

SYSTRON-DONNER CORPORATION (A)

Design of an Analog Computer

In March 1965, Dick Dunlop, a Product Designer in the Electronic Instrumentation section of Systron-Donner Corporation, Concord, California, began preliminary design work on a proposed new analog computer. The computer was to be a small portable model using transistors exclusively in place of vacuum tubes.

Systron-Donner Corporation was formed in 1960 from a merger of Systron Corporation, makers of electronic test instruments with Donner Scientific Company, an established manufacturer of analog computers and inertial instrumentation. In 1965 net sales were \$10 million and the firm employed a little over 400 people. Products include various types of electronic test instruments, counters, and gyros and servo-accelerometers for military aircraft, in addition to computers.

(c) 1966 by the Board of Trustees of Leland Stanford Junior University.

Prepared in the Design Division, Department of Mechanical Engineering, Stanford University, by John A. Alic, under the direction of Professor H.O.Fuchs, with financial support from the National Science Foundation.

Dick Dunlop had been with Systron-Donner for a year and a half when he began working on the new computer. Dick explained that his job as a product designer at S-D included both mechanical design and styling of what is basically electronic equipment. Dick arrived at this position following varied experience after leaving art school in 1957. He worked for two years as a technical illustrator, then took a job as a design draftsman at Lick Observatory, where he designed small high-precision optical instruments. Next he designed large high-precision optical instruments, including an X-Y measuring machine for tracking guided missiles with an accuracy of one micron* in six inches, for an Oakland (California) firm. Dick pointed out that the design of such items -- of which only one or two are to be produced -- is dictated primarily by the manufacturing processes which must be employed, so that the design seems almost to complete itself once the basic idea is stated.

During this period Dick was acquiring valuable technical knowledge through extension courses given by the University of California at Berkeley and at community trade schools offering night courses in such subjects as machine tool and foundry practices.

Previous to joining Systron-Donner Dick worked for IBM. He pointed out that the difference between products at IBM and designing for Systron-Donner is again a matter of manufacturing processes, as dictated by production quantities. Dick said that while the products at IBM had been slated for mass production, most of S-D's products are produced in quantities such that castings, forgings, and stampings, are uneconomic.

The first project Dick worked on at S-D was the 40/80 series of analog computers described in Exhibits 1 and 2. These two computers were the company's first transistorized analogs and the industry's first ± 100 volt solid state analogs. They went into production in the summer of 1964. Dick explained that with equal absolute component accuracies a ± 100 volt computer affords accuracy superior by an order of magnitude to the ± 10 volt computers offered by S-D's competition. He also pointed out that a vacuum tube computer built ten years previous to the 40/80 with equal capabilities would have occupied a good sized room.

The 40/80 price and quotation form which appears in Exhibit 1 shows that a series 40 computer with a full complement of equipment sells for around \$30,000, while a similarly equipped series 80 runs \$50,000 to \$60,000. These prices put the machines beyond the reach of the smaller companies and universities engaged in research and development activities for which an analog computer is a valuable tool. In addition to its R & D uses, the 40/80 also finds application in the chemical industry for process control.

* One micron equals 10^{-6} meters.

S-D's sales and engineering representatives, who market the company's products across the country, had been reporting wide demand for a smaller, lower cost solid state analog ever since the introduction of the 40/80. Many prospective customers can neither afford the 40/80 nor utilize effectively its capabilities. Systron-Donner's management felt that there was a definite demand for a small, easily portable analog selling for around \$10,000. Such a computer would be within the reach of most universities for teaching purposes as well as for research, and would tap another large market consisting of the smaller engineering laboratories. It was also felt that such a computer would be purchased by many medical centers since analogs were being used to increasing extents both in medical research and in diagnosis.

Systron-Donner's management concluded that a computer using perhaps 7 to 10 of the computing modules from the 40/80 could be sold in quantities of 20 to 30 per month. A computing module is shown in Exhibit 3. There were six different modules available for the 40/80, providing various capabilities, with more under development. The series 40 uses a total of 21 modules; the series 80 uses 42.

The proposed new model was designated the 10/20. Discussion of the features of the new computer in relation to the market at which it would be aimed began in the fall of 1964. It was planned that other components from the 40/80 series besides the modules be employed in the 10/20, for example the coefficient potentiometers used to set the values of variables.

By January, 1965, an electrical engineer had been named project engineer for the 10/20 and he had written and submitted to management a "New Product Proposal", part of which is shown in Exhibit 4. Because Systron-Donner is not a large company, management normally keeps in touch with the activities of the engineering departments without the aid of many written communications. The proposal was not intended to inform management, since the project engineer was in consultation with management during its preparation. Its purpose was rather to provide a basis for budgeting the development of the 10/20. Thus the product specifications in the proposal were quite flexible and changes could be made at any time.

Dick Dunlop's involvement with the 10/20 project began in March when he started work on the preliminary mechanical design of the package. This was known as Phase 1 of the development -- generation of alternative schemes for packaging the electronics specified by the electrical engineers. Phase 1 of the electronics design was simple and straightforward, the essentials being carried over from the 40/80 experience. During Phase 1 Dick's task was to investigate the concept of the computer with respect to functional capabilities, styling, estimated production costs and general feasibility. He was not in a decision making position however; he was merely expected to propose alternatives in these areas. Specifically, he was expected to propose three or four different package designs offering various arrangements of the components.

One of Dick's proposed designs was accepted by management in June, and work began on a hand-built model on July 1st. Ordinarily this would have been an engineering prototype, during the construction of which all design details, both mechanical and electrical, would have been finalized prior to making the engineering drawings of the piece parts and assemblies. Phase 2 for the 10/20 did not follow this usual pattern, however, because it was decided to prepare a working model of the computer in time for the 1965 WESCON Show (Western Electronic Show and Convention) in August. Because of the short time available, this first model was built with bread-boarded electronics and, while in appearance the computer was finished, many of the details had not been finally determined. This model was built in the engineering model shop from sketches Dick prepared. While making these sketches he also worked on a layout of the entire computer.

After the first model had been completed and exhibited at the WESCON Show August 24-27, work began on the Phase 2 engineering prototype which would exactly represent the final design. During the months from July onward Dick worked in parallel with the electrical project engineer, with each man responsible for his own area. Since the computing modules were in existence, the electrical engineers were concerned mainly with designing new power supplies.

Coincidentally with work on the prototype, documentation of the design began. In October, three draftsmen were assigned to help Dick with the task of making drawings from which the computer could be produced by the manufacturing department. Dick began working on a new layout of the computer which would incorporate all revisions of the design -- shapes, dimensions and tolerances, etc., which had not appeared on his first layout. The draftsmen worked on other layouts, on subassembly drawings and on piece part details. Parts lists also had to be prepared for transmittal to the manufacturing department, and all components of the design were re-examined for cost and manufacturability. During Phase 2 Dick was able to request help from the manufacturing department in reaching decisions on such things as manufacturing and assembly processes; extrusion die costs, dip brazing, etc. Ideally, after all these drawings had been checked and released, Phase 3 would begin. By this time the final prototypes would also be complete.

Phase 3 is pilot production. Normally manufacturing produces twenty units once necessary tooling is available; the production of this pilot lot is still under the control of the engineering department and the design is evaluated by engineering for ease and cost of manufacturing. Design changes are made accordingly as Phase 3 continues and the product is debugged. At the conclusion of pilot production, the engineering department formally releases the product to manufacturing and their responsibility for it ends, although they may still serve as consultants to manufacturing. Pilot production of the 10/20 actually began in early November, long before documentation of the design was completed. Work began on the

manufacture of the piece parts for ten computers and as enough parts for subassemblies became available, these were built up. At the same time work began on another lot of 40, with completion of these scheduled by July to meet sales forecasts. Thus, although it may be convenient to think of product development activities as divided into three consecutive phases (design, prototype construction and development, and pilot production), in the case of the 10/20 there was considerable overlap and the three phases were carried out more or less concurrently.

Preliminary Design

During Phase 1 of the 10/20 computer development project, the preliminary design stage, Dick Dunlop and others at Systron-Donner had to consider, evaluate, and finally choose among many alternative design possibilities. It had already been decided that the computing modules would be fitted to pre-wired receptacles and that a removable problem board would be used, similar to the 40/80 design. When a module is installed, prongs at its rear connect to terminals in the module receptacle which are wired to the power supplies and controls. From the front of each module protrude 84 spring prongs. In front of these prongs is located a board with 84 corresponding holes for patch cord plugs. Coded directions for the various possible connections appear on the front of each board. The individual boards for all the modules, when installed in a rectangular frame, comprise the problem board. The shallow prong-filled cavity in the front of the computer in which the problem board fits is called the patch bay.

Among those things that had not been decided upon were the following:

- 1) The number of computing modules to specify. The six different modules available for the 40/80 would be available to purchasers of the 10/20 along with two new modules being designed for use in both computers. Since the modules are all interchangeable they must have a common size; this size is 2-1/4" x 16" x 6-3/8". The size of each coded module board is 2-1/4" x 6-3/8" x 3/8".
- 2) The number of coefficient potentiometers to specify -- also whether the number installed should be a customer option as with the 40/80.
- 3) Where to place the variable diode function generator (VDFG) cards (or boards) and how many to specify. The VDFG cards and their installations on the 40/80 are described in Exhibit 5. The size of each VDFG card is 1" x 3-1/2" x 6".

- 4) Whether it should be possible to mount the computer in a standard electronic equipment rack. If so, its width would be limited to 19 inches. Electronic equipment is often rack mounted so that related or inter-connected pieces can be neatly grouped together. For instance, an analog computer might receive its input from a digital/analog converter with the readout being shown on an oscilloscope. It might then be desirable to mount all three together in a rack.
- 5) How the following components of the computer should be arranged:
- modules, potentiometers and VDFG cards.
 - the two power supplies, one of size 6" x 15" x 8", the other 8" x 10" x 6".
 - the fan and motor for cooling the power supplies, a purchased assembly of size 6" x 5-1/2" x 2-1/2".
 - the controls: 8 pushbuttons (each 7/8" x 3/8" x 3-1/2" deep), 4 concentric rotary switches (each 1-1/2" dia. x 3" deep), 3 single pole double throw switches (each 3/4" dia. x 2-1/2" deep) and a voltmeter (3-3/8" x 2" x 2" deep). Dick was free to lay out the panel and design knobs, etc., as he wished for good human engineering.
- Some thought would have to be given to air flow from the fan through the electronic components. The amplifiers in the modules produce the most heat.
- 6) Styling of the package -- consistent with the engineering and suited to the anticipated production volume of 30 units per month.

A more specific problem which faced Dick Dunlop was the design of the problem board and its latching mechanism. On the 40/80 coded module boards are held in a rectangular frame which is latched to the front of the computer after the proper connections between and within the modules have been made with patch cords and patch plugs. The patch plugs and patch cords plug into the holes in the front of the module boards and contact the spring prongs, as shown in the sketch of Exhibit 6. The manufacturer of the prongs told Dick that when installed correctly they should be loaded by the plugs to a deflection at their ends of about .060 inch. The 40/80 problem boards are programmed first and then latched to the computer. During the latching operation the board is lifted vertically upwards to load the prongs.

To be able to design a latch arrangement -- or problem board receiving mechanism -- Dick felt that he should know how much force would be required to load the prongs. He filled a module board with patch cords so that he could check for the worst case -- 84 plugs loading 84 prongs. Using this board and a single module he found that it took a force of about 28 lbs to raise all the prongs .060 inch. He used a platform scale in the shipping department to measure the load.

TRANSISTORIZED $\pm 100V$ ANALOG COMPUTER PRICE and QUOTATION FORM

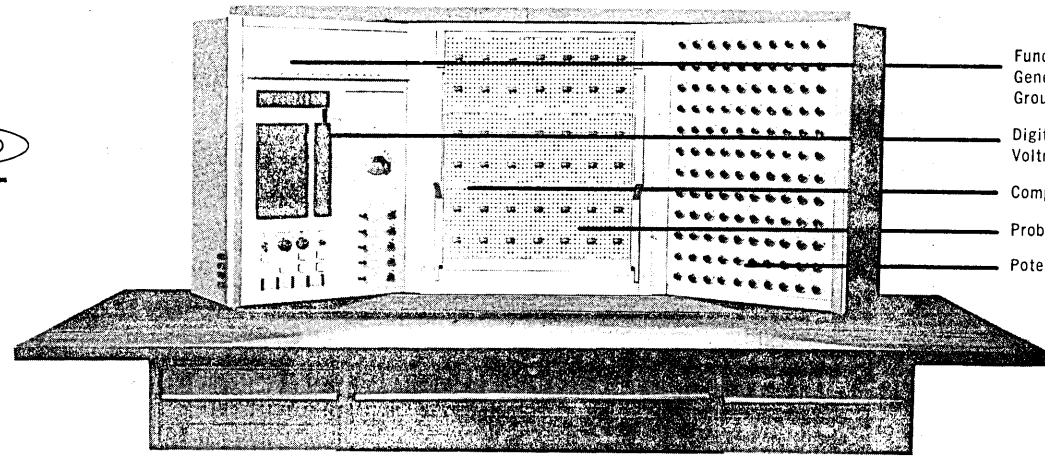
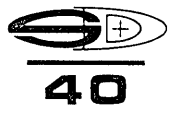

- Function Generator Group
- Digital Voltmeter
- Computing Modules
- Problem Board
- Potentiometer Group

SD 40 Computer Cabinet, Controls, and Receptacle

SD 40 COMPUTER

Cabinetry, Control and Receptacle including:
 Desk top cabinetry with cooling fans
 Complete control wing with mode and test controls, rep-op, voltmeter, Null reference system and digital address selector.
 Potentiometer wing for mounting up to 6 potentiometer groups.
 Pre-wired module receptacle unit for up to 21 computing modules.
 Computer Power supplies and $\pm 100V$ d.c., $\frac{1}{2}$ ampere reference supply.

OVERALL DIMENSIONS:
52"L x 26"H x 23"D
 APPROX. WEIGHT: 450 lbs.
 POWER CONSUMPTION: 440 watts
 PRICE \$ 8,585.00

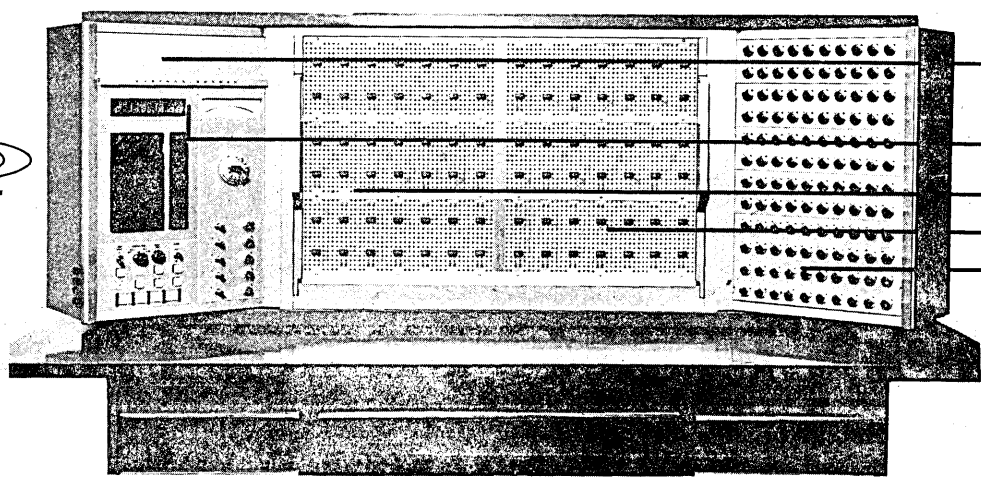
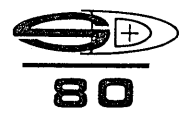

- Function Generator Group
- Digital Voltmeter
- Computing Modules
- Problem Board
- Potentiometer Group

SD 80 Computer Cabinet, Controls, and Receptacle

SD 80 COMPUTER

Cabinetry, Control and Receptacle including:
 Desk top cabinetry with cooling fans
 Complete control wing with mode and test controls, rep-op, voltmeter, Null reference system and digital address selector.
 Potentiometer wing for mounting up to 6 potentiometer groups.
 Pre-wired module receptacle unit for up to 42 computing modules.
 Computer Power supplies and $\pm 100V$ d.c., $\frac{1}{2}$ ampere reference supply.

OVERALL DIMENSIONS:
68"L x 26"H x 23"D
 APPROX. WEIGHT: 600 lbs.
 POWER CONSUMPTION: 650 watts
 PRICE \$10,500.00

Exhibit 1: The 40/80 Series of Systron-Donner Analog Computers.

	UNIT PRICE	QTY.	TOTAL PRICE
1 BASIC COMPUTER: SD/40...\$8,585.00 <input type="checkbox"/> SD/80...\$10,500.00 <input type="checkbox"/>			\$ _____

2 POTENTIOMETER GROUP:

Model 3370 Pot panel, 20 ten-turn wire-wound pots with counting dials	\$ 810.00		\$ _____
Potentiometer TOTAL (Including 5 on control wing):			_____

3 FUNCTION GENERATOR GROUP:

Model 3350 Function Card Receptacle	\$ 270.00		\$ _____
Model 3351 Variable Diode Function Generator card	215.00		_____
Model 3341 Function Generator Setup Unit	165.00		_____
Function Generator TOTAL			_____

4 COMPUTING MODULES:

Model 3320 Dual Integrator Amplifier	\$ 700.00		\$ _____
Model 3321 Dual Summer Amplifier	650.00		_____
Model 3322 Dual Inverter Amplifier and Dual Operational Relay	540.00		_____
Model 3323 Dual Inverter Amplifier and Dual Electronic Multiplier	945.00		_____
Model 3324 Dual Inverter Amplifier and Quad Electronic Switch	835.00		_____
Model 3325 Quad Summer	\$1,000.00		_____

Computing Module TOTAL: _____ including _____ Amplifiers, _____ Multipliers,
 _____ Integrators, _____ Relay Comparators, _____ Electronic Comparators

5 DIGITAL LOGIC CONTROL MODULES:

Model 3326 Flip-Flops	\$ 500.00		\$ _____
Model 3327 Logic Gates	500.00		\$ _____
Model 3328 Time/Event Control	950.00		\$ _____

6 Removable Problem Board: SD40...\$ 270.00 SD80...\$450.00 _____ \$ _____

7 Patch Cord and Shunt Plug Assortment (200 items) 200.00 _____

8 Four-place Digital Voltmeter 2,200.00 _____

9 Universal Module Extender 100.00 _____

10 Instruction Manual, A.C. Power Cords and Spare Fuse Kit 1 each N/C

11 Special Instructions or assembly requirements: _____

Price for special work (if required) \$ _____

TOTAL PRICE, F.O.B. Concord, California \$ _____

S-D Quotation No: _____
 (Please reference this number on all correspondence)

Delivery: _____ days after receipt of Purchase Order
 Terms: net 30 days

SYSTRON-DONNER CORPORATION

NOTE: Budgetary prices are subject to change without notice. Signed quotations are firm for a period of 30 days.

Signature _____

Date _____

Converting a SD 40 to a SD 80 computer is accomplished merely by inserting an additional receptacle which doubles the computing module capacity from 42 to 82 amplifiers, and exchanging problem boards and top and bottom cabinet plates.

GENERAL DESCRIPTION

The SD 40/80 series of general purpose analog computers are constructed of fully transistorized circuitry and operate over a full ± 100 volt computing range. General configuration is a desk-top design, pre-wired, with removable problem board, modular computing elements, and movable control and potentiometer wings.

The entire series is designed to solve ordinary and partial differential equations, and other engineering, design, and control equations by solution, simulation or logic analysis. The SD 40/80 Computers include operational program check circuitry, a storable program set-up system, and a completely short circuit proof design that protects computing components as well as the power supply against errors in patching and accidental shorts to ground.

COMPUTING EQUIPMENT

± 100 volt Operational Amplifier is a removable, identical, dual-channel unit which is included in each computing module. (Specifications as measured at the Problem Board.)

Maximum Output Voltage	± 105 v (1 ma)
Output Voltage (at ± 25 ma)	± 100 v
Maximum Output Current (at ± 100 v)	± 25 ma
Overall DC Gain	$> 10^7$
Summing Junction Offset/8 hours	$100 \mu\text{v}$
Summing Junction Offset due to $\pm 10\%$ line variation	$< 20 \mu\text{v}$
Short-term Stability (referred to Summing Junction)	$\pm 20 \mu\text{v}$
Noise (referred to Summing Junction)	< 2.5 mv P-P

SD 40		SD 80
14	Integrating Amplifiers	28
14	Summer Amplifiers	28
6	Multiplier-Dividers with	12
6	Inverting Amplifiers	12
4-15	Variable Diode Function Generators with Inverting Amplifiers	8-15
8	Electronic Switches with	16
4	Inverting Amplifiers	8
4	Operational Relays with	8
4	Inverting Amplifiers	8
up to 65	Coefficient Potentiometers	up to 125
5	Function Switches	5
80	Trunk Lines	160
1764	Problem Board Terminals	3528
52"L x 26"H x 23"D	Overall Dimensions	68"L x 26"H x 23"D
300 lbs.	Approximate Weight	370 lbs.
440 watts self-contained	Power Consumption	650 watts self-contained
	Cooling	

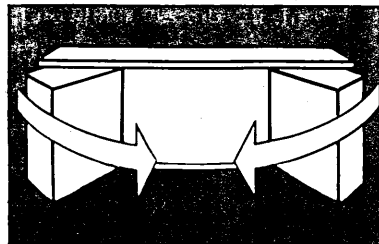

Control Wing (on left) and Potentiometer Wing (on right) are hinged. They swing to any convenient angle to give operator total visibility and control.

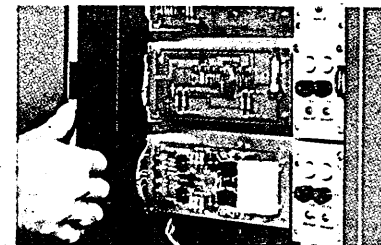

A centralized, fully expanded power supply system is comprised of four supplies, each individually fused and fully short circuit proof.

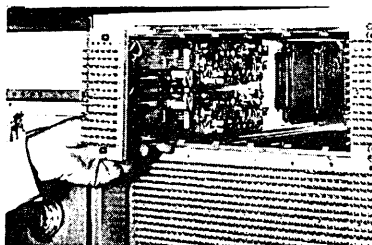

Modular, plug-in computing elements form patchbay to provide high dynamic accuracy. Gold contacts, with double wiping action, assure positive connection.

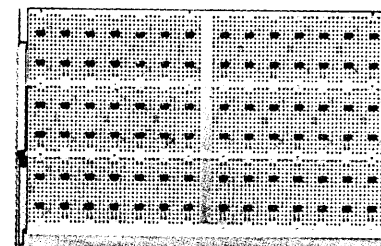

Removable problem board, made up of color-coded patch panels, couples directly into computing elements which can be arranged in any convenient order.

Exhibit 2: Systron-Donner 40/80 Series Computer.

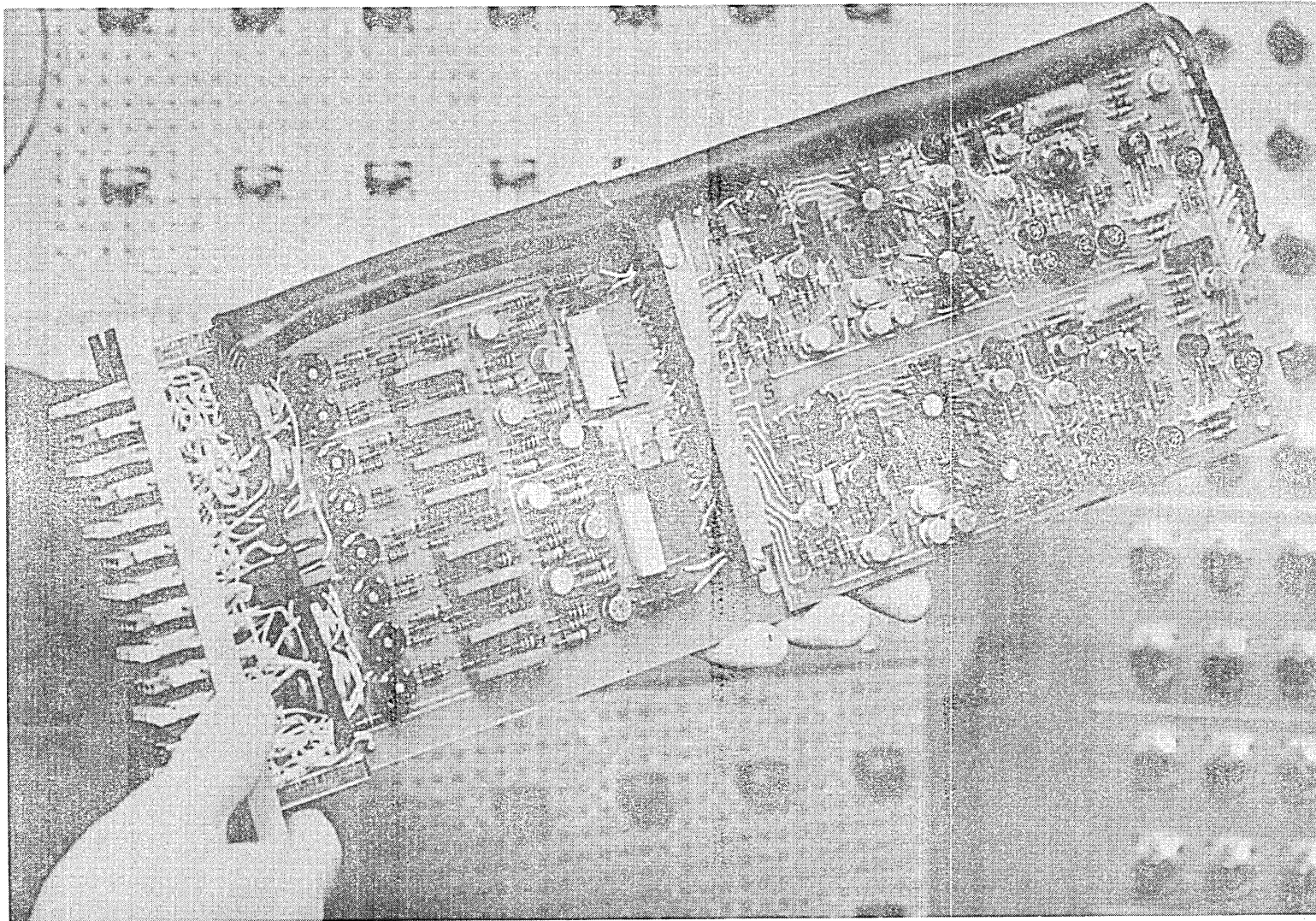

Plug-in Computing Modules

* Front panel of module forms patch bay - no lengthy interconnecting cables

Exhibit 3: Computing Module.

Exhibit 4: Part of the Proposal for the 10/20 Computer.

APPROVALS*

A.B. Blessing
Q. James
O. Reese
F.L. Kazabowski
G. Washington

ECL 47-A
Exhibit 4
Page 1

SYSTRON-DONNER CORPORATION
Electronic Instrumentation

Copy only:
O.P. Henry
F. Virgil

New Product Proposal

Date: 12 January 1965

Proposal: EI-5B

Name of development: Desk Top Analog Computer, Model SD 10/20

Description:

A) Control Center

1. The five modes of operation: Reset, Compute, Hold, Balance and Potset shall be controlled by a rotary switch.
2. An optional plug-in unit to provide rep-op operation. Both Compute and Reset modes of the Rep-Op operation shall be continuously adjustable from 5 msec to 1.0 sec.
3. An address and meter select system shall be of rotary type switches. The address system shall be capable of monitoring 20 amplifier outputs, and 30 potentiometers through the pot. bus. All power supply voltages shall be available for monitoring either on the problem board or control center.
4. A voltmeter read-out device of the taut-band type shall have an overall accuracy of $\pm 2\%$ of full scale.
5. A differential voltmeter read-out system for pot setting shall have an overall accuracy of $\pm 0.05\%$.
6. A visual master overload indicator of the latching type shall respond to any momentary or sustained overload condition from any amplifier in the computer system.
7. A slave option to make control of the computer possible from a remote source such as another computer through the trunk lines of the integrator network module.
8. Three function switches of TTDP type shall be available.
9. Visual indicators to indicate modes of operation, overload, power-on shall be available.

* Fictionalized names (Case Writer).

Description: (continued)

B) Power Supplies

1. All power supplies shall be fully protected from accidental shorting to ground with no consequences.
2. All components of each power supply shall be capable of withstanding a cabinet temperature of 50°C (122°F).
3. The power supplies shall have the following specifications:

	<u>+112V</u>	<u>+100V</u>	<u>+28V</u>
Output current	500 ma	150 ma	500 ma
Load regulations (0 to full load)	112 mv	10 mv	28 mv
+10% line-change regulation	112 mv	10 mv	28 mv
Ripple with full load	20 mv	5 mv	10 mv
Tracking	-	3 mv	-

4. The ± 100 V reference supply shall have an 8 hour stability of 10 mv under constant temperature, line-voltage, and loading conditions.
5. The temperature stability of the ± 100 V reference supply over the temperature range of 0°C (32°F) to 43°C (100°F) shall be better than 75 mv (less than 1 mv/°F).
6. All power supplies shall be capable of 115V or 230V (50 cps to 60 cps) operation.

C) Computing Modules

1. All modules shall have the same physical dimensions, number of terminals on front panel as those of the SD 40/80.
2. There shall be three separate types of modules, namely: quad-operational amplifier, quad-integrator network, and dual multiplier/comparator.
3. Quad-operational amplifier module shall contain two dual-operational amplifiers, Model 3310, four precision resistor plug-in type of P.C. boards, each shall have five wire wound, .01% resistors. No additional patching shall be required for amplifier balance. Balance adjustments shall be available on the front panel. Optional choice of the number of dual-amplifier boards and precision resistor boards can conveniently convert the quad-operational amplifier module to a dual operational amplifier, dual-summer or quad-summer module.

Description: (continued)

4. There shall be two types of quad-integrator network, one for real-time another for rep-op operation. When either integrator network is used in conjunction with the quad-summer, they become two separate dual integrators capable of real-time or rep-op type of operation depending on the type integrator network used.
 - a) Quad integrator network for real-time operations shall contain two separate plug-in type P.C. boards each with two 1.0 MF, 0.05% and 0.1 MF, 0.05% polystyrene capacitors, four 50K, 0.01% resistors, and two 2-C mechanical relays to provide logic control for two channels of integrator network.
 - b) Quad integrator network for rep-op operation shall contain two separate plug-in type P.C. boards each with two 1.0 MF, 0.05%, 0.1 MF, 0.05% and 0.01 MF, 1% polystyrene capacitors, four 50 K, 0.01% resistors, two 2-C relays (one shall be high speed type) to provide logic control for two channels of integrator network.
5. Dual multiplier/comparator module shall contain two channels of 1/4 square type of multiplier as used in the SD 40/80 and two channels of comparator that require no external operational amplifier. Each comparator channel shall contain an unstabilized amplifier which output shall be connected to a 2-C relay capable of fast operation. Each comparator channel shall occupy a P.C. board of the plug-in type. Optional choice of multiplier board and comparator board can conveniently convert the dual multiplier/comparator module to dual multiplier, dual comparator, or dual multiplier/comparator module.
6. Function generator board shall be same as those in SD 40/80. Their termination shall be available on the integrator network, multiplier/comparator module problem boards.
7. There shall be two types of potentiometers available, the 10 turn wire wound and single turn molded carbon. With the 10 turn wire-wound potentiometers, plain black plastic knobs or duo-dial helipot knobs shall be made available. Pot. panel shall have groupings of ten potentiometers of either type. A push-button type of switch shall be used with each pot. to perform the functions of pot. setting and monitoring.

D) Cabinet Assembly

1. The construction of the removable problem board, problem board receiving mechanism and module receptacle are essentially the same as the SD 40/80. Attempt to reduce the cost of the existing design shall be made.

Description: (continued)

2. The function generator receptacle unit shall be located on the bottom level of the computer. The receptacle unit shall accept 5 function generator boards.
3. The pot. panels shall be mounted next to the problem board area on the right side of the computer.
4. The control center shall be located next to the problem board area on the left side of the computer.
5. The front side of the computer shall be a single plane construction. The cabinet shall be a simple box-type shape which may be purchased.
6. All power supplies shall be either behind the control center or the pot. panels.

Effect on Established Systron-Donner Products: None, but does extend the SD 40/80 Analog Computer series into a similar market area of the Donner 3400 which has proven to be a widely accepted computer model over the years. The SD 10/20 modules will provide new additions to the module family of the SD 40/80.

Function Generator

Model 3321

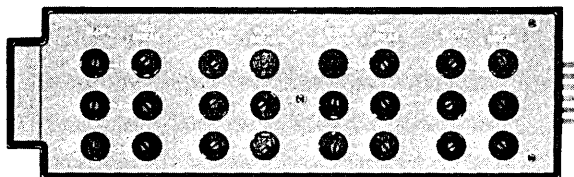

Input Voltage	± 100 v maximum
Output Voltage	Arbitrary function of input voltage; within the range of ± 100 v
Frequency Response	1 kc
Input Impedance	Greater than $45\text{ k}\Omega$ (depends on function)
Output Impedance	Equal to the output Z of the output amplifier
Function Simulation	Straight-line approximation of 12 line segments
Line Segments	12 breakpoints total (6 adjustable between 0 and $+100$ v) (6 adjustable between 0 and -100 v)
Slopes	Each segment has a maximum adjustable slope of 2.5 v/v input. (Larger slopes are obtainable by adding individual line segments.)
Noise	150 mv P-P
Power Requirements	± 100 v, ± 6 ma

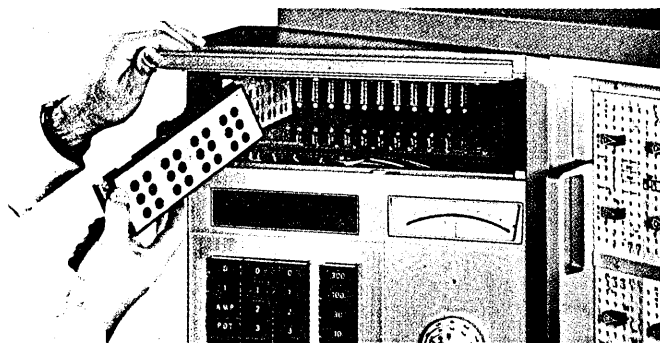

The Function Generator Receptacle mounts up to 15 cards and terminates each FG channel at the Dual Summer, Model 3321, or at the Inverter/Operational Relay, Model 3322. Each FG card contains 12 independent segments, all have screw driver pot adjustment for break point and slope. This flexible FG card set-up permits "stacking" of breakpoints for increased slope, and 24-segment function generation by paralleling two FG cards.

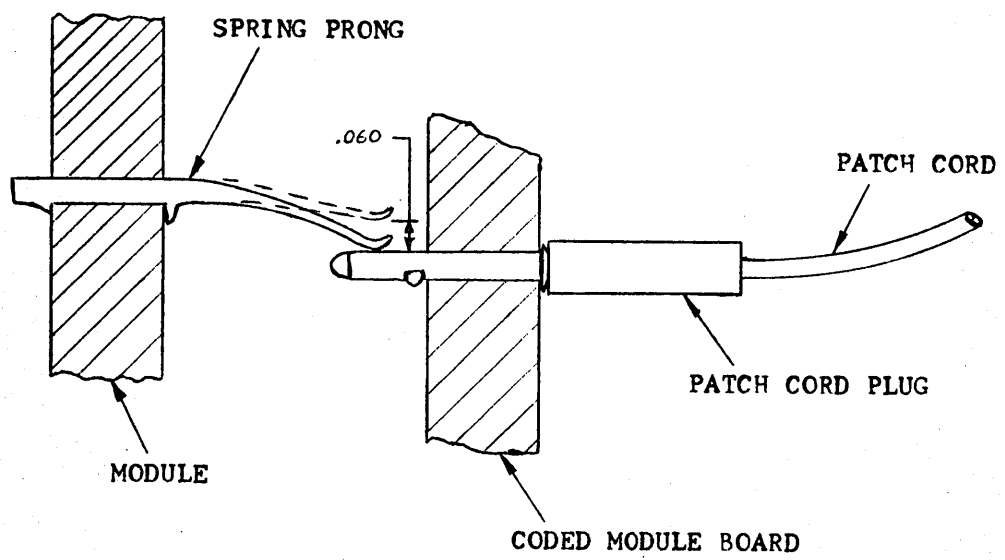
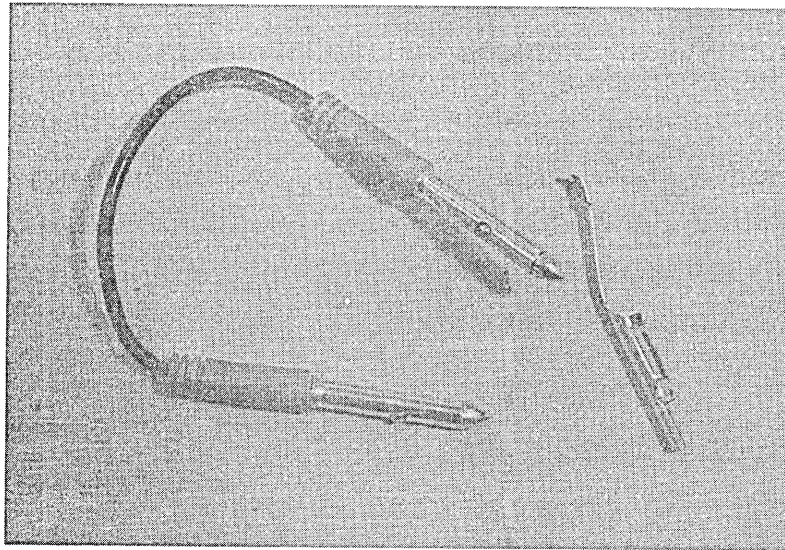

Exhibit 6: Spring Prong and Patch Cord.

SYSTRON-DONNER CORPORATION (B)

Design of an Analog Computer

Dick Dunlop began Phase 1 of the development of the new model 10/20 analog computer during March 1965. He was expected to propose three or four alternative package designs.

One of Dick's preliminary design sketches, made in April, is shown in Exhibit 1. This computer incorporates ten computing modules and is suitable for rack mounting; however, Dick did not like the upright appearance of this design nor of the several others he sketched that were limited in width to 19 inches so that they could be rack-mounted. He noted that the principal competition in the small portable analog computer field would be from an upright ± 10 volt machine which could be rack mounted. However, Dick felt that this machine looked more like a slot machine than a computer. He began to feel that it would be impossible to design an aesthetically satisfactory computer that could be rack-mounted and turned his attention to designs with more pleasing proportions.

When Dick first decided to try a design with all the computing modules in a single horizontal row, he made the sketch shown full size in Exhibit 2. He showed this sketch to several people concerned with the project and it met with favorable response. Then he went ahead and made a number of larger sketches based on this idea, one of which is shown (reduced in size) in Exhibit 3. This design contains only seven modules

and was made to investigate rack mounting of a computer having a single row of modules. Dick became quite enthusiastic about the basic idea common to Exhibits 2 and 3, so much so that he felt it was the only design worth pursuing for the 10/20, and he made a number of further sketches investigating modifications and variations in the location of components such as the VDFG cards. He also sketched computers with differing numbers of modules. He said he arrived at this basic design by a deductive process -- by considering designs and rejecting those he didn't like until he finally came up with one that he did like. Although he was supposed to present several alternative designs to management for their choice, Dick felt that it would be a good idea to present his preferred design in as forceful a manner as possible. With the sketches having served their purpose, he then had the model shop make a full-size model of the cabinet and front panel of a nine module computer, one virtually identical to his original sketch of Exhibit 2, and thus too wide for the rack mounting. This model incorporated the sheet metal cover, trim molding, dummy knobs and switches, and a problem board. Work on this model started in the middle of May. Its design received management approval with no significant changes and work, as previously mentioned, started on the engineering prototype on July 1st, with hopes of completion before the WESCON show in August.

The final design has room for nine computing modules, up to 24 coefficient potentiometers, and four VDFG cards. A description of the computer appears in Exhibit 4. Nine modules were finally decided upon because it was felt that eight would be too few but ten too many. The number of coefficient potentiometers is about the same ratio of modules to pots as for the 40/80 series. A 10/20 price list appears in Exhibit 5.

One of the sketches Dick made as an aid to estimating manufacturing cost of the computer appears in Exhibit 6. Dick explained that the cost of the tooling for the frame and cover of the computer totalled about \$300, with the extrusion die for the trim molding being about \$75 of this.

Photographs of the chassis and cabinet of the 10/20 appear in Exhibit 7. The chassis is shown from the rear in both pictures. The fan blows air along one side of the computer; then the air hits the front panel and is deflected upwards through the modules. There are outlets at the top rear of the cabinet. This design allowed only filtered air to enter and also allowed natural convection to assist in cooling.

Another of Dick's blow-up sketches appears in Exhibit 8. In this sketch and that of Exhibit 6 the problem board and part of the latch mechanism can be seen. Photographs of a problem board with patch cards, patch plugs, and overload lights appear in Exhibit 9. The overload lights indicate non-linearity in an amplifier. The nine module boards are held from the back of the problem board against flanges on the top and bottom of the

frame. Each end of the frame is a channel-section aluminum extrusion. When installing the problem board, it is first pushed back into the patch bay. Four spring loaded ball plungers, or ball detents, hold the problem board in place when the rear legs of the channels on the ends of the frame are pushed past them. Two ball plungers are pressed into holes at each end of the cabinet as shown in the layout of Exhibit 10 and the photographs of Exhibit 11. Only part of the drawing Dick made is shown in Exhibit 10 and explanatory notes have been added. Dick placed two hard wear pads on the inside of each rear channel leg (Exhibit 9) when he found that the aluminum channel would be severely scored by the ball plungers. When the problem board is snapped into place past the ball plungers there is clearance between the patch cord plugs and the spring prongs in the patch bay.

Dick used a camshaft to move the problem board up 1/8 inch and load the spring prongs. The cams are actually flats, 1/8 inch deep at their center, milled in a 3/4 inch diameter stainless steel shaft, as can be seen in Exhibits 10 and 11. On the layout, the shaft is shown in the up position with the stepped oilite foot on the bottom of the problem board (Exhibit 9) resting on the circumference beyond the slot. This corresponds to the up (vertical) position of the lever at the side of the problem board. With the handle and shaft rotated 90° clockwise (on the drawing) the oilite pads sit in the milled slots and the problem board can be removed or installed. Part of the handle appears on the drawing in phantom view for this position. When the problem board is raised it is positively locked; the ball plungers no longer hold it alone. The four plungers actually serve only as a convenience during loading, to hold the problem board in place while it is being lifted.

The stainless steel camshaft sits in slots milled in aluminum blocks. At first Dick had planned to mount it in bronze bushings, but then he decided that wear of the aluminum would probably be negligible, since the shaft would be turned only through 90° and then probably only a few times a week.

Dick had also designed a camshaft to lift and lock the problem board on the 40/80 computer and it was a natural step to use a similar arrangement for the 10/20. He recalled that the camshaft idea had seemed to have a self-generating origin, that after toying for awhile with all the requirements of the problem and the parts that already existed, the only feasible way to move the problem board upwards seemed to be with cams. Using a handle turned through 90° to rotate a shaft with two eccentric supports then followed logically. During the 40/80 design period Dick had considered replacing the handle by a torque motor with a worm reducer to drive the camshaft. He investigated available motors and reduction units but found that a very high reduction would be needed to give sufficient torque output to raise the problem board and that the best combination he could assemble would take about five seconds to raise the board. Also, the cost was too high.

The 40/80 camshaft is machined from 7/8 dia. shafting with an eccentric 1/2 dia. x 1" W. at each end. At first Dick planned on a similar arrangement for the 10/20. He decided to check a 3/8 inch diameter shaft for the handle force needed to lift the problem board and for the accompanying shaft deflection and twist. His calculation sheet appears in Exhibit 12. On the basis of these results he felt a more rigid shaft was necessary and for the first prototype specified a 3/4 inch diameter shaft with a flat milled its entire length to provide the 1/8 inch lift. Later he realized it would be much simpler to cut only two flats in the shaft, each 5/8 " wide x 1/8 " deep.

The Phase 2 engineering prototype, begun after the completion of the WESCON model in August, was finished in January 1966. No significant changes were made to the design during the construction of this prototype, or later in the project; however, Dick pointed out that a number of dimensional errors in the drawings were caught at this stage and that it was a lot better to find them before putting the computer into production. With Dick and three others still working on the documentation, it was about 90% complete by March 1966, and Dick expected it to be finished by August. The first batch of ten computers, all of which had already been sold, were completed and ready to be shipped by the end of March.

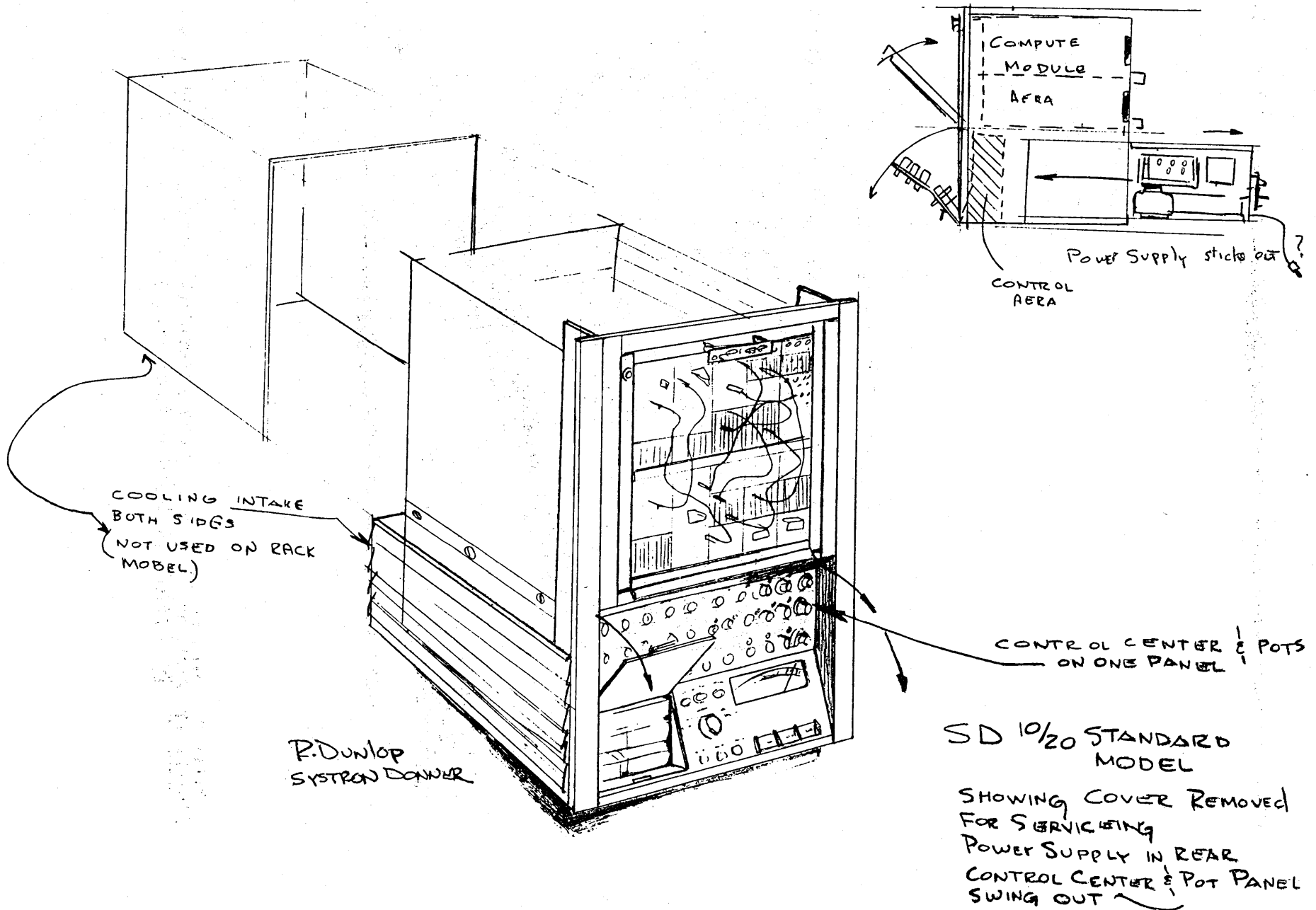
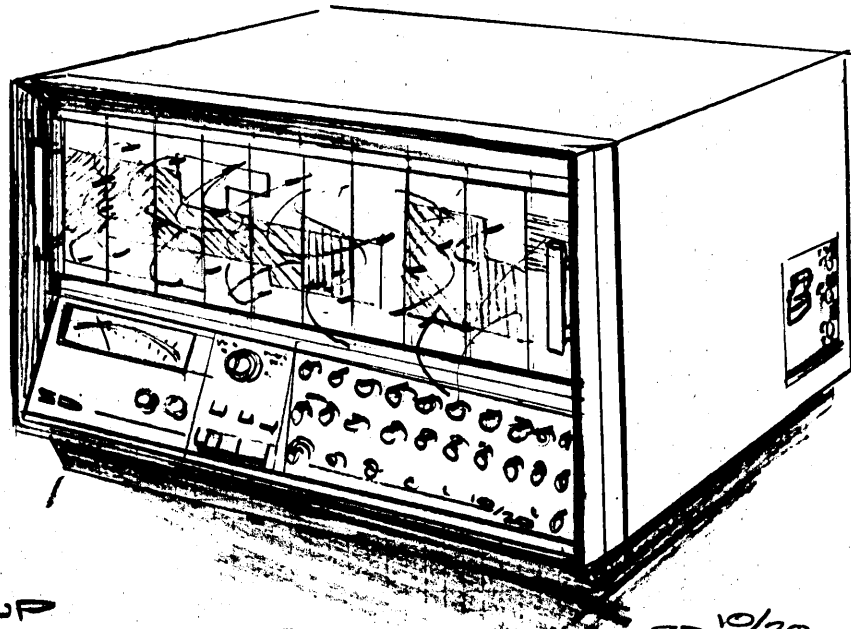

Exhibit 1: One of Dick Dunlop's Early Sketches. Reduced in Size



R. DUNLOP
SYSTEMS DONNER CORP.

SD 10/20
ANALOG COMPUTER

Exhibit 2: Dick Dunlop's First Sketch (Original Size) of a Computer with All Modules in a Single Horizontal Row.

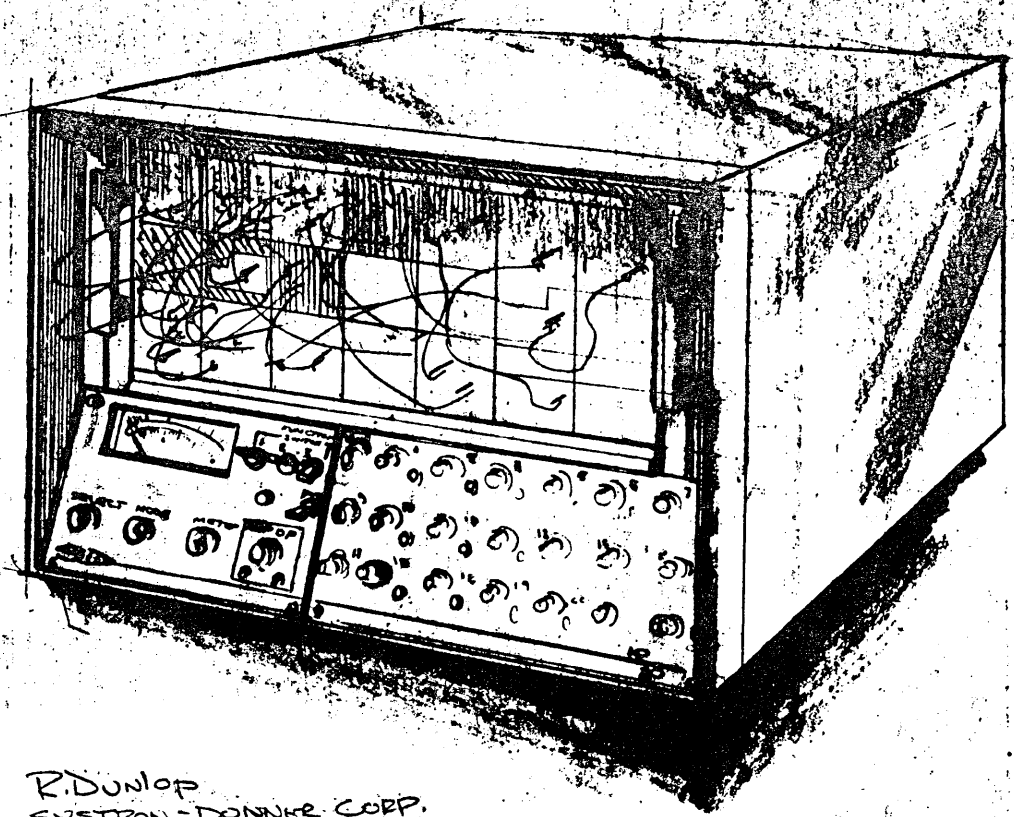

R. Dunlop
SYSTEM - DONNER CORP.

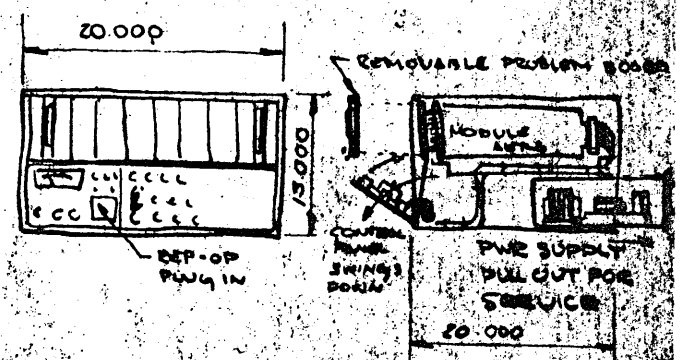
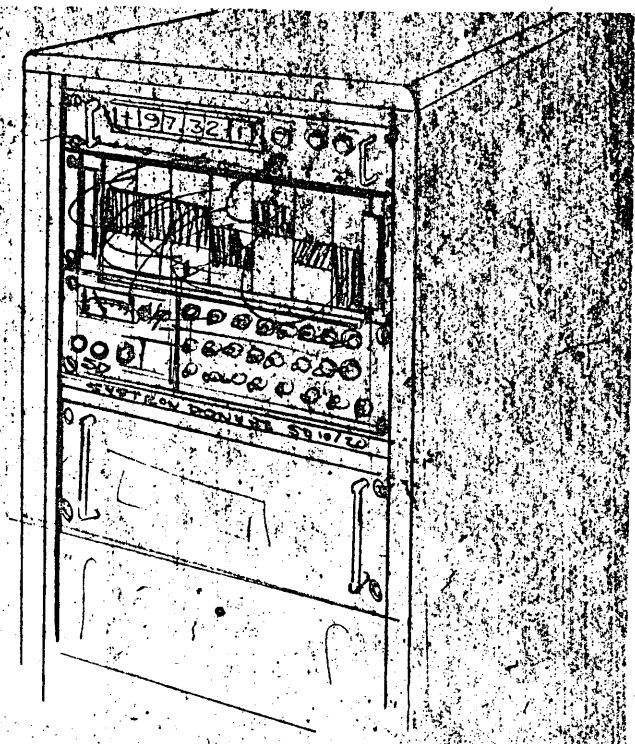

SD 10/20 24 POTS MAX APRIL 15 65

*New
Portable
Analog Computer*

SD 10/20

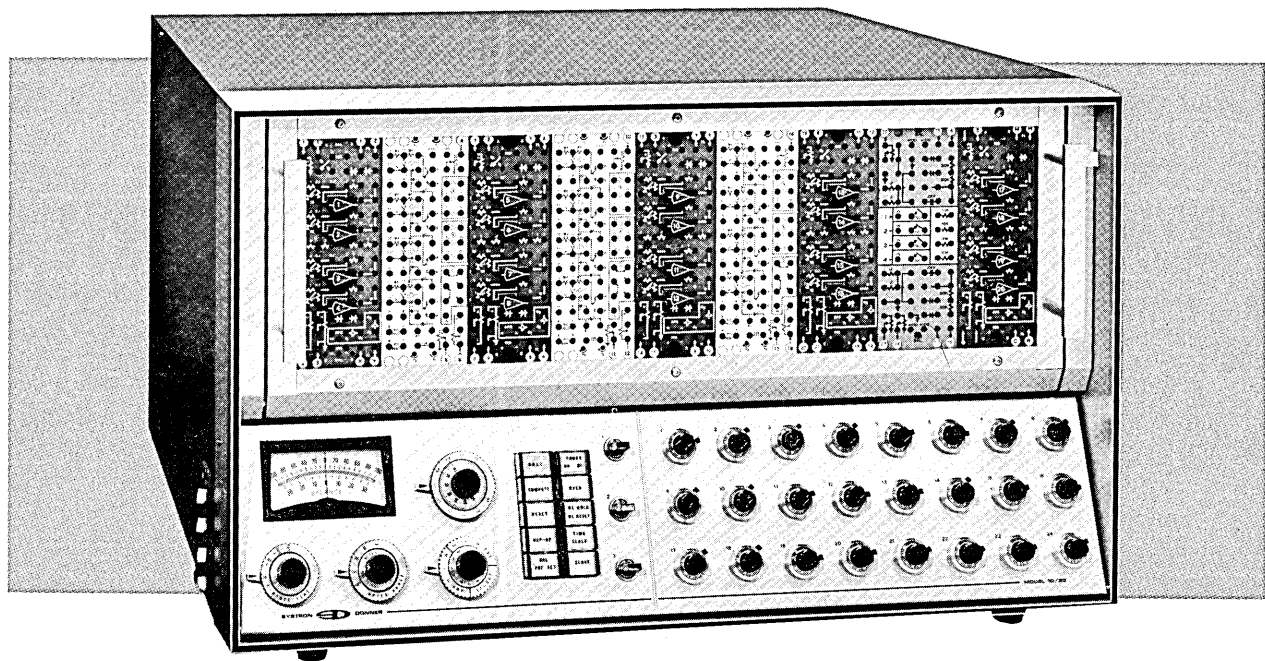

A MODERN ± 100 VOLT COMPUTER

In 13 years since the first portable Donner computer was announced, over 1000 computers have been installed. Each year brought new improvements — chopper stabilized amplifiers, first classroom computer, first solid state ± 100 volt amplifiers, iterative computing mode, and others. Now the MODERN analog computer is available — the Systron-Donner 10/20.

Designed for the maximum in problem-solving capability in a small, expandable analog computer, the new SD 10/20 is the first true portable computer to offer a full ± 100 volt operating range. In addition to the basic 100 volt design, the SD 10/20 has been carefully engineered to match the larger, sophisticated computers in problem set-up,

checking and operation. This new computer thus brings to the engineering lab, classroom, and research facility the opportunity to utilize a small, portable computer that uses the same powerful solution approach to problems within the scope of analog computation as the big computers.

DONNER'S EXPERIENCE LEADS THE WAY —

- ★ ± 100 volt design, fully transistorized
- ★ Removable problem board with visual computer circuits
- ★ Patchable electronic mode control
- ★ Patchable integrator time scales
- ★ Full iterative controls, 100 cps REP-OP

MODERN FEATURES OF THE PORTABLE SD 10/20 PROVIDE E

REMOVABLE PROBLEM BOARD, consisting of color-coded modular panels, couples directly into computing modules which are housed in a universal, pre-wired patchbay. This close, direct coupling between patch terminals and computing modules provides decrease in amplifier cross-coupling and lower system noise.

VISUAL COMPUTER CIRCUIT. All computer patch terminals are arranged into visual circuit diagrams thus matching the computer textbooks.

CAPACITY of 20 amplifiers, 16 integrators, 8 multipliers, 4 comparators, 24 potentiometers, and 4 variable diode function generators.

FOOL-PROOF PROBLEM BOARD. The power supply and all amplifiers are voltage and current limited. No blowing out of components when accidental shorts occur.

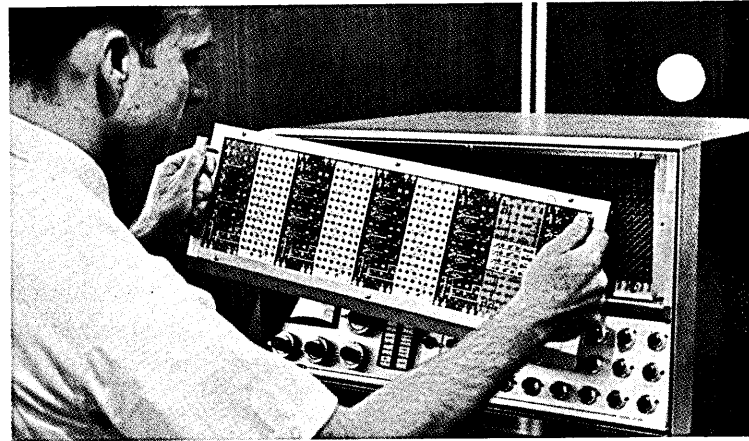

BASIC COMPUTING MODULES

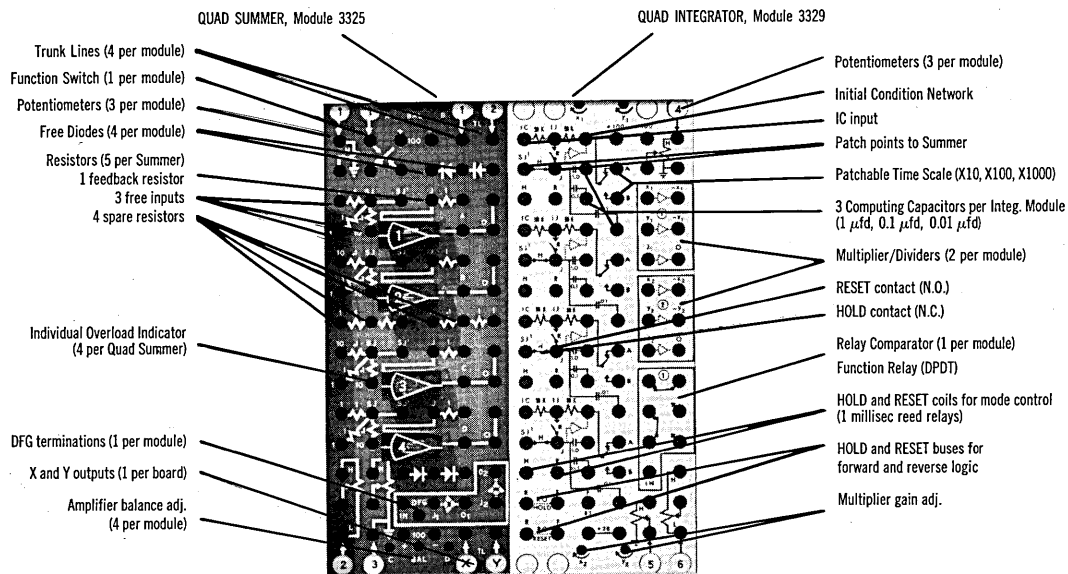

SIMPLICITY AND FLEXIBILITY IN PATCHING COMPUTER CIRCUITS

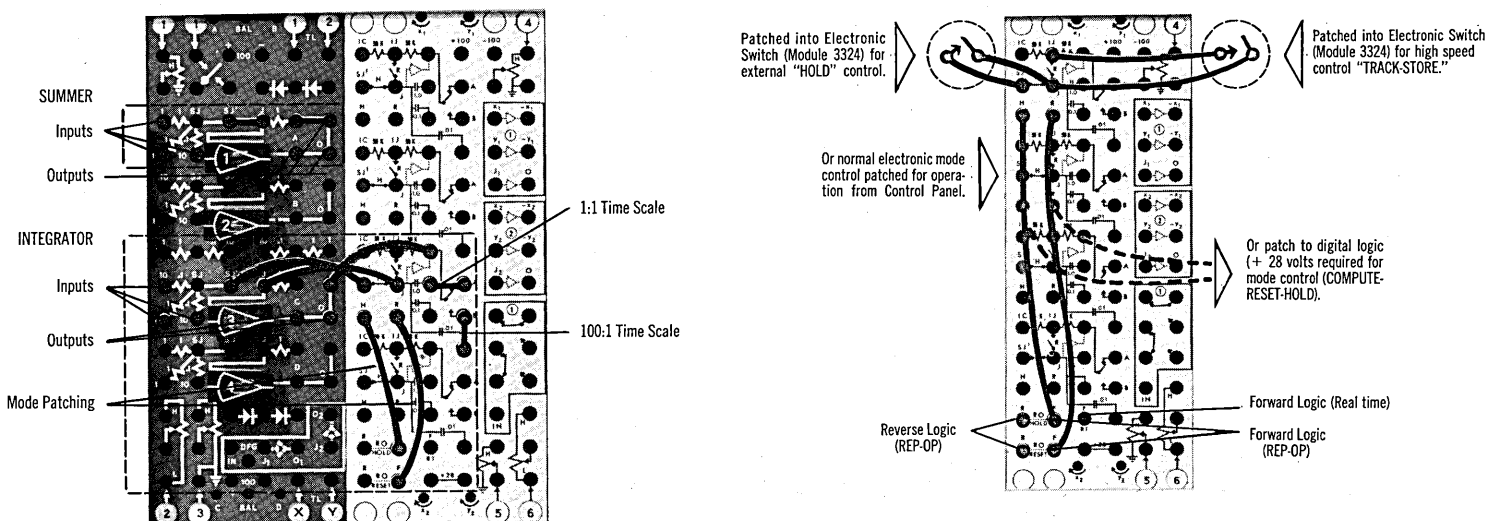

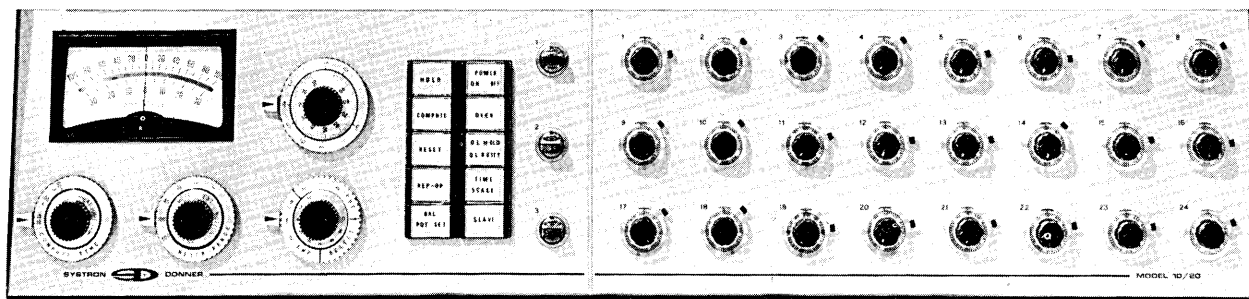

CONTROL PANEL

The SD 10/20 Control Panel puts at the operator's fingertips all the controls (pushbuttons, concentric selectors, switches) to facilitate rapid readout of problem variables, selection of

computer operating mode, and setting of compute time. The right side of the control panel provides for up to 24 coefficient potentiometers.

MODE SELECTION—by lighted pushbuttons

HOLD — places problem solution on all integrators into hold position simultaneously (within 1 msec).

COMPUTE — applies problem voltages to all integrators simultaneously (within 1 msec).

RESET — applies initial condition voltages to integrators simultaneously (within 1 msec).

REP-OP — places integrators into a repetitive operation cycle. (Compute time variable from 5 msec to 10 sec.)

BAL/POT SET — disconnects junction and grounds the summing junction of all integrator and summer amplifiers. Each amplifier is converted to a gain of 2500 for accurate indication of junction offset.

POWER ON/OFF — energizes and de-energizes computer. **OVEN** — indicates +28 volt oven power is on to maintain constant temperature of computing capacitors.

OL HOLD, OL RESET — lights up when any amplifier is overloaded. When depressed, computer goes into HOLD; when released, normal operation is resumed.

TIME SCALE — activates relays in each integrator module to change capacitor across amplifier. (x 10, x 100, x 1000, depending on patchpanel connections.)

SLAVE — permits operation of computer control circuitry from a second console.

READOUT AND ADDRESS SELECTION

PANEL METER — for reading out amplifier outputs, potentiometer arms, potentiometer coefficients, and all mul-

tiplier and function generator outputs by selecting the appropriate amplifier. Meter reading ranges are 1, 3, 10, 30, 100, and 300 volts, and \pm null. Full scale accuracy is 2%. Null position provides 0.02% F.S. resolution with reference potentiometer having a $\pm 0.05\%$ linearity at 25°C.

ADDRESS SELECTOR (concentric) — address capability of 20 amplifiers and 24 potentiometers.

READOUT SELECTOR (concentric) — provides rapid choice of readout at: Panel Meter, External (oscilloscope, x-y plotter, DVM), and +Null and -Null.

METER RANGE SELECTOR (concentric) — with positions for 300 v, 100 v, 30 v, 10 v, 3 v, and 1 v. Serves also as sensitivity adjustment for \pm null.

COMPUTE TIME SELECTOR (concentric) — compute time continuously variable 5 msec to 10 sec. Reset time varies from 5 msec to 5 sec, depending upon compute time selected.

FUNCTION SWITCHES

Three single-pole, double throw switches, with terminations on the Quad Summer Modules, provide manual switching flexibility in problem solutions.

POTENTIOMETER PANEL

Maximum capacity: 24 potentiometers, available in groups of 6. Choice of either 10-turn wire-wound potentiometers or single-turn carbon potentiometers for economy.

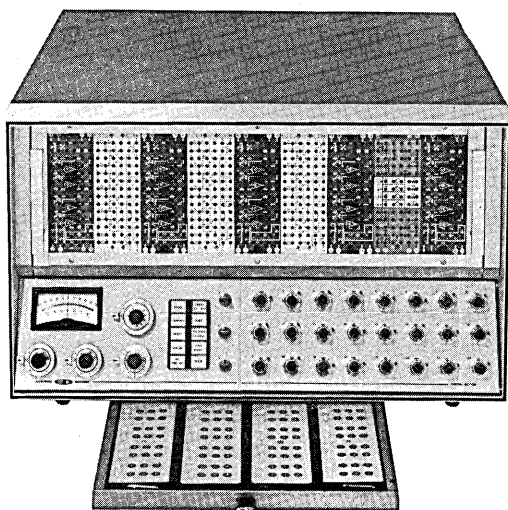

VARIABLE DIODE FUNCTION GENERATOR GROUP
FOUR VDFG CARDS are mounted on a slide-out tray below the Control Panel. Each FG card contains 12 independent segments, all have screwdriver pot adjustment for break point and slope. Each FG channel terminates on a Quad Summer Module.

TYPICAL EQUIPMENT COMPLEMENT

The Basic SD 10/20 is completely wired to accept a full complement of computing modules. Changing and expanding the module complement is accomplished merely by inserting additional computing modules (up to 9) into the pre-wired patchbay.

Item	Quantity
Cabinet with complete Control Panel, reference system, power supply, pre-wired patchbay	1
Quad Summers, Module 3325	5
Quad Integrators, Module 3329 (Dual Multiplier & Comparator)	4
Potentiometer Group, Model 3374 (6 potentiometers in each group)	4
Variable Diode Function Generators, Model 3351	4

SPECIFICATIONS

DUAL OPERATIONAL AMPLIFIER, Model 3310 (2 Model 3310 plug-in cards in each Module 3325 Quad Summer)

Maximum Output Voltage	± 105 volts (1 ma)
Output Voltage (at ± 25 ma)	± 100 volts
Maximum Output Current (at $\pm 100v$)	± 25 ma
Overall DC Gain	$> 10^7$
Summing Junction Offset	$< 100 \mu v/8$ hours

INTEGRATORS (Part of Module 3329)

Reset Relays (Reed type) & Hold	Operate time 0.5 msec (typical) 1 msec (max) Differential operate time 0.2 msec (typical) 0.5 msec (max)
Integrator Drift ($R_{in} = 1M, C_{fb} = 1 \mu f$)	$\pm 20 \mu v/sec$ max.
Noise at Output (with $C_{fb} = 1 MF$)	< 5 mv (PP)

SUMMERS (Module 3325)

Bandwidth ($R_{in} = R_{fb} = 100K$, no capacitive loading at summing junction or output)	> 200 kc (typical overshoot of 1.0 db)
Bandwidth ($R_{in} = R_{fb} = 1M$)	> 50 kc (typically no overshoot)
Velocity Limit	$> 3 \times 10^6$ v/sec
Noise at Output ($R_{in} = R_{fb} = 1M$ with R_{in} grounded)	10mv (PP) (to 100 kc)
Phase shift at 100 cps ($R_{in} = R_{fb} = 100K$)	< 0.03

INPUT & FEEDBACK COMPONENTS

Feedback capacitors of 1 μf and 0.1 μf values to within $\pm 0.02\%$.
Feedback capacitors of 0.01 μf accurate to better than $\pm 1\%$.
1 μf and 0.1 μf capacitors mounted in an oven with ± 1 degree C temperature regulation to reduce inherent dielectric changes with temperature.
Temperature coefficient of 0.01% resistors less than ± 5 ppm per degree C.
Input and feedback resistors matched to $\pm 0.01\%$.

QUARTER SQUARE MULTIPLIERS (Part of Module 3329)

Maximum static error: Less than 100 mv.
Zero Offset: $X = Y = 0 \rightarrow 20$ mv X or $Y = 0 \rightarrow 60$ mv.
Frequency Response: Down no more than 3 db at 50 kc.
Drift: Less than 25 mv for 8 hours at constant temperature, $X = Y = \pm 100$. Less than 5 mv/8 hours, $X = Y = 0$.
Noise: 20 mv (PP) (0 to 100 kc).
Phase Shift: Less than 0.05° at 100 cps and less than 0.5° at 1000 cps.
Input and output signal voltage ranges: ± 100 volts.

DIODE FUNCTION GENERATORS, Model 3351

Noise: < 100 mv (PP) for worst possible conditions; high slope settings and all diodes conducting.
Amplitude Response: Flat to 1 kc.
Phase Shift: $< 1^\circ$ at 100 cycles (when using an operational amplifier output).
Input Impedance: $> 45k$ ohm.

Each function generator card has 12 diode segments (12 slopes and 12 break points). Two FG cards can be paralleled for 24-segment function generation.

Amplifiers required by the function generators are available at the patch board in the Quad Summer Modules. Each diode segment is capable of providing a 2:1 slope change.

Setting of the function is possible by adjusting the appropriate potentiometers while reading out the actual break point and ordinate values.

COEFFICIENT POTENTIOMETERS, Model 3374

Linearity error	$< \pm 0.25\%$
Resolution	$< 0.013\%$
Power Rating	2.5 watts (at $40^\circ C$)
End Resistance	< 10 ohms
Nominal Resistance	30k ohms

PHYSICAL DESCRIPTION

Dimensions: 24" wide, 15" high, 25" deep.
Weight: 125 lb. approx. (fully expanded).
Power Consumption: 350 watts (fully expanded).
Power Source: Connections provided for 115v, 220v, 230v, 240v, 250v, $\pm 10\%$, 50-400 cps.

SYSTRON-DONNER ENGINEERING REPRESENTATIVES

NORTH and CENTRAL ATLANTIC

Burlingame Associates
510 South Fulton Avenue, Mount Vernon, New York
Tel: MO 4-7530
8218 Wisconsin Avenue, Washington 14, D.C.
Tel: OL 4-6400
106 Pickard Bldg., East Malloy Road, Syracuse 11, N.Y.
Tel: 454-2408
7 Wellington Street, Waltham, Massachusetts
Tel: TW 4-1955
222 Long Lane, Upper Darby, Pennsylvania
Tel: JA 8-6080

SOUTH ATLANTIC

E. G. Holmes Associates
3667 Clairmont Rd., N.E., Chamblee, Georgia
Tel: 451-6161
316 1/2 South Bumby Street, Orlando, Florida
Tel: CH 1-2128
430 W. Gaston St., Greensboro, North Carolina
Tel: BR 2-9855
915-F Franklin St. S.E., Huntsville, Alabama
Tel: 539-1114

MIDWEST

S. Sterling Co.
21250 10 1/2 Mile Rd., Southfield, Mich.
Tel: 442-5656
5827 Mayfield Rd., Cleveland 24, Ohio
Tel: HI 2-8080
3300 S. Dixie Dr., Dayton 39, Ohio
Tel: AX 8-7573
4232 Brownsville Rd., Pittsburgh 27, Penn.
Tel: TU 4-5515
7849 N. Lindberg Blvd., Hazelwood, Missouri
Tel: TE 7-1221
Carter Electronics
7203 So. Western Ave., Chicago 36, Illinois
Tel: 776-1601
2401 W. 66th St., Minneapolis 31, Minnesota
Tel: 869-3261
6333 Hollister Dr., Indianapolis 24, Indiana
Tel: AX 3-0696

WEST

Ward-Davis Associates
2425 Mission St., San Marino, California
Tel: 682-3307
1020 Corporation Way, Palo Alto, California
Tel: 968-7116
3492 Pickett St., San Diego, California
Tel: 297-4619
Barnhill Associates
1170 South Sheridan Blvd., Denver 26, Colorado
Tel: 934-5505
319-A Wyoming Blvd., N.E., Albuquerque, New Mexico
Tel: 265-7766
30 Pima Plaza, Scottsdale, Arizona
Tel: 947-5493
Rush S. Drake Assoc.
6133 Maynard Avenue South, Seattle 8, Washington
Tel: PA 5-2700

CANADA

Instronics, Ltd.
P. O. Box 100, Stittsville, Ontario, Canada
Tel: 828-5115



888 GALINDO STREET · CONCORD, CALIFORNIA
Phone: (415) 682-6161 · TWX 415-687-3200

TRANSISTORIZED $\pm 100V$ ANALOG COMPUTER PRICE and QUOTATION FORM

SD 10/20

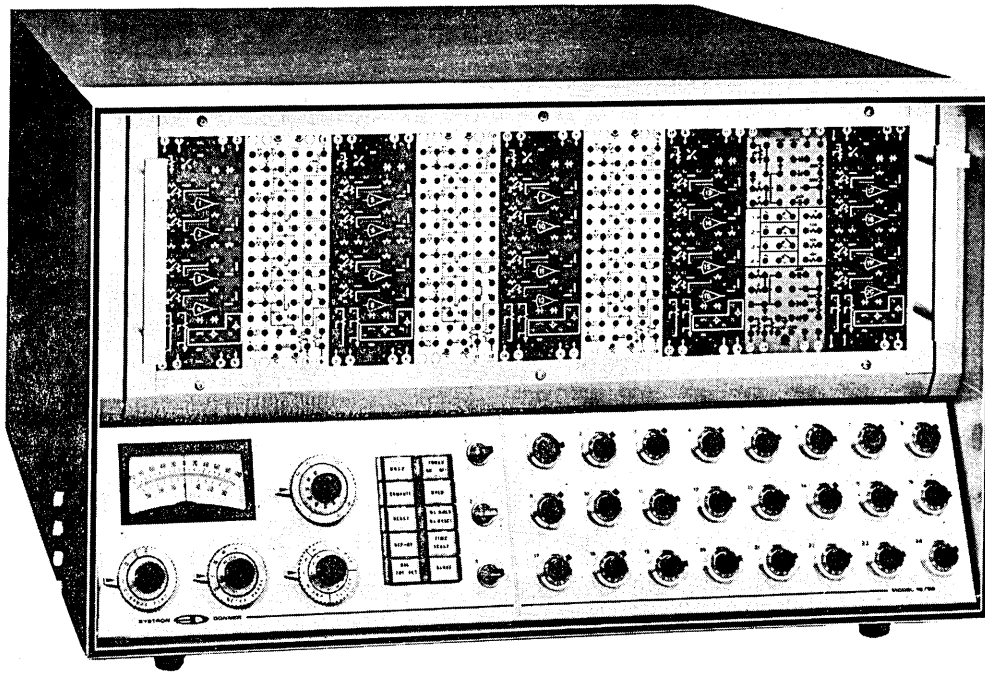

I SD 10/20 COMPUTER

Cabinet with complete Control Panel, Potentiometer Panel (24 potentiometer capacity), pre-wired module receptacle (9 module capacity), computer power supply and ± 100 volt d.c. reference system.

OVERALL DIMENSIONS: 24" wide, 15" high, 25" deep APPROX. WEIGHT: 100 lbs. (fully expanded)

POWER CONSUMPTION: 150 watts (fully expanded)

POWER SOURCE: Connections provided for 115v, 220v, 230v, 240v, 250v, $\pm 10\%$, 50-400 cps.

PRICE \$ 3,000.00

Exhibit 5: 10/20 Price List.

UNIT PRICE	QTY.	TOTAL PRICE
\$3,000.00	_____	\$ _____

1 BASIC SD 10/20 COMPUTER:

2 POTENTIOMETER GROUP:

Model 3374 Pot group, 6 ten-turn wire-wound pots with counting dials	\$ 300.00	_____	\$ _____
--	-----------	-------	----------

Potentiometer TOTAL : _____

3 FUNCTION GENERATOR GROUP:

Model 3351 Variable Diode Function Generator card	215.00	_____	\$ _____
---	--------	-------	----------

Function Generator TOTAL: _____

4 COMPUTING MODULES:

Model 3325 Quad Summer	\$1,000.00	_____	\$ _____
Model 3329 Quad Integrator, Dual Multiplier & Comparator	750.00	_____	_____
Model 3320 Dual Integrator Amplifier	700.00	_____	\$ _____
Model 3321 Dual Summer Amplifier	650.00	_____	_____
Model 3322 Dual Inverter Amplifier and Dual Operational Relay	540.00	_____	_____
Model 3323 Dual Inverter Amplifier and Dual Electronic Multiplier	945.00	_____	_____
Model 3324 Dual Inverter Amplifier and Quad Electronic Switch	835.00	_____	_____
Model 3310 Dual Amplifier (spare card)	400.00	_____	_____

Computing Module TOTAL: _____ including _____ Amplifiers, _____ Summers, _____ Inverters, _____ Integrators, _____ Relay Comparators, _____ Electronic Comparators, _____ Multipliers

5 DIGITAL LOGIC CONTROL MODULES:

Model 3326 Flip-Flops	\$ 500.00	_____	\$ _____
Model 3327 Logic Gates	500.00	_____	_____
Model 3328 Time/Event Control	950.00	_____	_____

6 Removable Problem Board	120.00	_____	\$ _____
----------------------------------	--------	-------	----------

7 Patch Cord and Shunt Plug Assortment (100 items)	100.00	_____	_____
---	--------	-------	-------

8 Universal Module Extender	100.00	_____	_____
------------------------------------	--------	-------	-------

9 Instruction Manual, A.C. Power Cords and Spare Fuse Kit	1-each	_____	N/C
--	--------	-------	-----

10 Special Instructions or assembly requirements: _____

Price for special work (if required) \$ _____

TOTAL PRICE, F.O.B. Concord, California \$ _____

S-D Quotation No: _____

(Please reference this number on all correspondence)

Delivery: _____ days after receipt of Purchase Order

Terms: net 30 days

SYSTRON-DONNER CORPORATION

NOTE: Budgetary prices are subject to change without notice. Signed quotations are firm for a period of 30 days.

Signature _____

Date _____

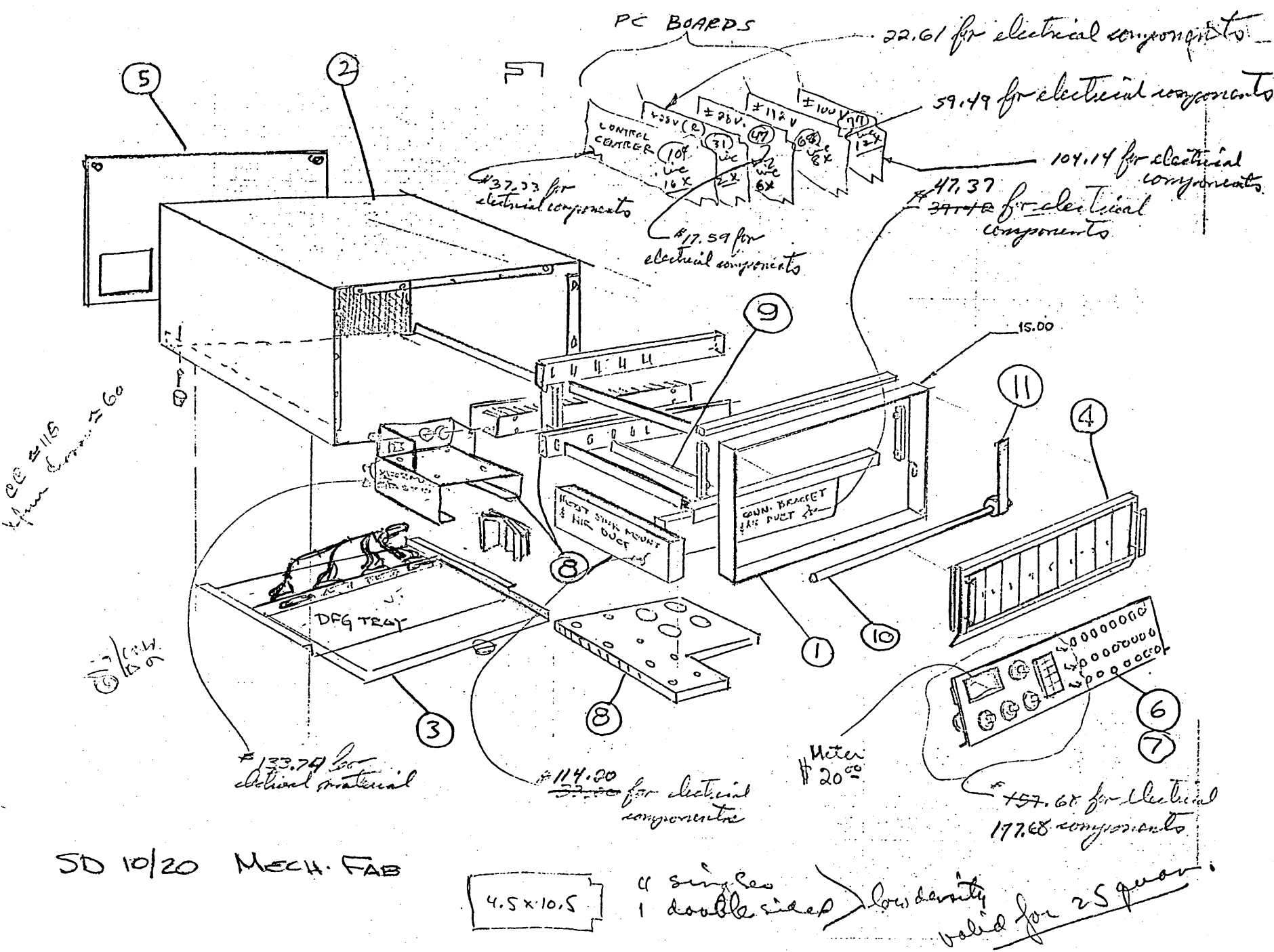

SD 10/20 MECH. FAB

4.5x10.5

4 singles
1 double sided } low density
valid for 25 quad.

Exhibit 6: A Sketch Dick Dunlop Made While Estimating Costs for the 10/20.

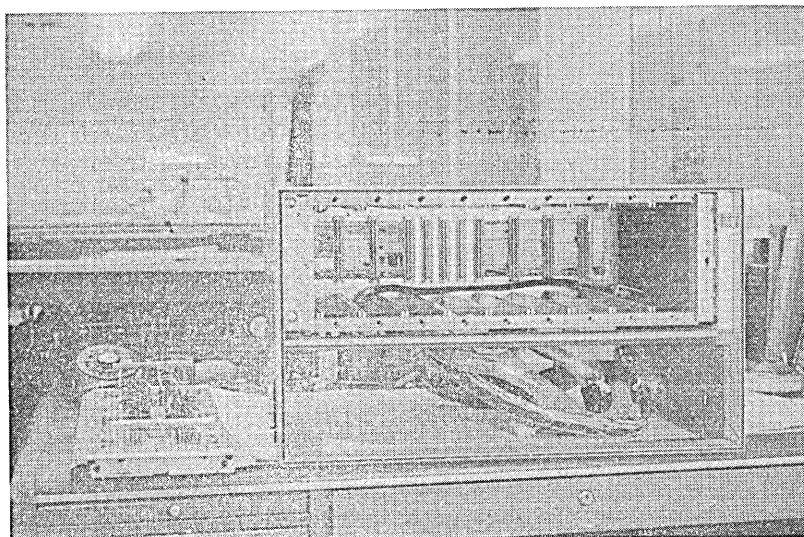
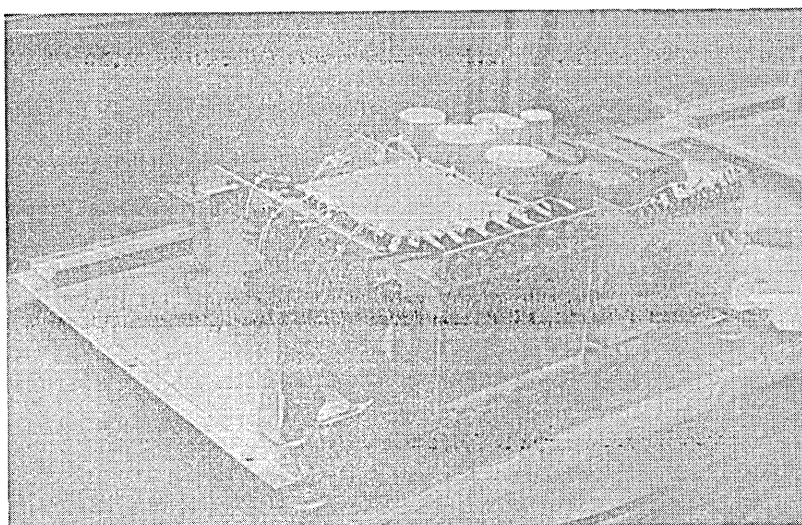
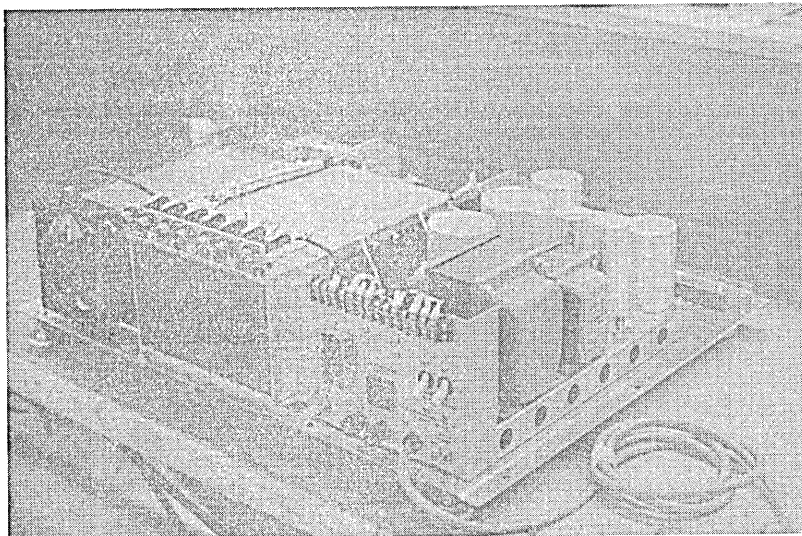
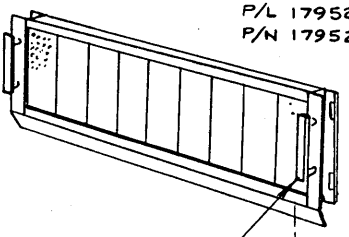

Exhibit 7: 10/20 Chassis and Cabinet.

① PROBLEM BOARD ASS'Y & P/L

P/L 17952
P/N 17952



HANDLE
SUB-ASS'Y

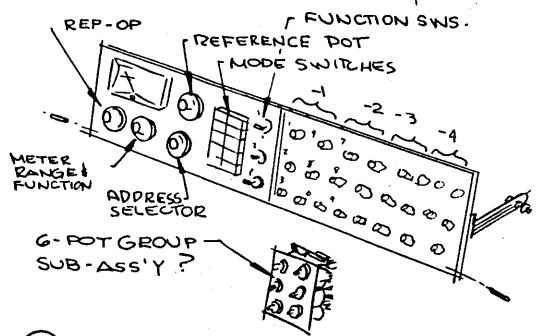

② FRONT PANEL ASS'Y & P/L

P/L 17860
P/N 17860

- 17794 ±100V P.S. P.C. BOARD ASS'Y
- 17795 ±112V P.S. P.C. BOARD ASS'Y
- 17796 ±28V P.S. P.C. BOARD ASS'Y
- 17793 +28V (RELAY) 4OVEN P.S. P.C. BOARD ASS'Y
- 17797 CONTROL CENTER P.C. BOARD ASS'Y

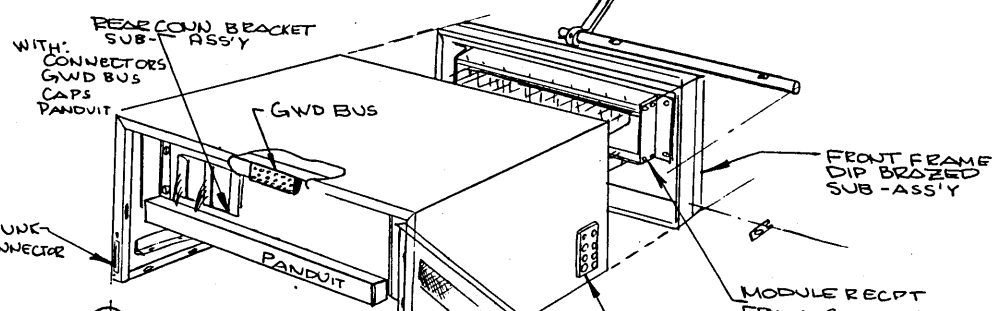

③ CABINET ASS'Y & P/L

P/L 17953
P/N 17953

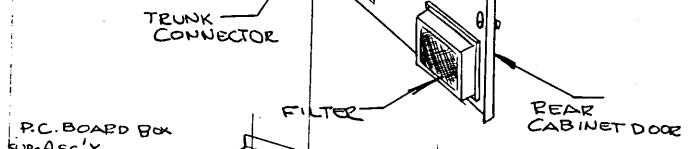

P.C. BOARD BOX SUB-ASS'Y

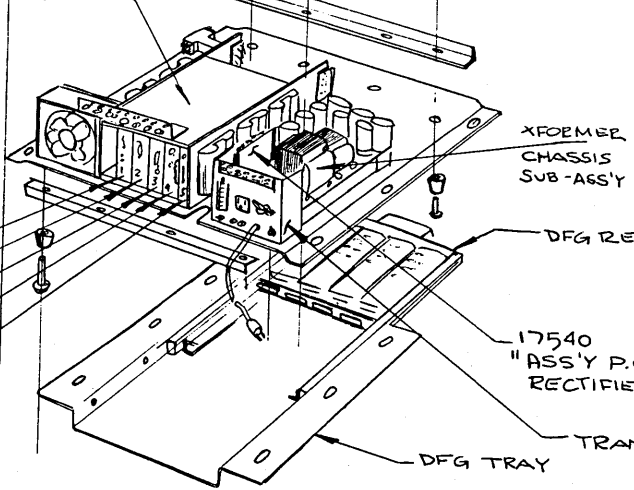

④ BOTOM DECK ASS'Y & P/L

P/L 17954
P/N 17954

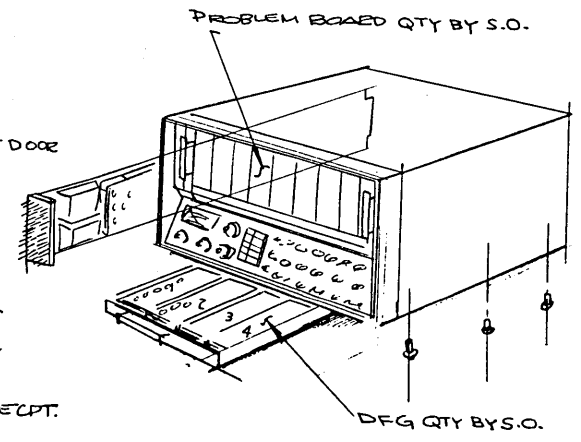

FINAL ASS'Y & P/L
P/L 17955
P/N 17955

SD 10/20 Major Ass'ys & Sub' Ass'ys R.D. Dwyer Nov 29 65

Exhibit 8: One of Dick's Blow-Up Sketches. Reduced in Size.

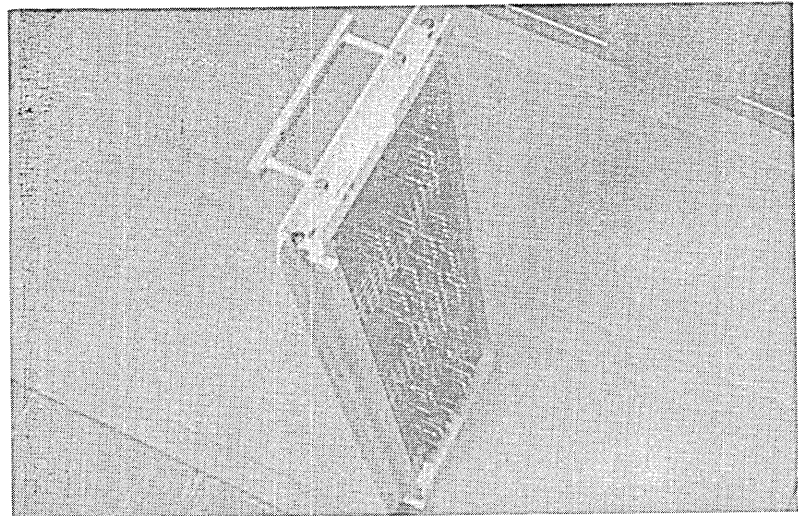
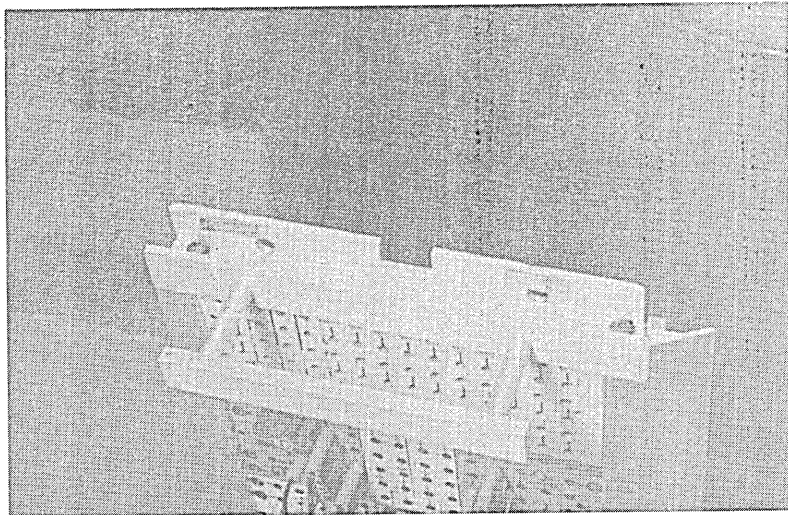
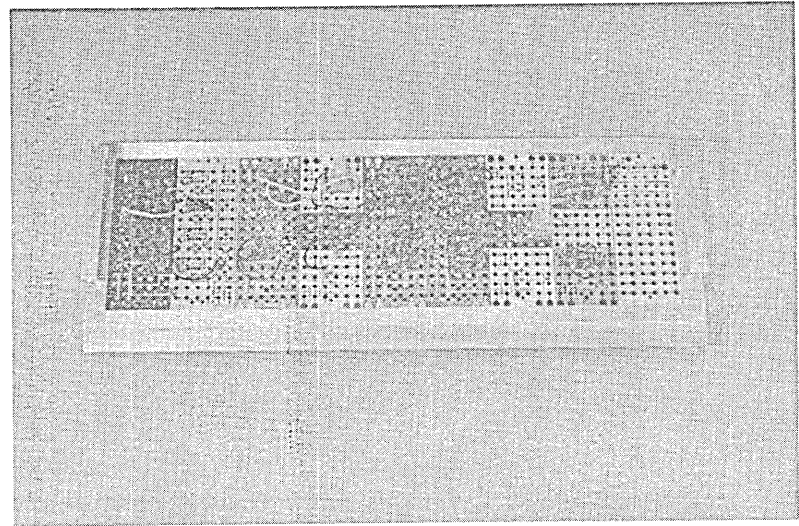
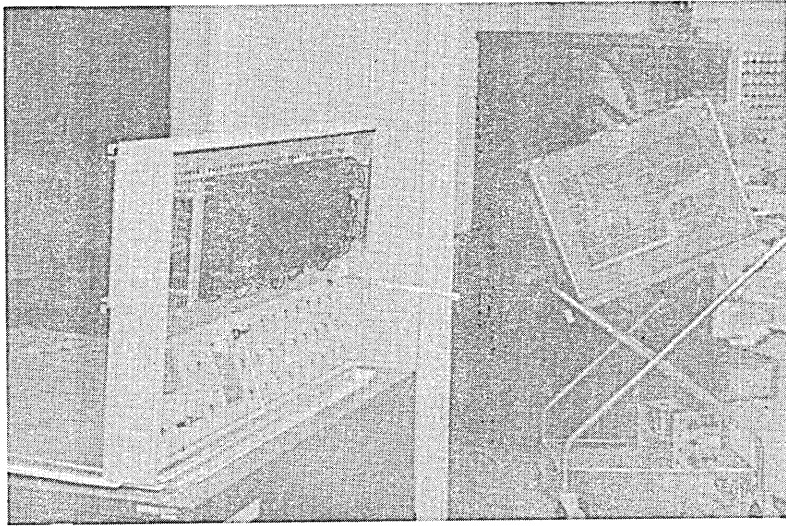

Exhibit 9: Problem Board with Patch Cords, Patch Plugs and Overload Lights.

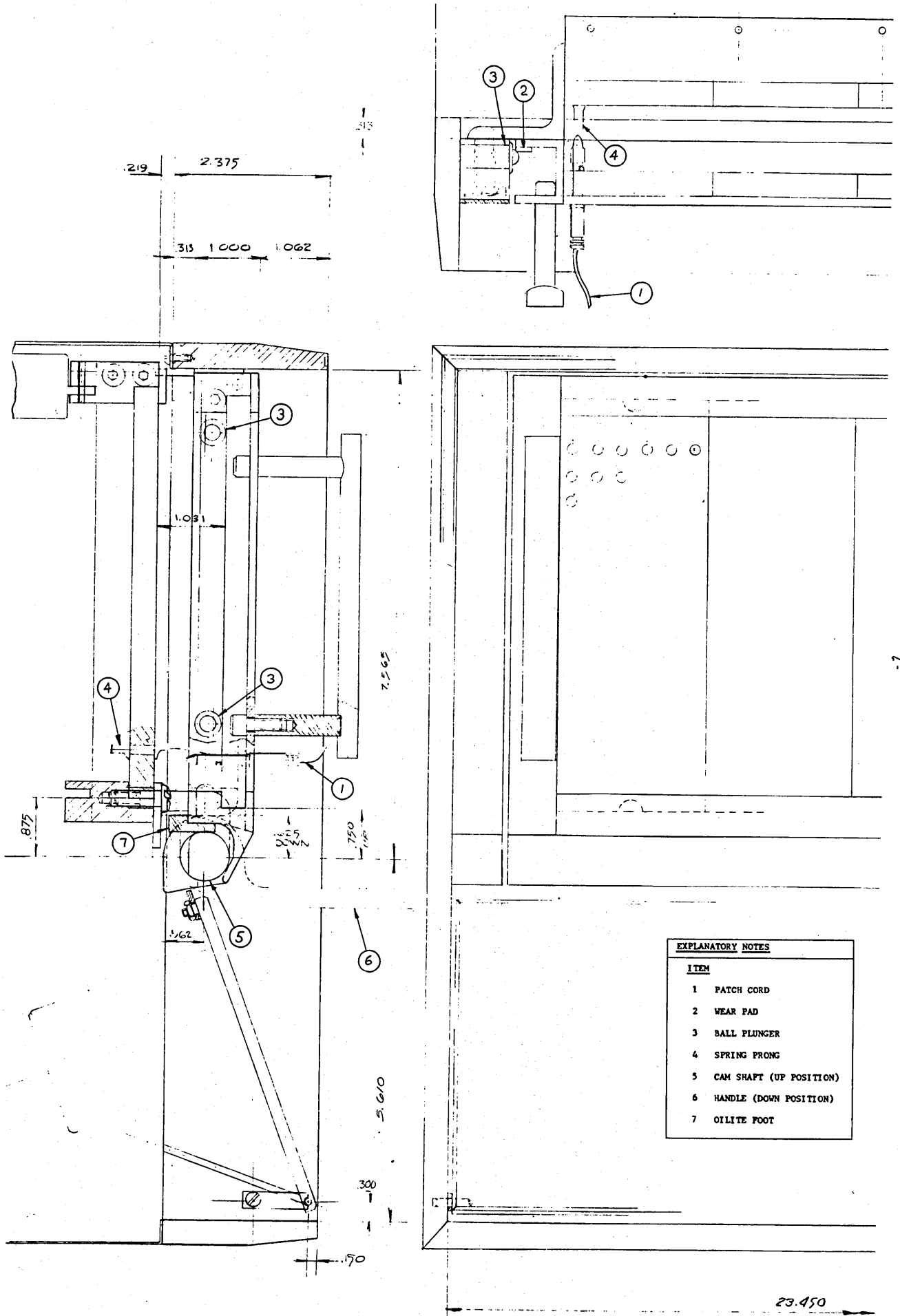

Exhibit 10: Part of Dick's Layout with Notes Added. Reduced in Size.

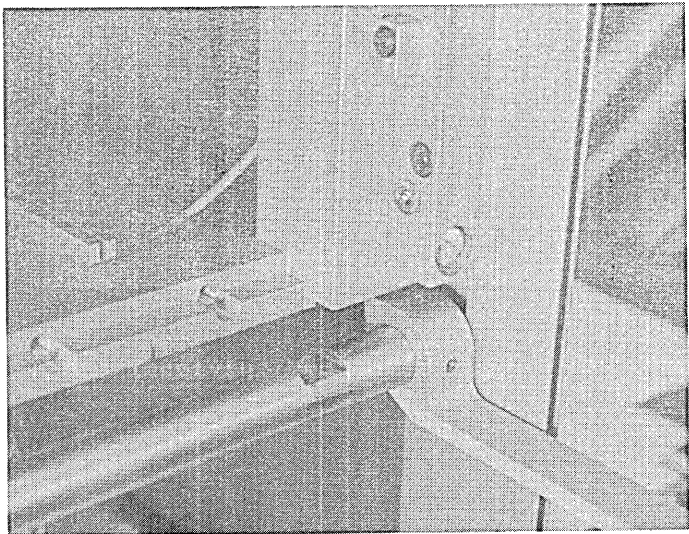
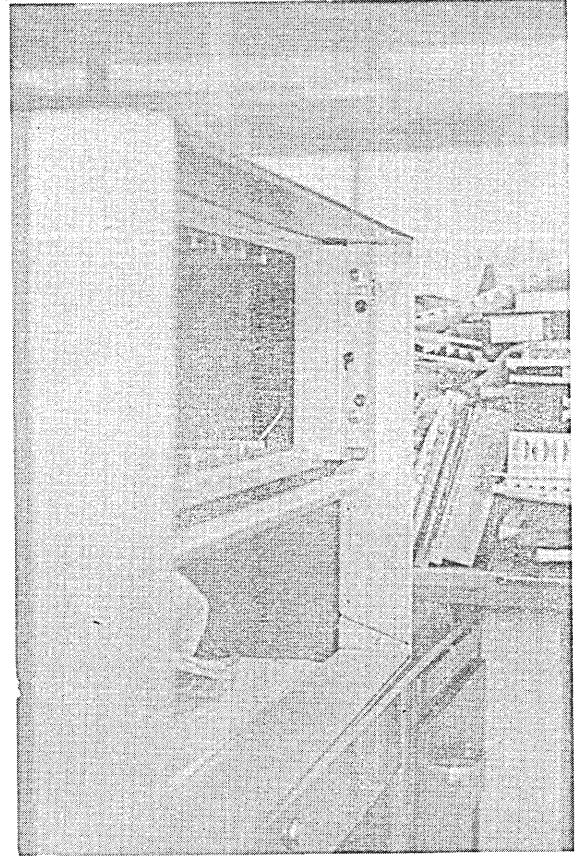
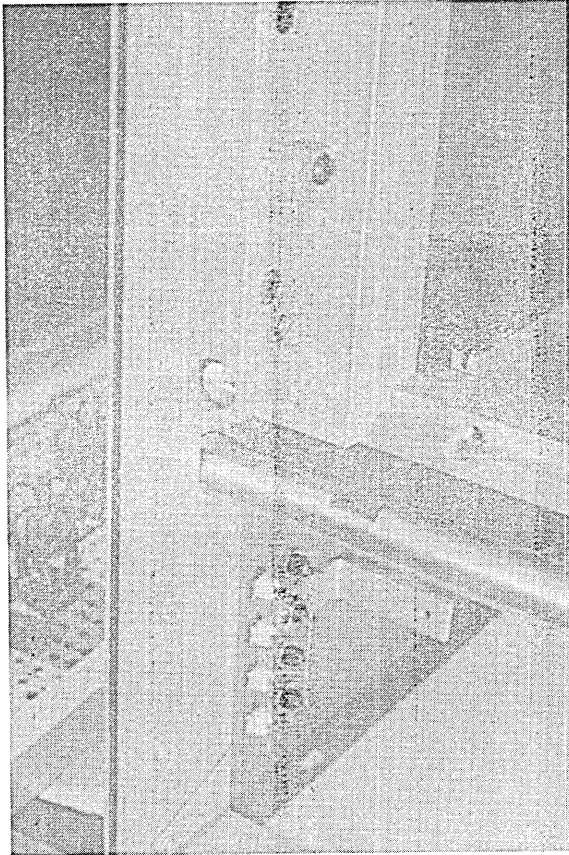
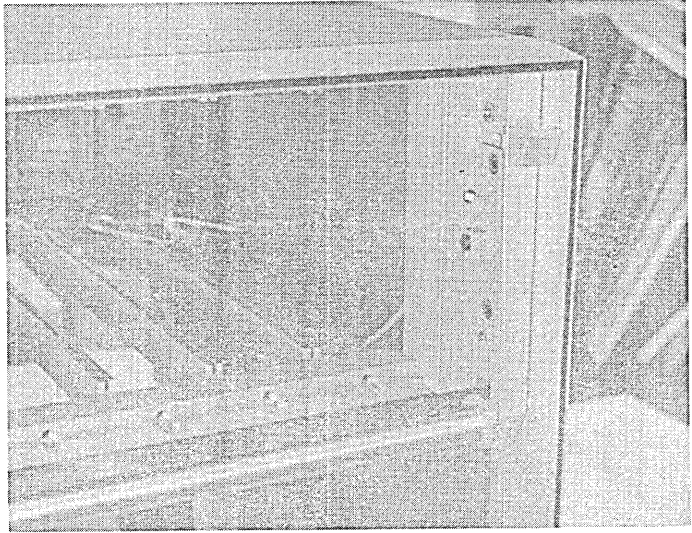
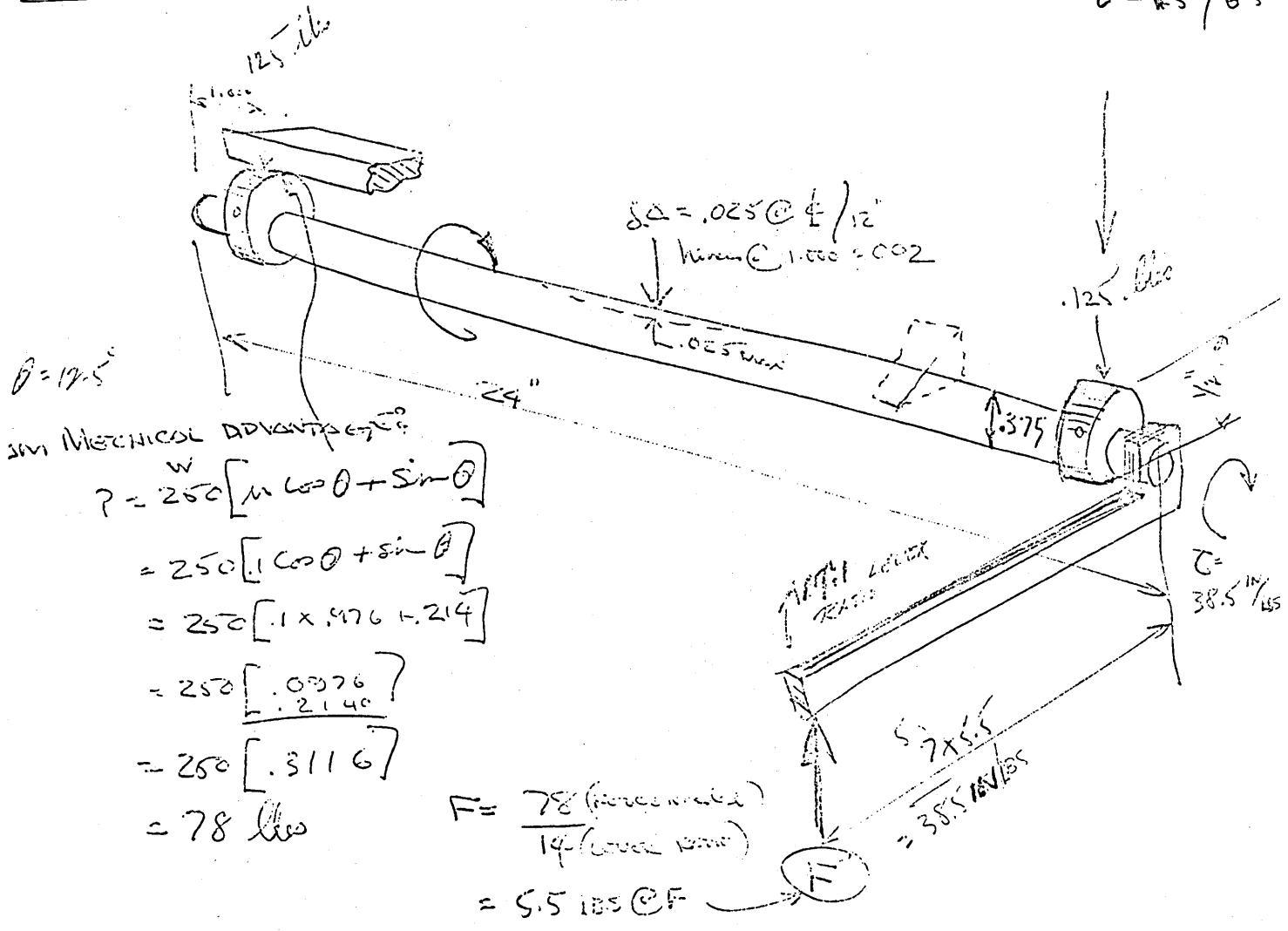

Exhibit 11: Camshaft and Problem Board Receiving Mechanism.

SD 10/20 3M SHAFT STRUCTURE STUDY R. D. Dunlop
6-85/65



3M MECHANICAL ADVANTAGE

$$\begin{aligned}
 P &= 250 [1 \cos \theta + \sin \theta] \\
 &= 250 [1 \cos 17.5 + \sin 17.5] \\
 &= 250 [1 \times .976 + .297] \\
 &= 250 [1.273] \\
 &= 250 [1.273] \\
 &= 318.25 \text{ lbs}
 \end{aligned}$$

$$\begin{aligned}
 F &= \frac{78 \text{ (force needed)}}{14 \text{ (lever arm)}} \\
 &= 5.5 \text{ lbs @ F}
 \end{aligned}$$

Torsional Stress on Shaft
in angular displacement
 $\alpha = \frac{T}{GJ}$

$$\begin{aligned}
 \alpha &= \frac{584 \text{ T/L}}{D^4 G} \\
 &= \frac{(584 \times 38.5)(24)}{D^4 \times 10^7} \\
 &= \frac{539616}{200,000} \\
 &= 2.7^\circ
 \end{aligned}$$

OR FOR D = .5

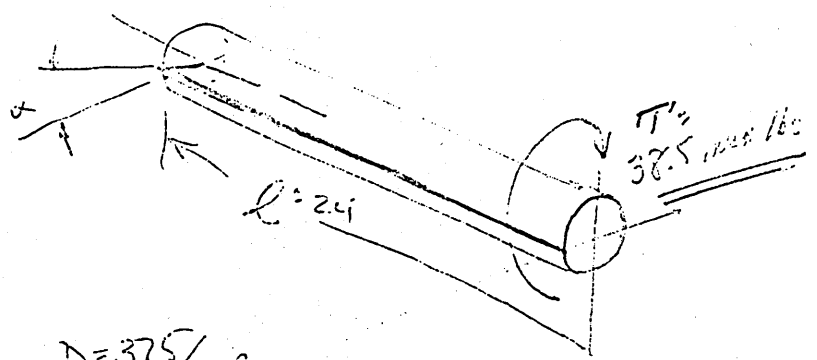

$$\begin{aligned}
 D &= .375 / 2.7^\circ \\
 D &= .500 / 1^\circ
 \end{aligned}$$

Exhibit 12: Calculations for Lever Force and Shaft Twist.

102680885