

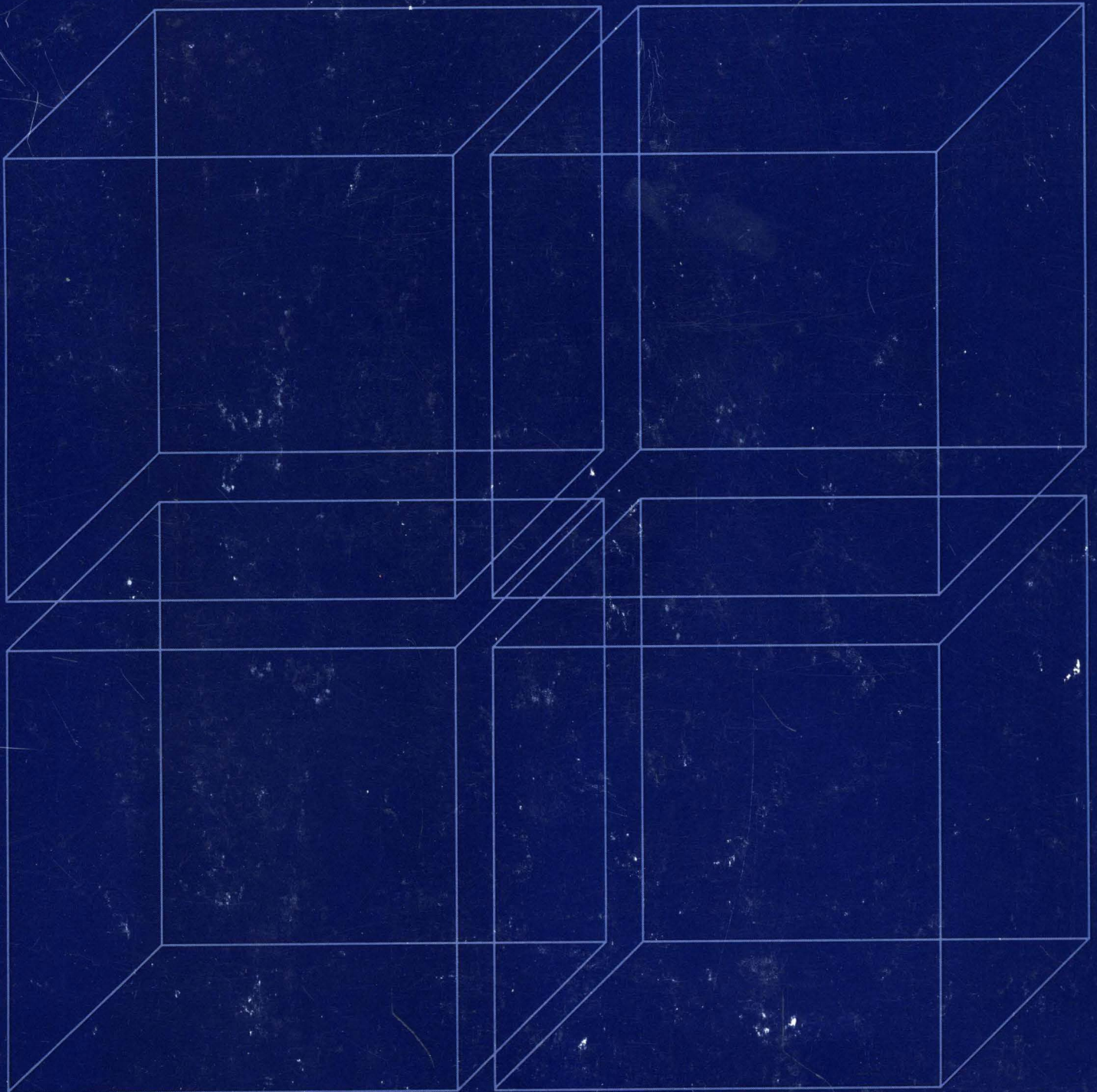

Setup and Operation for the 6091 Color Displays



P/N 39F9074
GA23-2114-03



Setup and Operation for the IBM 6091 Color Displays

GA23-2114-03

Fourth Edition (September 1992)

This edition, GA23-2114-03, applies to the IBM 6091 Color Displays and to any subsequent releases and modifications unless otherwise indicated in new editions or Technical Newsletters.

This publication could contain technical inaccuracies or typographical errors. Changes are made periodically to the information herein.

Any reference to an IBM program product in this publication is not intended to state or imply that only IBM's program product may be used. Any functionally equivalent program may be used instead. References in this publication to IBM machines, programs, or services do not imply that IBM intends to make these available in all countries in which IBM operates.

Publications are not stocked at the address below. Make requests for IBM publications to your IBM representative, or to your local IBM branch office.

A form for reader's comments is provided at the back of this publication. If the form has been removed, address comments to IBM Corporation, Department 30SE, MS 634, Neighborhood Road, Kingston, N.Y., U.S.A. 12401. IBM may use or redistribute whatever information you supply in any way it believes appropriate without incurring any obligation to you.

GA23-2114-03 © Copyright International Business Machines Corporation 1992. All rights reserved. Note to U.S. Government Users — Documentation related to restricted rights. Use, duplication, or disclosure is subject to restrictions set forth in GSA ADP Schedule Contract with IBM.

Canadian Department of Communications Compliance Statement

This equipment does not exceed Class A limits per radio noise emissions for digital apparatus, set out in the Radio Interference Regulation of the Canadian Department of Communications. Operation in a residential area may cause unacceptable interference to radio and TV reception requiring the owner or operator to take whatever steps are necessary to correct the interference.

Avis de conformité aux normes du ministère des Communications du Canada

Cet équipement ne dépasse pas les limites de Classe A d'émission de bruits radioélectriques pour les appareils numériques, telles que prescrites par le Règlement sur le brouillage radioélectrique établi par le ministère des Communications du Canada. L'exploitation faite en milieu résidentiel peut entraîner le brouillage des réceptions radio et télé, ce qui obligerait le propriétaire ou l'opérateur à prendre les dispositions Nécessaires pour éliminer les causes.

Federal Communications Commission (FCC) Statement

Warning: This equipment generates, uses, and can radiate radio frequency energy and if not installed and used in accordance with the instruction manual, may cause interference to radio communications. It has been tested and found to comply with the limits for a Class A computing device pursuant to Subpart J of Part 15 of FCC rules, which are designed to provide reasonable protection against such interference when operated in a commercial environment. Operation of this equipment in a residential area is likely to cause interference in which case the user at his own expense will be required to take whatever measures may be required to correct the interference.

Instructions to User: If this equipment does cause interference to radio or television reception, which can be determined by turning the equipment off and on, the user is encouraged to try to correct the interference by one or more of the following measures:

- Reorient the receiving antenna.
- Relocate the device with respect to the receiver.
- Move the device away from the receiver.
- Plug the device into a different outlet so that device and receiver are on different branch circuits.

Properly shielded and grounded cables and connectors must be used for connection to peripherals in order to meet FCC emission limits. Proper cables are available from IBM authorized dealers. IBM is not responsible for any radio or television interference caused by using other than recommended cables or by unauthorized modifications to this equipment. It is the responsibility of the user to correct such interference.

If necessary, the user should consult the dealer or an experienced radio/television technician for additional suggestions. The user may find the following booklet prepared by the Federal Communications Commission helpful:

How to Identify and Resolve Radio-TV Interference Problems

This booklet is available from the following:

| | |
|--|---|
| Consumer Assistance and Small Business Division Room 254 1919 M St. NW Washington, DC 20554 Tele (202) 632-7000 | FOB Public Contact Branch Room 725 1919 M St. NW Washington, DC 20554 Tele (202) 634-1940 |
|--|---|

The United Kingdom Telecommunication Act 1984

This apparatus is approved under approval number NS/G/23/J/100003 for indirect connections to the public telecommunications systems in the United Kingdom.

Convergence Safety

Hinweise

Die Konvergenz des Bildes kann sich auf Grund des Magnetfeldes am Ort der Aufstellung aus der korrekten Grundeinstellung verändern, Zur Korrektur empfiehlt es sich deshalb, die Regler an der Frontseite für H.STAT und V.STAT so einzustellen, daß der Darstellung eines Buchstabens zur Deckung (Konvergenz) gelangen. Siehe hierzu auch die Erklärungen zu H.STAT und V.STAT.

Vertikalkonvergenzregler (V-STAT)

Die Konvergenz ist werksmäßig in der Mittelstellung des Reglers abgeglichen. Bei Abweichungen ist der Regler so einzustellen, daß die roten und die blauen Vertikallinien mit der grünen Vertikallinie zur Deckung kommen.

Horizontalkonvergenzregler (HSTAT)

Die Konvergenz ist werksmäßig in der Mittelstellung des Reglers abgeglichen. Bei Abweichungen ist der Regler so einzustellen, daß die roten und die blauen Horizontallinien mit der grünen Horizontallinie zur Deckung kommen.

Contents

| | |
|--|-----|
| Preface | vii |
| Who Uses This Guide | vii |
| What This Guide Is About | vii |
| How This Guide Is Organized | vii |
| Further References | vii |
| Display Specifications and Compatibility | vii |
| | |
| Chapter 1. Materials Shipped with Your Color Display | 1 |
| 6091-023 Checklist | 1 |
| 6091-19i Checklist | 2 |
| 6091-016 Checklist | 3 |
| | |
| Chapter 2. Setting Up the Color Display | 5 |
| 6091-023 | 5 |
| 6091-19i | 6 |
| 6091-016 | 7 |
| Connecting the Video Cables | 8 |
| Plugging In the Power Cord | 10 |
| | |
| Chapter 3. Operating the 6091 Color Displays | 11 |
| 6091-023 | 11 |
| 6091-19i | 12 |
| 6091-016 | 13 |
| Powering On the Displays | 14 |
| Adjusting the Brightness (6091-023) and the Contrast (6091-19i and 6091-016) | 14 |
| Adjustment Procedure for 6091 Display (on an IBM 5080 or 6090 Graphics | |
| System) | 15 |
| Selecting Monitor Test Patterns | 15 |
| Adjust Horizontal Centering (6091-016 & 6091-19i) | 16 |
| Adjust Vertical Centering | 16 |
| Adjust Convergence | 16 |
| Verification | 16 |
| Adjustment Procedure for the 6091 Display (on a RISC System/6000) | 17 |
| Procedures for Selecting Monitor Test Patterns | 17 |
| Adjust Horizontal Centering (6091-016) | 20 |
| Adjust Vertical Centering | 20 |
| Adjust Convergence | 20 |
| Verification | 20 |
| For Non-IBM Graphics Systems Adjustment of the Monitor | 21 |
| Preventing Signal Loss When Connecting Additional View-Only Displays | 21 |
| Setting the Gain Switch on the 6091-023 (Signal Attenuation) | 21 |
| Setting the Input Impedance Switch on the 6091-19i and 6091-016 | 23 |
| Cleaning the Display | 24 |
| Preventing Overheating of the Display | 24 |
| Four Ways to Make Working with Your Display More Comfortable | 24 |
| | |
| Chapter 4. Display and Video Specifications | 25 |
| General Display Specifications | 25 |
| Video Specifications | 26 |
| Summary of Monitor Timing Parameters for 6091-023 | 28 |
| Summary of Monitor Timing Parameters for 6091-19i | 29 |

Summary of Monitor Timing Parameters for 6091-016 30

Preface

Who Uses This Guide

Use this guide if you are planning to attach a 6091 display to a processor with a compatible video interface.

What This Guide Is About

This guide describes the setup and operation details of your 6091 color display.

How This Guide Is Organized

This guide is intentionally brief, because the setup and operation of your 6091 color display varies greatly with the processor you choose to use with your system.

Read this list to find out what sections are in this guide:

- A checklist of materials shipped with the 6091 displays
- A short description of the 6091 displays
- A few details on setting up the 6091 displays
- Some simple procedures for operating the 6091 displays
- Display specifications that assist you in making sure the 6091 displays are compatible with your processor.

Further References

- *IBM 5080 Graphics System: Setup Instructions (5085 Models 1, 1A, 2)*, GA23-2007.
- *IBM 5080 Graphics System: Setup Instructions (5085 Model 2A)*, GA23-2035.
- *IBM 5080 Graphics System: Setup Instructions (5086)*, GA23-2051.
- *Setup Instructions for the IBM 6095 Graphics Processor*, GA23-2102.
- Your RISC System/6000 Setup document.

Display Specifications and Compatibility

Not all display models work with all processors. Refer to your IBM marketing representative for processor compatibility.

Chapter 1. Materials Shipped with Your Color Display

6091-023 Checklist

Look at the pictures on this page to see what materials come with your 6091-023 display.

6091-023 Display

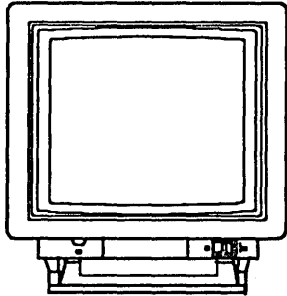

Documents



Line Cord



Note: The power cord is certified as type H05VV – F where applicable.

6091-19i Checklist

Look at the pictures on this page to see what materials come with your 6091-19i display.

6091-19i Display

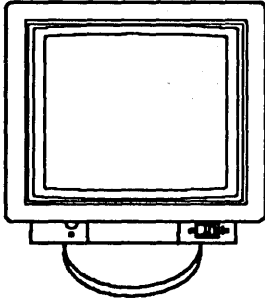

Documents

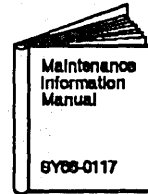
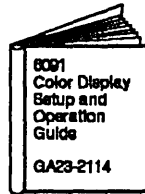

Line Cord



Note: The power cord is certified as type H05VV-F where applicable.

6091-016 Checklist

Look at the pictures on this page to see what materials come with your 6091-016 display.

6091-016 Display

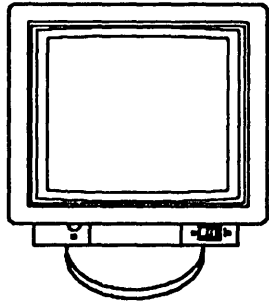

Documents

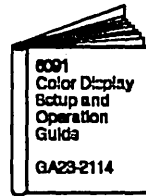

Line Cord



Note: The power cord is certified as type H05VV – F where applicable.

Chapter 2. Setting Up the Color Display

6091-023

The 6091-023 is a raster display performing a variety of high resolution (1024 x 1024 or 1280 x 1024 pixels) graphics applications.

The display attaches to a processor with a compatible video interface to create an interactive graphics display station. You can attach up to five view-only displays to this graphics display station.

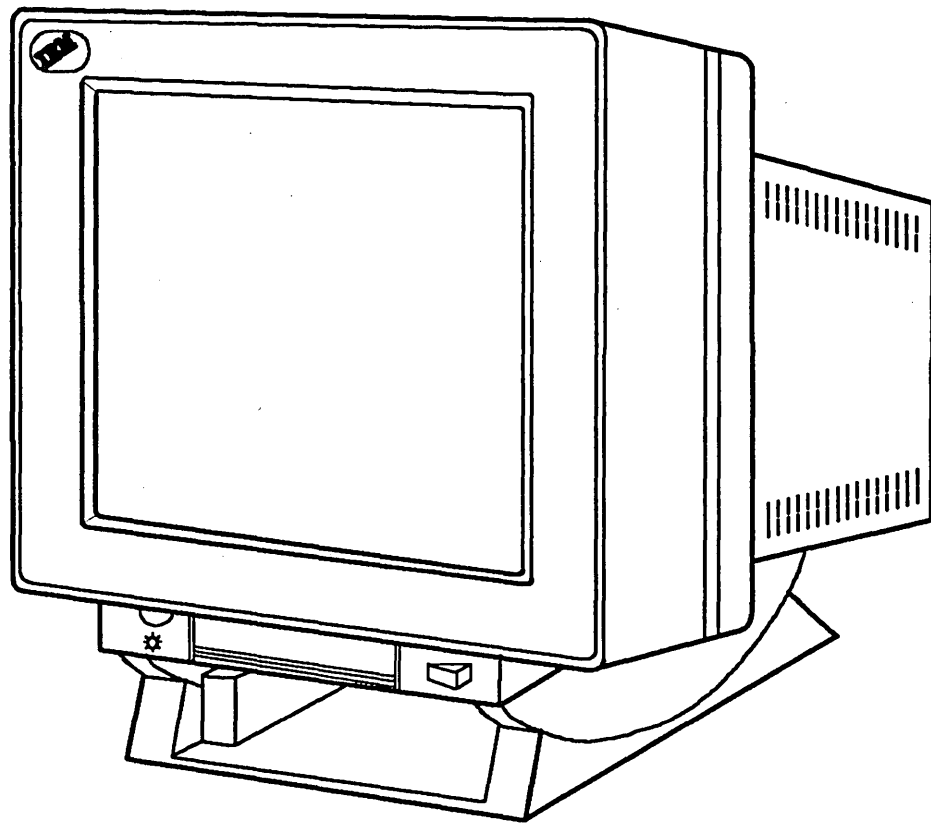

Figure 1. The 6091-023 color display

Look for the unpacking instructions printed on the top panel of the display shipping carton. After unpacking this material, read pages 8 to 10 to find out how to set up your display.

6091-19i

The 6091-19i is a raster display performing a variety of high resolution (1024 x 1024, 1280 x 1024 or 1280 x 496 pixels) graphics applications.

The display attaches to a processor with a compatible video interface to create an interactive graphics display station. You can attach up to five view-only displays to this graphics display station.

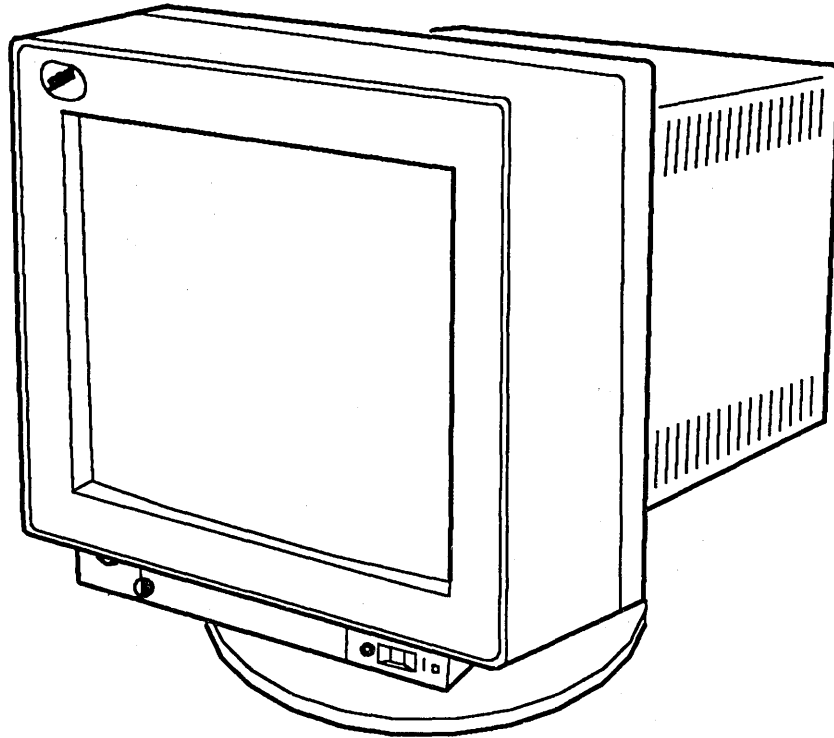

Figure 2. The 6091-19i Color display

Look for the unpacking instructions printed on the top of the display shipping carton. After unpacking this material, read pages 8 to 10 to find out how to set up your display.

6091-016

The 6091-016 is a raster display performing a variety of high resolution (1280 x 1024 or 1024 x 768 pixels) graphics applications.

The display attaches to a processor with a compatible video interface to create an interactive graphics display station. You can attach up to five view-only displays to this graphics display station.

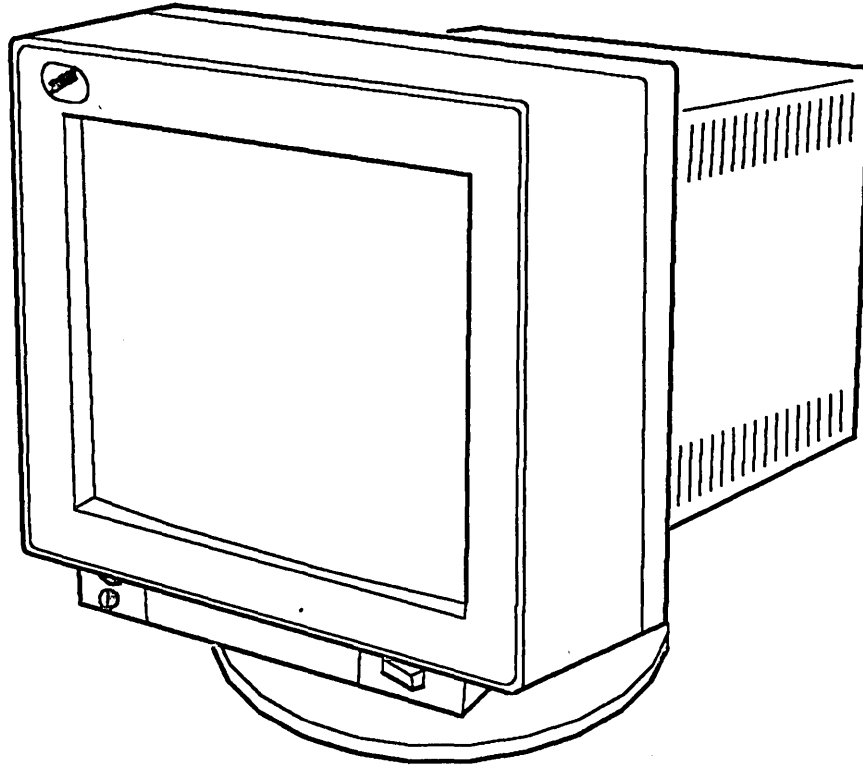

Figure 3. The 6091-016 color display

Look for the unpacking instructions printed on the top of the display shipping carton. After unpacking this material, read pages 8 to 10 to find out how to set up your display.

Connecting the Video Cables

Before you begin using the 6091 display, you must connect the video cables from the graphics processor to the display.

- Refer to Figure 4 if you have a 23" display.
- Refer to Figure 5 on page 9 if you have a 16" or 19" display.

Follow these procedures to connect the video cables at your display:

1. Attach the red, green, and blue, and (if needed) the external horizontal and vertical sync video cables from your processor to the bottom row of connectors on the back of the interactive display. Look for the input cable markings. (See Figure 4 or Figure 5 on page 9 for the input symbol you need to locate.)
2. If you are also using view-only displays, connect video cables to the top row of connectors on the back of each display. Look for the output cable markings. (See Figure 4 or Figure 5 on page 9 for the output symbol you need to locate.)
3. Attach the other end of all the video cables to the input connectors on the back of the first view-only display. Look for the input cable markings.

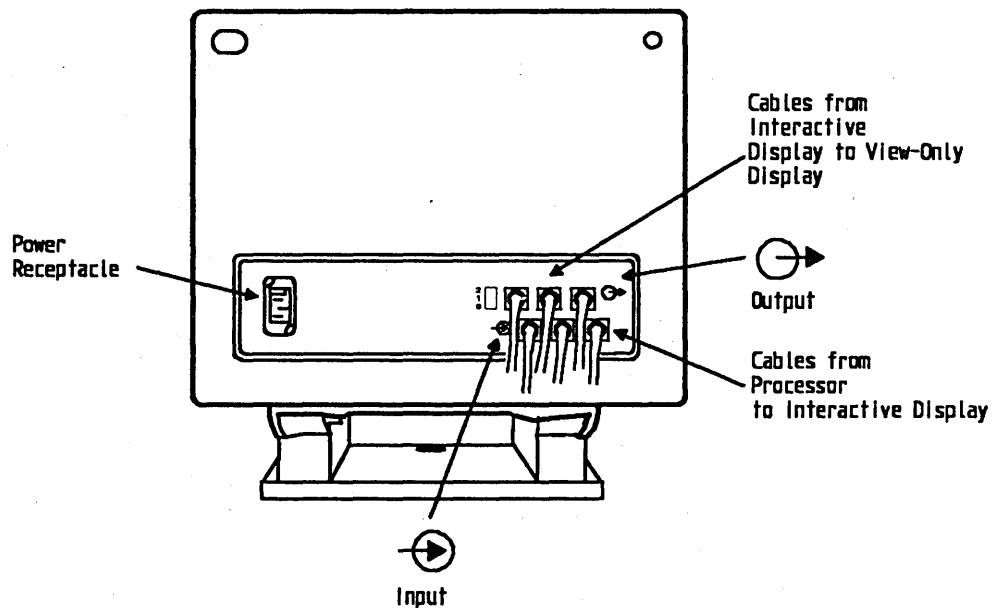

Figure 4. Power receptacle and cable connections on the 6091-023 display

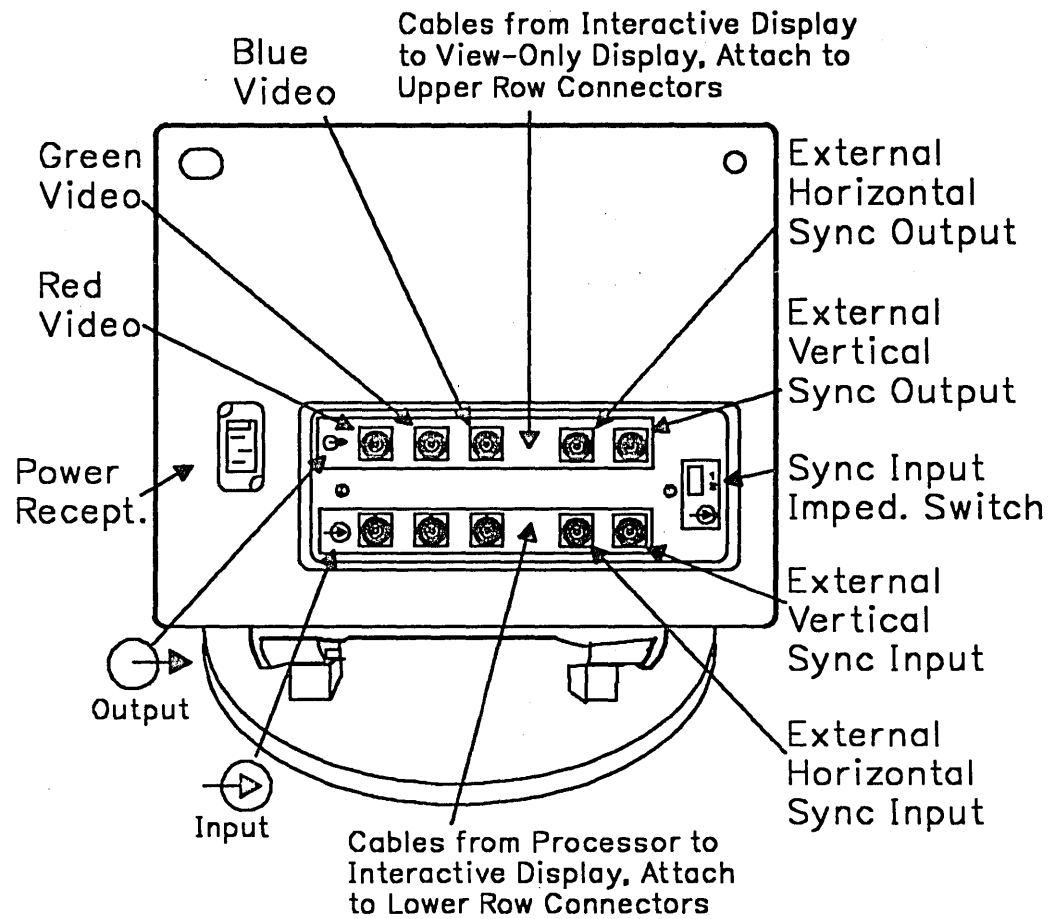

Figure 5. Power receptacle and cable connections on the 6091-19i and the 6091-016 displays

Plugging In the Power Cord

Follow these steps to install the wall power cord:

1. Plug the power cord into the power receptacle at the back of the display. See Figure 4 on page 8 and Figure 5 on page 9 for the location of this receptacle.
2. Plug the three-prong end of the power cord into a wall outlet. You must plug the graphics processor and the monitor into the same wall outlet.

Note: The power cord is certified as type H05VV-F, where applicable

Chapter 3. Operating the 6091 Color Displays

This chapter describes how to adjust the various controls on your display, as well as centering and convergence adjustments.

6091-023

You can tilt the 6091-023 display to fit your work needs.

Figure 6 shows all the controls located on the front of the display. The power on/off switch, operation lights, and controls for picture quality are found here.

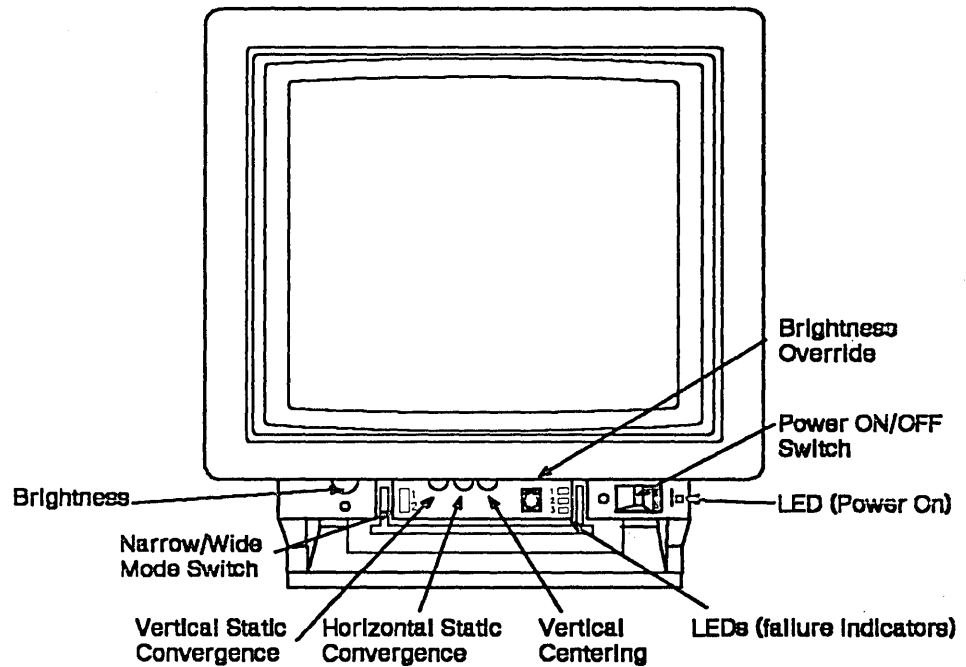
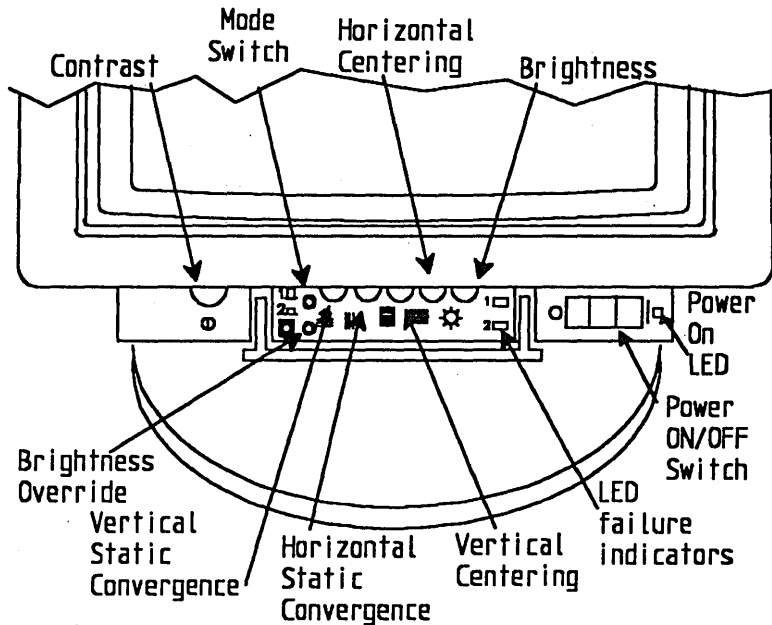

Figure 6. Controls for the 6091-023 display

6091-19i

You can tilt and swivel the 6091-19i display to fit your work needs.

Figure 7 shows all the controls located on the front of the display. The power on/off switch, operation lights, and controls for picture quality are found here.



NOTE:
Failure LEDs #1 & #2 turn on and then off at IPL.

Figure 7. Controls for the 6091-19i display

| MODE* | MODE SWITCH POSITION | RESOLUTION | SCREEN REFRESH RATE |
|-------|----------------------|-------------|---------------------|
| 1 | 1 | 1024 X 1024 | 60 Hz |
| 2 | 2 | 1280 X 1024 | 60 Hz |
| 3 | N/A | 1280 X 1024 | 77 Hz |
| 4 | N/A | 1280 X 496 | 120 Hz (Stereo) |

Note: If the incoming screen refresh rate is 60 Hz, the mode switch must be set to positions 1 or 2 to select the desired screen width.

If the incoming screen refresh rate is 77 or 120 Hz, the mode switch is inoperable (the display automatically selects the screen width).

You can tilt and swivel the 6091-016 display to fit your work needs.

CAUTION:

Do not remove the 6091-016 from its base. The 6091-016 cannot be used without the tilt swivel base.

Figure 8 shows all the controls located on the front of the display. The power on/off switch, operation lights, and controls for picture quality are found here.

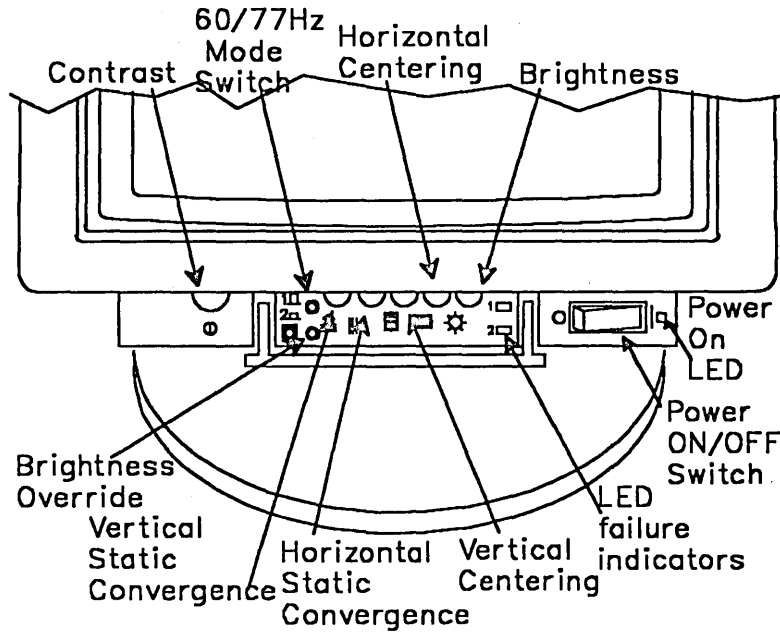

NOTE:
Failure LEDs #1 & #2 turn on and then off at IPL.

Figure 8. Controls for the 6091-016 display

Powering On the Displays

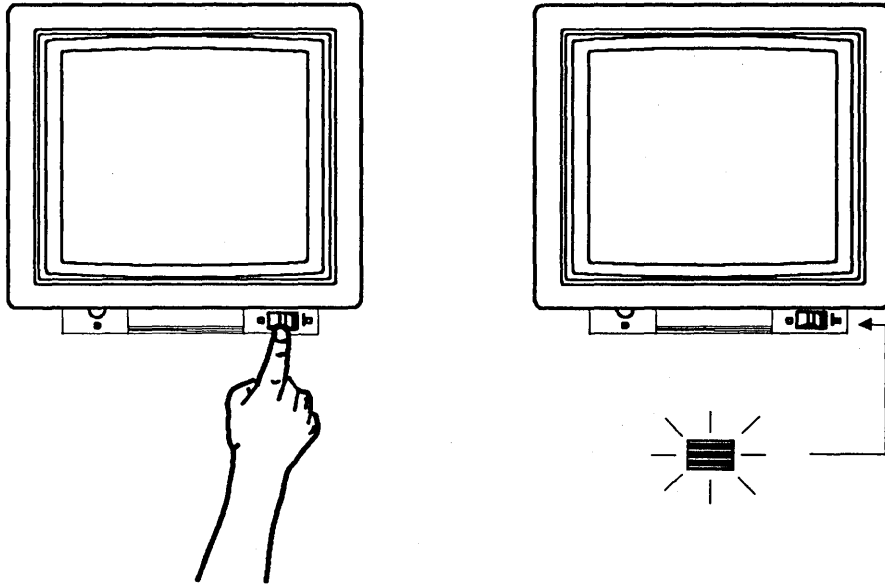

Note: The 6091-19i has a pushbutton on/off switch.

Adjusting the Brightness (6091-023) and the Contrast (6091-19i and 6091-016)

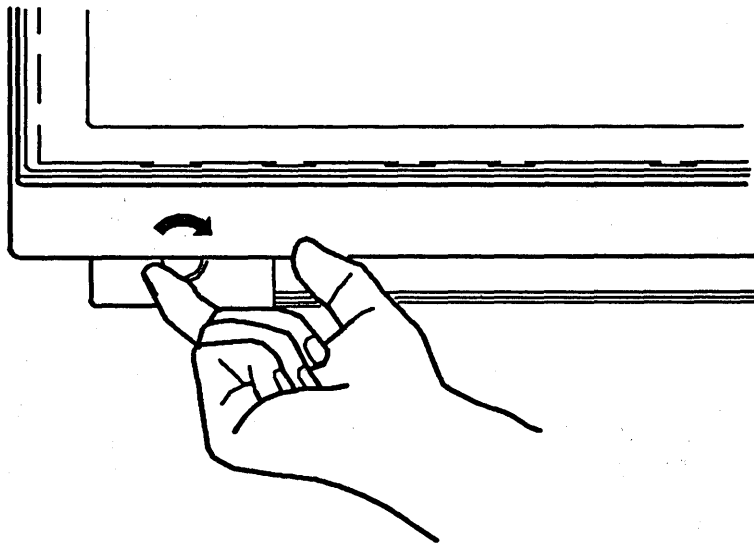

Adjustment Procedure for 6091 Display (on an IBM 5080 or 6090 Graphics System)

Selecting Monitor Test Patterns

1. Check the mode switch for the proper mode selection.
2. Display Customization Panel 01-01 by pressing and holding down an Alt key and pressing Setup.
3. Press F1 for the main menu.
4. On the main menu, type in 31 and press Enter.
5. The color bar test pattern will appear.
6. Make sure the following test pattern appears as shown and the colors are in their proper order. (If colors are in the wrong order, check the RGB cable for proper connections.)
7. When you have finished using this pattern, type q and press Enter. The grid pattern panel will be shown. See the grid pattern panel on the following page.

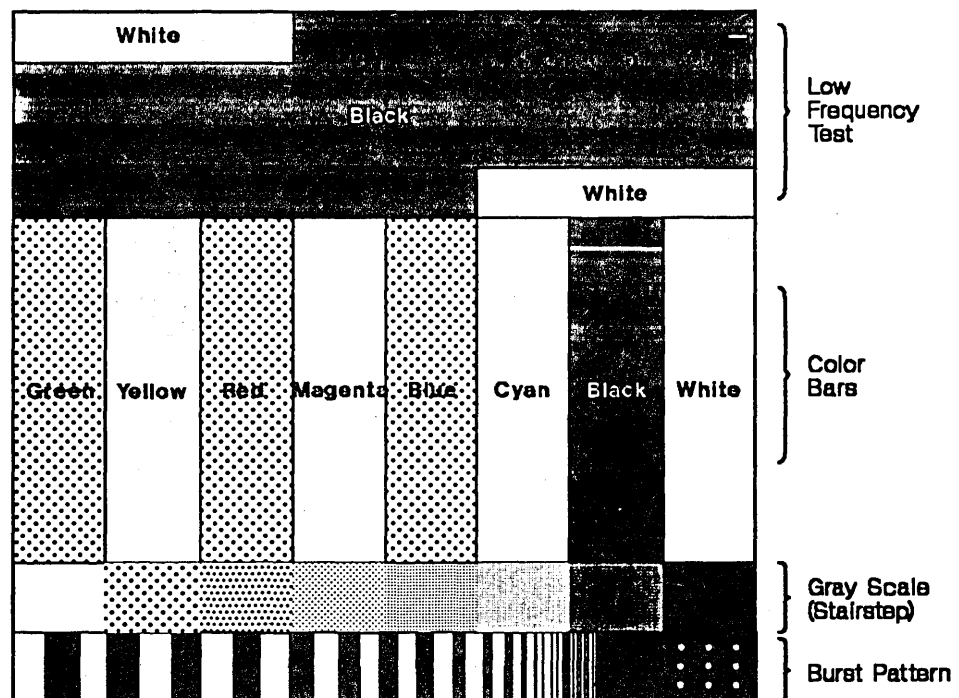

Figure 9. Combination color test pattern

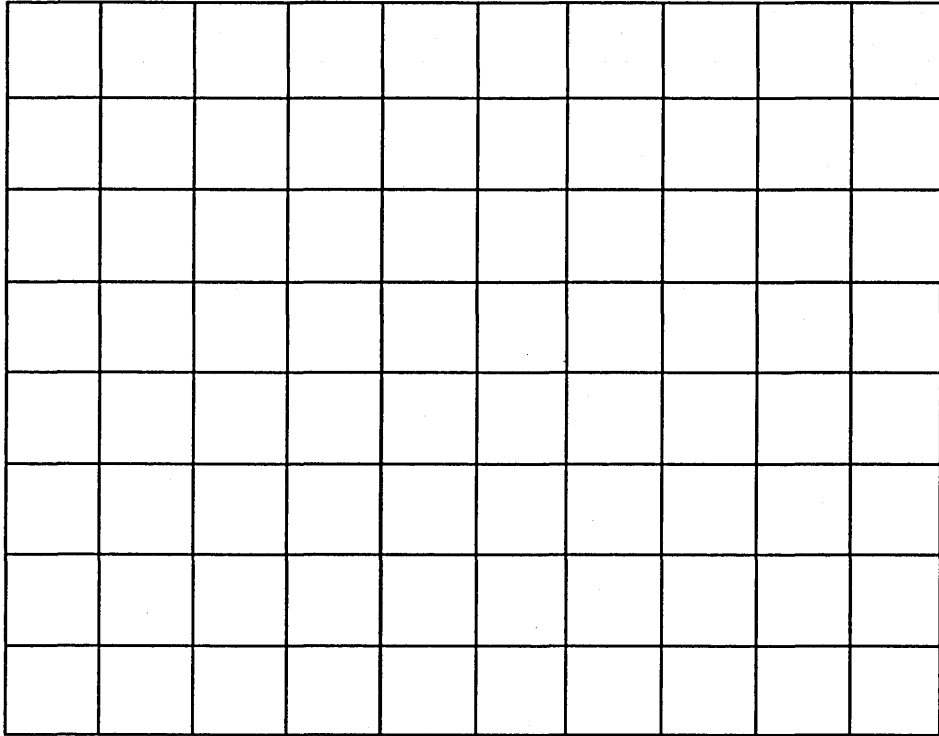

Figure 10. 9 x 11 Grid Pattern Panel

Note: There are two grid patterns. Use the 9 x 9 for 1024 x 1024 mode and the 11 x 9 for 1280 x 1024 mode.

Adjust Horizontal Centering (6091-016 & 6091-19i)

Adjust the horizontal centering control on the display until the grid is centered on the screen between the right and left edges of the screen. If you cannot get the grid centered on the screen, contact your help desk.

Adjust Vertical Centering

Adjust the vertical centering control on the display until the grid is centered between the top and bottom edges of the screen. If you cannot get the grid properly centered, contact your help desk.

Adjust Convergence

Look at the center of the grid. Turn the vertical static convergence control until the horizontal lines are white. Turn the horizontal static convergence control until the vertical lines are white.

If you cannot obtain reasonable convergence, contact your help desk.

Verification

Press **q** followed by **Enter** until the color bar test pattern reappears and observe the following:

- The color bars should be in the proper order and be bright and crisp.
- The low frequency area at the top should be free of interference and the transition of white to black or black to white should be sharp.

- The gray scale shows six clearly defined shades of gray between black and white.
- The burst pattern will show clear vertical fine lines at the lower right and the single pixel dots are clearly defined.

The monitor is now properly adjusted and ready for use. Press F3 to end.

Adjustment Procedure for the 6091 Display (on a RISC System/6000)

Procedures for Selecting Monitor Test Patterns

Step 1: With the display on and RISC System/6000 running, type DIAG from anywhere in the AIX shell and press Enter to display the system diagnostics screen, menu number 801001. The menu number appears in the upper right corner.

```
IBM RISC System/6000 POWERstation and POWERserver      801001
DIAGNOSTICS VERSION 1.0
LICENSED MATERIAL and LICENSED INTERNAL CODE - PROPERTY OF IBM.
(C) COPYRIGHTS BY IBM AND BY OTHERS 1982, 1990.
ALL RIGHTS RESERVED.
DIAGNOSTIC OPERATING INSTRUCTIONS

These programs contain diagnostic and service aids for the system.
These procedures should be used whenever problems with the system occur
which have not been corrected by any software application procedures
available.

In general, the procedures will run automatically. However, sometimes
you will be required to select options, inform the system when to
continue, do simple tasks, and exchange diskettes.

Several keys are used to control the procedures:
-- The Enter key continues the procedure or performs an action.
-- The Backspace key allows keying errors to be corrected.
-- The cursor keys are used to select an option.

Press the F3 key to exit or press Enter to continue.
```

Step 2: Press Enter to bring up the Function Selection menu, number 801002. Move the cursor down to select Service Aid as shown.

| | |
|--|----------|
| FUNCTION SELECTION | 801002 |
| Move cursor to selection, then press Enter. | |
| Diagnostic Routines This selection will test the machine hardware and detect any hardware problems. A problem will be indicated by a SRN (Service Request Number). The SRN will allow a service representative to quickly determine what parts are required to repair the machine. | |
| Service Aid This selection will look at the machine configuration, exercise external interfaces, format media, look at past diagnostic results, control what resources are tested, check out media, etc. | |
| Advanced Diagnostic Routines This selection will normally be used only by the service representative. | |
| F3=Cancel | F10=Exit |

Step 3: Press Enter to bring up menu number 802001.

| | |
|---|----------|
| SERVICE AIDS SELECTION | 802001 |
| Move cursor to selection and press Enter. | |
| (TOP) | |
| Service Hints This selection displays service hints and errata information about the maintenance package. | |
| Display Previous Diagnostic Results This selection displays the results of previous diagnostic runs. | |
| Display or Change Configuration or Vital Product Data (VPD) This selection displays or changes the configuration or VPD. | |
| Display or Change Diagnostic Test List This selection displays the resources tested by Diagnostics and allows the resources to be added or deleted from the Diagnostic Test List. | |
| Disk Media This selection provides the format disk and certify disk service aids. | |
| Diskette Media This selection provides a tool for checking out a diskette. | |
| Service Aids for Use With Ethernet (Ethernet is a trademark of Xerox Corp.) | |
| (MORE. . .13) | |
| F3=Cancel | F10=Exit |

Step 4: Press PgDn to display the second page of options. Move the cursor to select Display Test Patterns.

```
SERVICE AIDS SELECTION                                802001

Move cursor to selection and press enter.

(MORE. . .13)

This selection provides a tool for checking out a diskette.

Service Aids for Use with Ethernet
(Ethernet is a Trademark of Xerox Corp.) This selection provides
a tool for diagnosing Ethernet problems.

SCSI Bus
This selection provides a tool for diagnosing SCSI bus problems.

Display Test Patterns
This selection displays patterns required to adjust the IBM 5081 and
IBM 6091 displays.

Microcode Download
This selection provides a tool for downloading microcode from a
diskette to a fixed disk.

Product Topology
This selection updates the system Product Topology information.
It should be run whenever the system is installed, when a MES or FCSI
is installed and when a FRU is exchanged.

(BOTTOM)

F3=Cancel F10=Exit
```

Step 5: Press Enter to bring up menu 802081 and move the cursor to select the attached display.

```
DISPLAY SERVICE AID                                802081

Which of the following displays do you want to test?

Move cursor to selection, then press Enter.

The color display attached to the High Performance
3D Color Graphics Processor in location 00-07.

Return to the Service Aids Selection Menu.

F3=Cancel F10=Exit
```

Step 6: Press Enter to display menu number 802082. Move the cursor to select the 9 x 9 grid pattern and press Enter.

| | |
|---|--------|
| DISPLAY SERVICE AID | 802082 |
| Which of the following patterns do you want to display? | |
| Move cursor to selection, then press Enter. | |
| The red full screen pattern. | |
| The green full screen pattern. | |
| The blue full screen pattern. | |
| The black full screen pattern. | |
| The white full screen pattern. | |
| The 9x9 grid pattern. | |
| The 9x11 grid pattern. | |
| The colorbar pattern. | |
| Return to the Display Selection menu. | |
| Return to the Service Aids Selection menu. | |
| F3=Cancel F10=Exit | |

The 9 x 9 grid pattern will appear on the display. See Figure 10 on page 16.

Adjust Horizontal Centering (6091-016)

Adjust the horizontal centering control on the display until the grid is centered on the screen between the right and left edges of the screen. If you cannot get the grid centered on the screen, contact your help desk.

Adjust Vertical Centering

Adjust the vertical centering control on the display until the grid is centered between the top and bottom edges of the screen. If you cannot get the grid properly centered, contact your help desk.

Adjust Convergence

Look at the center of the grid. Turn the vertical static convergence control until the horizontal lines are white. Turn the horizontal static convergence control until the vertical lines are white.

If you cannot obtain reasonable convergence, contact your help desk.

Verification

Press Enter, select the color bar test pattern and check for the following:

- The color bars should be bright, crisp, and in the proper order.
- The low frequency area at the top should be free of interference and the transition of white to black or black to white should be sharp.
- The gray scale shows six clearly defined shades of gray between black and white.
- The burst pattern shows clear vertical fine lines at the lower right and the single pixel dots are clearly defined.

The monitor is now properly adjusted and ready for use. Press F3 to end test.

For Non-IBM Graphics Systems Adjustment of the Monitor

- For vertical centering, use an existing full screen graphics image, and center as directed on page 20.
- For convergence, a white "T" or a "+" character at the screen's center can substitute for the grid pattern. Converge as directed on page 20.

Preventing Signal Loss When Connecting Additional View-Only Displays

You can connect one 6091 display to a processor with a compatible video interface to create an interactive graphics display station. It is also possible to attach up to five view-only displays to this graphics display station.

However, when you connect additional displays to the 6091-023, you need to take precautions to avoid signal loss. Resetting the gain switch on the 6091-023 is one way to compensate for this signal loss.

Refer to the manuals listed in the Preface for details.

Setting the Gain Switch on the 6091-023 (Signal Attenuation)

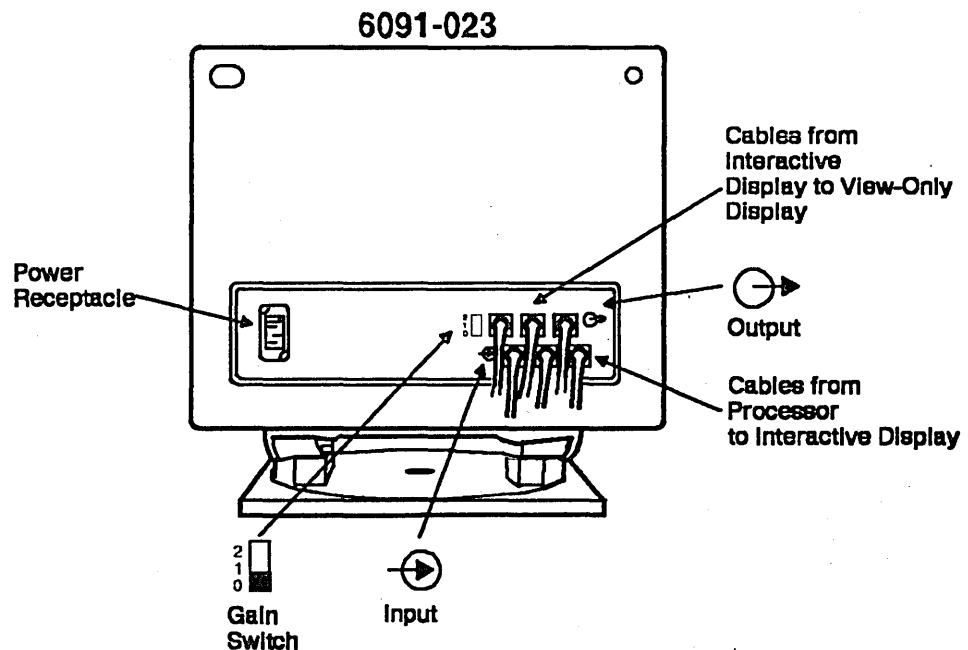

Figure 11. Gain switch on the 6091-023 display.

You need to set the gain switch **only** when using additional view-only displays on the video link. The following information will explain how to set the gain switch on your 6091-023 display.

Depending on the length of the video cables to the next display, noticeable signal loss could result. To compensate for this signal loss, set the gain switch at the display driving the video signal.

The gain switch, located at the back of the 6091-023 display (see Figure 11 on page 21 for the location of this switch) has three positions: 0, 1, and 2. This switch affects the OUTPUT signal level. The OUTPUT signal is the signal received by the next display on the video link.

As an approximate guide, use gain position 0 for video cable lengths up to 20 meters; position 1 for cable lengths between 20 and 60 meters; and position 2 for lengths between 60 and 100 meters.

CORRECT

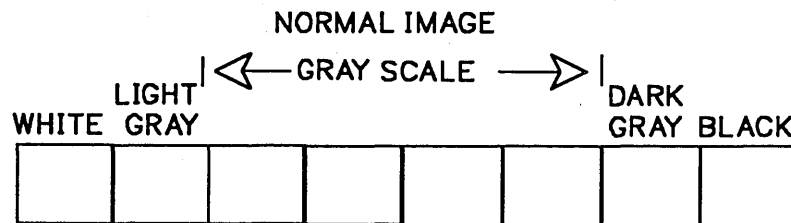

INCORRECT

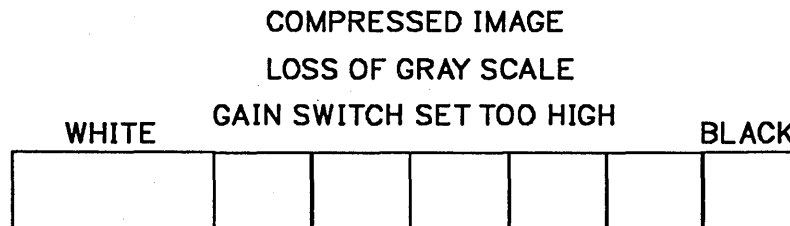

Figure 12. Correct and incorrect gray scales (color bar test pattern)

Observe the gray scale. The pattern should show white at the left with six shades of gray and black at the right. If the black (background) appears gray, reduce the setting of the brightness control. (Normally this control should be at the center detent.)

Setting the Input Impedance Switch on the 6091-19i and 6091-016

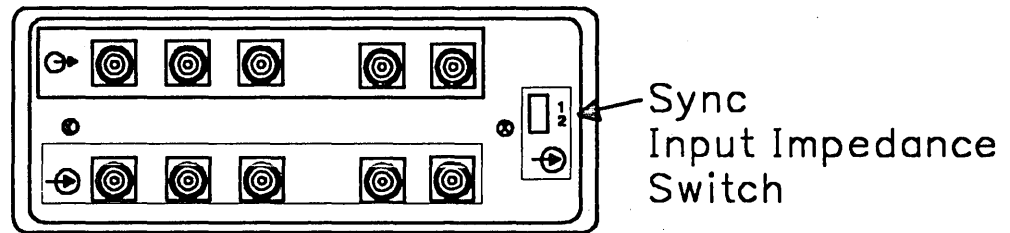

Figure 13. Input impedance switch on the 6091-19i and 6091-016 display

The input impedance switch located at the back of the 6091-19i and 6091-016 displays has two positions:

Position 1 (high impedance): 2,000 ohms

Position 2 (low impedance): 75 ohms.

For the 6091-016, move the switch to position 1 (high impedance) for normal operation.

For the 6091-19i, move the switch to position 2 (low impedance) for normal operation.

This switch affects the external sync inputs only.

Cleaning the Display

To clean the anti-glare surface of your CRT display, we recommend using a solution of water and isopropyl alcohol. **Do not use cleaners containing wax or silicones. These products reduce the antiglare qualities of the surface.** Apply the cleaning fluid to a cloth or tissue and then use the cloth or tissue on the screen.

CAUTION:

Do not spray cleaners directly on the CRT screen. Excess cleaner could run down the face plate and bezels and damage the CRT and its components.

Preventing Overheating of the Display

CAUTION:

Do not place anything on top of the display since this could cause the unit to overheat.

Four Ways to Make Working with Your Display More Comfortable

These four recommendations can make viewing your display more comfortable:

- Use characters with favorable color contrast.
- Sit 355 to 500 mm (16 to 24 inches) from the 6091, as this is the most comfortable viewing distance. For continuous viewing, never sit farther than 600 mm (26 inches).
- Tilt or swivel (or both) the CRT to minimize ambient glare and provide the best view of the entire screen.
- Look directly at the screen's center, where the anti-glare screen is most effective.

Chapter 4. Display and Video Specifications

Use the display and video specifications in this section if you need information on making the 6091 display compatible with your processor.

General Display Specifications

| Specifications | 6091-023 | 6091-19i | 6091-016 |
|----------------------------------|---|--|---|
| Pixel Resolution | 1024 x 1024 or 1280 x 1024 @ 60 Hz | 1024 x 1024 or 1280 x 1024 @ 60 Hz and 1280 x 1024 @ 77 Hz | 1280 x 1024 @ 60 Hz or 77 Hz or 1024 x 768 @ 75 Hz |
| Video Bandwidth | 100 MHz | 100 MHz | 100 MHz |
| Horizontal Frequency Rate | 63.36 KHz | Mode 1 = 63.36 KHz Mode 2 = 63.63 KHz Mode 3 = 81.32 KHz Mode 4 = 63.63 KHz | Mode 1 = 63.63 KHz Mode 2 = 81.33 KHz Mode 3 = 61.10 KHz |
| Vertical Frequency Rate | 60 Hz non-interlaced | Mode 1,2 = 60 Hz Mode 3 = 77 Hz Mode 4 = 120 Hz stereo all non-interlace | Mode 1 = 60 Hz Mode 2 = 77 Hz Mode 3 = 75 Hz all non-interlace |
| RGB Input, Timing | See Figure 14 on page 26 and Figure 15 on page 26 | See Figure 14 on page 26 and Figure 15 on page 26 | See Figure 14 on page 26 and Figure 15 on page 26 |
| RGB Input, Amplitude | See Figure 16 on page 27 | See Figure 16 on page 27 | See Figure 16 on page 27 |
| RGB Input, Connector | 3 – BNC Jack | 3 – BNC Jack | 3 – BNC Jack |
| Video Input Impedance (RGB) | 75 ohms | 75 ohms | 75 ohms |
| External Sync, Connector (H & V) | N/A | 2 – BNC Jack | 2 – BNC Jack |
| Sync Input Impedance | N/A | Switchable 75 ohms or 2,000 ohms | Switchable 75 ohms or 2,000 ohms |
| Sync Output Impedance | N/A | 75 ohms | 75 ohms |
| Power Consumption | 240 watts | 240 watts | 240 watts |

Video Specifications

Monitor Timings

Video specifications on RGB input timing and signal amplitude appear in Figure 14, Figure 15, and Figure 16 on page 27.

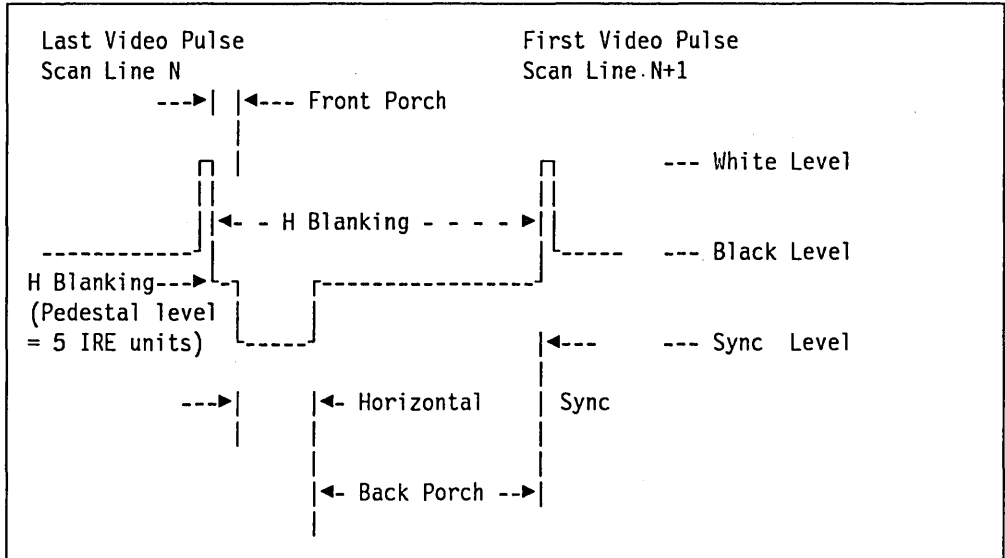

Figure 14. RGB input timing, horizontal sync interval (6091). Refer to Table 1 on page 28, Table 2 on page 29 or Table 3 on page 30 for exact timings.

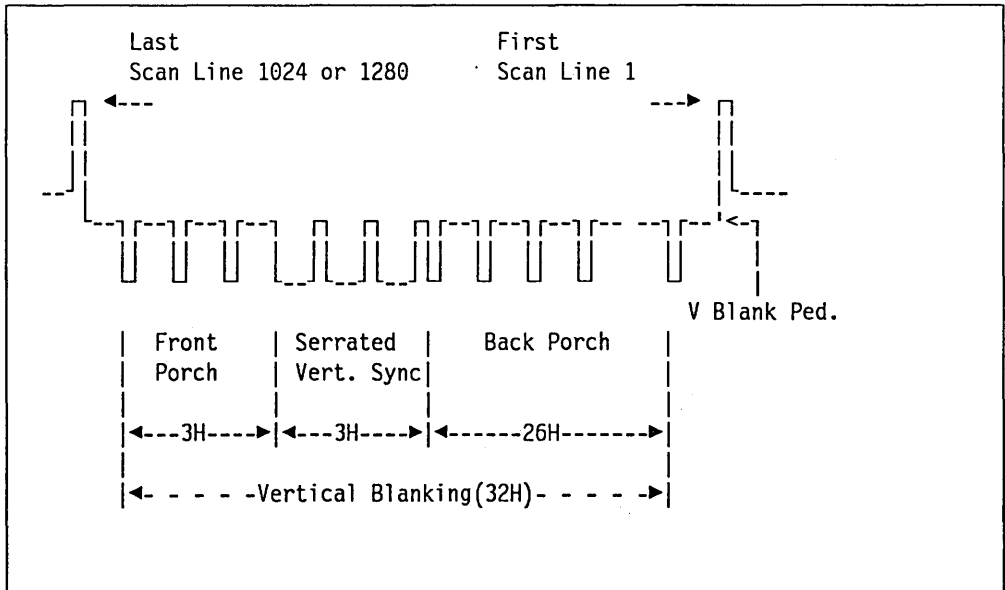

Figure 15. RGB input timing, vertical sync interval (6091). Refer to Table 1 on page 28 or Table 2 on page 29 for exact timings.

Composite Video Signal Levels

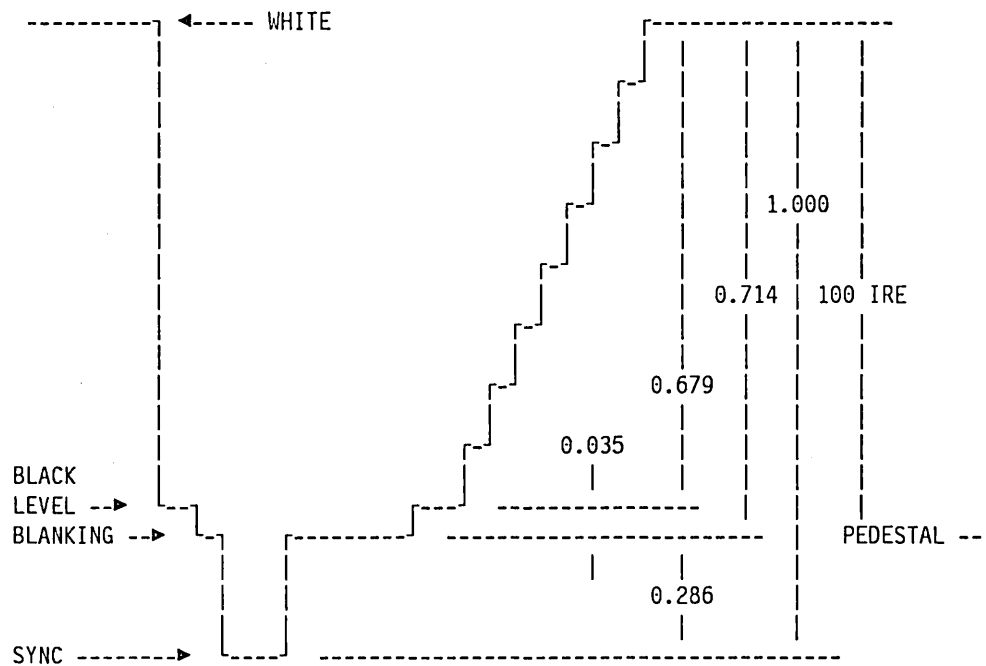

Figure 16. RGB input signal amplitude, horizontal interval (6091)

Composite Video Amplitude Summary

| Level | IRE Units | P-P Volts Nominal | Tolerance + | Tolerance - |
|--|-----------|----------------------|----------------|----------------|
| Sync to Blanking Ped- estal | 40 | 0.286 | 0.292 | 0.278 |
| Blanking Ped- estal Setup | 5 | 0.035 | 0.731 | 0.034 |
| Reference Blanking to White | 100 | 0.714 | 0.731 | 0.696 |
| Composite Video Ampli- tude | 140 | 1.000 | 1.023 | 0.974 |
| Note: Video overshoot/undershoot = 2 percent maximum (of 100 IRE) One IRE Unit = 7.14 millivolts or 1 percent of video (that is, blanking to white). DC bias of the video signal with respect to ground is equal to, or less than, 2.0 volts. | | | | |

Summary of Monitor Timing Parameters for 6091-023

| <i>Table 1. Timing Parameters 6091-23</i> | | |
|---|-------------------------|-------------------------|
| Mode | Mode 1 | Mode 2 |
| Sync Type | Composite Sync on Green | Composite Sync on Green |
| Format | 1024 x 1024 | 1280 x 1024 |
| Pixel Clock Frequency | 89.2108 MHz | 111.518 MHz |
| Pixel Time | 11.2094 ns | 8.9671 ns |
| H Line Rate | 15.7828 μ s | 15.7828 μ s |
| H Line Frequency | 63.360 KHz | 63.360 KHz |
| H Active Scan Time | 11.4780 μ s | 11.4780 μ s |
| H Sync Width | 1.7940 μ s | 1.7940 μ s |
| H Front Porch Width | 0.2350 μ s | 0.2350 μ s |
| H Back Porch Width | 2.2750 μ s | 2.2750 μ s |
| H Blanking Width | 4.3040 μ s | 4.3040 μ s |
| V Frame Rate (Frequency) | 60 Hz (N/I) | 60 Hz (N/I) |
| V Period | 16.666 ms | 16.666 ms |
| Serrated V Sync Width | (3H) 47.3 μ s | (3H) 47.3 μ s |
| V Front Porch Width | (3H) 47.3 μ s | (3H) 47.3 μ s |
| V Back Porch Width | (26H) 410.4 μ s | (26H) 410.4 μ s |
| V Blanking Width | (32H) 505 μ s | (32H) 505 μ s |
| Total Scan Lines | 1056 | 1056 |
| V Displayable Lines | 1024 | 1024 |

Summary of Monitor Timing Parameters for 6091-19i

| Mode | Mode 1 | Mode 2 | Mode 3 | Mode 4 |
|--------------------------|-------------------------|-------------------------|-------------------------|---------------------|
| Sync Type | Composite Sync on Green | Composite Sync on Green | Composite Sync on Green | Separate Syncs |
| Format | 1024 x 1024 | 1280 x 1024 | 1280 x 1024 | 1280 x 496 |
| Pixel Clock Frequency | 89.2108 MHz | 112 MHz | 148.0 MHz | 112 MHz |
| Pixel Time | 11.2094 ns | 8.9285 ns | 6.7567 ns | 8.9286 ns |
| H Line Rate | 15.7828 μ s | 15.71 μ s | 12.29 μ s | 15.7143 μ s |
| H Line Frequency | 63.360 KHz | 63.63 KHz | 81.32 KHz | 63.63 KHz |
| H Active Scan Time | 11.4780 μ s | 11.4284 μ s | 8.6485 μ s | 11.4286 μ s |
| H Sync Width | 1.7940 μ s | 1.786 μ s | 1.38 μ s | 1.786 μ s |
| H Front Porch Width | 0.2350 μ s | 0.232 μ s | 0.27 μ s | 0.232 μ s |
| H Back Porch Width | 2.2750 μ s | 2.268 μ s | 2.00 μ s | 2.268 μ s |
| H Blanking Width | 4.3040 μ s | 4.286 μ s | 3.65 μ s | 4.135 μ s |
| V Frame Rate (Frequency) | 60 Hz (N/I) | 60 Hz (N/I) | 77 Hz (N/I) | 120 (Stereo) |
| V Period | 16.666 ms | 16.666 μ s | 12.987 μ s | 8.297 ms |
| Serrated V Sync Width | (3H) 47.3 μ s | (3H) 47.14 μ s | (3H) 37.0 μ s | (3H) 47.14 μ s |
| V Front Porch Width | (3H) 47.3 μ s | (3H) 47.14 μ s | (3H) 37.0 μ s | (3H) 47.14 μ s |
| V Back Porch Width | (26H) 410.4 μ s | (26H) 408.57 μ s | (26H) 320 μ s | (26H) 408.6 μ s |
| V Blanking Width | (32H) 505 μ s | (32H) 502.86 μ s | (32H) 393.5 μ s | (32H) 502.9 μ s |
| Total Scan Lines | 1056 | 1056 | 1056 | 1088 |
| V Displayable Lines | 1024 | 1024 | 1024 | 1024 |

Note: If the incoming sync pulse is 60 Hz, the mode switch must be set to positions 1 or 2 to select the desired screen width.

If the incoming sync pulse is 77 or 120 Hz, the mode switch is inoperable (the display automatically selects the screen width).

Summary of Monitor Timing Parameters for 6091-016

| Mode | Mode 1 * | Mode 2 | Mode 3 |
|--|-------------------------|-------------------------|-------------------|
| Sync Type | Composite Sync on Green | Composite Sync on Green | Separate Sync |
| Format | 1280 x 1024 | 1280 x 1024 | 1024 x 768 |
| Pixel Clock Frequency | 112 MHz | 148 MHz | 86 MHz |
| Pixel Time | 8.9285 ns | 6.7567 ns | 11.6279 ns |
| H Line Rate | 15.71 μ s | 12.29 μ s | 16.37 μ s |
| H Line Frequency | 63.63 KHz | 81.32 KHz | 61.10 KHz |
| H Active Scan Time | 11.4284 μ s | 8.6485 μ s | 11.9069 μ s |
| H Sync Width | 1.786 μ s | 1.38 μ s | 3.72 μ s |
| H Front Porch Width | 0.232 μ s | 0.27 μ s | 0.09 μ s |
| H Back Porch Width | 2.268 μ s | 2.00 μ s | 0.65 μ s |
| H Blanking Width | 4.286 μ s | 3.65 μ s | 4.47 μ s |
| V Frame Rate (Frequency) | 60 Hz (N/I) | 77 Hz (N/I) | 75 Hz (N/I) |
| V Period | 16,666 μ s | 12,987 μ s | 13,333 μ s |
| Serrated V Sync Width | (3H) 47.14 μ s | (3H) 37.0 μ s | (8H) 131 μ s |
| V Front Porch Width | (3H) 47.14 μ s | (3H) 37.0 μ s | (0H) 0 |
| V Back Porch Width | (26H) 408.57 μ s | (26H) 320.0 μ s | (30) 491 μ s |
| V Blanking Width | (32H) 502.86 μ s | (32H) 393.5 μ s | (38H) 622 μ s |
| Total Scan Lines | 1056 | 1056 | 806 |
| V Displayable Lines | 1024 | 1024 | 768 |
| *: For ergonomic/usability reasons, Mode 1 (which has a vertical frame rate frequency of 60Hz) should only be used with light characters on a dark background (negative representation). | | | |

Note: Mode 3 is automatically selected by the incoming sync pulse. The Front panel mode switch is inoperative when in mode 3.

Readers' Comments

**Setup and Operation for the IBM
6091 Color Displays**

Publication No. GA23-2114-03

Use this form to tell us what you think about this manual. If you have found errors in it, or if you want to express your opinion about it (such as organization, subject matter, appearance) or make suggestions for improvement, this is the form to use. If you prefer, you may send comments electronically to your IBM branch office, **Attention: Dept. 34CA-634, Kingston, NY**. Or you may fax your comments to us directly at: **FAX (914) 385-6625**.

To request additional publications, or to ask questions or make comments about the functions of IBM products or systems, you should talk to your IBM representative or to your IBM authorized remarketer. This form is provided for comments about the information in this manual and the way it is presented.

When you send comments to IBM, you grant IBM a nonexclusive right to use or distribute your comments in any way it believes appropriate without incurring any obligation to you.

Be sure to print your name and address below if you would like a reply.

Name

Address

Company or Organization

Phone No.

Customer Satisfaction Survey

Setup and Operations for the 6091 Color Displays, GA23-2114-03

How satisfied are you that the information is:

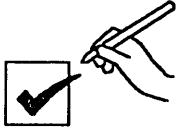
|  | Very Satisfied | Satisfied | Neutral | Dissatisfied | Very Dissatisfied |
|---|----------------|-----------|---------|--------------|-------------------|
| Accurate | | | | | |
| Complete | | | | | |
| Easy to find | | | | | |
| Easy to understand | | | | | |
| Well organized | | | | | |
| Applicable to your tasks | | | | | |
| THANK YOU! | | | | | |

Please tell us how we can improve this manual:

To return this survey:

- Mail it
- Fax it **FAX (914) 385-6625**
- Hand it to your IBM representative.

If you would like a reply:

Name: _____
 Title: _____
 Company or Organization: _____
 Address: _____
 City: _____ State: _____
 Type of Business: _____
 Phone: (_____) _____

When you send comments to IBM, you grant IBM a nonexclusive right to use or distribute your comments in any way it believes appropriate without incurring any obligation to you.



Part Number: 39F9074

Printed in U.S.A.

