

GTSC

INSTRUCTION MANUAL

MODEL 304

SERIAL I/O BOARD

GRANT TECHNOLOGY SYSTEMS CORPORATION



**GRANT TECHNOLOGY SYSTEMS
CORPORATION**

INSTRUCTION MANUAL

MODEL 304

SERIAL I/O BOARD

MODEL 304

SERIAL I/O BOARD

TABLE OF CONTENTS

<u>Description</u>	<u>Page</u>
Features	1
General	1
Specifications	2
Q-Bus Interface	3
Interrupt Logic	3
Console Channel	5
UART	5
Control & Status Registers	6
Data Registers	6
Error Registers	7
EIA Circuit	7
Baud Rate Generator	7
<u>Operation Modes</u>	8
Factory Configuration	10
Setting the Base Address	10
Setting the Vector Address	11
Setting the Interrupt Level	12
Enabling the Console	14
System Halt or Reboot	14
Setting the Baud Rate	14
Setting the Serial Data Format	15
Setting the Line Discipline	17
Reader Run Pulse	19
<u>Serial Interface</u>	20
Connector Description	20
Line Discipline, Cable Length & Data Rates	21
<u>Programming</u>	22
<u>Warranty</u>	

FEATURES

- * Direct Replacement for DLV11-J Serial I/O Board
- * Totally Compatible with DEC Software
- * All Standard DEC Features
- * Each Port Independently Configured for Either EIA RS-232, RS-422, or RS-423
- * Four Level Vector Interrupt Structure, Ideal for Multi-User Applications
- * Channel 3 can be Independently Configured as System Console

GENERAL

The Model 304 is a four channel serial I/O port for interfacing DEC's Q-bus to asynchronous serial data channels. The 304 is a direct replacement for the DEC four channel Serial I/O Board (Model DLV11-J). It is packaged on the standard 8.9" x 5.2" DEC style dual width board and is electrically and mechanically compatible with DEC's LSI-11, 11/2, and 11/23 Microcomputer Series.

Each channel consists of a UART which receives and converts serial start, data, parity and stop bits to parallel data verifying proper code transmission, parity and stop bits. The UART's transmitter converts the computer's parallel data into serial form and automatically adds start, parity, and stop bits.

Each channel's data length can be configured for 7 or 8 bits. Parity is jumper selectable, odd or even, and parity checking and generation can be inhibited. Stop bits are jumper selectable; one or two.

The 304 can be used in a wide range of interface applications including printers, terminals, peripherals and remote data acquisition systems. Each channel can operate at one of nine jumper selectable data rates, from 150 to 38.4K baud, which are generated by an on-board clock. The user may also provide an external clock.

The line characteristics of each channel can be jumper configured to operate in accordance with EIA standard RS-232,

RS-422, or RS-423. Twenty milliamp current loop operation is possible when used in conjunction with the DEC DLV11-KA.

A unique feature of the 304 is the capability to support the LSI 11/23 four level interrupt structure. Channel 3 may also be configured as the system console, independent of the other three channels. Special pins are provided on each I/O connector which can be used to constantly assert the data terminal ready lines of the peripheral, and each channel can also be configured to provide a pulse output to control a paper tape reader.

SPECIFICATIONS

Bus Interface	Q-bus, DEC LSI-11, 11/2 & 11/23 compatible
Data Characteristics	
(Each Channel)	
No. of Channels	4
Data Protocol	Asynchronous serial
Baud Rates	Jumper Selectable 150, 300, 600, 1.2K, 2.4K, 4.8K, 9.6K, 19.2K 38.4K, Ext.
Line Discipline	Jumper Selectable EIA RS-232C, RS-422, or RS-423
Data Bits	Jumper Selectable 7 or 8
Stop Bits	Jumper Selectable 1 or 2
Parity	Jumper Selectable Odd, Even, None
Addressing	
Base Address Range	Jumper Selectable 776000 ₈ to 777740 ₈
Console Address	Jumper Selectable 777560 ₈ Channel 3 Only
Interrupts	
Priority Level	Jumper Selectable LSI-11 & 11/2 Level 4, Jumper Selectable LSI-11/12 Level 4, 5, 6, or 7
Base Vector Range	Jumper Selectable 0 to 740 ₈
Console Vector	60 only when console option is enabled

Mechanical & Environmental

Dimensions	DEC LSI-11 standard 8.9" x 5.2" half quad board
Power Requirements	5V @ 1 Amp, 12V @ .2 Amps
Bus Loading	1.5 Std. AC/1 Std. DC Load
Operating Temperature Range	0 to 55°C
Storage Temperature Range	0 to 75°C
Relative Humidity	To 85% non-condensing
Mating Connector	Amp #87133-5, Pin #87165-2

Q-BUS INTERFACE

The Q-Bus Interface consists of address/data transceivers, an address comparator, console decode logic and I/O select and control logic.

During the addressing portion of a bus cycle, the Address/Data transceivers are in the receive mode. Address lines 12 through 5, gated by bus line BBS7, are compared to the base address setting selected by the address selection jumpers. When the correct address is asserted by the processor, the comparator output (BDSEL) is asserted. This in conjunction with the assertion of BSYNC is used by the Select and Control Logic (SCL) to select the appropriate on-board register for the remainder of the bus cycle.

If the processor is performing a read, then the BDIN line is decoded in conjunction with the SCL to enable the tri-state buffers of the selected register, place the bus transceivers in their transmit mode, and then assert the BRPLY line.

If the processor is performing a write operation, then the register which is to be written to is selected during the Address/Data portion of the bus cycle and the BDOUT line is used to clock the latches of the receiving register, and to assert BRPLY.

INTERRUPT LOGIC

The interrupt handling logic consists of interrupt request logic, a priority encoder, level circuit logic, arbitration control, and vector logic.

The interrupt request logic consists of eight latches; one for each transmit or receive CSR. In order to generate an interrupt, two requirements must be met. First, the interrupt

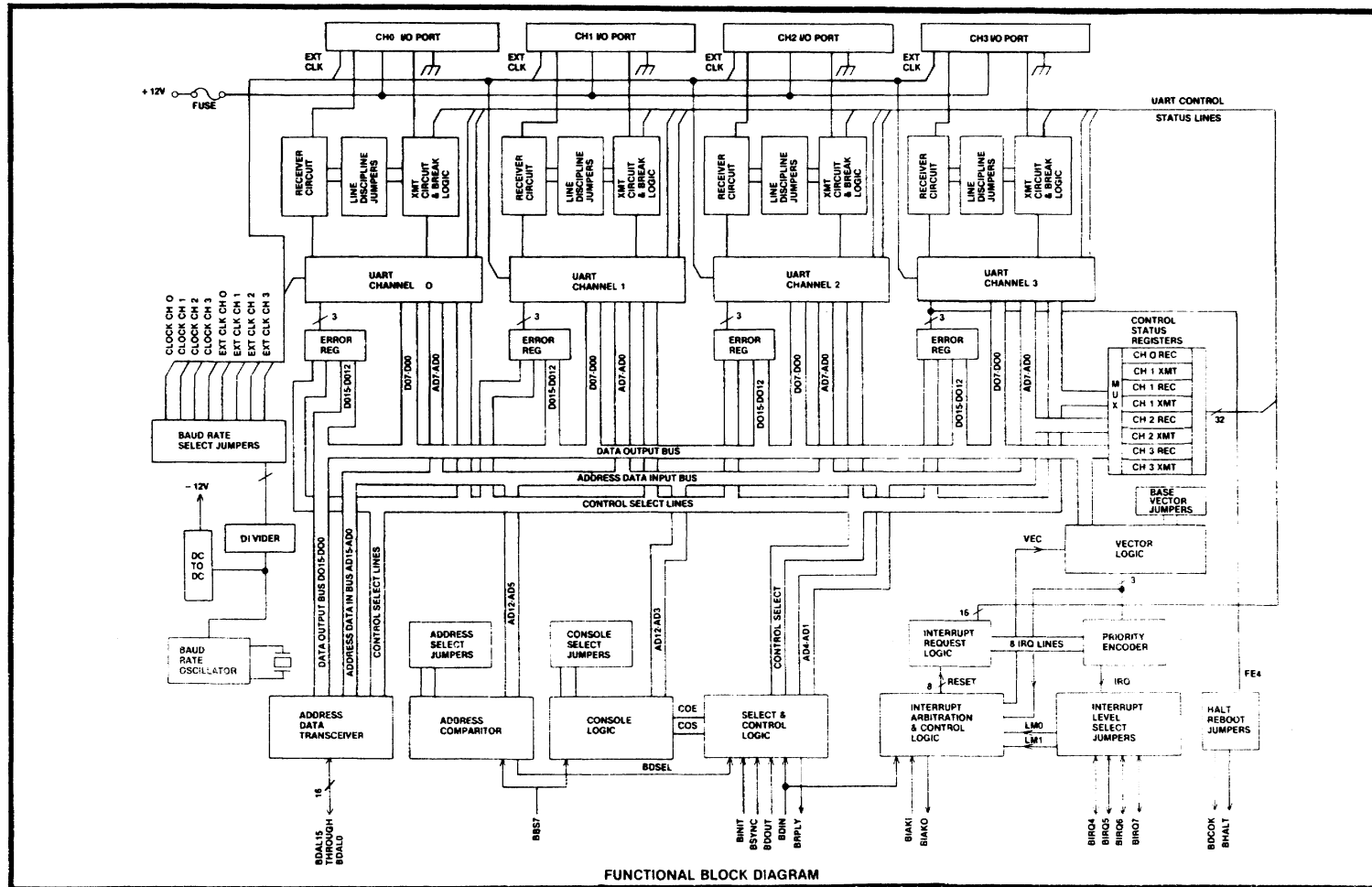

MODEL 304
Functional Block Diagram

enable bit (Bit 6) in either the transmit or receive CSR must be set, and second, the appropriate condition flag must be set (Bit 7). These two logically anded signals clock the flop. The outputs of all eight flops are fed into the priority encoder. When the output of any flop goes high, the priority encoder generates a master interrupt request (IRQ). This signal is fed into the level select logic which in turn asserts the appropriate BIRQ lines. At the same time the arbitration logic monitors the bus to determine if a device on a higher interrupt level is requesting. If not, then when the interrupt grant signal BIAKI is received, the appropriate vector as determined by the priority encoder is placed on the bus, and if more than one channel is requesting, the channel of highest priority is cleared leaving the lower priority requests pending. Table 1 gives the priority level of each channel.

<u>Channel</u>		<u>Level</u>		<u>Vector Offset</u>
Channel 0	Receive	0	Highest Priority	Base Vector +0
Channel 1	Receive	1		Base Vector +10
Channel 2	Receive	2		Base Vector +20
Channel 3	Receive	3		Base Vector +30
Channel 0	Transmit	4		Base Vector +4
Channel 1	Transmit	5		Base Vector +14
Channel 2	Transmit	6		Base Vector +24
Channel 3	Transmit	7	Lowest Priority	Base Vector +34

TABLE 1

CONSOLE CHANNEL

When the console enable jumper is installed, Channel 3 will respond to the address of 177560_8 , and the receiver will always have a vector address of 60_8 . The transmitter vector will be 64_8 . The console mode of operation is independent of the board's base address.

UART

Each channel consists of a Universal Asynchronous Receiver Transmitter (UART) which receives and converts serial data, parity and stop bits to parallel data verifying proper code transmission, parity and stop bits. If a transmission error is detected, the nature of the error is outputted to an error

register which is read when the receive data register is read. Upon receiving the last stop bit, the receiver full flag is set (Bit 7 of the receive CSR). If the receiver interrupt enable bit is set (Bit 6), then the receiver full flag will generate an interrupt request.

The UART's transmitter converts the computer's parallel data into a serial format and automatically adds start, parity, and stop bits. When the transmitter buffer is ready to receive a byte of data for transmission, the transmitter ready flag is set (Bit 7 of the transmitter CSR). If the transmitter interrupt enable bit is set (Bit 6), then the transmitter ready flag will generate an interrupt.

CONTROL STATUS REGISTER (CSR)

Each channel contains a 16 bit receiver CSR and a 16 bit transmitter CSR. Bit 7 is a read only bit used as a status flag and Bit 6 is a read/write bit used to enable an interrupt request when Bit 7 gets set.

Bit 7 of the receiver CSR is used to indicate that the receiver contains new data. Bit 7 is cleared by reading the receiver's data register or by a software reset. When Bit 6 is set, an interrupt request is generated when Bit 7 is set.

Bit 0 of the receiver CSR is used to transmit a reader run pulse. This bit is a write only bit and always reads zero.

Bit 7 of the transmitter CSR, when set, indicates the transmitter buffer is empty and ready to transmit new data. Setting Bit 6 will generate an interrupt whenever Bit 7 is set.

Bit 0, when set, will transmit a continuous break.

All unused CSR bits in both the transmitter and receiver CSR's will always read zero.

DATA REGISTERS

Each channel contains a Receiver Data Register (RDR) and a Transmitter Data Register (TDR). When data is received, it is placed in the RDR and Bit 7 of the Receiver CSR is set. The received data is obtained by reading this register and, thus, automatically clearing Bit 7.

Data to be transmitted is written to the TDR. This automatically clears Bit 7 of the Transmitter CSR. Here the data will remain until the transmitter is ready. The data is then placed into the transmitter setting Bit 7.

ERROR REGISTERS

Each channel contains a 4 bit error register which is comprised of Bits 15 through 12 of the RDR.

Bit 12 is the Parity Error (PE) Bit. A "1" indicates the receiver parity does not match the parity selected by the format jumpers. The PE bit remains set until parity matches on a succeeding character. When parity is inhibited, this bit always reads zero.

Bit 13 is the Framing Error (FE) Bit. A "1" indicates the first stop bit was invalid. The FE bit will stay set until the next valid character's stop bit is received.

Bit 14 is the Overrun Error (OE) Bit. A "1" indicates that the last character was not read from the RDR before a new character was received. The OE is reset at the next character's stop if Bit 7 of the Receive CSR cleared.

Bit 15 is the Error Flag (EF) and is the logical "oring" of the PE, FE, and OE bits. The setting of any error bit will set this bit.

EIA CIRCUIT

The EIA circuit for each channel consists of a differential line driver, line receiver, and a single ended line driver. Through the use of wire wrap jumpers, each channel can be configured to operate as RS-232C, RS-422, or RS-423.

Channels operating as RS-232C or RS-423 will configure the differential line receiver to operate single ended and utilize the single ended line driver. The slew rates of the line drivers are controlled by changing external resistors.

Channels which operate as RS-422 configure the differential line receiver for differential operation by adding a 100 ohm termination resistor, and utilize the differential line driver.

BAUD RATE GENERATOR

The baud rate generator consists of a crystal oscillator and divider. The oscillator base frequency is 4.1952 MHz which is divided to yield the nine baud rate clocks. Each channel can operate at any one baud rate independent of the other channels.

MODES OF OPERATION

Each channel of the 304 can operate in various line disciplines, data formats, and baud rates. The base address can be set so that the board can reside in any I/O page location. The vector can also be set to any address from 0_8 to 774_8 , and the interrupt level can be set to 4, 5, 6, or 7. All of these operation modes are configured by setting wire wrap jumpers. Table 2 is a summary of the jumper selectable modes which the board can be configured to.

TABLE 2

Jumper Selectable Modes of Operation

<u>Mode Description</u>	<u>Mode Selection</u>
* Line Discipline	RS-232C, RS-422, or RS-423
* Baud Rate	150, 300, 600, 1200, 2400, 4800, 9600, 19.2K, 38.4K, External
* Serial Data Format	Data Bits, 7 or 8 Stop Bits, 1 or 2 Parity, Odd, Even, None
Base Address	160000_8 to 177740_8
Vector Base Address	0 to 740_8
Console	Enable Channel 4 as System Console Address CH 4 = 177560_8 Vector CH4 = 60_8
Halt/Reboot on Break	Channel 3
Interrupt Level	4, 5, 6, or 7

* Channel to Channel Configurable

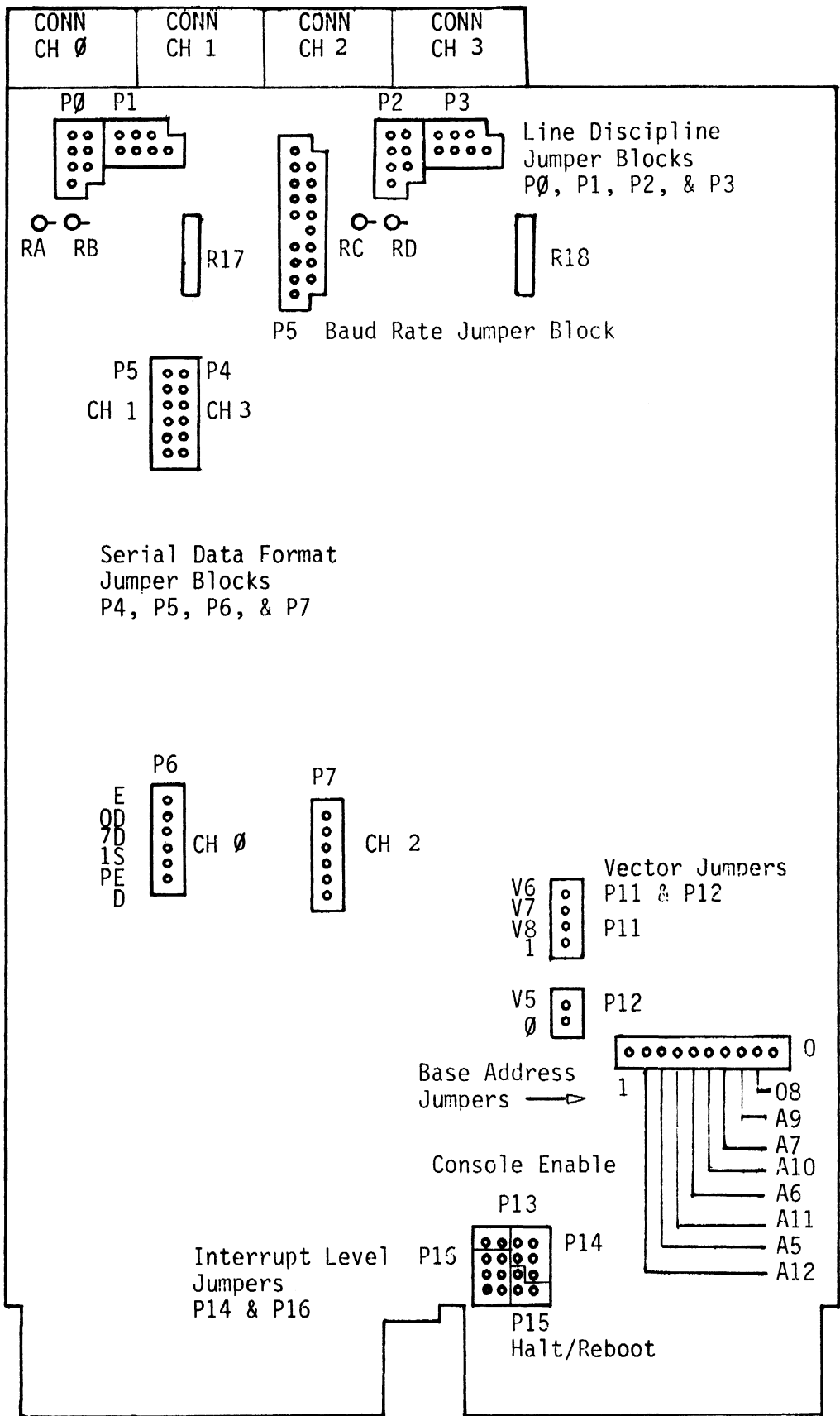

FIGURE 1
Model 304 Jumper Layout

FACTORY CONFIGURATION

The Model 304 is shipped configured as follows:

TABLE 3

Base Address	176500 ₈
Vector Base Address	300 ₈
CH3 Console Enabled	Yes
CH3 Halt on Break	Enabled
* Serial Data Format	1 Stop Bit, 8 Data Bits, No Parity
* Line Discipline	RS-232C
* Baud Rate	9600
Interrupt Level	4 (LSI 11)
* All Channels	

SETTING THE BASE ADDRESS

The 304's base address can be set to reside anywhere within the I/O page. The location of the base address jumpers is found on Figure 1. To change the board's base address requires reconfiguring the base address jumpers. Figure 2 indicates the base address jumper post arrangement. To change an address bit from 0 to 1 or vice versa requires wire wrapping that bit to the post labeled 0 or 1.

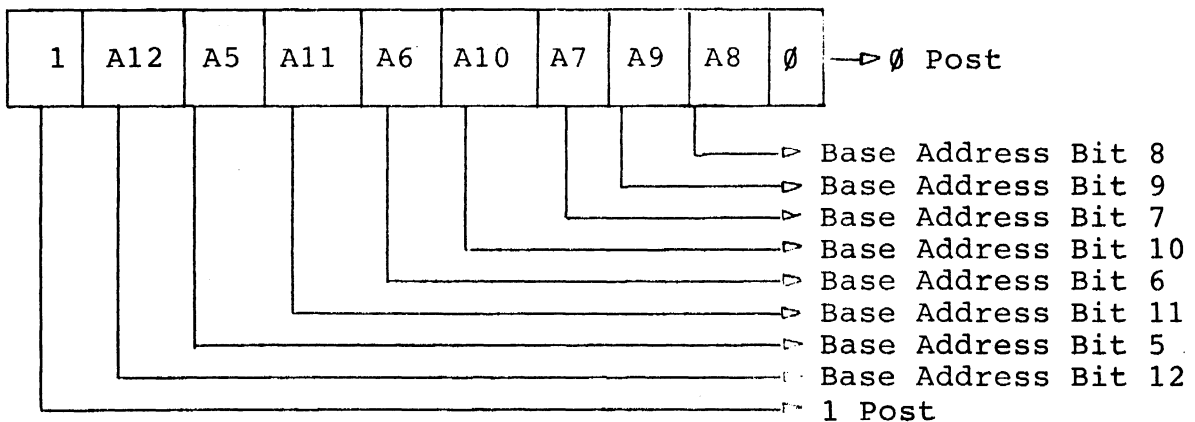

FIGURE 2

Base Address Jumpers

As an example, the factory configured base address is 176500₈. To set the base address requires wire wrapping A12, A11, A10, A8, and A6 to 1 and A9, A7, and A5 to 0. Refer to Table 4.

TABLE 4
Factory Configured Base Address

<u>Base Address</u>	<u>Bit Number</u>	<u>Jumper Post Description</u>	<u>Jumper Destination</u>
1	Bit 15	N/A	
	Bit 14	N/A	
7	Bit 13	N/A	
	Bit 12	A12	1
	Bit 11	A11	1
6	Bit 10	A10	1
	Bit 9	A9	0
	Bit 8	A8	1
5	Bit 7	A7	0
	Bit 6	A6	1
	Bit 5	A5	0
0	Bit 4	N/A	
	Bit 3	N/A	
	Bit 2	N/A	
0	Bit 1	N/A	
	Bit 0	N/A	

SETTING THE VECTOR ADDRESS

The 304's vector address can be set from 0 to 740₈. The location of the vector selection jumpers are found by referring to Figure 1. Wire wrapping jumper posts V6, V7 or V8 to Post 1 will cause these vector bits to read as 1. No connection will cause these bits to read 0.

Connecting jumper post V5 to 0 will cause vector Bit 5 to read 0. No connection of V5 will cause vector Bit 5 to read as 1.

As an example, the factory configured vector is 300₈. This requires leaving Post V8 open, connecting V6 and V7 to Post 1 and connecting V5 to Post 0.

Table 5 is a vector configuration guide. Vector Posts V6, V7, or V8 should never be connected to Post 0 and Vector

Post V5 should never be connected to Post 1. THIS WILL RESULT IN AN ERRONEOUS VECTOR.

TABLE 5

Vector Selection Jumpers

<u>Vector Base Address Octal</u>	<u>Vector Post P11</u>			<u>Vector Post P12</u>
	<u>V8</u>	<u>V7</u>	<u>V6</u>	<u>V5</u>
0	*	*	*	Ø
40	*	*	*	*
100	*	*	1	Ø
140	*	*	1	*
200	*	1	*	Ø
240	*	1	*	*
300	*	1	1	Ø
340	*	1	1	*
400	1	*	*	Ø
440	1	*	*	*
500	1	*	1	Ø
540	1	*	1	*
600	1	1	*	Ø
640	1	1	*	*
700	1	1	1	Ø
740	1	1	1	*

1 = Connect to Post 1 of P11
 Ø = Connect to Post Ø of P12
 * = Leave Post Open (No connection)

SETTING THE INTERRUPT LEVEL

The 304 can fully support the 11/23 multi-level interrupt structure. To do so requires that the 304 assert the appropriate interrupt request lines (BIRQ4, BIRQ5, BIRQ6 and BIRQ7) and monitor interrupt request lines of higher priority. Jumper post block P14 (Fig. 1) is used to select which interrupt request lines are to be asserted, and jumper post block P16 (Fig. 1) is used to select which interrupt request lines are monitored.

The 304 is factory configured to support systems which do not support a multi-level interrupt structure, which means that its priority level is strictly a function of its electrical locations relative to the processor. To change the configurations, refer to Table 6 and Figure 3 for proper jumper installation.

TABLE 6

Interrupt Level Configuration Jumpers

<u>Interrupt Level</u>	<u>Level Request Jumpers P14</u>			<u>Level Monitor Jumpers P16</u>	
	<u>R5</u>	<u>R6</u>	<u>R7</u>	<u>LM1</u>	<u>LM0</u>
11/2 *	G	G	G	P	P
4	G	G	G	Q5	Q6
5	IR	G	G	P	Q6
6	G	IR	G	P	Q7
7	G	IR	IR	P	P

* This configuration is set at the factory and must be used in systems which do not support the multi-level interrupt.

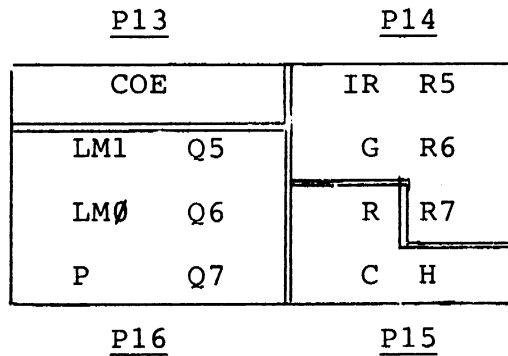

FIGURE 3

Interrupt Level, Console & Halt Reboot Jumpers

ENABLING THE CONSOLE

Channel 3 can be enabled as the system console independent of the base and vector address settings. To enable this option requires installing jumper P13. To disable this option requires removing jumper P13. Refer to Figure 1.

When the console is enabled, Channel 3 will respond to addresses 177560₈ to 177566 and will output a vector of 60 and 64 for the receiver and transmitter interrupts, respectively. Caution should be employed when the console is enabled so as not to set the base address equal to 177540 or a conflict will exist between Channel 2 and Channel 3.

By disabling the console, (remove jumper P13) and setting the board's base address equal to 177540 and setting the vector equal to 40₈, Channel 2 will act and respond as the system console.

SYSTEM HALT OR REBOOT

Any device communicating through Channel 3 can generate a system Halt or power up initialization by outputting a "BREAK".

To generate a system Halt on BREAK requires installing a jumper at P15 (Figure 3) from C to H. To generate a power fail reset, connect C to R. Refer to Figure 1 for jumper block P15's location.

SETTING THE BAUD RATE

Each channel of the 304 can communicate at one of nine jumper selectable baud rates or at an externally provided clock rate. Table 7 lists the baud rates and the jumper post identification letter. Figure 4 details the baud rate jumper block, the location of which can be found by referring to Figure 1.

Setting a channel to operate at a particular baud rate requires jumpering the appropriate pin whose letter represent the desired baud rate to the pin labeled for that channel (Refer to Figure 4).

As an example, the 304 is shipped from the factory with all 4 channels set to operate at 9600 baud. The baud rate jumper post C is connected to jumper posts CH0, CH1, CH2, and CH3.

TABLE 7

Baud Rate Jumper Identification

<u>Baud Rate</u>	<u>Letter</u>
150	I
300	H
600	G
1200	F
2400	E
4800	D
9600	C
19.2K	B
38.4K	A

38.4K	A	
19.2K	B	CH0 Channel 0
9600	C	CK0 Ext. Clock Channel 0
4800	D	CH1 Channel 1
2400	E	CK1 Ext. Clock Channel 1
		CH2 Channel 2
1200	F	CK2 Ext. Clock Channel 2
600	G	CH3 Channel 3
300	H	CK3 Ext. Clock Channel 3
150 Baud	I	

FIGURE 4

Baud Rate Jumper Block Detail P5

SETTING THE SERIAL DATA FORMAT

Each channel of the 304 can be configured to operate in the following data formats:

- 7 or 8 Data Bits
- 1 or 2 Stop Bits
- Odd, Even, or with No Parity

Jumper posts P6, P5, P7, and P4 (Figure 1) are used to set the data formats of Channels 0 through 3 respectively. The jumper configuration of the various options are illustrated in Table 8. As an example, the 304 is configured for 8 data bits, 1 stop bit, and no parity. This requires jumpering PE and 7D to E and jumpering 1S to E. When parity is not enabled, the odd/even parity post has no effect but must be jumpered to either E or D. Figure 5 illustrates the format jumper arrangement.

TABLE 8

Format Jumper Configuration Guide

<u>Format Option</u>	<u>Jumper Configuration</u>
8 Data Bits	7D to D
7 Data Bits	7D to E
2 Stop Bits	1S to D
1 Stop Bit	1S to E
No Parity	PE to D
Parity	PD to E
Even Parity	OD to D
Odd Parity	OD to E

E	Enable
OD	Odd Parity/Even Parity
7D	7 Data Bits/8 Data Bits
1S	1 Stop Bit/2 Stop Bits
PE	Parity/No Parity
D	Disable

FIGURE 5

Serial Data Format Jumper Block Detail

(P4, P5, P6, & P7)

SETTING THE LINE DISCIPLINE

Each channel of the 304 can operate in any one of the following EIA line disciplines:

RS-232C
RS-422
RS-423

The jumper blocks used to configure Channels 0 through 3 are P0, P1, P2, and P3 (Figure 1), respectively. Table 9 illustrates the jumper configuration to set up each channel. As an example, the 304 is shipped from the factory with each channel set up to operate in RS-232C. This requires jumpering S+ to I+ and S- to I-. Figure 6 illustrates the layout of the line discipline jumper blocks.

TABLE 9

Line Discipline Jumper Configuration

<u>Line Discipline</u>	<u>Jumper Configuration</u>
RS-232C	I+ to S+, I- to S-
* RS-422	I+ to D+, I- to D-
RS-423	I+ to S+, I- to S-

* Add 100 ohm termination resistor, (RA, RB, RC, RD)

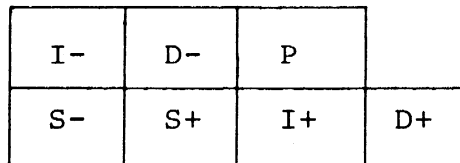

FIGURE 6

Line Discipline Jumper Block Layout

(P0, P1, P2, & P3)

When a channel is set up to operate in RS-422, a 100 ohm termination resistor must be installed at the input of the differential receiver. Table 10 lists the channel number and resistor name.

TABLE 10

RS-422 Resistor Installation Guide

Channel 0	Install a 100 ohm resistor at RA
Channel 1	Install a 100 ohm resistor at RB
Channel 2	Install a 100 ohm resistor at RC
Channel 3	Install a 100 ohm resistor at RD

During data communication over long data leads it may be necessary to change the rise and fall times of the single ended line drivers used in RS-423 to reduce line reflections and the potential of data errors. R17 controls the transition time for Channels 0 and 1 and R18 controls Channels 2 and 3. The resistor installed at the factory is a 22K which sets the transition time at 2.2 μ s. Table 11 is a list of recommended resistor values as a function of baud rate which should be installed if line reflections become a problem.

TABLE 11

RS-423 Slew Rate Resistor Values

<u>Baud Rate</u>	<u>Resistor Value in Ohms</u>	<u>Nominal Transition Times</u>
150	1 Megohm	100 μ sec
300	1 Megohm	100 μ sec
600	1 Megohm	100 μ sec
1200	820K Ohm	82 μ sec
2400	430K Ohm	43 μ sec
4800	200K Ohm	20 μ sec
9600	100K Ohm	10 μ sec
19.2K	51K Ohm	5.1 μ sec
38.4K	22K Ohm	2.2 μ sec

READER RUN PULSE

The reader run pulse is used to control a paper tape reader. To use this control requires connecting P to I- at the appropriate line discipline jumper block (Figure 1). Figure 6 illustrates the location of this jumper with the line discipline jumper block.

SERIAL INTERFACE

Figure 1 illustrates the connector location for each channel.

CONNECTOR DESCRIPTION

Each channel is interfaced through a 10 pin header. Figure 7 illustrates the pin-out location. The mating connector is manufactured by AMP, Inc. Table 12 lists the parts which are required to assemble the mating connector. The connector may be obtained through AMP, AMP distributors, or GTSC.

TABLE 12

Model 304 Connector Assembly Parts List

<u>AMP P/N</u>	<u>Description</u>	<u>Quantity/Connector</u>
87133-5	Connector Shell	1
87179-1	Key Pin	1
87165-2	Pins	9

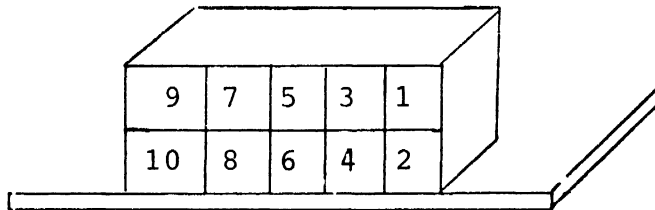

FIGURE 7

Model 304 Header Pin-out

The pin-out description of each header is as follows:

<u>Pin No.</u>	<u>Description</u>
1	Clock I/O
2	Signal Ground
3	Transmit Data +
4	Transmit Data -
5	Signal Ground
6	Key (No Pin)
7	Receive Data -
8	Receive Data +
9	Signal Ground
10	+12 Volts (Fused)

When a channel is configured for RS-232C or RS-423, Pin 7 must be externally tied to signal ground. This is typically done by connecting Pin 7 to Pin 9. Pin 1 is the external clock input.

LINE DISCIPLINE, CABLE LENGTH & DATA RATES

The two basic methods for electronic communications are single ended transmission and differential transmission. RS-232 was developed for single ended transmission over short distances at slow data rates. RS-423 extends the maximum data rate and cable length beyond that of RS-232. It also provides for wave shaping dependent on data rate and wire length to control reflections.

For communications over long distances, differential transmissions (RS-422) should be used to nullify effects of ground shifts and noise signals which appear as common mode. Table 13 lists the maximum recommended cable length and data rates for each line discipline.

TABLE 13

Key Aspects of RS-232,

RS-423 & RS-422

<u>Specification</u>	<u>RS-232C</u>	<u>RS-423</u>	<u>RS-422</u>
Mode of Operation	Single-ended	Single-ended	Differential
No. of Drivers & Receivers allowed on one line	1 Driver 1 Receiver	1 Driver 10 Receivers	1 Driver 10 Receivers
Maximum Cable Length	50 feet	4000 feet	4000 feet
Maximum Data Rate	20 kb/s	100 kb/s	10 mb/s

PROGRAMMING

Figure 8 illustrates the functions of the four 16 bit registers which comprise each channel. Thus, the Model 304 occupies 16 contiguous blocks in the I/O page *. The registers which make up each channel are:

Receiver Control Status Register (RCSR)
Receiver Data Register (RDR)
Transmitter Control Status Register (TCSR)
Transmitter Data Register (TDR)

Table 14 illustrates the relationship between each channel's registers and the base address. When the console is enabled, any attempt to address Channel 3 through an address other than the console address will cause a bus time out error.

Testing Bit 7 of the RCSR is used to indicate that the UART has received new data. Reading the RDR will clear Bit 7. Setting Bit 6 of the RCSR will enable the receiver interrupts. When Bit 7 is set, an interrupt will be generated.

Bit 0 of the RCSR is used to generate the reader run pulse by setting this write only bit. This action will also clear Bit 7 of the RCSR.

Bits 0 through 7 of the RDR contain the data received by the UART. Bits 12 through 15 indicate any errors which have occurred during the reception of data.

Bit 7 of the TCSR indicates the status of the transmitter. When this bit is set, the transmitter is ready to receive a new byte of data for transmission. When this bit is cleared (Bit 7 = 0), the transmitter is busy and no attempt to write the data to the TDR should be made. Setting Bit 6 of the TCSR will allow interrupts to be generated when Bit 7 is set.

Bit 0 of the TCSR is a read/write bit used to transmit a continuous break. A "1" written to Bit 0 will transmit a break (continuous 0), a zero clears the break transmission.

* This only holds true if Channel 3 is not configured as the console.

Data which is to be transmitted is written to the TDR, but only if Bit 7 of the TCSR is set.

Table 15 lists the relationship between the vector jumper settings and each channel. Note, Channel 3's vector is that of the console when the console is enabled.

Table 16 illustrates the register and vector address when Channel 3 is configured as the system console.

TABLE 14

Register Address Offset

<u>Register Description</u>	<u>Base Address Offset (Octal)</u>
Channel 0 Receiver CSR	Base Address +0
Channel 0 Receiver Data Register	Base Address +2
Channel 0 Transmitter CSR	Base Address +4
Channel 0 Transmitter Data Register	Base Address +6
Channel 1 Receiver CSR	Base Address +10
Channel 1 Receiver Data Register	Base Address +12
Channel 1 Transmitter CSR	Base Address +14
Channel 1 Transmitter Data Register	Base Address +16
Channel 2 Receiver CSR	Base Address +20
Channel 2 Receiver Data Register	Base Address +22
Channel 2 Transmitter CSR	Base Address +24
Channel 2 Transmitter Data Register	Base Address +26
Channel 3 Receiver CSR	Base Address +30
Channel 3 Receiver Data Register	Base Address +32
Channel 3 Transmitter CSR	Base Address +34
Channel 3 Transmitter Data Register	Base Address +36

TABLE 15

Vector Address Offset

<u>Interrupt Request Description</u>	<u>Vector Base Address Offset</u>
Channel 0 Receive	0
Channel 0 Transmit	4
Channel 1 Receive	10
Channel 1 Transmit	14
Channel 2 Receive	20
Channel 2 Transmit	24
Channel 3 Receive	30
Channel 3 Transmit	34

TABLE 16

Console Register & Vector Addresses

When Console Option is Enabled

<u>Channel 3 Register Description</u>	<u>Register Address</u>
Receiver CSR	177560 ₈
Receiver Data Register	177562 ₈
Transmitter CSR	177564 ₈
Transmitter Data Register	177566 ₈
Receiver Interrupt Vector Address	60 ₈
Transmitter Interrupt Vector Address	64 ₈

FIGURE 8
RECEIVER CSR

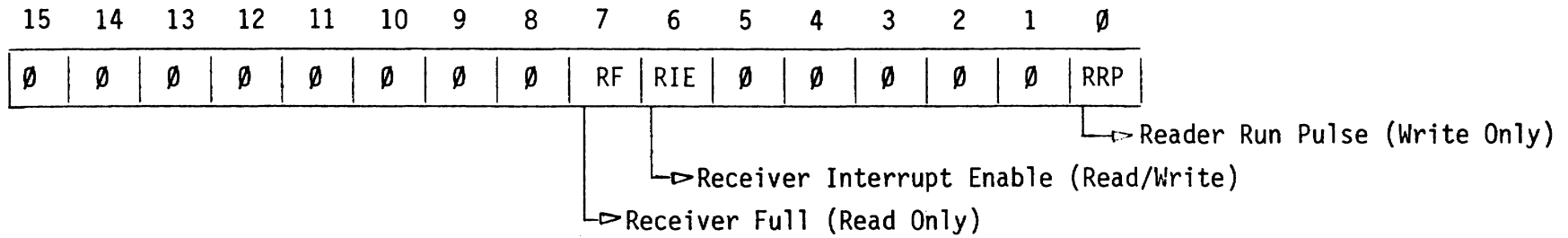

RECEIVER DATA REGISTER

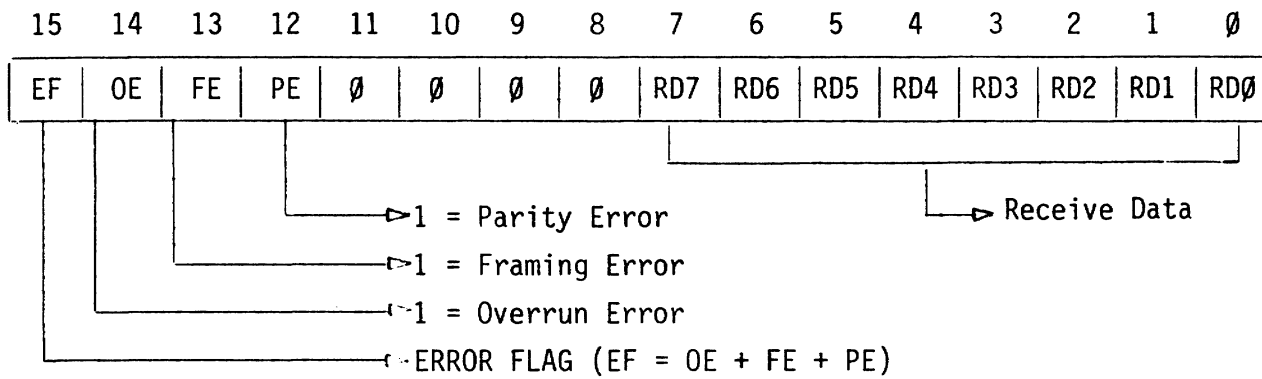

TRANSMITTER CSR

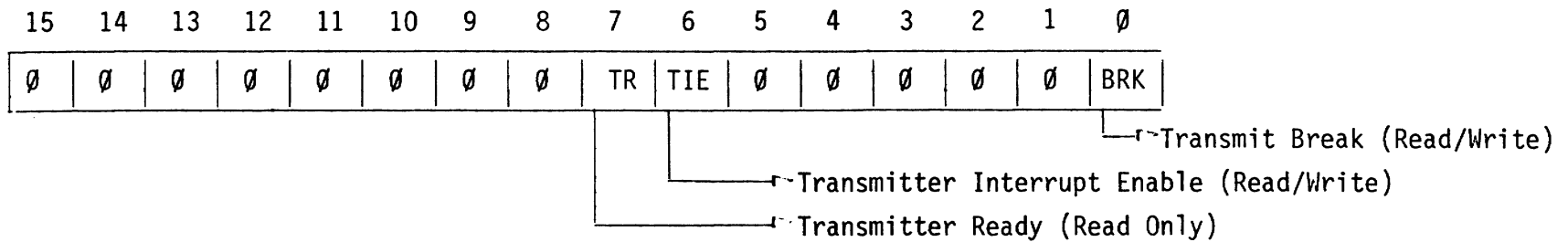

TRANSMIT DATA REGISTER

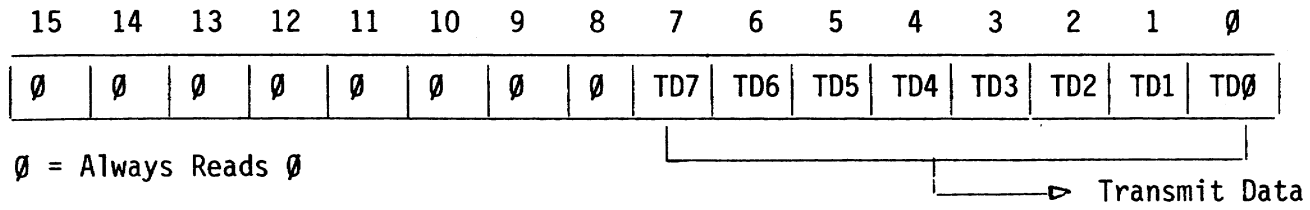

FIGURE 8 (Cont.)

Model 304 Serial I/O Port Register Formats

WARRANTY

Grant Technology Systems Corporation warrants that its products, except software, will be free from defects in workmanship or material under normal use and service. GTSC under this warranty will, at its option, replace or repair without charge at its plant any products manufactured by GTSC.

Freight, insurance, and other charges incurred in returning the product to GTSC will be paid by the customer.

The terms of this warranty are 90 days from the original date of shipment. The warranty provisions do not extend to products which have been repaired or altered without prior written GTSC approval, or to products which became defective due to accident or to the customer's improper installation, application or maintenance.

This warranty is in lieu of any other warranty, that is expressed or implied, including warranties of merchantability and fitness for use. GTSC reserves the right to make any changes in the design or construction of its products at any time without incurring any obligation to make any changes to products previously delivered.

GTSC neither assumes nor authorizes any other person to assume for it any other liability in connection with the sales, installation or use of its products.

GTSC shall have no liability for incidental or consequential damages of any kind arising out of the sale, installation, or use of its products.

To exercise this warranty, call GTSC, Customer Service Department for a return authorization in the event that a product is to be returned for "In Warranty Repair".