

Technical Manual for

MODEL 7102

Communications Terminal

by

Friden



Technical Manual for

MODEL 7102

Communications Terminal

by

Friden

TABLE OF CONTENTS

SECTION I. INTRODUCTION

| | |
|------------------------------------|---|
| Components | 1 |
| Reader | 2 |
| Single-Character Storage | 2 |
| Code Translator | 2 |
| Keyboard | 2 |
| Printer | 2 |
| Code Selector | 2 |
| Two-Character Buffer | 2 |
| Punch | 3 |
| Serializer/Deserializer | 3 |
| Interface | 3 |
| Operating Speeds | 3 |
| Control | 4 |
| Reader | 4 |
| Keyboard | 4 |
| Remote Device | 4 |

SECTION II. SPECIFICATIONS

| | |
|--|----|
| Carriage | 5 |
| Carriage Release Buttons | 5 |
| Margin Stop | 6 |
| Paper Release Lever | 6 |
| Multiple Copy Control Lever | 6 |
| Platen | 6 |
| Platen Ratchet | 6 |
| Line Space Lever | 6 |
| Tab Rack | 6 |
| Paper Tear Off Blade | 6 |
| Keyboard | 6 |
| Printing and Format Control Keys | 6 |
| Manual Control Keys | 7 |
| Console Panel Switches | 7 |
| Type Style | 8 |
| Ribbon | 8 |
| Tape Used | 8 |
| Code System | 8 |
| Accuracy Checking | 8 |
| Two-Character Buffer | 8 |
| Parity Check | 8 |
| Keylever Interlock | 8 |
| Tape Supply and Control | 8 |
| Tape Guide | 9 |
| Tape Tension Arm | 9 |
| Tape Hold Down Arm | 9 |
| Machine Desk | 10 |

SECTION III. OPERATING FEATURES

| | |
|-------------------------------|----|
| POWER Switch | 11 |
| Color Mode Switch | 11 |
| Manual Control Keys | 11 |

| | |
|----------------------------|----|
| TAPE FEED Key | 11 |
| START READ Key | 12 |
| STOP READ Key | 12 |
| BREAK Key | 12 |
| CONTROL Key | 12 |
| Panel Switches | 12 |
| PRINT OFF Switch | 12 |
| ALL Switch | 12 |
| PUNCH ON Switch | 12 |

SECTION IV. CUSTOMIZING FEATURES

| | |
|--|----|
| Edge-Punched Card Reader & Punch | 13 |
| Mechanical Non-Print Feature | 14 |
| Character Parity Check Feature | 14 |
| Automatic Device Control Feature | 14 |
| Accessories | 15 |
| Roll Paper Holder & Mounting Stand | 15 |
| Flexofeed | 15 |
| Pin Feed Platens | 16 |

SECTION V. COMMUNICATIONS

CONCEPTS AND CONSIDERATIONS

| | |
|---|----|
| Types of Service | 17 |
| Types of Circuits, and Interrupt Provisions | 17 |
| Transmit Mode | 17 |
| Receive Mode | 17 |
| Grades of Circuits | 17 |
| Transmission Mode and Speed | 17 |
| Modems | 17 |
| Communications Interface | 18 |
| Timing | 18 |
| Carriage Return | 18 |
| Case Shift | 18 |
| Horizontal Tabulation | 18 |
| Backspace | 18 |

SECTION VI. ON-LINE AND OFF-LINE OPERATING PROCEDURES

| | |
|--|----|
| Off-Line Operation | 19 |
| Systems Consideration | 19 |
| Programming | 20 |
| On-Line Operation | 20 |
| Procedures for Communicating with the Computer | 21 |
| Establishing Contact | 21 |
| Logging In | 21 |
| Executing the Program | 21 |
| Sign Off | 21 |
| Sample Procedures | 21 |

SECTION I

INTRODUCTION

The Model 7102 Communications Terminal is a keyboard/printer type of terminal. It has been designed as a general purpose communications terminal, employing an integral paper tape or edge card punch and reader.

As such, the Model 7102 is capable of serving as a remote input/output device for a computer in addition to its normal functions of document origination and preparation. The Model 7102 is capable of utilizing either leased private services or the public switched telephone network, to connect the terminal user directly with a remote computer, or another terminal. Extensive use is made of integrated circuits for logical functions. All electronic circuits are contained on modular plug-in printed circuit boards.

The Model 7102 is exceptionally easy to operate. This unit is based on sound human factors principles, developed through long experience by FRIDEN in business machines design. Two modes of operation are possible with the Model 7102. It can operate on-line, (that is connected to a remote computer or another Model 7102 via common carrier facilities) or off-line (as an automatic writing machine.)

In an on-line mode of operation, the Model 7102 can perform as a:

- Keyboard/printer
- Automatic paper tape transmission system
- Printer only

In an off-line mode of operation the Model 7102 is capable of:

- Document origination/reproduction
- Data origination/reproduction for batch processing

Applications for the Model 7102 include:

- Computer time-sharing
- Information retrieval
- On-line programming and debugging
- On-line and off-line document and data preparation
- Text editing
- Computer-aided instruction

COMPONENTS

The Model 7102 is made up of seven basic components (see Figure 1): the reader, code translator, printer, keyboard, code selector, punch and electronic units. The electronic units involved in data flow are: the two-character buffer, the single-character storage, and the serializer/deserializer (shift register) and the interface. These components function as follows:

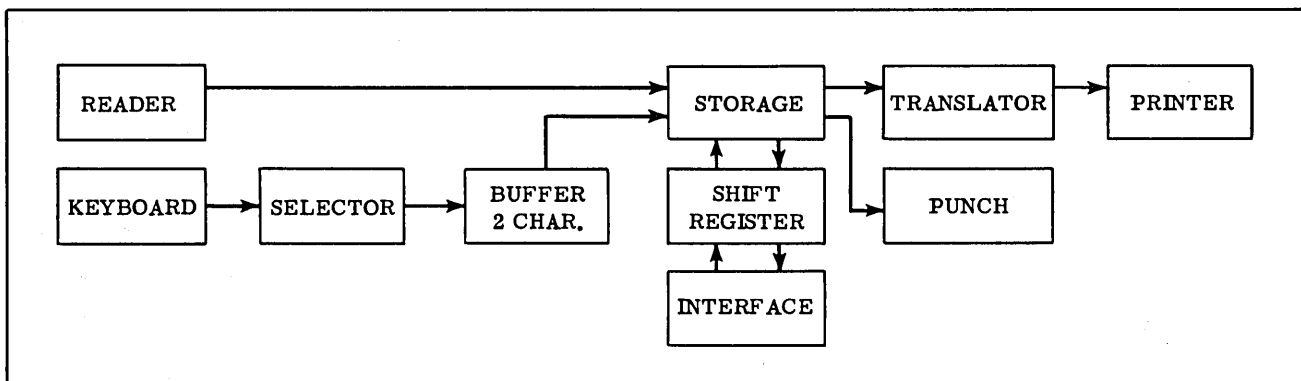

Figure 1. Flow Chart of Model 7102 Communications Terminal.

Reader

The reader mechanically senses codes punched in tape or edge-punched cards, and converts each code into a series of electrical impulses which are sent to the single-character storage.

Single-Character Storage

The single-character storage performs a central receiving and distributing function. It accepts codes directly from the reader and serializer/deserializer, and indirectly from the keyboard (through the selector and two-character buffer). It also distributes codes directly to the punch and serializer/deserializer and indirectly to the printer (through the code translator).

Code Translator

The code translator converts the electrical impulses from the single-character storage into a mechanical action to cause printing and other writing machine functions.

Keyboard

The keyboard is used to provide manual input for, and manual control of the Model 7102. It is a standard electric typewriter keyboard with secretary shift and capable of generating all 128 USASCII codes. The keyboard is mechanically linked to the printer.

Printer

The printer of the Model 7102 is essentially the same heavy-duty unit used in FLEXOWRITER* automatic writing machines. It features a 135 character writing line and automatic ribbon color shift.

Code Selector

When a keylever is manually activated, the code selector converts this action into a series of electrical impulses which are sent to the two-character buffer.

Two-Character Buffer

The two-character buffer is capable of storing up to two characters received from the

code selector. It prevents an operator from "over keyboarding" any two successive characters when typing familiar words or syllables such as "ing" or "the". The two character buffer prevents these impulses from being "scrambled" as they are sent to the single-character storage.

Figure 2 shows how successive characters are sequenced from the selector through the buffer positions, and into the single-character storage. Although three characters are shown in the illustration, if only one character were entered, it would be moved by timing circuitry through the buffer and into storage in the same manner.

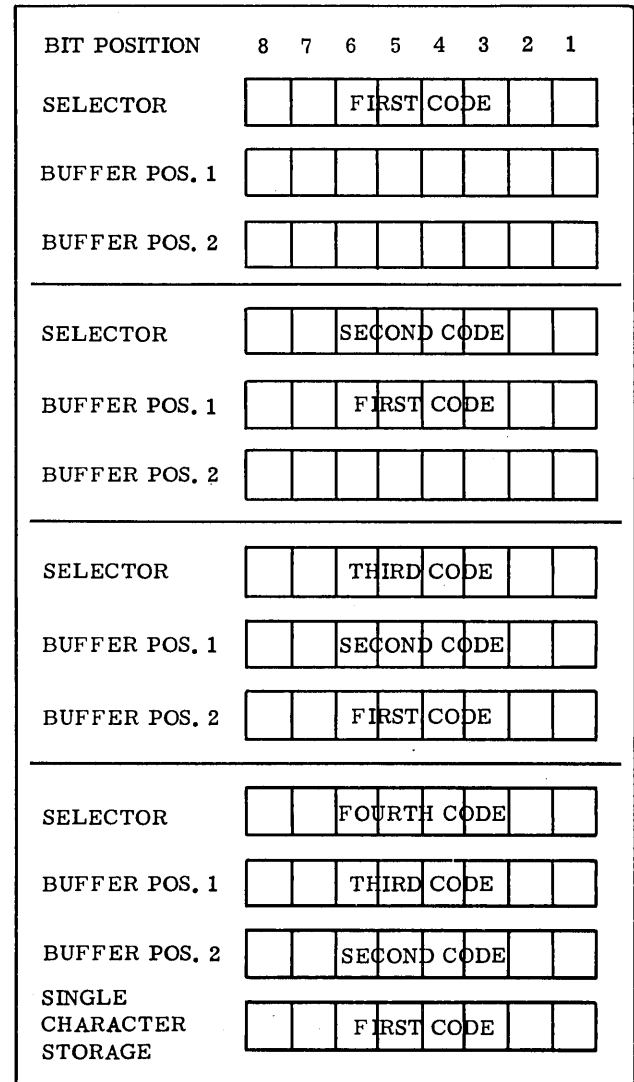

Figure 2. Two-Character Buffer, Showing Interaction With Selector and Single-Character Storage.

* A Trademark of Friden, Inc.

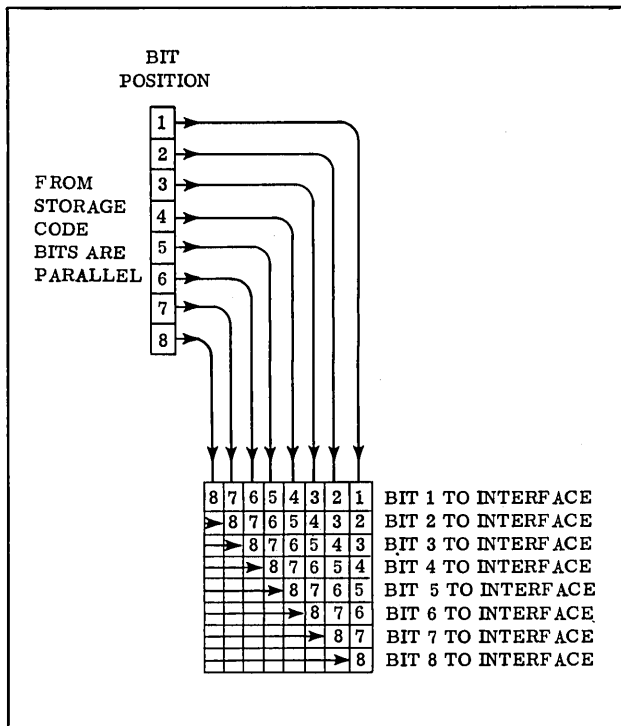

Figure 3. Serializing and Shifting of eight-bit character by Serializer/Deserializer.

Punch

The punch receives signals from the single-character storage, and if on, punches the associated codes. The punch is code insensitive. This makes it possible to punch non-USASCII codes sent from the reader or transmission line.

Serializer/Deserializer

All impulses or codes are generated and "moved" within the 7102 in a parallel fashion. (That is all bits for a particular code are read, punched or generated by keylever depression at the same time.) However, these bits must be transmitted from the Model 7102 in a serial fashion (i. e., one bit at a time.) As shown in Figure 3, the serializer/deserializer (or shift register) accomplishes this task by merely taking the low order bit (i. e., channel 1) and placing it in the first position of the register. Each ascending bit is placed into a corresponding position within the shift register. When all 8 bits have been stored in this register, they are sent to the interface unit one bit at a time. As the first bit is shifted out, it is re-

placed by the second bit and so forth until all 8 bits have been sent to the interface. The shift register also adds a start bit and one or two stop bits (depending upon the transmission requirements) to the code bit configuration.

When the shift register receives codes from the interface, the process is reversed. The start and stop bits are removed from the code configuration, and the data bits themselves are arranged for parallel movement within the Model 7102.

Interface

Coded impulses are received by the interface from the shift register in a serial fashion. The interface converts the internal unipolar signal to a bipolar form acceptable to communication equipment. (See Figure 4). This bipolar signal represents a "no bit" condition as a -2 volts and a bit condition as a +2 volts.

Conversely, the interface receives incoming signals in a bipolar form, and converts these incoming signals to a unipolar form compatible to the internal requirements of the 7102.

OPERATING SPEEDS

Reading (code sensing) speed of the 7102 is 730 codes per minute. This will provide automatic typing at a rate in excess of 135 (5 characters + space) words per minute.

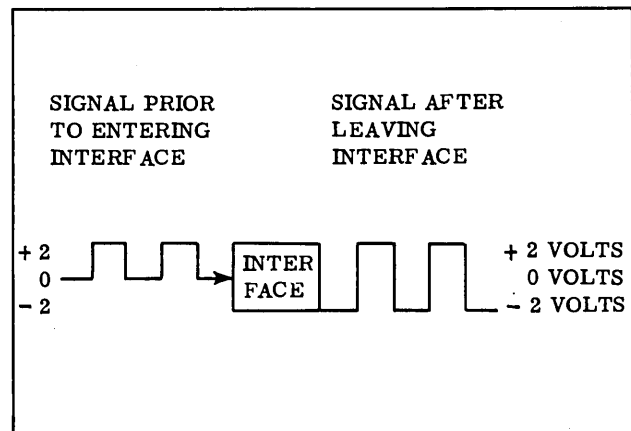

Figure 4. Unipolar/Bipolar Signal Conversion by Interface.

The 7102 is capable of transmitting or receiving a maximum of 12.2 characters per second. The transmission and reception rate is field adjustable from 10 characters per second to 12.2 characters per second.

The reader, keyboard, and punch are all synchronized to the transmission rate.

CONTROL

Specific operation of the Model 7102 can be controlled from three areas: the reader, the keyboard, and a remote device (such as a computer or another Model 7102).

Reader

Codes sensed in the reader can be punched,

printed, transmitted, or used to control machine functions.

Keyboard

All manual entries and operator control of machine functions are handled through keyboard operation.

Remote Device

The Model 7102 may be controlled from a remote device such as a computer or another Model 7102. In certain instances the printer, reader, and punch may be turned on and off by such remote devices.

SECTION II SPECIFICATIONS

To provide for maximum flexibility and reliability, the Model 7102 Communications Terminal is designed and engineered as a heavy duty unit. These heavy duty characteristics enable the Model 7102 to withstand many years of sustained high-speed operation. Extensive use of micro-integrated circuits, modular plug-in printed circuit boards and other solid-state components contribute greatly to the high reliability of the 7102. Below is a list of general specifications.

ELECTRICAL CHARACTERISTICS

Input power requirements: 115 volts AC, 50 Hz.

Current load: 1.5 amps.

Communications interface: Conforms to EIA Interface Standard - RS -232-B.

PHYSICAL AND ENVIRONMENTAL CHARACTERISTICS

Weight: 110 pounds.

Dimensions: 20 1/2" wide, 10" high, 22" deep.

Temperature range: +35 to +115 ° F.

Humidity range: 5% to 95%.

CARRIAGE

A 16-inch carriage is standard on the Model 7102. This carriage will accept a maximum paper size of 14 inches, and provides a writing line of 13.5 inches (135 characters). The carriage has been designed to accept standard size business documents.

The various standard features located on the carriage are shown in Figure 5 and are described in the following paragraphs.

Carriage Release Buttons

Located on both sides of the carriage, the carriage release buttons, when depressed allow the carriage to be moved freely, and to be manually positioned at any point to the right of the margin stop.

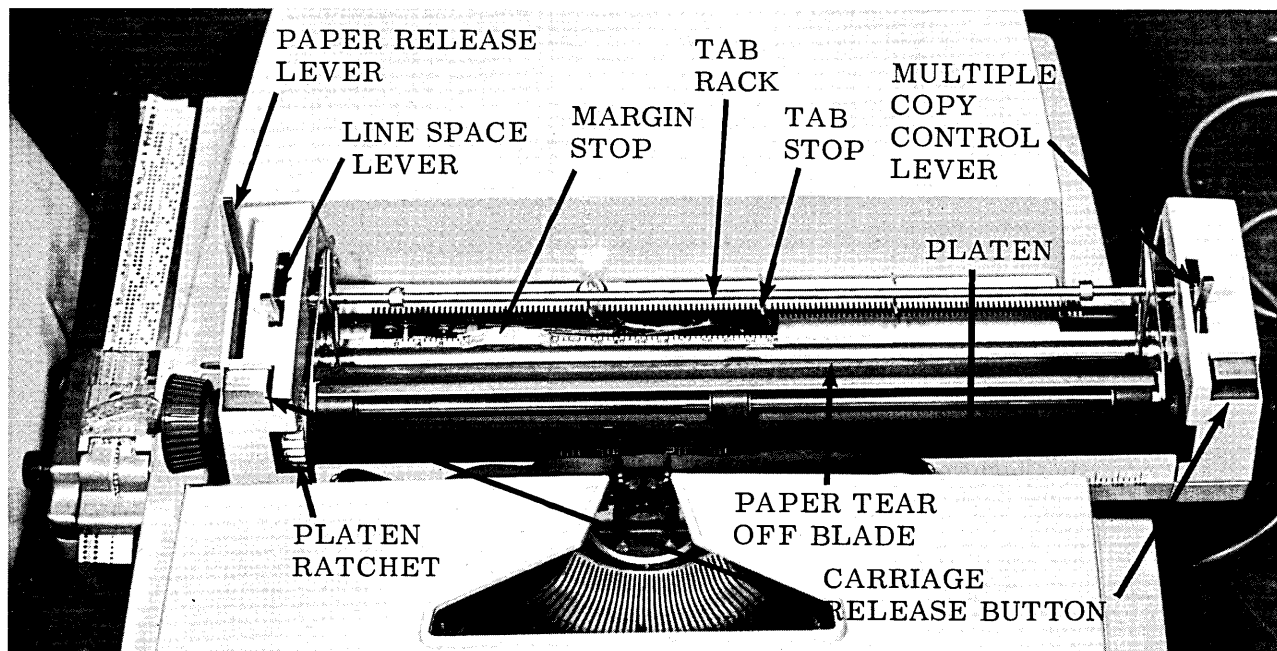

Figure 5. Carriage, Showing Standard Features.

Margin Stop

The extreme point of right carriage movement is fixed by the margin stop. The margin stop may be manually set at any letter space along the margin rack.

Paper Release Lever

When the paper release lever is moved from its rear position to the front position, all pressure on the platen is released, and the paper in the platen moves freely. This lever is normally used to adjust horizontal alignment of forms as they are inserted into the platen.

Multiple Copy Control Lever

The multiple copy control lever moves the platen back and forth to compensate for the thickness of multiple documents and carbons. As a general rule, this lever should be in the forward position (toward the operator), when one thickness of paper is being typed. Advance the lever for additional thickness, as needed to prevent embossing.

Platen

Platens are supplied in various sizes and degrees of hardness for different types of work. Usually, actual documents or forms are sent with the order to facilitate factory type alignment and platen selection.

Platen Ratchet

The platen ratchet controls the vertical line spacing of type on the document. A 33-tooth ratchet is standard and gives six lines to the inch.

Line Space Lever

The line space lever selects single or double line spacing.

Tab Rack

The tab rack provides right to left carriage movement to predetermined points. The tab

rack on the Model 7102 is non removable. Tabulation is initiated by the TAB key or by a code received from a remote device such as a computer or communications terminal. Tabulation is terminated by the manual placement of tab stops along the rack. Tab stops may be placed at any letter space position along the rack, but the minimum movement must be at least two letter spaces.

Paper Tear Off Blade

The paper tear off blade allows the operator to quickly and neatly tear off printed copy when using continuous forms or journal paper.

KEYBOARD

The Model 7102 is equipped with a standard typewriter keyboard, with shift keys on both sides. (See Figure 6.) A lock key is located on the left, and an unlock key on the right side of the keyboard. In addition to the standard alpha, numeric, and special characters, the keyboard is capable of generating control codes, which are engraved in red on the front of the key caps. Each key may generate a maximum of three codes: - the code which will print, punch and/or transmit the upper case character; the lower case character; and a control code (if assigned). Therefore it is not necessary, for example, to read two codes to print, punch, and/or transmit an upper case character. One code will shift the type basket and print the character. This is possible because the Model 7102 is capable of recognizing (and generating) the full 128 USASCII code structure.

The keyboard is divided into two general areas - the printing and format control keys, and the manual control keys.

Printing and Format Control Keys

Forty-five keys cause printing of 90 alphanumeric and special characters. There are seven format control keys including the space bar. Each may be operated manually by the operator, or automatically from the reader on a remote device.

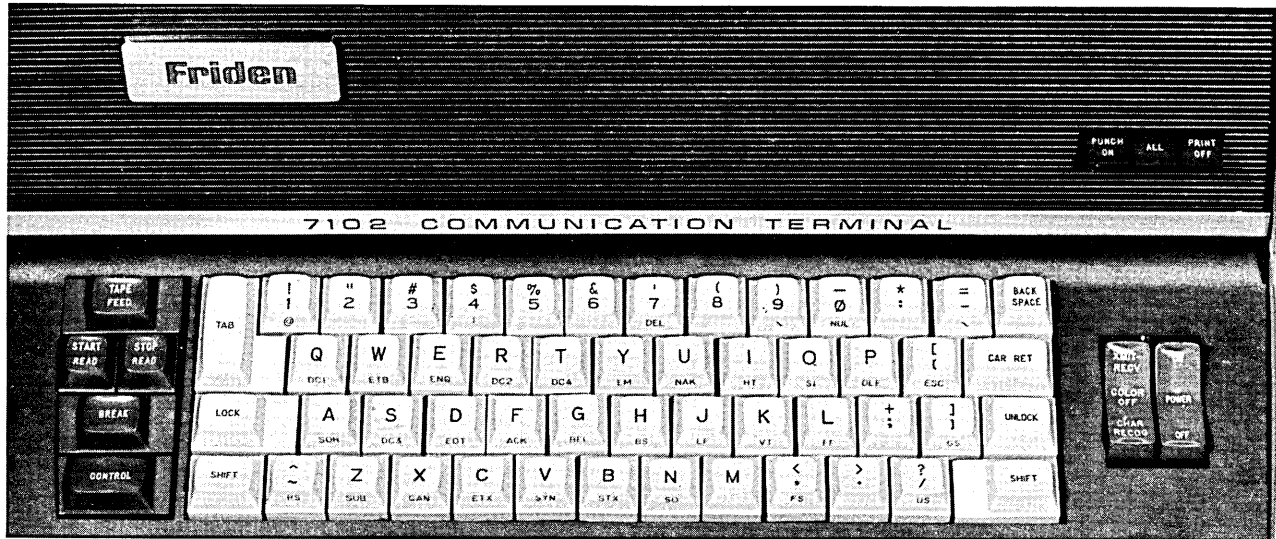

Figure 6. Model 7102 Keyboard.

CAR RET (CARRIAGE RETURN) KEY

When operated the CAR RET key causes the carriage to return to the left margin. The document is indexed one or two line spaces, depending upon the setting of the line space lever, carriage return and line feed are a compound motion on the Model 7102, and cannot be separated.

TAB KEY

When operated, the TAB will cause right-to-left carriage movement at high speed. Termination is determined by the placement of tab stops in the tab rack.

SHIFT KEY

When operated, the SHIFT key will cause the printer to be conditioned to print upper case characters. The SHIFT key itself is non-locking, therefore, the printer will return to the lower case condition upon release of this key.

LOCK KEY

Depression of the LOCK key will cause the printer to shift to an upper case condition. The printer will remain in upper case until either the SHIFT or UNLOCK key is depressed.

UNLOCK KEY

The UNLOCK key will return the printer to a lower case condition.

BACK SPACE KEY

Operation of the BACK SPACE key will cause the carriage to move one letter space in reverse (left to right).

SPACE BAR

Operation of the space bar will cause the carriage to move one letter space forward (right to left).

Manual Control Keys

Located to the left of the keyboard, is a group of five manual control keys. These keys allow the operator to manually control various machine operations. Specific operation is described in Section III.

CONSOLE PANEL SWITCHES

Immediately above and to the right of the keyboard, is a group of three console switches, which allow manual conditioning of certain components. Specific operation of these switches is described in Section III.

TYPE STYLE

The type style used by the Model 7102 is pica standard. This provides 10 typewritten characters to the horizontal inch. The Model 7102 has a cancelled zero (Ø), which prevents the letter O from being mistaken for a zero.

RIBBON

The Model 7102 Communications Terminal is equipped with a red and black inked ribbon. Under certain circumstances, characters are printed in red.

TAPE USED

A one inch wide tape (see Figure 7) is used and is punched with an eight-unit code. Tapes of various materials are supplied by Friden, Inc. Code hole positions are numbered 8-7-6-5-4-3-2-1 from left to right across the width of the tape. Feed holes assure positive positioning of the tape in the reader and punch. They are located between the third and fourth code holes, .394 inches from the right (guide) edge of the tape, and are in line with the code holes.

CODE SYSTEM

The Model 7102 Communications Terminal uses a full 128-character USASCII code set.

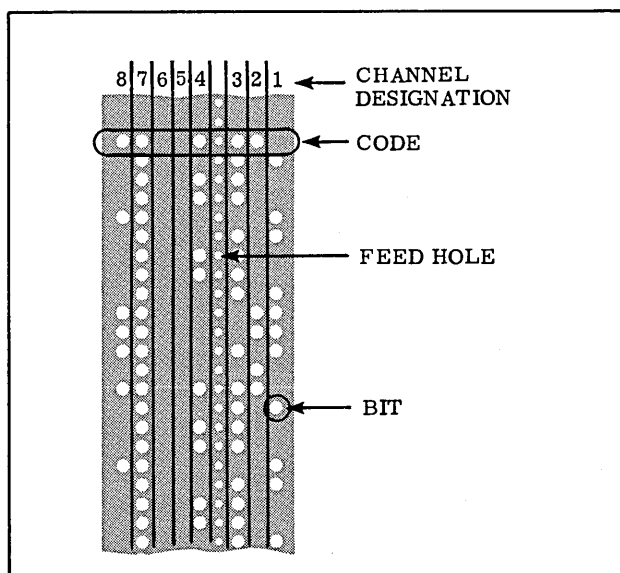

Figure 7. 8-Channel, USASCII-Coded Punched Tape.

This is the established standard coding structure for the industry. USASCII is a seven-level code. In the Model 7102, an eighth bit is added for even parity. (That is, each code is comprised of an even number of bits). The Model 7102 is capable of reading, punching, transmitting and receiving all 128 USASCII codes. A code chart, listing all USASCII codes will be found on Figure 8.

ACCURACY CHECKING

An elaborate system of checks is incorporated to insure accurate transmission and/or code punching. Some of these checks are integral within the machine; others provide accurate tape feeding, and positioning. The integral checks are described in the following paragraphs.

Two-Character Buffer

Previously described in Section I (under Components), this feature prevents a code from being scrambled due to "over key-boarding."

Parity Check

All codes generated by the Model 7102 keyboard are considered valid codes and contain an even number of bits.

Keylever Interlock

The keylever interlock prevents the accidental operation of more than one key at a time. It assists the two-character buffer in preventing garbled codes due to over key-boarding.

TAPE SUPPLY

Tape is supplied to the punch from a special holder on the back of the machine (see Figure 9). Tape feeds from a roll, approximately 1000 feet in length, through the punch unit. Several checks provide positive feeding and registration during this process. These checks are shown in Figure 9, and described in the following paragraphs.

| BITS | | | | | COLUMN | | | | | | | |
|------|----|----|----|-----|--------|-----|----|---|---|---|---|-----|
| b4 | b3 | b2 | b1 | ROW | 0 | 1 | 2 | 3 | 4 | 5 | 6 | 7 |
| 0 | 0 | 0 | 0 | 0 | NUL | DLE | SP | 0 | @ | P | | p |
| 0 | 0 | 0 | 1 | 1 | SOH | DC1 | ! | 1 | A | Q | | q |
| 0 | 0 | 1 | 0 | 2 | STX | DC2 | " | 2 | B | R | | r |
| 0 | 0 | 1 | 1 | 3 | ETX | DC3 | # | 3 | C | S | | s |
| 0 | 1 | 0 | 0 | 4 | EOT | DC4 | \$ | 4 | D | T | | t |
| 0 | 1 | 0 | 1 | 5 | ENQ | NAK | % | 5 | E | U | | u |
| 0 | 1 | 1 | 0 | 6 | ACK | SYN | & | 6 | F | V | | v |
| 0 | 1 | 1 | 1 | 7 | BEL | ETB | ' | 7 | G | W | | w |
| 1 | 0 | 0 | 0 | 8 | BS | CAN | (| 8 | H | X | | x |
| 1 | 0 | 0 | 1 | 9 | HT | EM |) | 9 | I | Y | | y |
| 1 | 0 | 1 | 0 | 10 | LF | SUB | * | : | J | Z | | z |
| 1 | 0 | 1 | 1 | 11 | VT | ESC | + | ; | K | [| | { |
| 1 | 1 | 0 | 0 | 12 | FF | FS | , | < | L | \ | | |
| 1 | 1 | 0 | 1 | 13 | CR | GS | - | = | M |] | | } |
| 1 | 1 | 1 | 0 | 14 | SO | RS | . | > | N | ^ | | ~ |
| 1 | 1 | 1 | 1 | 15 | SI | US | / | ? | O | _ | | DEL |

Figure 8. USASCII Code Chart

Tape Guide

The tape guide serves to provide a smooth, even flow of tape to the punch. It prevents kinks or tears from occurring as tape is being fed from the supply spool.

Tape Tension Arm

The tape tension arm acts as a safeguard against tape feeding due to obstructions in feeding. If the tape should become ob-

structed, or if a certain pre-set tension is exceeded, this arm will cause the machine to become locked against further operation until corrective measures are taken.

Tape Hold Down Arm

The tape hold down arm provides sufficient pressure against the tape in the punch to insure positive engagement of the feed holes with the feeding mechanism. If this arm is not closed, the keyboard will lock until the situation is corrected.

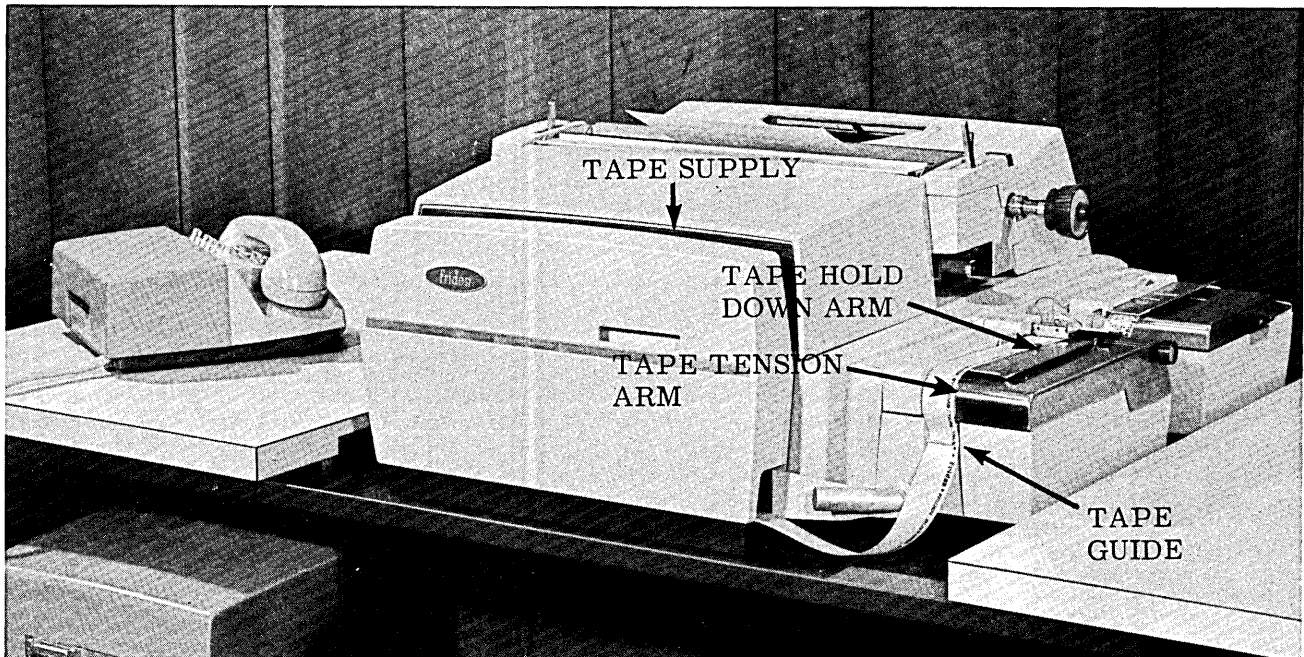

Figure 9. Tape Supply

DESK

The Model 7102 desk is constructed of high-strength steel with wear resistant Formica top. Designed especially for the Model 7102, the desk is 28-1/2 inches high, 27-1/2 inches deep, 51-1/4 inches wide (with tape-

only reader and punch) and 54-1/2 inches with tape/edge card reader and punch. It contains a shelf to hold the data set and strapping to keep the necessary cabling safely and neatly out of sight. Two other features of the desk, a chad box, and a stacker for edge-punched cards are shown in Figure 10.

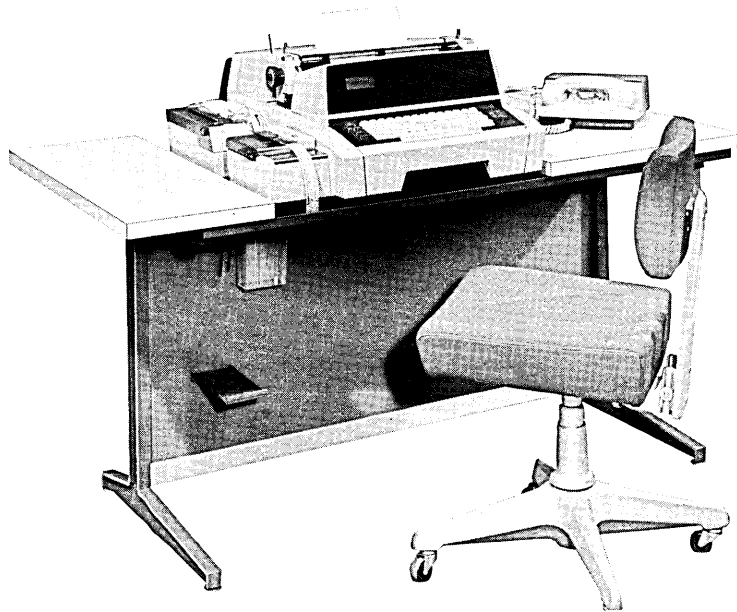
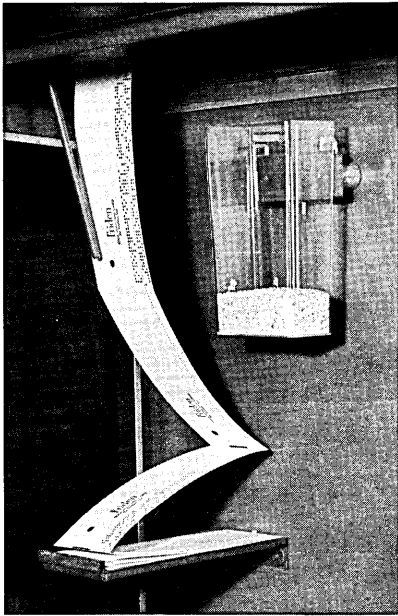

Figure 10. Chad Box and Stacker for Edge-Punched Cards on Model 7102 Desk.

SECTION III

OPERATING FEATURES

This section describes the operating controls and the basic operating principles of the Model 7102 Communications Terminal.

POWER SWITCH

A two-position power switch, at the right of the keyboard, is used to turn the power on and off. This rocker-type switch must be in the ON position in order to establish telephone connection with a remote device such as a computer or another communications terminal. (See Figure 11.)

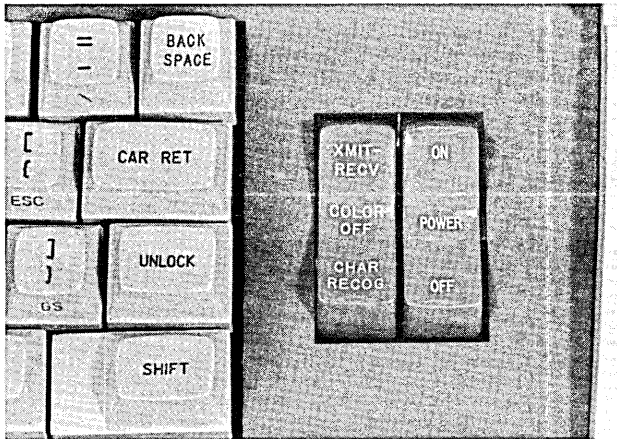

Figure 11. POWER and Color Mode Switches.

COLOR MODE SWITCH

A three-position rocker-type color mode switch is located at the right of the keyboard (see Figure 11). This switch, labeled XMIT-REC, COLOR OFF, CHAR RECOG provides for use of an automatic color ribbon shift in the following modes:

1. XMIT-REC: All transmitted messages print in red. Received control (3rd case) codes do not print. The choice of colors for transmit and receive is optionally reversible. Transmitted control codes print, in red, the graphic character normally printed by the key.
2. COLOR OFF: All transmitted and received graphic characters print in black. Transmitted control codes print

in red; received control codes do not print.

3. CHAR RECOG: All transmitted and received control (3rd case) codes cause printing in red of the corresponding normal upper or lower case symbol on the key. All other codes print in black. This allows a printing representation of all 128 USASCII characters except carriage return (CR) and space (SP). Line feed (LF);

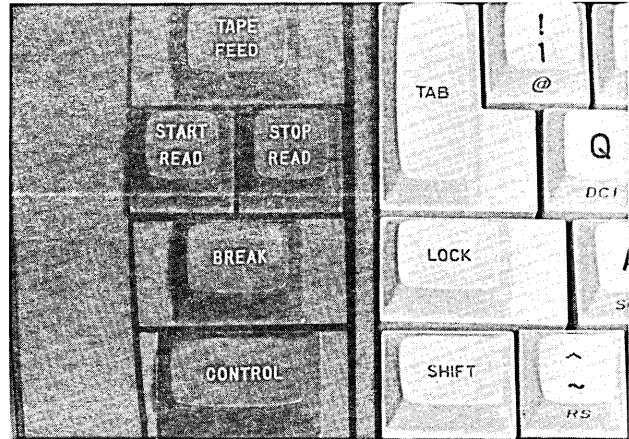

Figure 12. Manual Control Keys.

null (NUL); and delete (DEL) codes can be optionally inhibited in this mode. Horizontal tabulation is inhibited in this mode and is replaced by the printing of a red "I". Backspace is inhibited and replaced by printing a red "H".

MANUAL CONTROL KEYS

This group of five keys, located immediately to the left of the keyboard is used for manual control of the reader and punch, code generation and the Interrupt Feature. The manual control keys are shown in Figure 12, and described in the following paragraphs.

TAPE FEED Key

The TAPE FEED key feeds tape through the punch for as long as it is depressed. The punch does not have to be in an on condition

for this function to occur. The TAPE FEED key causes punching of the Delete (DEL) code (code bits 1 through 8), which is used for preparing leader and trailer strips and to overpunch tape errors. If the Model 7102 is equipped with an edge card punch, this switch has a somewhat different function when edge cards are being punched. This is further described in Section IV, Customizing Features.

START READ Key

When touched and released, the START READ key initiates reading action. Holding this switch down, temporarily stops the reading action until it is released, allowing the operator to pulse codes through the reader one at a time.

STOP READ Key

When the STOP READ key is touched, reading action stops.

BREAK Key

When depressed and held, the BREAK key transmits a continuous "spacing" signal to a computer. Through programming, the computer will go into a routine to acknowledge the "break", or "interrupt" signal. This key is useful when the operator wishes to interrupt a computer sequence, for example, when enough information has been obtained from a program, and there is no need to continue that particular sequence. (The BREAK key can also be used to interrupt another terminal.)

CONTROL Key

When the CONTROL key is depressed in conjunction with certain keylevers, the code represented by the red engraving on the front of the key cap will be generated. This key provides character generation of the 32 non-printing USASCII codes plus the characters "@", ".", and "\".

PANEL SWITCHES

Immediately above and to the right of the keyboard is a group of locking switches which allow the operator further control over the reader, punch and printer. (See Figure 13.) Descriptions of these switches, their functions and modes of operation follow.



Figure 13. Panel Switches.

PRINT OFF Switch

With the PRINT OFF switch in the up (unoperated) position, normal printing, punching, transmission and reception will occur.

With the switch in the down (operated) position, operation of the keyboard will cause printing, but no codes will be punched or transmitted. Codes read in the reader may be punched and transmitted, but will not print. Codes received from the interface may be punched, but will not print.

NOTE: The function of this switch will be overridden if the punch is in an off condition.

ALL Switch

The ALL switch controls the reader, making it either code sensitive or insensitive. In the up or normal position, the reader will be sensitive to (that is, recognize) certain codes. A Stop code (manufactured by simultaneously depressing the CONTROL and T keys to manufacture the DC4 code) will stop the reading action; and a Tape Feed (DEL) code will be disregarded by the reader. Neither code will be transmitted by the reader.

When the ALL switch is depressed, the reader will be insensitive to (that is, it will not recognize) certain codes. All codes, including the Stop and Tape Feed (DEL) codes will be transmitted by the reader. In addition the Stop code will not stop the reader.

PUNCH ON Switch

The PUNCH ON switch controls the operation of the punch. In the up (unoperated) position; the punch is off. In the down (operated) position, the punch will be on. If the switch is in an unoperated position, the printer may not be turned off by the PRINT OFF switch. This is a safety feature which eliminates the possibility of losing a received message due to the punch and printer both being in an off condition. In this case, the received message would be printed instead of punched.

SECTION IV CUSTOMIZING FEATURES

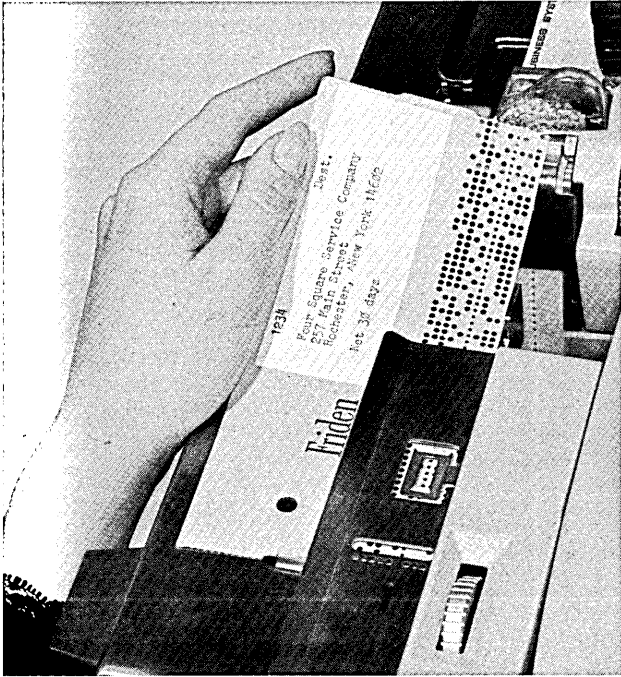

Figure 14. Edge-Punched Card Reader.

The 7102 Communications Terminal has many desirable features which make it well-suited to most applications. However, in some applications features other than standard may be required. This section describes these optional features.

EDGE-PUNCHED CARD READER AND PUNCH

An edge-punched card reader and/or punch can be installed on the Model 7102 in place of the standard tape-only reader and punch. Figures 14 and 15 illustrate the appearance of these units. Both the reader and punch can use either tape or edge-punched cards.

Edge-punched cards are encoded along one or two edges with the same 8-channel code as is punched into tape (see Figure 14). Speed of insertion and removal, as well as simplified filing methods, make edge-punched unit record cards particularly well adapted to systems applications.

With edge cards in the punch (see Figure 15), the TAPE FEED manual control key operates in a slightly different manner. Touching and releasing this key will cause the next edge card to advance to the first punching position, punching feed holes only.

This means that when edge cards are being punched, the TAPE FEED key cannot be used to delete codes erroneously punched by the operator. Instead, wrong codes are over-punched by depressing the CONTROL manual control key, and the "7" key simultaneously.

With tape in the punch, the TAPE FEED manual control key operates normally. It punches the Tape Feed (DEL) code as long as it is depressed.

Both the edge-punch card reader and punch must be factory installed.

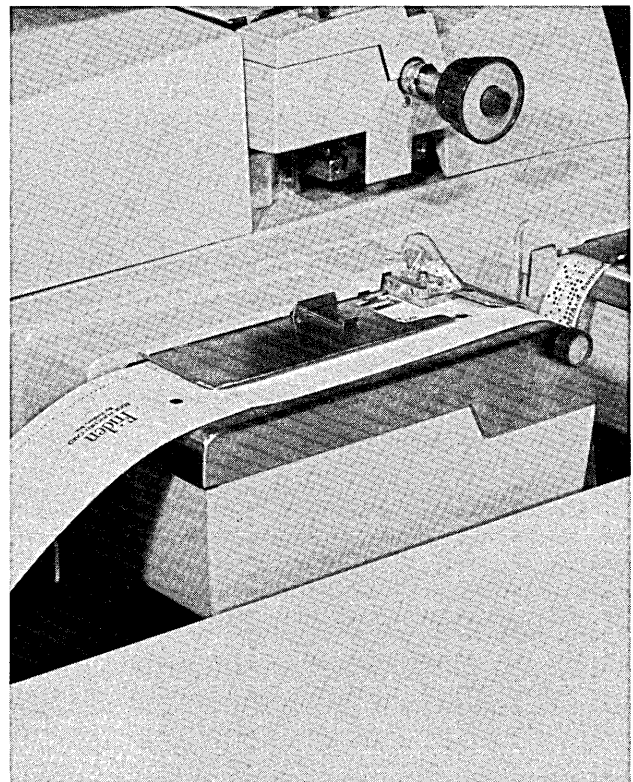

Figure 15. Edge Card Punch.

MECHANICAL NON-PRINT FEATURE

Mechanical non-print is a factory installable feature which, when engaged, prevents the type bars from striking the printing surface. By using this feature, user numbers, passwords, and other identifying security information can be entered from the keyboard, but not printed on hard copy. When the manual non-print lever (located on the right side of the terminal) is moved to the rear, a rubber bumper is positioned to arrest the motion of the typebars, as shown in Figure 16. Figure 17 shows the bumper in the retracted position.

CHARACTER PARITY CHECK FEATURE

Character parity check is a factory installable option which allows parity checking of all received data. Codes which have incorrect parity cause an upper case "M" to be printed in red, and cause a Delete code to be punched.

The parity check feature can be manually over-ridden. This permits any 8-bit non-USASCII codes to be punched in the Model 7102, and also permits 8-bit, non-parity, USASCII codes to be printed and/or punched.

AUTOMATIC DEVICE CONTROL FEATURE

Automatic device control is a factory installable option which allows both on-line (computer or another Model 7102) and off-line (local reader) control of the punch, reader, and printer by use of control codes as follows:

- DC 1 - Punch On
- DC 2 - Start Reader
- DC 3 - Punch Off
- DC 4 - Reader Stop
- SO - Printer Off
- SI - Printer On

The DC 4 (Stop) code can only be used when read from a tape in the local reader due to the half duplex operation of the terminal; a "break" (200 millisecond spacing signal)

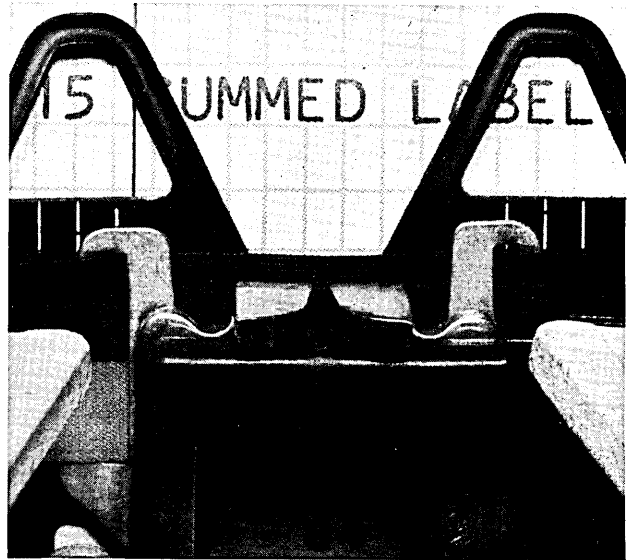

Figure 16. Mechanical Non-Print Feature, Engaged Position.

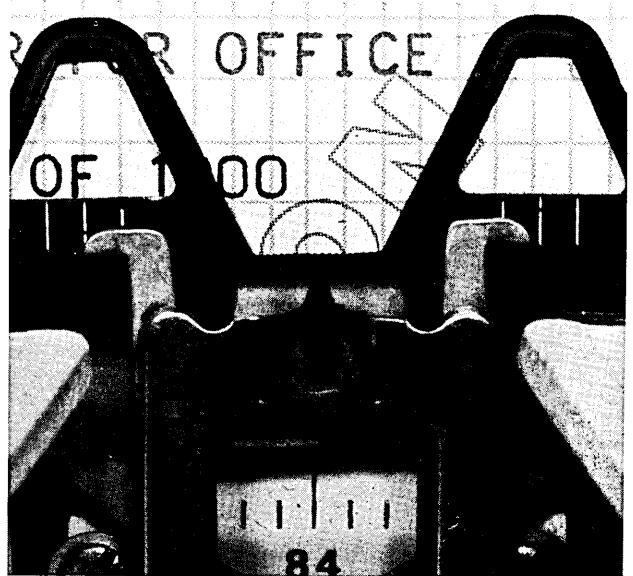

Figure 17. Mechanical Non-Print Feature, Retracted Position.

from the computer or other terminal is required to stop the reader on-line. The DC 2 (Start Reader) code is of use only in the on-line receive mode of operation.

The automatic device control feature is in effect only when the ALL panel switch is in the up position.

The device control codes, when read from the reader or received from the communications line, will control operation of punch,

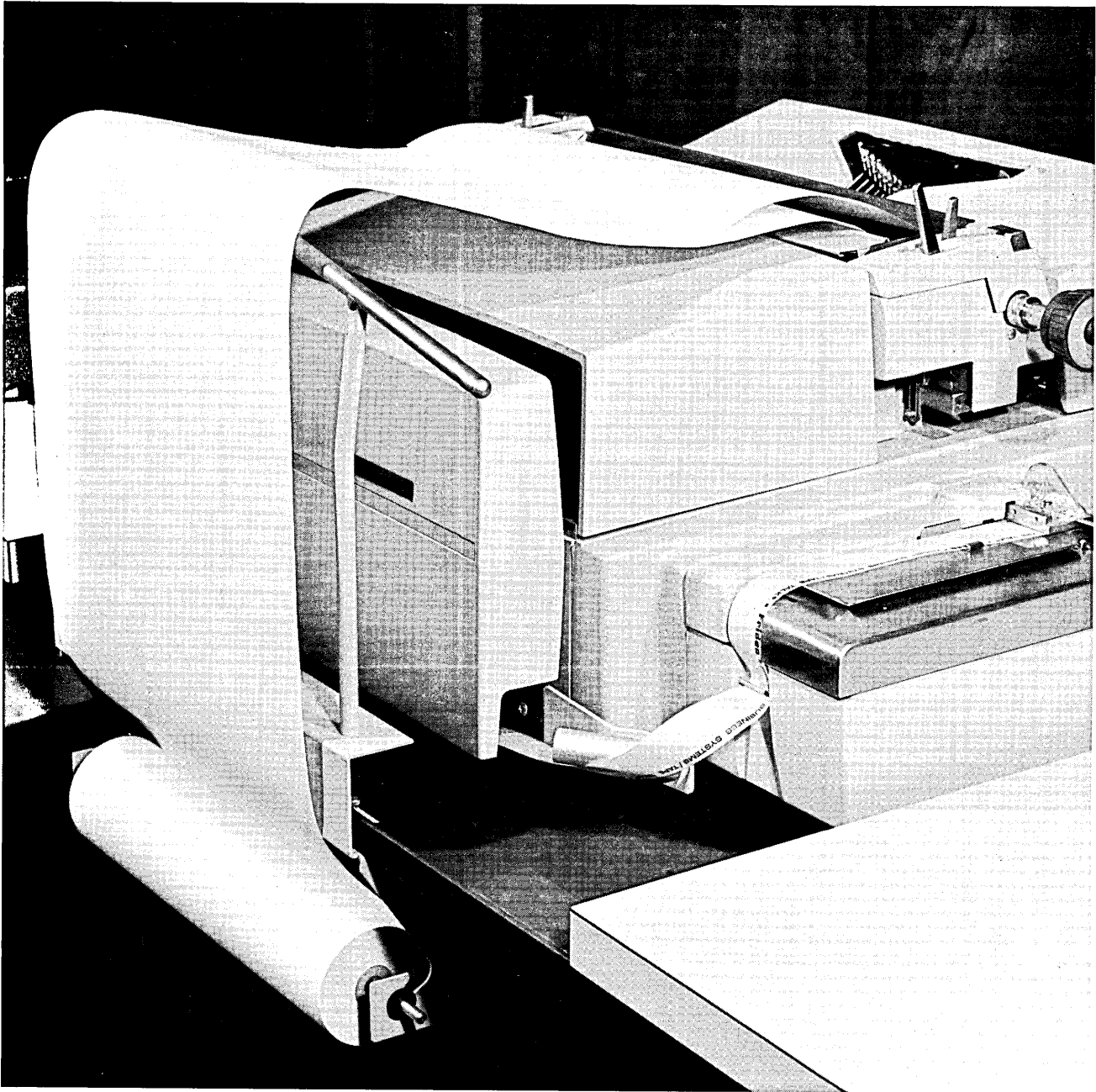

Figure 18. Roll Paper Holder and Mounting Stand.

printer, and reader. These codes will not be reproduced by the printer or punch, or transmitted to the communications line. The control codes over-ride the PRINT OFF and PUNCH ON panel switches. Keyboarded control codes will always be punched or transmitted. When the ALL panel switch is down, the automatic device control feature is disabled.

ACCESSORIES

Roll Paper Holder and Mounting Stand

In some applications, it may be necessary or desirable to use a continuous roll of paper rather than individual forms. The roll paper holder and mounting stand, shown in Figure 18, attaches to the Model 7102 desk and can accommodate the maximum width paper acceptable in the carriage.

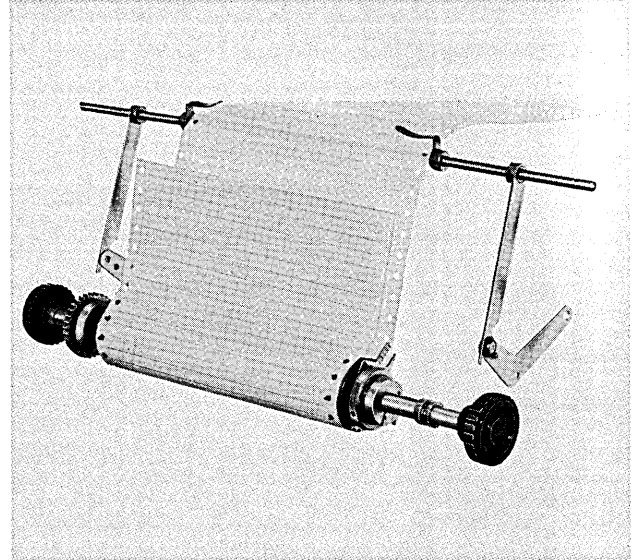
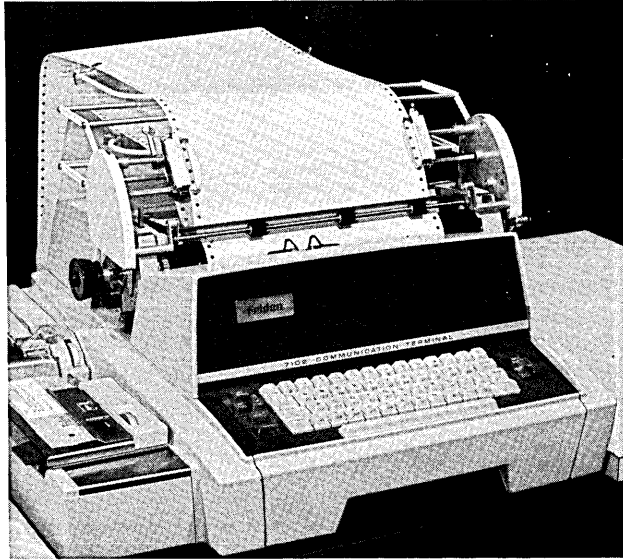

Figure 19. Flexofeed (left) and Pin Feed Platen (right).

Flexofeed

The Flexofeed by FRIDEN makes use of the standard platen, but allows both continuous and standard forms of different widths to be used, interchangeably. When the Flexofeed is in position on the carriage, as shown in Figure 19, continuous forms, perforated on both sides, may be used. Otherwise, it is easily detached to accommodate standard forms. The Flexofeed is hand-adjustable to any width form.

Pin Feed Platens

Pin feed platens are available for factory or field installation. They have retractable pins at either end to accommodate continuous forms. Designed by many different forms companies to fit specific applications, the forms themselves are usually made up of multiple copies interleaved with carbon paper.

Positive registration is the main advantage provided by the use of pin feed platens. The writing areas match exactly on the original and all carbon copies. Also the operator does not have to align each form separately.

SECTION V

COMMUNICATIONS CONCEPTS AND CONSIDERATIONS

The information contained in this section is intended to acquaint the user with the communications concepts and considerations which are pertinent to the use of the Model 7102 in a data communications system.

TYPES OF SERVICE

Communications common carriers offer two basic types of service; leased private and public switched. Leased private facilities are dedicated to full-time use by the subscriber. Normally a flat charge is paid for unlimited use of this service. Public switched service on the other hand, is not dedicated to a particular subscriber. The user is charged on a time and distance basis. The Model 7102 Communications Terminal is capable of operating on either of these services.

TYPES OF CIRCUITS, AND INTERRUPT PROVISIONS

The Model 7102 can operate in either a half duplex or full duplex type of circuit. In a half duplex circuit, the Model 7102 can transmit data, or receive data, but not at the same time.

In a full duplex system (such as ordinary telephone service), the following interrupt features are operational.

Transmit Mode

The computer can interrupt a transmission from the terminal reader by the transmission to the terminal of a break signal on the receive data line consisting of a 200-millisecond spacing condition. Computer interrupt of the manual keyboarding process is provided by software formatting for the individual application.

Receive Mode

The BREAK switch on the Model 7102 inter-

rupts a computer by transmitting a continuous spacing signal on the transmit data line as long as the switch is depressed.

GRADES OF CIRCUITS

Communications Common carriers offer three grades of circuits; narrow band (which includes telegraph grade and sub voice grade), voice band and broad band. The Model 7102 requires at least a sub voice grade of circuit which has a capacity to handle a maximum of 180 bits per second.

TRANSMISSION MODE AND SPEED

Characters are transmitted in a serial start-stop (or asynchronous) fashion. The Model 7102 is capable of transmitting a maximum of 12.2 characters per second. This rate is field adjustable from 10 characters per second to 12.2 characters per second. The bit rate is adjustable from 100 to 137 bits per second depending on whether one or two stop bits are required.

Transmitted and received characters consist of 10 signal elements (bits) as follows: START, 7 USASCII bits (low order bit first), EVEN PARITY, STOP.

Start bit is defined as a spacing condition (binary 0). Stop bit is defined as a marking condition (binary 1). A marking signal is continuously transmitted between codes and during idle periods.

The length of the stop bit is field adjustable from one to two bit times in order to provide an 11 bit character format where required.

MODEMS

In an on-line mode of operation, the Model 7102 interfaces to the common carrier facilities through the use of a modem (data

set). The modem serves to modulate DC signals presented to it by the Model 7102. That is, it impresses the DC signal on a continuous wave carrier signal to form a data-bearing, audio-frequency signal that is compatible with communications facilities.

The following modem models are frequently used:

Western Electric 103A - public switched
Western Electric 103F - leased private
Western Union 1808D - leased private

No modem is required for direct connection up to fifty feet.

A special type of modem, known as acoustic couplers, may be used (in certain instances) to modulate/demodulate the signals to and from the Model 7102. These devices allow the Model 7102 to transmit and receive data using a normal telephone.

COMMUNICATIONS INTERFACE

The Model 7102 interface conforms to EIA Interface standard RS-232-B.

TIMING

Carriage Return

When the Model 7102 is receiving data, time for a single carriage return will not exceed the time in milliseconds computed by multiplying the carriage spaces travelled by 7

milliseconds and adding the constant 220 milliseconds.

Time (milliseconds) = (7ms x number of spaces) + 220 ms.

Line spacing, (indexing) at the margin requires 220 milliseconds delay. Carriage return and line feed are a compound motion and cannot be separated.

Case Shift

When the Model 7102 is receiving data, no additional time is required to shift to upper or lower case characters, the printing plus the shift is accomplished in one code time.

Horizontal Tabulation

When the Model 7102 is receiving data, the time for a horizontal tabulation will not exceed the time in milliseconds computed by multiplying the carriage spaces travelled by 14.5 milliseconds and adding the constant 330 milliseconds.

Time (milliseconds) = (14.5 ms x number of spaces) + 330 ms.

The tab stops are manually set by the operator.

Backspace

Backspacing action requires two character times (BS plus one character fill code, either NUL or DEL).

SECTION VI

ON-LINE AND OFF-LINE OPERATING PROCEDURES

Specific operating procedures for both on-line and off-line modes of operation will vary with the application and installation. These procedures will also vary with the type of computer/communications system employed. Therefore, this section presents a general approach to establishing specific procedures, in addition to giving examples of their use.

It should be remembered that the primary function of the Model 7102 is to transmit data to be used in conjunction with a computer, and to obtain from the computer, responses to direct inquiries. This function in itself implies some form of a computer program. It is not within the scope of this manual to discuss computer programming as such, but at times examples may be used to clarify applications or features of the Model 7102.

OFF-LINE OPERATION

Systems Considerations

When used in an off-line mode of operation, the Model 7102 may be used to process business documents such as sales orders, purchase orders, etc. Generally a tape will be created as a by-product of this operation. This tape will contain selected data for later transmission and processing.

The procedure for creating the select tape may vary, depending on optional features installed on the Model 7102. For example, if the Model 7102 is not equipped with the automatic device control feature, the operator will manually turn the punch on and off to capture the selected information.

However, if the Model 7102 has the automatic device control feature, DC 1 (Punch On) and DC 3 (Punch Off) codes may be placed in an edge punched card (or tape) to turn the punch on and off automatically at the proper time. (Refer to Section IV. Customizing Features

for a more complete description of this feature.)

In addition, the automatic device control feature allows special codes and data to be punched into the tape without being printed. For example, if the numbers 12345 were to be punched into the tape, but not printed on the document, the program for the Model 7102 would be as shown in Figure 20.

In this particular type of system, the Model 7102 operates independently of the computer/communication system while creating the document and select tape. However, the system should be so designed to allow the Model 7102 to access the computer at any time for status reports or other inquiry processing functions. A major advantage of this type of system is that the actual telephone line time is greatly reduced, resulting in lower operating costs for the entire system. Computer time is also reduced in this type of system. Less time is required to process selected data from a document, than to input all of the data contained on a document, and through computer programming, select the required information.

The select tape transmitted to the computer will be error-free and verified. As the operator is preparing the document and tape, visual verification is necessary only for manual data entered by the operator. If a mistake has been made, the tape and document may be corrected immediately.

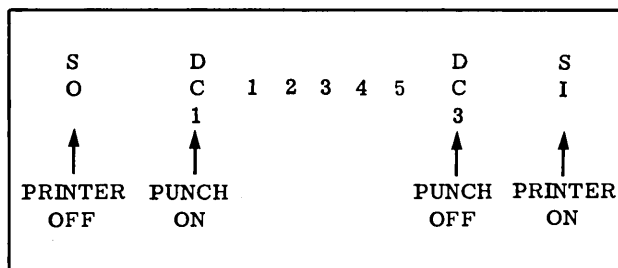

Figure 20. Simple Tape Program for Punching Data Without Printing.

Generally, the select tape will be transmitted after all of the documents have been prepared. However, depending on the system, it may be desirable to transmit data more often than once a day.

Programming

The programming required to produce the document and select tape is similar to normal FLEXOWRITER automatic writing machine programming. Constant vendor, customer or item data is pre-captured in edge-punched cards. In addition to this constant data, format control codes, punch control codes, and any special codes required for transmission and/or computer operation are also contained in the edge-punched card. The operator merely inserts the card in the reader, and touches the START READ manual control key. The reader will automatically stop at the appropriate fields to allow the operator to input variable data. Similar cards are used to prepare the "item" section of the document. Each card contains information for one vendor, customer, or line item.

ON-LINE OPERATION

The Model 7102 may be used for on-line applications in many systems. Generally, an on-line system will involve inquiry processing, file updating, and/or time-sharing. Time-sharing may be further subdivided into commercial time-sharing and in-house time-sharing. In commercial time-sharing, actual computer time is purchased from an outside source. In-house time-sharing allows many departments within a company to share the same computer.

On-line applications will vary, but they all have one common objective -- that of interfacing the person with a problem to the computer capable of solving that problem. On-line applications are generally oriented more towards a computer program which will give the desired results, than towards a FLEXOWRITER writing machine type of program which will produce a document. (However, a Model 7102 can be used on-line in a billing system. In this case, both a

FLEXOWRITER writing machine program and a computer program would be used.)

The computer program in on-line systems should be written in such a manner that the Model 7102 operator has only to enter the required data. In many cases, the program is written to ask the operator specific questions, or the operator will be given definite instructions, such as, "what is the interest rate?" or, "enter Social Security number - (omit hyphens)".

In the latter case, the operator was told what information to enter and how to enter it. Programs such as these, are usually stored in the computer on a permanent basis. They are intended for repetitive use whenever needed.

Other on-line programs are intended for one-time or infrequent use. For example, a scientist may develop a program which he will use only once to get a specific answer to a specific problem. When he has received the answer, the program is of no further use, and is destroyed. On the other hand, an engineer may develop a program which could be used again for a similar situation at a future date. This program would be stored for future use.

In most on-line systems, storage becomes a factor. Whether the user has his own computer or is buying time on some one else's, storage can be expensive. Many users find it advantageous to store infrequently used computer programs on paper tape.

These programs are loaded into the computer via the reader on the Model 7102, and used to obtain an answer. The programs do not have to be saved in the computer because they are already stored in punched paper tape. The results obtained from the computer may also be stored in punched paper tape. Again, this will save computer storage and allow the intermediate results to be further processed at a later time.

PROCEDURES FOR COMMUNICATING WITH THE COMPUTER

In both on-line and off-line applications, contact between the Model 7102 and the computer must be established. In on-line systems, this contact will be established immediately, while in off-line systems contact will be established after the input data has been prepared. After contact has been established, identification is usually required, along with execution of the program, (inputting the data), obtaining the results, and signing off.

Establishing Contact

Generally, contact between the Model 7102 and the computer is established by dialing a number assigned to the computer. (See "Modem" in Section V). The computer will answer with a tone signal, and the operator will depress the DATA pushbutton located on the modem. (NOTE: The Model 7102 power switch must be ON, and the color mode switch in the XMIT-RECEIVE position.) The operator then types a greeting such as "Hello".

Logging In

After contact has been established, it is normal to require some method of logging in. This may involve user identification, terminal identification and/or a password. (This will vary with the system, but generally a combination of these "identifiers" are required.) These identifiers serve many purposes. In commercial time-sharing systems, they may serve a billing function, in addition to identification for a valid user. (Many in-house applications also use identifiers to charge computer time to specific departments.) Statistics such as operator usage, terminal usage, or department usage may also be obtained by using identifiers.

Systems which provide permanent storage use identifiers for storage protection. That is, each user can gain access only to the programs they have saved. User A could not access user B's programs, (conversely user B could not access user A's programs.)

Identifiers may also be used for storage allocation in the computer.

Executing the Program

If the desired program has been stored in the computer, the user may request it by name. Execution of the program is then accomplished by giving the computer a command which will cause the program to begin. Input data for the program may be entered manually from the keyboard or automatically from the reader.

If the desired program has not previously been stored in the computer, the operator may load it after contact has been established. The program may be loaded from the keyboard or if it has been stored in paper tape, automatically through the reader.

(NOTE: In some systems, the operator may type "Tape" to inform the computer that tape is going to be read. This applied to loading a program as well as a select tape created in an off-line application.)

Generally, an on-line application requires that the results obtained from executing the program be printed by the Model 7102. This will be controlled by the program itself. In an off-line application, results so obtained may or may not be printed by the Model 7102. This is dictated by the system itself and controlled by the computer program.

Sign-Off

When the computer program has been executed and the results obtained, some form of sign-off procedure should be initiated. Generally the sign-off procedure informs the computer that the application has been completed and, in many systems, disconnects the Model 7102. A sign-off procedure may be a simple statement or phrase typed by the operator.

Sample Procedures

Figures 21 through 24 show sample procedures for using the Model 7102. These examples are intended to be typical time-

sharing applications. They are not based on any actual system, program or application. Their sole purpose is to graphically illustrate the concepts that have been discussed in this section.

Figure 21 illustrates a typical procedure to establish contact with the computer, call for a stored program, execute the program, input data manually, and sign-off. Under-

lined entries indicate user's answers to the program.

This type of program is normally used when data concerning one particular salesman (or subject) is required. The program is designed to ask the operator to enter the information pertinent to a particular salesman (or subject).

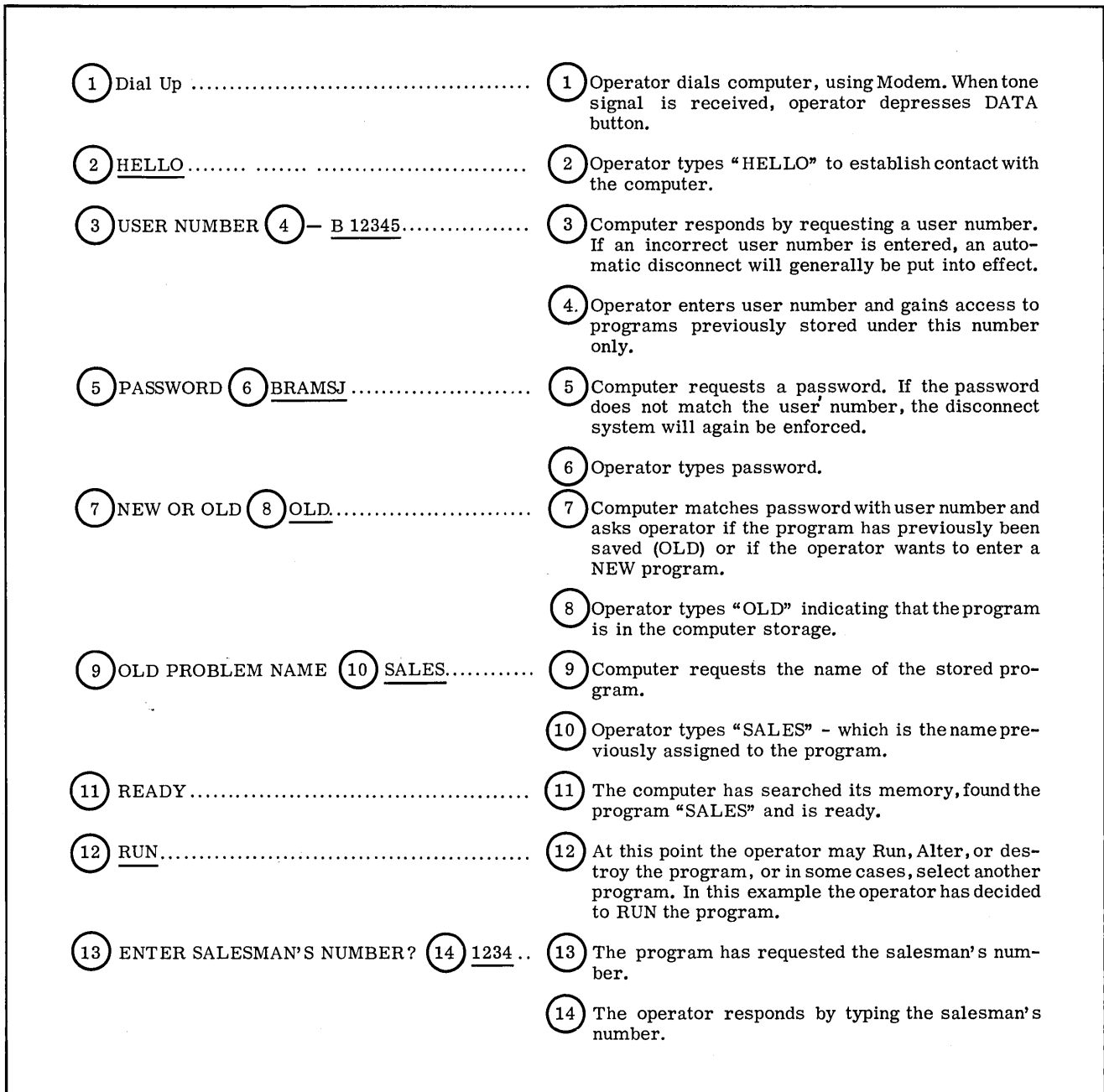

Figure 21. Example of Using Stored Program with Manual Data Input.

| | |
|--|--|
| <p>⑮ ENTER CURRENT SALES? ⑯ <u>25,000</u>.....</p> <p>⑰ TOTAL SALES, YEAR TO DATE 50,000.....</p> <p>⑱ PERCENT OF QUOTA YEAR TO DATE 50...</p> <p>⑲ TIME: 1 SECS.</p> | <p>⑮ The program requests the current sales. This will be added to previous sales to compute the total sales, year-to-date.</p> <p>⑯ Operator enters current sales.</p> <p>⑰ Program prints the statement "Total Sales, Year-to-Date" and the actual figure.</p> <p>⑱ Program prints the statement "Percent of quota, year-to-date" computes the percentage and prints it.</p> <p>⑲ The program has been completed. The computer now tells the user how much Central Processor Time has been used for this particular program. If the operator wishes to obtain the same information for another salesman - step 12 would be repeated.</p> |
|--|--|

Figure 21 continued.

However, it is sometimes desirable to print out a table containing complete information for all salesmen.

In Figure 22, a select tape has been prepared which will furnish the computer with the same information manually entered in Figure 21, that is, salesman's number and current sales for all of the salesmen. In

Figure 22 the program will not ask the operator for information concerning a specific salesman, instead, the operator will type "Tape" indicating to the computer that pre-recorded data is to follow. Of course, this program is modified to accept the tape as automatic input. Steps 1 through 11 will remain the same as for Figure 21.

| | | | | | | | | | | | | | | | | | | | | | | | | | | | | | | | | | |
|--|---|--------------|---|----------|---------|--------|---------|--------|----------|-------|----------|--------------|--------------|--------------|--------------|-------|-------|-------|-------|-------|-------|-------|-------|-------|-------|-------|-------|-------|-------|-------|----|----------------------------|--|
| <p>⑫ <u>TAPE</u>.....</p> <p>⑬ READY</p> | <p>⑫ Operator types "TAPE" indicating to the computer that a tape transmission of input data is to follow. During this transmission, the computer will not answer the normal End of Block codes transmitted to it. Instead, the computer will recognize a command at the end of the tape transmission, and execute the program.</p> <p>⑬ The computer indicates to the operator that it is ready to accept the tape transmission. The operator then depresses the START READ manual control key and the tape is transmitted to the computer.</p> | | | | | | | | | | | | | | | | | | | | | | | | | | | | | | | | |
| <table border="0"> <tr> <td style="vertical-align: top;"> <p>⑭</p> </td> <td style="padding-left: 10px;"> <table border="0"> <tr> <td style="text-align: left;">Salesman</td> <td style="text-align: left;">Current</td> <td style="text-align: left;">Total</td> <td style="text-align: left;">Percent</td> </tr> <tr> <td style="text-align: left;">Number</td> <td style="text-align: left;">Sales</td> <td style="text-align: left;">Sales</td> <td style="text-align: left;">of Quota</td> </tr> <tr> <td></td> <td></td> <td style="text-align: left;">Year to Date</td> <td style="text-align: left;">Year to Date</td> </tr> <tr> <td style="padding-left: 20px;">1234</td> <td style="padding-left: 20px;">25000</td> <td style="padding-left: 20px;">50000</td> <td style="padding-left: 20px;">50</td> </tr> <tr> <td style="padding-left: 20px;">1235</td> <td style="padding-left: 20px;">30000</td> <td style="padding-left: 20px;">60000</td> <td style="padding-left: 20px;">50</td> </tr> <tr> <td style="padding-left: 20px;">1236</td> <td style="padding-left: 20px;">35000</td> <td style="padding-left: 20px;">70000</td> <td style="padding-left: 20px;">50</td> </tr> <tr> <td style="padding-left: 20px;">1237</td> <td style="padding-left: 20px;">40000</td> <td style="padding-left: 20px;">80000</td> <td style="padding-left: 20px;">50</td> </tr> </table> </td> </tr> <tr> <td style="vertical-align: top;"> <p>⑮ TIME 4 SECS.</p> </td> <td></td> </tr> </table> | | <p>⑭</p> | <table border="0"> <tr> <td style="text-align: left;">Salesman</td> <td style="text-align: left;">Current</td> <td style="text-align: left;">Total</td> <td style="text-align: left;">Percent</td> </tr> <tr> <td style="text-align: left;">Number</td> <td style="text-align: left;">Sales</td> <td style="text-align: left;">Sales</td> <td style="text-align: left;">of Quota</td> </tr> <tr> <td></td> <td></td> <td style="text-align: left;">Year to Date</td> <td style="text-align: left;">Year to Date</td> </tr> <tr> <td style="padding-left: 20px;">1234</td> <td style="padding-left: 20px;">25000</td> <td style="padding-left: 20px;">50000</td> <td style="padding-left: 20px;">50</td> </tr> <tr> <td style="padding-left: 20px;">1235</td> <td style="padding-left: 20px;">30000</td> <td style="padding-left: 20px;">60000</td> <td style="padding-left: 20px;">50</td> </tr> <tr> <td style="padding-left: 20px;">1236</td> <td style="padding-left: 20px;">35000</td> <td style="padding-left: 20px;">70000</td> <td style="padding-left: 20px;">50</td> </tr> <tr> <td style="padding-left: 20px;">1237</td> <td style="padding-left: 20px;">40000</td> <td style="padding-left: 20px;">80000</td> <td style="padding-left: 20px;">50</td> </tr> </table> | Salesman | Current | Total | Percent | Number | Sales | Sales | of Quota | | | Year to Date | Year to Date | 1234 | 25000 | 50000 | 50 | 1235 | 30000 | 60000 | 50 | 1236 | 35000 | 70000 | 50 | 1237 | 40000 | 80000 | 50 | <p>⑮ TIME 4 SECS.</p> | |
| <p>⑭</p> | <table border="0"> <tr> <td style="text-align: left;">Salesman</td> <td style="text-align: left;">Current</td> <td style="text-align: left;">Total</td> <td style="text-align: left;">Percent</td> </tr> <tr> <td style="text-align: left;">Number</td> <td style="text-align: left;">Sales</td> <td style="text-align: left;">Sales</td> <td style="text-align: left;">of Quota</td> </tr> <tr> <td></td> <td></td> <td style="text-align: left;">Year to Date</td> <td style="text-align: left;">Year to Date</td> </tr> <tr> <td style="padding-left: 20px;">1234</td> <td style="padding-left: 20px;">25000</td> <td style="padding-left: 20px;">50000</td> <td style="padding-left: 20px;">50</td> </tr> <tr> <td style="padding-left: 20px;">1235</td> <td style="padding-left: 20px;">30000</td> <td style="padding-left: 20px;">60000</td> <td style="padding-left: 20px;">50</td> </tr> <tr> <td style="padding-left: 20px;">1236</td> <td style="padding-left: 20px;">35000</td> <td style="padding-left: 20px;">70000</td> <td style="padding-left: 20px;">50</td> </tr> <tr> <td style="padding-left: 20px;">1237</td> <td style="padding-left: 20px;">40000</td> <td style="padding-left: 20px;">80000</td> <td style="padding-left: 20px;">50</td> </tr> </table> | Salesman | Current | Total | Percent | Number | Sales | Sales | of Quota | | | Year to Date | Year to Date | 1234 | 25000 | 50000 | 50 | 1235 | 30000 | 60000 | 50 | 1236 | 35000 | 70000 | 50 | 1237 | 40000 | 80000 | 50 | | | | |
| Salesman | Current | Total | Percent | | | | | | | | | | | | | | | | | | | | | | | | | | | | | | |
| Number | Sales | Sales | of Quota | | | | | | | | | | | | | | | | | | | | | | | | | | | | | | |
| | | Year to Date | Year to Date | | | | | | | | | | | | | | | | | | | | | | | | | | | | | | |
| 1234 | 25000 | 50000 | 50 | | | | | | | | | | | | | | | | | | | | | | | | | | | | | | |
| 1235 | 30000 | 60000 | 50 | | | | | | | | | | | | | | | | | | | | | | | | | | | | | | |
| 1236 | 35000 | 70000 | 50 | | | | | | | | | | | | | | | | | | | | | | | | | | | | | | |
| 1237 | 40000 | 80000 | 50 | | | | | | | | | | | | | | | | | | | | | | | | | | | | | | |
| <p>⑮ TIME 4 SECS.</p> | | | | | | | | | | | | | | | | | | | | | | | | | | | | | | | | | |

Figure 22. Example of Using Stored Program with Data Loaded from Tape.

The previous examples have illustrated the procedure involved to use old or stored programs. The following examples will be concerned with new programs, or programs that have not been previously stored in the computer. Figure 23 shows the manual on-line programming method, while Figure

24 illustrates a program which has been pre-punched in tape.

In Figure 23, steps 1 through 7 found in Figure 21 are repeated. In Figure 24, the same program has been stored in tape. Steps 1 through 11 are the same for both figures.

| | |
|---|--|
| 1 Dial Up | 1 Operator dials computer, using Modem. When tone signal is received, operator depresses DATA button. |
| 2 HELLO | 2 Operator types "HELLO" to establish contact with the computer. |
| 3 USER NUMBER 4 - B 12345..... | 3 Computer responds by requesting a user number. If an incorrect user number is entered, an automatic disconnect will generally be put into effect. |
| | 4 Operator enters user number and gains access to programs previously stored under this number only. |
| 5 PASSWORD 6 BRAMSJ | 5 Computer requests a password. If the password does not match the user number, the disconnect system will again be enforced. |
| 7 NEW OR OLD 8. NEW..... | 8 The operator has typed "NEW" indicating that a program is to be entered into the computer. |
| 9 NEW PROBLEM NAME 10. MULTPY..... | 9 The computer has requested a name for the new program. |
| | 10 The operator types the name, "MULTPY". |
| 11 READY..... | 11 The computer indicates that it is ready to accept the new program. |
| 12 10 LET A = 10..... 20 LET B = 12 30 LET C = A *B 40 PRINT C 50 END | 12 The operator enters the program - this program states the value of A as 10, and the value of B as 12, it then asks the computer to multiply these values and derive C. The next instruction tells the computer to print the value of C and finally, instruction 50 tells the computer that the program is finished. |
| 13 RUN..... | 13 The operator has told the computer to execute the program. If this were a program which would be used at a later time, the operator could have instructed the computer to STORE the program. |
| 14 120..... | 14 The computer prints the answer to the problem. (In this case, the value of C.) |
| 15 TIME 0 SECS..... | 15 Again, the computer prints the Central Processor Time used for this program. |

Figure 23. Example of New Program Manually Entered from Keyboard.

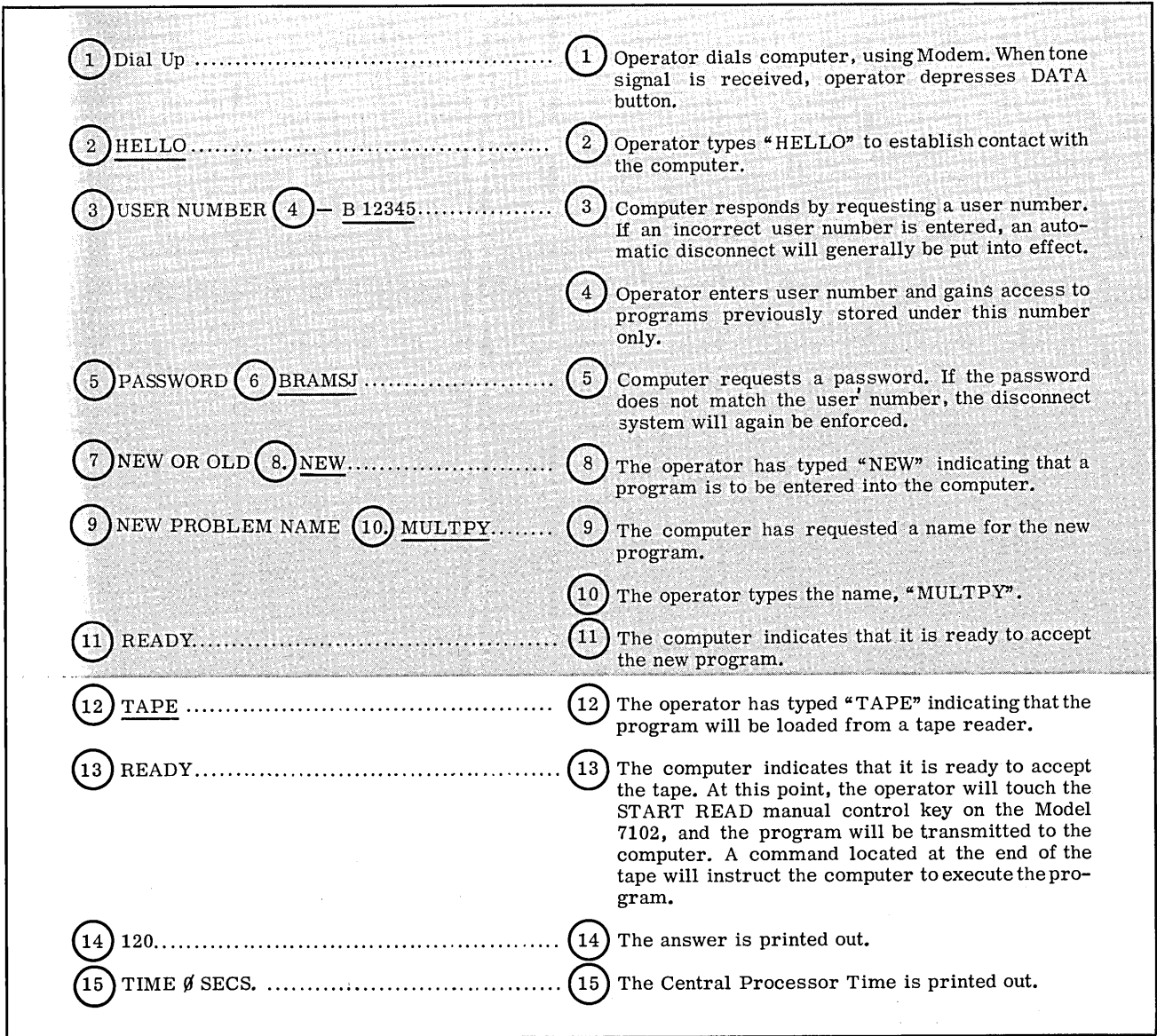
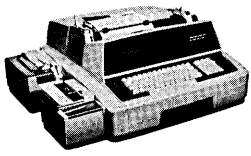
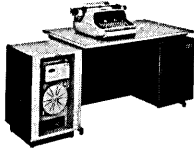
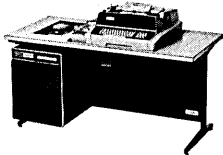
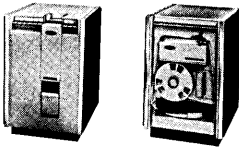
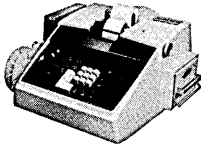

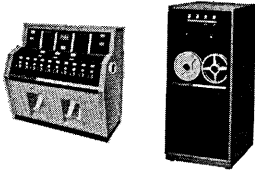



Figure 24. Example of New Program Loaded from Tape.

FRIDEN Products Designed for Practical . . .

| | |
|---|---|
|  | <p>FLEXOWRITER <i>automatic writing machine</i></p> |
| <p>5015 COMPUTYPER <i>writing/computing machine</i></p> |  |
|  | <p>5610 COMPUTYPER <i>data processor</i></p> |
| <p>AUXILIARY EQUIPMENT</p> |  |
|  | <p>ADD-PUNCH <i>adding machine/tape punch</i></p> |
| <p>7100 CONVERSATIONAL TERMINAL</p> |  |
|  | <p>COLLECTADATA <i>data collection network</i></p> |
| <p>CALCULATOR ADDING MACHINE</p> |  |

DATA PROCESSING EQUIPMENT

FLEXOWRITER* automatic writing machine produces documents while simultaneously perforating paper tapes or cards. Many models are available for specific data processing applications.

5015 COMPUTYPER* electronic billing/accounting machine is designed to accomplish a wide range of accounting operations. It is particularly geared to those applications that require fast, accurate computations, and the simultaneous output of printed information on a document.

5610 COMPUTYPER* data processor combines space age technology and English language programming to provide a revolutionary, low-cost billing/accounting center. It can handle the simplest and most complex billing applications, payroll, government reports, distribution, analysis and other important data processing tasks.

Wide variety of auxiliary, input/output units may be cable-connected to the FLEXOWRITER writing machine, the COMPUTYPER data processor or other FRIDEN equipment. These units facilitate greater application and programming flexibility.

ADD-PUNCH* adding machine/tape punch captures numeric data for automatic preparation of reports. This unit creates a printed tape as well as a punched paper tape for many applications.

7100 Conversational Terminal is a keyboard/printer communications terminal designed for time-shared computer systems. It can be used for direct on-line access to a central computer, or off-line as a typewriter.





COLLECTADATA* data collection network facilitates fast and accurate reporting from diverse points directly to a data collection center. This transmission and receiving system provides management with up-to-date information on plant operations at all times, thus allowing executive decisions to be based on events as they occur.

OFFICE PRODUCTS

FRIDEN Calculators and 10-key "natural-way" Adding Machines are leaders in their field. These easy-to-operate calculators come in a wide variety of rotary and electronic models for all business applications, large and small.

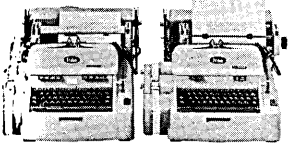
*A Trademark of Friden, Inc.

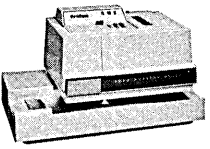
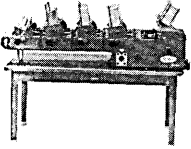
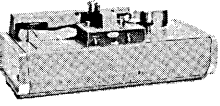
Application in Business and Industry

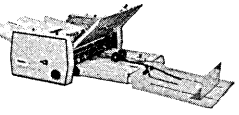
| | |
|---|---|
|  | <p>JUSTOWRITER <i>automatic composing machine</i></p> |
| <p>TAPE MERGER</p> |  |
|  | <p>8201 TAPE PERFORATOR</p> |
| <p>POSTAGE MACHINE</p> |  |
|  | <p>MAIL INSERTER</p> |
| <p>IMPRINTER <i>imprinting machine</i></p> |  |
|  | <p>POSTAL SCALES</p> |
| <p>FOLDING MACHINES</p> |  |

GRAPHIC ARTS EQUIPMENT

JUSTOWRITER* automatic composing machine produces justified (even margin) copy for duplicating or printing. This easy-to-operate machine is available in a variety of models that will provide an economical source of high-quality composition.

8303 Tape Merger accurately updates 5, 6, 7 or 8 channel tape for traditional coding used in cold type, phototype or data processing systems. An error-free tape is produced at 20 codes per second by merging an old tape and control tape. Minimum training is required.

The 8201 Tape Perforator is a solid state, "blind" perforator used to punch paper tape for computer input. A full keyboard and cable-connected tape punch provide means for maximum efficiency while perforating "endless" tape for computer typesetting programs.

MAILING EQUIPMENT

Postage Machine Model 9020 prints meter stamps on envelopes and seals flaps at the same time, or will perform either operation independently. A tape unit permits printing of meter stamps on wet or dry gummed tape for parcel post or bulky letter mail.

FRIDEN-Ertma mail inserter automatically gathers and stuffs into envelopes as many as eight different inserts; then seals, stacks and counts the envelopes ready for mailing.

Imprinter signs, endorses, cancels, counts, numbers, dates and imprints checks or other documents at high speed. These operations are performed economically; and safety is insured by the use of locked steel signature dies.

Postal Scales for every mailroom application, complement the FRIDEN mailroom and distribution system. There are seven different models, ranging in capacity from 20 ounces to 70 pounds, suitable for all mail handling systems. Sorting racks, mail bags, and unitized sealers and openers complete the line.

Folding Machines in all sizes perform the eight basic folds required by modern business. In addition, these machines can operate to score, perforate, and slit both paper and cardboard. One model can spot-glue and fold in one operation.

Friden
DIVISION OF **SINGER**
DIVERSIFIED • WORLDWIDE