

FEBRUARY 17, 1977

JAPAN BUILDS SEMICONDUCTOR DRIVE ON U.S. MARKET/72

Which data-terminal display: plasma panel or CRT?/91

A processor chip dedicated to complex computations/102

FOUR DOLLARS A MCGRAW-HILL PUBLICATION

Electronics®

1420 TCHDSB MCSA-SEP78
STATE TECHNICAL INST
FREEMAN LIBRARY 017823
5903 MACON COVE
MEMPHIS TN
36134

ISSCC

- Reprogrammable one-chip computer
- SOS microcomputer CPI
- One-chip Nova
- 5-V erasable PROM
- 14-bit A/D converter
- 50-MHz phase lock loop

**WHAT'S
COMING
IN SOLID
STATE**

the **DIP** **HIGH** **SIP**

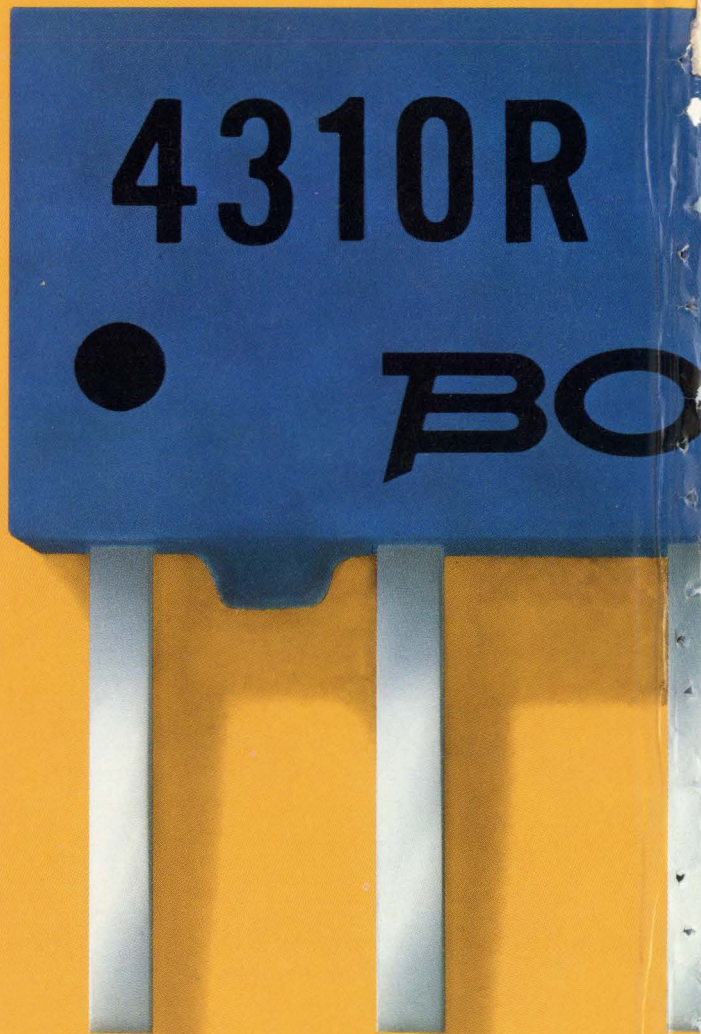

Now in the only full line of super low profile SIP Resistor Networks.

If you haven't designed in Single In-line Package resistor networks because of their high profile, take another look. THE HEIGHT ON BOURNS SIPs IS ONLY .190 INCH! And that's standard for all 6, 8 and 10 pin configurations with:

- 5, 7 or 9 resistors and 1 common pin
- 3, 4 or 5 isolated resistors
- 12 resistors, dual terminator (8 pin)

Now you can fit the same number of resistors into less area and yet maintain close P.C. Board spacing. Something you can't do when using other SIP networks with .250 or .350 inch high profiles.

And only Bourns SIPs offer the same reliable Krimp-Joint™ lead termination design as our DIP packages, high-copper alloy leads and uniform molded package design. With added features like MACHINE INSERTABILITY, COMPETITIVE PRICING AND DISTRIBUTOR AVAILABILITY —

Why specify other than Bourns?

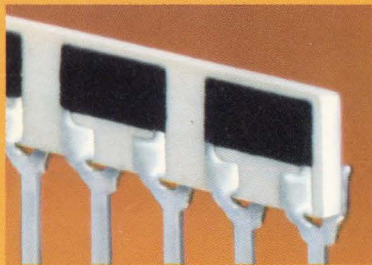

Bourns Krimp-Joint™ offers both a mechanical and electrical bond that lap or butt joint construction can't provide. The lead is crimped on the network element and a high-temp, reflow-resistant solder is used to prevent failure during wave soldering and in circuit thermal cycling and vibration.

FREE SIP and DIP SAMPLES!

Write on your company letterhead and let us know your requirements, we'll rush you a SIP or DIP resistor network sample and complete specifications.

TRIMPOT PRODUCTS DIVISION, BOURNS, INC., 1200 Columbia Avenue, Riverside, California 92507. Telephone 714 781-5415 — TWX 910 332-1252.

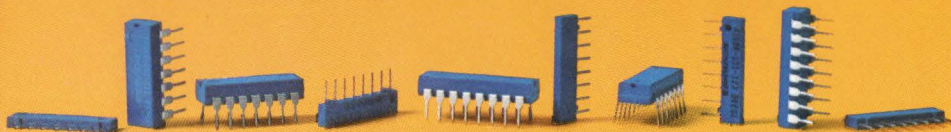

Int'l Sales Offices: European Hdqtrs. — Switzerland, 042/23 22 42 • Belgium 02/218 2005 • France 01/2039633 • Germany 0711/24 29 36
• Italy 02/32 56 88 • Netherlands 070/88 93 18 • United Kingdom 01/572 6531 • Japan 075 92 1121 • Australia 86 9410 • Brazil 257-3535

Circle 900 on reader service card

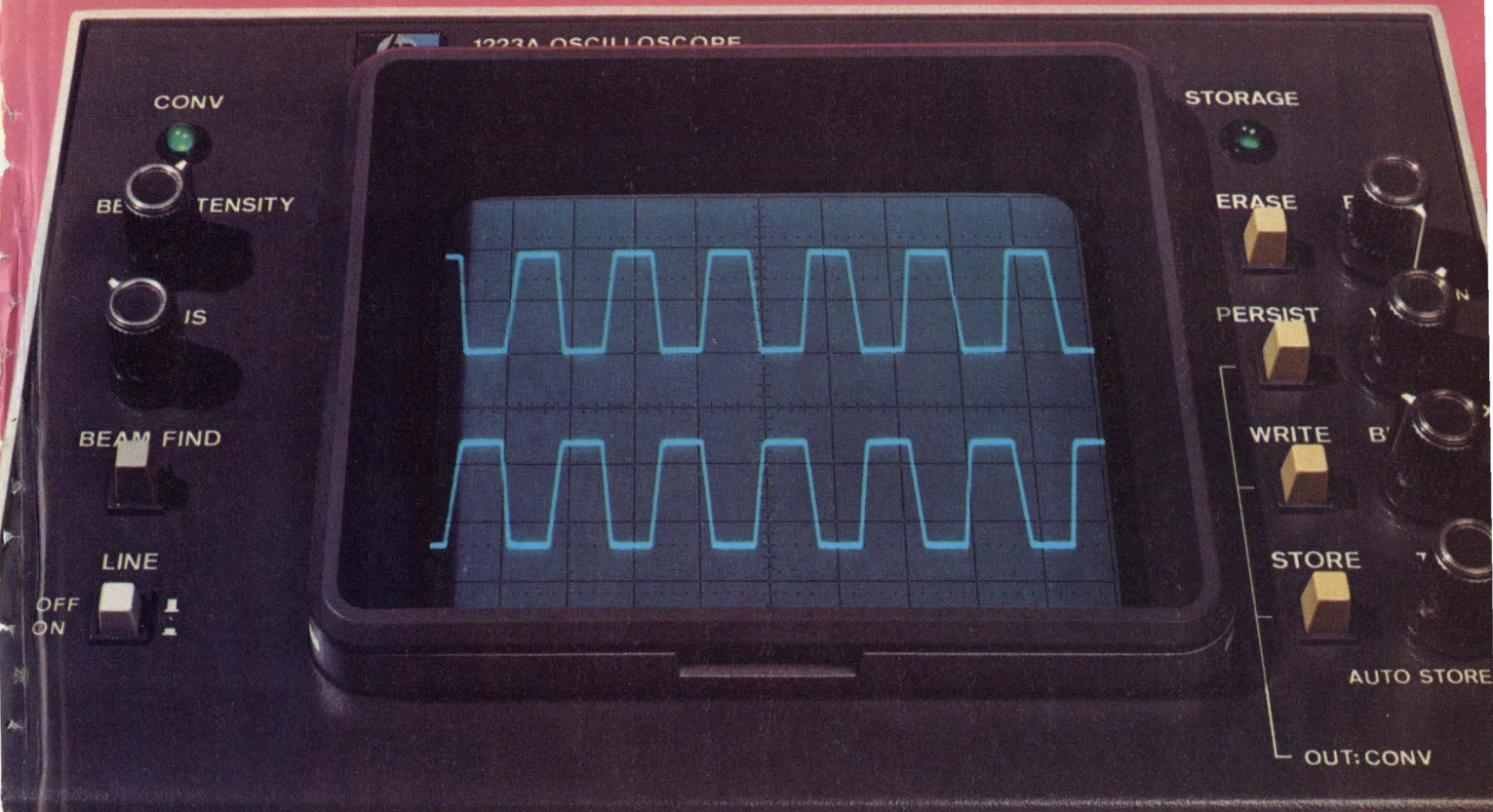

For a low cost way to capture fast transitions, glitches, low rep-rate signals and single-shot events...

HP's the Answer.

And the new **15MHz 1223A** with variable persistence/storage is your scope. Now, you don't need to pay for more capability than you need. Instead, you have the option of low-cost, variable persistence/storage scope that not only captures those elusive signals, but lets you see fast risetimes clearly for better glitch detection—something new for low-cost oscilloscopes. The 1223A provides variable persistence/storage and ease-of-use for only \$2250.*

Set it in Auto Store, walk away, and it's armed to capture and store an event for up to two hours. Vary the Brightness Control and you can optimize signal-to-background contrast. Vary the Persistence and you can integrate those glitches, very-low-frequency, and low-duty-cycle traces into clear displays or eliminate overriding noise. Adjust auto erase to the desired rate and you can update the



display without even touching the scope. Of course you can store a trace or erase a stored signal with the touch of a button.

And there's more: 2mV/div sensitivity, TV Sync, selectable chop/alternate sweep operation, variable trigger hold-off, and calibrated X-Y display. And you get traditional HP after-sale support.

Here's an economical answer for industrial lab and production applications such as electromechanical, industrial control and medical equipment design, testing and troubleshooting. Excellent capability at low-cost for education too. Your local HP field engineer has all the details. Give him a call today. In addition to the 1223A, ask him about the variable persistence/storage in a high-performance 100MHz scope—HP's new 1741A.

*Domestic U.S.A. price only.

HEWLETT  PACKARD

1507 Page Mill Road, Palo Alto, California 94304

For assistance call: Washington (301) 948-6370, Chicago (312) 255-9800, Atlanta (404) 955-1500, Los Angeles (213) 877-1282

Circle 1 on reader service card

0872

LOOK: Difficult Amplifier Tests Become Easy With The HP 8755/8620 Swept-Test System.

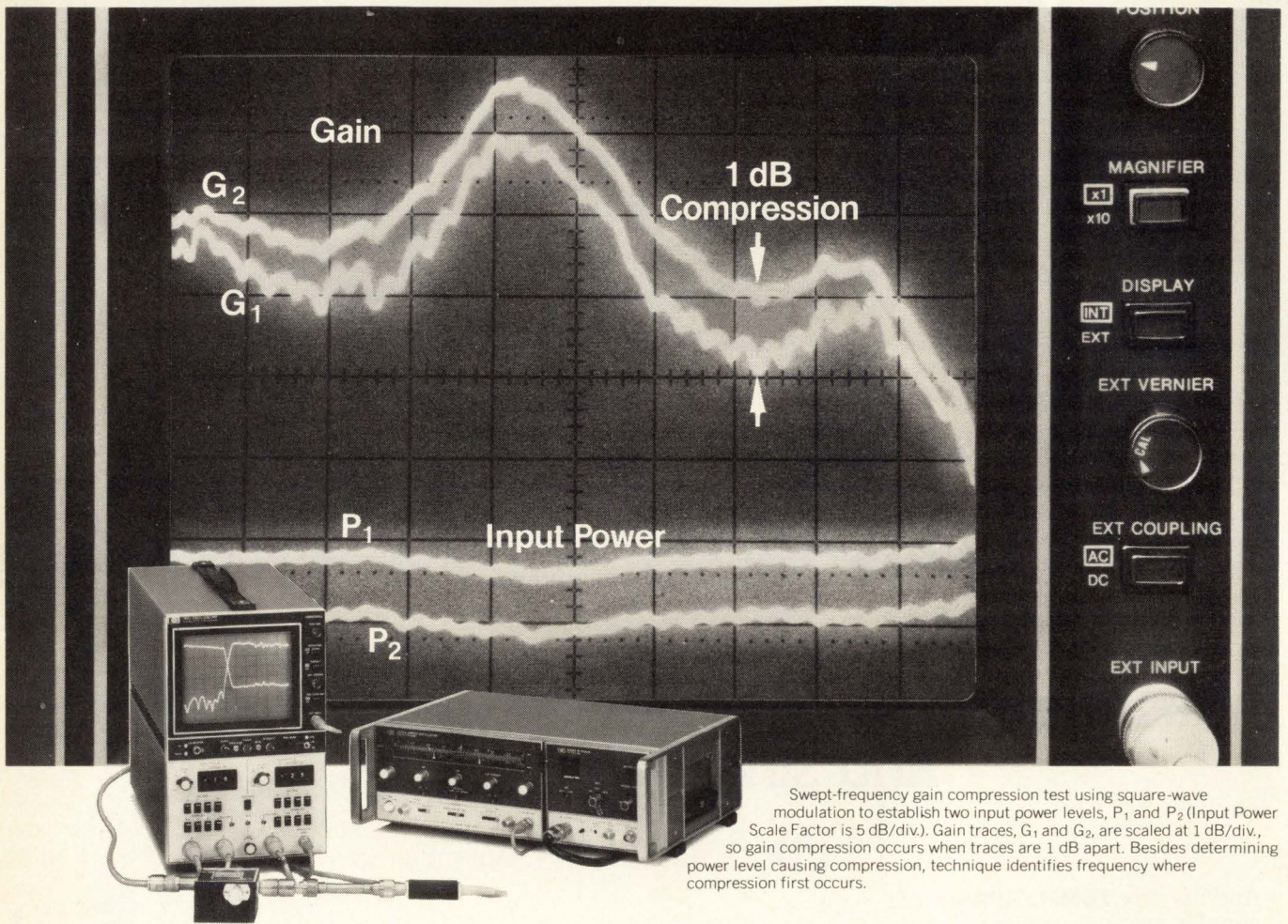

Swept-frequency gain compression test using square-wave modulation to establish two input power levels, P_1 and P_2 (Input Power Scale Factor is 5 dB/div.). Gain traces, G_1 and G_2 , are scaled at 1 dB/div., so gain compression occurs when traces are 1 dB apart. Besides determining power level causing compression, technique identifies frequency where compression first occurs.

Use HP's 8755 Frequency Response Test Set and the HP 8620C Sweeper to make swept frequency measurements of gain, gain vs. power, gain compression and harmonics of amplifiers and other active devices. Our new Application Note (AN 155-1), yours for the asking, tells you how. The 8755 has two-channel ratio-ing capability with 60 dB dynamic range and 15 MHz-18 GHz coverage. And HP's single-band 86200 Series plug-ins for the 8620C Sweeper have the power to make saturation tests. For example, two new plug-ins deliver an unprecedented 50 mW, 5.9-9.0 GHz and 8.0-12.4 GHz.

Then for testing wideband passive devices, use HP's multi-octave sweeper plug-ins (HP 86222 covering 10 MHz-2.4 GHz and 86290A from 2-18 GHz) with the 8755 Test Set and its broadband measuring accessories. These include

a 40 MHz-18 GHz Reflectometer Bridge with > 26dB directivity at 18 GHz for reflection measurements, and a dc-18 GHz Power Splitter with ± 0.25 dB tracking for accurate transmission measurements.

The 8755 and the 8620C form the ideal system for testing a wide range of both active and passive microwave devices — a practical answer to both your narrowband and broadband measurement needs.

Ask your HP field engineer for details, or write.

HEWLETT  PACKARD

Sales and service from 172 offices in 65 countries.
1507 Page Mill Road, Palo Alto, California 94304

29 Electronics Review

SOLID STATE: Intel readies a 16,384-bit erasable PROM, 29
MILITARY: Early warning OTH radar takes shape in Maine, 30
Electronics for NATO's Awacs worth \$300 million, 31
CONSUMER: Microprocessor takes on chess players in \$200 game, 32
Battle over home video-tape-recorders moves into the U.S., 34
MEDICAL: X-ray system gets digital controller, 34
MILITARY: Slight cut leaves Tomahawk unhurt, 36
MEMORIES: Bell installs its first bubble memory, 38
COMPUTERS: Personal computer fleshes out usual bare bones, 38
NEWS BRIEFS: 40

55 Electronics International

EUROPE: Fairchild launches consumer-electronics push, 55
AROUND THE WORLD: 55
WEST GERMANY: Auto collision-avoidance systems being tested, 56
Traffic-news decoder for cars undercuts competition at \$36, 56

65 Probing the News

DISPLAYS: Gas-discharge-display sales soar, 65
ELECTRONICS ABROAD: Sluggish Sweden is key to Scandinavia, 69
SEMICONDUCTORS: Japanese have Americans worried, 72
YOU AND YOUR CAREER: New IEEE head casts wide net for ideas, 74
SPACE ELECTRONICS: Satellite makers scramble for business, 78

81 Technical Articles

SPECIAL REPORT: What's new at ISSCC, 81
Microprocessors, memories dominate digital sessions, 82
Converters, system-like chips spearhead linear progress, 85
COMPUTERS: Which data-terminal display: plasma panel or CRT? 91
DESIGNER'S CASEBOOK: Two 555 timers build discriminator, 98
Analog current switch makes gain-programmable amplifier, 99
MICROPROCESSORS: Mathematics is easy for Number Cruncher, 102
INSTRUMENTS: Exercising functional structure of microprocessors, 109
ENGINEER'S NOTEBOOK: Test finds resistor power capability, 113
CALCULATOR NOTES: Sequence timer gives audible alarm, 114

119 New Products

IN THE SPOTLIGHT: LSI chip programs most CRT functions, 119
Tester checks entire microcomputer at its operating speed, 123
INSTRUMENTS: 3½-digit phase meter is priced at \$795, 126
SUBASSEMBLIES: Sample-and-hold amplifier switches fast, 133
MICROWAVE: Uhf transistor offers flat gain over wide band, 142
INDUSTRIAL: Digital thermometer sells for \$189, 148

Departments

Publisher's letter, 4
Readers' comments, 6
Editorial, 12
People, 14
Meetings, 20
Electronics newsletter, 25
Washington newsletter, 47
Washington commentary, 48
International newsletter, 53
Engineer's newsletter, 116
New literature, 154

Services

Reprints available, 143
Employment opportunities, 156
Reader service card, 167

Cover: ISSCC features wealth of new devices, 81

There is something for everyone at this week's International Solid State Circuits Conference: new microprocessors, new memories, new linears. The conference papers also will report on the technologies behind them, such as V-notch isolation and mixed metal-oxide-semiconductor and bipolar processes.

Art Director Fred Sklenar designed the cover.

Japanese hike U.S. semiconductor effort, 72

The American semiconductor market—particularly the computer segment—is feeling the effects of Japanese technological advances. Key U.S. executives expect competition to strengthen.

Making the choice: plasma panel or CRT, 91

Cathode-ray tubes have long been the leading choice for computer-terminal displays, but integrated circuitry is making gas-discharge types more cost-competitive. A hard look at the tradeoffs will help decide which type suits a particular task.

Tough math is child's play for new chip, 102

When it comes to complex mathematical computations, general-purpose microprocessors don't shine. But a new chip includes most of the necessary calculation software for stand-alone tasks and for extending the processing power of minicomputers and microcomputers.

And in the next issue . . .

A new approach to digital troubleshooting . . . thin-film magnetic heads are here . . . the arrival of a high-capacity erasable programmable read-only memory.

EDITOR-IN-CHIEF: Kemp Anderson

EXECUTIVE EDITOR: Samuel Weber

MANAGING EDITOR: Arthur Erikson,
International

SENIOR EDITORS: Laurence Altman,
Ray Connolly, Lawrence Curran,
John Johnsrud, H. Thomas Maguire,
Stephen E. Scrupski, Gerald M. Walker

ART DIRECTOR: Fred Sklenar

ASSOCIATE EDITORS: Howard Wolff,
Alfred Rosenblatt

DEPARTMENT EDITORS
Aerospace/Military: Ray Connolly
Circuit Design: Raymond P. Capece
Communications & Microwave:
Richard Gundlach
Components: Lucinda Mattera
Consumer: Gerald M. Walker
Industrial: Raymond P. Capece
Instrumentation: Stephen E. Scrupski
New Products: H. Thomas Maguire,
Michael J. Riezenman
Packaging & Production: Jerry Lyman
Solid State: Laurence Altman

CHIEF COPY EDITOR: Margaret Eastman

COPY EDITORS: Everett C. Terry, Ben Mason

ART: Charles D. Ciatto, *Associate Director*
Paula Piazza, *Assistant Director*

EDITORIAL SECRETARIES: Janet Noto,
Penny Rothman, Marilyn B. Rosoff

FIELD EDITORS
Boston: Lawrence Curran (Mgr.), Pamela Leven
Los Angeles: Larry Waller (Mgr.)
Midwest: Larry Armstrong (Mgr.)
New York: Bruce LeBoss (Mgr.)
San Francisco: Bernard Cole (Mgr.)
Judith Curtis
Washington: Ray Connolly (Mgr.)
Frankfurt: John Gosch
London: William F. Arnold
Paris: Arthur Erikson
Tokyo: Charles Cohen

McGRAW-HILL WORLD NEWS
Editor: Michael Johnson
Brussels: James Smith
Milan: Andrew Heath
Moscow: Peter Gall
Paris: Joel Stratte-McClure
Stockholm: Robert Skole
Tokyo: Colin Gibson

PUBLISHER: Dan McMillan

ADVERTISING SALES MANAGER:
Paul W. Reiss

MARKETING ADMINISTRATION MANAGER:
Wallis Clarke

CIRCULATION MANAGER: Karl Peterson

MARKETING SERVICES MANAGER:
Tomlinson Howland

RESEARCH MANAGER: Margery D. Sholes

The workhorse cathode-ray tube has served long and well in many electronic jobs and still is the favorite for computer-terminal displays. But, points out Interstate Electronics' Lester Turner, the gas-discharge plasma panel is the odds-on challenger, thanks to developments in such areas as driver circuitry and microprocessors. What's more, the plasma panel is really just starting out on its growth curve, and the years ahead should see some fairly dramatic cuts in plasma-terminal costs. You'll find a valuable comparison of plasma panels vs CRTs in Turner's article, which begins on page 91.

Improving display quality with plasma terminals is a satisfying job to Turner, who says he has "spent too many hours squinting at CRTs." His near-lifelong interest in communications goes back to a boyhood in Brooklyn, where his father ran a radio-TV store. At 10, he strung a wire telegraph system on trees in his block, so he and his pal could communicate without anyone overhearing. "When the tree-trimmers cut the wires down, we had them back up before their backs were turned," he recalls.

Turner's penchant for electronic tinkering lives on, he says, describing a recent challenge given him by a doctor who wanted to monitor heart-rate data on an ambulatory patient but not to pay the \$1,000 going rate for units designed for this task. Turner put together a transistor-radio-sized unit that works just as well for about \$150.

Microprocessors are, in many ways, in a world apart from traditional electronic components, and testing

them requires going into something of a new world, too. For example, a test of each instruction in the processor's instruction set may indicate that everything is fine, but how do you determine if a syntactically correct combination of instructions will be carried out correctly without trying all the millions of combinations?

For Douglas H. Smith, who on page 109 describes Tektronix' pioneering test method, called Wisest, such a question reflects a much wider problem: the way engineers think is lagging behind the technologies they employ.

He calls microprocessor testing a classic case in point, and the approach he outlines in his article is one he hopes other engineers can use with profit. "First we know that the qualities—power and flexibility—which make microprocessors attractive to use also make them difficult to test. Second, it should be obvious that the old testing methods simply aren't conceptually adequate for the new devices. And third, we know what we want. Our goal is 100% accuracy in sorting good microprocessors from bad in a minimum amount of time."

He concludes: "Of course, each of us has to define what we mean by 100%, good, bad, and minimum amount of time. So it seems the first logical step is to develop an appropriate test philosophy and then to create the proper test procedures."

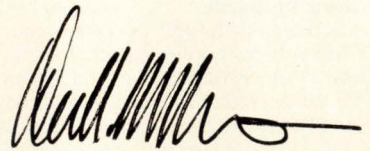

February 17, 1977 Volume 50, Number 4 94,874 copies of this issue printed

Published every other Thursday by McGraw-Hill, Inc. Founder: James H. McGraw 1860-1948. Publication office 1221 Avenue of the Americas, N.Y., N.Y. 10020; second class postage paid at New York, N.Y., and additional mailing offices.

Executive, editorial, circulation and advertising addresses: Electronics, McGraw-Hill Building, 1221 Avenue of the Americas, New York, N.Y. 10020. Telephone (212) 997-1221. Teletype (212) 796-TWX 710-581-4879. Cable address: MCGRAW HILL L N E W Y O R K.

Subscriptions limited to professional persons with active responsibility in electronics technology. No subscriptions accepted without complete identification of subscriber name, title or job function, company or organization, and product manufactured or services performed. Based on information supplied, the publisher reserves the right to reject non-qualified requests. Subscription rates: in the United States and possessions \$14.00 one year, \$35.00 one year, \$50.00 three years; company addressed and company libraries \$20.00 one year, \$50.00 three years; APO/FPO addressed \$35.00 one year only; Canada and Mexico \$16.00 one year, \$40.00 three years; Europe \$40.00 one year, \$100.00 three years; Japan, Israel and Brazil \$65.00 one year, \$165 three years; Australia and New Zealand \$90.00 one year, \$240 three years, including air freight; all other countries \$45.00 one year, \$112.00 three years. Limited quota of subscriptions available at higher-than-basic rate for persons allied to field served. Check with publisher for these rates. Single copies: \$4.00. Please allow four to eight weeks for shipment.

Officers of McGraw-Hill Publications Company: Gordon L. Jones, President; Paul F. McPherson, Executive Vice-President; Group Vice-President, Gene W. Simpson; Senior Vice-Presidents: John B. Hoglund, Controller; David G. Jensen, Manufacturing; Ralph R. Schulz, Editorial; Vice-Presidents: James E. Boddorf, Planning & Development; Robert L. Leyburn, Circulation; Edward E. Schirmer, Sales.

Officers of the Corporation: Harold W. McGraw, Jr., President, Chief Executive Officer, and Chairman of the Board; Robert N. Landes, Senior Vice President and Secretary; Ralph J. Webb, Treasurer.

Title registered in U.S. Patent Office; Copyright © 1977 by McGraw-Hill, Inc. All rights reserved. The contents of this publication may not be reproduced in whole or in part without the consent of copyright owner.

Subscribers: The publisher, upon written request to our New York office from any subscriber, agrees to refund that part of the subscription price applying to copies not yet mailed. Please send change-of-address notices or complaints to Fulfillment Manager; subscription orders to Circulation Manager, Electronics, at address below. Change-of-address notices should provide old as well as new address, including postal zip code number. If possible, attach address label from recent issue. Allow one month for change to become effective.

Postmaster: Please send form 3579 to Fulfillment Manager, Electronics, P.O. Box 430, Hightstown, N.J. 08520.

who says- switch-mode (25 kHz) power supplies are only cost-effective at high power?

we've got some great switchers in the under 200 watt class that offer you small size, high efficiency and light weight at a really affordable price!

size **A**
\$179.00

2 7/16" x 5 1/8" x 7 1/2"
Weight: 3 lbs.

MODEL	NOMINAL OUTPUT VOLTAGE*	OUTPUT CURRENT				
		30°C	40°C	50°C	60°C	71°C
RMK 05-A	5V	12.0 A	10.8 A	10.0 A	8.3 A	5.0 A
RMK 09-A	9V	7.6 A	6.8 A	6.0 A	5.2 A	2.7 A
RMK 12-A	12V	6.3 A	5.6 A	5.0 A	4.3 A	2.0 A
RMK 15-A	15V	5.0 A	4.5 A	4.0 A	3.4 A	1.7 A
RMK 24-A	24V	3.2 A	2.8 A	2.5 A	2.2 A	1.0 A



size **B**
\$259.00

3 3/32" x 5 1/8" x 8 3/4"
Weight: 4.75 lbs.

MODEL	NOMINAL OUTPUT VOLTAGE*	OUTPUT CURRENT				
		30°C	40°C	50°C	60°C	71°C
RMK 05-B	5V	36.0 A	34.0 A	26.0 A	17.0 A	9.0 A
RMK 09-B	9V	20.0 A	17.0 A	15.0 A	10.0 A	5.2 A
RMK 12-B	12V	16.6 A	15.0 A	12.0 A	8.0 A	4.2 A
RMK 15-B	15V	13.3 A	13.3 A	10.2 A	6.2 A	3.3 A
RMK 24-B	24V	8.5 A	8.5 A	7.5 A	4.7 A	2.3 A

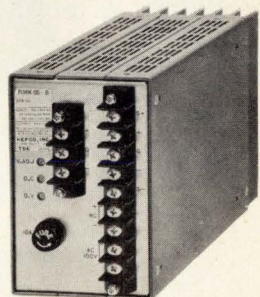

size **C**
\$299.00

4 1/16" x 5 1/8" x 8 3/4"
Weight: 5.25 lbs.

MODEL	NOMINAL OUTPUT VOLTAGE*	OUTPUT CURRENT				
		30°C	40°C	50°C	60°C	71°C
RMK 05-C	5V	40.0 A	38.0 A	30.0 A	21.5 A	14.0 A
RMK 09-C	9V	22.0 A	22.0 A	17.2 A	12.5 A	7.7 A
RMK 12-C	12V	17.0 A	17.0 A	14.6 A	10.5 A	5.8 A
RMK 15-C	15V	14.0 A	14.0 A	12.3 A	8.3 A	4.7 A
RMK 24-C	24V	9.0 A	9.0 A	8.0 A	5.5 A	3.0 A

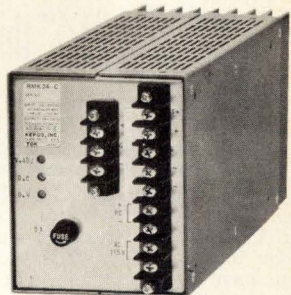

*Adjustable $\pm 10\%$, you may order them to be factory-set anywhere in the range -30% to +10% of the nominal.

KEPCO series RMK are the product of a KEPCO/TDK joint venture. They employ advanced digital signal processing for a low parts population (enhancing reliability) and advanced TDK ferrites for efficiency and low noise. RMK are burned in for 48 hours at +55°C to insure delivery to you of a reliable, trouble-free power supply. We back that with a 5-year Warranty! . . . the same warranty offered on our fine linear and ferroresonant models. Call Kepco collect : (212) 461-7000 and arrange for a demo right in your own shop!



KEPCO®

For complete specifications, write Dept. FL-14

KEPCO, INC. • 131-38 SANFORD AVENUE • FLUSHING, N.Y. 11352 U.S.A. • (212) 461-7000 • TWX #710-582-2631 • Cable: KEPCOPOWER NEWYORK

Electronics/February 17, 1977

Circle 5 on reader service card 5

A SMART WAY TO BEAT YOUR POWER SUPPLY SIZE PROBLEM

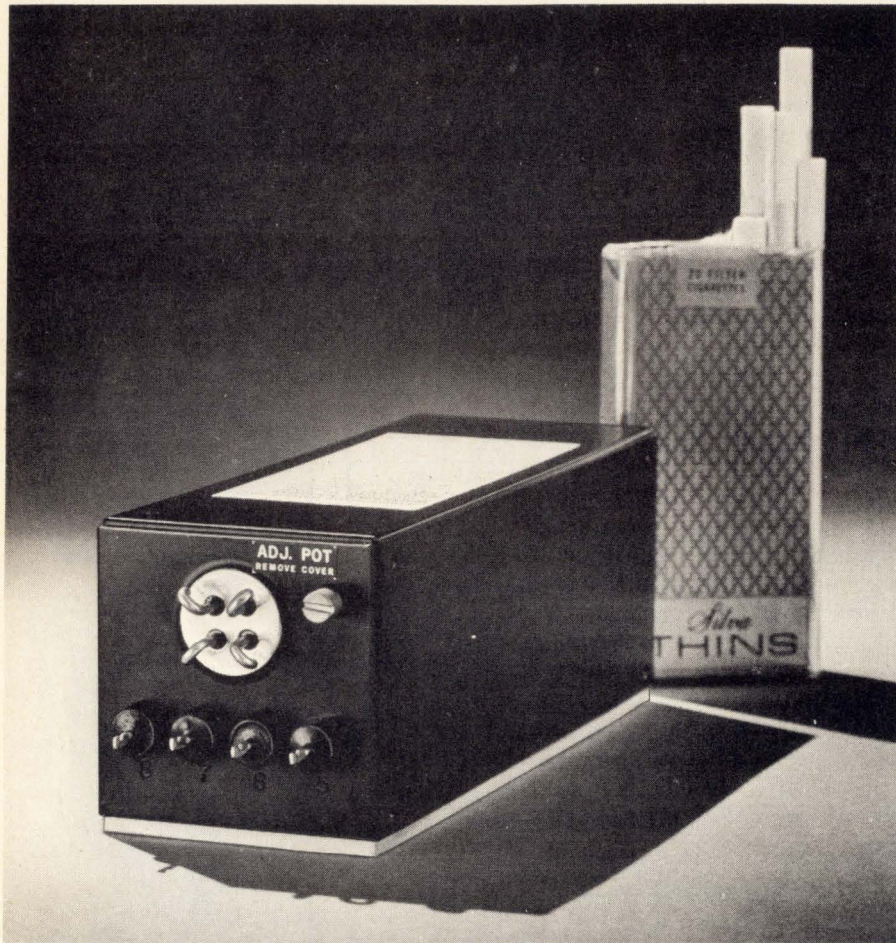

2 1/2" thin, 2 3/8" narrow, 6 1/4" short

yet this converter produces 50 watts of regulated DC power from an input of 20-32 VDC! It weighs less than 2 pounds. This is only one of our wide variety of many small lightweight converters, inverters and power supplies — there are over 3500 models listed in our newest catalog, including size, weight, and prices. If you have a size problem, why not send for an Abbott catalog?

MIL SPEC ENVIRONMENT — All of the hermetically sealed power modules listed in our new catalog have been designed to meet the severe environmental conditions required by modern aerospace and military systems, including MIL-STD-810C. They are hermetically sealed and encapsulated in heavy steel containers. New high performance units meet MIL-

STD-461A for conducted and radiated electromagnetic interference.

RELIABLE — Highest quality components are used in Abbott power modules to yield high MTBF's (mean time between failure) as calculated in MIL-HDBK-217. Typical power modules have over 100,000 hours MTBF — proving that the quality was built in from the beginning.

WIDE RANGE OF OUTPUTS — Any voltage from 5 volts DC to 740 VDC is available by selecting the correct model you need from our catalog with any of a variety of inputs including:

60 \sim to DC
400 \sim to DC
DC to DC
DC to 400 \sim
DC to 60 \sim

Please see pages 1836-1848 of your 1976-77 EEM (ELECTRONIC ENGINEERS MASTER Catalog) or pages 676-682 Volume 2 of your 1976-77 GOLD BOOK for information on Abbott Modules.

Send for our new 60 page FREE catalog.

abbott transistor
LABORATORIES, INCORPORATED

GENERAL OFFICES
5200 W. Jefferson Blvd.
Los Angeles, CA 90016
(213) 936-8185
Telex 69-1398

EASTERN OFFICES
1224 Anderson Ave.
Fort Lee, NJ 07024
(201) 224-6900
Telex 13-5332

Readers' comments

Ins and outs of pulling in relays

To the Editor: The circuit for reducing relay-power requirements [Dec. 9, p. 113] would not need a nonpolarized capacitor if a diode replaced R_2 , the 680-ohm resistor. Then if the diode's cathode is connected to ground, a standard electrolytic capacitor can be used, with its positive terminal going to the collector of the transistor.

Joe Buswell
Midwest City, Okla.

■ **Milton H. Crothers**, associate professor of electrical engineering at the University of Illinois, Champaign-Urbana, corroborates. Replacing R_2 with the diode results in a final voltage across the capacitor of $V_C = V_{CE(SAT)} - V_D$, where $V_{CE(SAT)}$ is the on voltage of the transistor and V_D is the diode drop. If V_C results in a slight reverse voltage that may be undesirable, the addition of a diode to the emitter leg of the transistor will offset the difference.

He adds that this modification also serves to increase the holding current from 8.7 milliamperes to 16 mA, decreasing the chance of contact release under vibration or shock.

To the Editor: The Dec. 9 Engineer's notebook on relay actuation claims that power can be saved by using a voltage-adding circuit. This is true, but there are definite pitfalls to avoid and tradeoffs to accept.

First, the time constant of the circuit must be sufficient to assure complete actuation of the relay armature and contacts. The circuit as shown has a time constant of only about 5 milliseconds—not long enough for a relay where pickup time may be 15 or 20 ms.

Second, the criticalness of the time constant depends on the circuit being switched. Opening a 20-ampere circuit with normally closed contacts requires full power during a good portion of the actuation time in order to quickly break the arc. For a 15-ms relay, 5 (or even 10) ms of full power may not be enough.

The major tradeoff with reduced relay holding power is that the contacts will open more easily under conditions of shock or vibration than

PMI announces the new 108A.

Do you want to know the real inside story of our new 108A/308A precision low power op amp? Here it is, without names in order to protect our customer. Fact is, this customer came to us and asked if we could make some 108A's that met 108A specs. We tried and couldn't. But we found out why nobody else could, either; it was simply designed wrong.

So we redesigned it as a 108A. Corrected the unbalance which caused the high TCV_{OS} . Gave it our zener zap treatment. Plus ion implantation. And the kind of pricing high volume production parts deserve.

Result? Check with your distributor. He has 108A's on his shelf right now. And they work. Up to MIL-M-38510/101D-04 specs.

Processed to MIL-STD-883A Level B.
 V_{OS} 0.5mV Max.;
 TCV_{OS} $5\mu V/^{\circ}C$ Max.

Just ask for it by name: PMI's new 108A/308A. The one that works.

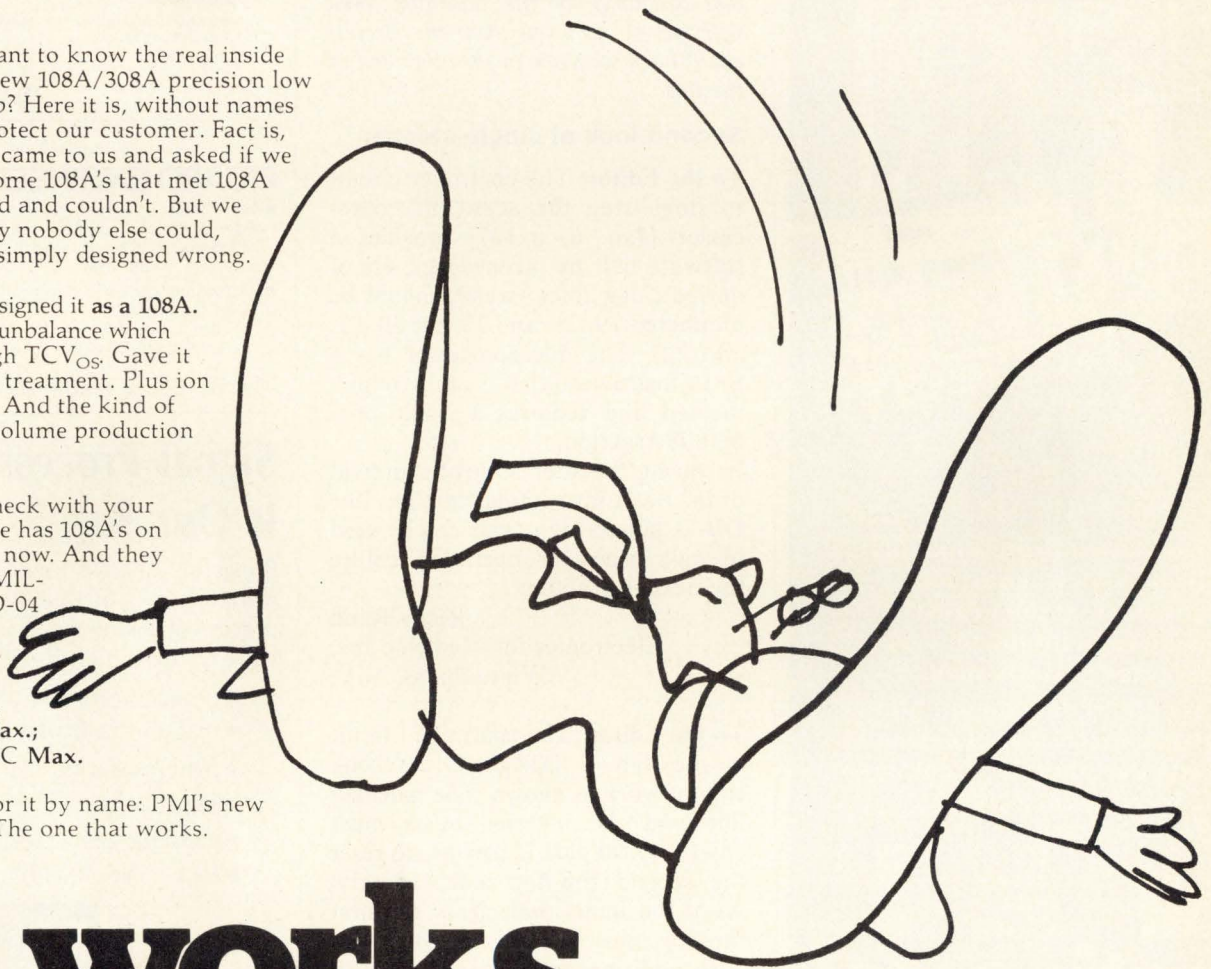

It works.



Precision Monolithics, Incorporated
1500 Space Park Drive, Santa Clara, CA 95050
(408) 246-9222. TWX: 910-338-0528
Cable MONO.

Get the scope you need-Now!

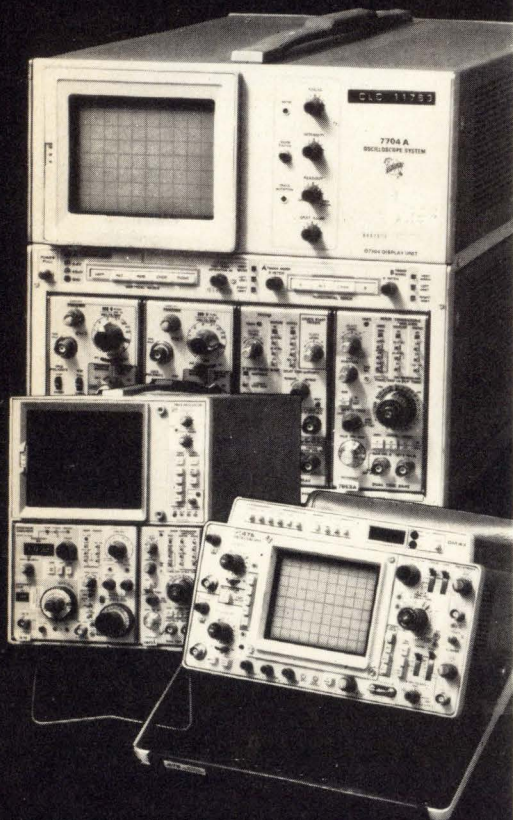

Our "Instrument Professionals" will tell you which scope will do the job best, at the lowest cost, make immediate delivery and guarantee performance.

Write or call for data on our other specialties: Instrument Leasing • Computer Peripherals • Equipment Sales • Instrument Service.

Circle 8 on reader service card

Call Continental Rentals

Div. Continental Leasing Co., Inc.
175 Middlesex Turnpike, Bedford,
MA 01730 (617) 275-0850

FOR IMMEDIATE RESPONSE CALL:
N.E. (617) 275-0850; L.I. (516) 752-1622;
NY, NJ (201) 654-6900;
Gtr. Phila. (609) 234-5100;
Wash., D.C. area (301) 948-4310;
Mid West (312) 439-4700;
So. Central (214) 690-1706;
Costa Mesa, CA (714) 540-6566;
L.A., CA (213) 477-7521;
Santa Clara, CA (408) 735-8300

Get our
FREE
Catalog



Readers' comments

when full power is applied to the relay coil.

The one sure way to conserve power is to use a latching relay. Once it is latched, power may be removed completely.

Patrick M. Craney
Potter & Brumfield Div., AMF Inc.
Princeton, Ind.

■ *A final word of caution from Hans Dankerl at the American Embassy, APO New York 02953: best avoid the circuit altogether when the relay contacts are switching lethal voltages. An inadvertent discharge of the capacitor (even with power removed from the circuit) could burn someone at the other end of the line.*

Second look at single-stepper

To the Editor: The controller circuit to single-step the SC/MP microprocessor [Jan. 6, p. 107] provides a software halt by inconvenient use of device's flag lines (which should be numbered 19, 21, and 22, not 20, 21, and 22). The microprocessor has a HALT instruction that is easily implemented and requires a single one-byte instruction.

During the address-strobe interval of the HALT instruction, data bus line DB₇ is pulsed high. This can be used to halt processor operation before the next instruction.

Ricky Rand
Electronics for Medicine Inc.
White Plains, N.Y.

To the Editor: The controller circuit in the Jan. 6 Designer's casebook cannot work as shown. The halt flag line and the inverted NADS must enter an AND gate if they are to reset the second flip-flop independently. Also, the input that clears the first flip-flop must be the inverted NADS.

In addition, good design practice dictates that mechanical switches should bring transistor-transistor-logic inputs to ground. If the mode switch were rearranged to this configuration, the unnecessary 22 milliamperes flowing through the 220-ohm resistor in either stepping mode could be avoided. Pullup resistors of 6.8 kilohms would suffice.

James A. Kuzdrall
Candia, N.H.

Gas Sensing Semiconductor

FIGARO TGS GAS SENSOR

quickly senses
even small
amount
of gas.

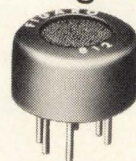
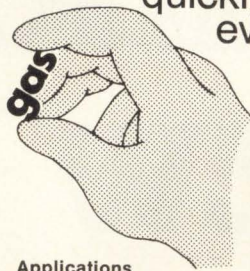

Applications

1. Natural Gas-Leak Alarm
2. Propane Gas-Leak Alarm
3. Carbon Monoxide Detector
4. Automatic Fan Control
5. Fire Alarm (Detecting combustible gases contained in smoke)
6. Alcohol Detector (Detector for drunken driver)
7. Air Pollution Monitor

Please contact any of the addresses below directly for catalogs and price/delivery information.

FIGARO ENGINEERING INC.

● **Head Office:** 3-7-3 Higashitoyonaka, Toyonaka City, Osaka, 560, JAPAN TELEX: 05286155 FIGARO J CABLE: FIGARO TOYONAKA TEL: (06) 849-2156

● **North America:** 3303 Harbor Boulevard, Suite D-8, Costa Mesa, California 92626, U.S.A. TELEX: 678396 CABLE: FIGARENGIN COSTAMESA TEL: (714) 751-4103

Circle 168 on reader service card

Signal Processing Is Our Bag

Princeton Applied Research, a leading manufacturer of sophisticated signal processing instruments, invites you to write or call for information on:

- low noise preamplifiers
- real time spectrum analyzers
- light measuring instrumentation
- signal averagers
- capacitance-voltage (CV) plotters
- lock-in amplifiers

Send for your free copy of our new catalog.

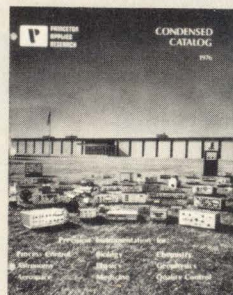

Princeton Applied
Research Corporation
P.O. Box 2565
Princeton, N.J. 08540
Phone: 609/452-2111

For additional information only circle 170
Circle 169 on reader service card

In high-voltage CMOS designs...

To B or to UB? RCA COS/MOS helps with the answer.

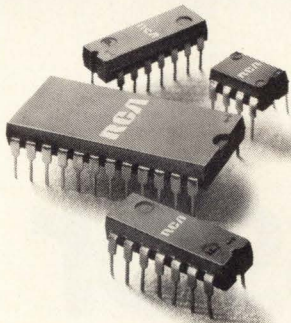

Not all B-Series CMOS is buffered — that's why there's a UB suffix. RCA experience shows that certain designs call for a buffered gate, but in others, unbuffered is better. Only the designer is in a position to decide.

That's why we offer you both. To JEDEC specs. With COS/MOS you don't have to worry about non-interchangeability of "B" devices in applications where speed, noise immunity, output impedance and linear gain-bandwidth characteristics are critical. As the table shows, you can select the COS/MOS option that does what you want in the environment to be faced — without having to add components or compromise on system performance.

Get the RCA B-Series Product Guide from your Solid State distributor. Or RCA.

Which COS/MOS option is best for your design?

Requirement/environment	Buffered	Unbuffered
High speed		x
Ultra-low frequency		x
High freq., moderate gain, linear amplification		x
High-noise environment, low-speed system	x	
Constant output impedance	x	
Low freq., high gain, linear amplification	x	

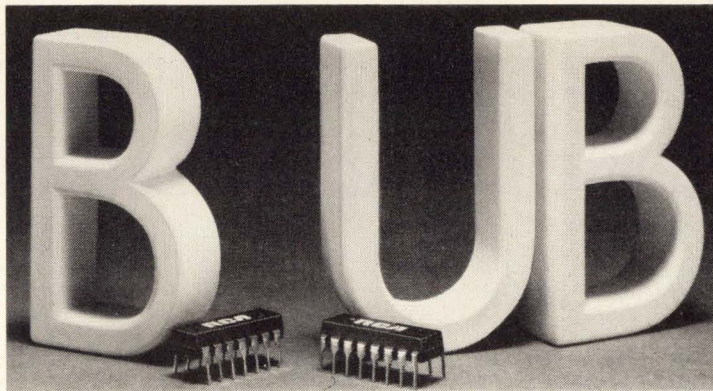

Buffered B Unbuffered B

CD4000B	CD4000UB
CD4001B	CD4001UB
CD4002B	CD4002UB
CD4011B	CD4011UB
CD4012B	CD4012UB
CD4023B	CD4023UB
CD4025B	CD4025UB

Write: RCA Solid State, Box 3200, Somerville, NJ 08876; Sunbury-on-Thames, Middlesex TW16 7HW, England; Ste-Anne-de-Bellevue, Quebec, Canada; Fuji Bldg., Tokyo, Japan.

RCA COS/MOS experience is working for you.

The Microprocessor Buyer's Guide.

(From the people who brought
you the Buyer's Market.)

Advanced Micro Devices, the people who made it easy for you to get into microprocessing, make it even easier with this one-page, scrupulously objective buyer's guide.

One.

The best way to make a microprocessor system is the 8080 way. It's the most popular architecture; it has the best support. The flexibility, the upgrade capabilities are better than any other microprocessor.

Two.

The best 8080A is a 9080A. Look:

Ours and Theirs.

(The 8080A & 9080A)

Specification	Intel	AMD
Minimum Instruction Cycle Time	1.3 microseconds	1 microsecond
Maximum Power Dissipation (at 1.3 microsec. 0-70°)	1307 milliwatts	829 milliwatts
Output Drive	1.9mA @ .45V	3.2mA @ .4V
Minimum Input High Voltage	3.3V	3.0V
MIL-STD-883	Special	Standard

Three.

Save shoe leather and heartache. We've already done the shopping. Advanced Micro Devices builds all the really important 8080 peripherals that you-know-who invented, a whole bunch that we invented, plus all the memories you'll ever need. And in our traditional heart-warming way, we add a little reliability and performance. (Everything we make is MIL-STD-883 for free.)

Four.

Don't let anyone in this business tell you what to do. You're the customer.

Now, paste this message on the inside of your purchase order book. Or, failing that, write or call Advanced Micro Devices, the Buyer's Market.

Ours and Ours.

(Am9080A System Circuits)

AMD Part Number	Description	Availability
CPU		
Am9080A/-2/-1/-4	0 to +70°C	Stock
Am9080A/-2/-1	-25 to +85°C	Stock
Am9080A/-2	-55 to +125°C	Stock

STATIC READ/WRITE RANDOM ACCESS MEMORIES		
Am9101A/B/C/D	256 x 4, 22 Pin	Stock
Am9101A/B/C	256 x 4, 22 Pin	Stock
Am9102A/B/C/D	1K x 1, 16 Pin	Stock
Am9102A/B/C	1K x 1, 16 Pin	Stock
Am9111A/B/C/D	256 x 4, 18 Pin	Stock
Am9111A/B/C	256 x 4, 18 Pin	Stock
Am9112A/B/C/D	256 x 4, 16 Pin	Stock
Am9112A/B/C	256 x 4, 16 Pin	Stock
Am9131A/B/C/D/E	1K x 4, 22 Pin	Stock
Am9131A/B/C/D	1K x 4, 22 Pin	Stock
Am9141A/B/C/D/E	4K x 1, 22 Pin	Stock
Am9141A/B/C/D	4K x 1, 22 Pin	Stock

DYNAMIC READ/WRITE RANDOM ACCESS MEMORIES		
Am9050C/D/E	4K x 1, 18 Pin	Stock
Am9060C/D/E	4K x 1, 22 Pin	Stock

MASK PROGRAMMABLE READ-ONLY MEMORIES		
Am9208B/C/D	1K x 8, 250 nsec. max.	Stock
Am9216B/C	2K x 8, 300 nsec. max.	Stock
Am8316A	2K x 8, 850 nsec. max.	Stock
Am8316E	2K x 8, 550 nsec. max.	Stock

ERASABLE READ-ONLY MEMORIES		
Am1702A	256 x 8, 1.0 μsec.	Stock
Am2708	1K x 8, 450 nsec.	1st Q. 1977

CPU: 9080A = 480 nsec. -2 = 380 nsec. -1 = 320 nsec. -4 = 250 nsec.
MEM: A=500 nsec. B=400 nsec. C=300 nsec. D=250 nsec. E=200 nsec.

SECOND SOURCE SUPPORT		
Am8212	8-bit I/O Port	Stock
Am8216	Non-Inverting Bus Transceiver	Stock
Am8224	Clock Generator	Stock
Am8226	Inverting Bus Transceiver	Stock
Am8228	System Controller	Stock
Am8238	Extended Write System Controller	Stock
Am8251	Prog. Communications Interface	Stock
Am8255	Prog. Peripheral Interface	Stock
Am8257	Direct Memory Access Controller	3rd Q. 1977

IMPROVED SUPPORT			
		REPLACES	
Am8224-4	High-Speed Generator	N/A	Stock
Am8238-4	High-Speed System Controller	N/A	Stock
Am9511	Arithmetic Processing Unit	N/A	3rd Q. 1977
Am9517	Multi-mode DMA Controller	8257	3rd Q. 1977
Am9519	Universal Interrupt Controller	8259	3rd Q. 1977
Am9551/-4	Prog. Communications Interface	8251	Stock
Am9555/-4	Prog. Peripheral Interface	8255	Stock
Am25LS138	1-of-8 Decoder	8205	Stock
Am25LS139	Dual 1-of-4 Decoder	8205	Stock
*Am25LS273	8-bit Common Clear Register	N/A	2nd Q. 1977
*Am25LS373	8-bit Transparent Latch	8212	4th Q. 1977
*Am25LS374	8-bit 3-State Register	8212	Stock
*Am25LS377	8-bit Common Enable Register	8212	2nd Q. 1977
*Am25LS2513	Priority Encoder	8214 & 8212	Stock
*Am25LS2537	1-of-10 3-State Decoder	8205 (2)	Stock
*Am25LS2538	1-of-8 3-State Decoder	N/A	Stock
*Am25LS2539	Dual 1-of-4 3-State Decoder	N/A	Stock

*All combine high performance and low power in space saving 20-pin package.



Advanced Micro Devices

Bipolar LSI. N-channel, silicon gate MOS. Low-power Schottky.
Multiple technologies. One product: excellence.

Circle 271 on reader service card

A new start for manpower studies

It has been a long time coming, and it has taken a lot of complaints—from engineers and at least one professional society—but the Engineering Manpower Commission has finally conceded, albeit somewhat indirectly, that critics of its manpower-demand studies have been right.

The full commission has just approved a policy statement on manpower supply vs demand projections that goes part way toward removing one of the principal objections to the studies: that because of the biases inherent in the source material, its “predictions” may be biased, too. Indeed, a major and recurring criticism has been that the studies were unduly optimistic, sometimes painting a scene of expanding engineering employment opportunities when, in fact, employment was dwindling. At fault, said some, were educators and employers, who have a stake in having more, not fewer, students entering the engineer career pipeline.

Now, according to the new policy statement, “assessments of supply vs demand relationships will be based on analysis of all available data sources. Undue reliance of any single source will be strictly avoided.” Even more significant, perhaps, is the promise that “when quantitative projections are made, the important underlying assumptions on which they are based will be clearly and prominently identified and the accompanying discussion will include an appraisal of the reliability of the assumed conditions or factors and any apparent biases in the data.” The commission’s new policy also outlaws “the use of exaggerated terms in reference

to potential shortages or surpluses of manpower” and the citing of data and opinions about supply and demand “as an inducement to undertake careers in engineering.”

These words reflect important first steps in rectifying a problem that may well have had a wide-ranging and unfortunate impact on many of today’s engineers. The old argument that, lured by overly rosy predictions of a glamorous and well-paid career, students entered engineering only to find no jobs or a dead end at 40 need not be repeated. The damage has been done, and the question has never been whether the surveys’ faults were intentional or not. The question is—and this is what the commission has for so long refused to face—whether the faults, having been pointed out and well documented, would be allowed to go unfixed.

There is a certain irony, though, in the timing of the new policy statement. While the policy is designed to better protect upcoming surveys from the shortcomings of those of the past, the statement comes at a time when there are no funds in its budget for any further studies and a proposal for National Science Foundation funding was turned down as being too narrow in scope.

However, it might be well worth it for the commission to consider expanding the scope of its studies if that will lead to a commitment for Government funding. Then, the studies could be done with money from a more objective source. That independent funding could go a long way toward insuring the independence of the studies from the biases of their traditional supporters.

NOW: 1 TV SET = 1 CHROMA CHIP.

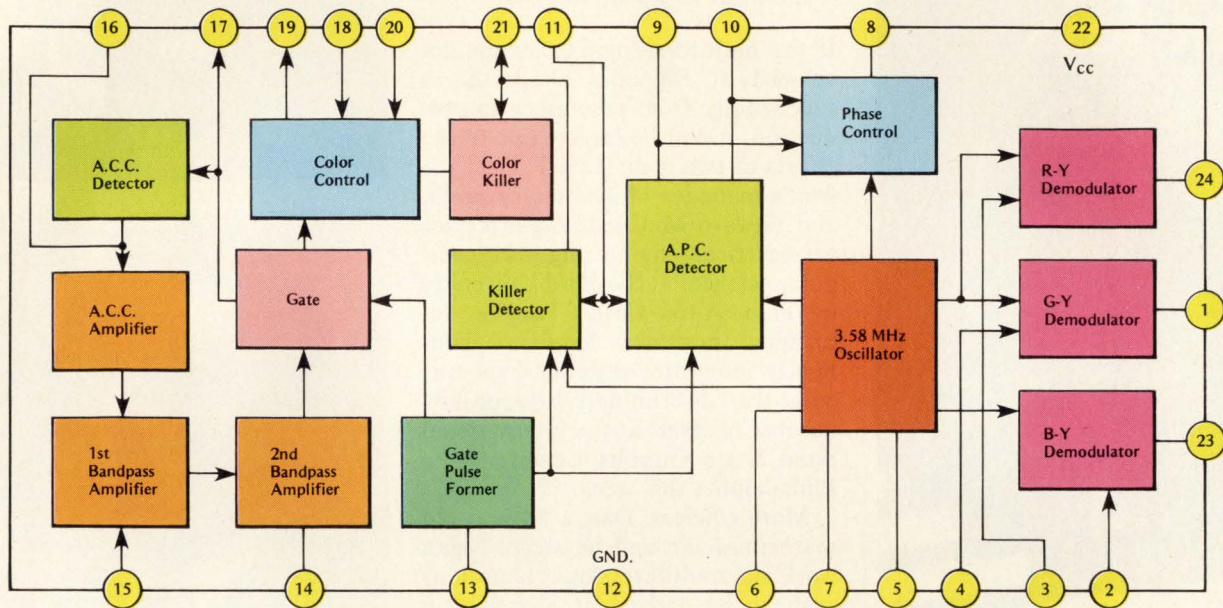

We're shipping what others are still developing.

Here's true high technology—you cut component count, assembly time, design time. And get every color processing function except video power output from one MSI device, the μ PC580C. While most other sources are still perfecting two-IC chroma, NEC's single-chip, plastic, 24-pin DIP is already user-proven in NTSC color TV. And being shipped in volume to TV manufacturers world wide.

In one chip, you get all these: ACC level and color killer setting automatically performed, eliminating variable resistors. Plus a triaxial color demodulator that lets you set the external axis. And, NEC gets rid of the tuning coils for you.

And more: The DC control system for color adjustment not only eases wiring, but greatly improves anti-interference characteristics. You get it all—ACC bandpass and color burst amps, color killer, phase-locked subcarrier regeneration, triaxial chroma demodulator, gating, detector, oscillators—everything but video output power stages. Ahead of its time? No way. You're ready, and so are we, with product in volume, high volume, and of super high quality.

The μ PC580C is just one sample of NEC's high technology, quality, and deliverability across the entire semiconductor spectrum. For more information, contact us.

This is what we're doing for TV. NOW: what can we do for you? With 60,000 employees, our 78-year old firm is shipping world-wide, high volumes of such products as:

ECL	TTL	MOS
Linear	Zeners	Discretes
Diodes	Rectifiers	Thyristors
Optoelectronics	Power transistors	

Quality? QUALITY! NEC's QC is the best in the world. Has to be, for us to have gained the customer confidence that's made us a major world source of semiconductors.

How can we help you? What do you need in semiconductors? Send a letter or give us a call about your needs. We could have some exciting answers for you. NEC America, Inc., Electron Devices Division, 3070 Lawrence Expy., Santa Clara, CA 95051, (408) 738-2180. We have representatives in major U.S. cities.

NEC
NEC America, Inc.

Build better resolution, accuracy and stability for a lot less money!

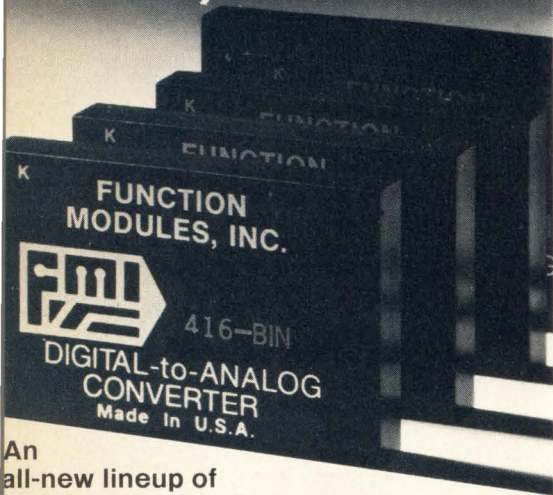

An all-new lineup of high-resolution D/A Converters

Compare these features!

- Selectable current or voltage output
- 14 and 16-bits binary available
- 4 and $\pm 4\frac{1}{2}$ digits BCD
- Low non-linearity and non-linearity drift
- 168 hours burn-in at 85°C
- Delivery off-the-shelf

You'll enjoy more resolution, accuracy and temperature stability for the price with the complete team of Intech/Function Modules high-resolution Digital-to-Analog Converters than from any others available . . . anywhere. Each DAC—packaged in a 2" x 3" x .4" case—has a built-in temperature-compensated reference network, ± 2 ppm/°C binary or BCD weighted wire-wound resistor network, fast current switches and op-amp. Plus, every model provides optional external offset and gain adjustments, too!

MODEL	RESOLUTION	ACCURACY	STABILITY	PRICE (1-24)
414-BIN	14-Bit Binary	$\pm 0.003\%$	± 3 ppm/°C	\$156.00
416-BIN	16-Bit Binary	$\pm 0.002\%$	± 2 ppm/°C	\$184.00
416-BCD	4-Digit BCD	$\pm 0.005\%$	± 3 ppm/°C	\$167.00
418-BCD	$\pm 4\frac{1}{2}$ -Digit BCD	$\pm 0.005\%$	± 3 ppm/°C	\$205.00

DAC's . . . off-the-shelf . . . today!
Details . . . for the asking . . . today!



intech/function modules

282 Brokaw Road
Santa Clara, Calif. 95050
Phone (408) 244-0500
TWX: 910-338-0254

14 Circle 14 on reader service card

People

Dao, McCluskey show off multilevel logic at ISSCC

If the multilevel-logic technique developed at Signetics Corp. moves successfully from laboratory to production, it will be largely due to the efforts of two men: Tich T. Dao, the firm's manager of systems research, and Edward McCluskey, a professor of electrical engineering and computer sciences at Stanford University in Palo Alto, Calif. They're describing their new family of non-binary integrated-injection-logic circuits that discriminate between any number of levels at the International Solid State Circuits Conference in Philadelphia this week.

More efficient. Dao, a 50-year-old mathematician and physicist, began work on multilevel logic almost as soon as he arrived at Signetics in Sunnyvale, Calif., in 1972. "I've always felt that binary logic was a very inefficient way to utilize an integrated circuit," says the designer of most of the new circuits [*Electronics*, Oct. 28, p. 31]. "It makes much more sense to use the same pathways to send three, four or ten levels of information, rather than just two."

Signetics' multithreshold logic is only part of the effort to boost computer efficiency. "Boolean (binary) logic is only the tip of the iceberg as far as designing a computer system is concerned," Dao continues. "There is a whole body of mathematical knowledge extending back into the 18th century that can be applied to designing much more efficient computers. Some of these techniques have been used in developing new software languages but, as for implementing them in hardware, computer scientists have been waiting for the IC designers to catch up."

The design rules that will allow engineers to work with Signetics' proposed four-level logic and beyond to even eight and ten levels are also being developed, points out the 48-year-old McCluskey, a consultant to Signetics. "So far, using my design rules, I've developed circuits with no *a priori* knowledge of the device

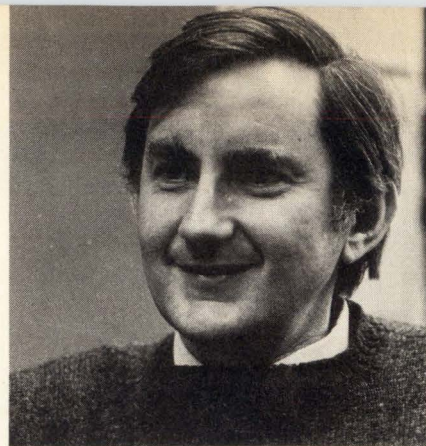

Boosters. Increasing information density up to 10 times is goal of McCluskey and Dao.

structure that come close in performance to those actually developed," he says.

Reliability is also being taken care of, though it is much more of a problem here than with binary logic. "In multivalued circuits, the thresholds representing 1, 2, 3, 4, and so on have to be precise and predictable," McCluskey says. "And in a production device, the levels have to be relatively immune to process variations."

What this all means, says Dao, is that computers can be built based on multivalued logic circuits that increase information density per given area 4, 8, or 10 times without any substantial changes in present processing. "That's a goal worth aiming for," McCluskey concludes.

LCD watches are the target for Motorola's Martin Cooper

With Motorola Inc. aggressively courting traditional watchmakers with its new line of digital modules (p. 25), Martin Cooper is happily sitting atop what's estimated to be a \$100-million business within the

A/D converters.

+ 1999

- 1999

- 19999

+ 19999

Only Intersil makes this many.

	AVAILABLE FROM STOCK							FIRST QTR. '77		
	8052/ 8053	8052A/ 8053A	8052/ 7101	8052/ 7103	8052A/ 7103A	LD111/ LD110	LD111/ LD114	8052A/ 7104	MONOLITHIC CMOS	
								7106	7107	
DISPLAY										
3½ Digit LED	✓			✓			✓			✓**
3½ Digit LCD	✓		✓							
4½ Digit LED		✓		*	✓					
4½ Digit LCD		✓								
DATA PROCESSING										
3½ Digit BCD	✓		✓	✓		✓	✓		✓	
4½ Digit BCD		✓			✓					
16 Bit Binary		✓						✓		
UART Compatible				✓	✓			✓	✓	
Price @ 100 pcs	\$9.00	\$10.50	\$11.00	\$10.50	\$12.50	\$13.90	\$20.15	\$15.00	\$8.80	\$9.25

* 8052/7103 has 4½ digit resolution.

** 7107 drive displays directly.

A complete family for every application.

Look over Intersil's line of A/D converter products. Find exactly what you need for instrumentation, control or data processing. All devices feature auto-zero, auto-polarity and single references. All are suitable for MUXed inputs.

Intersil means leadership in dual- or single-chip devices. Our new 7106 and 7107 monolithic CMOS converters will include all display drive circuitry on-chip. For interfacing microprocessors, the 8052/7101 has 3½ digit parallel BCD output plus polarity and over-range, and can be MUXed or tristated to your bus. The 8052/7103 has UART-compatible outputs and inputs for remote 2-wire use. And the 8052/7104 will offer both these features with built-in tri-state byte or word outputs.

A library you must have before you begin a design:

1. "Interfacing A/D Converters and Microprocessors," by Peter Bradshaw.
2. "Selecting Between Integrating and Successive Approximation A/D Converters," by Dave Fullagar.
3. "Do's and Don'ts of Applying A/D Converters," by Bill O'Neil.
4. "A Complete Error Analysis of the Integrating A/D Converter," by Lee Evans.

Get them all from the leader, Intersil, 10900 North Tantau Ave., Cupertino, CA 95014.

Need a specialized A/D circuit?

If you digitize analog data, you should talk to Intersil. A leading DMM manufacturer spoke to Intersil and others, and selected Intersil to develop and produce a dedicated single-chip, low noise CMOS A/D converter. Intersil provides a selection of custom features such as:

- Output format selection (LCD, BCD, LED, Binary, Etc.)
- Low noise (10µV p-p) vs. cost
- Accuracy vs. cost
- Specialized power supply requirements
- UART, PIE and microprocessor controllability
- Auto-ranging vs. dedicated ranges

Call Skip Osgood (408)996-5000 today about your needs. Many of your requirements may already be designed.

Intersil



Intersil stocking distributors
 Advent Electronics, Inc., (Indianapolis)
 Arrow Electronics
 Century Electronics
 Elmar/Liberty Electronics
 Harvey (Upper N.Y.)
 Intermark (San Fran., Seattle)
 Kierulff Electronics (Mass.)
 R.A.E. Ind. Elect. Ltd. (Van. B.C.)

RESCO (Raleigh, N.C.)
 Schweber Electronics
 Sheridan Assoc.
 Diplomat (Fla.)
 Weatherford
 Zentronics (Canada)
Intersil area sales offices
 Boston (617)861-6220
 Chicago (312)986-5303

Dallas (214)387-0539
 Los Angeles (213)532-3544
 Ft. Lauderdale (305)772-4122
 Minneapolis (612)925-1844
 New York (201)567-5585
 San Francisco Bay Area (408)984-2170
 Upstate New York (607) 754-7406
 Toronto, Canada (416)457-1014
Representatives in all major cities.

New miniature metallized capacitors for professional and consumer electronics

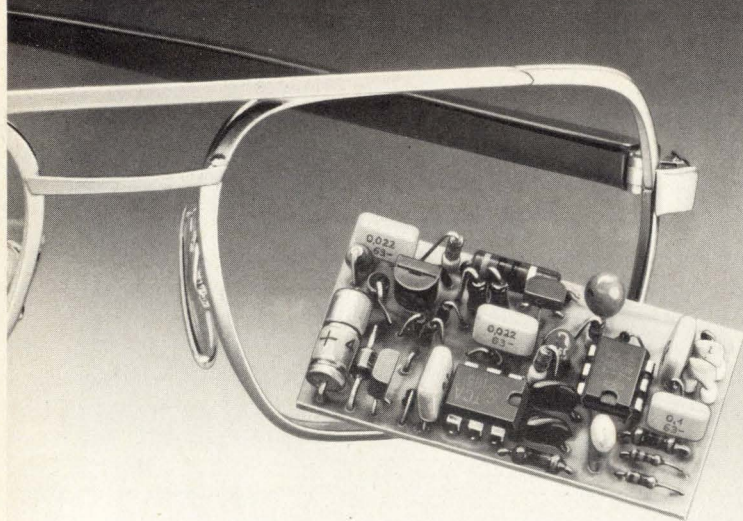

WIMA MKS 2 min

5 and 7.5 mm lead spacing. Up to 1.0 μ F. Ultra miniature size, previously unattainable.

WIMA MKS 3

7.5 and 10 mm lead spacing. Up to 1.0 μ F. Subminiature size and suitable for most applications.

Long term reliability with high dielectric and case insulation. Designed for easy mounting and for double-sided printed circuit boards.

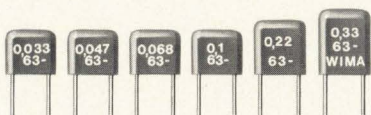

WILHELM WESTERMANN

Spezialvertrieb elektronischer Bauelemente
P.O.-Box 2345 · Augusta-Anlage 56
D-6800 Mannheim 1 · Fed. Rep. of Germany
Tel.: (6 21) 40 8012

People

firm's Communications group. Moreover, Systems Operations, as the business is called, has been upgraded to full divisional status and Cooper has been named its general manager.

It's a handful of diverse businesses, actually, ranging from Motorola's traditional radio common-carrier business to piezoelectric ceramic hi-fi speakers, portable-radio batteries, and quartz crystals. But the newest and fastest growing segment is the watch modules.

Big market. Cooper estimates that there will be 30 million digital watches sold world-wide this year—fully half of them with liquid-crystal displays. "We intend to become the largest supplier of quartz crystals, LCD displays, and LCD watch modules," he says, confident Motorola will push successfully into a market served by companies like Hughes Aircraft and Beckman Instruments.

Cooper also doesn't foresee any shortages of liquid-crystal watch parts. In addition to Motorola, he sees a number of U.S. suppliers adding to their display capacity, and he looks to the Japanese to enter the market in a big way.

"The Japanese are going after the whole quartz watch market world-wide," says the 48-year-old Motorola vice president. "There will be a surplus of quartz watch crystals in 1977, primarily because the Japanese have entered the market with ridiculously low prices."

All this competition will make for some sharp price cuts. Although LCD watch prices will still be higher than their light-emitting diode counterparts, "there's going to be a dramatic drop, based on our impact on the market and the Japanese impact," Cooper says. Liquid-crystal modules sold for around \$25 each last year; this year will see prices heading toward half that, he says.

Cooper has directed Systems Operations from his Schaumburg, Ill., office since its organization in 1972. "We started it to go after higher growth, riskier opportunities but we've grown out of Motorola's traditional businesses," he says.

TO-5 RELAY UPDATE:

Solve your energy crisis with TO-5 relays

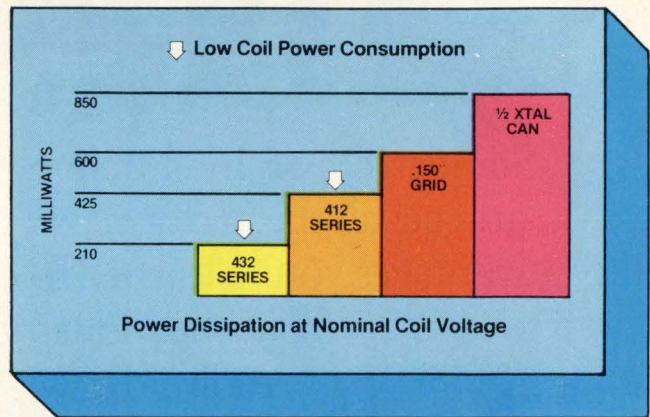

Subminiaturization and pc board compatibility — two obvious advantages of Teledyne TO-5 relays. But there's another outstanding advantage: low coil power consumption. This feature is best illustrated in the above graph which shows our TO-5 relay power savings compared to other miniature relays. The Teledyne 412 Series dissipates about 30% less power than the .150" grid relay, and 50% less than the 1/2 crystal can. Our sensitive 432 Series is 65% less than the .150" grid. And 75% less than the 1/2 crystal can.

This means you can save over 6 watts in a typical system using, let's say, ten TO-5 relays. In the end, you gain significant advantages in terms of thermal and power supply considerations that can help prevent an "energy crisis" in your system.

Our complete line of TO-5 relays includes military and commercial/industrial types, with virtually all military versions qualified to established reliability MIL specs. For complete data, contact Teledyne Relays — the people who pioneered the TO-5 relay.

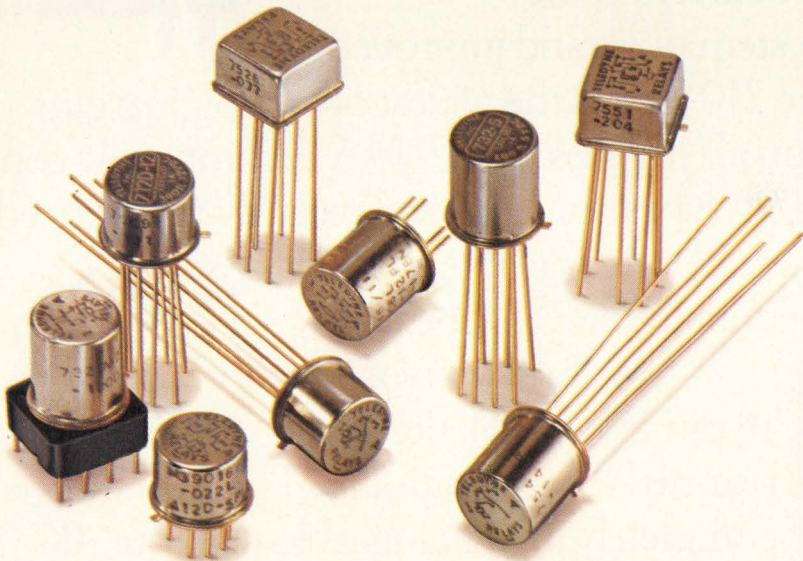

- **Hybrid "T" Series**
SPDT & DPDT types with internal transistor driver and suppression diode
- **"D" and "DD" Series**
Military and commercial/industrial versions with internal suppression and steering diodes
- **Maglatch Series**
SPDT, DPDT, and 4PST magnetic latching types
- **Centigrad® Series**
World's smallest relay — only .225" (5.72mm) high x .370" (9.40mm) square
- **Hi-Rel Series**
Screened versions for space flight applications (NASA qualified)
- **High Environment Series**
Hi-temperature, Hi-shock, and Hi-vibration types

 **TELEDYNE RELAYS**

3155 West El Segundo Boulevard, Hawthorne, California 90250
Telephone (213) 973-4545

Intel delivers compatible 4K

Standardize on Intel® 16 pin, 4K and 16K RAMs, and get all the performance and reliability advantages you've learned to expect

from the industry's leading RAM producer.

It all starts with our

volume-produced 2104A 16 pin 4K RAM. There isn't a faster 4K anywhere—nor lower power. And because the

2104A has significantly lower current spikes than other 4Ks, there's less system noise and improved operating margins. In fact, the 2104A has the widest operating margins available—including $\pm 10\%$ on all supplies. The 2104A is completely compatible with both the older 4096 type metal gate and recently-announced 4027 type silicon gate 16 pin 4K RAMs available from other sources. Planned compatibility keeps your alternatives open.

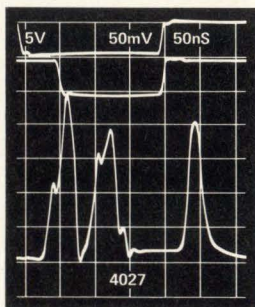
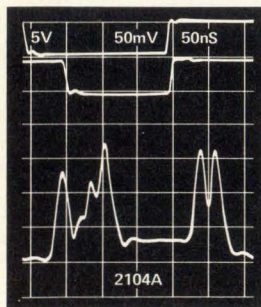
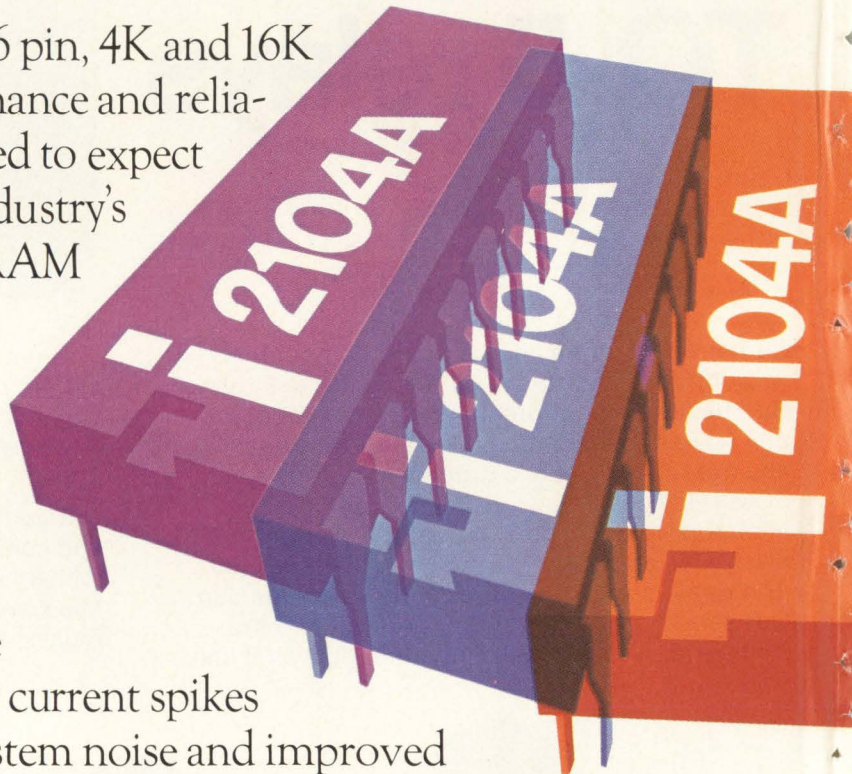

We're now in production on our 16 pin 16K RAM, the 2116. Again we've planned for compatibility. The 2116, 16K is completely interchangeable with our 4K 2104A. The 2116 provides four times the density per package at half the power per

bit. Like the 2104A, it provides a $\pm 10\%$ margin on power supplies. And because the 2116 includes an output latch identical to all 16 pin 4K RAMs,

the first and 16K RAMs.

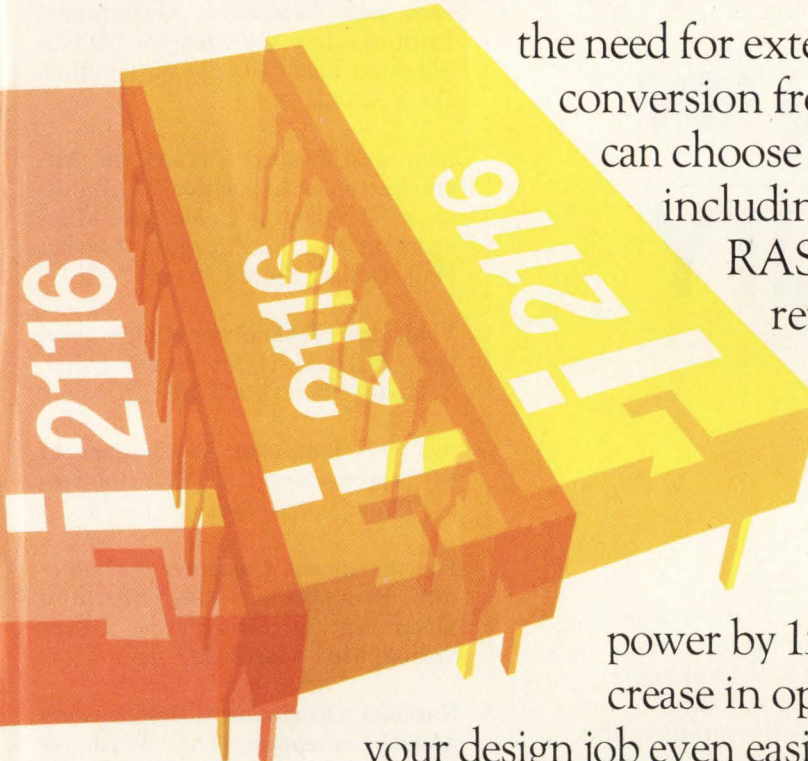

the need for external latches is eliminated and conversion from 4K to 16K is simplified. You can choose from several refresh modes including 4K compatible 64 cycle or RAS-only 128 cycle. The 64 cycle refresh improves memory throughput by doubling the time between refresh cycles. This mode also enhances page mode operation and reduces refresh standby

power by 15% or more without any increase in operating power. And to make

your design job even easier, we've provided the 3242

Address Multiplexer/Refresh Counter.

Whether you're looking for the performance advantage in 16 pin 4K RAMs or for the easiest way to get a 16K into your new designs, you'll find Intel delivers your best choice—the 2104A or 2116.

INTEL 16 PIN, 4K & 16K RAMs				
Part Number	Mem. Capacity	Max. Access Time (ns)	Cycle Time (ns)	Max. I _{DD} (mA)
2104A-1	4K	150	320	35
2104A-2	4K	200	320	32
2104A-3	4K	250	375	30
2104A-4	4K	300	425	30
2116-2	16K	200	350	69
2116-3	16K	250	375	68
2116-4	16K	300	425	65

For Data Sheets and our 16-page Application Note, use the reader service card or write Intel Corporation, 3065 Bowers Avenue, Santa Clara, California 95051.

intel® delivers.

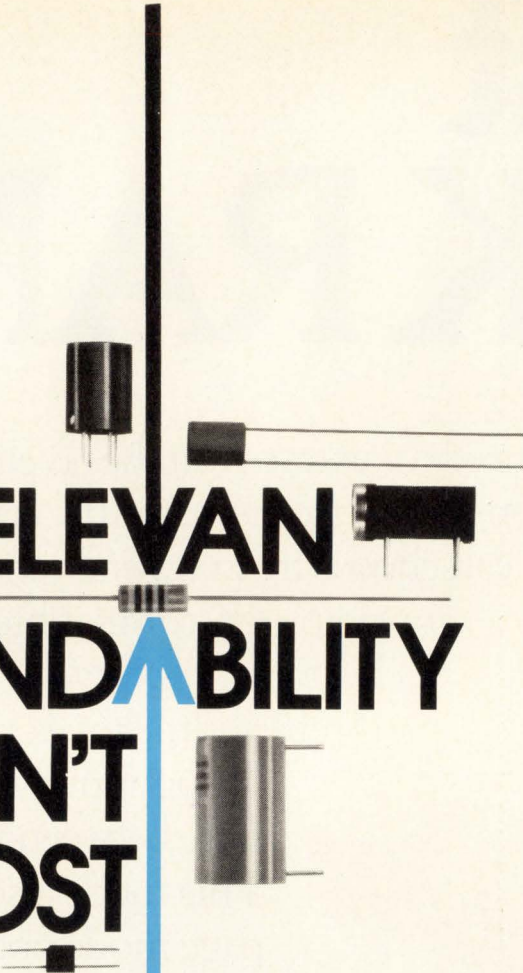

DELEVAN

DEPENDABILITY

DOESN'T

COST

There's a lot more than meets the eye in Delevan's lineup of miniature RF inductors and transformers. Like the unmatched dependability built into each component. Thanks to a lot of things that go on at the factory. Hard-nosed quality controls . . . complete material analysis . . . advanced in-plant environmental testing . . . automated techniques for winding, soldering and molding . . . and conscientious people who take pride in true "no-fault" production. And of course, the dependable delivery and service you always get from Delevan.

IT PAYS

Remember . . . the proven reliability of these superior made-in-U.S.A. inductive devices means greater reliability for the products and assemblies *made from them*. Sure, you can save a few pennies by using cheaper components. But this could be expensive in terms of premature failure of the finished product. When your company's reputation is on the line, you can't afford *not to use* Delevan components. Their premium performance more than justifies their use . . . because Delevan dependability pays for itself. Why not prove it to *yourself!*

Delevan  **AMERICAN PRECISION INDUSTRIES INC.**
Division

270 QUAKER RD./EAST AURORA, N.Y. 14052
 TELEPHONE 716/652-3600 TELEEX 091-293
 OTHER DIVISIONS OF AMERICAN PRECISION INDUSTRIES INC.:
 BASCO • DUSTEX • MOELLER INSTRUMENT CO. • OXFORD CORP.

Meetings

Nepcon '77 West—National Electronic Packaging and Production Conference, Industrial and Scientific Conference Management Inc. (Chicago), Anaheim Convention Center, Anaheim, Calif., March 1-3.

Fourth Energy Technology Conference and Exposition, Government Institutes Inc. (Washington, D.C.), Sheraton-Park Hotel, Washington, D.C., March 14-16.

Southwest Printed Circuits and Microelectronics Exposition '77, Industrial and Scientific Conference Management Inc. (Chicago), Market Hall, Dallas, March 16-17.

Vehicular Technology Conference, IEEE, Orlando Hyatt House Hotel, Orlando, Fla., March 16-18.

IECI '77: Industrial Applications of Microprocessors, IEEE, Sheraton Hotel, Philadelphia, March 21-23.

Fourth Annual Computer Architecture Symposium, IEEE, Sheraton Silver Spring Motor Inn, Silver Spring, Md., March 23-25.

National Association of Broadcasters Annual Convention, NAB (Washington, D.C.), Shoreham Americana and Washington Hilton Hotels, Washington, D.C., March 27-30.

Data Communications Interface '77, Datamation magazine *et al.*, Georgia World Congress Center, Atlanta, March 28-30.

1977 International Semiconductor Power Converter Conference, IEEE, Walt Disney Contemporary Hotel, Orlando, Fla., March 28-31.

Conference on Computer Systems and Technology, Institution of Electronic and Radio Engineers (London, England), University of Sussex, Brighton, England, March 29-31.

Salon International Des Composants Electroniques, Porte de Versailles, Paris, France, March 31-April 6.

What You Need Is What You Get.

Ramtek's new RM9000 modular graphics and imagery system gives you expandability, economy and flexibility.

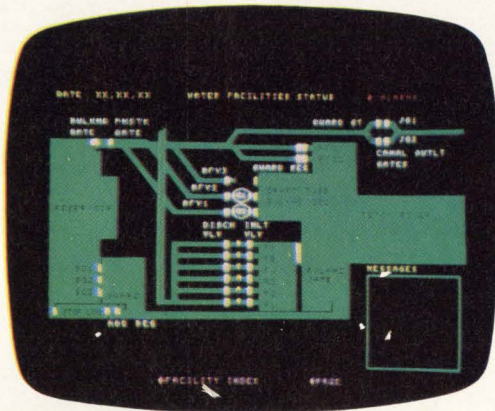

Process Control: Water facilities plant.

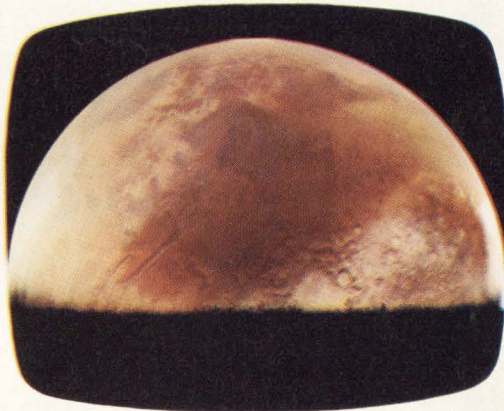

Imaging: Viking I Orbiter.

Select The Performance You Need.

The RM9000's total modularity lets you select the exact performance you need to fill your particular application. You pay only for the performance you need. Nothing more. And that's like money in the bank.

Add On As You Have To.

As your needs change and grow, the RM9000's capability will grow right along with them. A comprehensive list of options such as expansion from black and white to grey scale or color—even a complete range of interactive peripherals and additional independent channels.

Microprocessor-Controlled Raster Scan.

The RM9000 is the first raster scan graphics and imagery system to be totally microprocessor

controlled. That means you can implement a higher-order user language to minimize programming costs without a sacrifice in system throughput.

Functional. Reliable. Maintainable.

High reliability is the direct result of intensive testing of components and systems prior to shipment. Solid state components and printed circuit construction are used exclusively. Result? No special preventive maintenance measures are required. In fact, the RM9000 can be pre-programmed with self-diagnostic capability.

You Need To Know More.

To fully appreciate the RM9000's capability, you need more details. Call or write Ramtek Corporation, 585 N. Mary Ave., Sunnyvale, CA 94086. (408) 735-8400.

ramtek
Our Experience Shows



When you're
designing microprocessors
into your products...
our 990 computer products
can give you a head start.

TEXAS INSTRUMENTS.

Start with the TMS 9900 microprocessor.

It delivers surprising power, speed and flexibility in a low-cost, single-chip 16-bit package. Its repertoire of versatile instructions and high-speed interrupt capabilities provide computing power usually associated with a 16-bit TTL minicomputer.

Hardware multiply and divide is standard and the software you develop for the TMS 9900 is upward compatible with any other member of the 990 computer family.

When your application calls for a microcomputer—start with the 990/4 microcomputer on a board.

It offers all the advantages of the TMS 9900, plus flexible memory and CPU options ideally suited to manufacturers' applications: up to 8K bytes of dynamic RAM memory, up to 2K bytes of RAM and/or PROM, real-time clock input, eight vectored interrupts, expansion interface and optional ROM utilities. It's our off-the-shelf answer for many production needs.

The 990/4 microcomputer is also available in a low-cost three-slot OEM chassis... or housed in a 6- or 13-slot rack-mount chassis with programmer's panel... or in a 6-slot

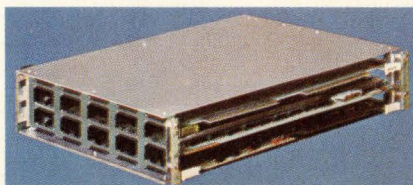

tabletop chassis. And, the 990/4 is available as a complete computer system supported by your choice of performance options and peripherals.

For applications requiring greater speed, we offer the most powerful member of the 990 computer family... the 990/10 minicomputer. It uses a TTL implementation of the 990 architecture and features TILINE*, an asynchronous, high-speed 16-bit parallel I/O data bus which links the CPU, memory, and high-speed peripheral devices.



Rack-Mount 990 Computer

And to help you get on line faster and surer, there's a prototyping system using 990 computer hardware and software packages.

In addition, the 990 family is well supported by a substantial library of software development packages.

Whatever your needs... the TMS 9900 microprocessor, the 990/4 microcomputer, or the 990/10 minicomputer... you'll be working with some of the most attractive



990/9900 Prototyping System

computer component values on the OEM market. Price/performance leadership you expect from Texas Instruments.

You can start today by getting more information on the entire 990 computer family. Contact your nearest TI sales office, or phone (512) 258-5121, Computer Equipment Marketing, for your local distributor. Write Texas Instruments Incorporated, P.O. Box 1444, M/S 784, Houston, Texas 77001.

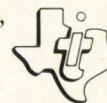

*Trademark of Texas Instruments Incorporated

©Copyright 1977, Texas Instruments Incorporated

TEXAS INSTRUMENTS
INCORPORATED

Get more for your money!

Use This New 3/8" Square Cermet Trimmer From Allen-Bradley

Our new TYPE E trimmer is a high performer with a realistic price. It has some important advantages: • Immersion seal is tested in 85°C water (not 50° or 70°). • Temperature characteristic is 100 PPM/°C for stability. • Multifingered contact for excellent adjustability. • \$0.49 each—1000 piece price. For more information call your A-B distributor or write for Publication 5219.

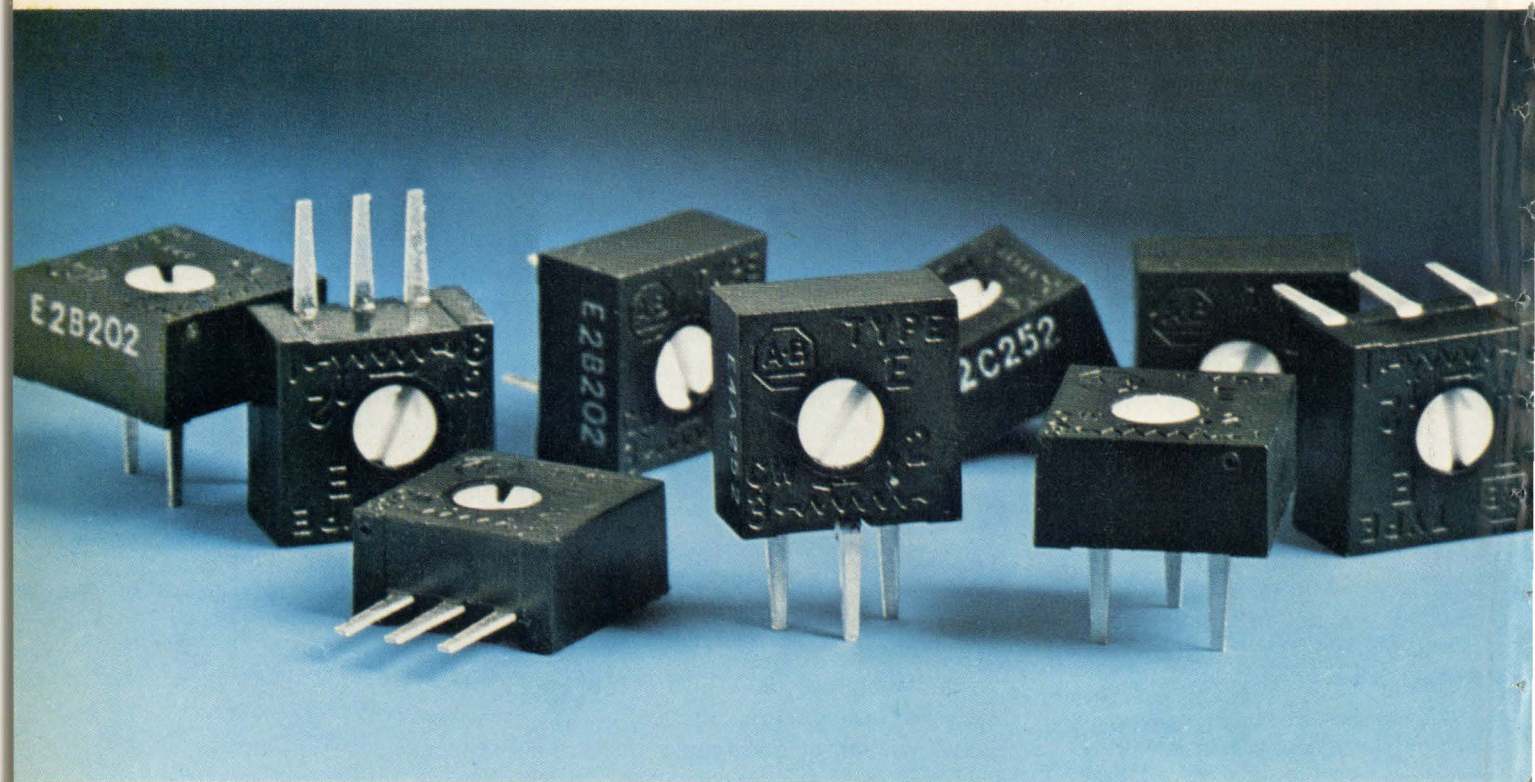
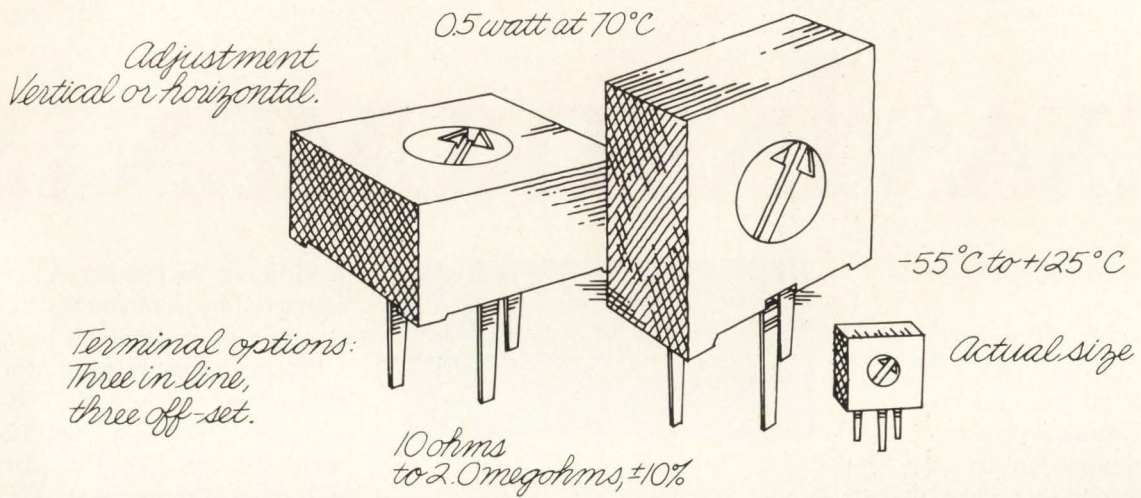

Quality in the best tradition.



ALLEN-BRADLEY
Electronics Division
Milwaukee, Wisconsin 53204

Fairchild aims its I²L process at 16-k RAM

The MOS-dominated dynamic memory market may be in for a major jolt. Using its Isoplanar injection logic process (which it calls I³L), Fairchild Camera and Instrument Corp. will begin manufacturing a 16-kilobit dynamic random-access memory in the second half of 1977 whose target specification can be termed awesome compared to 16-k MOS parts: **100-nanosecond access time, 350-milliwatt active power, and 70-mw standby power.** How much of a bite the new bipolar RAM takes out of the price-conscious main-memory market depends on what it will cost. In view of the very compact die size of the company's recently-introduced 4-k I²L dynamic RAM, the price of the 16-k version could be extremely competitive with those of high-performance MOS 16-k designs.

Motorola mounts LCD-watch crystal on substrate

Now that Motorola has started shipping production volumes of its new liquid-crystal-watch module [*Electronics*, Nov. 25, 1976, p. 35], the secret of its tiny size is out. Instead of using a packaged watch crystal, the firm has mounted the quartz crystal directly on the module's ceramic substrate, **eliminating enclosures, feedthroughs, and leads.** The crystal is also laser-trimmed, so that the module needs no variable trimmer.

Besides watch module and crystals, Motorola's Communications group also plans to sell fabricated and plated, but unpackaged, crystals to watchmakers that want to do their own trimming. "But the trimming is tricky," says Motorola vice president Martin Cooper. "We'd rather sell the substrate with the crystal mounted and trimmed."

Lithium batteries for LED watches may be near

The answer to the battery-supply nightmare of many a maker of light-emitting-diode digital watches is in the offing. By next Christmas the newest generation of sophisticated LED watches may sport a new power source—lithium-based batteries, **which offer more power in less area and longer shelf life** than conventional batteries. At the Consumer Electronics Show last month, National Semiconductor Corp. of Santa Clara, Calif., showed a new lithium-powered LED watch module, 210 mils thick, to selected customers. Mallory Battery Co. of Tarrytown, N.Y., was there also, with its new lithium iodide battery capable of 2 to 3 volts and 200 milliampere hours of output.

Other battery makers with active lithium programs aimed at the consumer market include Honeywell Inc. of Minneapolis, Eagle Picher Industries Inc. of Joplin, Mo., and CTS Corp. of Elkhart, Ind. National has signed agreements with Eagle Picher and Honeywell for thin, half-dollar-size batteries that would fit in the bottom of watch cases.

Amdahl reported to be first buyer of E-beam system . . .

One of the first buyers of the manufacturing electron beam exposure system (Mebes) from ETEC Corp. of Hayward, Calif., is reported to be Amdahl Corp. [*Electronics*, Nov. 25, 1976, p. 36]. In what appears to be a **move to build an in-house capability for fabricating advanced LSI circuits** for its V/470 series of super computers, Amdahl is reported to have spent an estimated \$500,000 for the Mebes; the first commercial production system for electron-beam lithography of integrated circuits, plus \$350,000 for diffusion furnaces from Tempress Microelectronics and \$175,000 for cylinder reactors from Applied Materials.

**. . . as GCA confirms
it will sell own
version next year**

GCA Corp. has confirmed its hint that next year it will market an electron-beam lithography system for making semiconductor masks [*Electronics*, Sept. 30, 1976, p. 12]. The Bedford, Mass., supplier of semiconductor production equipment **will use a proprietary approach in its system.** The company doesn't have a license from Bell Laboratories, whose electron-beam-exposure-system technology is being used by at least two competitors: ETEC Corp., and the Extrion division of Varian Associates in Gloucester, Mass.

**GI to market
1-chip processor
as standard device**

Augmenting General Instrument Corp.'s custom microprocessor approach to the low end of the controller market is its one-chip microcomputer to be offered by the Hicksville, N.Y. Microelectronics division as a standard product in April. The byte-oriented PIC1650 has 512 12-bit words of program memory, 32 bytes of working registers, and four sets of 8 input/output lines. **Priced at a rock bottom \$5 each for 100,000 and \$8 each for 20,000 pieces,** the MOS part is intended for control applications in gas pumps, vending machines, fast-food equipment, appliances, and other end equipment.

**Benrus moving closer
to introducing
LCD watches**

It's no longer a question of *if* Benrus Corp. will be selling a liquid-crystal-display digital watch, but *when*. At the 1977 Spring International Jewelry Trade Fair and Convention in New York, marketers for the Ridgefield, Conn., firm were **quietly polling retailers' preferences for a large number of LCD-watch modules** being evaluated by Benrus. Elliott Morrison, marketing manager for solid-state watches, says a decision will be made within a few weeks on which modules and suppliers to team with. Benrus then can have its watches on the market in six weeks.

**Home computer
is based on
Z-80 microprocessor**

The hobby-computer field acquires new systems almost as fast as it adds *aficionados* (see p. 38). For one of the latest product introductions, watch for Martin Research, Northbrook, Ill., this month to introduce one of the first home microcomputers to be built around Zilog Corp.'s Z-80 microprocessor. Also aimed at small industrial users, the new Mike 8 will be a three-card, \$495 device that comes with calculator keyboard, light-emitting-diode displays, and a 1,024-byte operating system.

In addition, the Heath Co. has hinted—to no one's surprise—**that it will offer computer kits this year.** The firm has been working on a broad family of home computer products for more than two years.

**Toshiba to ship
half the 1978 car
controls to Ford**

Toshiba will supply half of the 30,000 electronic engine-control modules to be fitted into 1978-model cars this year by Ford Motor Co. In addition, the Japanese company will make the **microprocessors and associated large-scale-integrated control modules** that the Essex division of United Technologies Corp. will provide for Ford cars. A third module supplier will be Ford's Electrical and Electronics division. It is believed that the division will use components from Intel Corp. and Texas Instruments, selected from among seven vendors.

Profit from sameness.

Kodak micro resist 747 gives you the precise uniformity to help improve your yields.

It's formulated to give excellent adhesion, etch resistance, and resolution for use on semiconductor and metal surfaces common to microelectronics manufacturing.

Our rigid filtering standards mean a consistently low metal-ion content. And the tightly controlled viscosity means

more uniform coating and higher reliability.

747 resist is negative-working and is available in four viscosity grades: 110, 60, 45, and 30 centistokes.

Batch-to-batch consistency—helps build your profits.



For a free packet of information on Kodak products for photofabrication, write Eastman Kodak Company, Dept. P04802, Rochester, N.Y. 14650.



Kodak micro resist 747

RESULTS COUNT



You'll probably replace your bulb 10 times before your Pro-Log programmer fails even once.

Ordinary lightbulbs average a 1,000-hour life. And while we back our Series 90 and 92 PROM programmer control units with a 2-year parts and labor warranty—the industry's longest—chances are you won't need it. With over 1,000 units in use in the U.S., the mean time between failure is 10,000 hours. In terms of a normal workweek, that's nearly five years.

Think of the benefit. If your programmer doesn't need service, you don't have to wait around for a field service man.

And when something does happen to a Pro-Log unit, our Customer Service Desk promises you full repairs in one week maximum or loan equipment if you're in a hurry.

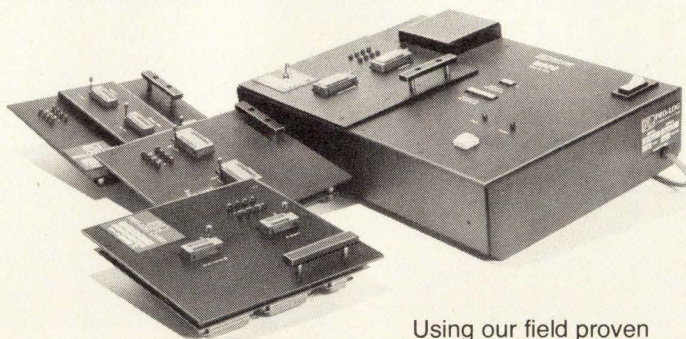
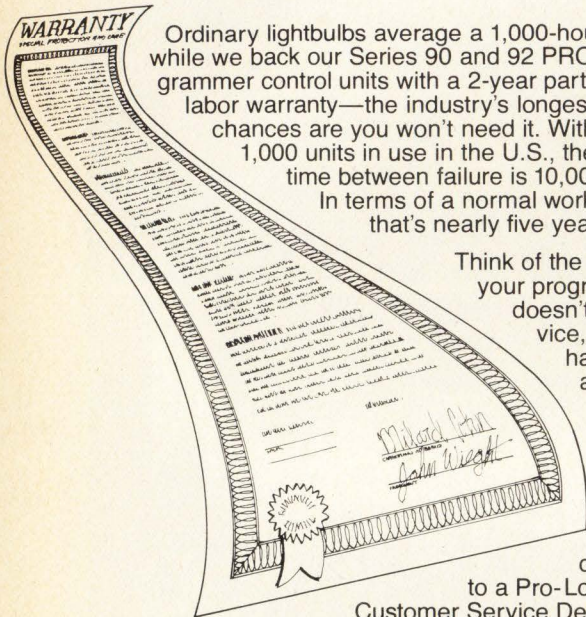

Using our field proven plug-in personality modules, each with its own full-year parts and labor warranty, the stand-alone Series 90 PROM Programmer programs, lists, duplicates and verifies every major MOS and bipolar PROM; its master control unit costs only \$1,800. The single-button Series 92 PROM Duplicator control unit is \$995. Modules cost from \$360 to \$450. Options include TTY, paper tape reader, parallel I/O, RS232 and RAM memory.

See for yourself. For a demonstration call Pro-Log, 2411 Garden Road, Monterey, CA 93940. Phone (408) 372-4593.

 **Pro-Log
Instruments**
Microprocessors at your fingertips.



Intel readies a 16,384-bit erasable PROM

Largest ultraviolet-erasable device, interchangeable with 16-k ROMs, needs only a single 5-volt power source

While others are still struggling to get into production with 8,192-bit ultraviolet-light-erasable programmable read-only memories, Intel Corp. will be supplying samples of a 16,384-bit version in the second quarter. What's more, the 2716 will

be easier to use and need just a single 5-volt power supply instead of multiple supplies.

Like Intel's earlier 2708 8-k device, the 2716 is a double-layer polysilicon-gate n-channel metal-oxide-semiconductor device. It is two to four times as dense as most 8-k erasable PROMs around, including the 2708, but even so, its speed is about the same—450 nanoseconds—and power dissipation in the normal read mode is actually 20% less, about 600 milliwatts. Another feature, not available on any UV-eras-

able device now on the market, is a standby power mode in which the device operates at a sixth of its normal power dissipation. That, of course, offers further savings in power at the system level.

The new part will expand the already sizeable market in UV-erasable PROMs—they have become popular for prototype programming in microcomputer-based designs. This year the industry expects to sell \$40 million to \$50 million worth as the average selling price of 4,096-bit and 8-k devices drops 50% from the 1976

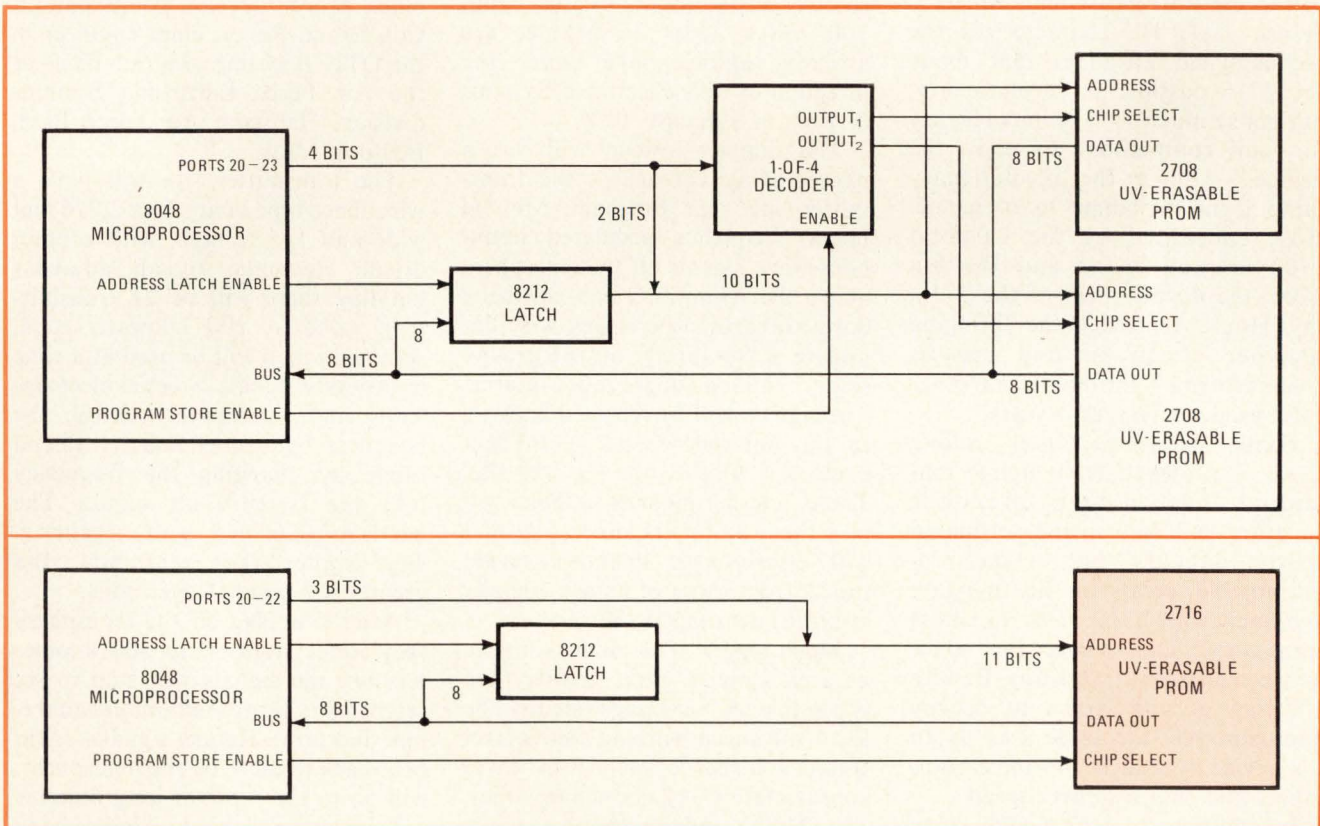

Bonus. The 2716 16-k erasable PROM replaces a pair of 2708 8-k devices and is easier to use because it requires a single 5-volt power supply. Just an external latch is all that's needed to interface the device to a microprocessor system like Intel's 8048.

level of \$50 to \$75 each and as pressure from the 16-k PROMS builds.

To make things tougher on competitive devices, Intel has added a circuit-design feature that simplifies programming. As before, programming is a matter of transporting charge to a floating gate by inducing an avalanche injection of electrons. While the memory chip still needs a +26-v supply for this function, the supply no longer needs to be switched externally. Instead, the pulsed signal that induces the avalanche injection now occurs on chip. And unlike present 8-k erasable PROMS, single-pulse and single-location programming are now possible with the 2716. Moreover, chip size is only 30,625 square mils for the 2,048-by-8-bit device, according to Dave House, Intel's memory applications manager. This is only 17% larger than present 8-k devices.

"I think we've come up with a pretty little package of advantages, enough to help us maintain our lead in the erasable-PROM marketplace," House says. He characterizes the technological advances that made the 2716 possible as "evolutionary, but not so much so as to make it easy for our competitors to copy the device." Unlike the revolutionary jump from p-channel to n-channel MOS represented by the 2,048-bit 1702 erasable PROM and the 8-k 2708, the development of the 2716, says House, represents the "bringing together of circuit and process enhancements" introduced in other Intel products in recent years.

Oxide isolation. Chief among these is a switch from active ion-implant isolation to passive oxide isolation, not only in the peripheral control circuitry, but in the programmable array of floating-gate avalanche-injection MOS (Famos) transistors. This halves the space between adjacent transistors. Besides allowing a 16-k array to occupy approximately the same area as an 8-k device, it reduces bit-line capacitances and thus improves speed.

In addition, a +12-v and -5-v supply were eliminated and additional speed gained for the 16-k

PROM by using the +5-v process and circuitry originally developed for Intel's 2102A and 2115 1,024-bit static random-access memories for the peripheral circuitry—address decoders and buffers, row and column decoders, and output sense amplifiers. The on-chip program pulsing is provided by a simple voltage switch—a MOS transistor with a 26-v input and a gate on the output.

A chief goal in designing the new

device was to make it easy to use, House points out. For that reason, he says, Intel designed the 2716 in a 24-pin package that is completely plug-compatible with its 2316E 16-k mask-programmable read-only memory. "Using these two nearly identical devices," House says, "the user may debug systems with the 2716 and, as soon as the data pattern is firm, order ROMs to plug directly into the same socket." □

Military

Early-warning over-the-horizon radar being put together in Maine by GE

Now about two years into its \$38.8 million contract, General Electric Co. is hard at work on a new Air Force radar system for early warning of bomber attacks. First tests of the so-called over-the-horizon backscatter system are set for the fall of next year. The huge transmitter and receiver installations, located about 100 miles apart in Maine, are already taking shape under the direction of GE's Electronic Systems division in Syracuse, N.Y.

The doppler system will use a phased-array antenna at the transmitter site near Bingham, Me., to bounce frequency-modulated continuous-wave signals off the ionosphere above the Atlantic Ocean and back down to earth, where they will illuminate a "footprint" on the ground some 1 million square miles in area. The signals will be reflected back up to the ionosphere and again bent back, this time to the receiver site. There, another gigantic antenna will pick them up for the processing that will discriminate unknown target tracks from those of known friendly aircraft operating in the area.

Much bigger. The radar will scan an area some 10 times greater than is possible with existing systems. The E-3A advanced warning and control system's airborne radar can cover approximately 112,000 square miles. The Maine radar's shortest range will be some 500 miles, and it will exceed 1,800 miles at maximum

reach. Land-based line-of-sight radars, such as the AN/FPS-27, which the radar will complement, cover a radius of about 200 miles.

Apart from its coverage and size, the system is not unusual. For instance, it does not pick state-of-the-art components, but relies on older, proven devices, points out Lt. Col. Erlind Royer, chief engineer in the OTH-B system program office at the Air Force Electronic Systems division, Hanscom Air Force Base, Bedford, Mass.

The transmitter site will have a wire-fence type of antenna 2,276 feet wide and 135 ft high, with contact dipole elements. In an adjacent building there will be 21 transmitters, rated at 100 kilowatts each, seven of which will be used at a time to generate signals. Steered electronically under computer control, the beam can be scanned in azimuth and range by changing the frequency over the system's six bands. The bands range from 5 to 30 megahertz. The higher the frequency, the greater the range, Royer adds.

After bouncing off the ionosphere that varies from 50 to 300 kilometers up, the signals will step in six segments to form the million-square-mile footprint. Return signals, again bent back to earth by the ionosphere, will go to the 5,816-ft-long receiver antenna near Columbia Falls, Me., where they will be relayed to 96 three-stage superheterodyne re-

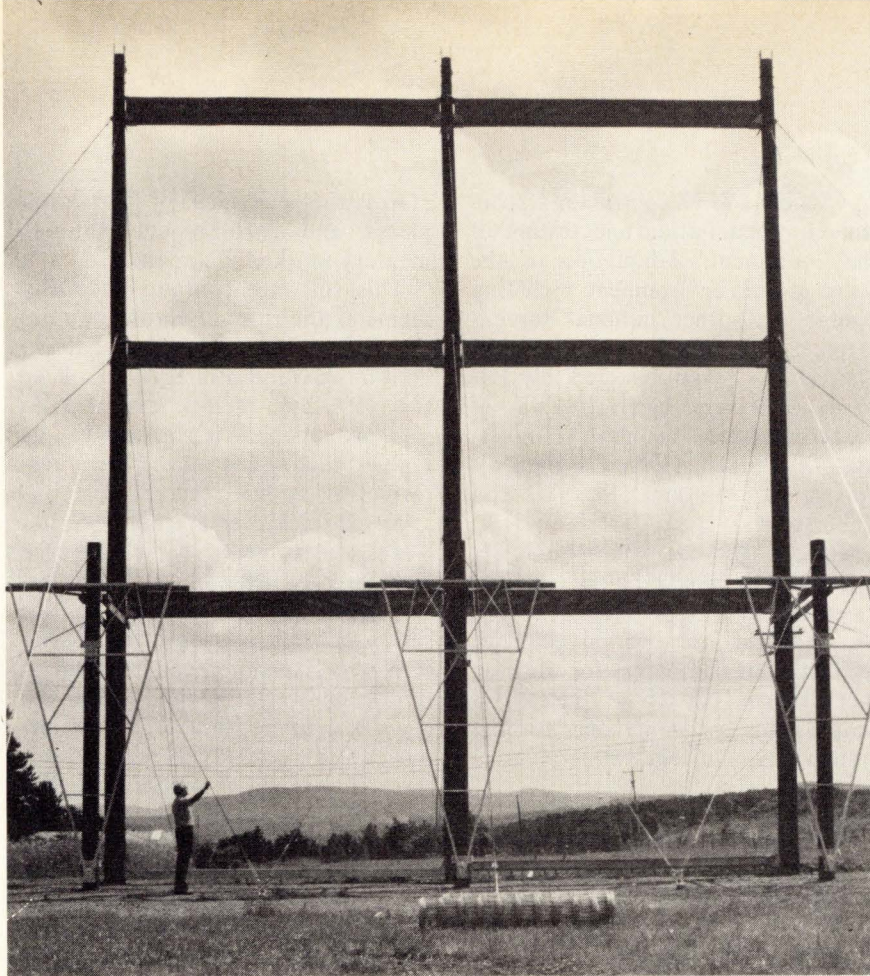

Big ear. Breadboard of backscatter over-the-horizon system being built by General Electric for the Air Force's Electronic Systems division gives just a hint of its final massive size. Completed, the antenna will be 135 ft high and more than one mile wide.

ceivers, undergo analog-to-digital conversion, and be fed to a digital beam former. The receivers apply phase correction and other processing to the returned beam to define the six beams that make up the footprint.

Additional processing includes application of a two- or three-phase moving-target indicator, plus range and doppler processing before the formed beam passes to a central

processor as a series of amplitude peaks. The central processor forms target tracks from those peaks by applying a sequential detection and tracking algorithm originally developed by GE for sonar applications.

Finally, the displayed tracks will be compared with flight plans and pilot position reports provided by the Canadian Ministry of Transport over a computer-to-computer link from Gander, Newfoundland. □

Close to \$300 million in electronics to be awarded for NATO's Awacs

British, German, and Canadian companies stand to gain an estimated \$400 million in offset work, about 75% of it in electronics, as a result of NATO's impending \$2.44 billion purchase of the E-3A Awacs (Airborne Warning and Control System). NATO defense ministers are expected to give the final go-ahead

to the project, the largest buy in the alliance's history, at a special meeting tentatively set in Brussels for Feb. 24 and 25.

The warning system for NATO includes 27 Boeing Co. 707 jets designed to carry out radar surveillance, detection, and tracking of hostile aircraft. The aircraft will

work with existing ground defense and communication facilities including Nadge (the NATO air defense ground environment).

To be worked out. Many of the details—including what companies will manufacture what—still must be worked out. It appears that about 80% of the cost of the system will be paid by the U.S., West Germany, the United Kingdom, and Canada, with the rest coming from smaller NATO members. So far, many of the program's teething pains have involved finding a formula to permit widest possible participation of member countries in the systems' manufacture. Aircraft deliveries will begin in late 1980 and end in 1985.

The heart of the system is the Westinghouse 360° look-down radar, whose mushroom-shaped antennas are in a Rotodome mounted on the 707 fuselage, plus a variety of sophisticated systems for data processing, communications, and weapons command. About 60% of the overall price is for airborne systems.

Except for some \$110 million earmarked for Pratt and Whitney TF-33 engines, the rest of the money goes for modifications to the existing ground system, an avionics maintenance and training laboratory, mission and flight deck simulators, and initial spares. Systems include the sophisticated Westinghouse radar, the IBM central data processor, and Hughes Aircraft time-division multiple-access digital transmission system.

Each government's share of the contracts will depend on the relative size of its contribution. West Germany seems likely to pick up 25% of the bill, with the UK and Canada paying 18% and 8% respectively. The U.S. share is reported at 28%.

Plans last December earmarked contracts for parts of the central data-processing unit and the TDMA system for West Germany, while parts of the radar were targeted for UK firms. It is also expected that the English company, Redifon, which is producing the flight-deck simulator for the U.S. Air Force, will also produce it for NATO.

Other contracts will involve the

Electronics review

Boeing interface adapter, a system linking the central data processor, the radar, the identification friend-or-foe system, and communications and navigation equipment. Also to be ordered are multiple displays produced by Hazeltine, on-board test equipment, part of the Northrop navigational system, and some work on ground support including the maintenance laboratory and simulators. Final assembly of many of the sophisticated subsystems, particularly the radar and data processor, will probably take place in the U.S. using European-made components.

European integrator. Aircraft will be produced at Boeing facilities in Seattle. The planes are to be delivered, with Rotodome installed,

to possibly a U.K. contractor responsible for installation and testing of the equipment. Adaptation of the NATO ground environment, including Nadge and other national surveillance, command, and control systems, is being handled by Eutronic, a Brussels-based grouping of six companies including Hughes, AEG-Telefunken, Hollandse Signaal-apparaten, Marconi, Selenia, and Thomson-CSF.

Selection of companies for offset work is being handled by Boeing and its subcontractors. Hughes Aircraft, for example, is reported to have selected four companies for work on the airborne portion of the TDMA. Seven firms are contenders for the system's ground segment. □

Consumer

Microprocessor takes on all comers in electronic chess game to sell for \$200

Gambling on software developed by one of its engineers who began by working in his spare time at home, a small hearing-aid manufacturer in Chicago is entering the consumer electronics business with an electronic toy that sells for \$200. The company's Chess Challenger is an expensive, sophisticated microprocessor-based chess game, complete with board, chess pieces, and alphanumeric display. It will go on sale later this month at the Nieman-Marcus store in Dallas.

Other retailers are expected to follow quickly. "We originally thought we'd sell about 50,000 this year," says Myron M. Samole, the attorney who, with his brother Sidney, owns the game's developer, Fidelity Electronics Ltd. "But based on the response we saw at last month's Consumer Electronics show in Chicago, we figure 100,000 will be the minimum." Almost every major retailer in the country has placed at least a sample order with

the firm since the show, he says.

The chess player's opponent is an 8080A-type microprocessor made by Nippon Electric Co. It works with an 8224 clock generator/driver, 8228 system controller, 512 8-bit bytes of NEC's random-access memory that

stores the positions of the chess pieces, and a 16,384-bit read-only memory masked in Japan.

This software contains such elements as the rules of chess, the relative importance of the pieces, allowable moves, and strategies. To keep the 12½-by-8-inch chessboard as thin as possible—it's about 1¼-in. high—Fidelity has moved the transformer to the line cord.

Keyed in. Moves are entered on a Texas Instruments calculator-type keyboard buried under a Mylar-coated surface and displayed on four seven-segment light-emitting diodes. The microcomputer can respond in milliseconds, "although we've delayed the microprocessor's counter-moves a few seconds so people won't think they're playing with a calculator," Samole says. Two additional LEDs are used to show that the microcomputer has the player in check, and for it to admit defeat.

"An average chess player can beat the computer 25% to 75% of the time, depending on how carefully he plays," Samole says. The keyboard can be used at any time to verify the position of each chess piece.

The microcomputer plays by the book, working on the weighted values of the pieces, completely scanning the board for the best move

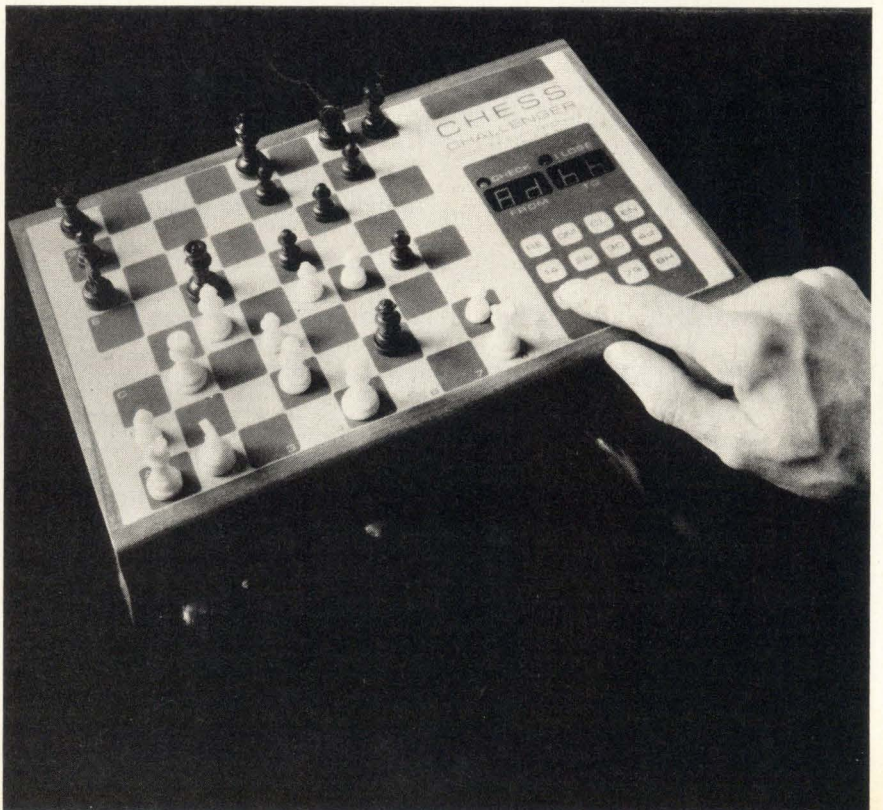

Challenger. Chess moves, punched in through keyboard, are displayed on LEDs in chess game from Fidelity Electronics.

Power supply engineers

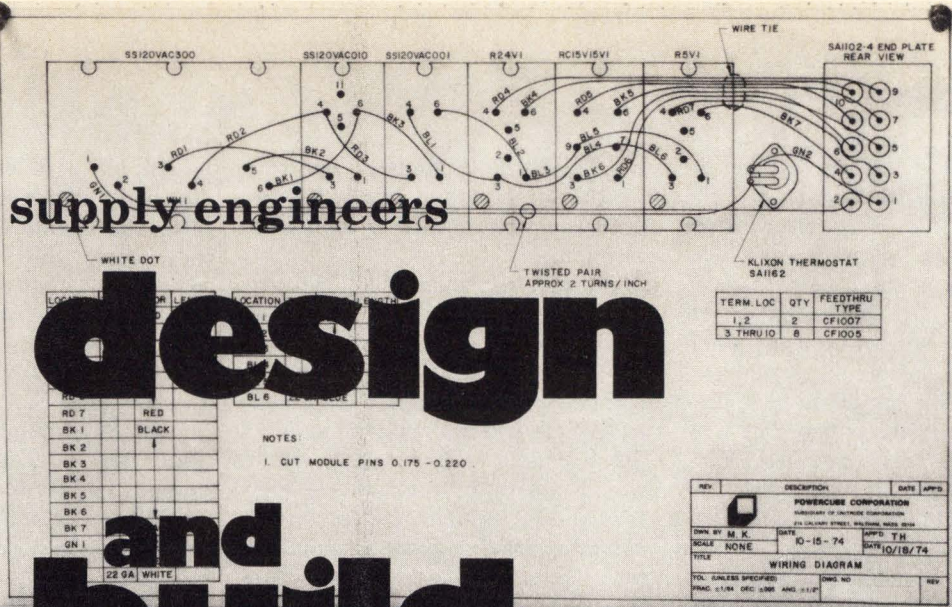

design

and build

with Cirkitblock® modules

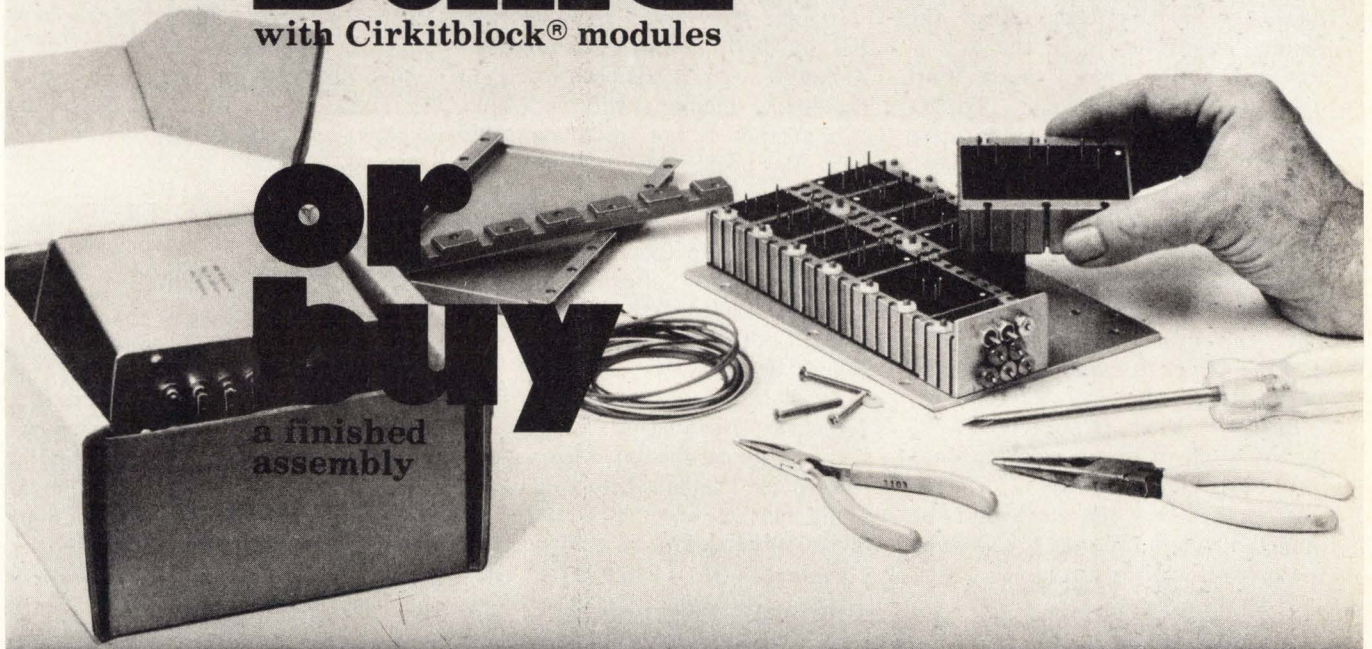

or buy

MIL standard Cirkitblock modules give you the option to design and build your own custom power supply. Or put us to work building a finished supply for you. You'll spend your time maximizing design and performance without getting bogged down in component selection, vendor delays and time consuming breadboarding. These pre-engineered modules meet the most demanding specs for sophistication, weight, environment, ruggedness, reliability

and performance (i.e., MIL-STD-704A, MIL-STD-461 and environmental conditions of MIL-E-5400). They allow you to synthesize an infinite variety of power supplies while providing all you need for your finished power source. Next time your program calls for a MIL standard power supply, contact Powercube and find out how you or we can optimize the design and save money using Powercube® Cirkitblock modules.



POWERCUBE CORPORATION

214 CALVARY STREET, WALTHAM, MASS. 02154 (617) 891-1830

SUBSIDIARY OF UNITRODE CORPORATION

TWX-710-324-0300

each time. "It plays aggressively, it tries to control the center of the board, and if it's in trouble, will try for a stalemate," Samole says. The program accepts and performs castling and *en passant* and automatically turns pawns into queens when they reach the last rank.

Fidelity has a harder-to-beat program waiting in the wings. The new program requires about five kilobytes of 8-bit memory, and the firm will upgrade any Chess Challenger for \$75 after June 1.

Samole, concerned about competitors trying to duplicate his machine, has tried to make it tough for them. For one thing, he won't disclose the name of his engineer. Also, the printed-circuit board in the unit is fastened to a metal plate that conceals the components. "To get into the electronics, the walnut case must be destroyed," Samole says. And perhaps some of the electronics will be destroyed in the process.

Nothing yet. An earlier electronic chess set demonstrated in breadboard at last year's American Toy Fair [*Electronics*, March 4, 1976, p. 44] has yet to make it to market. Leslie Berger, president of Cardinal Industries Inc., Brooklyn, N.Y., claims his firm is still working on a unit based on a Mostek Corp. F8 microprocessor. But he won't be pinned down and refuses to say when the product will be available. □

Home-VTR battle moves into U.S.

The fierce competition among Japanese makers of home video-tape recording systems has spilled over into the U.S. market, damping hopes for settlement on a single standard format. Early this month Zenith Radio Corp., No. 1 in U.S. sales of color-television sets, announced it would market Sony Corp.'s Betamax home VTR. But this potent combination will face other strong contenders led by Victor Company of Japan, which in September came out with its own Video Home System (VHS),

priced at \$890 in Japan. Total sales in the U.S. could reach 100,000 units this year, according to industry estimates.

JVC has agreements with Hitachi Ltd., Sharp Corp., and Mitsubishi Electric Corp. in Japan. Its most powerful ally, however, is parent company Matsushita Electric Industrial Co., which finally announced just a couple of months ago that it would make and sell the 2-hour-format JVC system. Matsushita is Japan's largest color-TV manufacturer and, with its Panasonic Co. of America, could provide lots of clout in both markets.

Sony presently dominates sales of the home recording systems with its basic \$1,000 1-hour-format unit. But to counter JVC, it has been forced to develop a machine with a 2-hour format that is not interchangeable with its own 1-hour format (see *International Newsletter*, p. 53). In addition, Sanyo Electric Co. and Tokyo Shibaura Electric Co., which will continue to offer their jointly developed V-Cord II system at well over \$1,000, have cast their lot with Sony's Betamax.

In short, although the Electronics Industries Association of Japan is trying to move the Japanese makers toward one standard before its infant home market becomes confused, it appears there will be no truce. To complicate the technical situation further, Matsushita has also developed and is marketing yet another VTR system, the VX-2000, a low-priced (\$730 in Japan), single-head player. Quasar Electronics Co., a division of Matsushita Electric Corp. of America, recently began marketing this machine in the U.S. as the VR-1000 for a price of \$995. Quasar's deck, which is made in Japan, plays both 100-minute and 120-minute cassettes.

RCA too. As for the No. 2 U.S. TV maker, RCA Corp., industry sources say it will probably have a system on the market by the second half of this year. The company is evaluating all of the formats and will probably sell a purchased machine at first. But if RCA decides on Betamax, there is some question whether Sony could

supply it with enough decks. The Japanese firm is straining to meet its own and Zenith's needs. Therefore, RCA could lean toward JVC, with which it has had friendly relations.

Zenith has not disclosed retail prices yet, but expects to begin volume sales of 2-hour playing decks in the fall. Sony will supply the machines to Zenith's specifications. Also, the Chicago-based company intends to put out a combined video-tape recorder and television receiver in a high-end console and to provide a black-and-white-TV camera and mike for recording at home. In addition, it will sell blank tape cassettes and handle service through its established network. However, the firm has not abandoned its plans for a video-disk system. □

Medical

X-ray system gets digital controller

Despite the increasing use of lower-dosage X-ray techniques, there is still a \$460 million annual market for conventional film X-ray equipment. In the hope of garnering a larger market share, Litton Medical Systems division has designed a digitally controlled single-phase X-ray generator that is one of the first to rely heavily on solid state.

"At the moment, the larger firms are ignoring innovations in direct shadowgraph [film-producing] X-ray equipment to go after the high-technology markets, such as computerized tomography," says John E. McIntyre, market manager for diagnostic X-ray apparatus at the Des Plaines, Ill., division. "We see the void as an opportunity to get an increasing share of the business."

The 650S generator made its debut late last year in Chicago, at the annual meeting of the Radiological Society of North America, and the first production units are now being shipped. Basically an analog system, it uses an auto-transformer and a high-tension transformer to translate line voltage to the 150-

EVERYTHING YOU NEED TO KNOW ABOUT BUYING A PROM PROGRAMMER IN SIX EASY LESSONS.

1. **Select a programmer that's universal** — as opposed to **one that's dedicated**. Choose a programmer that can program all 200 plus PROMs currently available on the market. This eliminates the need to buy additional programmers to accommodate different PROMs and gives you maximum flexibility — unrestricted by PROM type or manufacturer.

A universal programmer does away with unnecessary investments in costly capital equipment.

2. **Select a programmer that can program generic PROM families with a single personality card set**. Many programmers require multiple card sets to program PROMs with identical family characteristics. These extra card sets can cost as much as \$400.00 each. A programmer that uses generic personality card sets will eliminate this requirement and save you time and money.

3. **Select a programmer system that's approved by PROM manufacturers**. Make sure the programmer manufacturer can supply you with approved programming specifications. Otherwise you run the risk of wasting PROMs and time.

Approved specifications reduce your programming costs and help you reach 100% yields.

4. **Select a programmer that you can calibrate**. This will eliminate the need to return the programmer to the manufacturer for costly calibration. Programmers you can calibrate will continually perform to PROM manufacturers' specifications.

This saves time, saves money, increases yields and assures you of uninterrupted production.

5. **Select a programmer manufacturer that will help you reach 100% yields**. A good manufacturer will keep you updated on new PROMs and programming specification changes based on the latest input from PROM manufacturers.

A good programmer will also be supported by a direct factory sales and service organization staffed by knowledgeable people who know the products and can answer any of your questions.

6. **Select a programmer capable of ROM emulation**. ROM emulation saves time and money during software development and insures that the first PROM you program works.

ONLY DATA I/O AND DATA I/O PROGRAMMERS PROVIDE ALL OF THESE BENEFITS.

Programmers from \$1095.00.

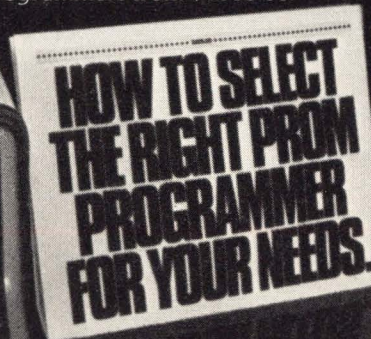

Let us send you our fact-filled tabloid *HOW TO SELECT THE RIGHT PROM PROGRAMMER FOR YOUR NEEDS*. For your free copy, simply circle reader card or contact Data I/O Corporation, P.O. Box 308, Issaquah, WA 98027. 206/455-3990.

DATA I/O

THE PROM PROGRAMMER PEOPLE.

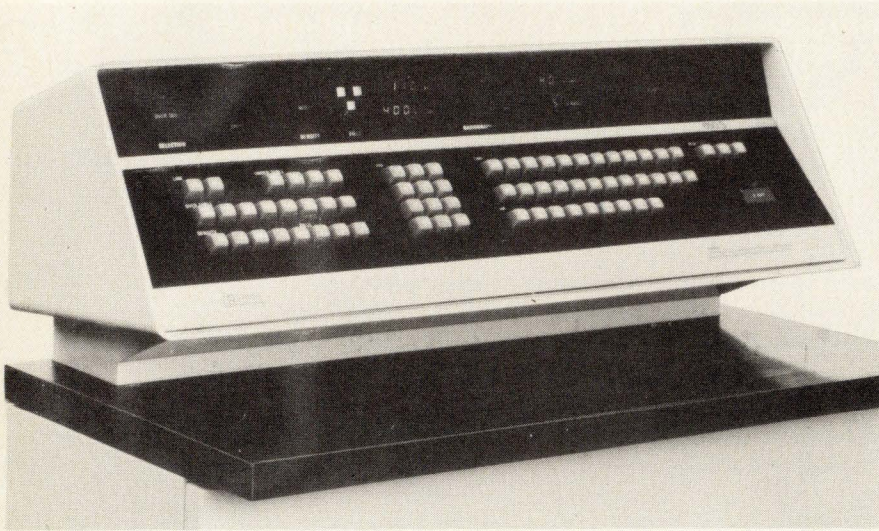

Neat look. Operator's panel of the digital controller developed by Litton's Medical Systems division for an X-ray generator resembles what one would expect to find on a computer.

kilovolt output required by the X-ray tube. "But it's under total digital control," says project engineer Fred Budelman.

Digital control adds significantly to the generator's reliability which, McIntyre says, will be a strong selling point. He also lists lower manufacturing costs and smaller size as reasons for Litton's switch from the traditional electromechanical approach to controls.

Desk change. The most visible changes in the generator are at the operator's desk, where Litton has stripped out banks of electromechanical switches, potentiometers, and analog-meter displays. Instead, the control panel is built around a Hall-effect keyboard from Honeywell's Microswitch division, Freeport, Ill., and 24 seven-segment light-emitting diodes that indicate current, voltage, and time—the exposure-control parameters.

"Digital displays don't stick or go out of calibration like meter displays do," comments Budelman. Key-switch inputs are multiplexed onto a data bus, eliminating two or three wires per mechanical switch. The keyboard also allows a technician to select the X-ray procedure to be performed, such as chest X ray or mammography.

Analog circuitry is needed for the basic servo system that varies the unit's autotransformer. It also keeps

parts count down in some calculations, including an optional unit that warns when the X-ray tube is overheating. But most of the rest is complementary-metal-oxide-semiconductor logic. "An X-ray system is a noisy environment, and we need the noise immunity of C-MOS," as well as the technology's LSI capability, Budelman explains.

The generator—which needs only a tube unit for a complete X-ray system—is priced from \$17,000 to \$27,000, depending on options. That's about the same as earlier systems with comparable functions and power levels, McIntyre says.

Future designs will probably have an even higher digital content, perhaps including microprocessors. "When we start building in self-diagnosis and self-calibration capabilities, we'll need the computing power," Budelman points out. □

Military

Slight cut leaves Tomahawk unhurt

That things are not always what they seem was demonstrated again in Washington when Secretary of Defense Harold Brown appeared to be ordering a slowdown in the Navy's Cruise missile program. That is how

most of the news media construed Brown's reversal of the January decision of the Defense Systems Acquisition Review Council to go ahead to the tune of about \$25 million with full-scale engineering development of the antiship version of the Navy's Tomahawk. But the antiship missile represents only a small segment of the total Navy and Air Force Cruise programs.

Go-ahead given. While Brown was getting media mileage out of overruling the review council, the Naval Air Systems Command got approval for \$25.1 million on two contracts for full-scale engineering development of the more complex and costly Tomahawk land-attack version. This includes \$5.4 million for the guidance system to McDonnell Douglas Corp.

The new fiscal year package of nearly \$403 million for the separate but, say some critics, duplicative, Air Force and Navy subsonic Cruise missile efforts—\$168.4 million for the Air Force, \$234.3 million for the Navy—demonstrates that the services are running hard to get their systems into inventory before a new round of strategic arms limitation talks.

Moreover, the antiship Tomahawk, the critic adds, is one the Navy doesn't need anyway "because they already have an antiship cruise missile in McDonnell's Harpoon."

Harpoon, with its 75-mile range, does not match Tomahawk's proposed 300-mile range, however. The Navy antiship version of Tomahawk would require an active radar target-acquisition and guidance system like the Harpoon has, one which is different from the Air Force and Navy land-attack versions. These match terrain contours under the missile's flight path against digitized terrain signatures in its on-board computer to guide it to a target [*Electronics*, Oct. 2, p. 39].

Development at Convair. The land-attack Tomahawk, is under development at General Dynamics' Convair division in San Diego. The Navy wants to begin procurement in fiscal 1979 and become operational the following year. The Air Force,

SORENSEN IS THE SOURCE:

FOR THE LARGEST SELECTION OF HIGH-POWER, HIGH-EFFICIENCY POWER SUPPLIES.

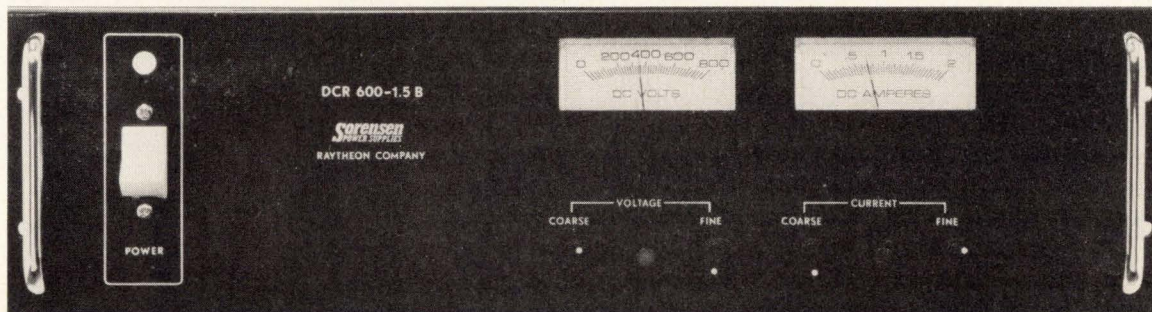

The Sorensen DCR series for component burn-in, aging racks, test equipment, and general laboratory use.

- 12 package sizes in 8 voltage ranges, from 0-10 to 0-600V
- 60 current levels from 0.75 to 1000 amps
- Remote voltage, current, or resistance programming
- Constant current operation with automatic crossover
- No overshoot with turn-on, turn-off, or power failure
- Stocked for immediate delivery
- 5-year warranty, backed by a worldwide service organization

Call us and we'll give you the details: (603) 668-4500.
Sorensen, a Raytheon Company, 676 Island Pond Road,
Manchester, N.H. 03103.

SORENSEN
POWER SUPPLIES

A Raytheon Company

Spend it or lose it: Brown

As Air Force and Navy Cruise missile development proceeds, the Secretary of Defense, Harold Brown, indicated in his first congressional appearance on the fiscal 1978 spending program that he will hold other systems outlays to amounts that can be usefully spent in the year. This reflects his desire to cut unspent dollar carryovers from one fiscal year to another [*Electronics*, Feb. 3, p. 58].

The most visible and potentially most controversial of the Carter Administration's proposed changes could come in Rockwell's B-1 bomber [*Electronics*, Nov. 29, p. 49]. Brown would slip fiscal 1978 production to 5 planes from the 8 proposed in the Ford budget; however, a final decision is pending. Military estimates are that his proposal might chop one-third from the \$1.7 billion procurement.

But Brown is firm in his plan to cut back on outlays for expensive, heavy ships like the new strike cruiser. Yet his proposal to reduce the fiscal 1978 purchase of SSN 688 attack submarines from two to one—for a possible \$200 million saving—is based more on a doubt that the Navy can spend the money in the next fiscal year, rather than on reasons of economy. So is the \$400 million to \$500 million cut in the proposed allotment of \$1.74 billion for 108 of the Air Force F-15 Eagle fighters being manufactured for the service by McDonnell Douglas Corp., St. Louis, Mo.

meanwhile, is proceeding with its Boeing AGM-69 Cruise missile to be used on the B-52 and B-1 bombers. Its fiscal 1978 budget request of \$164.5 million includes \$40.6 million for the first procurement of long-lead-time items. The service also has tucked another \$3.9 million in next year's R&D budget to explore a mobile ground-launched version of the missile.

At the moment, the Air Force-Navy land-attack models have only the technology of their McDonnell Douglas terrain-contour guidance systems in common. Yet the services may be obliged to consolidate the management of the program under a single director. Brown is seriously considering consolidation, a prospect raised by his predecessor, Donald Rumsfeld. □

Memories

Bell installs its first bubble memory

After almost 10 years of developing magnetic-bubble technology, Bell Laboratories is trying it out in one of the Bell System's phone companies, but in a quite modest way. Thin-film garnet chips, each with a storage

capacity of 68,121 bits, are being tested in a recorded-message machine in the Detroit switching office of Michigan Bell Telephone Co. The machine stores such messages as "We're sorry. You have reached a nonworking number."

The bubble memory, housed in a basic, four-chip package fabricated by a Bell Labs/Western Electric Co. team, measures 1.2 by 2.2 by 0.6 inches, has 32 output pins, and is shielded by a Permalloy outer case against external magnetic fields. The total storage capacity of approximately 272,000 bits holds about 12 seconds of digitized voice.

Six-month trial. The message machine, dubbed the 13A announcement system, will undergo a six-month trial in Detroit. Storing up to eight different messages, the 13A replaces a machine that stored recorded messages on a magnetic drum, but those messages eventually degraded and had to be re-recorded—magnetic bubbles will virtually eliminate that task.

The relatively small capacity of each chip definitely makes this a modest test of the bubble-memory technology. Bell itself claims to have stored as many as a quarter-million bits on a single chip, and other companies, though they may not have reached this number, have

made and are applying chips with higher storage capacities than the Bell chip being tested.

Texas Instruments, for example, is running in-house trials of a chip with a 92,304-bit capacity [*Electronics*, Sept. 30, p. 29] and is working on memory units incorporating 16 chips. Also, Rockwell International Corp.'s Autonetics Group is putting 102,400 bits on a chip and is developing a memory package with 16 chips or more than 1.6 million bits [*Electronics*, Jan. 6, p. 31]. □

Computers

Personal computer adds to bare bones

Many machines for the computer hobbyist are fairly bare-bones systems, and the extra software and peripherals required may shoot costs up to anywhere between \$1,500 and \$3,000. But there's a personal computer being brought to market that, for \$987.54, has enough software and peripheral hardware to handle a fair array of applications. The only extra items needed are an ordinary television set, hooked up to act as a display device, and a tape-cassette recorder to handle loading, program storage, and "mass" memory.

The new machine, "MicroMind," comes from ECD Corp., a small company in Cambridge, Mass. When the company was organized in late 1974, it wasn't aiming at personal computers. Its first product, shipped in volume in mid-1975, was a hand-held capacitance meter. It has since added a digital thermometer to its line [p. 148].

Growing market. The move into personal computers was made to bring ECD into a young market that it expects will grow handsomely. A company spokesman says it already has orders for 200 MicroMind units, which it introduced this week in New York. The firm believes it could sell as many as 5,000 this year, although this would represent an unusually large percent of the total market. Venture Development

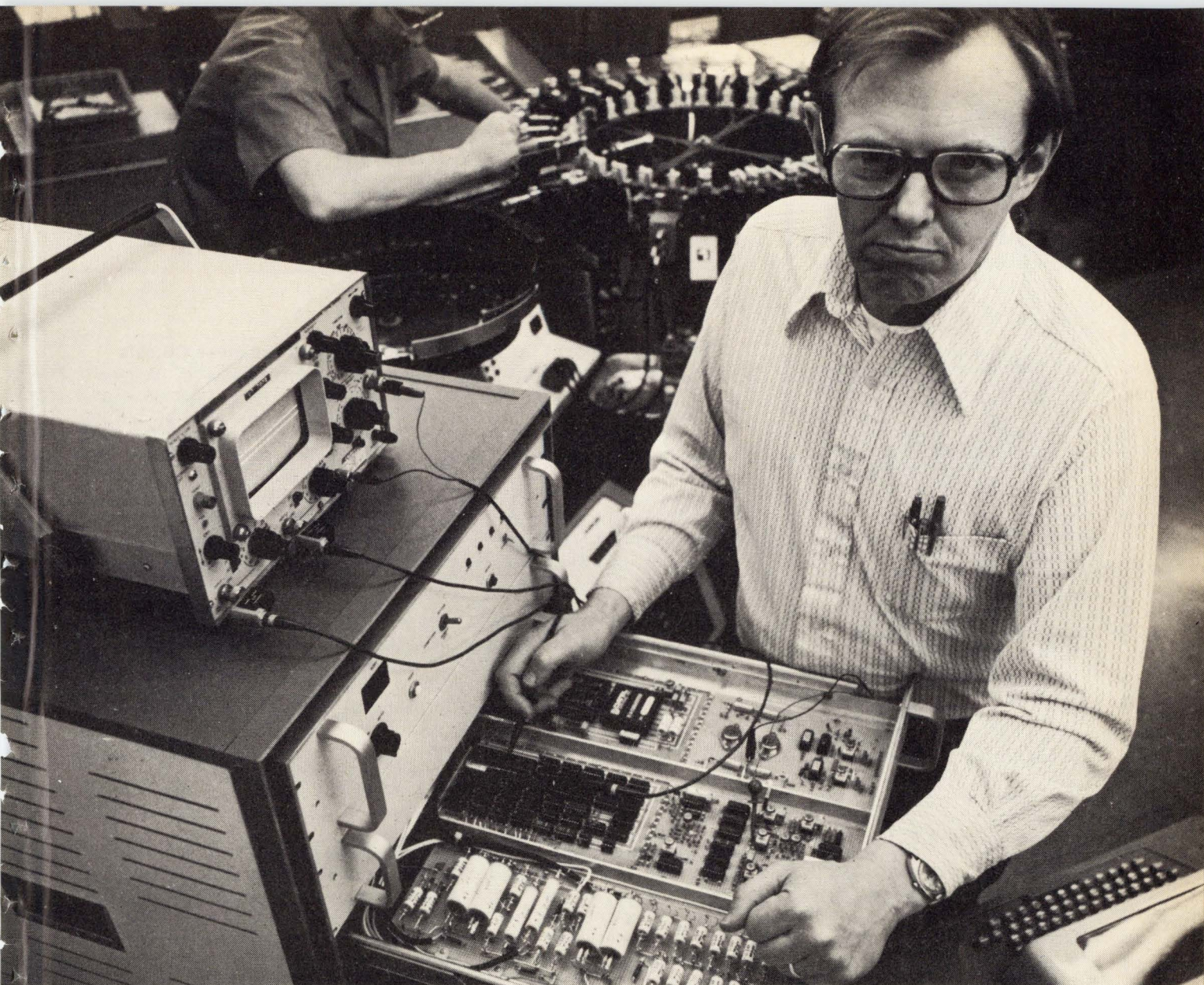

How to prevent your microprocessor from getting the shock of its life.

Transient voltages can give your microprocessor or IC configuration a lethal shock. And, unfortunately, there is simply no way to predict when they'll happen.

But you can prevent those transient voltages from destroying your microprocessor, causing system downtime and adding costly service calls.

All for less than \$1.

Introducing the Unitrode TVS505 Transient Voltage Suppressor Series.

It can dissipate 500 watts of peak pulse power. And it reacts almost instantaneously—about 1×10^{-12}

seconds. And all devices come in a highly reliable miniature glass encased package.

This means your microprocessor is protected in the most hostile electrical environments. Even under the worst sort of "noisy" factory conditions.

Standard devices are available covering all popular application voltage levels from 5 volts to 28 volts. (Higher voltage levels for special requirements can be obtained on request.)

And Unitrode delivers fast. In the

quantity you need.

The Unitrode 500W Transient Voltage Suppressor.

It takes a lot of shock, so your components don't.

Circle the reader service card and we'll rush you a data sheet/application note. Or drop us a line on your letterhead indicating your system power supply voltage levels and we'll rush out sample devices.

Unitrode Corporation,
580 Pleasant Street, Watertown,
MA 02172

Phone: 617-926-0404.

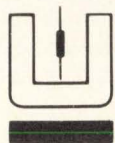

UNITRODE

Circle 39 on reader service card

1500-watt Switcher!

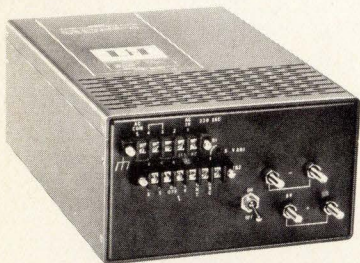

You get a power density of 2.4 watts/in.² in LH's 800 series 5-volt, 300 amp switcher. Priced less than a dollar per watt, this super switcher offers up to 80% efficiency, excellent reliability, and is constructed modularly to make maintenance easy. Major specs include:

- Compact size—5.25" H. x 9.12" W. x 14.38" D.
- Output voltage—5V DC, 300 amps, 1500W max.; other voltages include 2V, 12V, 15V, 18V, 24V, 28V.
- Line regulation—0.2% for 10% line change.
- Load regulation—0.4% from zero to full load.
- Response time—200 μ sec for a step load change of 25% at 5A/ μ sec.
- Over-voltage protection—factory set at 125% \pm 5%.
- Forced air cooling.

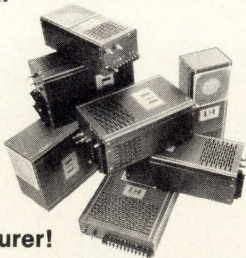

World's largest switcher manufacturer!

The LH 800 typifies the high-reliability, easy-to-maintain switchers LH Research offers. Nobody packs more power in smaller packages or offers a broader line of switchers than LH Research. 1 through 6 outputs. Up to 2.45 watts/in.². Up to 65 watts/lb. Up to 80% efficiency. At less than 65¢/watt in quantity.



LH RESEARCH, INC.

1821 Langley Avenue, Irvine, CA 92714
(714) 546-5279

Electronics review

Corp., a Wellesley, Mass., consulting firm, predicts that 25,000 personal computers will be sold this year [*Electronics*, Jan. 20, p. 26].

The MicroMind is aimed at two kinds of users, says ECD marketing manager, Edward Costello. One is the software novice who is experi-

News briefs

U.S. firms ponder FCC withdrawal from testing Japanese CB sets

The Federal Communications Commission's unexpected ruling this month that surrenders to the Japanese responsibility for type acceptance and certification of citizens' band radios imported from Japan has caught the American CB community flat-footed. Japanese firms supply most U.S. sets anyway, so importers and American firms subcontracting their production were delighted with the promise of accelerated shipments. "I'm not sure we like it," says Motorola CB specialist Ron Polanski in an effective summary of U.S. manufacturers' initial reaction. Japan's Ministry of International Trade and Industry is naming two laboratories to test the sets. This will lift the load from the FCC, which last year began testing samples of CB models before approving them for U.S. sale.

Delay sought in tightening of CB interference standards

The Electronic Industries Association wants a six-month delay in the FCC's proposed new Docket 21000 to reduce CB transmitter interference with television signals and other spectrum uses. The FCC notice proposes to reduce spurious and harmonic CB emissions to 100 decibels below the mean output for such emissions that are more than 250% from the center of the authorized bandwidth. John Sodolski, the EIA's vice president for communications and industrial electronics, says the request for a delay is based on the need for more experience with the new 40-channel CB sets and for greater discussion of the problem between makers of CB and TV sets.

NCR enjoins Nitron on electrically alterable ROMs

NCR Corp. and its licensee General Instrument Corp. are moving in the courts to prevent McDonnell Douglas Corp.'s Nitron division in Cupertino, Calif., from benefiting from the expertise in electrically alterable read-only memories a new Nitron employee developed while an NCR scientist. The two plaintiffs have filed lawsuits alleging their trade secrets are endangered by Nitron's hiring late last year of Wendell Spence, former manager of research and development for NCR's Microelectronics division. The Temporary restraining orders, granted by a California Superior Court judge, will be in effect until a hearing on motions for preliminary injunctions is completed. The orders enjoin Nitron from selling any electrically alterable ROMs using NCR's trade secrets and prohibit Spence from working for Nitron in that field.

TRW stakes a claim to fiber-optic market

The potential of fiber-optic communications is attracting another major U.S. firm. At the U.S. Independent Telephone Association meeting this month in Kansas City, TRW Inc., Redondo Beach, Calif., used its Vidar division's pulse-coded-modulated terminals to multiplex signals from 24 telephone circuits into a 1.544-megabit-per-second stream, with two signals again multiplexed into a 3.1864-Mb/s stream that was then transformed into infrared optical impulses transmitted through a glass fiber. A detector in the optical receiver of the demonstration unit converts the light pulses to electrical signals.

Honeywell jumps into distributed processing

Honeywell Inc.'s Information Systems group in Waltham, Mass., is jumping into the distributed-systems market with additions to its Series 60 computers and related communications equipment. The new models include four host processors, a front-end network processor, two remote batch terminals, and a low-cost display terminal. A new 66/85 host processor is the top of the line in the Level 66 large-scale system. It has a main memory configurable to two million words and costs \$4.5 million to \$7.5 million.

DUAL COIL CIRCUIT BREAKER

reacts to both
voltage and current.



Smaller, Lighter, Less Expensive. The Airpax Dual Coil Circuit Breaker is a single pole magnetic circuit protector that reacts like a two pole breaker but is smaller, lighter, and less expensive.

Wide Variety of Applications. In addition to conventional circuit protection, the Airpax Dual Coil Circuit Breaker can be used in conjunction with a temperature transducer to protect heat-sensitive equipment such as power supplies. By connecting a sensing device to the voltage coil, it can be used in interlock circuits or can react to pressure, flow, weight, or fluid level.

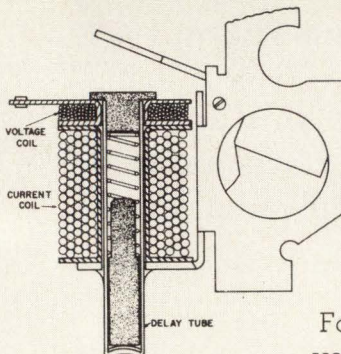

Current Coil Ratings. The current coil ratings are from 0.050 to 30 amperes at 65V dc or 250V ac maximum, 60 or 400 Hz. (Other models to 100 amperes.)

For more detailed information, call your local Airpax representative or contact Airpax Electronics, Cambridge Division, Cambridge, Md. 21613. Phone (301) 228-4600. Telex: 8-7715. TWX: 865-9655. Other factories in Europe and Japan. European Sales Headquarters: Airpax S.A.R.L., 3 Rue de la Haise, 78370 Plaisir, France.

AIRPAX™
THE PRO IN PROTECTION

REST IN PEACE



The brittle bodied, grease shrouded warrior is forever gone — replaced by resilient, efficient Cho-Therm 1661.

This new grease-free, thin and flexible thermal interface material proved too easy to apply and carried BTU's too well.

Hail & Farewell BeO.

Copies of the eulogy (our 1661 specs) are available on request!

CHOMERICS

77 Dragon Court
Woburn, Ma. 01801
(617) 935-4850

Electronics review

enced in electronics hardware. The other is the programmer who isn't interested in assembling a kit.

For the purchase price, the buyer gets a fully assembled and boxed system built around three circuit boards—the central processor board with the MOS Technology Inc. 6512A microprocessor and 8,192 bytes of semiconductor random-access memory, a display processor board that includes 2,560 bytes of display memory, and an input/output board that includes a power supply with ± 5 -volt and ± 12 -v outputs.

Every microprocessor board has sockets for 16,384-bytes of dynamic random-access memory; 8,192 bytes are supplied with the standard system. Memory capacity can be expanded by adding 32,768-byte memory-expansion boards.

Also included in the basic price are an 80-key ASCII keyboard with keys that can be defined by the user with software, a radio-frequency modulator that allows the computer to be connected directly to the TV set's antenna leads, and the all-important software. According to ECD president Jerry Roberts, the software consists of an interactive editor, assembler, monitor, cassette-based file system, and an extended form of the Basic language. It enables MicroMind to be used for computation, remote job entry, or graphics display, or as an intelligent terminal.

There are also games supplied with the basic software package, including an animated space war game and Life, a game based on biology and showing the growth of an organism. The latter is quite popular with computer hobbyists. MicroMind will display a chessboard but ECD does not yet have a chess-playing program.

The firm also offers five options costing a total of \$450. All five will be included in MicroMind II, a more powerful system that will be available soon for \$1,386.54. The options are an additional 8 kilobytes of memory, analog I/O, vector interrupt, cycle suppression, and memory mapping. □

NATIONAL ANTHEM

A Review of New Products and Literature from



National Semiconductor • No. 5, Oct. 1976

Bi-FET™ Line-Up Continues to Grow

By this time we hope you know about our proprietary process that lets us marry JFET and bipolar technologies on a single, monolithic chip. We call this technique Bi-FET™ technology,

New Keyboard for SC/MP Kit Replaces Teletype™

National's new Keyboard Kit now gives SC/MP Kit users a low-cost input/output capability. The Keyboard and SC/MP Kits together form an inexpensive learning and development tool for anyone without access to a Teletype™ machine. The new kit replaces the Teletype previously required by the SC/MP Kit, yet still allows you to evaluate the SC/MP CPU and to develop a variety of application software.

The heart of the Keyboard Kit is a 512-byte ROM firmware package called SCMPKB, which replaces the 'Kit Bug' ROM supplied with the SC/MP Kit. SCMPKB lets you use the hex keyboard display to execute programs, examine or modify the contents of memory and the SC/MP registers, and monitor program performance.

The Keyboard Kit comes complete with a manual, all required ICs and

resistors, a keyboard cable-connector assembly, pre-cut wires, and wire-wrap connectors; we even supply a hand-held wire-wrap tool.

The SC/MP PC card already has a hole pattern for additional ICs. Simple instructions in the Keyboard Kit manual tell you how to add the extra circuits to the SC/MP card, replace the 'Kit Bug' ROM with the new SCMPKB ROM, and connect the preassembled keyboard cable-connector to the card. With these steps done, you're ready to go.

The Keyboard Kit is another step in the tradition of simple, cost-effective solutions to your microprocessor needs. For Keyboard Kit specifics, call your local National distributor and ask for information on the ISP-8K/400. 

Bi-FET™ n-Channel Analog Switches

Our new family of analog switches combines n-channel JFETs and bipolar transistors on a single chip for the first time—a technique made possible by our Bi-FET™ technology. And the switches built this way provide the industry's only low ON-resistance, high-speed, monolithic, n-channel, JFET analog switches.

The new switches are ideal for A/D and D/A converters, data acquisition, signal multiplexers, sample-and-holds, video switchers, and so on.

At 25°C, the Series AM181 switches (for -55° to +125°C operation) feature a 30-Ω maximum ON-resistance,

matched to 2 Ω (typical); this resistance is constant for signals to ±10 V. Switching times are 105-ns turn-on/95-ns turn-off (typ.) for a break-before-make action. Isolation and cross-talk are down 60 dB (typ.)

Four versions of Series AM181 switches are available: dual driver, SPST; dual driver, DPST; single driver, SPST; and dual driver, SPDT. Series AM181 switches are pin-for-pin, spec-for-spec compatible with the Siliconix Series DG181 hybrid parts.

The Series AM281 switches—dual driver, SPDT—are intended for operation between -20° and +85°C, and have slightly relaxed specifications. 

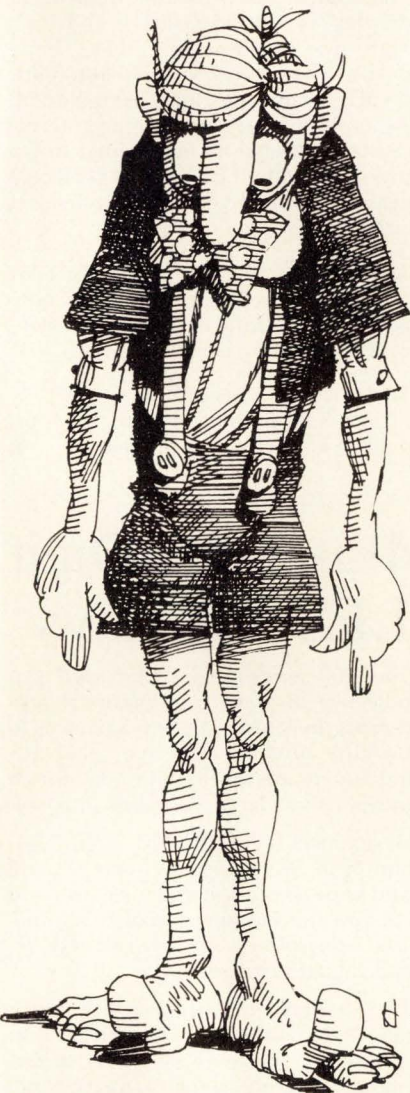

and to date each circuit built with this technology has set new standards of performance for the industry to match.

In fact, we introduced the industry's first Bi-FET products, our LF156 op amp series, almost a year ago. The available specs on these parts— I_B , I_{OS} , V_{OS} , V_{OS} drift, slew rate, and settling time—make the 156 series about the most advanced op amps in the world. And if you've heard otherwise, we'd like to

point out that National does indeed supply a plastic minidip version; just ask about our LF356N—it's been around for several months now.

We've also got the LF13741 op amp, which replaces the 741 wherever you need extremely-low input current; the LF13331 family of analog switches, which has no latch-up or static blow-out problems; the LF352 instrumentation amplifier, which combines low

input-current demand and excellent linearity; and the new LF198/398 sample-and-holds with short acquisition times, high accuracies, and low droop rates.

Of course, more Bi-FET parts are on their way. But we suggest that you find out what the unique specs of our already available Bi-FET parts can do for you now. We're sure you'll be pleasantly surprised. 

Programmer, Frequency Synthesizers for CB Use

National announces a new family of phase-locked-loop circuits for 40-channel frequency synthesizer applications in CB transceivers.

The MM55104, MM55114, MM55106, and MM55116 are for use in single- or double-I.F. systems, and operate from a single power supply (either +5 V or +8 V, depending on the type number). Each circuit contains a reference oscillator, an oscillator divider chain (10-kHz or 5-kHz outputs), a binary-input programmable divider for channel selection, and a phase detector. A 5.12-MHz or 10.24-MHz crystal determines the reference frequency.

The MM55104/114 provide a 2^8-1 division of the input frequency, while the MM55106/116 provide a 2^9-1 division. These latter two synthesizers also have 5.12-MHz outputs, which may be tripled for use as a reference oscillator frequency in two-crystal systems.

Division of the input frequency is controlled by standard binary signals, which may be set up by mechanical switches or by an external electronic programmer.

National has such a programmer. It's called the MM57150, and it generates the binary codes necessary to control 40-channel PLL synthesizers. Our space here precludes a full description of the host of features available on the MM57150, so we'll simply list a number of its more important ones:

- Initial power-up on Channel 19
- Direct, calculator-style keyboard entry of channel number is available.
- Two-speed, up/down slewing
- Direct access to Channel 9, the emergency channel, via a single contact closure
- Programmable memory bank for scanning up to ten channels in any sequence of your choosing
- Rollover on Channels 1 and 40 (i.e., . . . 38, 39, 40, 1, 2, 3 . . .)
- Scan rate of four channels/second
- Two-channel, alternating channel capability via a single push button
- Automatic monitoring of a preselected channel for 0.25 second every 10-15 seconds while active on another channel; squelch/lock capability on the monitored channel
- Adjustable squelch
- Illegal channel entry prohibited
- Transmit key locks programmer on channel (scanning stops) 

Super Savings on Super-Strong TO-126 Types

We now second-source fifty of the most popular types of TO-126 packaged power transistors. Our TO-126 products are encapsulated in National's tough Epoxy B—so strong that you'll strip the 4-40 screw mountings before you'll damage the package.

Added to our TO-126's toughness is a large cost savings. National can save you 25 percent, typically, over the competition's pricing.

We're stocking our distributors' shelves right now. And in November our distributors will advise their customers, by mail, of the new TO-126 types from National. If you're not already on such a list, call your local National distributor now to make sure you get the information on these hot new ones from National Semiconductor Corp. 

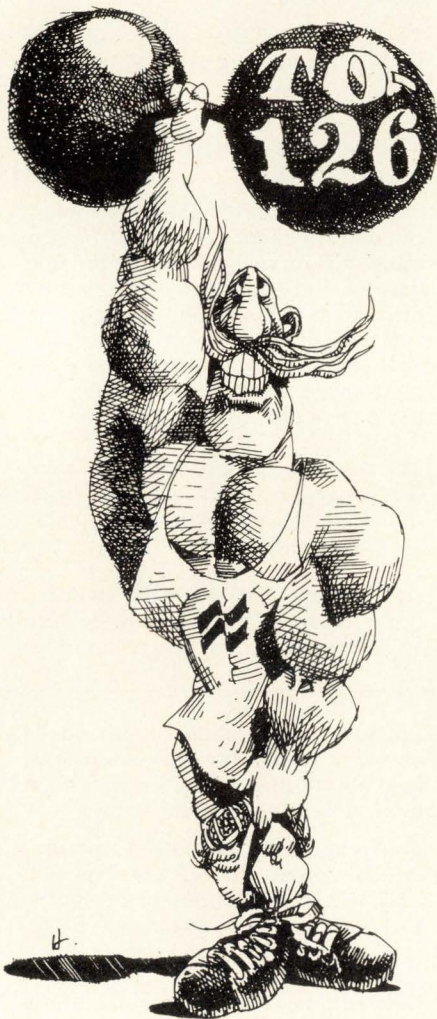

Clock Module Designed for Instrumentation, Automotive Uses

The MA1003 is a self-contained time-keeping module for a host of 12-Vdc applications; just add switches and a lens, and it's ready-to-go in bench and battery-powered instruments, CB base stations, aircraft/marine/auto clocks, and so on.

The bright, green, vacuum fluorescent display of the MA1003 is 0.3-inch high, and is filterable to blue, blue-green, green, and yellow; automatic display-brightness logic is included. Accurate timekeeping, via an internal crystal timebase, is maintained down to 9 Vdc, and all circuitry is protected against automotive supply transients and reversals.

Timesetting controls operate at a 1-Hz rate with no rollover; to prevent tampering, timesetting is locked out whenever the display is blanked.

The MA1003 pc board measures only 1.75 x 3.05-inches overall; a 6-pin, built-in connector is optional. 

4½- and 5-Digit LED Displays

The 5900-series of 0.5-inch GaAsP LED reflective displays from National represents the latest in design advances to provide you an effective, easy-to-implement answer to your need for an inexpensive, large, numeric display.

Designated the NSB 5917, NSB 5921, and NSB 5922, the new displays will find wide use in test and measurement equipment, consumer products, industrial controls, desk-top calculators, and digital instruments.

The displays offer versatility, with both common-anode (NSB 5922) and common-cathode (NSB 5921) multiplexed versions available for five full digits, and an optional direct-drive overflow/polarity indication with four digits in a common-anode multiplexed format (NSB 5917). Electrical connection is by PCB-type terminals on the edges of the display.

The optical design of this series assures a distinct, easy-to-read display with a wide viewing angle (120° total), and excellent on-off contrast and segment-to-segment uniformity. 

APPLICATIONS CORNER

High Performance, Low Power Memories from Inexpensive Parts

You can use standard, inexpensive, bipolar PROMs to build high-performance memories of low power dissipation. The secret is to power-down the chip when it is not being accessed.

The technique illustrated here results in a power savings beyond that possible with bipolar PROMs having on-chip power-down, and the cost is much less than that of CMOS PROMs of the same capacity. In fact, because the access time of the circuit shown here is less than 80 ns, the power savings can be greater than 10 to 1 if the circuit is cycled every microsecond. Longer cycle times, or decoding of the power switching to multiple packages, yields even more impressive ratios.

National's PROMs are well behaved in this application. With power removed, our Tri-State® parts revert quickly to their third state (a high-impedance open). Because there are no clamp diodes from the outputs to V_{CC} , the powered-down device presents only leakage to the output bus.

Note that in a CMOS system, passive pull-ups are desirable to establish the CMOS input level at V_{CC} when the PROM is powered down. If the CMOS input is more than a threshold away from both supply rails, the input stage of the

CMOS device may draw supply current, which will increase system power dissipation. Here it is desirable to clock the PROM outputs directly into a CMOS holding register to reduce the time that the PROM must be powered up. Also, the pnp core driver pass elements can be driven directly by an MM74C42 1-of-10 decoder output without pull-up or current limiting resistors, with some increase in effective access time.

The MM74C42 would replace the 74LS04 shown here.

In any system that switches a device's supply lead to conserve power, the power supply bypassing must be performed on the supply side of the power switch; that is, at the pnp emitter. Any capacitance at the collector of the pnp will increase both system power dissipation and access time. \square

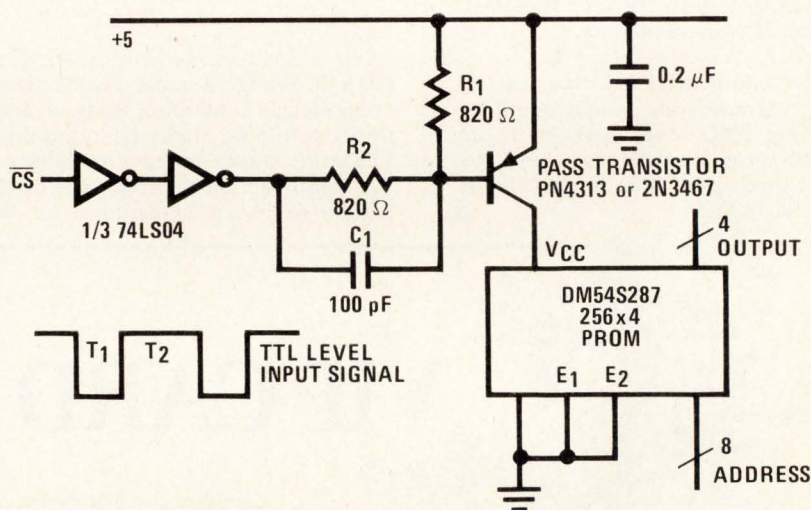

True RMS-to-DC Converter

Our LH0091 will compute the rms value of virtually any combination of ac or dc input signals from dc to 2 MHz. At frequencies below 70 kHz the accuracy is 0.05 percent; the crest factor rating is 10.

The LH0091 is thus ideal for DVMS, DMMS, for measuring audio and noise signals (or both in combination), for vibration and harmonic analysis, etc.

An extra, uncommitted, internal op amp is available, which you can use as a summing amplifier, to buffer the input or the output, to adjust the gain, or whatever.

The LH0091 also is available as the LH0091CD for commercial temperature range uses, and as the LH0091D for the military range—all at prices you cannot walk away from. \square

16,384-Bit Si-Gate n-Channel ROM

National's MM5246 static read-only memory is organized in a 2048-word x 8-bit format. It uses n-channel enhancement and depletion mode silicon-gate technology, which, boiled down, means that it's DTL/TTL-compatible and needs only a single, +5.0-V supply.

Very useful in microprogramming, control logic, and table look-up applications, and in random-logic synthesis, the MM5246 provides expandable memory through its three programmable Chip Select inputs, which control its Tri-State® outputs. The MM5246 has a maximum access time of 450 ns, and is fully decoded.

And look for still another 16k ROM that will soon be coming along. Designated the MM5247, it's organized 4kx4; all other specifications are identical to the MM5246. \square

National Announces Oxide-Isolated RAMs

The DM93415/DM93415A (open-collector) and the DM93425/DM93425A (Tri-State®) are 1024-word x 1-bit random-access, read/write memories—the first of our family of oxide-isolated, bipolar memory products.

Designed for buffer control storage and high-performance main memory applications, the DM93415/425 offer maximum access times of 70 ns, while the suffix 'A' versions offer a 45-ns access.

Other features include full on-chip decoding, separate Data In and Data Out lines, and an active LOW Chip Select and Write Enable. Fully DTL/TTL-compatible, the DM93415/415A/425/425A have a 16-mA drive capability, and dissipate 0.5 mW/bit. \square

7900-Series Regulators from National

National Semiconductor now second-sources the popular 7900-Series three-terminal voltage regulators. In particular, we now offer the 7900MK/MH/CK/CH/CT and the 79M00CP.

Since each of these parts is available in nine voltages, we are, in effect, offering 54 new regulators.

Keep in mind, however, that you can easily upgrade your system simply by replacing 7900-series parts with our LM320-series regulators; these are higher grade parts spec'd more tightly than the 7900s.

New CMOS Guides Now Available

National's new four-page *CMOS Status/Cross Reference Guide* is a concise, handy guide to 90 CD4000-series and 70 MM74C-series parts. Each part is briefly described functionally, and its production status and 38510 status at National are noted; RCA, Motorola, Fairchild, Harris, and SSS equivalent designations are listed. The guide ends with a tabulation of complete ordering information.

A New Era in CMOS Reliability—CMOS II is a three-page summary, with charts, of National's continuing study of, and improvements in, CMOS reliability. The study shows that the reliability of our improved CMOS products is comparable to that of bipolar logic.

Saturating-Output Display Drivers

We have introduced a series of saturating-output display drivers to interface CMOS calculator chips with common-cathode LED displays. The series consists of the DS8871 (an 8-digit driver), the DS8872 (9-digit), the DS8873 (9-digit, with low-battery indicator), and the DS8977 (7-digit, with low-battery indicator).

You can operate these drivers in calculator systems with a supply voltage range of 4.5 V to 9.0 V. In a 9-V system you can use the low-battery feature of the DS8873 and DS8977 to turn on the decimal point of the digit '9' when the supply voltage falls below 6.5 V. This alerts the user that the battery should be replaced, even though the calculator will still function for awhile yet.

Each driver can sink 40 mA, and is designed for multiplexed operation. The saturating-output feature permits operation with power supply voltages lower than possible in Darlington-type output display drivers, and also results in lower power dissipation in the LED driver; standby power consumption is zero. Input and output pins are located to make wiring easy.

The new series is functionally and pin-for-pin equivalent to our DS8855, DS8864, DS8865, and DS8866 family of LED display drivers.

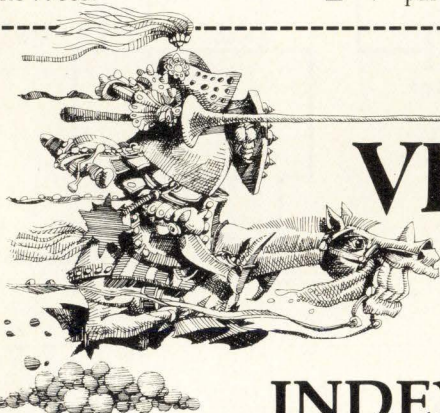

VIP CARD

Complete card and mail to
NATIONAL SEMICONDUCTOR
 Attn: Marketing Services
 2900 Semiconductor Drive
 Santa Clara, CA 95051

INDEX

Please send me the information that I have checked:

- | | |
|---|---|
| <input type="checkbox"/> Bi-FET Line-Up, Pg. A, Col. 1 | <input type="checkbox"/> 4½/5-Digit Displays, Pg. B, Col. 3 |
| <input type="checkbox"/> SC/MP Keyboard Kit, Pg. A, Col. 2 | <input type="checkbox"/> RMS/dc Converter, Pg. C, Col. 1 |
| <input type="checkbox"/> AM181/AM281 Switches, Pg. A, Col. 2 | <input type="checkbox"/> MM5246 16-K ROM, Pg. C, Col. 2 |
| <input type="checkbox"/> CB Freq. Synthesizers, Pg. B, Col. 1 | <input type="checkbox"/> DM93415/425 RAMs, Pg. C, Col. 3 |
| <input type="checkbox"/> CB Channel Programmer, Pg. B, Col. 1 | <input type="checkbox"/> CMOS Status Guide, Pg. D, Col. 2 |
| <input type="checkbox"/> TO-126 Power Types, Pg. B, Col. 2 | <input type="checkbox"/> CMOS-II REL Guide, Pg. D, Col. 2 |
| <input type="checkbox"/> MA1003 Clock Module, Pg. B, Col. 3 | <input type="checkbox"/> LED Display Drivers, Pg. D, Col. 3 |

Please send me the literature that I have checked:

- | | |
|---|--|
| <input type="checkbox"/> AN-163 Mate SC/MP
w/Cassette Recorder | <input type="checkbox"/> AN-165 3½ Digit DVM
w/CMOS Interface |
| <input type="checkbox"/> AN-164 A Data Concentrator Using PACE | <input type="checkbox"/> AN-167 DM8678 Bipolar Character Gen. |

Your End Product or Application: _____

Have Salesman Call YES NO

Please print clearly; this information will be used for our mailing list.

NAME _____ TITLE _____

COMPANY _____

ADDRESS _____

CITY _____ STATE _____ ZIP _____



Washington newsletter

ERDA to draw on Japan's electric-car technology . . .

The United States will begin to draw on Japanese electric-vehicle technology—including advanced batteries—under an information-exchange agreement being negotiated by the Energy Research and Development Administration and Japan's Ministry of International Trade and Industry. ERDA's George Pezdirtz, director of energy-storage systems, says the agreement recognizes that Japan's five-year-old national electric-vehicle program **"puts them much further along the learning curve than we are."** He cites as one example the Kobe public transit system, where battery-powered buses can exchange battery packs "in a couple of minutes" at an automated maintenance center. European nations like West Germany, the Netherlands, and Sweden are similarly advanced, he adds. Pezdirtz attributes Japan's advantage to the fact that its citizens "are already paying \$1.20 a gallon for gasoline."

. . . U.S. stresses metal sulfides combined with Li, Na

ERDA's own battery R&D program, directed by its Argonne National Laboratory, is budgeted to rise to \$15 million in fiscal 1978 from this year's level of about \$10 million. It is to be supplemented later in the year with the start of "a sizable program to support the Electric and Hybrid Vehicle Research, Development, and Demonstration Act passed by Congress last year." While ERDA's dollar share of the demonstration program is still being negotiated with the White House, **it will stress near-term improvements in lead-acid, nickel-zinc, and nickel-iron batteries.**

But about two thirds of ERDA's own battery budget is pushing development of advanced lithium-sulfur and sodium-sulfur types to achieve a storage capacity of 65 to 75 watt-hours per pound for electric vehicles. Present lead-acid batteries store 12 w-h.

NSF electronics programs get congressional support

The National Science Foundation got a sympathetic first hearing in Congress on its request for an 11% increase in fiscal 1978 funds to \$894 million. Congressional committee sources anticipate no significant cuts in the funding request, particularly the \$249 million share for engineering and the mathematical and physical sciences that supports advanced electronics R&D. NSF acting director Richard Atkinson indicated that the proposed 11% boost in that share will emphasize **increased outlays for "new instrumentation, especially lasers," for use in chemistry research;** for computer science to achieve more efficient usage and increase software-problem-solving capabilities; and for engineering programs stressing optical communications and superconducting devices.

First opposition to Bell Bill arises in House

The first formal opposition to the so-called Bell Bill, heavily supported by the telephone industry, has arisen in the House and the Senate. The bill—actually the Consumer Communications Reform Act—would revise the 1934 Communication Act.

House members were asked to support a resolution noting that "it is timely and appropriate to give priority attention to make **more advanced telecommunications services and equipment available** to the people" through competition approved by the FCC.

On the Senate side, the Commerce Committee, which will hear the bill, asked the Office of Technology Assessment to examine communications technologies—optical fibers, microwaves, coaxial cable, satellites, plus data processing and electronic funds transfer—and their impact.

Controlling color-TV imports: a sorry case

The International Trade Commission's question was obvious and should have been anticipated: how will domestic color-television makers improve their future competitive stance during the five years of quota/tariff controls on imports they want the Government to impose? There were embarrassing minutes of silence in the ITC hearing room as George Konkol, GTE Sylvania's consumer products chief, conferred with counsel, groping for an answer. Finally, he responded that Sylvania had "a plan" that it would submit later for the record.

The response was clearly inadequate for the commissioners and later prompted one ITC staffer to observe privately, "If these are the industry's friends, they don't need enemies." The coalition of U.S. color-TV makers and unions seeking import relief under the 1974 Trade Act's escape clause see Japan's exporters as the enemy and are fighting them through an organization called Compact—the Committee to Preserve American Color Television.

Cross purposes

But the coalition is a loose one and often poorly prepared when it gets beyond formal testimony and into the nitty-gritty of Q. and A. At times, the trade unions seem to be at cross purposes to the manufacturers. One example of that was the testimony of the AFL-CIO's I. W. Abel, who suggested that manufacturers like RCA Corp. were not participating in Compact's

What's troubling John deButts?

When American Telephone & Telegraph Co. chairman John deButts told a Federal Bar Association seminar in Washington that he is "deeply troubled by the current relationship between the telephone industry and its Federal regulators," those in the audience who were not surprised seemed amused. Indeed, the expression of concern was out of phase with the tough line he has taken with the Federal Communications Commission in recent years.

But deButts' subsequent proposals to correct those troubles were completely in character. Among other things, he would like to replace the adversary nature of FCC proceedings with "a relationship that might, for example, provide for the joint development of long-range objectives for our business" with "the commission presenting its views of the nation's communications needs over the years ahead, the industry contributing its vision of the potentialities of its technology." The proposal, he concedes, raises "the

appeal because of the extensive income it derived from licensing TV technology to such Japanese manufacturers as Matsushita.

While unionist Abel's argument was meant merely to illustrate how American jobs are lost by technology exports, it also provided one more example of the global nature of technology transfer. Additional support for that latter argument has been advanced by the President's Council on Wage and Price Stability, which documented its opposition to import controls far more effectively than Compact presented its argument for relief [*Electronics*, Feb. 3, p. 57].

Domestic color-TV producers, the council suggests, may be going the way most other consumer products have gone—offshore—because "as the product goes through its life cycle of slow and then rapid growth, competition intensifies, products become standardized, unskilled-labor content increases, and the comparative advantage shifts to countries with lower costs for unskilled labor." The scenario has "happened for every major consumer-electronics good except color TV . . . and may now be taking place for this product as well."

That move, the council concludes, may be accelerated by a domestic industry "in danger of losing the vitality and drive that kept it a leading innovator and generator of new technology for the last half-century." If Compact is to counter those arguments effectively, it must make a better case than it has thus far.

suspicion that our motive for doing so is to rig things our way." True or false? Mr. deButts' only response was that "we have no alternative but to seek a better way."

Opposition and assessment in Congress

As for the conciliatory side of the AT&T chairman's observations, cynics suspect deButts has one eye on the Congress. For even as he spoke, the first formal opposition was developing in the House to the rewrite of the 1934 Communications Act sponsored by the telephone industry. And the Senate Commerce Committee that will hear the bill wants an in-depth analysis by the Office of Technology Assessment (see p. 47).

Members of the 95th Congress—many of them newcomers—are not rushing to support AT&T's proposals the way many did last year. That may be troubling Mr. deButts more deeply than his problems with the FCC. **Ray Connolly**

PRECISION SIGNALS

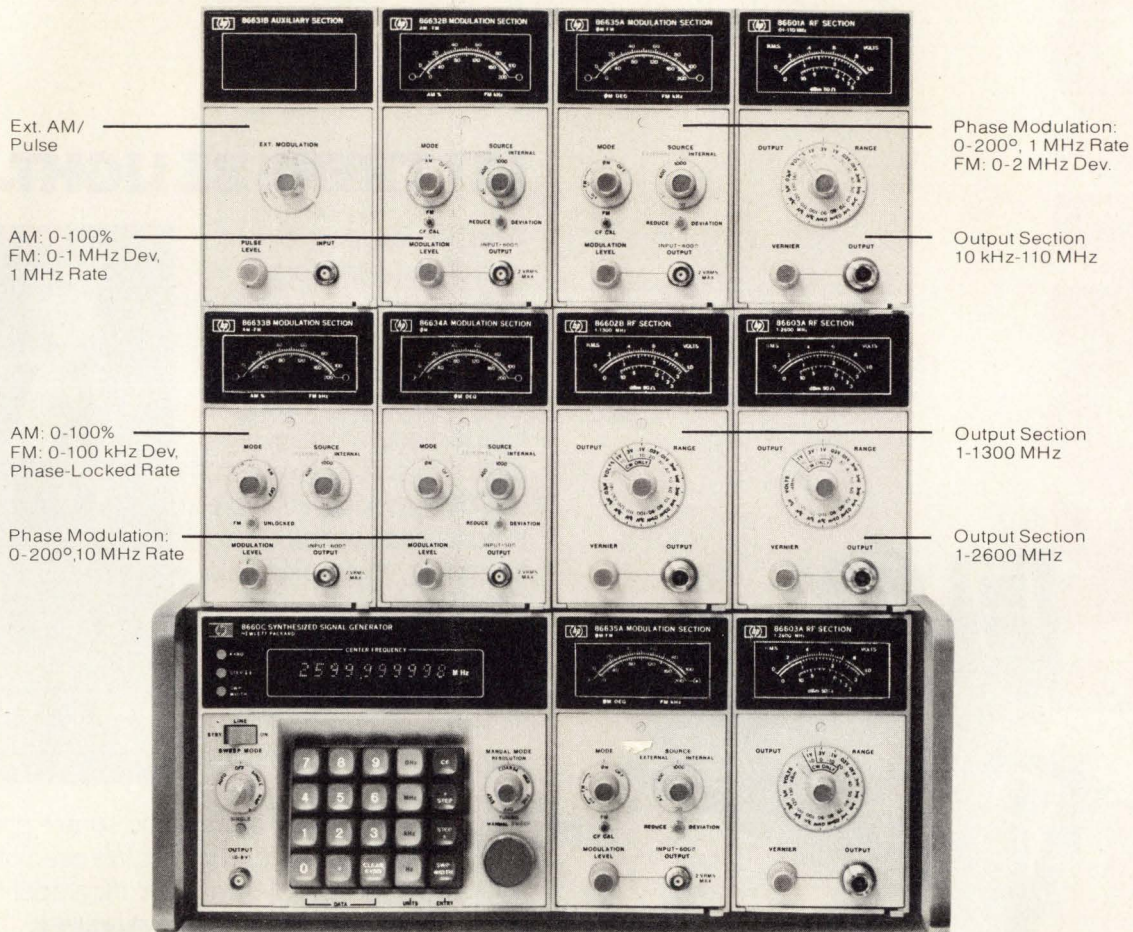

FROM 10 kHz TO 2600 MHz.

Your broadest selection of precision signals.

Choose a modulation capability for your exact frequency range. You can get the precise combination for the signals you need. And you won't

find a broader selection of modulation and output capabilities on the synthesizer market.

For manual operation, choose the HP 8660C mainframe. It features keyboard entry, digital readout, 1 or 2 Hz resolution, digital sweep, good signal purity and the operating convenience you need.

For systems operation, the HP 8660A mainframe features thumbswitch entry.

Both mainframes are completely programmable with the HP Interface Bus (IEEE 488) or BCD.

Complete systems start at \$9850* and a typical keyboard mainframe with 1300 MHz output and AM-FM modulation is \$18,850*.

For our 20 page brochure describing HP's synthesized signal generator call your nearby HP field sales office, or write.

*Domestic U.S. prices only.

HEWLETT  PACKARD

1507 Page Mill Road, Palo Alto, California 94304

For assistance call: Washington (301) 948-6370, Chicago (312) 255-9800, Atlanta (404) 955-1500, Los Angeles (213) 877-1282



LET THERE BE LIGHT.

Whether you need to light up a digital watch or a computer panel, you should light up our switchboard first. Because, with high volume production of LED lamps, digits, couplers, phototransistors, arrays and LED dice, nobody has more experience or better technology than Fairchild's Optoelectronics Division.

A LAND FULL OF LAMPS.

Fairchild is the largest producer of LED lamps in the world. A wide variety

of proprietary and second source profiles in red, orange, yellow and green. We even offer 4° beam width for optical communication applications.

A FIST FULL OF DIGITS.

When it comes to LED digits, we build more than anybody else. We build the largest ones—up to 8/10" — and the brightest ones. And we can fit more character size in a smaller package than anybody else.

Our digits are available with pins or as PC board mounted stackables. You get a choice of common anode or common cathode varieties.

Also, as you might expect, our digits come in the widest selection of colors available. Red. Super red. Orange. Green.

MORE THAN A COUPLE OF COUPLERS.

Our line of couplers is the broadest on the market. And it gives the best performance. Our "Glassolated™"



coupler doubles isolation voltage to 5kV. That gives you a lot more of what you buy couplers for.

We can also provide the highest isolation voltage in the industry — 7kV peak, 6kV continuous. And to top it off, the last thing you'd expect with such performance: No extra cost.

A WIDE SELECTION OF PHOTOTRANSISTORS AND ARRAYS.

We've been one of the leading manufacturers of plastic phototransistors and arrays for years. And now, we've expanded our line to include metal phototransistors and photo Darlington's as well. If you need it, we've got it.

A ROLL OF THE DICE

Our dice take the gamble out of building your own displays. That's because they're loaded. With high-performance, high-efficiency characteristics gained through years of experience as the major producer of LED displays for watch and calculator applications.

Monolithic die sizes range from .116 inch to .040 inch.

For more information, write or call your Fairchild sales office, distributor or representative today. Or use the direct line at the bottom of this ad to call our Opto-electronics Division. Fairchild Camera & Instrument Corp., 464 Ellis St. Mountain View,

CA 94042. Tel: (415) 493-3100. TWX: 910-373-1227.



FAIRCHILD

**CALL US ON IT.
(415) 493-3100**

The Power E...

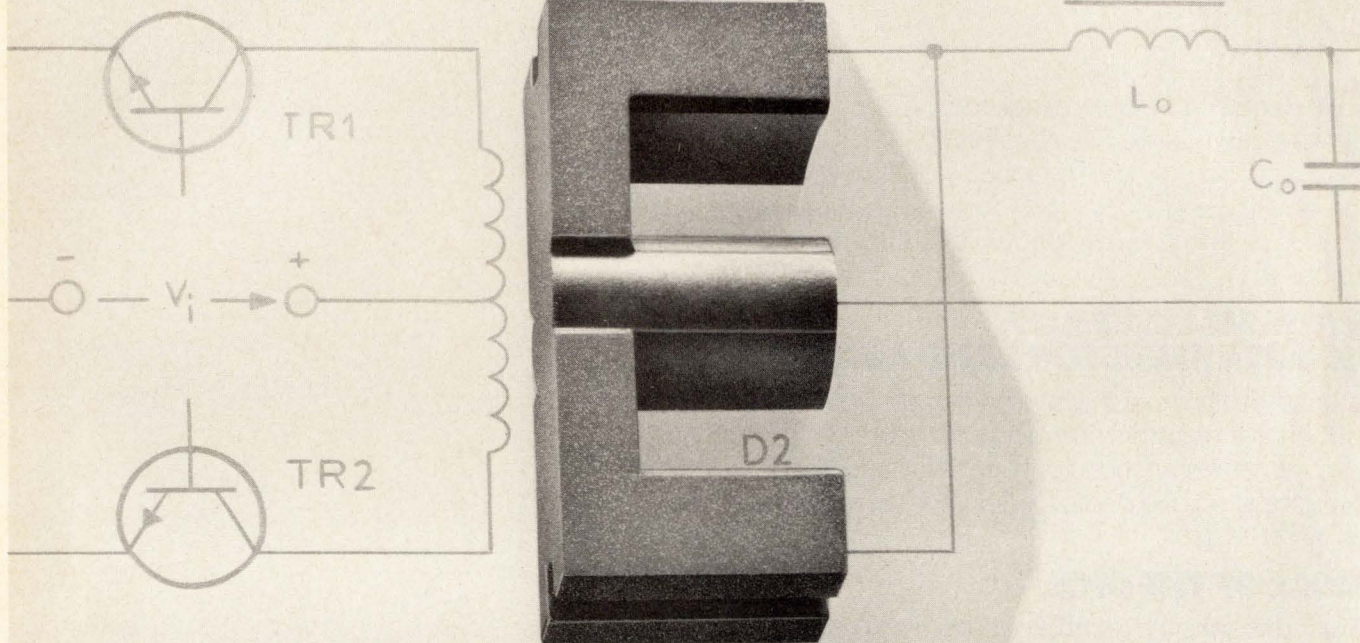

Another small accomplishment from Ferroxcube ...with Guaranteed performance!

Manufacturing switch-mode power supplies? Inverters? Converters? Want to simplify transformer and filter design and fabrication? Then take a closer look at one of our latest accomplishments.

Series EC—

Power E Cores in 3C8 material

A transformer operating at high flux densities and high frequencies should be screened to minimize external fields and radiation. The usual method is to use a pot core design or an I and U core combination. But the Power E Core design offers you the advantages of both the pot core and I and U combination. First, the round center leg makes strip winding easy and insures a high copper or space factor, and the lowest DC resistance. Second, the winding geometry is configured for low-leakage inductance. **And . . .**

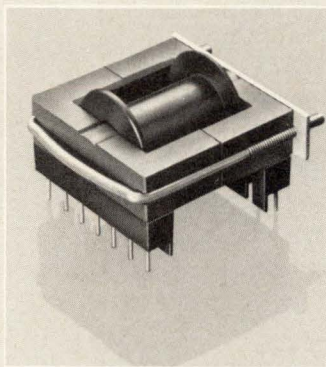
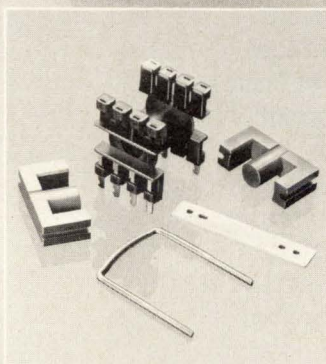

We guarantee the minimum flux density, at 100°C. will be 3300 Gauss. And a maximum loss of 100 milliwatts/cm³ at 16 kHz, at 100°C. and 2000 Gauss.

The new core line has been IEC standardized in four sizes: Types EC-35, EC-41, EC-52 and EC-70, covering transformer throughput power to 1 Kw. We have slotted the cores to accept a mounting bracket that eliminates the assembly problems of the square-legged lamination cores. You also can choose a standard bobbin or PC bobbin for printed circuit board mounting.

Series EC—Power E Cores are fully described in the new Ferroxcube Linear Ferrite Catalog. For your free copy write or call:
Ferroxcube
Division of Amperex Electronics Corp.
5083 Kings Highway
Saugerties, N.Y. 12477
(914) 246-2811

FERROXCUBE

A North American Philips Company



International newsletter

Delegates postpone setting hemisphere satellite channels

The U.S. negotiating team headed by FCC Commissioner Robert E. Lee has successfully delayed the fixing of channel assignments and orbital locations for direct-broadcasting satellites beamed at North and South American countries (ITU Region 2) until 1982. The U.S. delegation to the International Telecommunications Union conference that convened in Geneva to allocate services in the 11.7-to-12.7-gigahertz band persuaded a majority of other Region 2 countries to forego a definite plan now.

But instead of the full postponement they had hoped for at the five-week meeting, which ended last week, **U.S. officials had to consent to reserving two big segments of orbital space for direct-broadcasting satellites** (another three are assigned for fixed-service use) and also to some main transmission/reception parameters. Region 2 countries agreed to meet in 1982 to work out a detailed allocation plan. However, officials could not win majority support for a hold-off by European, African, and Asian countries. They adopted a fixed plan for their regions (1 and 3).

Firm to furnish silicon ribbons for solar cells

Jointly held Japan Solar Energy will soon begin shipping to its Japanese owners p-type silicon ribbons for conversion into solar cells for commercial applications. It will also try to develop its own solar cells for such applications as toys. The firm, which grows the ribbons by the edge-fed method licensed by Mobil Tyco Solar Energy in Somerville, Mass., is jointly owned by Kyoto Ceramic Co., Sharp Corp., Matsushita Electric Industrial Co., Mobil Oil Co., and Tyco Laboratories.

Japan Solar Energy winds 10- to 15-meter lengths of ribbons, which are 0.2 to 0.3 millimeter thick and 2.4 to 2.5 centimeters wide, on spools. The best 5-by-2-cm cells in a 10-m length of ribbon have conversion efficiencies as high as 9%, and smaller regions range as high as 10%. Resistivity is 0.5 to 5.0 ohm-centimeters, Hall mobility is 150 to 300 $\text{cm}^2/\text{v-second}$, and lifetime of the minority-carrier diffusion is about 50 μm . **The company has packaged sample solar batteries, consisting of 10 slices of ribbon 5 cm long with the edges sliced off to cut the width to 2 cm, in an acrylic module 11 cm square.** They provide a maximum output of 720 mw, open-circuit voltage of 5.2 v and short-circuit current of 220 mA. Typical conversion efficiency is 7.2%, and module panel efficiency is 5.9%

French firm to hit market with LCD digital watches

Watch for the first "made-in-France" five-function digital timepieces, which will have liquid-crystal displays, to go to market in Europe this spring. Montrelec SA, charged by the government to get the country into the electronic-watch business, turned out 2,000 watch modules last month and plans to work up to an output of 20,000 monthly by year end. Pierre Vovelle, Montrelec president, predicts that 1977 sales of French LCD watches, priced at \$70 to \$80, will run about 100,000 units. Montrelec's stockholders, who are all French watch makers, will market their own brand-name watches made with the modules.

At the outset, Montrelec will rely mainly on imported components. **The integrated circuits will come from American Microsystems Inc. in the U.S. and Intersil in West Germany, the displays from an Austrian supplier, and the quartz crystals from Switzerland.** By April, though, Montrelec expects to be getting its crystals from Sofrelec, an allied firm. The French government has promised nearly \$1.2 million in subsidies and loans during the next three years to put Montrelec solidly into the electronic-watch business.

**You can buy
this signal generator
for a 3-month job,
and then let it
gather dust.**

**You can rent
this signal generator
for a 3-month job,
and return it
when you're done.**



When you buy electronic test equipment for a short-term project, you're stuck with the equipment after the project is completed. Maybe it'll sit around gathering dust and costing you money. Or maybe you could sell it at a loss.

Or maybe, you should have rented it from REI.

When you rent equipment from us, you keep it only as long as you need it. When you're through with it, you send it back. Since you pay only for the time you have your instruments, you never have to spend your money on idle equipment. Short-term needs are just one reason for renting. Immediate delivery is another. Because we maintain over \$10 million in inventory in fully stocked instant inventory centers around the country, you can get delivery within hours.

REI stocks over 8,000 fully checked-out test instruments. And they're ready whenever you are. For the full story on renting as well as our low prices, send in the coupon for prompt delivery of our free illustrated catalog. Or call us now for your immediate requirements.

Rental Electronics, Inc.,
99 Hartwell Avenue, Lexington, Mass. 02173.
Please send me your free instrument rental catalog:

Name _____ Title _____

Company _____

Address _____

City _____ State _____ Zip _____

Tel. Number _____

Rental Electronics, Inc. 

Burlington, MA (617) 273-2770 • Gaithersburg, MD (301) 948-0620 • Oakland, NJ (201) 337-3757 • Ft. Lauderdale, FL (305) 771-3500
Des Plaines, IL (312) 827-6670 • Dallas, TX (214) 661-8082 • Mountain View, CA (415) 968-8845 • Anaheim, CA (714) 879-0561
Rexdale, Ontario (416) 677-7513

Circle 54 on reader service card

Fairchild launches European push in consumer-electronics market

When you rank No. 4 in Europe, you try even harder. That is the message from Fairchild, which is launching a 1977 push into the European consumer market. This year, the company plans on introducing its cassette-based television games, doubling sales of digital watches, and getting its F8 microprocessor designed into a legion of white goods.

All this activity is expected to fuel a 20% increase in European sales in real terms—enough, the company hopes, to capture some territory from the leaders, Texas Instruments, Philips, and Motorola. One reason Fairchild is optimistic: “The projected market for microprocessors this year is way underestimated—including Europe,” declares Wilfred J. Corrigan, president and chief executive officer of Fairchild Camera & Instrument Corp. of Mountain View, Calif.

Prospects. He sees a wide range of consumer and industrial goods as bright growth prospects. Fairchild executives feel that they are in a good position to cash in on that growth with the F8 microprocessor, which is well suited to those low-end-of-the-market control applications.

In fact, right now, the company is already either discussing or developing with European companies the use of F8s in TV tuners, washing machines, ovens, refrigerators, dryers, and both household and industrial scales, says James A. Duffy, who is vice president and general manager of the International division.

He hints that the TV game, which Fairchild calls a video-entertainment system, already has been bought by two European companies. “The F8 is starting to take hold,” he says.

On the consumer front, “the primary thrust is the digital watch,” says R.H. Bohnet, director of European marketing for Fairchild Consumer Products Inc. Its factory in

Frankfurt, West Germany, cases 500,000 watches a year, which, with imports from the U.S. and the Far East, will give Fairchild more than 20% of the market. “We’re Europe’s largest digital-watch company,” Bohnet boasts.

Also, digital clocks, second only to watches, are “very viable in the tremendous European market,” he continues. He points out that Europe is so important because it contributes 30% of Fairchild’s total consumer-products business—equal to

that of the U.S. market—or about \$30 million last year when the consumer total from all countries amounted to about \$100 million.

The icing on the cake is the F8-based TV game, due to sell for \$170. The PAL-compatible cassettes that load the game programs will be about \$20, Duffy says. Moreover, he predicts that the game will be expanded into a large household educational market, where the system could be used to teach children mathematics or help parents

Around the world

Improved redundancy reduction speeds facsimile transmission

For reducing redundancy in facsimile transmissions, the relative-address-coding (RAC) method developed by the Research and Development Laboratories of Kokusai Denshin Denwa Co. in Tokyo appears to be the most efficient technique devised yet. Tests of the Quick Fax system, which implements the RAC scheme, are now under way between KDD in Tokyo and RCA in New York. The three-week tryout is expected to prove that when operating full-duplex, the system can transmit documents without error on leased or Datel lines.

Then if KDD and Nippon Electric Co., manufacturer of the terminal used in New York, and Fujitsu Ltd., maker of the other terminal, can show that the equipment price is not out of line, the design could be adopted as the Japanese standard and possibly by CCITT (Comité Consultatif International des Télégraphes et Téléphones).

Test documents are being sent at 4,800 bits per second on a modem with 2,400-b/s fallback capability. Copy is transmitted at CCITT-recommended resolutions of 3.85 lines per millimeter vertically with four picture elements per mm, 7.70 lines/mm with 8 elements/mm, and the other two possible combinations of line spacing and resolution.

Modification improves D-type bistable circuit

The deterrent to high speed in conventional D-type bistable emitter-coupled-logic circuits is the level-shifting circuit that cross-couples the transistor pairs, claims E.V. Jones, who, when he was with Marconi Research Laboratories, Great Baddow, Essex, devised a solution. He is now a lecturer at Essex University. His concept may help give designers the 700-megahertz to 800-megahertz clock rates they will need for the 140-megabit-per-second and 565-Mb/s transmission systems being planned worldwide. Other potential applications include digitized television processing and computer interfacing.

Jones connects the whole circuit as an integral part of a feedback-latch arrangement. The now centrally located output nodes are compatible with the input nodes. Also, by moving the cross-coupling into the center of the circuit and adding a pair of transistors, he essentially creates an output-buffer stage to smooth out operation.

struggle with their income taxes.

"Using the television game as a vehicle, Fairchild will be the largest microprocessor manufacturer," Corrigan believes. This captive F8 market will help lower the processor's unit price and make it easier for the device to penetrate new markets. In addition, experience with the game and with the F8's n-channel process gives the company a leg up in volume production of its new high-speed 4-kilobit random-access memory and its 16-k RAM as well, he says. The company plans to add the game to its European assembly operations.

The next thrust will be in the

consumer end of the telecommunications market in products like built-in recorders for telephones and time-shared teletypewriter-transmission systems, Corrigan says. That market is beginning to take off in the U.S., but lags a little in Europe.

He rates the potential market for Teletext and Viewdata systems in Europe as a "maybe" proposition. Just in case, however, Fairchild has built a Teletext-Viewdata decoder that is based on the ubiquitous F8. Downstream, Corrigan thinks that the 65-kilobit charge-coupled-device memory, which is slated for introduction later this year, may help this vast market. □

West Germany

Two groups are developing radar-based collision-avoidance systems for autos

Although still far from becoming standard equipment on cars, radar-based collision-avoidance systems are under intensive development by a number of electronics companies, car producers, and automotive-accessory makers in West Germany. Bonn's Ministry for Research and Technology is subsidizing work by AEG-Telefunken with Robert Bosch GmbH on the one hand and ITT affiliate Standard Elektrik Lorenz AG (SEL) with Daimler-Benz on the other. Moreover, one of Europe's leading vehicle-instrument makers, VDO Adolf Schindling AG, is paying for its own work on collision-avoidance systems.

The AEG-Telefunken/Bosch system is based on pulse-radar principles and—in contrast to many systems developed abroad that use frequencies around 10 gigahertz—operates at 35 GHz. Further, the high frequency makes for good reflection from any kind of road surface and also gives improved resolution.

The radar, designed by AEG-Telefunken, produces a beam of about 2.3°, and its acquisition range is roughly 1.2 kilometers. Under 0° azimuth conditions, the system can recognize an accident-warning trian-

gle up to 60 meters away, a human being as far away as 90 m, a Volkswagen Beetle at 250 m, and a truck at 300 m.

After extensively testing a prototype system on a passenger car, the two companies are building 10 additional trial systems. These are to be tested by different drivers on trucks and other types of vehicles to obtain data under various traffic and road conditions.

Alarms. In the AEG-Telefunken/Bosch system, a small process computer triggers acoustical and optical alarms in various situations. When an object is spotted, a yellow light comes on. When the distance to the object decreases to a critical value, a red light blinks, and an intermittent tone is sounded. A steady tone and a steady red light tell the driver that he should step on the brakes to avoid a collision.

In handling its job, the Bosch-developed computer processes the data on the speed of the object ahead and that of the host car. It also takes into account the instantaneous distance between the two objects and then calculates the distances at which the various types of alarms are to be given. Besides, the comput-

er ensures that the effects of irrelevant objects such as guard rails along curved road sections are not involved in the calculations.

The SEL/Daimler-Benz system uses frequency-modulated continuous-wave radar principles. Originally designed for 16.5 GHz, the system has just been revamped for operation at the Post Office-approved 35-GHz frequency to reduce equipment dimensions. The radar, which produces a 2° pencil beam, has a maximum range of 130 meters. For data evaluation, the system uses an 8080 microprocessor [*Electronics*, Nov. 25, 1976, p. 65]. SEL foresees large-scale application of collision-avoidance systems priced at about \$420 in the 1980s.

Like the other system, the SEL/Daimler equipment determines the required safety distance to the vehicle ahead and gives a warning under critical conditions. In a future version, SEL says the signals that trigger the warning may also be designed to automatically act on the accelerator and brakes. This would be advantageous, particularly in dense traffic. However, brake and accelerator control will not be taken from the driver, SEL says.

Discrimination. The system can recognize, pinpoint, and evaluate several targets within its acquisition range. Although pulse-type radars are generally used for such multiple-target recognition, SEL designers managed to obtain this capability with a cw radar by using sawtooth-wave frequency modulation. In that way, they combined the benefit of multiple-target acquisition with the advantage that cw radar allows—simple transmitter and receiver construction.

Signal-pattern recognition in the microprocessor enables the system to distinguish between echoes from moving objects in the vehicle's path and from objects like road signs, lamp posts, and guard rails that are off to the side. SEL and Daimler plan to optimize the computer program to eliminate the possibility of false alarms in city environments, where many more objects exist that might trigger them. □

TALLY PRINTERS

Simplicity, Reliability, Low Cost of Ownership



TALLY SERIAL PRINTERS

Simple and Reliable

The Tally T-1000 Series. Reliability achieved by simplicity. Simplicity expressed in a minimum of moving parts. Microprocessor based electronics save space and provide inherent long term reliability. Performance is trouble-free.

1 Print Head Efficiency Designed for extended life. Minimal wear. Positive positioning. Tally's print head delivers consistently clear and concise matrix formed characters over long periods of time. Because print needle wear increases proportionately to curvature, needles and coils are positioned to maximize straight line design. Ruby jewel front bearings precisely lock-in registration. For added life, contact surfaces employ wear resistant materials.

2 Stepping Motor Control An economy of parts and motion. Positive print head movement forward. And backward. Fast precision paper handling. No springs or clutches needed. No adjustments, no warm up time. Instead, instant response. Reliable operation. Tally.

3 Positive Paper Drive Tally's dual tractor engagement allows rapid paper advancement and alignment. And increased throughput. Paper loading is easy.

4 Exceptional Print Quality Easy to read and pleasing to see. Sharply defined characters produced by a half-space matrix font. Tally's print quality is consistent copy to copy. For straight line registration that never wavers, two sturdy precision guide rails hold the print head carriage in exact alignment.

5 Microprocessor Control For increased throughput, the Tally microprocessor offers optimized bi-directional printing. It directs the print head on the shortest path to the next print position. While moving over blank spaces, the print head is accelerated to three times the printing speed. Throughput efficiency is doubled or tripled depending on the form. Reports are generated faster, yet the printer isn't working any harder.

6 Quiet Operation Tally's acoustically designed enclosure muffles the printing noise level down to a comfortable 55 dBA. When not printing, the unit is quiescent. No remote motor control is needed to assure silence.

7 Cartridge Ribbon Ribbon changing is clean, fast and easy. Tally's continuous loop cartridge design provides efficient ribbon utilization with a minimum of moving parts.

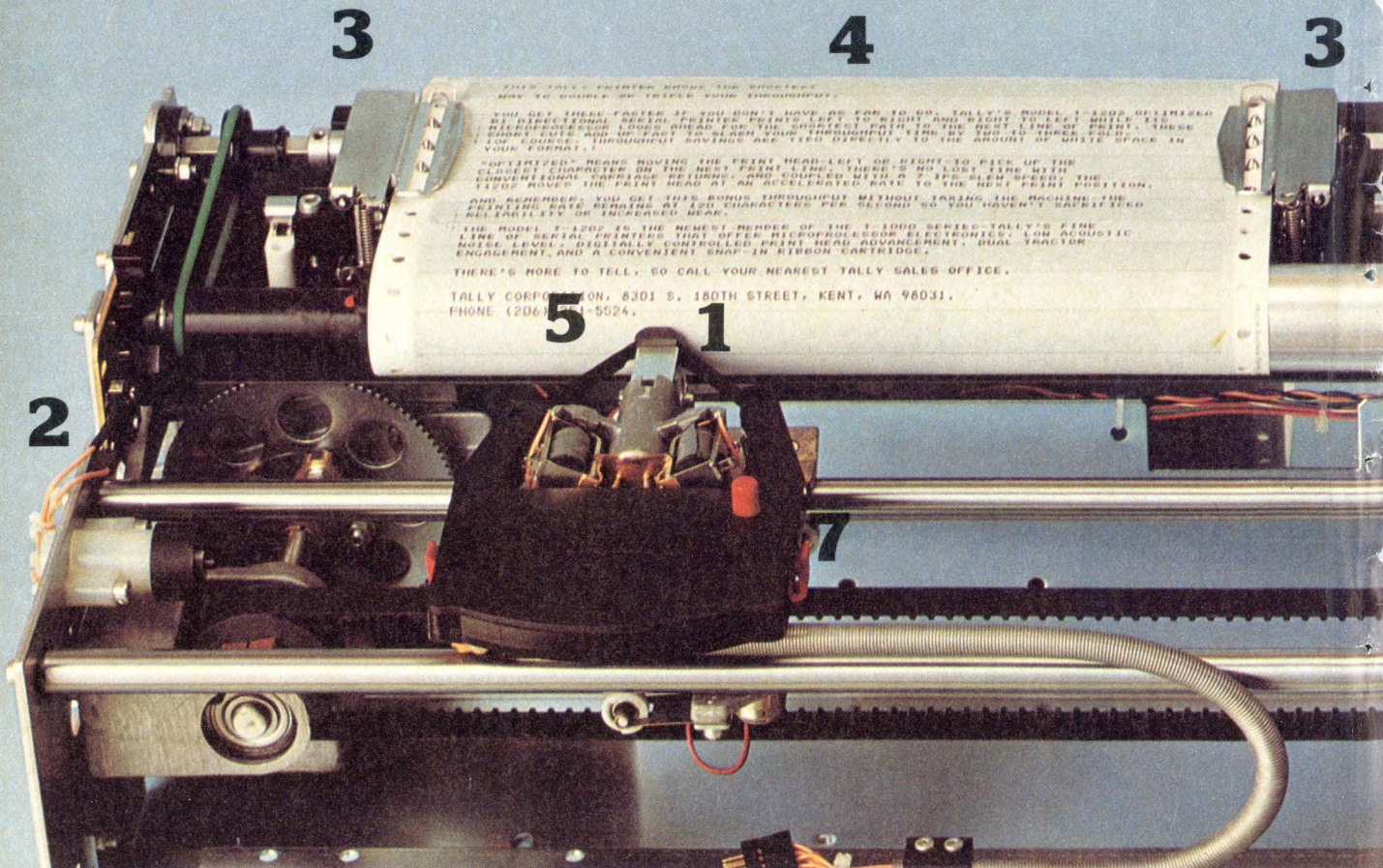

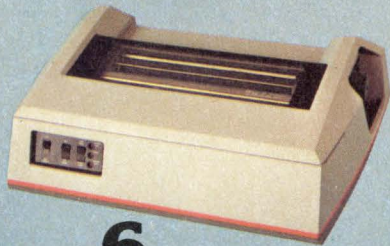

6

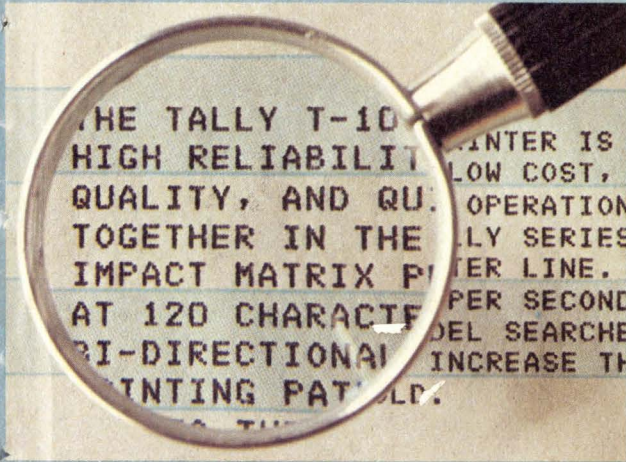

4

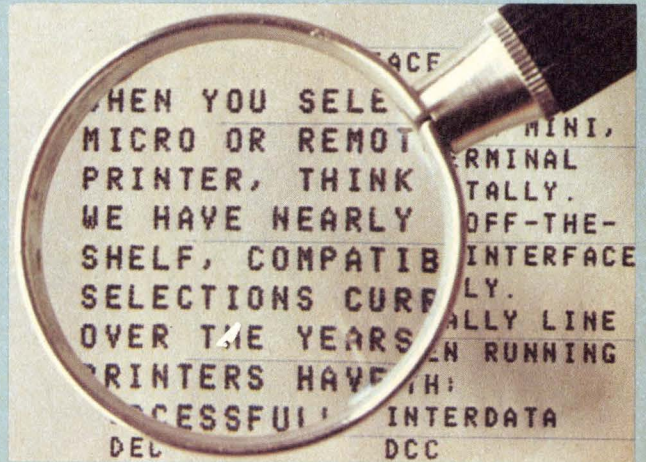

4

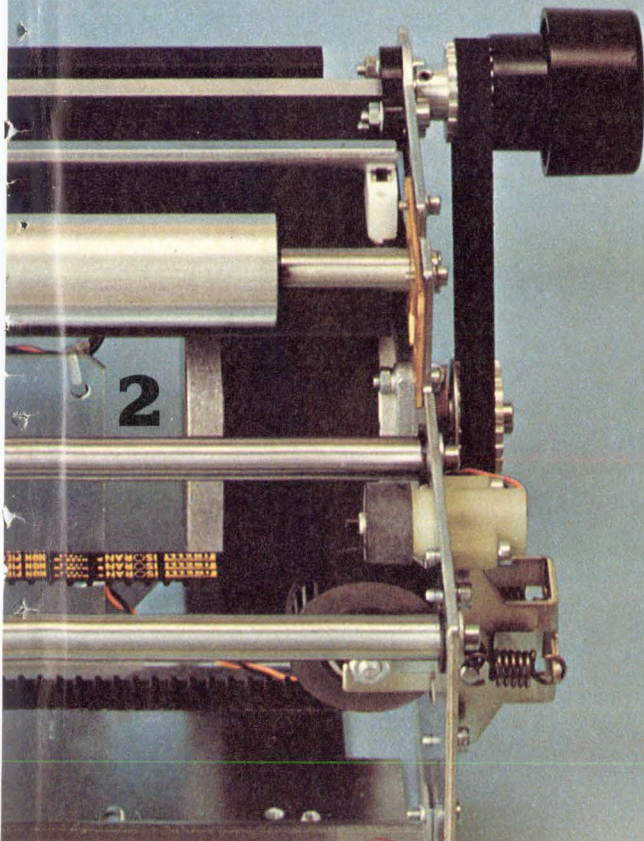

2

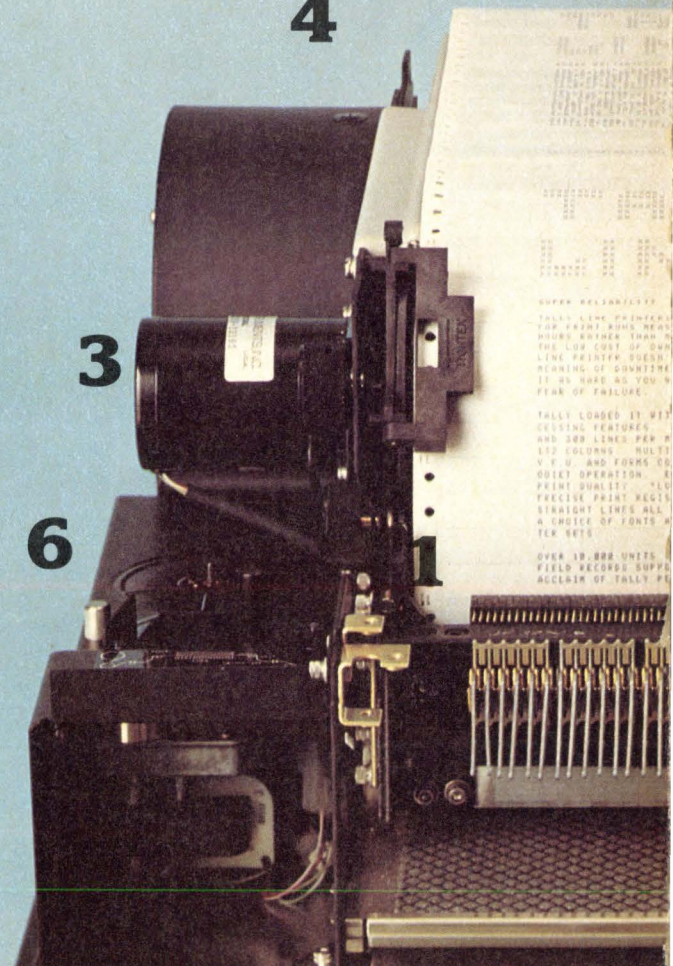

3

6

TALLY COMB PRINTING

The Tally print comb — Over 99% of Tally print combs have never been replaced. Never required adjustment. And that's from a Tally printer base of 10,000 units over a four year period. Tally's unique patented comb matrix printing system assures high resolution print quality and straight lines all the time. Print registration, vertical and horizontal, never wavers.

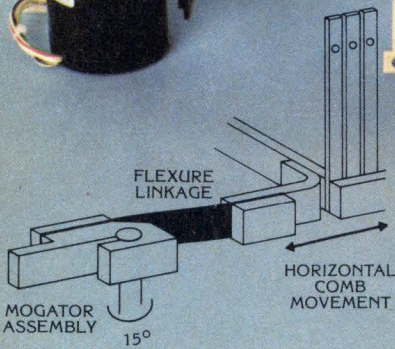
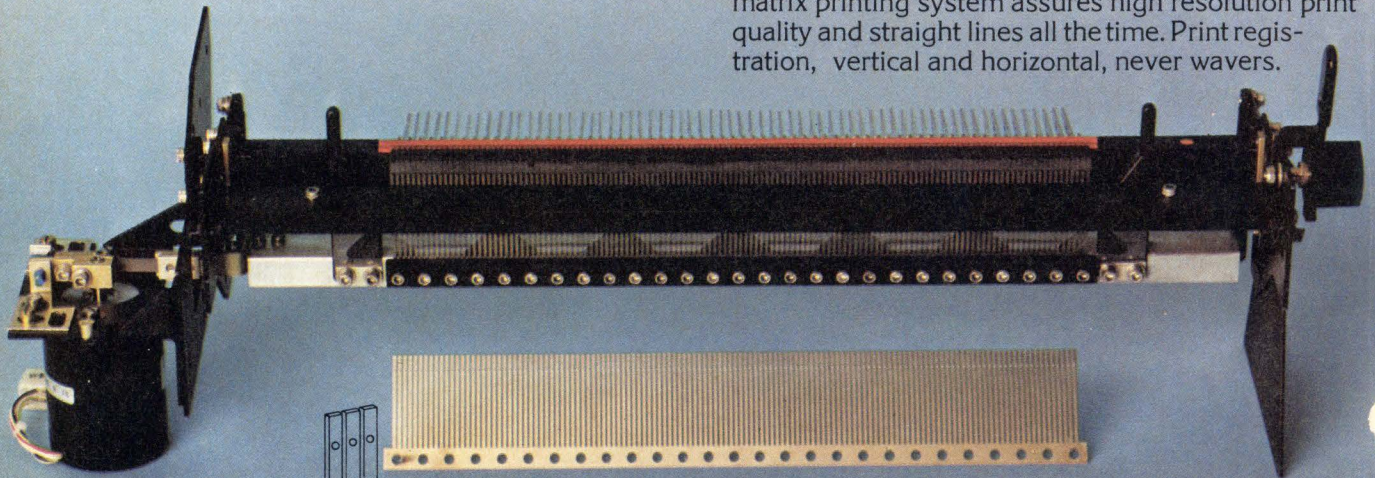

Tally generates dot matrix characters one line at a time. The light weight, single piece print comb consists of 132 fingers, each with a steel ball impact face. A dot is formed when the finger is struck against a fixed platen mounted behind the paper and inked ribbon. Each of the 132 fingers corresponds to a character position.

Each finger is pulled back by its own fixed electro-magnet and then released to fly forward and create a dot. Horizontal movement of the comb locates the adjacent dot position and the finger is released again. This is repeated until one dot row is complete. The paper advances vertically one dot row and the process is repeated until the complete line has been printed.

The Tally mogator — Rotary stepping motor motion is transformed into linear horizontal scan motion through the use of a flexure between the stepping motor and the print carriage. This technique delivers precise character positioning, and eliminates timing sensitivity, alignment adjustments, high wear factors and high failure rate components. Tally calls it the Mogator. It's a reliability concept based on light weight, low stress parts moving at low velocities over small displacements. And with no lubrication required.

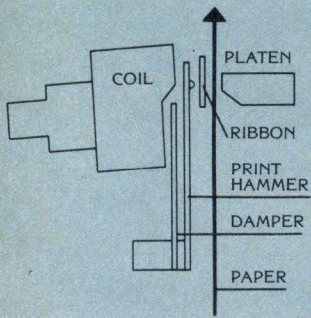
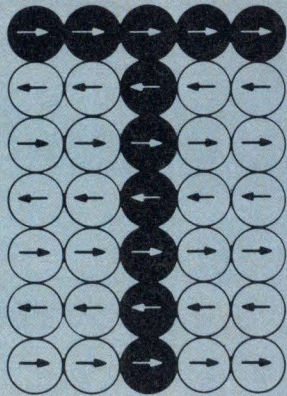

TALLY

Tally Corporation, 8301 S. 180th St.
Kent, WA 98031, Phone (206) 251-5524

Regional Offices:

- Boston (617) 742-9558
- New York (516) 694-8444
- Chicago (312) 956-0690
- Los Angeles (213) 378-0805
- Melbourne Beach (305) 724-0480
- San Jose (408) 247-0897
- Seattle (206) 251-6730
- San Antonio (512) 733-8153
- Business Systems (415) 254-8350

TALLY LINE PRINTERS

Simple and Reliable

The Tally T-2000 and T-4000 Series. Designed for heavy duty print runs. Only two moving elements in the print mechanism. The paper drive and the single piece print comb. Tally has eliminated clutches, belts, lubrication points, potentiometers. Eliminated mechanical adjustments and electronic adjustments. There are no preventative maintenance requirements. No duty cycle limitations. No mechanical movement if the unit isn't printing.

1 Unique Flexure Technology Tally uses special flexible steel couplings to support and move the print carriage. The fingers of the one piece hammer are also flexures. A flexure is simple, reliable, and has no wear points. No lubrication. No adjustments. They are designed for unlimited life.

2 Comb Matrix Print Hammer A unique and highly reliable printing technique based on low stress parts moving at low speed over short distances. Tally's patented print hammer is a simple, single piece 132 finger comb. Each finger corresponds to a character position. Displacement, force and stress factors are dramatically reduced.

3 Stepping Motor Dependability Positive control and fast, consistent response. Tally uses long life stepping motors to position the print comb and paper. No adjustments. No clutches. No warm up time. No timing problems.

4 Superb Print Quality Tally's print comb delivers crisp, concise characters and "locked-in" precise straight line registration. Everything stays in alignment without adjustment.

5 Easy to Live With It's quiet. Paper loading is easy. Tally's pin feed tractors adjust to accommodate variable width forms. A forms thickness control, a VFU with built in punch and paper out alarm are standard features.

6 Long Life Ribbon For added hours of ribbon life, the T-2000 inking system uses inexpensive reel to reel fabric ribbon. Ribbon life is at least 12 million characters.

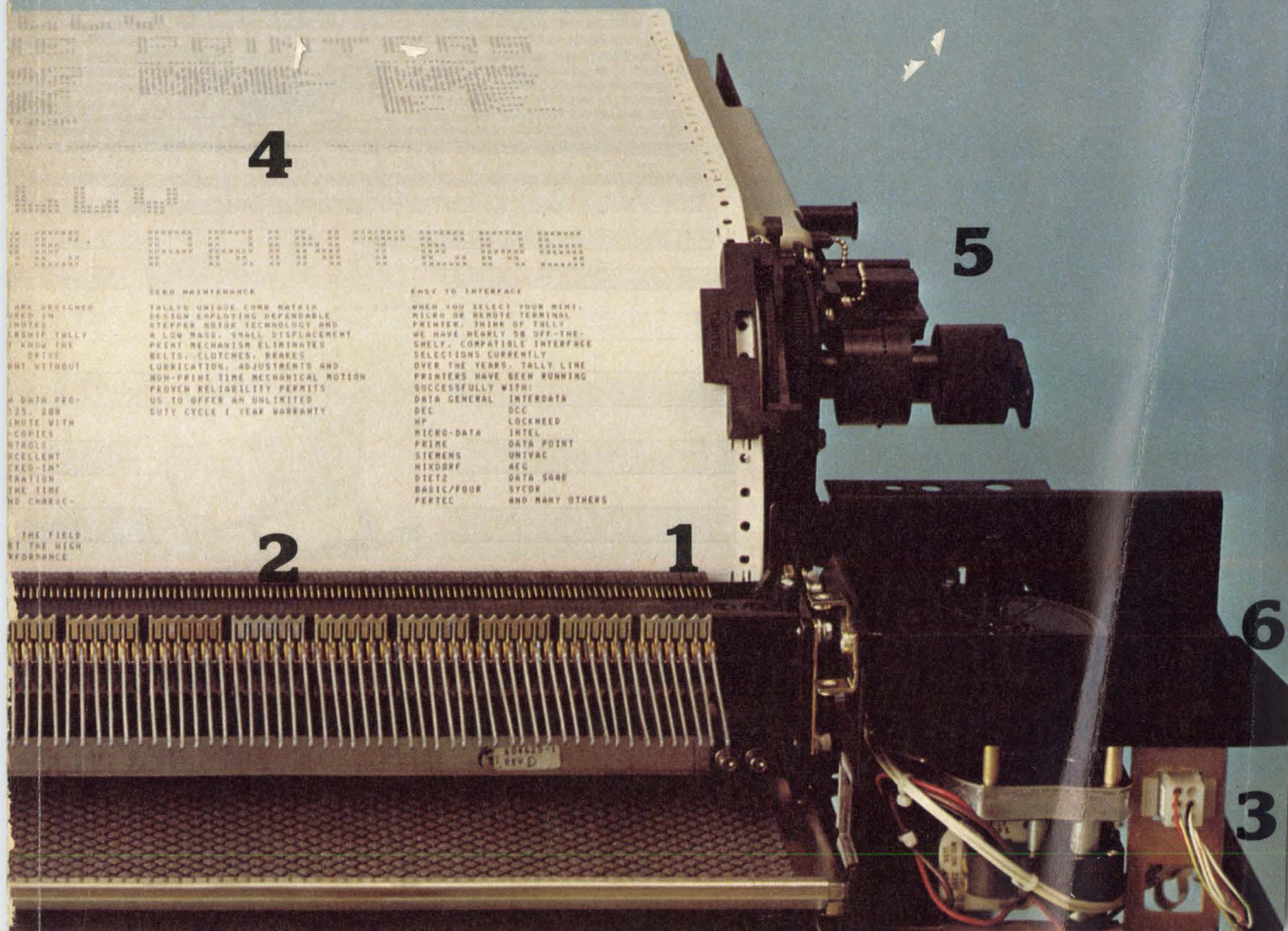

LOW COST OF OWNERSHIP

Tally's Printer Family



Tally's design philosophy of simplicity and reliability has a purpose. Low cost of ownership. Tally printers circumvent the high cost of service calls. The lost time of downtime. The solution is simple. Minimize moving parts. Eliminate high failure rate components. With Tally, there are fewer parts to buy, fewer parts to inventory.

Tally printers feature zero maintenance, absolutely no preventative maintenance is required. Belts, clutches, lubrication points are eliminated. Never any adjustments. No duty cycle limitations. A one year warranty. Over 10,000 units in the field that prove the point. Freedom from downtime. Instead, years of uptime performance that translates into significant cost savings. Dollar savings realized by shortcutting the need for service calls and parts usage. Dollars that can multiply fast when servicing remote or international installations. Rather than focusing on purchase price or speed alone, look closer at total cost over the life of a machine.

Also, cost of ownership is tied directly to usage. For high volume runs, use Tally line printers. For smaller runs, Tally serial printers are the answer.

Tally printers fit — Whatever your system — mini, micro, data terminal or data communications — Tally has a printer suited to your application. Use Tally printers anywhere. In harsh industrial environments or continuous duty office environments. Both serial and line printers. Speeds from 40 to 300 lines per minute.

Ready to interface — You'll find Tally printers on more different makes of minicomputers and systems than any other printer. To ease your system integration task, Tally stocks a wide variety of field proven interface controllers. And Tally has the applications support staff to assist with special problems. Also, worldwide service.



The Electronics Book Series offers you:

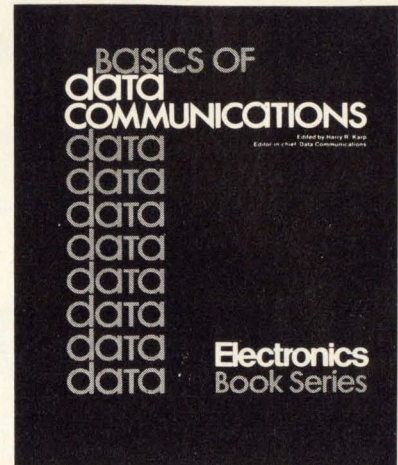
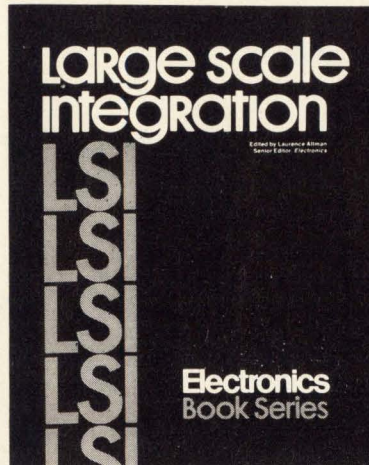
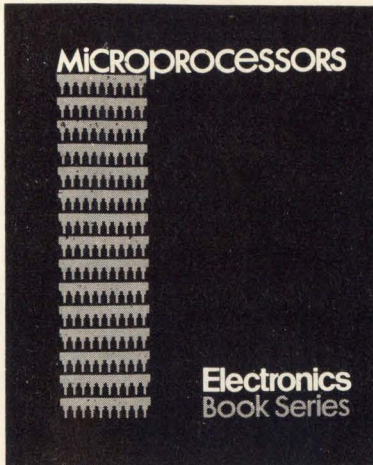

1 MICROPROCESSORS

The microprocessor has permanently changed the methods of designing and building electronic equipment—from process and industrial control to computer-based designs in instruments communication and consumer/commercial equipment.

This book cuts through the confusion, presenting the design and application potential of this exciting technology in a manner that will appeal to the design engineer who needs to know how to use microprocessors as well as the system analyst who must assess the tradeoffs between microprocessors and other techniques to accomplish his system goals.

Using articles from the pages of Electronics, this book contains practical and up-to-date information on available microprocessor devices, technology and applications.

2 LARGE SCALE INTEGRATION

The Electronics Book Series offers you a handbook on the current and revolutionary impact of LSI on digital design. This 220-page book presents a unique opportunity for circuit designers, systems designers, and engineering managers and supervisors to bring their expertise into line with today's LSI design requirements.

"Large Scale Integration" is a compendium of recent articles published in Electronics. Although in some ways it is a companion piece to "Microprocessors" because it explains the new circuits that play in mp systems, it is much more. "Large Scale Integration" deals with the entire range of design applications: main memory systems, peripheral memories, memory controllers, on-line industrial controllers, data acquisition boards, communication systems, calculators, watches, etc.

3 BASICS OF DATA COMMUNICATIONS

Data communications is one of the fastest-growing electronic equipment markets in the U.S.—during the decade of the '70's, better than 15-20% per year, compounded!

Chances are you are going to be a part of the data communications market. There's no better place to start than getting a copy of "Basics of Data Communications"—a 316-page compilation of essential articles which have appeared in Data Communications magazine. From the basic, tutorial, still state-of-the-art information published in the 1972 and 1973 Deskbook issues (now out of print), on through information on the practice of present-day data communications, this book includes forty-seven articles covering more than eleven key areas.

Electronics Book Series • PO Box 669, Hightstown, N.J. 08520



- 1 Send me _____ copies of "Microprocessors" at \$8.95 per copy.
- 2 Send me _____ copies of "LSI" at \$9.95 per copy.
- 3 Send me _____ copies of "Basics of Data Communications" at \$12.50 per copy.

Discounts of 40% on orders of ten or more copies of each book.

I must be fully satisfied or you will refund full payment if the books are returned after ten day trial examination.

- Payment enclosed
- Bill firm
- Bill me

Name _____

Title _____

Company _____

Street _____

City _____

State _____ Zip _____

Signature _____

Credit Cards Charge My Book To

- American Express
- Diners Club
- Master Charge
- BankAmericard

Acct. No. _____

Date Card Expires _____

Interbank No. _____

(1st No's. above name on Mastercharge only.)

**Rockwell
one-chip computers
give you the right fit
at the right price.**

Right now.

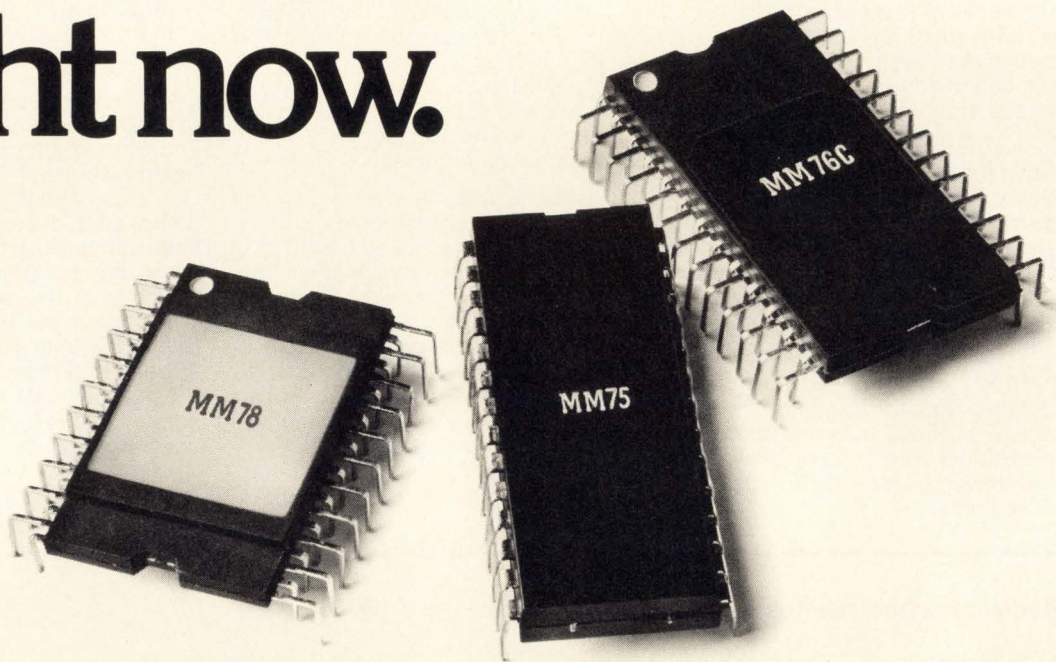

If you're designing a system or subsystem requiring as few as 10 TTL circuits, cost alone is reason enough to consider a Rockwell one-chip computer.

A wide choice of Rockwell one-chip computers is available right now. And the line-up of compatible one-chips is growing fast.

From Rockwell's PPS-4/1 family, you select the most cost-effective computer for your application.

More on-chip I/O eliminates extra interface devices.

All of Rockwell's one-chip computers offer powerful, user-oriented I/O ports that eliminate costly interface circuitry in overall systems.

I/O features, including bidirectional ports, flexibly designed drivers and receivers, and serial input/output ports, provide you with powerful system options.

Many types of displays can be driven directly. Analog-digital conversion is easy. And serial I/O ports offer a new dimension of capability by giving you simple, "no-cost" interfacing for multi-computer systems.

Rockwell flexibility assures cost-effective design.

Rockwell's one-chip computers give you design options you couldn't afford with other logic approaches.

During the design stage you can add or reduce functions, allocate I/O differently and make dozens of other changes by simple reprogramming or by moving to another software-compatible chip within the family.

Powerful instruction sets increase efficiency.

Rockwell's instruction sets provide ROM efficiencies of typically 2 to 1 over other microcomputers. For example, some one-byte multi-function Rockwell instructions perform operations requiring five instructions in other systems.

More than 80% of Rockwell's instruction

types can be executed in one byte and in a single cycle. Special ROM instructions allow many subroutine calls to be handled in one byte. Table look-up instructions for MM77 and MM78 chips provide easy look up of stored data and easy keyboard decoding with minimal programming.

The PPS 4/1 family of one-chip computers.

Model	MM76	MM77	MM78	MM75	MM76C	MM76D	MM76E
Description	Basic 76	Basic 77	Jumbo 77	Economy 76	High speed counter [#]	12-bit A/D converter	Expand- ed 76
ROM (x8)	640	1344	2048	640	640	640	1024
RAM (x4)	48	96	128	48	48	48	48
Total I/O lines	31	31	31	22	39	37	31
Cond. Interrupt	2	2	2	1	2	2	2
Parallel Input	8	8	8	4	8	8	8
Bidirectional Parallel	8	8	8	8	8	8	8
Discrete	10	10	10	9	10	10	10
Serial	3	3	3	—	3	3	3
In-line package	42 pin quad	42 pin quad	42 pin quad	28 pin dual	52 pin quad	52 pin quad	42 pin quad
Availability	Now	Now	Now	2Q 77	2Q/77	3Q 77	16 wk ARO

Power supply is 15v except low voltage version of Basic 76 available 3Q 77. Typical power dissipation is 70mw.

[#]Two 8-bit or one 16-bit presetable up/down counter with 8 control lines.

Rockwell design aids also help lower your system cost.

To help control development costs, Rockwell makes available a universal Assembler that lets you assemble, edit, develop and debug programs, as well as load PROMs. Special development circuits enable prototyping.

Your Assembler can also handle incoming inspection and factory testing. And the same Assembler can be used to develop systems based on all Rockwell one-chip and multi-chip microprocessors.

For the full story on Rockwell one-chip computers, and how quickly they can be a part of your new product, write on your company letterhead to: Marketing Services, D/727-E, Microelectronic Device Division, Rockwell International, P.O. Box 3669, Anaheim, CA 92803, U.S.A. or phone (714) 632-3729.



Rockwell International

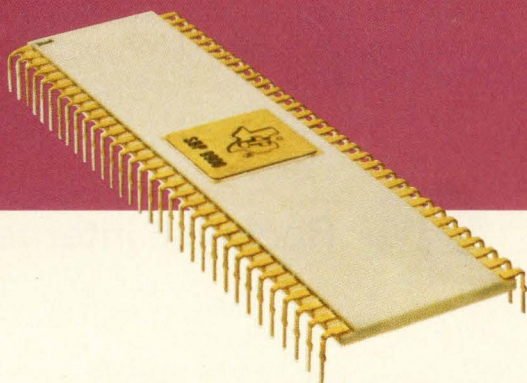
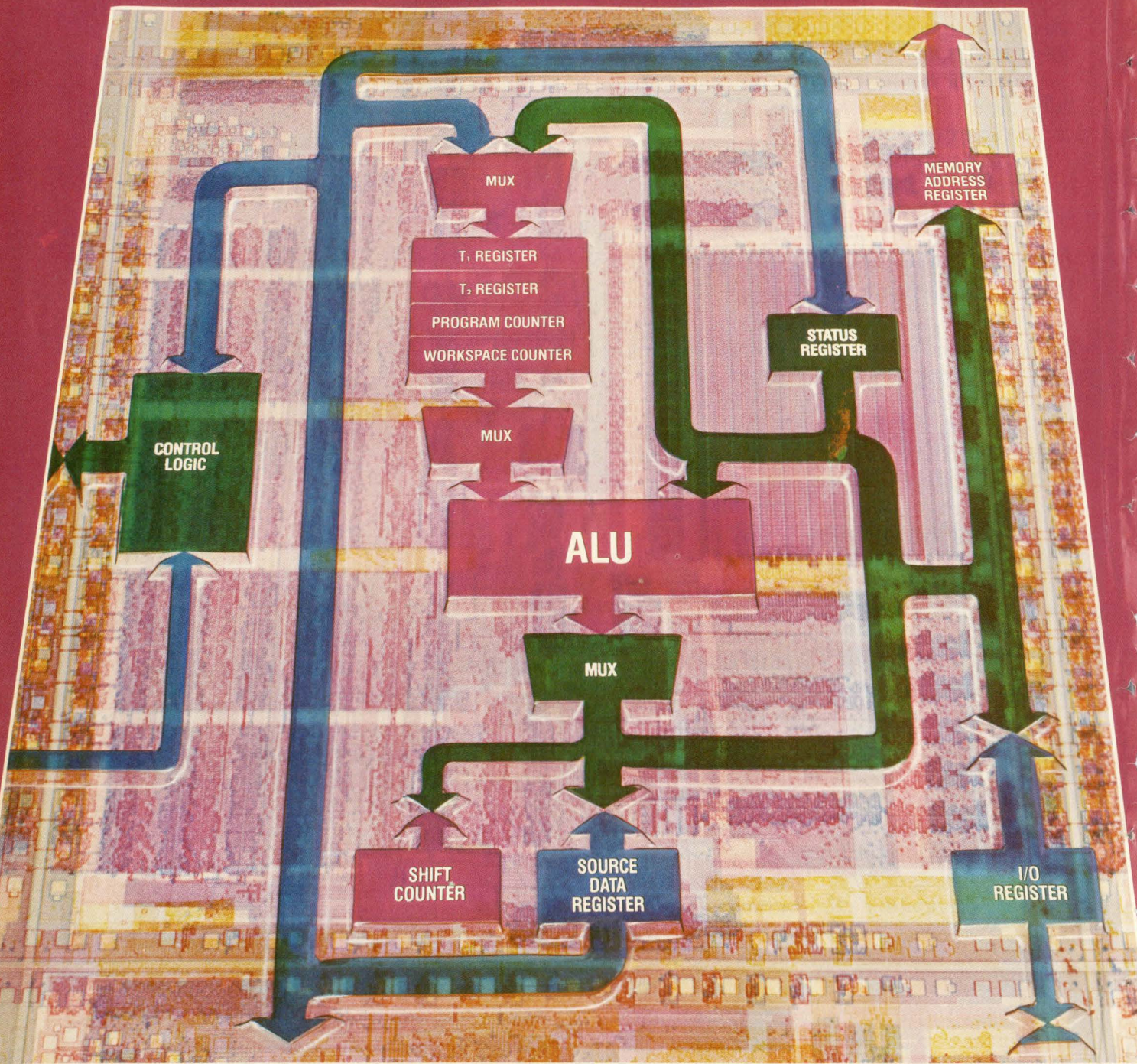

FIRST FAMILY

With the pacesetter SBP 9900 16-bit I²L microprocessor, TI keeps a promise. When introducing its revolutionary 9900 First Family, TI promised major additions to expand the family's unequalled design flexibility. To enable you to move easily and freely over your entire range of applications. Today and tomorrow. With less redesign, reinvestment and obsolescence.

First 16-bit I²L microprocessor: SBP 9900 joins TI's growing First Family.

TI's 9900 First Family welcomes a first-of-its-kind microprocessor. The SBP9900. Substantially enlarging the design versatility of this innovative family of software-compatible microprocessors. Support circuits. And micro and mini computers.

Microprocessor Milestone

The SBP9900 is a major technological advance. The first I²L microprocessor.

SBP9900 features include a 16-bit instruction word with full 16-bit data precision. Full mini computer instruction set including multiply and divide. Advanced memory-to-memory architecture that locates general purpose register files in memory. Separate address, data, I/O and interrupt buses.

In this single device, you have the power of 16 bits combined with the advantages of the 9900 family's microprocessor architecture. Result: Faster execution. Substantial savings in interface costs and in program coding. More efficient interrupt handling. Reduced memory bit requirements.

Plus all significant I²L benefits: Full temperature operation. High stability and efficiency. User-selectable speed/power operation. Exceptional ruggedness.

Unmatched Operation

Because of this unique combination, the SBP9900...

- Provides high-stability operation over an ambient temperature range of -55°C to 125°C.

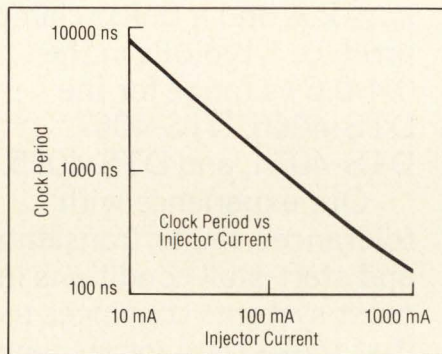

Pick your own speed/power operating point for optimum performance.

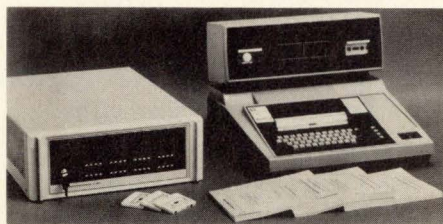

Full design support... including TI's 990/4 prototyping system.

9900 First Family Software Development Courses

WEEK OF	LOCATION
2/14	Washington, D. C.
2/21	San Jose/San Francisco
3/14	Long Island/NYC
3/21	Cleveland
3/28	Los Angeles
4/11	Boston and Houston
5/09	Denver
5/16	Syracuse/Rochester
5/23	Orlando/Tampa
6/06	Hamden, Conn.
6/20	Philadelphia
6/27	Seattle

For further information, circle 000 or contact:
Texas Instruments Incorporated
Post Office Box 1444, M/S 786
Houston, Texas 77001
(713) 776-6511 Ext. 501

- Requires only a single DC power source. Even solar cells or a pen-light battery will do.

- Is directly TTL compatible, with no special interfacing needed.

- Utilizes static logic to eliminate specialized clock drivers.

- Performs as a user-selectable speed/power device. As shown by the chart, the SBP9900 can operate efficiently over a speed/power range spanning several decades of supply current.

New Design Horizons

The SBP9900 opens a vast, new range of applications...challenges you to think beyond the conventional...dares you to explore applications where no other microprocessor can perform.

Use it in areas normally off limits to microprocessors. As the solution to design problems never before attempted. Wherever environmental demands are extraordinary. In a jet engine pod. On an off-shore drilling rig. Anyplace on, under, or above the earth.

Immediate Availability

The full temperature SBP9900 (-55°C to 125°C) is available now and is priced at \$386.00 each in 100-piece quantities. To order, or for more information about the SBP9900, contact your TI field sales office. Or write Texas Instruments Incorporated, P.O. Box 5012, M/S 308, Dallas, Texas 75222.



TEXAS INSTRUMENTS
INCORPORATED

DELCO'S NEW 25-AMPERE HIGH VOLTAGE DARLINGTONS WITH THE SPEED AND ENERGY CAPABILITY YOU ASKED FOR.

Good news for motor speed control designers who have expressed a need to upgrade horsepower ratings. The 25-ampere gain of these new Darlington permits increased horsepower ratings of existing AC motor speed control systems and a reduction in paralleling in new designs. However, grouping of t_{off} is available for current sharing in designs

MAJOR PARAMETER LIMITS

Type	hFE @ 25A	hFE @ 10A	VCEO (sus)	VCE (sat) @ 20A	ICEO @ 600V
DTS-4066	5	75	350V	3.5V	0.25mA
DTS-4067	10	150	350V	2.0V	0.25mA
DTS-4074	5	75	350V	3.5V	0.25mA
DTS-4075	10	150	350V	2.0V	0.25mA

TYPICAL SWITCHING

	DTS-4066 DTS-4067	DTS-4074 DTS-4075
t_r	0.5 μ s	0.5 μ s
t_s	5.0 μ s	3.2 μ s
t_f	4.5 μ s	1.0 μ s

NPN triple diffused silicon Darlington are packaged in solid copper cases conforming to JEDEC TO-3 outline dimensions.

SAFE OPERATING CURVES

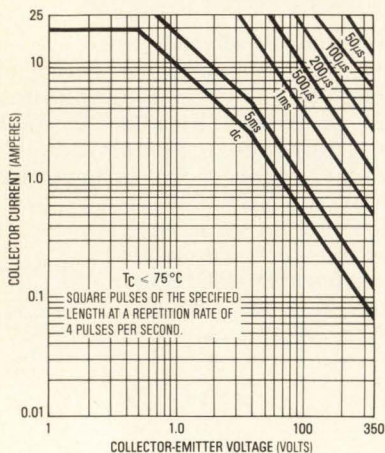

with parallel Darlington. A speed-up diode is built into the DTS-4074 and DTS-4075 permitting data sheet t_f typicals of 1.0 μ s. Drive circuit techniques involving $I_{B2} \geq 2$ A and a Baker clamp produce t_f typicals in the 0.4-0.6 μ s range for the DTS-4066, DTS-4067, DTS-4074, and DTS-4075.

Our experience with tolerances, faults, transients, and start-stall conditions in most systems convinces us that these Darlington have the right trade-off between speed and peak power handling capability. Note the greater than 10 kVA region of the reverse bias safe operating graph. All this, and you still get Delco's traditional solid copper TO-3 hermetic package that has a conservative 0.75°C/W thermal resistance.

These Darlington are already in high volume production and are available on distributor shelves. Prices, applications literature, and data sheets from your nearest Delco sales office or Delco distributor can complete the story on these new Darlington.



Features of Delco's new DTS-4066, 4067, 4074, 4075 Darlington.

- Upgrade existing motor speed control horsepower ratings.
- Reduce need for paralleling in new systems.
- Offer switching speed improvements over our earlier types.
- Achieve greater than 10 kVA peak power dissipation.
- Available with t_{off} grouping
- Delco hermetic copper package with 0.75°C/W.
- Currently in high volume production.

208/220 Vac, 3 ϕ MOTOR SPEED CONTROL

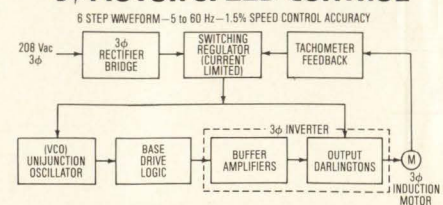

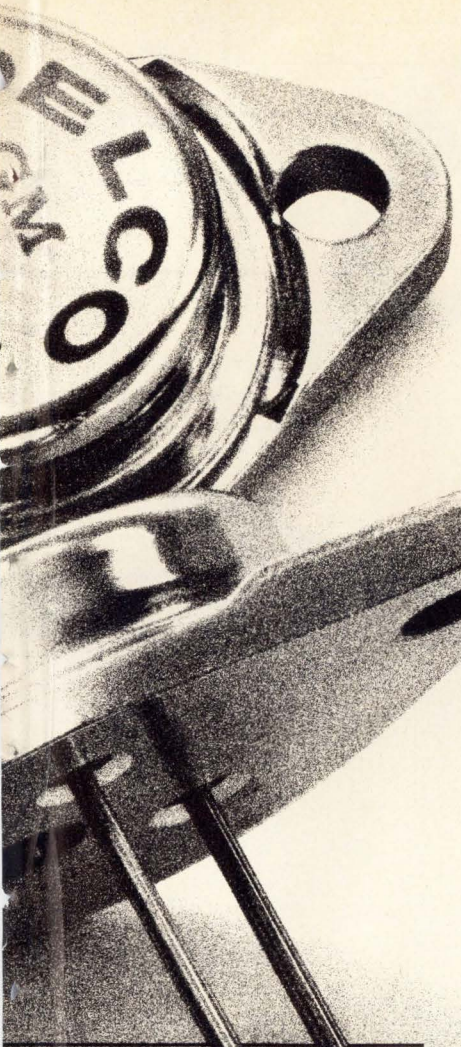

**NOW AVAILABLE FROM THESE DISTRIBUTORS
IN PRODUCTION QUANTITIES.**

ALABAMA

BIRMINGHAM
Forbes Distributing Co., Inc.
(205) 251-4104
HUNTSVILLE
Powell Electronics
(205) 539-2731

ARIZONA

PHOENIX
Sterling
Electronics, Inc.
(602) 258-4531

CALIFORNIA

GARDENA
Electronics
Distributors Div.
Bell Industries
(213) 321-5802
GOLETA
R.P.S. Electronics, Inc.
(805) 964-6823
LOS ANGELES
Kierulff Electronics, Inc.
(213) 685-5511
R.P.S. Electronics, Inc.
(213) 748-1271
PALO ALTO
Kierulff Electronics, Inc.
(415) 968-6292
SAN DIEGO
Kierulff Electronics, Inc.
(714) 278-2112
R.P.S. Electronics, Inc.
(714) 292-5611
SUNNYVALE
Bell Industries
(408) 734-8570

COLORADO

DENVER
Kierulff Electronics, Inc.
(303) 371-6500

CONNECTICUT

NORWALK
Harvey Electronics
(203) 853-1515

FLORIDA

CLEARWATER
Diplomat/Southland
(813) 443-4514

MIAMI SPRINGS
Powell Electronics/Florida
(305) 592-3260

ILLINOIS

ELK GROVE VILLAGE
Kierulff Electronics, Inc.
(312) 640-0200
SKOKIE
Bell Industries
Electronics Distributors Div.
(312) 282-5400

INDIANA

INDIANAPOLIS
Graham Electronics
Supply, Inc.
(317) 634-8202

MARYLAND

BALTIMORE
RESCO/Baltimore
(301) 823-0070

MASSACHUSETTS

BILLERICA
Kierulff Electronics, Inc.
(617) 935-5134
(617) 667-8331
NEWTON
The Greene-Shaw Co., Inc.
(617) 969-8900

MICHIGAN

LIVONIA
Pioneer/Michigan
(313) 525-1800

MINNESOTA

MINNEAPOLIS
Stark Electronics Supply Co.
(612) 332-1325

MISSOURI

KANSAS CITY
Walters Radio Supply, Inc.
(816) 531-7015
ST. LOUIS
LCOMP-St. Louis
(314) 647-5505

NEW JERSEY

CINNAMINSON
Wilshire Electronics/
Philadelphia
(609) 786-8990
(215) 627-1920

CLIFTON
Wilshire Electronics/
New Jersey
(201) 340-1900
(212) 244-8930

NEW MEXICO

ALBUQUERQUE
Sterling Electronics
(505) 345-6601

NEW YORK

BINGHAMTON
Harvey Electronics
(607) 748-8211
BUFFALO
Summit Distributors, Inc.
(716) 884-3450
FARMINGDALE
Wilshire Electronics/
Long Island
(516) 293-5775
FREEPORT
Milgray/New York
(516) 546-6000
WOODBURY
Harvey Electronics
(516) 921-8700
(212) 895-9260

OHIO

CINCINNATI
United Radio, Inc.
(513) 761-4030
CLEVELAND
Pattison Supply Co.
Industrial Electronics Div.
(216) 441-3000
DAYTON
Pioneer/Dayton
(513) 236-9900

OREGON

PORTLAND
Almac/Stroum Electronics
(503) 292-3534

PENNSYLVANIA

PHILADELPHIA
Almo Electronics
(215) 698-4000
PITTSBURGH
CAM/RPC Electronics
(412) 782-3770

SOUTH CAROLINA

COLUMBIA
Dixie Radio Supply Co., Inc.
(803) 779-5333

TEXAS

DALLAS
Sterling Electronics
(214) 357-9131

HOUSTON
Harrison Equipment
Co., Inc.
(713) 652-4700
Sterling Electronics
(713) 627-9800

WASHINGTON

SEATTLE
Almac/Stroum Electronics
(206) 763-2300
Kierulff Electronics, Inc.
(206) 763-1550
SPOKANE
Almac/Stroum Electronics
(509) 323-0679

IN CANADA:

Zentronics Ltd.
Toronto (416) 787-1271
Ottawa (613) 238-6411
Montreal (514) 735-5361

**OVERSEAS:
EUROPEAN
INQUIRIES:**

European Parts &
Accessories Marketing
Group
General Motors Continental
Plant 2, Noorderlaan,
Postbus 9
B-2030, Antwerp, Belgium

**ALL OTHER
OVERSEAS
INQUIRIES:**

General Motors Overseas
Operations
Parts & Accessories Dept.
767 Fifth Avenue
New York, N.Y. 10022
(212) 486-4412

**DELCO ELECTRONICS
REGIONAL SALES
OFFICES**

Charlotte, North Carolina
28209
4600 Park Road
(704) 527-4444
Van Nuys, California 91404
Box 2968
(213) 988-7550

**GENERAL SALES
OFFICE**

700 E. Firmin, Kokomo,
Ind. 46901
(317) 459-2175

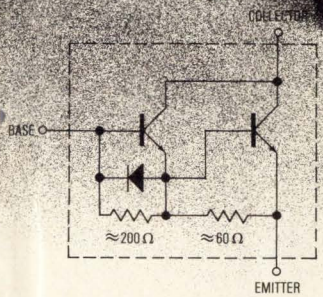

**SPEED-UP DIODE
USED ON DTS-4074/4075 ONLY**

**3φ DARLINGTON INVERTER
DTS-4066-4067**

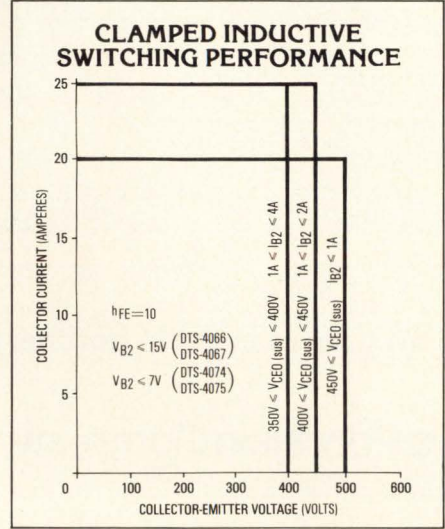
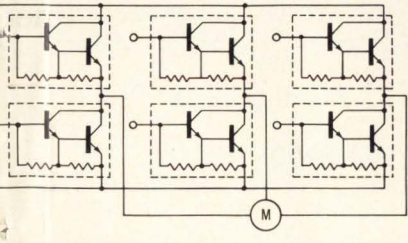

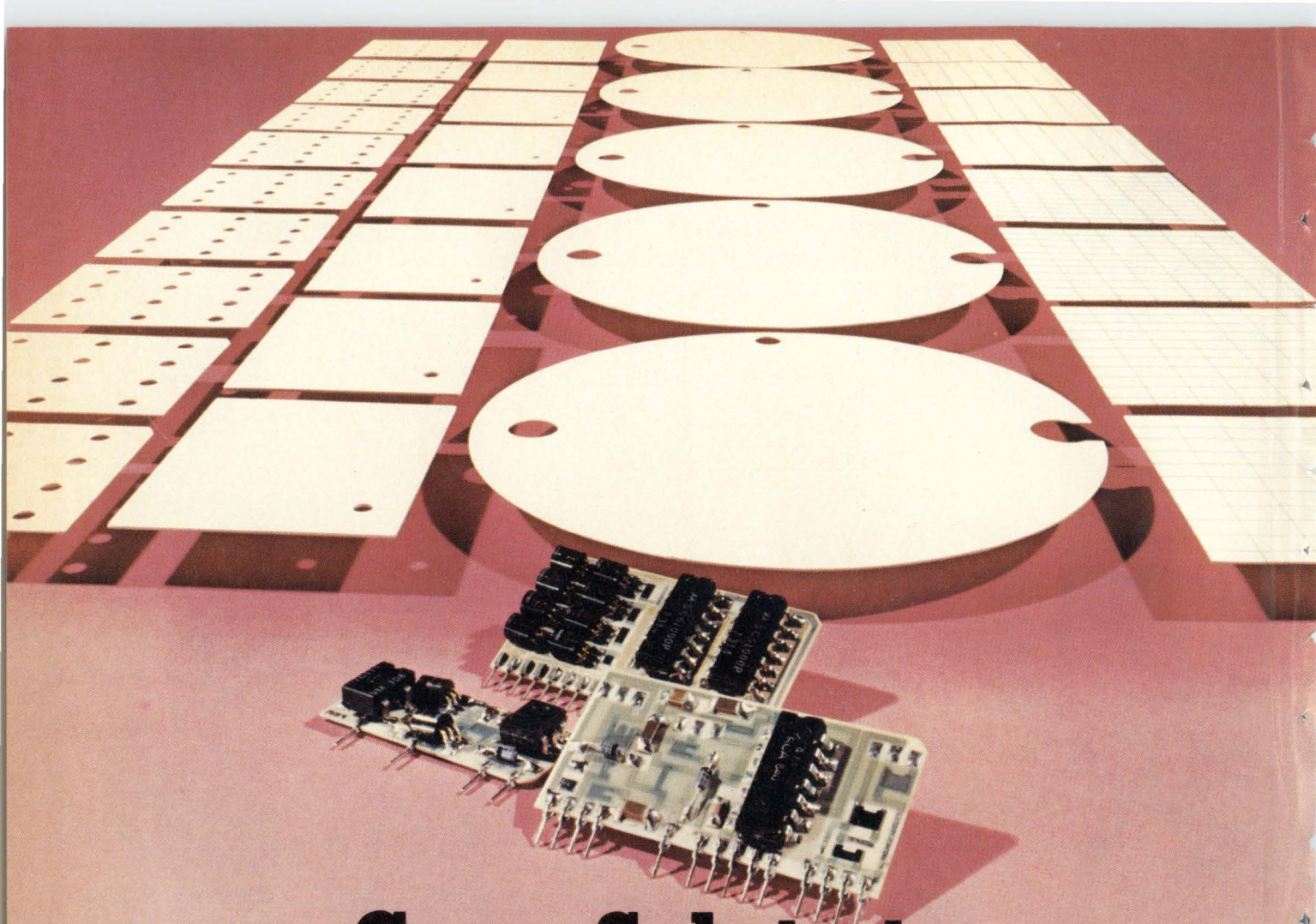

Coors Substrates Aren't Just Better. They're Faster.

You've told us fast response to customer orders is critical to your success in hybrid markets. Coors understands. We've made a commitment to give you the fastest delivery of thick- or thin-film substrates.

Through continuing investment in production facilities, we've cut lead times to give you better service on the largest or smallest orders. A new plant, under construction now, will significantly expand capacity for

even faster delivery in late summer, 1977.

But plant capacity is just one factor in Coors ability to cut your lead times. A special substrate service group—with a direct Substrate Hotline—gives you fast quotes and personal follow-through on all orders.

For complete details on Coors substrates and manufacturing capabilities, write for our free Electronic Ceramic Handbook, or call your local Coors sales engineer.

For quick delivery, call Coors Substrate Hotline: (303) 279-8320

Coors CERAMICS

Coors Porcelain Company

600 Ninth Street / Golden, Colorado 80401
(303) 279-8320/Telex 45-593

Gas-discharge-display sales soar

Ground lost to light-emitting diodes and liquid crystals is regained as new equipment requires their high-performance characteristics

by Bruce LeBoss, New York bureau manager

The demands of more and more equipment supplied with digital readouts has breathed new life into the gas-discharge-display market. After a two-year slump, during which they lost position to light-emitting diodes, liquid-crystal displays and other technologies, plasma panels have generated a dramatic increase in interest for a number of applications. The market now appears ready to leap to new heights.

In special applications—generally high-priced products where performance rather than cost is of prime importance—gas-discharge displays are winning the battle against LEDs, LCDs, and other displays. Among their advantages are larger digits, operation at temperature extremes, readability in bright ambient light, and high reliability.

Two of the more immediate beneficiaries of the upsurge in sales are Burroughs Corp.'s Electronic Components division in Plainfield, N.J., the traditional supplier, and Beckman Instruments Inc.'s Information Displays Operation in Scottsdale, Ariz. Also benefiting are some smaller domestic and foreign suppliers and the firms that manufacture driver circuits.

Beckman, which got into the market about three years ago by buying the Sperry Information Displays operation, also makes LED and LCD displays in Fullerton, Calif. Robert A. Kuntz, marketing manager for the Beckman operation,

says LEDs are doing well in low-priced instruments. "But in higher-priced products, such as point-of-sale equipment, banking terminals, and gas pumps, where aesthetics are an important factor and where equipment has to operate under high ambient light, just the opposite is happening."

Kuntz says that when the boom came in 1972 and 1973 for handheld and desktop calculators, many manufacturers marketed units that used the older Nixie-type display and others like Burroughs' Panaplex and Beckman's raised-cathode displays. The resulting domestic market

for gas-discharge displays grew to about \$40 million in 1972-73, "but that bubble burst about three years ago," he continues. "The result was that the market dropped to \$25 million to \$30 million in the 1974-75 period."

New peak. Now the demand is growing once again, "but in different kinds of products. The market is again very close to the peak of 1972-73, and it has the potential to surpass that peak," Kuntz says. He won't discount industry estimates that the domestic gas-discharge market could easily see a 50% growth by 1980-81 and reach a level of approx-

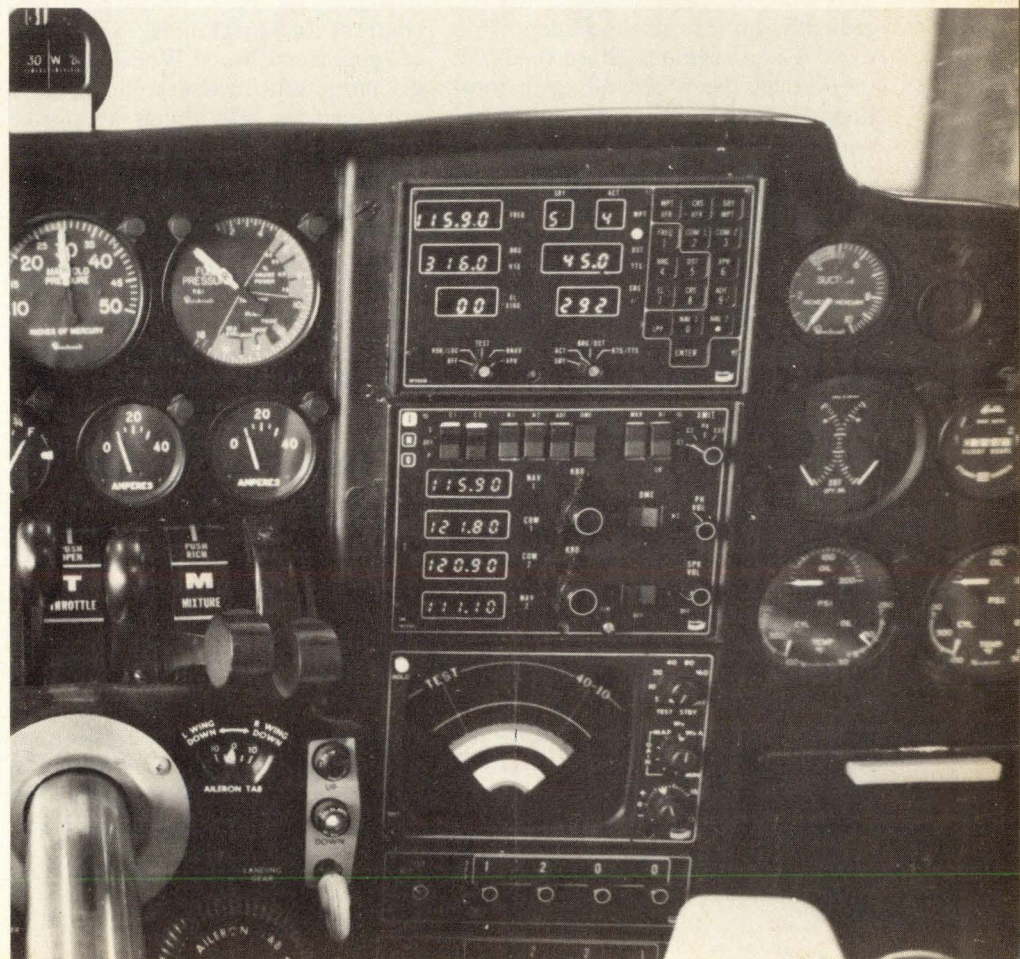

Wide blue yonder. For intense ambient light above the clouds, gas-discharge displays provide the bright readouts needed in this aircraft instrument panel from Bendix.

Probing the news



Selling job. Gas-discharge displays are well suited for point-of-sale terminals, an advantage that has helped the recent sales resurgence of the devices.

imately \$60 million annually.

Similarly bullish is Burroughs' Electronic Components division marketing manager, Art Shesser. He maintains that the calculator market gave sort of "a false peak" to the industry, only to decline about 75% to 80% as a segment. Since then, the market has been expanding in total dollars "and will continue to expand."

Among the new applications, Shesser is interested especially in autos. "The auto industry is in a lot of the display technologies and they're very cautious in making a major commitment. But, once the acceptance of the microprocessor comes—and it's going on now—they will need electronic displays." While there are many display technologies to choose from, he adds, "gas discharge is the only one that can take the auto's hostile environment of -40°F to $+180^{\circ}\text{F}$. LCDs freeze at the lower temperatures and, at the higher temperatures, the efficiencies of LEDs worsen."

The Burroughs gas discharge display line consists of the Self-Scan matrix line of alphanumeric characters, Panaplex displays that are a low-cost alternative to Nixies, and digitally controlled bar-graph dis-

plays. Sales of all three increased in 1976 over their year-earlier levels and, says Shesser, "will increase again in 1977." Only the Panaplex, "which isn't yet up to projected levels," did not hit a new peak last year, he adds. However, the market for alphanumeric displays "has been building," and that for bar-graph displays "will really take off within six months to a year," he says.

One of the smaller suppliers riding the upcurve is Dionics Inc. in Westbury, N.Y., a supplier of high-voltage driver circuits for the displays. Except for the big upsurge and subsequent downturn, "the business has grown modestly since the early 1970s. But there has been another recent spurt," says president Bernard L. Kravitz. "Our business with gas-discharge-display manufacturers is up about 50% over year-earlier levels."

In the air. Typical of the new equipment in which the displays are winning new and growing markets is the new line of microprocessor-controlled communications, navigation, and identification systems being built by Bendix Corp.'s Avionics division in Fort Lauderdale, Fla. "In order to read the information in sunlight, we have to have proper contrast and brightness," says project engineer Elwood Wheeler. "Gas-discharge and incandescent displays are about the only things we can be sure of seeing."

Bendix chose to go with the gas-discharge units because of their flexibility for several configurations. "We shied away from LCDs because their response time wasn't fast enough for multiplexing, and their temperature window is quite narrow. We want displays that will operate from -40°C to $+70^{\circ}\text{C}$, and that 110°C window is about twice what the present LCDs operate at," points out Wheeler.

As for LEDs, "they simply wash out in the bright sunlight above the clouds," says Wheeler, who says the use of gas-discharge displays in avionics equipment will increase significantly. "Our industry is getting into more of a solid-state mode, and the interface between the pilot and his equipment is much more readily communicated by a gas-discharge readout than was the case with the

older mechanical-drum outputs."

NCR Corp., General Instrument Corp., and Data Terminal Systems Inc. all chose gas-discharge displays in POS-terminal systems because of their easy readability. "Alphanumeric feedback to the operator is very important," says Ed Davis, chief engineer at GI's Unitote/Regitel division in Towson, Md.

For games. The brightness of gas-discharge displays is also cited as a major reason for their use in arcade games. "The intensity of the display is such that it can be used in well-lit rooms and be seen clear across the room," says Frank Bracha, assistant engineering vice president at Bally Mfg. Corp. in Chicago, a producer of electronic pinball machines. Bally also wants to use different color filters to change the game's aesthetics. Says Bracha, "LEDs aren't bright enough to be used with filters, but there's no problem with gas-discharge displays."

The displays also are making inroads into the consumer-electronics market. In digital TV tuning, for example, a number of set manufacturers have opted for plasma readouts for channel indicators. "The brightness and character size of LEDs wasn't suitable for viewing across a room, especially for remote-control sets," says Phil Polack of General Electric Co.'s Television Business department in Portsmouth, Va. Also affecting GE's decision was "the excellent life history we obtained from users on gas-discharge-display field failures," he adds. "Although we design for a seven-year life, we don't want a bunch of failures out in the field, even after sets are out of warranty, because it affects the customer's image of us."

Shortage. Oddly, the popularity of gas-discharge displays has caused at least one equipment maker to shift to LED displays. Litton Industries' Microwave Cooking division in Minneapolis wanted "multiple big suppliers." But there are only two that met the bill—Beckman and Burroughs—so Litton switched to LEDs. It's a problem that gas-discharge-display makers haven't enjoyed for some time, but it hasn't cropped up often enough to cause any rush by the industry to add capacity. □

A few words about Data Precision

Over the years, Data Precision products have reflected truly creative design innovations. Data Precision has led the industry with pioneering advances that have reduced the size, circuit complexity and cost of digital instruments, while improving performance and reliability.

Innovations such as TriPhasic[™] Conversion, Ratiohm[™] Resistance Mode and Isopolar[™] Reference, combined with far-sighted product planning and painstaking quality control (every instrument is put through definitive burn-in and ambient temperature cycle before final approval) have established Data Precision as the industry's leading source of reliable, high-performance, economically priced instruments. Over 60,000 are now in use all over the world, representing some 150,000 instrument-years of service.

For a demonstration or a copy of our comprehensive Digital Instrumentation catalog contact Data Precision Corporation, Audubon Road, Wakefield, Massachusetts 01880, USA
Phone (617) 246-1600
Telex (0650) 949341

Prices U.S.A.



Model 5740—7 digit 100MHz multifunction counter/timer \$295.



Model 1455—4½ digit bench/portable multimeter \$355.
Model 1450—4½ digit bench multimeter \$325.



Model 248—True RMS 4½ digit portable \$345.



Model 3500—5½ digit bench multimeter \$995.



Model 245—4½ digit miniature portable multimeter \$295.



Model 3400—4½ digit programmable bench and systems DMM \$795.



Model 175—3½ digit miniature portable multimeter \$189.



Model 7500—5½ digit programmable systems multimeter and universal ratiometer \$2995. base

DATA PRECISION[®]
...years ahead

For demonstration circle 66
For additional information circle 67

monolithic ceramic capacitors... Georgia style.

Murata "Georgia style" monolithic M-Caps™ are second to none in performance, reliability and economy. Why? Because they're backed by over 30 years of ceramic experience, the world's most automated production facility and "Georgia style" pride in a product you can stake your reputation on. Next time you're looking for monolithic capacitors — epoxy coated rectangulars, molded rectangulars, or chips — check into Murata M-Caps. We think their "Georgia style" will impress you.



First in ceramics

1148 Franklin Road, S.E.
Marietta, Georgia 30067
Tel: 404-422-9777
Telex: 54-2329
TWX: 810-763-4723

Circle 68 on reader service card

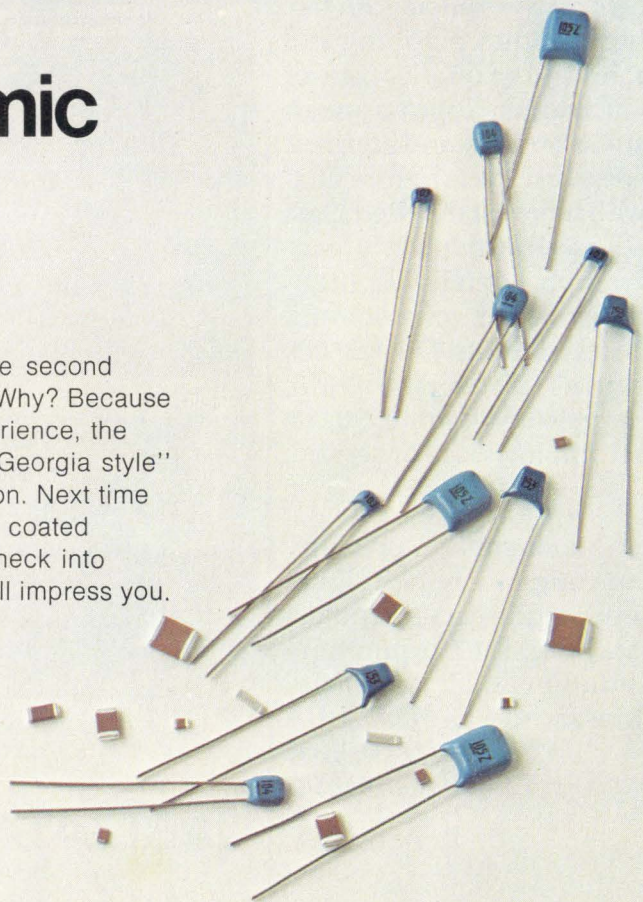

Electronics abroad

Sluggish Sweden is key in Scandinavia

Inventory buildup to keep growth this year below 3.5%, while Norwegian economy leads with anticipated 7% rise

by Arthur Erikson, Managing Editor, *International*

Where their economies are concerned, Scandinavia, in a sense, can be considered one large family. Like many large families, especially those near the top of the economic pyramid, some of the Scandinavian cousins are faring much better than the others.

The Norwegians are out front in affluence at the moment. Their well-oiled economy now seems set to move ahead by better than 7% this year. The Danes, beset by fairly high inflation and by an awesome balance-of-payments deficit, can't expect much more for the coming year than 2% growth.

As for the Swedes, far and away the most numerous of the cousins, they are not quite sure. For the past couple of years, the now-ousted Socialist government kept the economy from sagging through massive support programs that let hard-hit basic industries build up inventories rather than cut back on employment. The new government, which defeated the Socialists, is continuing the programs, but the point has been reached where some industries simply cannot continue to build inventory. Whether Sweden has a dismal year with only 1% growth for its economy or a passable year with about 3.5% growth depends on exports; that is, on how soon the long-delayed upswing in the world economy finally starts.

So don't look for any real zip in overall Scandinavian electronics

markets this year. It cannot happen when the dominant Nordic economy—Sweden's—is having troubles. *Electronics'* forecast for the year ahead, based on a survey made last fall, puts equipment markets for the three countries at \$1.989 billion, a modest 5% rise over the estimated \$1.893 billion for 1976. Because Nordic electronics-equipment makers are such heavy exporters, components markets will probably do much better. They will move up nearly 11% this year to \$465 million, the survey suggests.

Sweden. The Swedes were the first people in Western Europe to become mass buyers of color-television sets, and now, the inevitable has happened: the market has peaked. Some two thirds of Swedish households now have color sets, and, for the first time, sales will edge downward this year. The hi-fi market has also passed its peak. As a result, sales this year of consumer electronics will shrink nearly 11%, from \$436 million last year to \$389 million, the survey predicts.

The expected turndown in set sales offsets the gain—minimal, except for computers—in other sectors. Overall, Swedish equipment markets figure to stay flat at just over \$1 billion. As for components markets, they'll show a 10% rise to some \$276 million, the survey forecasts.

For set makers, the domestic market figures to keep dwindling until something comes along with

the impact that color TV had. No one yet really knows what that something might be, however, so Swedish producers have to make their marks abroad to survive. Lufor AB, the major native set maker (second only to Svenska Philips), expects its sales to rise by some 30% to \$155 million in its current fiscal year, which ends in August. Fully \$55 million of this will come from exports.

For communications-hardware producers, a flat year is in sight, with the market hovering around \$163 million. However, that condition is only temporary. Televerket, the state telephone agency, plans to invest nearly \$800 million in electronic-switching equipment through 1995, and the first allotments are to come in the late 1970s. Another lift will come from the Nordic data-communications network, a \$215 million project that, by 1980, will interconnect some 11,000 subscribers in Stockholm, Oslo, Copenhagen, and Helsinki, its backers say.

As for defense electronics, prospects are up in the air—unfortunately, more figuratively than literally. There is an embryo plan to develop a light interceptor jet that would take over from the current Viggen fighter in the 1980s. But a royal commission on defense has split over whether or not to recommend giving Saab-Scania a definite go-ahead to design the plane. The government, strapped by a whopping deficit, is trying to hold the line on defense spending for the next fiscal year, but the project could turn up on the work list that the parliament presumably will draw up this spring when it forges a long-range defense plan for the country.

Denmark. Danish electronic-equipment markets will mark time this year. From \$461 million in 1976, they will edge up to \$484 million, and the survey suggests where the trouble lies. Radio recorders excepted, all the major entertainment-electronics categories are likely to slump a little this year, pushing the sector's total down to some \$179 million. Last year's figure was \$190 million.

As always, Danish electronics producers have their antennas tuned more to export markets than to those at home. But exports have become

FIRST CHOICE of INDUSTRY

Phoenix Data's ENCASED EDAC Series 3000 Converters

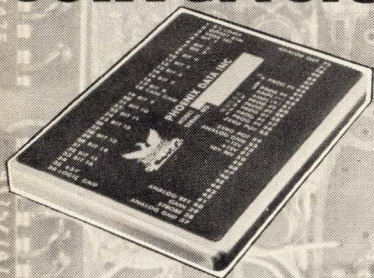

Time-proven reliability and ease of application in a wide range of products have made Phoenix Data's encased digital to analog converters a first choice with commercial and industrial equipment designers everywhere. Reasons why:

- 20 different models.
- 12 to 16 bit resolution.
- Straight binary, offset binary, or 2's complement input.
- Programmable output range selection.
- Bipolar or unipolar output.
- Precision internal voltage reference.
- Pre-calibrated for specified temperature range.
- RFI and EMI shielded.
- Conversion times to 1 usec. for 13 bits, 3 usec. for 16 bits.
- Accuracy to 0.003% of FSR.
- Optional temperature ranges from -55°C to 90°C.
- TTL compatible input holding register.
- Convenient printed circuit board mounting.

All of the EDAC modules are available to meet military specifications.

If it's stability, accuracy, speed, or all-around quality you need in Data Conversion, contact Ron Brunner, director of marketing, or your area representative.



PHOENIX DATA, INC.

3384 W. Osborn Rd. Phoenix, AZ 85017
Ph. (602) 278-8528, TWX 910-951-1364

Probing the news

worrisome, too. Last year, Danish firms turned out some \$580 million worth of electronic hardware. That works out to a gain of some 20% nominally, but only 12% when price rises are considered. Exports, though, moved up only 8% nominally, actually a piddling 2% real gain.

Frede Ask, director of the Danish electronics producers' trade association, foresees a production gain this year about equal to last year's mark. Exports will edge up disappointingly again, too, he expects, "but only if the wage settlements agreed to last August hold," he adds.

With exports flattening, the new "domestic" market, which stems from offset for the F-16 fighters Denmark is buying from General Dynamics, has come at the right time. It looks as if Danish firms will get some \$40 million worth of business for on-board electronics out of the deal. Contracts for about two thirds of this business have been signed. But one major item—the fire-control computer earmarked for Christian Rovsing—still is being haggled over, much to the irritation of the Danes. They are also anxious about their share of off-plane hardware—mainly the integrated ground checkout equipment and the training simulators.

Although they number only 4 million, the Norwegians, with a solid economy and oil as well, could well set the pace for growth this year among the world's industrialized nations. There is virtually no doubt that the country's electronics markets will surge ahead this year. The survey estimates equipment markets at \$480 million—a solid 20% gain over the 1976 figure.

Chalk up some of the increase—but not much—to entertainment electronics. The big lift will come from communications equipment to serve the oil platforms that dot Norwegian waters in the North Sea and for the military. There also will be fallout from the F-16, although it is still not clear how much of the contract offset work the state-run military electronics firm Kongsberg Vapenfabrikk, the main contractor for Norway, will pass along to other companies.

Kongsberg, Tandbergs Radiofabrikk AS (the country's only major set maker), and AS Elektrisk Bureau (which has close ties to L M Ericsson in Sweden) have teamed up for research, product development, and marketing. So some of the F-16 money presumably will find its way to Kongsberg's partners. Moreover, the government has indicated it will help strengthen Norway's native electronics companies—mostly small firms that have to count heavily on export markets to survive. □

SCANDINAVIAN ELECTRONICS MARKETS FORECAST (IN MILLIONS OF DOLLARS)

	1975	1976	1977
Total assembled equipment	1,779	1,893	1,989
Consumer electronics	768	773	722
Communications equipment	316	352	419
Computers and related hardware	464	513	570
Industrial electronics	121	133	146
Medical electronics	55	61	66
Test and measurement equipment	40	45	48
Power supplies	15	16	18
Total components	396	420	465
Passives	231	246	267
Semiconductors	95	100	122
Tubes	70	74	76

(Exchange rate: Denmark, \$1 = 5.9 kroner;
Norway, \$1 = 5.3 kroner; Sweden, \$1 = 4.2 krona)

Note: Estimates in this chart are consensus estimates of consumption of electronic equipment obtained from an *Electronics* survey made in September and October 1976. Domestic hardware is valued at factory sales, prices and imports at landed costs.

You won't find a better family of printers for the price. It's that simple.

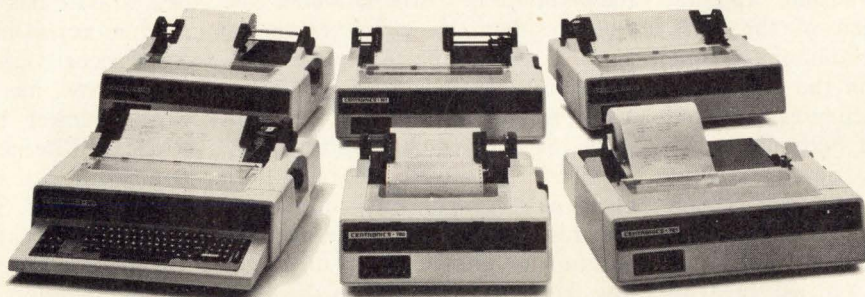

The New Centronics 700 Series.

Now, the features that make our model 700 the best, lowest-priced serial printer are available in a *family of seven* models: uncomplicated modular construction; the reliability of fewer moving parts; high parts commonality; and low price. All of which means a lower cost of ownership.

The new 700 family covers a full range of serial printer requirements: 80- and 132-column format; 60 to 180 cps speed range; bi-directional and logic-seeking operations; and 110-300 baud KSR and RO teleprinters.

Like all Centronics printers, the 700 family is better because we back them with a wide choice of customizing options and accessories. More than 100 sales and service locations worldwide. Centronics' financial stability, and dependability proven by more than 80,000 printers installed.

Simplicity of design, full range capabilities, and better back-up make our 700 series printers simply better. Centronics Data Computer Corp., Hudson, N.H. 03051, Tel. (603) 883-0111. Or Centronics Offices in Canada and throughout the world.

CENTRONICS® PRINTERS
Simply Better

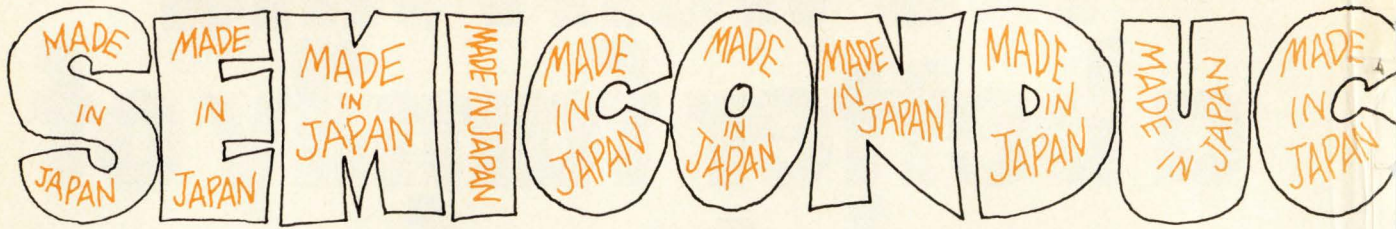

Americans becoming concerned as Japanese begin to close gap;
Nippon Electric chalks up \$30 million in U.S. sales

by Lawrence Curran, Boston bureau manager

A few years ago, most U. S. semiconductor executives estimated that they were two years ahead of Japanese technology. Today, that gap has been bridged or greatly narrowed, and leaders in the U. S. semiconductor community are clearly worried as Japanese competitors begin to chip away at the U. S. market—particularly the computer portion.

Except for consumer products such as calculators and watches, Japanese penetration of the U. S. markets for semiconductors to date has been shallow, in the opinion of Floyd Kvamme, vice president and general manager of National Semiconductor Corp.'s Semiconductor division. "But the American market is virtually wide open for the Japanese, with practically no barriers," Kvamme asserts, "Contrast this with the situation for foreign companies [competing] in Japan, where they're virtually shut out," Kvamme laments.

John Welty, a Motorola corporate vice president and group executive of the Semiconductor group, says the Japanese are setting reliability standards that pose a problem for U. S. firms to meet. "They're bright, and they work hard," Welty says. "That may be the most unfair competition of all."

Commitments. Intel Corp. chairman Robert Noyce shares Welty's respect. He notes that Japanese companies "have made major commitments to supplying components—especially computer components—to the Western world." Although he has not seen those commitments result in important inroads into the U. S. market yet,

Noyce says, significantly, the names of Japanese firms are appearing on reports listing the companies to which Intel has lost certain orders.

The leader among Japanese companies concentrating on the U. S. semiconductor market is clearly Nippon Electric Co., which will sell some \$30 million worth of semiconductors of all kinds in the U. S. in its fiscal year ending March 31. That's the estimate of Hiroe Osafune, NEC vice president. He characterizes the U. S. sales of other Japanese semiconductor producers as negligible, although Hitachi, Fujitsu, and Toshiba are starting sales efforts.

A Fujitsu source agrees with Osafune's assessment, indicating that his company's U. S. integrated-circuit sales consist mostly of sample lots. Toshiba's strength, in the opinion of one major U. S. competitor, is in power transistors, particularly for color-television sets, while Hitachi's U. S. activity is also aimed mainly at consumer equipment from a Los Angeles base.

U. S. marketer. NEC has had U. S. marketing arms for several years, but not until mid-1975 was NEC Microcomputers Inc. established in Lexington, Mass., to concentrate on marketing memories and microprocessors in the U. S. The company is staffed by 24 Americans who regard themselves as a U. S. company with an offshore manufacturing facility. In that sense, says NEC Microcomputers president Roger H. Bender, "our customers have the same kind of interface they're accustomed to" because the major U. S. semiconductor houses also have offshore facilities.

NEC Microcomputers, which will add about a dozen more marketing and marketing-support people in the Lexington office in the new fiscal year beginning April 1, will open its first regional offices—in the western and central U. S.—this year. The company has no direct salesmen; it works entirely through distributors and representatives.

The Lexington firm's greatest success to date has been with 4,096-bit random-access-memories. One New York security analyst estimates that parent NEC has about 13% of the world market for 4-k RAMs, and Richard Koerner, NEC Microcomputers' director of marketing, maintains, "Our U. S. activities account for a healthy part of that."

Products. George Muller, NEC Microcomputers' vice president and treasurer, says the Lexington company has been shipping tens of thousands of its fast (135-nanosecond access) 22-pin dynamic 4-k products since late 1975. The company also offers a 4-k static RAM with 100-ns access, smaller RAMs, a variety of read-only memories and program-mable ROMs, an 8080A-based microprocessor set, and controller devices to interface microcomputers to floppy disks and tape cassettes.

Back in Japan, Osafune says the parent company this year will introduce, among other products, a 16-k dynamic RAM that will be handled by Lexington. Muller predicts that the parent company could take 20% or more of the U. S. market in memories, microprocessors, and interface circuits.

Probably the biggest U. S. customer for NEC's 4-k RAM's is Honey-

MADE IN JAPAN
MADE IN JAPAN
MADE IN JAPAN
MADE IN JAPAN

well Information Systems Inc. The Phoenix-based computer maker is also exchanging design and process information with NEC on Honeywell's bipolar current-mode logic used in the new model 6865 mainframe with an eye to making NEC its prime source. "We're giving them very high marks," says a top Honeywell engineering official, adding that there's no problem working with a factory located in Japan.

NEC Microcomputers' Bender won't rule out a U. S. manufacturing facility for the parent, adding that the capacity at the Kumamoto City plant in Japan would have to be exceeded first. But, Muller asks rhetorically, "Where would it make sense to build more capacity when that happens?"

Disparity. Must top American semiconductor executives think that, given an even chance, they can counter the Japanese competition. Typical are comments from National's Kvamme and Intel's Noyce. "By even chance," says Kvamme, "I don't mean erecting trade barriers and subsidizing the U. S. semiconductor industry. What we'd all like is a chance to penetrate the Japanese market. We don't mind a little competition here if we can have a little competition there."

Noyce is less sanguine. He does not like the disparity in import taxes charged in each country—17% by the Japanese vs 6% in the U. S. Says he, "the time has come for the U. S. to say to the [Japanese government] that we'll trade on an even basis by imposing precisely the same import limits in the U. S. as Japan does in Japan." □

Now, a single integrated circuit, our TAD-32 (Tapped Analog Delay), can provide filtering with passband-to-stopband ratios of 40 DB or more per device. Simple variation of the clock sampling rates over 5 decades will accordingly shift a given filter characteristic. Transversal or recursive filters can be constructed with over 60DB dynamic range and linear phase. Tapped delays up to several hundred milliseconds are possible.

Discrete time analog signal processing using charge transfer devices is a reality at RETICON.

The TAD-32 is just one device in this growing family.

We don't just talk about them, we make them.

THIS DIP DOES IT ALL.

TAPPED DELAYS
MATCHED FILTERS
CORRELATION
CONVOLUTION

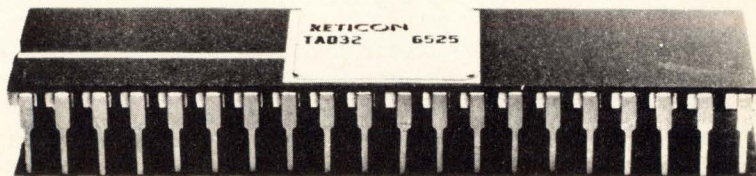

RETICON®

910 Benicia Avenue, Sunnyvale, California 94086
PHONE: (408) 738-4266 TWX: 910-339-9343

You and your career

New IEEE head casts wide net for ideas

by Gerald M. Walker,
Senior Editor

Soon after a narrow majority had elected him president of the Institute of Electrical and Electronics Engineers, Robert Saunders happened to be sitting next to a leading clinical psychologist on a plane. He asked the psychologist for a quick analysis of why there is so much apathy among the institute's members—why only 36% of eligible members had voted, even though the election was a hotly contested, three-way race for president. The psychologist suggested voters were apathetic because the election was not threatening enough to individuals to spur them to vote.

That is an illustration of Saunders' approach. "Taking IEEE's problems to a psychologist is a little unusual, but I'm always ready to use other people's ideas," Saunders says.

"What seems like a radical idea today may be the accepted norm tomorrow," he adds. "Ideas, not personalities, are IEEE's business. And there's a danger of missing good ideas if you don't divorce the issue from the person presenting it."

The 1977 president, a professor of electrical engineering at the University of California—Irvine, may well want to go back to the psychologist with another problem—reconciling the conflicts between the growing number of articulate dissident members and the increasingly intransigent establishment leaders concerning the professional-activities programs. At the same time, Saunders is worried about maintaining the



Top man. The IEEE's 1977 president, Robert Saunders, wants to improve accreditation, industry relations, the institute's fiscal affairs, and membership communications.

institute's traditional position as leader in technology information. Recently, too, he has been confronted with the need to pick a search committee to find a replacement for general manager Herbert Schulke Jr., who has resigned.

Saunders has four goals for the coming year that drive to the heart of the IEEE's problems. One is oriented toward the dissidents, one toward the conservatives, and two toward everyone.

Schools. The first objective will be to come to grips with the accreditation of engineering schools. "Accreditation has always been delegated to the engineering academic community, but there is evidence that the members feel the academic community is not doing it right. So we are going to take a look at how to do it right," he explains.

The second goal is to improve the IEEE's relations with industry. These relations are causing uneasiness within the conservative wing of the institute, which fears, among other

things, that the professional-activities program is leading toward unionization of EES.

"Just as IEEE sets technical standards, it can set professional standards. At no time do we say Corporation A does not meet the standards or Corporation B does. We should never have a black-list or a whitelist. Standards are best enforced by industry," he says.

If he survives the controversy that these two goals are bound to generate, Saunders has a couple of other equally troublesome projects in mind. One concerns dues and fiscal management. After a shaky financial period, the institute has now gone to a system of deferred expenditures in which a major portion of the annual budget is not actually committed until April.

Saunders admits that the last dues increase was not handled very well. Members were not adequately informed of the reasons for the increase, he says, and the result was resentment, a drop in membership,

REACT

Rapidly Evaluate & Apply Custom Technology.

REACT means that custom LSI for many applications can be attained in 3 to 6 months, at costs ranging from \$18k to about \$38k. REACT does not gain its cost-efficiency from a library of gate arrays, cells or mask-programmable chips—but rather from our extensive background in using advanced processes to custom-integrate complete logic functions. Chances are we've already optimized the design for many of the logic functions your product requires.

Over the past six years, we've developed more than 300 microcircuits to help many manufacturers realize the benefits of custom LSI. Benefits like reduced assembly costs, lower power consumption and smaller size.

Along the way, we've even developed and refined our own brand of LSI—High-Density CMOS (HD/CMOS). This production-proven process has effectively reduced both size and power consumption in a wide range of products, including digital watches, CB radios, multimeters and pacemakers.

Thanks to innovations like HD/CMOS, and our long experience in integrating custom logic, the time and cost for custom LSI development is being dramatically reduced. This development is so significant that we decided to label it REACT—for Rapidly Evaluate & Apply Custom Technology.

REACT means compatibility with the standard CMOS devices in the 4000 Series. The transition from this standard logic family to our high performance HD/CMOS is a natural evolution. In fact, we encourage our customers to prototype their design with 4000/CMOS before custom HD/CMOS development.

REACT could also mean an effective way to streamline microprocessor-based designs. In many cases, HD/CMOS can be used to custom-integrate the peripheral logic required to make a microprocessor function.

We've prepared a special brochure which describes our REACT program more fully. This brochure also contains a discussion of custom LSI time/cost considerations in today's numbers. For your copy, circle the R.S. number, or contact REACT Marketing, at (408)247-5350.



3100 Alfred Street, Santa Clara CA 95050

Circle 75 on reader service card

REAL TIME Analog I/O for Intel SBC 80/10 or MDS-800

A single board Analog I/O system for Intel's new single board computer. For laboratory or industrial measurements our DT1751 system can process 16 analog input channels and has 2 analog output channels with power amplifier for driving industrial loads. Drive CRT's directly as well...using the built-in point plot controller.

Real Time measurements are easily done with standard features such as external A/D trigger plus convenient interrupt operation. Optional switch gain amplifier extends dynamic range to 14-bits. CALL US at (617) 879-3595 for a complete set of applications data.

DATA TRANSLATION

INC

109 CONCORD ST., FRAMINGHAM, MA 01701 (617) 879-3595
TELEX 94-8474

...the analog I/O company

Circle 175 on reader service card

Probing the news

and two proposed constitutional amendments to make dues increases subject to a vote of the membership. Neither propositions won the two-thirds majority vote needed to pass, but the leadership got the message.

Accordingly, he will ask the treasurer to draw up three budgets for next year: one with no increase in dues and services cut to meet income, another with services held constant and the costs reflected in dues, and a third containing additional services members indicate they want and the extra cost per member. With three choices, members will be sampled to find out which way to go.

Give and take. The fourth objective is an old one around the institute—improving communications with members. There will be expanded coverage of institute news in the IEEE publication, Spectrum, and use of reader-response cards to sample opinion. Saunders hopes to get other officers to seek ideas from members just as he will.

As an example of ideas that have come from the membership, Saunders points to the provision for candidates to prepare rebuttals to campaign statements of their opponents. Another idea was a proposition on last year's ballot calling for full publicizing of all future propositions so that members will know how to vote. Although the board of directors was against the proposition and it did not get the necessary two-thirds majority, he is certain the concept will be put to use this year.

"These were two good ideas that came from John Crowe of Los Angeles [called Gadfly West around the IEEE headquarters to distinguish him from Irwin Feerst, Gadfly East]. He is not part of the operating committees, but Crowe produced a change in direction."

Will the fact that he is actually a minority president, with only 44% of the vote, hinder his activities? "There is no change in my attitude," he says. "The board of directors does not dance to the president, it's the other way around. So I see our activities as following a consensus rather than a single leader." □

JOIN the PAC

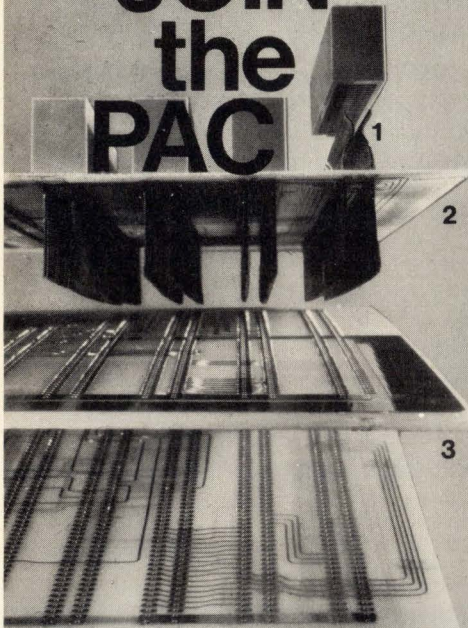

Edge-Pac®

A patented card edge backpanel system that offers you the finest in press-fit technology. A pre-loaded contact (1.) is press-fit directly into plated-thru holes in the etched board. (2.) The insulator is held firmly into place by an interference fit with the contact. Any size connector can be used, giving you complete system flexibility.

Multi-Pac®

Combines the reliability of Edge-Pac® with the cost savings of multi-layer backpanels. The discrete two-sided plated-thru boards (2, 3, 4) are sandwiched together with the high force press-fit contacts. The gas tight interface between the contact and each board is extremely reliable. A mylar insulating layer separates each board allowing interconnect systems of up to eight planes of circuitry.

Join the Pac... Specify Elfab patented press-fit backpanel systems. Send for our new design brochure today. Call or write Elfab Corporation (214) 233-3033, P. O. Box 34555, Dallas, Texas 75234.

The Leader in Press-fit Technology



76 Circle 76 on reader service card

Electronics/February 17, 1977

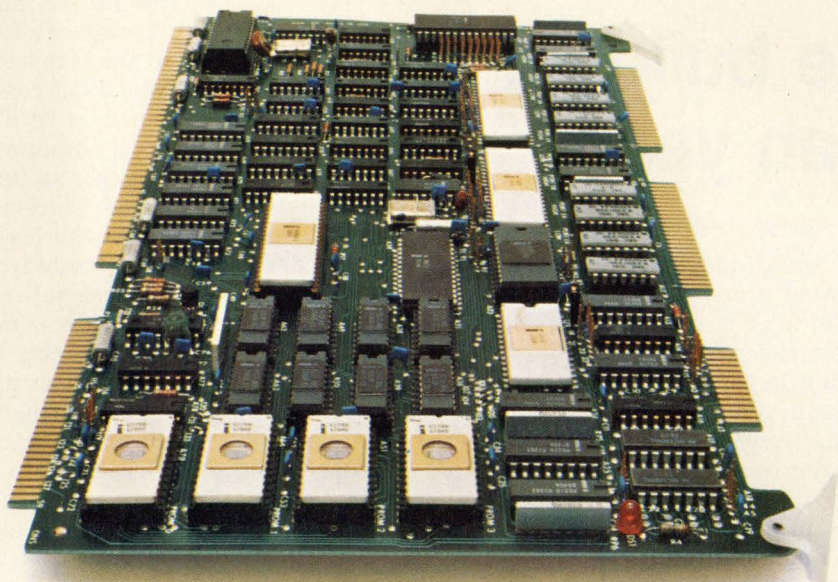

Intel delivers real time microcomputer multiprocessing. The new SBC 80/20 Single Board Computer.

SBC 80/20 delivers system throughput and design flexibility previously unobtainable on a Single Board Computer. Like our low cost industry standard SBC 80/10, the SBC 80/20 has everything you need—CPU, EPROM, RAM and programmable parallel and serial I/O—all on a single 6.75" x 12.0" board. And because the SBC 80/20 also has dual bus architecture, multiprocessor bus control, programmable eight level vectored interrupt and programmable timers, it is your best choice for real time multiprocessing and other high performance applications.

SBC 80/20 increases system throughput and improves system reliability by allowing tasks to be segmented in a true parallel processing

configuration. Operate up to sixteen SBC 80/20 systems simultaneously without tying up the system bus when using on-board memory and I/O. And when access is required to resources sharing the system bus, on-board multiprocessing logic provides the necessary bus priority control.

SBC 80/20 has eight levels of programmable vectored priority interrupt making it possible to immediately respond to critical I/O requirements. Priority assignments and priority algorithms are under program control and can be dynamically reconfigured as system requirements change.

SBC 80/20 has two programmable timers that increase throughput by relieving the CPU of timing and event counting operations. Each timer may

be programmed by system software to operate as a real time clock, interval timer, or event counter.

To protect data integrity, the SBC 80/20 includes an auxiliary memory power bus and all the logic necessary for implementation of a battery back-up system.

Ask for our new 24-page brochure describing the entire family of Intel® SBC 80 Single Board Computers, System 80 packaged systems and expansion boards. For your copy or for a demonstration contact your local Intel representative, use the reader service card or write: Intel Corporation, 3065 Bowers Avenue, Santa Clara, California, 95051.

intel® delivers.

Space electronics

Satellite builders face lean years

by Larry Waller, Los Angeles bureau manager

An industry whose worldwide customer traffic is growing nearly 20% each year would seem to offer ample opportunity for companies selling systems hardware. But in communications satellites, both commercial and military, the near-term outlook is for a dearth of major contracts.

No less an authority than Albert D. Wheelon, vice president and group executive of Hughes Aircraft Co.'s Space and Communications group, confirms this view. "The next few years appear to be a flat spot in the issuance of big communications contracts," he says. Hughes, of course, started the whole communications-satellite business with its Syncom for the National Aeronautics and Space Administration, launched into synchronous orbit in 1963. Now, Hughes may be the systems hardware manufacturer forced to tighten its belt the most although it has paced the field in both sales and technology. But it was hit particularly hard in recent months, losing out on both Intelsat 5 and the Air Force's DSCS III after being considered the leading contender for both.

Though the situation could change rapidly and dramatically, a combination of circumstances has caused the new business prospects to be leaner than at any time in years, industry sources say. First recent awards saw the big domestic and international consortiums take care of their hardware needs for several years (see table). Second, there is the influx of formidable competition into what was virtually the private preserve of Hughes and TRW Systems until about 1972. These include General Electric Co.'s Space

division, Ford Motor Co.'s Ford Aerospace and Communications Corp., Rockwell International Corp., and RCA Corp., all of whom subsequently won contracts, in addition to perpetual bridesmaid Lockheed Missiles and Space Co.

GE and Ford Aerospace, among fairly recent entries, made the

Recent awards

Defense Satellite Communications System III for Air Force. GE, \$75 million for one developmental and two operational models. February 1977.

Tracking and Data Relay Satellite Systems for NASA. A team of Western Union, TRW, and Harris Corp, \$309 million for two synchronous relay satellites and U.S. earth terminal. December 1976.

Aerosat Partnership. GE-led team, negotiating price for two experimental models for improved ocean air-traffic control. November 1976.

Intelsat 5 for International Telecommunications Satellite Organization. Ford Aerospace, \$235.5 million for seven large-scale satellites for 95-nation coverage. September 1976.

deepest inroads on the territory of the two established satellite houses. Price was probably the decisive factor in GE's winning the Aerosat project away from TRW Systems and also in Ford's edging out Hughes on Intelsat 5. While losers often level "low-ball" charges against winners, observers note that evolution from

technological to price competition is one mark of a maturing industry.

Bid talk. Still, one report making the rounds of systems houses after the Intelsat 5 award held that top corporate officials at Ford Motor Co., determined to keep the company in the business, ordered Ford Aerospace's bid chopped by millions at the 11th hour. While the company would not comment, other observers noted, in Ford's favor, that it did the most diplomatic job of putting together an international consortium of subcontractors.

On the horizon as the next sizeable hardware purchases are three commercial projects, sources say. Foremost is the \$400 million Satellite Business Systems digital communications network, to be operated by a partnership of International Business Machines Corp., Comsat General Corp., and Aetna Insurance Co. It expects to issue a request for proposals to industry by summer and award a contract for the birds before the end of the year. Legal challenges and further antitrust considerations might delay this schedule, however.

Other projects are Telesat—the Canadian government's next satellite for general-purpose voice and TV broadcasting—and a domestic Brazilian system. There is also no lack of rumored new business, including an Iranian system, a direct broadcast system for Nordic countries, and an expansion of NASA's communications effort.

In the meantime, companies in the business will have to scramble for whatever contracts are available. In the case of Hughes, one industry official observes, "I'd hate to see them get any leaner or meaner." Although the industry leader still has a sizeable backlog, employment declined in 1976 from 4,500 to 3,600 and could sink further. "In the long pull," Wheelon admits, "no company can stay in the business building one satellite a year."

Staying power. Only one company, Lockheed, has dropped out of bidding for prime contracts so far, but others could do likewise, according to some officials. Still, the consensus is that major firms with footholds will stick at least until the early 1980s, paying whatever price is necessary. □

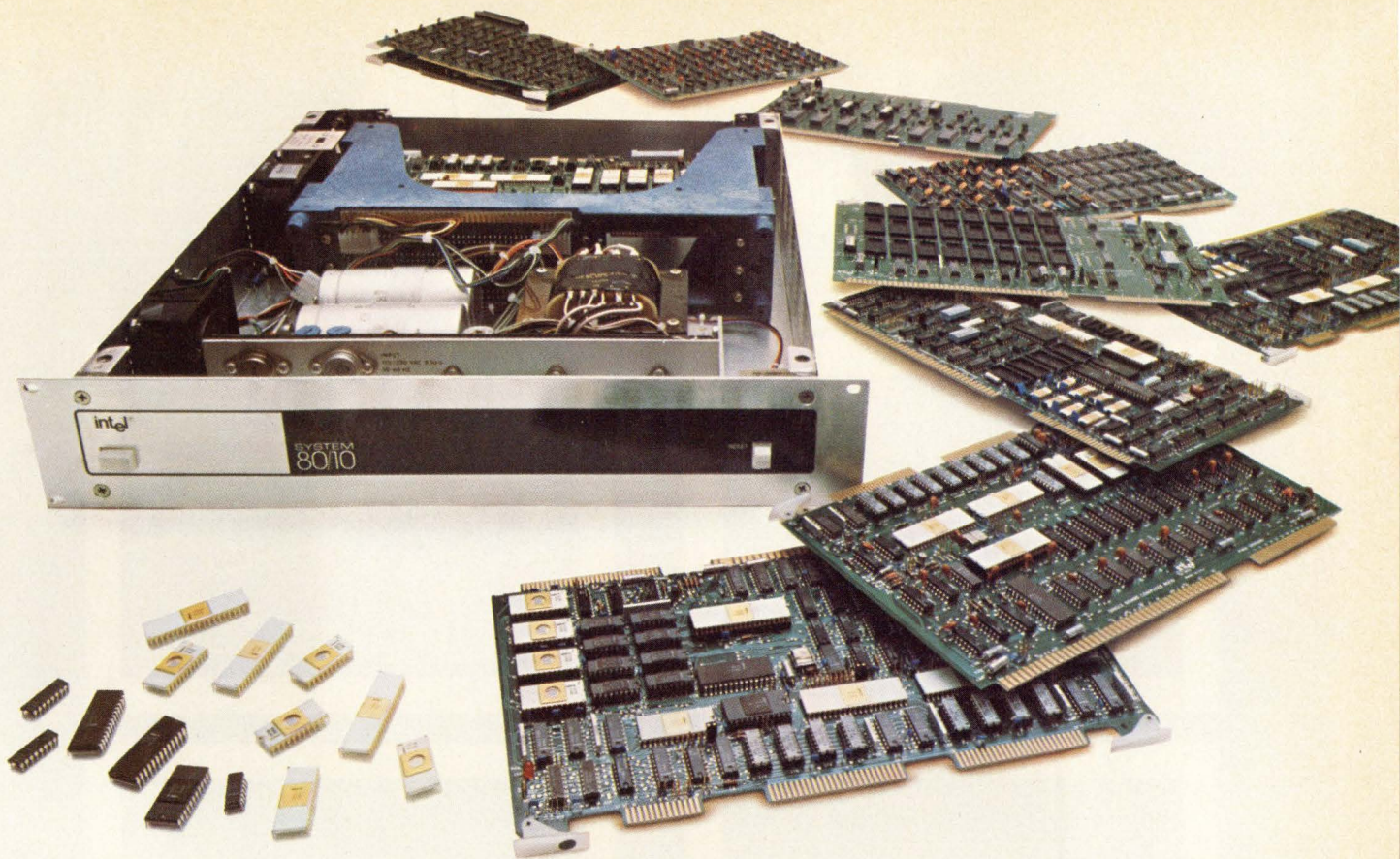

Intel delivers microcomputer systems that take the risk out of becoming successful.

Intel takes the risk out of becoming successful by providing economic, flexible and reliable microcomputer hardware and software solutions for your moderate and high volume requirements.

For most moderate volume microcomputer applications, it makes economic sense to buy an assembled and tested microcomputer system. That's why we offer two Single Board Computers (SBC 80/10, SBC 80/20) and two packaged systems (System 80/10, System 80/20). When you decide it's more economical to do the job "in-house," we'll make arrangements for you to use our bill of material, fab and assembly drawings, and artwork. And since we manufacture *all* the essential components—CPU, EPROMs, ROMs, RAMs, programmable I/O, and other LSI devices in volume, you can order the components from us and continue to take advantage of quantity discounts. *No penalty for success.*

Intel® microcomputer systems are flexible and easily configured to your specific needs. Expanding your system or reconfiguring the I/O is easy. All Intel microcomputer systems are supported by a complete line of I/O and memory expansion boards, diskette and DMA controllers, power supplies, card cages, and accessories. And since I/O, communications, timer and interrupt control functions are programmable, you can reconfigure the system to match your application by altering a few bytes of memory instead of redesigning system hardware.

And Intel delivers more than microcomputer systems that give you the cost/performance advantage. In addition we provide Intellec® Microcomputer Development System support to get you to market sooner. Intellec resident PL/M, the high level microcomputer language, can cut man months off your software development schedule. Intellec ISIS-II Diskette Operating Software, with

linkage and relocation capabilities, will save more programming time. Develop programs in small manageable modules—then link them together or link them with general purpose subroutines from a software library. Reduce system integration and checkout time with the Intellec resident ICE-80™ In-Circuit Emulator. Develop, symbolically debug and execute high level and assembly language programs directly on your System 80 or SBC 80 based prototype.

From hardware and software development all the way through production, Intel gives you the competitive advantage. For a copy of our new 24-page brochure or a demonstration contact your local Intel representative, use the reader service card, or write: Intel Corporation, 3065 Bowers Avenue, Santa Clara, California 95051.

intel® delivers.

Circle 79 for technical information
Circle 78 for a demonstration and technical information

The Model 186 art gallery.

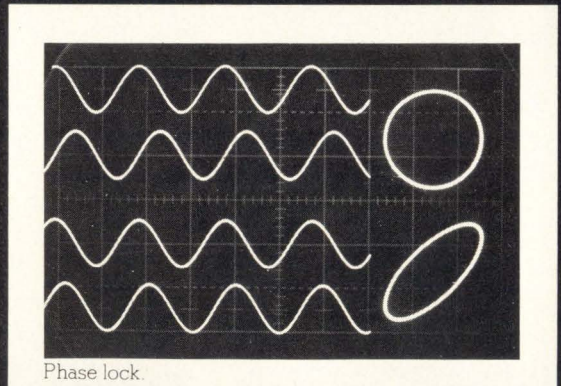
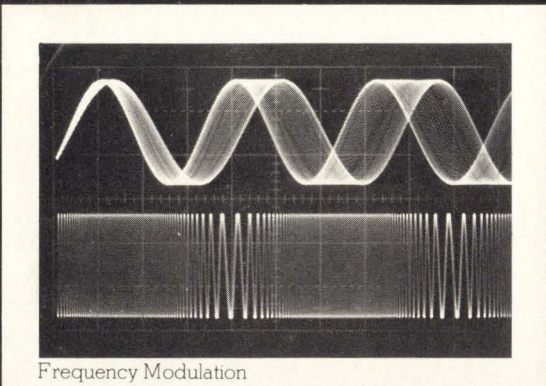
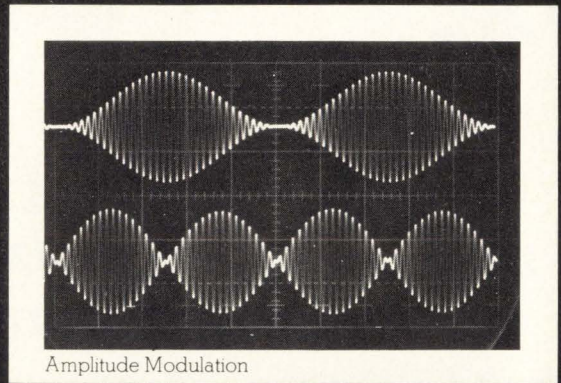
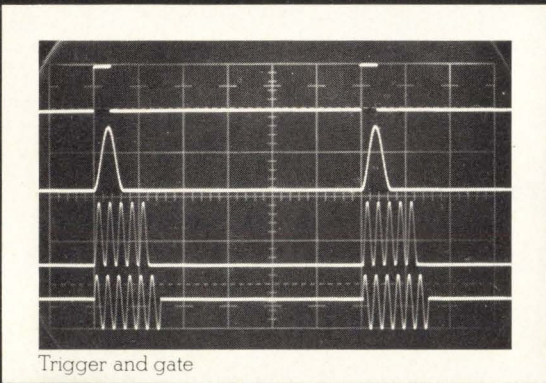
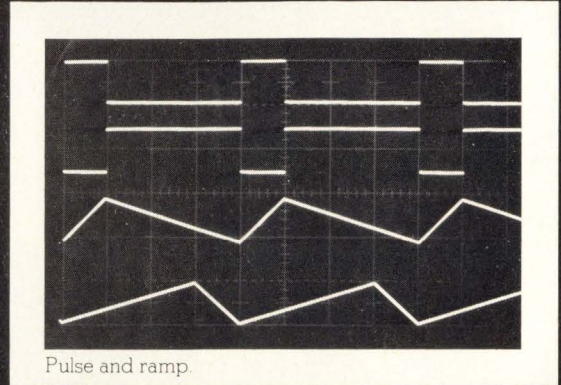
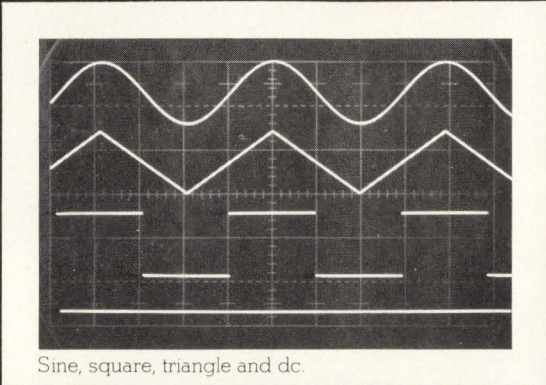

There's a whole lot more to the Model 186 than just pretty pictures. Like its calibrated phase lock and built-in oscillator for 1 kHz AM/FM capabilities. It also has 30 v p-p output plus continuous, triggered and gated modes. And it's the only generator that gives you the combination of AM and phase lock.

Circle 80 on reader service card

The Model 186 has a frequency range of 0.0001 Hz to 5 MHz and sells for just \$795.* Just circle our bingo number and we'll send you the complete picture.

*US domestic price only.

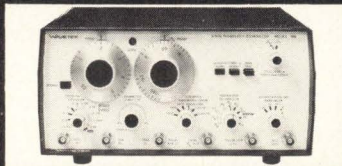

WAVETEK[®]
P.O. BOX 651, SAN DIEGO, CALIFORNIA 92112
TELEPHONE (714) 279-2200, TWX 910-335-2007

Special report ISSCC

- ## WHAT'S NEW—
- minis on chips
 - alterable ROMs
 - multi-function linears
 - and more

Two kinds of people are jostling their way along the corridors of the Philadelphia Sheraton this week—device specialists, come to exchange technology and circuit ideas at the 1977 International Solid State Circuits Conference, and device users. The specialists will have plenty to discuss, what with new metal-oxide-semiconductor methods employing stacked gates, V-notch isolation and silicon-on-sapphire approaches, not to mention bipolar techniques that boost the performance of injection logic in digital applications and increase the functional complexity of linear integrated circuits for analog applications.

But most important to the general electronics community is the fact that the ISSCC has become the premier conference for semiconductor device entry. This aspect of ISSCC, although unadvertised, is again bringing hundreds of IC users to Philadelphia to hear manufacturers disclose their new products for the coming year.

In microprocessors, for example, there are Intel Corp.'s 8748/8048 computer chips, built with the Santa Clara firm's new 5-volt MOS process for low-end applications and already out in sample form to manufacturers of control equipment. Fairchild Semiconductor has used injection logic for its high-performance 9400 one-chip central processing unit, which exactly emulates the CPU functions of a Data General Nova 1200 minicomputer. Then there is Hewlett-Packard Co.'s new chip—a 16-bit complementary-MOS CPU that HP built on a performance-boosting sapphire substrate for its new line of minicomputers. Not surprisingly, the first microprocessor to be designed by Bell Laboratories has a communications orientation (it's an 8-bit complementary-MOS device and is ready for pilot production), while RCA Corp. is producing the 1802, an 8-bit microprocessor chip, with the dense closed-C-MOS-logic process that it calls C²L.

ISSCC is equally rich in production-ready memory devices. Witness Mostek Corp.'s high-speed 16,384-bit dynamic MOS random-access memory, the 4116, which the company has begun supplying to major memory users [*Electronics*, Jan. 20, p. 86] along with its new 5-volt 4,096-bit static RAM, the 4104. Phoenix-based EMM/Semi Inc.'s recently introduced 4,096-bit static memories have made the conference agenda as well, in their clocked and unlocked versions. In high-speed

memories, Fairchild is presenting its 40-nanosecond 4,096-bit static part, which is about to enter the Mountain View company's expanding line of bipolar memories. In addition, its neighbor in the Bay Area, Intersil Inc., is introducing its 30-ns 1,024-bit transistor-transistor-logic RAM. Finally, Intel Corp. is disclosing the 450-ns stacked gate n-channel MOS process that the big memory manufacturer uses in its popular 2708 erasable read-only memories.

As for new linears, the show is full of outstanding items. Designers involved with analog signal processing will want to check out the ISSCC session on a trio of upcoming data converters: a monolithic 12-bit digital-to-analog converter from Precision Monolithics, a single-chip 4½-digit integrating analog-to-digital converter made by Japan's Nippon Electric Co., and a two-chip five-digit a-d developed by Philips Gloeilampenfabrieken in the Netherlands. Work in special-purpose large-scale linears is also reported to be forging ahead, led by a new self-contained camera-control chip from National Semiconductor Corp. and also by Mostek's ingenious mixed-

by Laurence Altman,
Solid State Editor,
and Lucinda Mattera,
Components Editor

process dialer circuit for use in tone telephones.

In sum, then, this year's ISSCC combines scintillating new technology and significant new product entries.

Microprocessors, memories dominate digital sessions

The nonstop push to cheaper, better, smaller, faster electronic circuitry has bred an exceptionally lively bunch of MOS and bipolar digital-circuit technologies for this year's ISSCC. Applied to microprocessors and memories, the newest in large-scale integration is already moving a multitude of chips into production that will raise the sights of digital-system designers everywhere.

Microprocessors: more power at both ends

Only one session of this year's program deals directly with microprocessors, so program chairman Peter Verhofstadt of Fairchild wisely concentrated his efforts at the two ends of the performance spectrum: low-cost controller performance and high-end 16-bit minicomputer performance. That is where the focus of development has shifted to, away from the more established byte-oriented middle ground.

Super star of the low end is Intel Corp.'s new 8748/8048 microprocessor (Fig. 1). It is a one-chip microcomputer that combines the low-cost potential of calculator types with the very respectable performance of many multi-chip microcomputer families. Using a single 5-v MOS process and a multiplexed bus architecture, designers at the Santa Clara, Calif., firm were able to integrate on a single LSI chip a powerful 8-bit CPU and 256-bit random-access memory with an 8,192-bit program memory and plenty of input/output capability. In one version the 8-k read-only memory is erasable by ultraviolet light. The device is easily the most powerful of the new one-chip microprocessors being introduced this year for control applications, since many of the others have only bare-bones arithmetic and minimal 1,024-to-2,048-bit program ROM capability. (For details of the Intel chip, see *Electronics*, Nov. 25, p. 99.)

Just as impressive for minicomputer applications is the

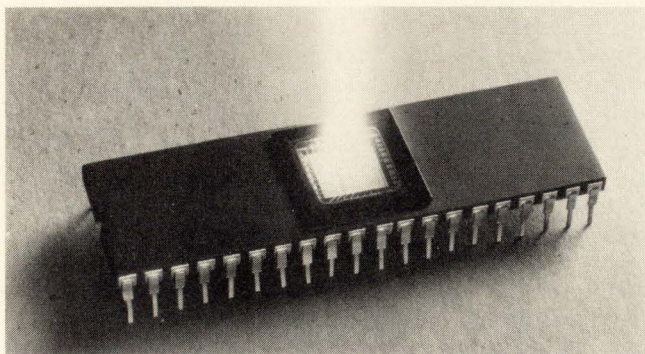

1. Free to change. Intel's 8748/8048 one-chip computer has plenty of processing for byte-oriented control and processing jobs. This version has 8,192 bits of program memory that can be reprogrammed with ultraviolet light for prototyping or small-run systems.

one-chip 16-bit Nova CPU from Fairchild Semiconductor, Mountain View, Calif. The CPU function of the Nova 1200 minicomputer takes over 100 TTL packages, and to duplicate that on one chip, the IC manufacturer combined an integrated-injection-logic circuit design with a proprietary Isoplanar process (it calls the combination I³L). The resulting chip offers low power and high speed (160 microwatts and 4 ns per gate) and very high packaging density, making it no larger than many 8-bit MOS microprocessors. Most significantly, Fairchild technologists were able to reach these impressive design goals without resorting to Schottky I³L designs, a course that would have complicated the process and therefore added to its cost.

The device has a 24-pin package and, by virtue of its ability to perform Nova instructions, will find an immediate market because of the many Nova systems in operation. More fundamentally, the 9400 CPU can be used in any 16-bit fixed-word-length general-purpose processor in any data-processing or industrial process-control application. The Fairchild chip has a stored-program architecture that uses homogeneous memory—instructions and data are stored in the same memory. Since it can handle a full 16 bits of information but uses only 15 bits for addressing the memory, its intrinsic memory-addressing capacity is 32,768 16-bit words, more than enough for most minicomputer applications.

Just as revolutionary is Hewlett-Packard Co.'s 16-bit microprocessor called the MC² (for micro CPU chip). But the big Palo Alto, Calif., manufacturer favored complementary-MOS-on-sapphire technology rather than injection logic for the device. Larry Lopp, HP's large-scale-integration manager for computer products, feels that C-MOS on sapphire is the best way to achieve high-performance LSI circuits for digital applications. The SOS technique enabled HP to integrate an entire 16-bit parallel CPU, containing almost 10,000 transistors, on a single 10-volt, 500-milliwatt chip measuring just over 40,000 mil². Worst-case cycle time is 150 ns, with instruction execution speeds ranging from 0.6 microsecond to 1.8 μ s.

The MC² microprocessor executes 34 basic classes of 16-bit instructions. Since these instructions have been tailored to provide maximum flexibility in handling I/O peripherals, the chip is ideal for high-speed controller applications. For instance, it has separate asynchronous I/O and memory handshakes, a feature that permits mixing memory and I/O operations that occur at different speeds. In addition, the separation of data, address, and control buses simplifies the decoding logic and increases throughput.

Architecturally, the HP microprocessor consists of an arithmetic/logic unit, memory-pointing registers, and control logic, tied together by independent 16-bit bidirectional buses. Included in the control section are a 5-bit state counter, 44 control flip-flops, assorted drivers and random logic, and three logic arrays.

Apart from the use of sapphire substrates, these logic arrays are perhaps the most innovative design feature of The MC². Called a custom logic array or CLA by HP designers, each can handle the program information in a much smaller area than can standard ROMs. The CLAs

What makes ISSCC run

What had its roots as a small Transistor Circuits Conference in 1954 marks its 24th year with the lifting of the curtain at this week's International Solid State Circuits Conference in Philadelphia. Once a forum for discussing recent developments in transistors for radio and television sets, the annual gathering of solid-state-circuit manufacturers and users nowadays "presents a moving view of the state of the art—you can always spot trends earlier there," says Jack Kilby, holder of many of the basic integrated-circuit patents.

Right from the start, the ISSCC has been *the* event for which circuits people save their best material. As Jack A. A. Raper, manager of advanced controls and displays at General Electric Co.'s Electronics Laboratory in Syracuse, N.Y., points out, "The program committee is able to choose from a large number of papers so that only the most meaningful material is presented. That's a lot better position to be in than to have to beat the bushes for good papers, as often happens at other conferences."

The informal evening sessions are important, too, says John S. Mayo, vice president of electronics technology at Bell Telephone Laboratories in Murray Hill, N.J. "At these sessions, critical issues have been identified over the years," he says. "They have the right subjects and the right people. Their importance is measured by the fact that they're well attended and appreciated after a very long day." Overall, states Mayo, "the ISSCC is where first

disclosures of significant benchmarks or accomplishments have been made"—like integrated circuits, chip memories, and microprocessors.

The solid-state nature of the conference, however, did not fully come to the fore until 1958, when the meeting was renamed Transistor and Solid-State Circuits Conference. A year later, "transistor" was dropped, and in 1960 the present name was adopted to reflect the growing participation from abroad, "especially with heavy inputs from Europe and Japan," says Lewis Winner who handles ISSCC publications. About 25% to 30% of the papers are international by now. Attendance meanwhile grew from about 900 in 1954 to a peak of nearly 3,500 in 1959/60, when the Esaki tunnel diode was a "hot topic," and has since settled down to average about 2,000.

ISSCC's Digest of Technical Papers, which Winner developed in 1958, is believed to be the only edited book for a conference of this type. It even includes late-news papers. "Everybody who plays a significant role in this industry considers it a Bible," says Gerald B. Herzog, staff vice president for the technology centers at the RCA Laboratories in Princeton, N.J. The digest has for the past 19 years been put together by Winner and his wife Beatrice, who passed away last Election Day. In her honor, a new award has been established—an IEEE/ISSCC Bronze Plaque for the conference paper displaying editorial excellence.

Bruce LeBoss

are actually NOR-NOR logic structures consisting of complementary n-channel arrays with p-channel current sources, and they dissipate only 30 mw of total chip power in an area of only 0.93 mil².

Another special-purpose microprocessor, an 8-bit device from Bell Laboratories, Murray Hill, N.J., employs bulk C-MOS technology for low-power operation—typically 100 mw at 2 megahertz. Although normally operated from 12- and 5-v supplies, the chip can also run off one 5-v supply at lower speeds.

Because Bell System requirements called for maximum throughput and computational capability, the device designers took the working registers off the chip and put them in external RAM, much as in TI's 9900 16-bit CPU. Then they used the extra chip space to add a powerful compiler for handling the large instruction repertoire needed in telecommunications applications. This arrangement enables the 8-bit microprocessor to deal with a wide variety of 16-bit instructions: 17 of the 21 addressing modes are for 16-bit word formats.

Memory designers quicken pace

While the microprocessor presentations at ISSCC are confined to a few key developments, the memory sessions cover an abundance of new devices. Closest to production appear to be a new 16,384-bit dynamic random-access memory, two n-MOS 4,096-bit static designs, a 4-k C-MOS static device, and a number of nonvolatile memory chips.

The 16-k dynamic RAM is Mostek Corp.'s MK 4116 P-2 device, which has so impressed memory system designers with its high-speed, low-power performance: 150-ns

access time at 420 mw. As in other companies' 16-k designs, Mostek engineers use two levels of polysilicon to shrink the cell area to a mere 0.7 mil², about as small as a one-transistor cell can get with today's 4-to-6-micrometer photolithographed rules. A chip containing 16,384 of these cells measures only 27,700 mil², or slightly larger than some 4,096-cell designs—and chip size is an important criterion to sophisticated memory users, who know that die size is clearly related to die yields and therefore memory costs. (For a complete description of the Carrollton, Texas, company's 4116 family, see *Electronics*, Jan. 20, p. 86.)

Semi Inc.'s new 4-k static devices, of which there are five, are well worth the attention of designers of memory systems because they offer a wide choice of performance tradeoffs (see table). Semi, of Phoenix, Ariz., has three clocked 4-k statics, configured as 4,096-by-1-bit and 1,024-by-4-bit devices, and two nonclocked designs, also a 4,096-by-1-bit and a 1,024-by-4-bit device.

For high-speed designs, of course, the clocked devices are best. Their access times go as low as 50 ns. But as they require two or three power supplies and dissipate 500 to 600 mw, the designer pays for performance in less ease of use and higher power dissipation. On the other hand, the clocked parts have a very low standby power of 20 to 30 mw, which makes them useful in battery-backup memory systems.

For small peripheral designs or some mainframe and microprocessor applications, the user will turn to the nonclocked, slower, but easier-to-use 5-v parts, which are entirely TTL-compatible. The price here is nonvolatility, since clock devices dissipate more standby power

STATIC 4,096-BIT RANDOM-ACCESS MEMORIES

Parameters	Device	Clocked			Nonclocked	
		4200	4402	4104	4804	4801
Organization		4,096 x 1	4,096 x 1	1,024 x 4	1,024 x 4	4,096 x 1
Access time (ns)		80	50	150	300	300
Chip-select width (ns)		150 to ∞	125 to ∞	150 to ∞	300 to ∞	300 to ∞
Cycle time (ns)		250	225	270	300	300
Operating power (mW)		500	600	450	250	250
Standby power (mW)		33	22	35	250	250
Battery-backup power (mW)		12	12	14	75	75
Supply voltage (V)		12, ± 5	12, - 5	12, ± 5	5	5
Input interface		TTL	TTL	TTL	TTL	TTL
Output interface		TTL	sense amp	TTL	TTL	TTL
Chip-select interface		MOS	driver	MOS	TTL	TTL
Chip size (mil ²)		32,000	32,000	42,000	26,500	26,500
Package pinout		22	22	22	18	18

SOURCE: SEMI INC.

than nonclocked ones and therefore are not suitable for battery-backup applications.

The basic difference in design between a clocked and a nonclocked part is the manner in which it selects a chip. The nonclocked static uses asynchronous circuitry throughout. The clocked RAM uses the chip-select signal both to select the chip and to generate the internal waveforms to enhance performance, much in the way that dynamic RAMs operate.

What this means to the memory user is that the operating cycle of a clocked device is characterized by an access period during which the chip is selected and all the internal circuitry is momentarily powered up in order to handle the functions of input latching, address decoding, and so on.

The next part of the cycle is the recovery period, when the chip is deselected and all inputs and outputs except chip select become inactive. This leaves clocked devices with only part of their cycle available for memory operations, making the timing a bit more critical. This same automatic recovery period, on the other hand, also makes the clocked devices useful for battery-backup systems. During it, all internal nodes recover to either V_{DD} or V_{SS} as the chip powers itself down to a lower standby mode, and V_{DD} can be reduced to 4 v for battery-backup operations.

Cause of the improved performance of the new static memories—and of their dramatically reduced size—is a polysilicon resistive-load cell (Fig. 2). Mostek as well as Semi use such a design. The resistors, which have a negative temperature coefficient, compensate for junction leakage current and dissipate only 10 mw of standby power. Containing just four transistors besides the two load resistors, the new cell occupies a much smaller area than the old static cell, since the resistors are implanted on top of the cell's diffused sense line and take up no additional space.

Mostek's designers see resistive loading becoming as important to static designs as depletion loading is to dynamic RAM designs. Using it in their new 4,096-by-1-bit MK4104 device resulted in some truly impressive specifications. The cells are about half the size of other

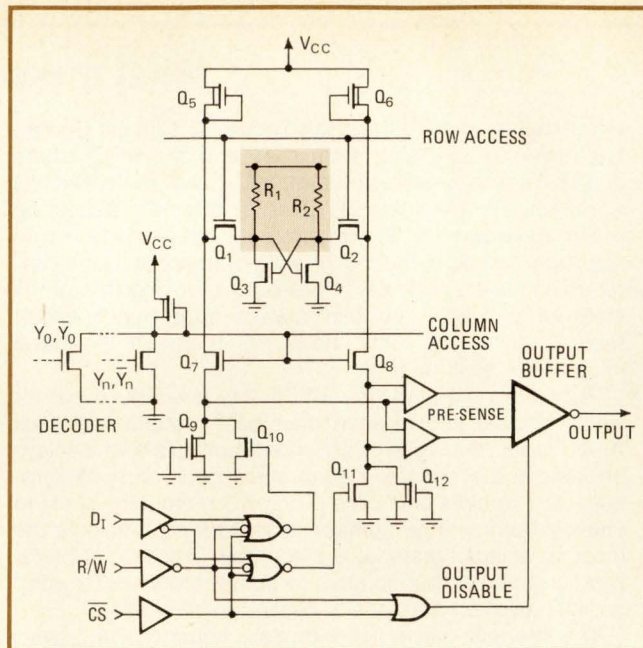

2. Resistor loads. Some 5-volt 4-k static RAM designers are using resistors for loads to squeeze cell size, reduce power dissipation, and increase speed. In this nonclocked 4-k static from Semi Inc., loads R_1 and R_2 are made of high-resistivity 60-megohm material.

n-MOS static cells, while the 25,000-mil² chip is about 30% smaller. The speed-power specifications of this single 5-v part are among the best in the industry: 150 ns at 80 mw active and 8 mw standby. An 0.8-mw standby mode is available for battery-backup operation.

Equally important for future static designs is the fact that each load resistor conducts less than 1 nanoampere of current, so that all 4,096 memory cells of the 4104 dissipate a mere 20 mw of power, while the balance is dissipated in the RAM's peripheral circuitry. This gives one license to envisage a much larger memory array, maybe four times the size, that would consume very little extra power, be served by the same peripheral circuitry, yet still keep the overall chip size and power within manageable tolerances.

Alterable memories

One of the fastest-moving memory technologies, for prototyping as well as ROM replacement, is that of the field-alterable ROM. Two kinds exist: the one erasable by ultraviolet light and built with a floating-gate process, and the other alterable electrically and built with a modification of the same process. The UV-erasable types came first, and several papers at the conference deal with improved next-generation versions of these programmable ROMs.

For example, engineers from Intel Corp., the original developer of the p-channel MOS floating-gate or Famos process, are showing an improved n-channel process that they use in the company's newer 4-k and 8,192-bit devices. When suitably modified to produce devices with single 5-v operation, the process will also be used to build a 16,384-bit 2716 PROM.

Basically, the Intel design team added a single-transistor two-layer process to an n-channel stacked-gate

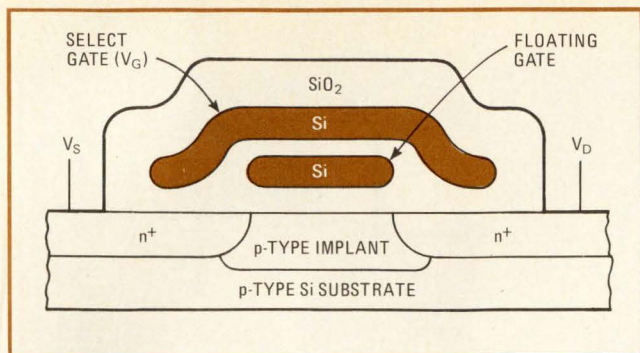

3. Stacked. By applying an n-channel two-layer process to its floating-gate avalanche MOS structures, Intel Corp. built 450-ns access time and high reliability into its 2708 UV-erasable PROM. The top gate selects, the bottom floating gate stores.

UV-erasable PROM structure. The two-layer process is like the one used in the Intel 16-k dynamic RAMs and in both cases yields a 1-mil² cell. This proves that the process can easily be taken up to the 16-kilobit level.

Even as it is, it results in very respectable device parameters. In the 2708 8-k chip it holds overall size to only 134 by 189 mils, yet the device is fully decoded, with TTL-level address and data lines. Maximum access time of the 2708 is 450 ns, as fast as pin-compatible 8-k and 16-k mask-programmable ROMs.

The double-level stacked-gate cell is shown in Fig. 3. The floating gate (bottom) stores the charge indefinitely, and a polysilicon select gate (top) controls programming and read/write operations. The attraction of the structure is that it encourages high yields, as do all silicon-gate processes. Both gate oxides are a quite ordinary 1,000 angstroms thick, and channel doping can be adjusted with a single implant step. The overlap of the silicon gate also reduces the process's sensitivity to manufacturing variations, making it easy to reproduce cell characteristics like programming margin and sense current over a wide range of manufacturing tolerances.

Essential to the high performance of the 2708 is the on-chip programming circuit, which delivers high programming voltages to the array while maintaining high performance during the read mode. The technique limits the high-voltage input requirements to a single pin. All the other pins, including supply voltage, remain at their normal read voltages. The programming voltage is then driven through the decoder to the array by bootstrapped circuits within each address buffer. These address buffers are isolated by means of transfer devices, while a double-polysilicon high-voltage driver transistor prevents gate-controlled breakdown at critical high-voltage nodes.

Converters, subsystem chips spearhead linear progress

For analog designers, this year's ISSCC is a bonanza of dramatic advances. There are lots of new large-scale linears, including dedicated-task devices aimed at

consumer, telecommunications, and biomedical applications, as well as the more familiar data converters, but ones that reach dizzying heights of resolution and accuracy. Also in the limelight is the improved performance of microwave amplifiers, transistors, and diodes.

Strong showing for special-purpose linears

Reflecting the changing nature of linear ICs, the papers at ISSCC describe several multifunction special-purpose circuits that pack an entire system or subsystem on a chip of silicon. Among this new breed of linears to be unveiled for the first time are: a self-contained control chip for cameras, a tone-generating dialer for telephones, a large array of mixed devices that can be interconnected on a custom basis, and implantable micropower devices for biomedical telemetry systems.

The camera-control linear comes from National Semiconductor Corp., Santa Clara, Calif. It is a bipolar chip (Fig. 4) for the instant-picture type of cameras. Since it has its own light-sensing element—a silicon photodiode—it is completely self-contained and does not require any outboarded components. In addition to low-light warning and a battery check, the device provides linear control of shutter speed and a two-position selection of lens aperture.

Current serves as the analog of scene brightness, so National calibrates each die during wafer sort, using a reference light source and a computer-controlled metal-link-blowing technique for trimming to final values. Special processing produces a blue-enhanced photodiode and transistors having high gains at low current levels. The shallow photodiode junction created by ion implantation boosts this device's normalized conversion efficiency to 60% in the visible-light region. The typical current gains of 100 for npn transistors and 50 for pnp transistors, at collector currents of just 10 nanoamperes, are achieved by low-temperature processing and annealing. In addition, there is even a second layer of aluminum on the die to shield its low-level control circuitry from incident light.

The dual in-line package is special, too. It is an eight-pin DIP, molded in a clear compound. To reduce infrared response, National inserts a light filter in a small preformed recess in the package.

Just as impressive is the telephone-dialer circuit from Mostek Corp., Carrollton, Texas. Besides replacing numerous precision discrete components, this large-scale linear IC eliminates the need for factory and maintenance adjustments, say Mostek's Michael Callahan and Charles Johnson in their ISSCC paper. What's more, the few external components the device requires can be of the inexpensive variety—a low-cost 3.58-megahertz crystal as a frequency reference (the type used for color television) and an economical calculator-type keyboard.

The circuit (Fig. 5) is quite a mixture of elements, containing both MOS and bipolar transistors, high-speed digital circuitry, ion-implanted resistor ladder networks, and an operational amplifier. In fact, the chip, which measures 108 by 132 mils, has two complete on-board digital-to-analog converters formed by the ladder networks and complementary-MOS analog switches.

For all its complexity, though, its operation is straight-

Starring at ISSCC

Pictured here are five of the new devices that light up this year's ISSCC. The chip in the upper left-hand corner is Nippon's 4½-digit a-d converter for instrumentation applications. Built with standard bipolar technology, it holds linearity error to 0.002%. On the upper far right is a linear control chip from National that is going into Kodak cameras. This monolithic workhorse controls both shutter speed and lens aperture and also warns of low light levels and weak batteries. In the middle is the cell used by Mostek in its 4-k static random-access memories, which each operate from a single 5-V supply. To save space and increase speed, the cell is built with resistive loads. On the lower left is an 8-k erasable read-only memory from Siemens, which employs a stacked-gate n-channel approach to ensure reliable 5-V operation. Finally, on the lower right is Hewlett-Packard's one-chip central processing unit. Being built with a C-MOS-on-sapphire process, it achieves minicomputer performance yet keeps power dissipation low.

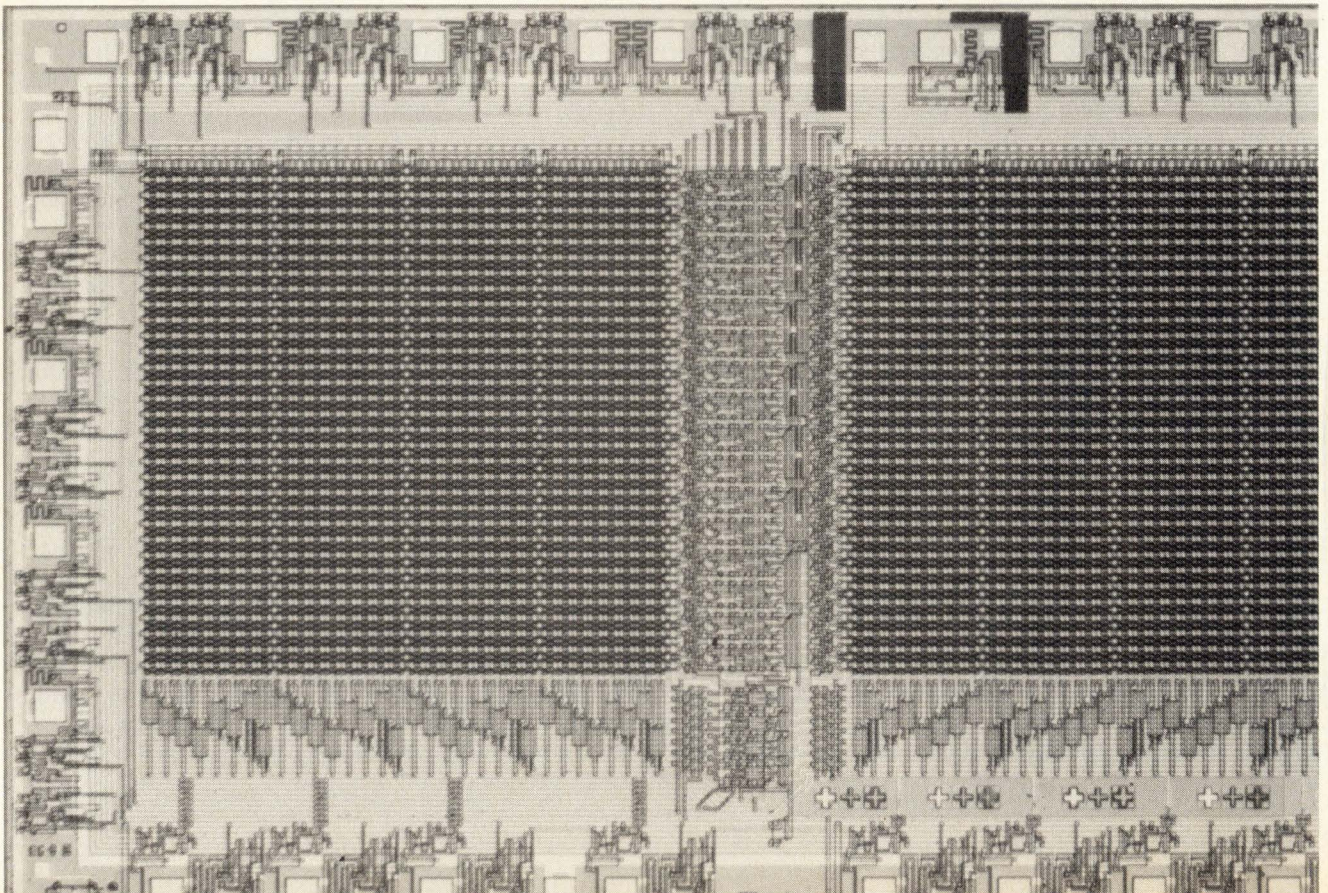
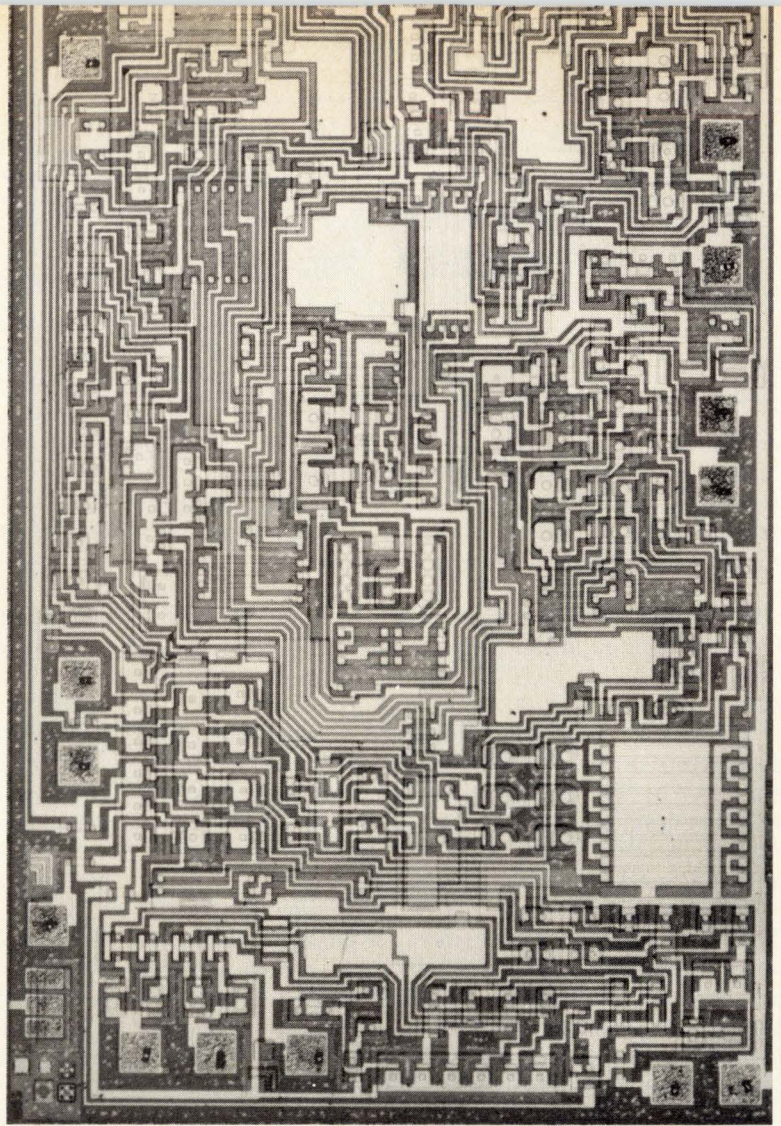

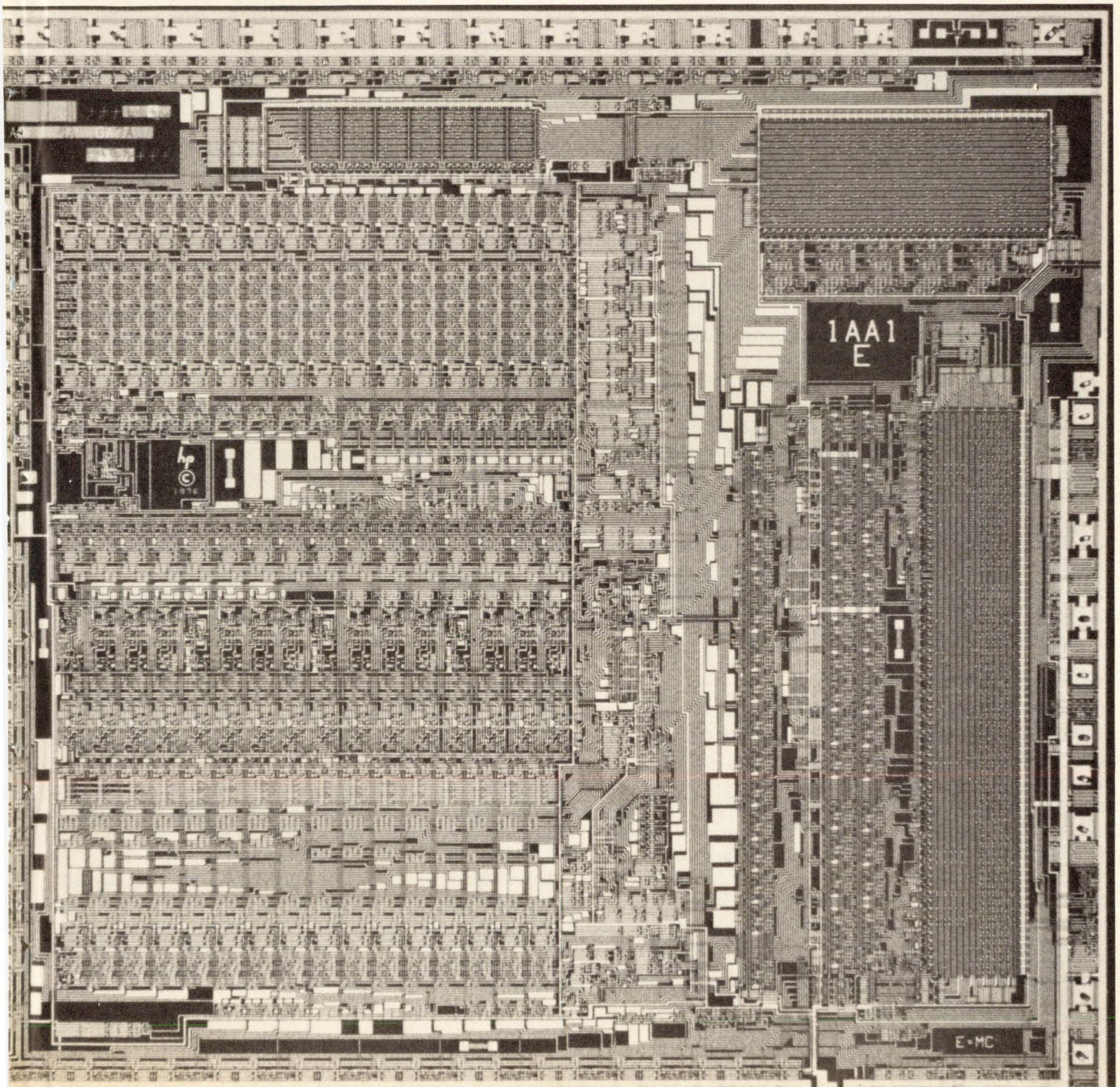
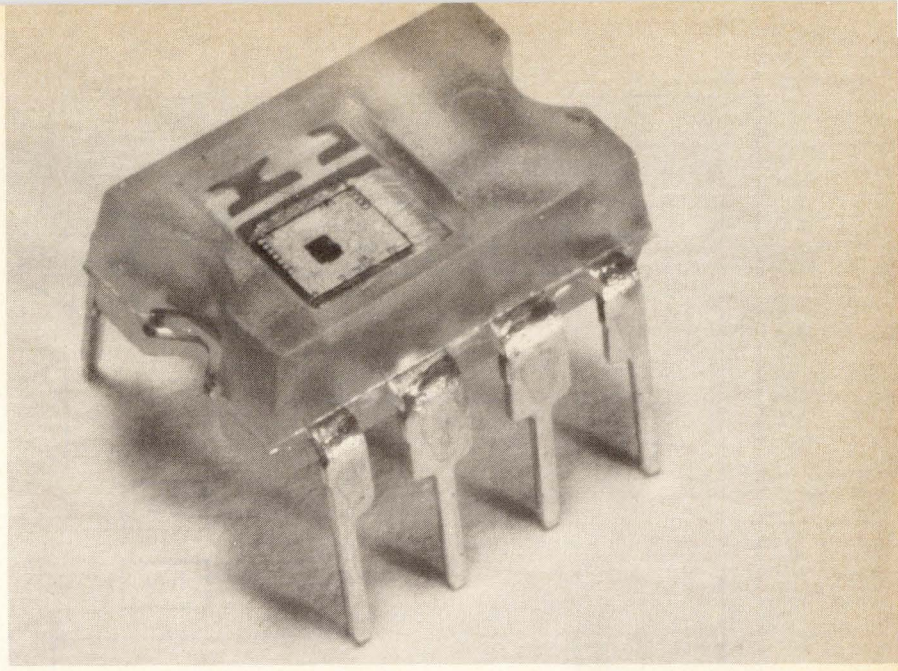
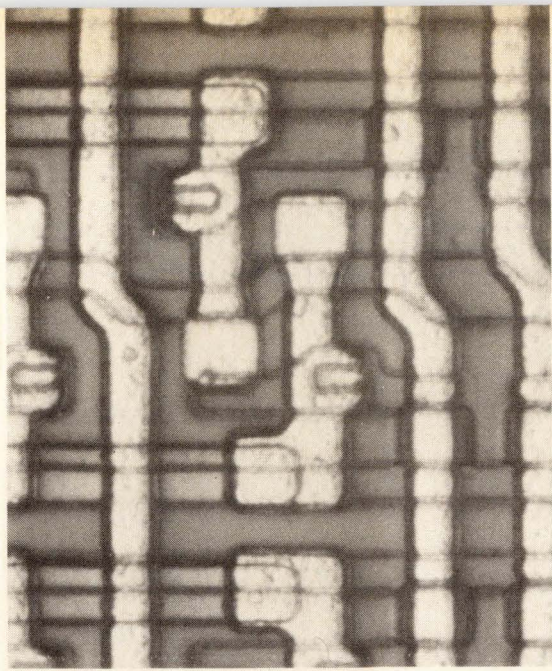

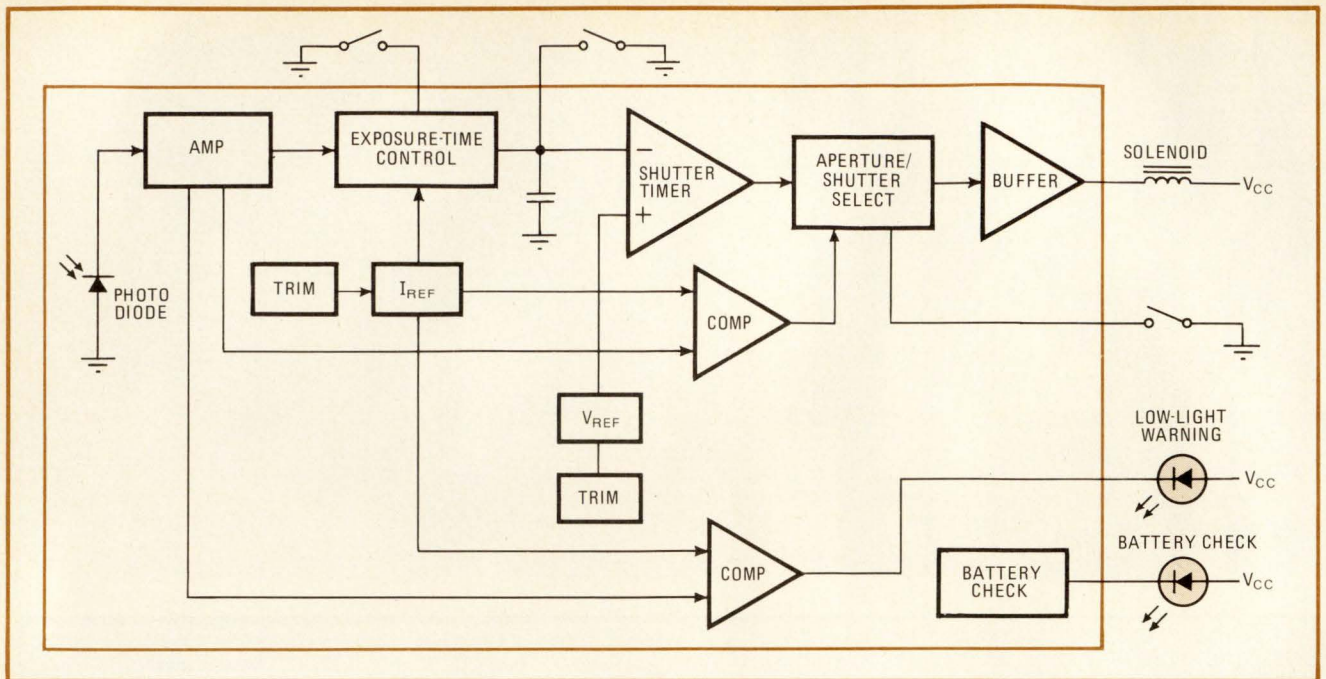

4. For cameras. Completely self-contained, this camera-control linear from National even includes its own photodiode. Besides warning of insufficient scene brightness and weak batteries, the device provides linear control of shutter speed and two-position aperture selection.

forward. The dialing signal for a tone telephone is a composite of two sine waves, one from a low-frequency group and the other from a high-frequency group. When the chip receives a valid keyboard signal, the internal keyboard logic selects the appropriate frequency from each group, dividing it down from the 3.58-MHz reference frequency. Each sine wave is then digitally synthesized by a programmable logic array, which drives a d-a converter. Now back in analog form, the two sine waves are summed together by the op amp.

The monolithic dialer operates directly from the telephone line, drawing very little current because of its C-MOS circuitry. The bipolar transistor at its output serves as a low-impedance driver. It is a vertical npn structure having a very lightly doped base region, for which Mostek uses an ion-implanted deposition.

A pair of papers from the Integrated Circuits Laboratory of California's Stanford University also point to the growing complexity of linear ICs. Researchers there have developed two outstanding chips. One is a mixed-process uncommitted device, and the other is an implantable command receiver for biomedical telemetry.

A programmable-function linear

Dubbed a Kitchip, the first IC is an array of unconnected transistors, resistors, and MOS capacitors, which a single custom aluminum interconnection pattern will transform into any simple digital or linear circuit configuration. The transistor arrangements include such key analog circuit blocks as balanced multiplexers, active-load differential pairs, and n-well current mirrors.

Potential applications abound, say Stanford's Stephen Combs and James Meindl, because the Kitchip is an economical way of realizing special-function devices in high volumes. Within the last year the device has already been the basis of several important circuits for biome-

dical applications, including an implantable complete four-channel continuous-wave ultrasonic blood-velocity meter, an implantable telemetry system for monitoring body pressure, biopotential, and temperature, and even an implantable micropower command receiver.

Compared to a standard linear process, the Kitchip's fabrication requires at least three extra steps: an ion implant, a polysilicon deposition, and an anisotropic etch. However, the chip process yields self-aligned low-current n- and p-type transistors (which may be either MOS or bipolar devices), low-on-resistance V-MOS switches for signal multiplexing, ion-implanted low- and high-value resistors, and low-voltage junction-type field-effect transistors. The fully complementary transistors are bimodal devices. In other words, their mode of operation, whether MOS or bipolar, is determined by the custom metal interconnection pattern, so that both complementary bipolar and micropower complementary-MOS circuitry can be realized simultaneously.

Each Kitchip die contains over 100 bimodal transistors, 10 substrate pnp transistors, eight JFETs, and four high-current transistors. The n-type bimodal transistors, which are constructed with dual emitters and V-groove gates, can operate as either a bipolar npn or an aluminum-gate V-MOS transistor. With the same set of diffusions, modifying the surface geometry and eliminating the V groove yields a p-channel JFET. The p-type bimodal transistors can operate as either a lateral pnp or a polysilicon-gate p-MOS transistor. High-gain high-current substrate pnp bipolars may be fabricated concurrently with the p-type bimodal devices.

The other paper from Stanford University deals with the implantable command receiver built with a Kitchip for biomedical telemetry. Since the command receiver in such a system must operate continuously, it needs to draw as little current as possible from the battery. But its

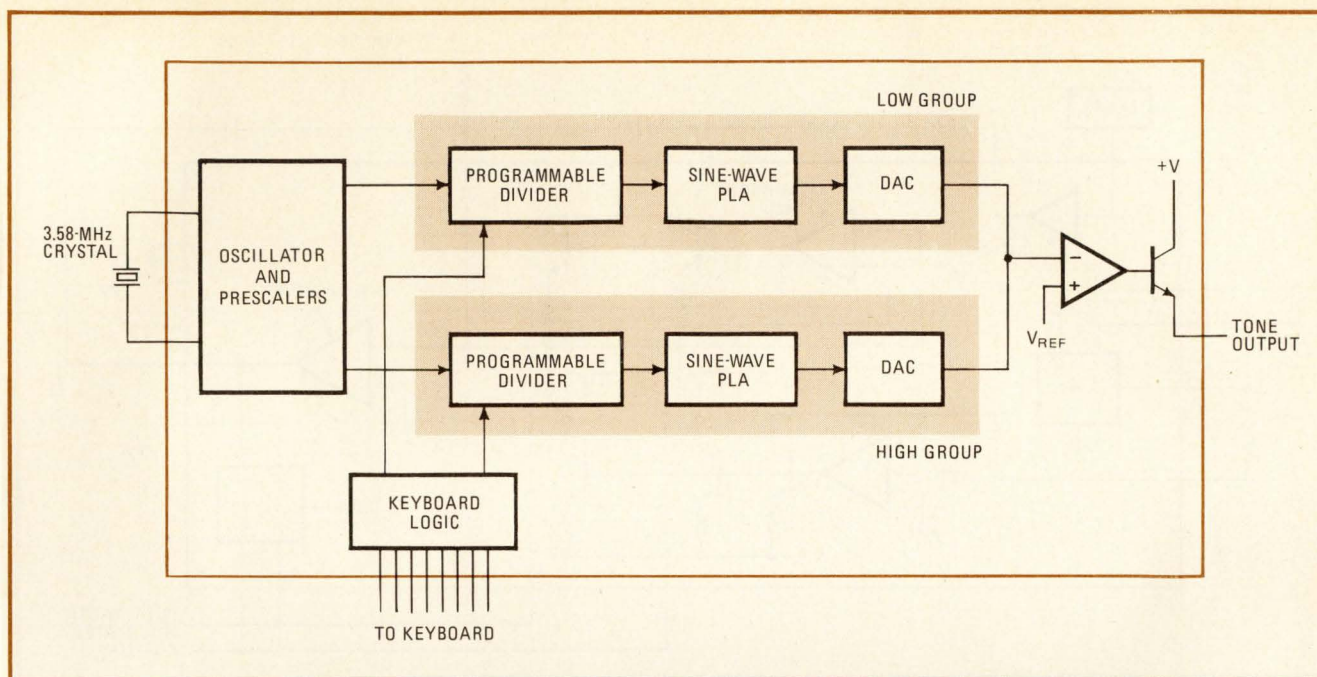

5. For telephones. Made by Mostek, dialer circuit for tone telephones is a large-scale mixed-process linear containing both C-MOS and bipolar devices. It can operate with inexpensive outboarded components—a 3.58-MHz color-TV crystal and a calculator-type keyboard.

need for a low current drain limits the receiver's carrier frequency and therefore its range in terms of distance.

With a Kitchip die, however, Stanford University's Robert Pettingill and James Meindl have built a minimum-duty-cycle pulse-powered command receiver that provides 10 times greater range than previous devices, while managing to hold current drain to only 20 microamperes. This monolithic receiver not only operates over a range of 30 meters, but also is less susceptible to false triggering from random noise.

Yet another paper at ISSCC centers on a linear IC for biomedical telemetry. This chip is a micropower pulse-frequency modulator, jointly developed by the Engineering Design Center of Case Western Reserve University in Cleveland, Ohio, and Turkey's Middle East Technical University. This circuit is designed for implantable temperature or biopotential telemetry systems where micropower operation is essential. Its most singular feature is that, unlike earlier chips, its operating frequency does not change with variations in the supply voltage. The modulator produces narrow pulses at low duty cycles ranging from 0.001 to 0.01. When operating from a 1.35-volt cell, it consumes as little current as 5 μ A.

Monolithic data converters advancing

Large-scale linears are not only special-purpose devices, like those just discussed, but multi-purpose chips like monolithic data converters, which are becoming increasingly essential components in the broad-based areas of instrumentation, industrial process control, and just about any other form of analog signal processing.

In the past year alone, monolithic 10-bit d-a converters have broken through the accuracy barrier, so that several of them now hold linearity error down to 0.05%. This year, however, should bring even more

startling developments—the emergence of 12-bit devices and high-resolution microprocessor-oriented chips. In fact, the first monolithic 12-bit d-a converter is being discussed this week at ISSCC. It comes from Precision Monolithics Inc., Santa Clara, Calif., which will be announcing the product shortly.

Meanwhile, work is by no means standing still for a-d converters. In particular, there has been a flurry of activity in the high-accuracy low-speed types of a-d chips, of the sort that is frequently used in instrument applications. Some of the newer 3½-digit dual-slope monolithic converters even include decoder circuitry for the display, and the integrating C-MOS converter chip introduced last year by Analog Devices Inc., Norwood, Mass., is a 13-bit quad-slope device that incorporates automatic zero correction.

But semiconductor manufacturers outside the U.S. are finding success with other a-d conversion techniques. At ISSCC, researchers from Japan's Nippon Electric Co. are discussing their use of standard bipolar linear processing to fabricate a 4½-digit a-d converter that produces a pulse-width-modulated output. Besides its astoundingly high resolution, the chip offers a linearity error of less than 0.002%. Its full-scale and zero-scale temperature drift is merely ± 10 ppm/ $^{\circ}$ C, and its power dissipation is a fairly low 120 milliwatts.

The device requires only a few external components—a clock having a 50% duty cycle, a couple of capacitors, and a pair of resistors to set the value of the internal voltage reference. As Fig. 6 shows, the chip is an integrating converter having a four-phase operating cycle, in which the capacitor across the integrator is charged twice and discharged twice. Each time this capacitor is charged and then discharged, a comparator, which is driven by the integrator, changes state, producing an output that is a pulse-width-modulated

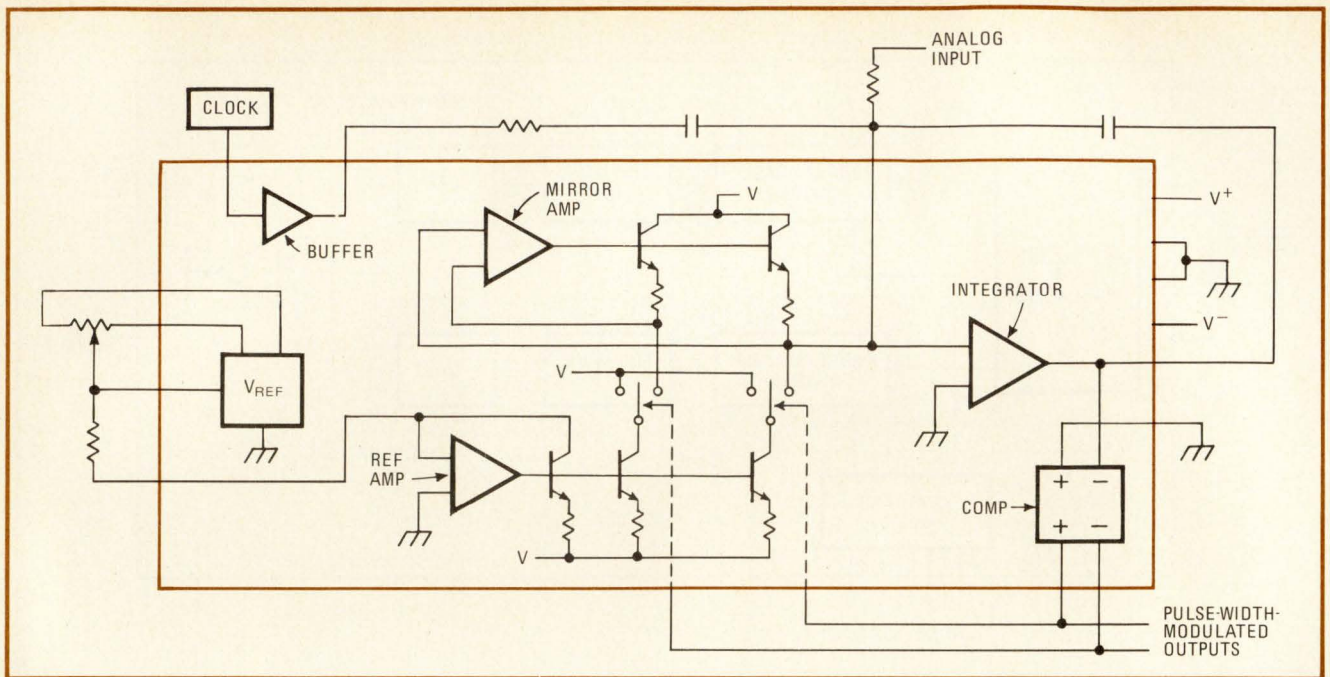

6. High resolution. With standard bipolar processing, Nippon Electric has managed to put a $4\frac{1}{2}$ -digit integrating a-d converter on one chip. The device delivers a pulse-width-modulated output and holds linearity error to less than 0.002%, temperature drift to 10 ppm/°C.

version of the analog input signal. The difference between the pulse widths at the comparator's output determines both the polarity and magnitude of the analog input.

Still another a-d conversion technique is being tried by N.V. Philips Research Laboratories in the Netherlands. Employing a delta-sigma modulation scheme, the group has developed a pair of bipolar chips that constitute an auto-zero five-digit a-d converter, which even permits a selection of input range. The two chips are pretty much self-contained, requiring only an external up/down counter and a timing circuit. Linearity error is held to $\pm 0.001\%$ of full scale, and zero stability is better than 1 ppm/°C. Incredibly, power consumption is a mere 27 milliwatts.

One chip contains a reference current source and a voltage-to-current converter with level-conditioning logic for range setting. On the other chip are current switches, a comparator, a flip-flop, a clock generator, a control operational amplifier, a bias-current stabilizer, and additional level-conditioning circuitry for the data and clock output lines.

In simplified terms, the a-d circuit works like this. The voltage-to-current converter, which can be regarded as a differential pair, transforms the analog input voltage into a current, which charges an integration capacitor. The reference current source, together with the differential pair under control of the flip-flop, generates equal charge and discharge currents. In turn, the comparator controls the flip-flop, so that the discharge current keeps the net capacitor charge at zero. The flip-flop produces a pulse train that is synchronous with the clock frequency and that is the converted analog input.

Technological advances in linears are even reaching up into the microwave region. At ISSCC, Charles E. Shinn II of the Santa Clara division of Hewlett-Packard

Co., Santa Clara, Calif., will describe his wideband monolithic amplifier/Schmitt trigger that can operate from dc to beyond 1 gigahertz. He used a junction-isolated bipolar process for a chip that provides electronic gain control, 180° phase switching, an emitter-coupled-logic line-driver output, and a one-shot light-emitting-diode driver. The amplifier, which has an input sensitivity of 8 millivolts root-mean-square, is loaded by the on-chip Schmitt trigger.

Stretching performance at microwaves

Improved performance is also the keynote for developments in microwave semiconductors at ISSCC. Roger Wong and James Chen, at HP's Microwave Semiconductor division, have successfully linearized the performance of a bipolar power transistor for operation in the 2-to-5-GHz region, so that it is especially suited for linear power applications in communications systems, microwave radar, and electronic-countermeasures systems. It is fabricated with a new process that encompasses self-aligning techniques, ion implantation, and local oxidation. As a result, when internally matched, it delivers a typical linear output power of 850 mw with 11 decibels of gain at 2 GHz and 250 mw with 5-dB gain at 5 GHz.

Finally, a joint effort by researchers from two RCA divisions—P.T. Ho and G.A. Swartz of the Microwave Technology Center of the David Sarnoff Research Center at RCA Laboratories in Princeton, N.J., and A. Schwarzmann of RCA Government and Commercial Systems, Advanced Microwave Techniques, Missile and Surface Radar division, Moorestown, N.J.—has resulted in a low-loss p-i-n diode with a breakdown voltage of greater than 1,500 v. A deep-diffused structure, the device is the heart of a three-bit F-band microwave-integrated-circuit phase shifter capable of handling peak powers of 5 kilowatts. □

Which data-terminal display: plasma panel or CRT?

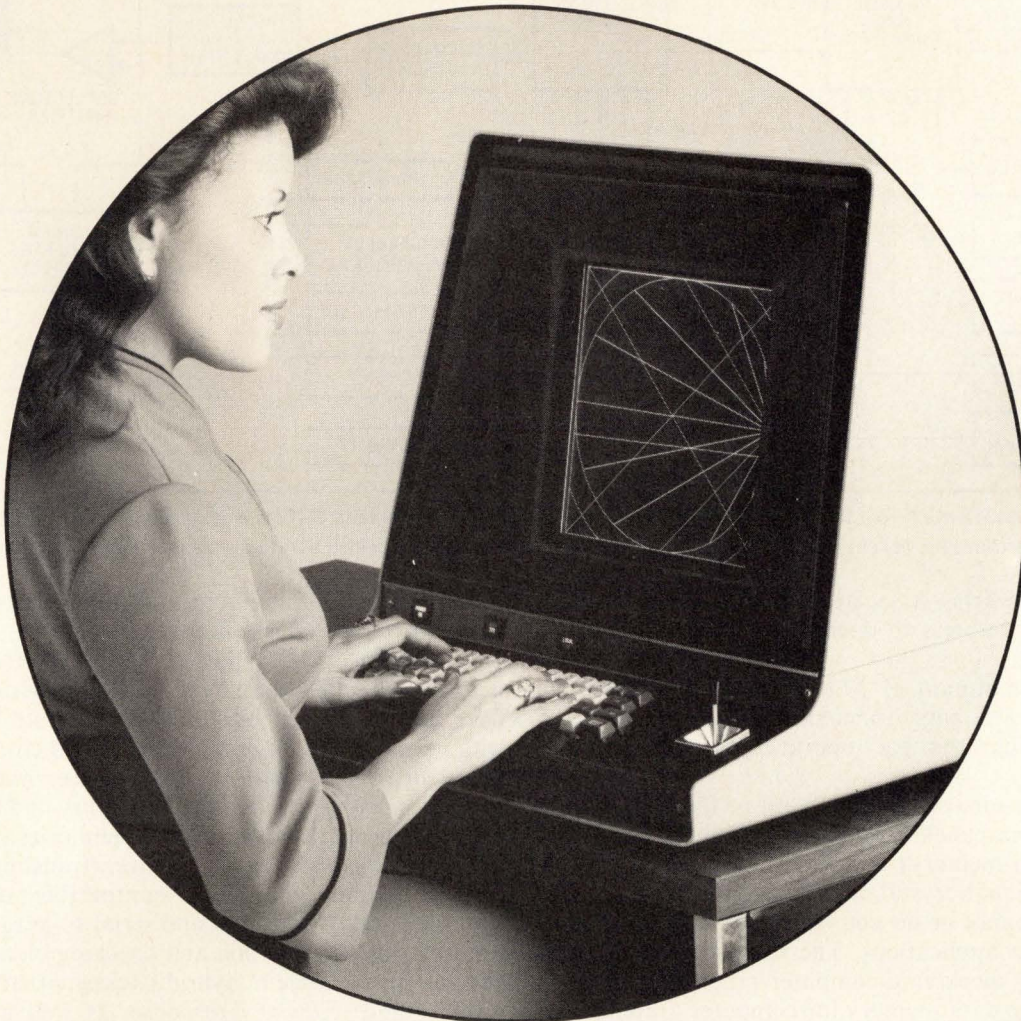

by Lester Turner, *Interstate Electronics Corp., Anaheim, Calif.*

□ Despite certain shortcomings, the cathode-ray tube has delivered the best performance for the money of any kind of computer-terminal display available for the past two decades. But ever since the first commercial gas-discharge display was introduced in 1971, it has been the leading candidate to succeed the CRT.

Although the plasma terminal's potential is bright, terminal buyers have not rushed to adopt it, largely because the circuitry needed to drive the display has been too complex and expensive. However, now that the discrete electrode drivers of earlier panels are being replaced by the microprocessor and other integrated circuits, prices of the two terminal types have become fairly comparable.

Plasma-terminal costs are certain to decrease dramatically as production rates are increased and component yields are improved. In contrast, technology of the

heavy, bulky, more fragile CRT has matured, and costs are not expected to decrease significantly from now on. The terminal designer and buyer may well benefit from an analysis of the tradeoffs between the two types of displays for different tasks.

To meet all computer-display requirements for most applications, the terminal must:

- Generate and display all alphanumeric characters and a complete set of vector graphics.
- Decode and implement the complete American Standard Code for Information Interface character and control set.
- Contain an input/output interface compatible with

Compact. A combination of plasma technology, large-scale-integrated-circuit drivers, and high-speed microprocessors is shrinking the size of data terminals like this model from Interstate Electronics.

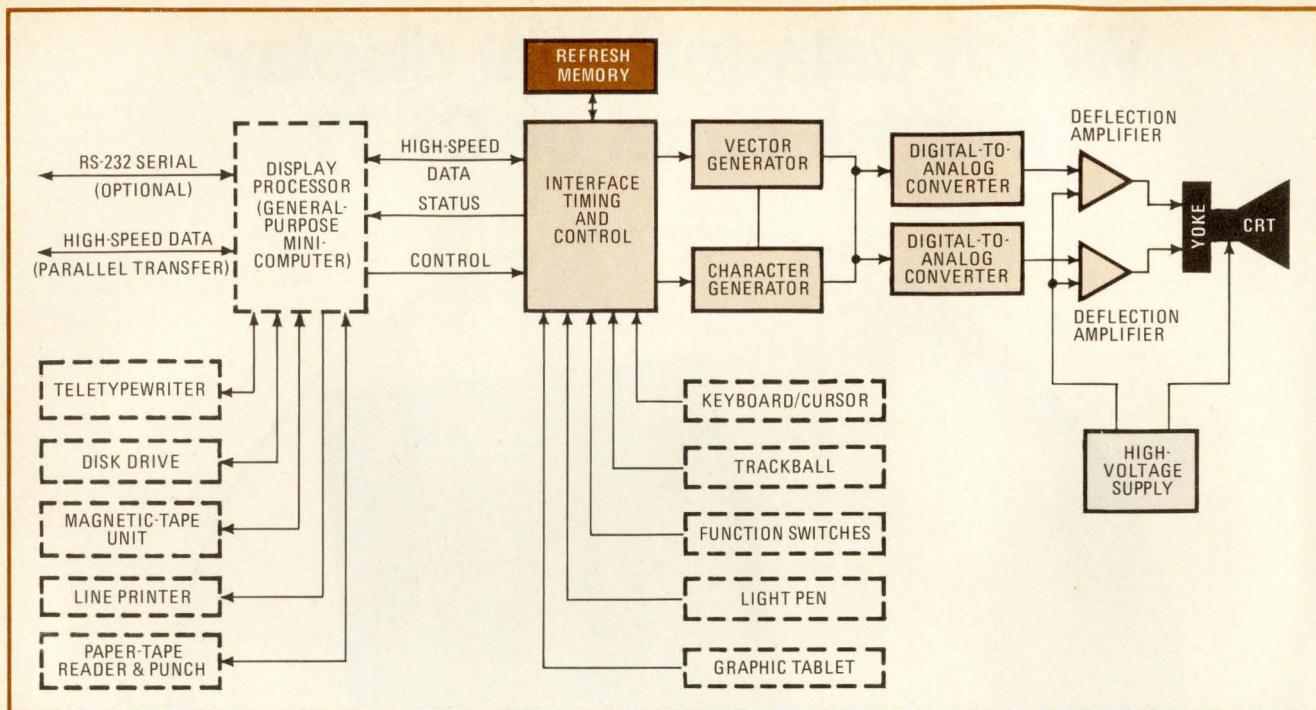

1. Random access. Derived from the conventional television display, the random-access CRT terminal display must be refreshed 30 to 60 times a second to eliminate flicker. This function is provided by the refresh memory, which also furnishes positioning information.

Electronic Industries Association Standard RS-232-C.

- Accept and respond to operate inputs for interactive operation.
- Display a minimum of 512 viewable characters for compatibility with page-oriented messages.
- Provide programs for operating and diagnostic purposes.

The only terminals that satisfy all of these conditions are the plasma-panel, CRT-storage, and CRT-random-access (refresh-memory) types. Others, such as electro-luminescent, liquid-crystal, and light-emitting-diode displays either cannot or do not yet satisfy all the requirements for most applications. The raster-scan CRT is not well suited for displaying computer graphics because it requires a large data memory for computer graphics and is difficult to adapt to this application.

Examining the random-access display.

A random-access terminal contains a CRT with a phosphor-coated screen that is activated by electronically positioned electron beams that are deflected and modulated to produce dots or segments on the screen. As in a television receiver, deflection amplifiers drive a yoke to position the beam in the X and Y axes (Fig. 1).

Status information is transmitted from the display processor through the RS-232-C-compatible circuits, and positioning information comes from the random-access refresh memory's manual inputs such as a light pen. A control-character decoder chooses between the character and vector generators to process the data.

The selected generator transmits the data to its digital-to-analog converter, which feeds the analog positioning signals to the deflection amplifiers for display. Because the persistence of the screen phosphor lasts a mere 10 to 100 microseconds, the refresh memory must

rewrite the data on the screen 30 to 60 times per second to minimize perceptible flicker.

Performance and reliability of the CRT, part of a mature technology developed by the television industry, have been improved by replacing discrete components with medium- and large-scale integrated circuits. Micro-processors, along with random-access and read-only memories, have increased the capability and flexibility of character generators and refresh memories.

Universal asynchronous receiver/transmitter (UART) devices include RS-232-C-compatible drivers and receivers, parallel-to-serial and serial-to-parallel converters, and parity-generation and checking circuits. Analog circuits are available in hybrid packages that have better stability and frequency response, as well as less drift, than earlier devices. As the production of television CRTs continues at a stable rate or may even decrease, chances are that CRT prices will increase to balance any price decrease that may result from component advances.

Storage-tube display

The direct-view bistable storage CRT was originally developed for oscilloscopes and then was adapted to display terminals to eliminate refresh requirements. By means of secondary-electron-emission techniques, dots and lines can be kept on the screen for hours without reactivation.

In the storage display (Fig. 2), a pair of registers replaces the refresh memory. The image is erased by flooding the phosphor screen with secondary electrons, a relatively slow process. With refresh methods, dynamic information can be presented on the bistable storage CRT in the same manner as on the random-access CRT.

Since the storage-CRT terminal has been commercially available for about 10 years, tradeoffs among display

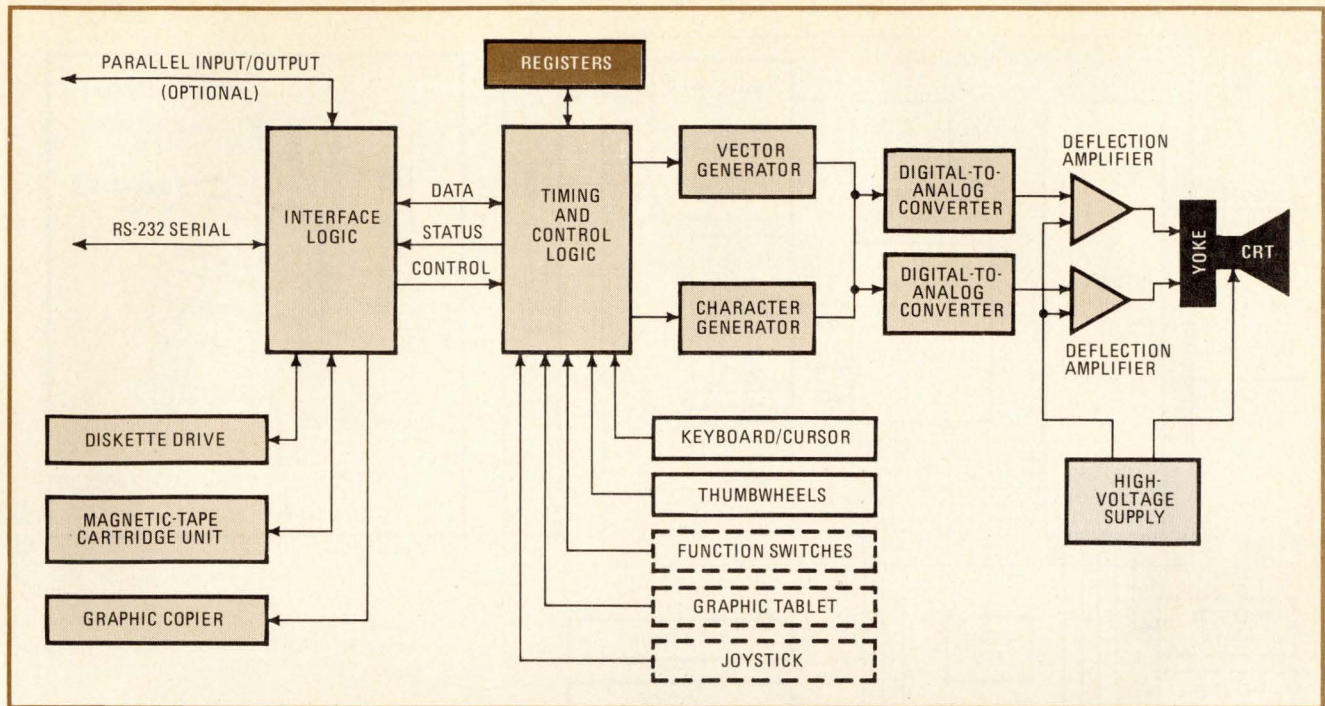

2. Storage display. In the direct-view storage CRT display, a pair of registers replaces refresh memory, while the phosphor screen is erased by flooding with secondary electrons, a relatively slow process. However, storage and random-access CRTs can handle graphics rapidly.

persistence, writing rates, and erase times have become well established. As with the random-access type, performance and reliability are being improved by replacing discrete components with LSI circuits.

Since the oscilloscope market has been considerably smaller than the television market and is not growing rapidly, storage-CRT terminals, which already take advantage of state-of-the-art electronics, will not significantly decrease in cost. Manufacturers will continue efforts to ruggedize this type of terminal for military and other severe environmental applications.

Plasma panels

Researchers at the University of Illinois began in 1964 to develop both ac and dc plasma display panels, and the first commercial ac versions were delivered in 1971. Although both types are now commercially available, the ac panel appears to be more suitable because the dc version has resolution limitations and lacks inherent memory, a major advantage of the ac type.

The ac panel (Fig. 3) consists of two glass sheets with deposited or etched electrodes. A dielectric glass layer coated with magnesium oxide, rather than the lead oxide of earlier panels, covers the electrodes. A precision glass seal keeps the glass layers parallel and retains a mixture of neon and a small amount of xenon or argon at pressures ranging from about 400 torr (0.5 atmosphere) to 760 torr (1 atmosphere), depending on the maker.

Available panels are built with a maximum matrix of 512 by 512 electrodes for a total of 262,144 addressable locations. This matrix requires 1,024 electrode drivers operating at about 100 volts. The continuous ac voltage needed to sustain the image is less than the igniting voltage. When an address-voltage pulse is applied between intersecting electrode points and summed with

the sustaining voltages, the gas between them is ionized, the plasma glows, and an equal and opposite charge is stored in the dielectric layers.

The glow is erased by applying an out-of-phase ac address voltage that momentarily reduces the sustaining-voltage levels and cancels the stored charge. A 50-kilohertz sustaining frequency provides a 20-microsecond dot-excitation (writing) rate.

In the latest plasma-panel terminals, a display processor with a microcontroller supplies X- and Y-axis position addresses to the display and control circuitry, which decodes them for the electrode drivers. The processor, which receives serial RS-232-C-compatible data through a UART from modems, computers, and peripherals, also accommodates parallel input devices such as keyboards, joysticks, touch panels, and function switches. The processor generates ASCII characters and graphic vectors. Crystal-controlled timing circuitry synchronizes data transfers.

Since the plasma is transparent, images can be projected from the rear so that updated data can be superimposed on them to dramatize the presentation. One version of the Interstate Electronics model PD-2000 terminal accommodates a microfiche projector that can select, under computer control, one of 256 images.

Characterizing the display

From the operator's viewpoint, the most significant characteristics of a display are its readability, information rates, and format flexibility. For a given display area, readability is primarily determined by element size, resolution, brightness, viewing angle, and contrast ratio.

Information-display rates are limited by writing and erasing rates, flicker tolerance, and the light spectrum. Addressing capabilities for alphanumeric characters and

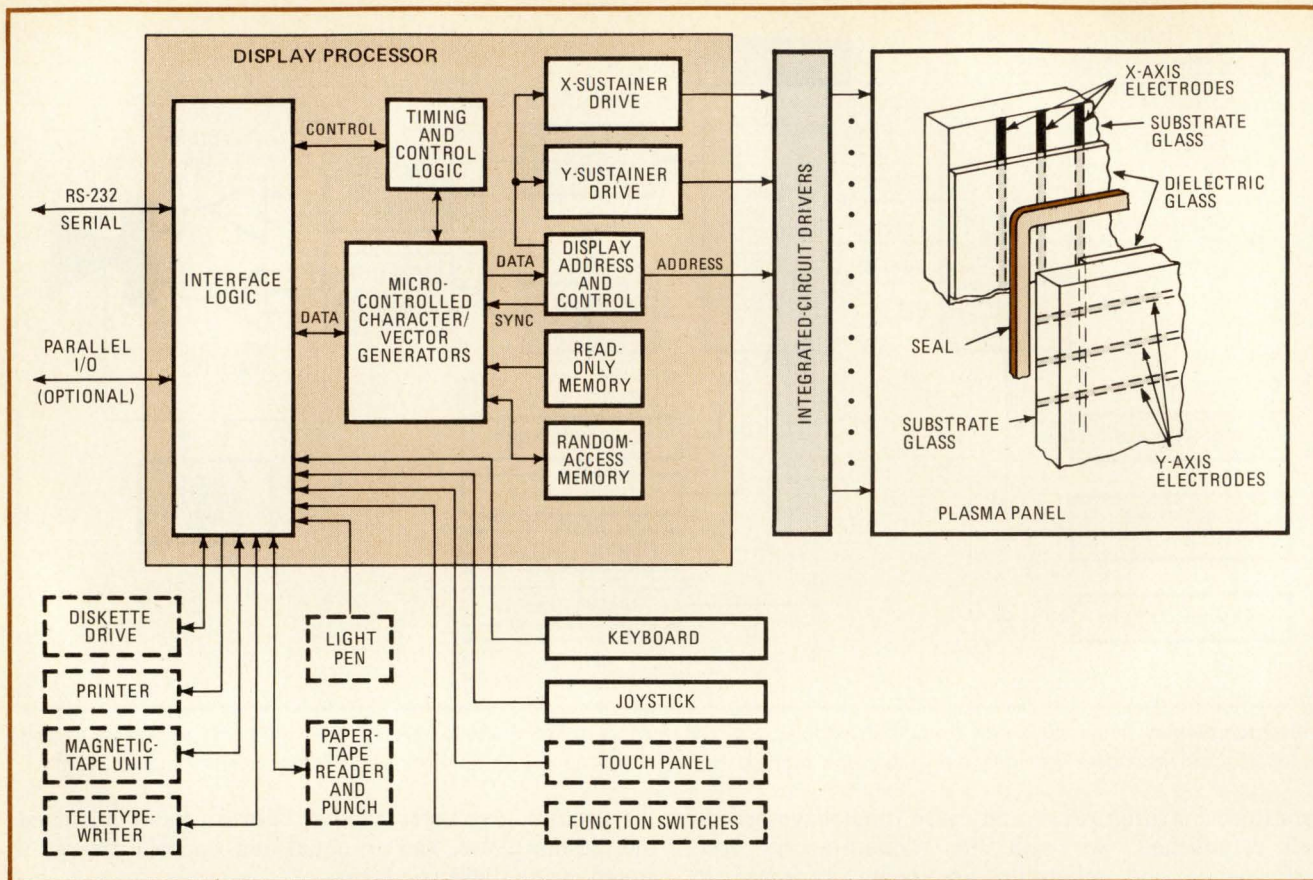

3. Second-generation plasma display. Available gas-discharge panels have a matrix of 512 by 512 electrodes that display characters and vectors positioned and activated by 1,024 electrode drivers operating at about 100 V. The plasma continues to glow so long as the image is sustained by a continuous ac voltage lower than the igniting voltage.

vectors determine format flexibility. The table compares display characteristics extracted from manufacturers' specifications, brochures, and manuals for a typical state-of-the-art terminal of each type (see "Evaluating displays").

The plasma terminal provides significantly better brightness, contrast ratio, and addressability, as well as a wider viewing angle and less distortion than either CRT display. In addition, the display's flexibility in writing, erasing, and addressing is highly desirable for interactive graphics. On the other hand, the CRT displays can write graphics much faster.

Getting in and out

The basic RS-232-C-compatible I/O port connects a terminal to a communications modem, printer, data-storage device, or other display terminal for data transfer. The CRT terminals can accommodate a 9,600-baud serial-data rate, which enables them to write a maximum of 1,000 characters per second. In contrast, the plasma terminal can write at a rate of 19,200 bauds.

The plasma panel and random-access CRT can transfer data in parallel as fast as 100,000 characters per second, but the storage-CRT terminal cannot. The high-speed I/O facility enables the terminal to be connected directly to other high-speed devices such as computers, floppy-disk drives, and magnetic-tape units.

Every computer manufacturer supplies teletypewriter

I/O routines. Terminals that can accommodate 80 characters per line can, like a teletypewriter, be attached directly to a computer to display alphanumeric information. However, because a storage CRT requires longer than 100 milliseconds to erase a page of data, transfer must be stopped until the panel is cleared. On the other hand, a plasma panel can erase the entire display in 20 microseconds, so data transfer can be continuous.

Interactive input devices are usually connected internally to the terminal's I/O facility or control logic. The most common I/O devices—keyboard, joystick, trackball, light pen, and function keys—operate equally well with both CRT and plasma-display terminals. However, the plasma terminal can also function with the touch panel, a simple optical mechanism that is difficult to implement with a CRT terminal because of probable errors from the diffusion of light through the curved faceplate.

The touch panel consists of rows of light emitters and detectors positioned around the edges of the display. When the light beam is broken, the coordinates of that position are transmitted to the computer to initiate an action. The flat surface of the plasma panel prevents possible distortion when the touch panel is used.

The plasma display is free of the fundamental reliability problem of the CRT—loss of brightness and contrast as the tube ages. After about 1,000 hours of use, the CRT must be replaced; in contrast, the plasma panel operates longer than 10,000 hours. Moreover, the analog

Evaluating displays

To help the designer choose a display, here are interpretations of the typical values of the main parameters for each type of readout:

Resolution. Representative resolution values, defined as the number of direct picture elements or resolvable line pairs per inch, are 60 lines per in. for the plasma display terminals, 50 to 55 lines per in. for the storage-CRT terminal, and 30 to 40 lines per in. for the random-access CRT display terminal.

Brightness. Typical character brightness is 60 foot-lamberts for the plasma display, 20 ft-L for the random-access CRT display, and 10 ft-L for the storage-CRT display. For comparison, the brightness in a well-lit office is 100 ft-L.

Viewing angle. A function of screen flatness, viewing angle is important for multiple viewers and off-axis viewing. Full-screen viewing angle is about 160° for the plasma display and 70° for the two CRT displays.

Contrast ratio. A high ratio enables the viewer to see displayed data in bright ambient light and decreases viewing fatigue. Approximate contrast ratios are 25:1 for the plasma display, 8:1 for the random-access CRT display, and 5:1 for the storage CRT display.

Light spectrum. The color of an image element on the screen background, this factor is primarily determined by the display technology. Users' color preferences are usually subjective.

Distortion. Caused by screen curvature and beam nonlinearities, distortion causes keystoneing of images, beam nonrepeatability, lack of parallelism, and positioning errors. This effect can be detrimental in computer-aided design and other precision graphics applications. The

plasma display has no distortion, but the CRT displays have a minimum distortion of about 2%.

Writing speed. The rate at which an activated element can be changed, writing speed is normally determined by the erase speed and vector-address rate to yield an effective vector-display speed.

Erase speed. The rate at which an activated element can be deactivated is significant for message updating. The frequency of the sustainer voltage determines the erase speed of the plasma display—about 20 microseconds. The refresh rate of the random-access CRT display determines the full-page erase speed of 16.7 to 33.3 milliseconds. The electron-flooding time of storage-tube CRT display boosts the erase speed to 700 ms.

Vector-address rate. The address and write rate—the rate at which display elements can be addressed and activated—is 150,000 elements per second for the CRT displays, in contrast to 50,000 elements per second for the plasma display. However, for the same display area, the larger dot size of the plasma display fills the area about three times as fast as the CRT displays, resulting in equivalent image-writing times. The viewer is unaware of any perceptible difference in resolution resulting from differences in dot sizes of the displays.

Character-address rate. The speed at which an alphanumeric character can be addressed and written in serial- and parallel-addressing modes, the maximum address rate of the CRT displays is 1,000 characters per second. For the 7-by-9-dot matrix characters of the plasma display, the serial-address rate is 8,333 characters per second, and the parallel rate is 6,250 characters per second.

components in the CRTs, such as deflection amplifiers and digital-to-analog converters, tend to drift with age and temperature changes. The 20,000 to 30,000 volts needed to drive the CRT tends to degrade components, but the digital circuitry in the plasma panel does not drift, and adjustments are never needed. Since its drive voltage is less than 150 v, high-voltage breakdown is impossible.

Comparing terminal mounts

For installation flexibility and ease of use, the size, weight, and configuration of a terminal are important. It should, first of all, be susceptible to rack-mounting. All five units of the random-access CRT display terminal—display indicator, keyboard, display generator, display processor, and power supply—are rack-mountable. A minimum display occupies a standard equipment cabinet six feet high.

The typical storage-CRT terminal is not rack-mountable, nor is the keyboard detachable. If the display with its keyboard is desk-mounted, the second part, the pedestal, must be located nearby. The ruggedized version, which weighs about 80 pounds, is rack-mountable. The equipment normally located in the pedestal is packaged inside the display unit, which is 15.75 inches high, 19 in. wide, and 20.6 in. deep.

The minimal depth of the plasma panel contributes to the unit's small size and weight. The entire terminal,

including power supplies and detachable keyboard, is packaged in one 40-pound unit that can be mounted either on a desk or in a rack. The terminal consists of five functional replaceable modules—plasma panel, driver electronics, sustainer-voltage control, display processor containing control and interface electronics, and power supply, plus the keyboard assembly.

The plasma-panel terminal, which weighs less than 8 pounds, is inherently rugged, and it can be readily configured to withstand severe shock and vibration. In contrast, the large-screen CRT with its relatively large volume and weight is inherently fragile and difficult to ruggedize.

For different reasons, both the CRT and plasma panel have altitude limitations. The high voltage needed to drive the CRT is difficult to suppress for control of electromagnetic and radio-frequency interference. Large-screen CRTs usually must be operated below 20,000 feet, while modern plasma panels can operate to an altitude of 30,000 feet.

Plasma's future glows brightly

The phosphors of the CRT are susceptible to damage by nuclear radiation, but the gas molecules in the plasma panel are relatively immune to it. When a gas molecule is radiated by a high-energy source, it emits a short light pulse and then returns to its normally inert state. Moreover, analog circuitry in the CRT appears to have less

COMPARING DISPLAY TERMINALS

Parameter	Random-access CRT display terminal	Storage-CRT display terminal	Plasma display terminal
Active display area	11.2 in. by 8.4 in.	8 in. by 6 in.	8.55 in. by 8.55 in.
Light spectrum	white or green on black screen	white on green screen	neon orange on black screen
Line and row capacity			
5-by-7-dot matrix	N/A	N/A	84 characters/line, 51 rows
7-by-9-dot matrix	64 characters/line, 16 rows	74 characters/line, 35 rows	64 characters/line, 32 rows
10-by-14-dot matrix	N/A	N/A	42 characters/line, 24 rows
Character size (7-by-9 matrix)	0.2 in. by 0.13 in.	0.087 in. by 0.106 in.	0.112 in. by 0.142 in.
Character capacity			
5-by-7-dot matrix	N/A	N/A	4,284 characters
7-by-9-dot matrix	1,024 characters	2,590 characters	2,048 characters
Character-address (write) rate			
5-by-7-dot matrix	N/A	N/A	8,333 c/s (serial)
7-by-9-dot matrix	1,000 c/s	1,000 c/s	6,250 c/s (parallel)
Full-screen erase time	1/refresh rate = 16.7 ms	0.7 s/scan	20 μ s
No. displayable points	768,000	780, 720	262,144
Dot spacing (center to center)	0.0078 in.	0.0077 in.	0.0167 in.
Vector-address rate	150,000 dots/s	150,000 dots/s	50,000 dots/s
Resolution (line pairs)	33 lines/in.	50 lines/in.	60 lines/in.
Flicker	at refresh rate	during scanning	none
Selective edit/erase	standard	optional (with refresh memory)	standard
Full-screen viewing angle	70°	70°	160°
Full-screen distortion	~2%	~2%	none
Contrast ratio (approximate) (small area, ambient light)	8 : 1	5 : 1	25 : 1
Brightness (approximate)	20 foot-lamberts	10 foot-lamberts	60 foot-lamberts (small area)
Data-transmission rates (into internal memory)	up to 9,600 baud serial (optional) 100,000 c/s parallel	up to 9,600 bauds serial	up to 19,200 bauds serial up to 31,200 b/s serial (optional) up to 100,000 c/s parallel (optional)
Weight	150 to 300 lb	10/80 lb	40/34 lb
Power dissipation	500 to 1,000 W	200 W	400 W maximum

tolerance for nuclear radiation than properly designed digital circuitry.

The advantages of plasma-panel terminals are being increased by leaps and bounds. Right now, Interstate Electronics is developing components that will reduce the number of IC drivers by 75% and the voltage and control-circuit packages by at least 50%. These developments not only will slash the price of the electronics in the terminals at least in half, but they will make feasible production of displays with a resolution of 1,024 by 1,024 lines per inch and a density as high as 100 lines per inch.

Fewer components in the plasma display will increase reliability, dissipate less power, and lead to a 25% decrease in size and weight. Work is well on the way to increase the plasma-dot activation and deactivation rates by at least 25%. Writing rates higher than 60,000 dots per second have been demonstrated, and a rate of 100,000 dots per second is feasible.

In conjunction with this effort, Interstate has already shown how decreasing the frequency of the sustainer voltage can cut the dot duty cycle so that variable brightness levels can be produced. This capability can easily be added to existing display terminals.

Further down the road, "dither," or matrixed-element, input can be added to the plasma display to provide half-tone variations for gray-scale images. Established area-modulation techniques are particularly applicable to the

digital characteristics of the plasma panel. Both plasma and random-access display terminals can produce eight shades of gray, or 64 intensity levels. A storage CRT is normally limited to four shades of gray.

Although three-color CRT terminals are well within the state of the art, control of a three-gun CRT is relatively costly. Three-color plasma panels have been successfully demonstrated, but they are subject to difficulties such as phosphor deposition during fabrication and fast phosphor deterioration. However, a full three-color panel should be commercially available by the end of the decade. When activated by the plasma, the three different phosphors deposited on the back glass plate produce the red, green, and blue colors.

Since the dots of each color are directly addressable, the circuitry is the same used in a monochrome plasma terminal. For good color presentation, a high-resolution (1,024-by-1,024-dot) plasma panel is necessary. A 5,000-hour green phosphor has been developed, and a green ac plasma panel should be available by 1979.

Another plasma-terminal convenience is electrical readout of displayed information. Because the panel memory is inherent, detection of displayed data does not involve computer memory. After detection, the data can be electrically transmitted for storage or printing. This capability allows the operator to generate and/or correct a display and then record the data without computer intervention. □

Borrow my coffee cup... but never my C-Meter.



The C-Meter opens up a new route to efficient designing. It's so handy that you'll find yourself measuring capacitors as a matter of course. Why? Because its pushbutton speed, high accuracy (.1%), small size and versatility (.1pf to .2 farads), make capacitors easier to measure than resistors.

With the C-Meter, you'll waste no time twiddling, and nulling, and you'll cut the need for expensive tight-tolerance capacitors or tweak pots in your circuits. You'll be a much more efficient engineer. And popular too, because people just can't keep their hands off the C-Meter.

You owe it to yourself to try one. Our reps are stocking them at **\$289.**



ECD CORP.

196 BROADWAY, CAMBRIDGE, MASS. 02139
(617) 661-4400

SALES OFFICES: AL, Huntsville (205) 533-5896; AZ, Scottsdale (602) 947-7841; CA, Costa Mesa (714) 540-7160; CA, Sunnyvale (408) 733-8690; CO, Denver (303) 750-1222; FL, Winter Haven (813) 294-5815; GA, Chamblee (404) 457-7117; IL, Elk Grove Vill (312) 593-0282; IN, Indianapolis (317) 293-9827; MD, Silver Spring (301) 622-4200; MA, Burlington (617) 273-0198; MN, Minneapolis (612) 781-1611; NJ, Camden (215) 925-8711; NM, Albuquerque (505) 299-7658; NY, Great Neck (516) 482-3500, (212) 895-7177, Syracuse (315) 446-0220; NC, Raleigh (919) 787-5818; OH, Centerville (513) 433-8171; TX, Houston (713) 688-9971; TX, Richardson (214) 231-2573.

Two 555 timers build pulse-height discriminator

by R. Karni and T. Assis
I.A.E.C. Nuclear Research Center, Negev, Israel

When making pulse and noise measurements, it is sometimes necessary to count the number of transients or pulses of a given amplitude. By configuring two 555 timers as adjustable-threshold monostable multivibrators with the output of one inhibiting the other, the resulting pulse-amplitude discriminator generates a clean square-pulse output only when it receives an input pulse of predetermined magnitude.

As shown in the figure, each 555 is connected as a basic monostable. In this configuration, a negative transition below a voltage level of $V_{CC}/3$ at the trigger input (pin 2) generates an output pulse at pin 3 of duration $1.1(RC)$. The voltage-dividing network at pin 2 permits an adjustable bias from $V_{CC}/3$ to almost V_{CC} . Therefore, since a V_{CC} of 15 v has been chosen, triggering can be made to occur on negative pulses from a minimum of

nearly 0 volt on up to a maximum of almost 10 volts.

Both timers have trigger inputs biased in the same fashion, and both receive the same input pulse through decoupling capacitors C_1 and C_2 . But the output of timer A is connected through an inverting buffer-transistor to the reset input (pin 4) of timer B; consequently, whenever monostable A is triggered, B is inhibited. It is this arrangement that permits the pulse discrimination.

If the threshold of timer A is set higher than that of B, only pulses having magnitudes between the two thresholds will produce a pulse at the output. Pulses of a magnitude less than the threshold of B will trigger neither monostable, and those of a magnitude greater than the threshold of A would trigger both—but the inhibiting action of A on B will allow no output pulse to be produced.

In using the discriminator, the control of B sets the threshold of the incoming pulse, while the control of A is set higher than B, to determine the "window" or the difference of the two thresholds.

With the components shown, and a 15-v supply, the pulse threshold is adjustable from 0 to about 10 v, and the window can be varied from a maximum of just under

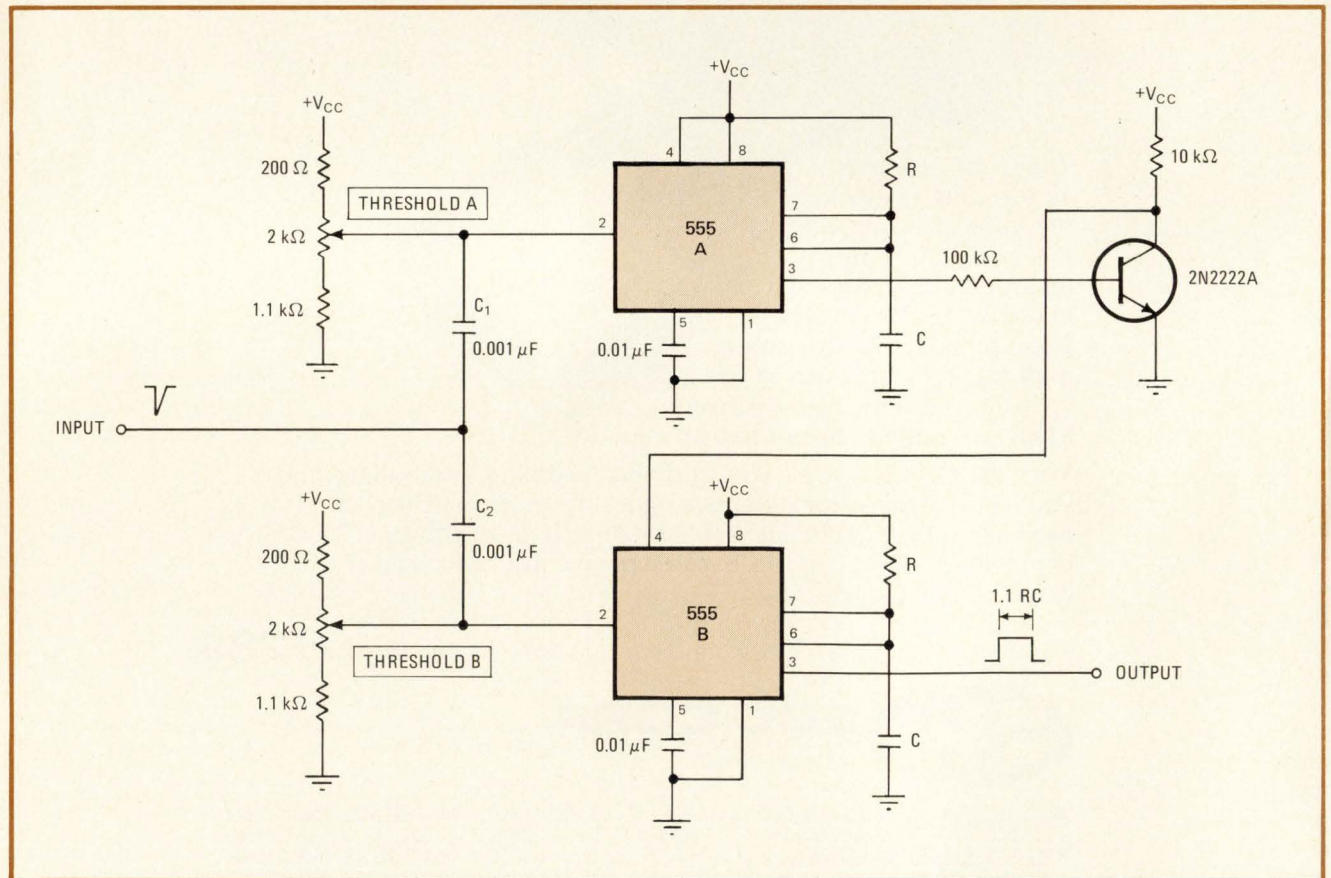

Pulse-amplitude window. Two 555 timers, hooked up as monostables with differing thresholds, select pulses by height. Timer A inhibits B so that an output occurs only when pulse level is within window set by two controls. TTL output-pulse duration is $1.1(RC)$.

10 v (when the threshold of B is set to minimum), down to zero, when B is set to its maximum. If signals of greater amplitude are to be encountered, suitable dividers may be added to avoid transitions below

ground at the pin-2 trigger inputs of the timers.

The output, which can drive up to 200 milliamperes of transistor-transistor-logic loads, may be connected to a counter or monitoring device. □

Analog current switch makes gain-programmable amplifier

by John Maxwell
National Semiconductor Corp., Santa Clara, Calif.

Moderate-cost binary or binary-coded-decimal gain-programmed amplifiers (GPAs) can be built with monolithic current-mode analog switches such as the National AH5010 or the AM97C10. GPAs are useful in audio and other systems that require logic control for signal preconditioning, leveling, and dynamic-range expansion.

The logic-controlled GPA is actually a multiplying digital-to-analog converter. The analog input is the reference node, which is multiplied by the digital input word. Although multiplying d-a converters have been available for some time in module, hybrid, and monolithic form, most are either prohibitively expensive or have poor signal-handling capabilities.

A 4-bit binary GPA with an input voltage swing of ± 25 v can be built with a quad current-mode switch (of the multiplexing type, which has all FET drains tied together), four binary-weighted resistors, and an operational amplifier, as shown in Fig. 1. The output voltage—which is a function of the feedback resistor, input resistors, and the logic states of the field-effect-transistor gates—behaves according to the equation shown in the figure.

Current-mode analog switches, unlike conventional analog switches, control only the signal current at the virtual ground of an op amp. And since the voltage across each of the FET switches is clamped by a diode to a few hundred millivolts, the switches can be driven by standard logic levels, without the need for power supplies, logic interfaces, and level-translator circuits.

A logic 0 turns the switch on because the FET passes current until the channel is pinched off by a gate voltage, and the voltage of a logic 1 is sufficient to pinch the FET off. The built-in clamping diodes hold the source-to-drain voltage to about 0.7 v. A fifth FET is incorporated in the multiplexing-type chip to facilitate op-amp compensation for the on resistance of the FET switches, and, as such, it is placed in series with the feedback resistor.

The number of bits can be expanded by cascading another quad-current switch and resistor array to the first, as shown in Fig. 2. Instead of continuing the binary progression of the input resistors (16R, 32R, etc.), current-splitting resistors (R_{CS}) and shunts (R_S) are used so that the same four-resistor array may be used for additional bits, minimizing the number of different values required for higher-order converters. Binary

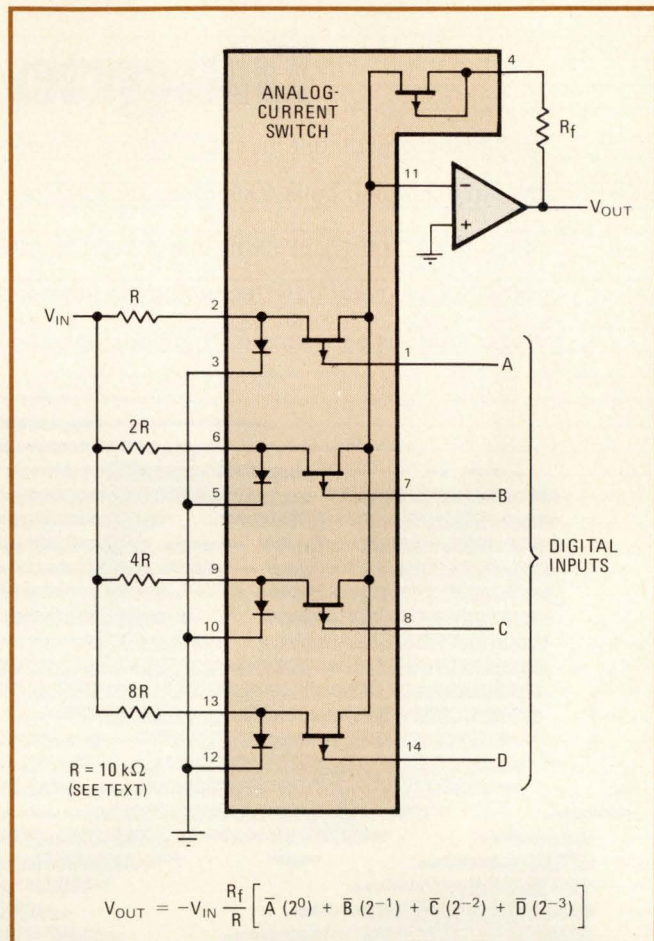

1. Gain-programmable amplifier. A monolithic current-mode analog switch connected to an operational amplifier becomes a moderate-cost GPA, or multiplying d-a converter. The multiplex switch depends on the controlling logic: for TTL, an AH5010 serves, while for C-MOS logic, the AM97C10 should be used. The op amp may be any general-purpose unit such as the LM118.

weighting requires a $1/16$ current split for the second quad switch, while BCD weighting requires a $1/10$ split.

Certain practical limitations must be considered in selecting values of the gain-programming resistors. If high values are used, switch resistance becomes negligible, but leakage at elevated temperatures can cause trouble, and the signal bandwidth is decreased as well.

Using programming resistors that are too small increases switch-resistance errors. In addition, the signal current could saturate the FET as I_{DSS} is approached. High signal currents may even forward-bias the diode and the FET source-gate junction.

An input resistor value of $R = 10$ kilohms limits the switch current to less than 2 milliamperes, minimizing both leakage and switch-resistance problems. The accuracy at unity gain (including the compensation FET

MEMORY AT WORK

Diagnostics Memory for medical

diagnostic equipment must be reliable. Human lives are involved. It must be fast; dynamic imaging calls for high speed CRT refresh. Those are two reasons our MICRORAM static RAM memory systems are chosen so often. Cycle speeds are sufficient for CRT refresh. Our metal-gate technology is inherently reliable. And the support circuitry needed by static RAMS is very simple. That adds up to an overall system reliability you just can't beat.

You can't beat our 15-year experience in the memory business, either. Give us a call today and tell us what you need.

Emm

COMMERCIAL MEMORY PRODUCTS

A Division of Electronic Memories & Magnetics Corp.
12621 Chadron Ave., Hawthorne, Calif. 90250
(213) 644-9881

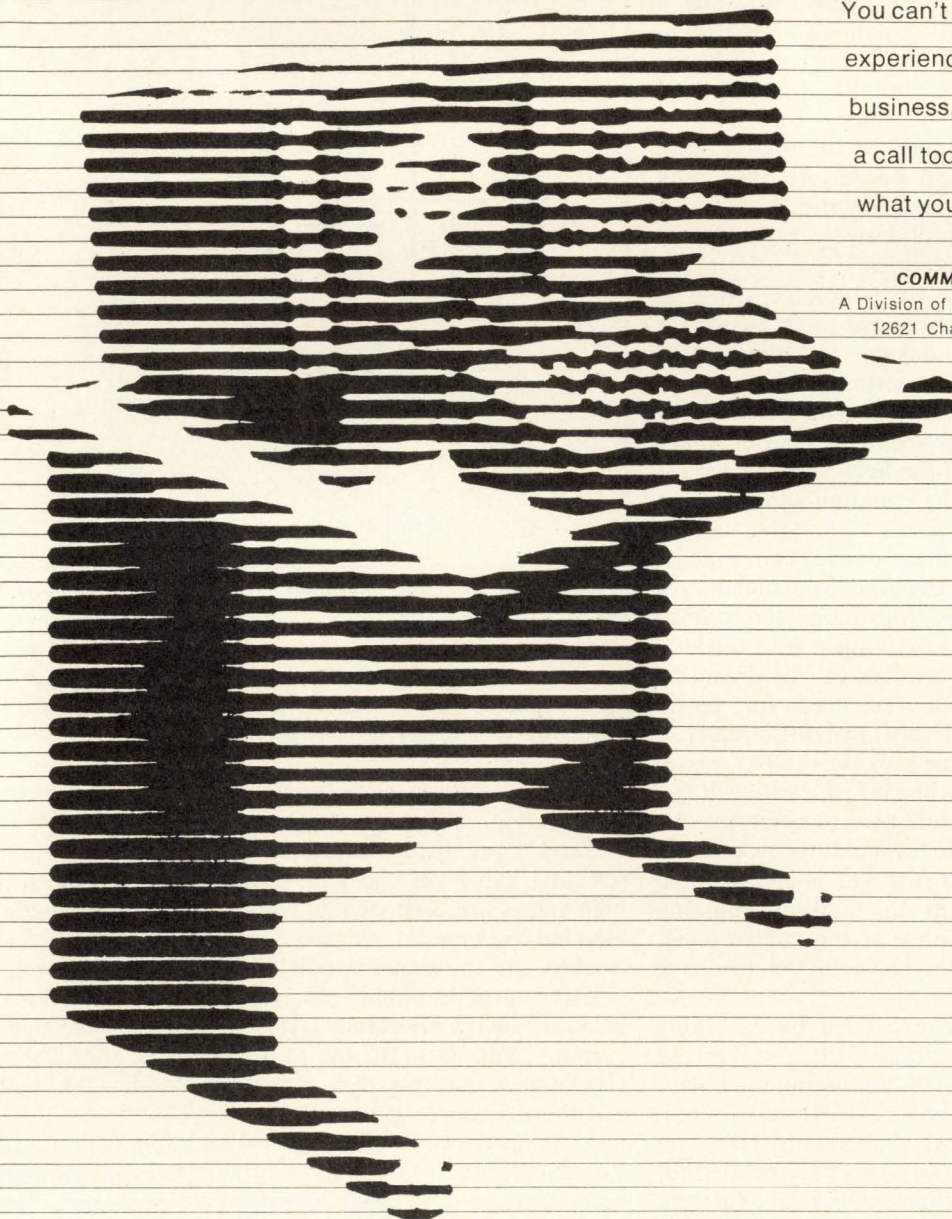

in the feedback loop) is within less than 0.05%, with $R = R_f = 10 \text{ k}\Omega$.

When cascading switches, the current-shunt resistor (R_s) should be small to minimize the voltage drop, keeping the FET drains near ground. Values of R_s should be lower than 100 ohms, typically 20 Ω .

The tolerance required for the programming resistors depends on the desired resolution of the converter; that is, the number of bits, N . For example, an 8-bit d-a converter will have $2^N - 1$ or 255 steps (99 for BCD), or different gains. The resolution or smallest step is the least significant bit, $\frac{1}{2}^N$ of the full-scale value, which works out to .0039. Error for d-a converters is usually specified as 1 LSB, or $\pm \frac{1}{2}$ LSB, which would be $\pm 0.2\%$

for the 8-bit binary unit. The feedback resistor, which is the most critical, should be a 0.1%-tolerance unit. The first resistor, R , contributes one half the full-scale error, and similarly, the second contributes one fourth, and so on. Therefore, using a 0.2%-tolerance resistor for the two most significant resistors, R and $2R$, 0.5% resistors for the third resistor, and 1% resistors for the fourth and fifth, allows 5% resistors to be used in the sixth, seventh, and eighth positions, still producing an overall accuracy within 0.2%. Thus, high accuracy joins the GPA's other assets of high speed and large signal-handling capability. \square

Designer's casebook is a regular feature in *Electronics*. We invite readers to submit original and unpublished circuit ideas and solutions to design problems. Explain briefly but thoroughly the circuit's operating principle and purpose. We'll pay \$50 for each item published.

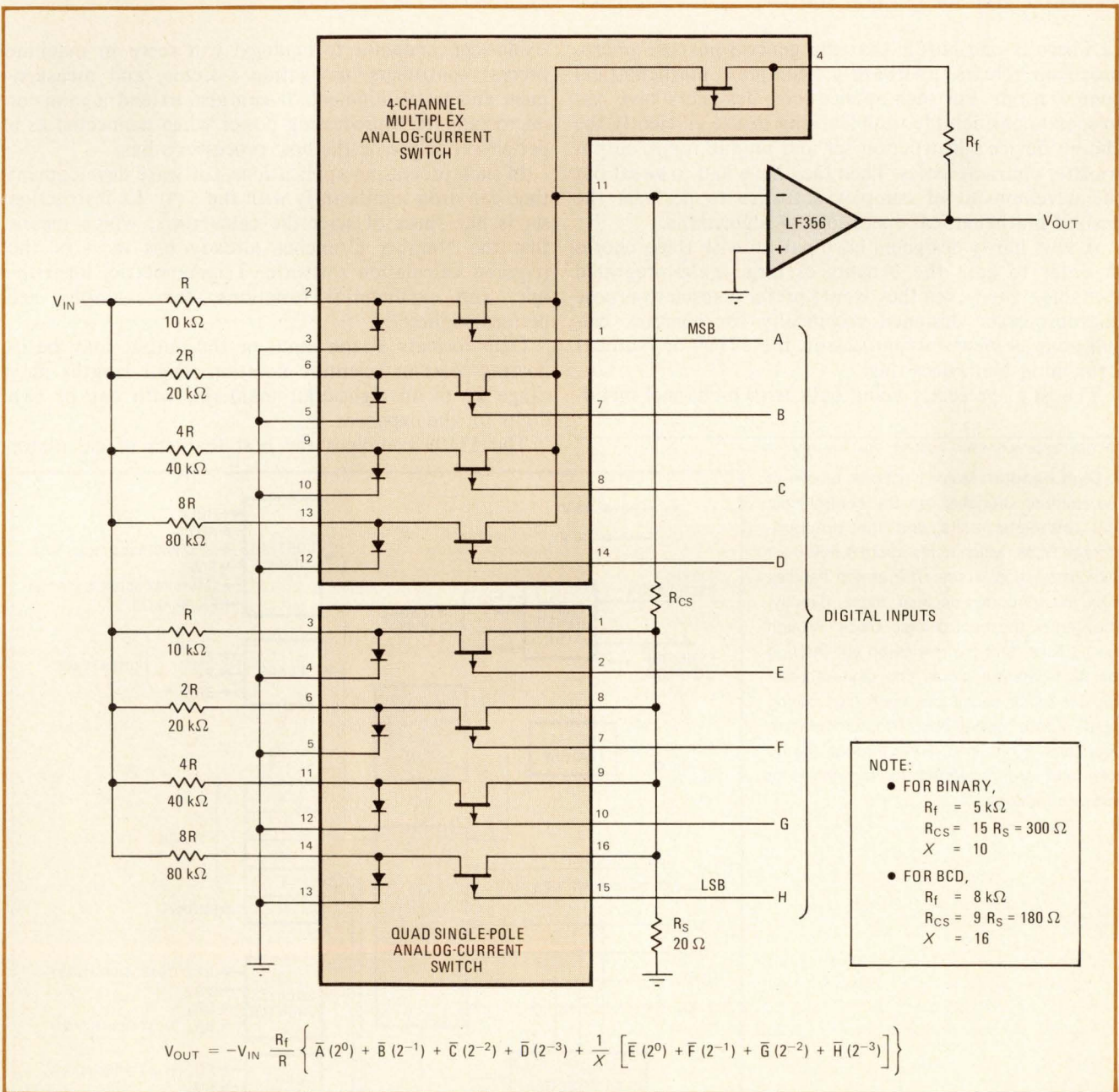

2. Eight-bit multiplying d-a converter. Cascading two 4-bit analog switches realizes an 8-bit programmable amplifier. Note that while the first monolithic switch is the multiplexing type, as in Fig. 1, the second switch is a quad spst type, with drains uncommitted and no compensating FET built in. Suitable types are AH5012 for TTL and AM97C12 for C-MOS digital control. The LF356 op amp settles fast.

Tough mathematical tasks are child's play for Number Cruncher

New special-purpose microprocessor combines best features of general-purpose and calculator chips

by Alan J. Weissberger and Ted Toal, *National Semiconductor Corp., Santa Clara, Calif.**

□ There is one hurdle that the general-purpose microprocessor clears awkwardly: complex mathematical computations. For such applications, designers have had to spend considerable time learning to use efficiently the chosen device's instruction set and unique input/output transfer characteristics. Then they have had to sweat out the development of complex software to perform the desired mathematical operations or algorithms.

A few, hardy designers have put up with these chores in order to gain the benefits of large-scale-integrated technology, but even they would prefer a special-purpose microprocessor designed specifically for complex calculations. A new microprocessor, the 57109 or Number Crunching Unit, does this.

The NCU, presently being built with p-channel metal-

oxide-semiconductor technology, can serve in machine process controllers, navigation systems, and measurement and test equipment. It can also extend a mini- or microcomputer's processing power when connected as a peripheral device on the host processor's bus.

In such processing applications, software development time can drop significantly with the NCU. Its instruction set is like those of scientific calculators, which means that the Number Cruncher already has most of the required calculation software. Trigonometric, logarithmic, and exponential functions, for example, are performed directly.

Data formats at the input or the output may be in floating-point or scientific notation. Digit lengths may range up to an eight-digit mantissa, with one or two digits for the exponent.

The 57109 combines the best features of calculator

*Al Weissberger is now with Signetics Corp., Sunnyvale, Calif.

1. Digit handler. Major functional blocks of the Number Cruncher are the control-logic and arithmetic units and the program-storage ROM, which holds about 1,500 8-bit microinstruction words. The device handles 4-bit binary-coded-decimal digits directly. They enter the control-logic block through the $I_{1,4}$ lines, and the results go out through the digit-data-out block. The digit-address-counter block sequences each digit during input/output operations. Programmed instructions, 6 bits long, enter through the $I_{1,6}$ lines and are converted to sequences of microinstructions.

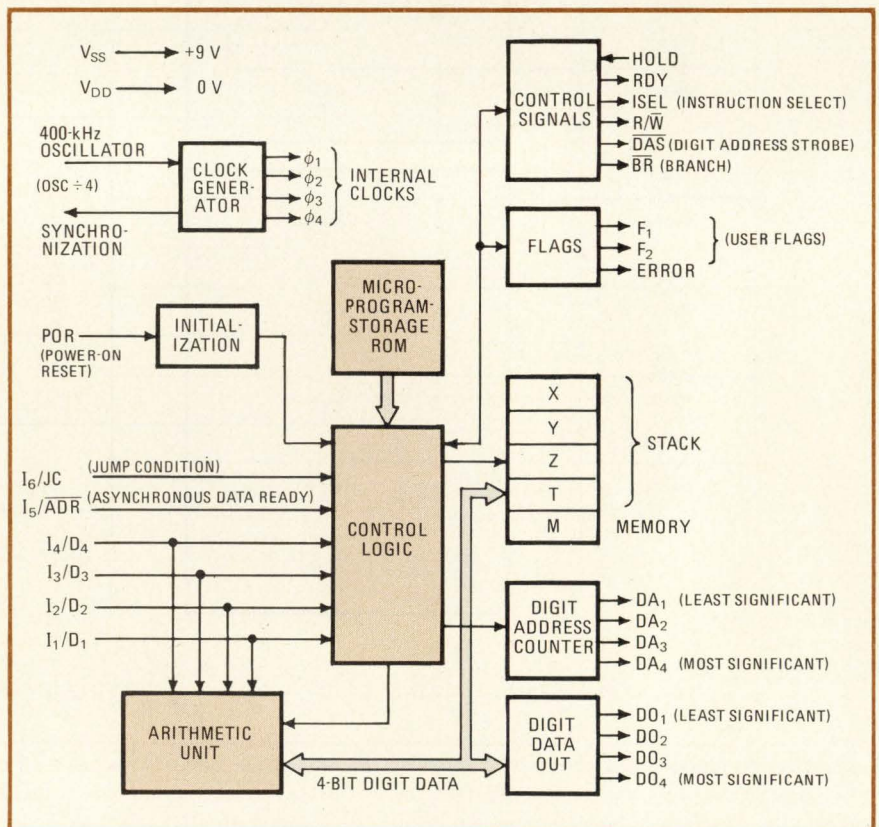

chips and general-purpose microprocessors (Table 1). For example, its I/O functions are more flexible than those of the calculator, which is limited to inputs from a keyboard and outputs to a display. But it is more directly useful for calculations than microprocessors. The NCU can accept a sequence of binary-coded-decimal digits with a single input instruction, an asynchronous digit input, or single-bit inputs for control purposes. In contrast, microprocessors work only on data bytes.

Unlike calculators, the Number Cruncher is controlled by a program stored in an external read-only memory and can perform conditional and unconditional program branches. As in processors, a HOLD input allows handling asynchronous instructions and single stepping, while test and branch instructions facilitate decision-making within programs.

The NCU's major functional blocks (Fig. 1) are the control-logic and arithmetic units and the program-storage ROM, which holds about 1,500 8-bit microinstruction words. Programmed instructions, 6 bits long, enter through the I_{1-6} lines and are converted to sequences of microinstructions. Binary-coded-decimal 4-bit data words enter the control-logic block through the I_{1-4} lines.

Output data passes through the digit-data-out block, while the digit-address-counter block sequences each digit during I/O operations. Logic levels are compatible with low-power logic families, and the device has on-chip generation of input/output strobes and timing signals.

Examples of the 6-bit operation codes are given in Table 2. (If 8-bit instruction memories are used, external hardware can use the additional 2 bits for device addresses.) Instruction executions vary in time from 1 to 500 milliseconds, although most require 5 to 10 ms. Although these speeds may seem rather slow, they compare favorably with similar functions implemented as subroutines in low-cost microprocessors.

Conditional-test-and-skip/branch instructions permit decision making within the user's program. The conditional-test instructions operate on the results of computations or from an external jump-condition sense input on line I_6 . The two flag outputs (F_1 and F_2) may be used to activate external devices. A four-register stack (X, Y, Z, T) holds operands and temporary results, and a

Function	Calculator	Number Cruncher	Microprocessor
Input/output	keyboard and display	multidigit, asynchronous digit, single bit	data bytes, single bit
Data format	floating-point or scientific notation	floating-point or scientific notation	binary
Data length	fixed	variable (1 to 8 digits for mantissa)	fixed
Program	key sequence	external ROM/program counter, microprocessor, or first-in, first-out buffer memory	external ROM, internal PC
Speed (math or I/O operations)	14 - 400 ms	0.5 - 400 ms	0.5 - 500 ms
Minimum number of chips for CPU and RAM	1 - 3	1 (external PC)	2 - 6

Digit entry: 0 - 9 EE CS PI EN	Each digit is entered into the X register mantissa or exponent if in enter-exponent mode. Fixes decimal point of mantissa of number being entered. Set enter-exponent mode. Change sign of mantissa or exponent. $\pi \rightarrow X$ register. Number entry terminated and stack is pushed. $X \rightarrow Y \rightarrow Z \rightarrow T$
Move: Roll POP XEY XEM MS MR	Roll stack. $X \rightarrow T \rightarrow Z \rightarrow Y \rightarrow X$ Pop stack. $X \rightarrow Y \rightarrow Z \rightarrow T \rightarrow 0$ Exchange X and Y. $X \leftrightarrow Y$ Exchange X with memory. $X \leftrightarrow M$ Memory store. $X \rightarrow M$ Memory recall. $X \leftarrow M$
Math: $X \leftarrow Y + X, X \leftarrow Y - X$ $X \leftarrow Y * X, X \leftarrow Y / X$ $X \leftarrow Y^X$ $M \leftarrow M + X, M \leftarrow M - X$ $M \leftarrow M * X, M \leftarrow M / X$ $1/X, \sqrt{X}, X^2, 10^X, e^X, \ln X, \log X$ $\sin(X), \cos(X), \tan(X)$ $\sin^{-1}(X), \cos^{-1}(X), \tan^{-1}(X)$ RTD, DTR	Result in X, stack popped. $Y \leftarrow Z + T + 0$ Result in memory. Result in X, previous X lost, stack unchanged. Result in X, previous X lost, stack unchanged. Convert X from radians to degrees or vice versa. Previous X lost, stack unchanged.
Branch: JMP TJC	Unconditional jump. On call branch instructions, second word of instruction is the branch address, which is loaded into an external program counter by a load pulse from the NCU. Test external jump condition, branch if true.
Input/output: IN OUT AIN	Multidigit synchronous input from RAM or peripheral into X register. Multidigit synchronous output to RAM or peripheral from X register. Single digit asynchronous input. Wait for asynchronous data ready (ADR) to go low, then read data and pulse acknowledge flag F_2 .
Mode control: SMDC	Set mantissa digit count from one to eight digits.

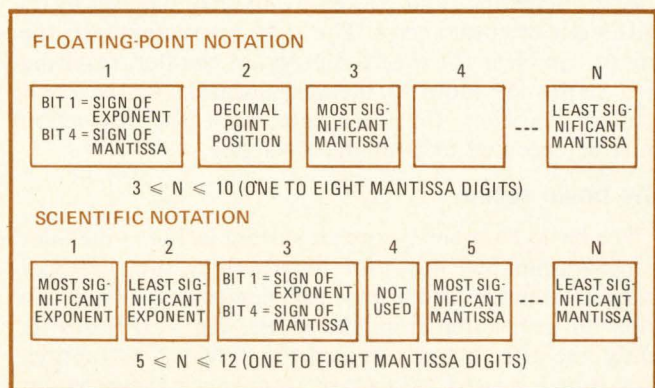

2. Two formats. The NCU can operate on data in floating-point or scientific notation formats with one to eight mantissa digits, depending on the setting of the digit count. It takes only one instruction to input or output a string of digits.

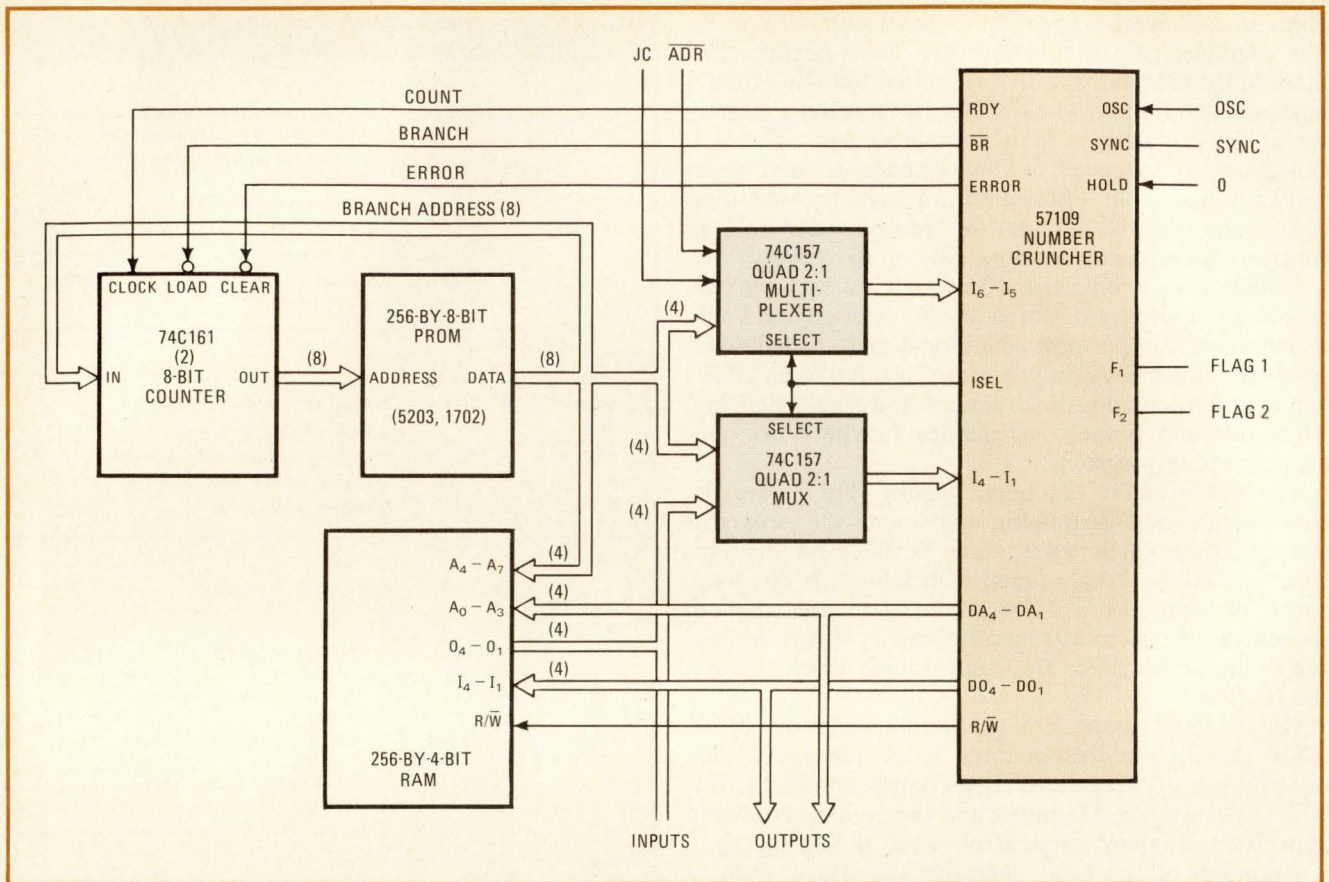

3. Stand-alone. The Number Cruncher can be used by itself in many control applications. Here a programmable ROM stores instructions, controlled by an external program counter, and a 256-by-4-bit RAM extends the internal memory. Multiplexers enter data or instructions.

memory register can store constants or temporary results or can serve as a loop counter for data transfer or program control. Additional data storage may be provided by external 256-word-by-4-bit random-access memories.

The two data formats are shown in Fig. 2. No reformatting is necessary when data is extracted from the 57109 or reentered from an external RAM. An asynchronous digit-input (AIN) instruction will accept a single digit when a data-ready signal indicates valid data.

Error detection is facilitated by an error flag, set by an arithmetic or output error. The TERR instruction tests the flag or can clear the external program counter, resulting in a hardware jump to memory location 0, the error recovery location. In either case, an ECLR instruction must be executed to clear the error flag.

The basic setup

The basic Number Cruncher system in Fig. 3 includes a programmable ROM for instructions, an external program counter, and a RAM for memory expansion. To fetch an instruction from the PROM, the NCU raises its ready line after it has executed the previous instruction. This signal is used as a clock to advance the program counter.

The PROM then accepts the new 8-bit address supplied by the PC, executes a read cycle, and supplies the instruction to the NCU. To facilitate entry of asynch-

ronous instructions, the 57109 does not lower RDY and begin execution until its HOLD input is low.

When the incoming instruction is a test and skip, the chip activates RDY to advance the PC and obtain the next word on the PROM output lines. This word is actually a branch address.

If the branch condition is true, the NCU's branch signal gates this address back to the program counter by parallel-loading it on the leading edge of the next RDY signal. When the PC is loaded, the PROM outputs will be the contents of the instruction at the branch address.

If the branch condition is not true, RDY is raised to step the PC so that it will point to the next sequential instruction at the time of the next instruction fetch.

The instruction-select signal (ISEL) selects which type of input will be used: instructions or data. The 2:1 multiplexers supply the Number Cruncher with data signals or instructions on the six input lines. This multiplexing saves pins so that the NCU can fit into a 28-pin package.

For a data-input instruction (IN), the Number Cruncher again raises RDY to advance the PC to the next instruction word, which contains a 4-bit high-order RAM address. The NCU supplies a 4-bit low-order digit address to the RAM from the digit-address DA lines and reads the RAM digit data on its input lines, having set ISEL low to select data instead of instructions. On a single IN instruction, 3 to 12 digits are input.

The OUT instruction procedure is similar to that for IN,

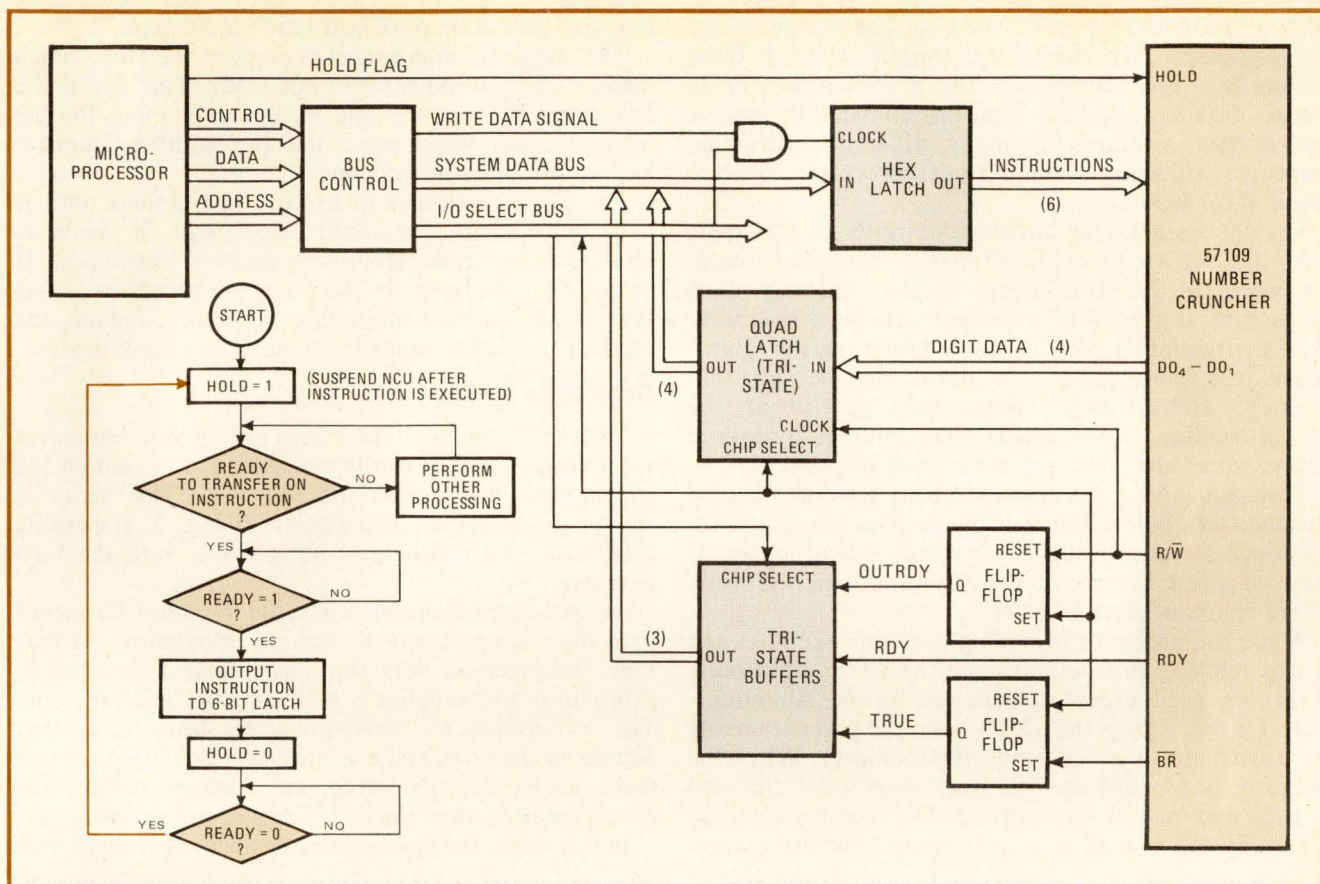

4. Partners. The NCU can extend processing power of a general-purpose microprocessor by taking instructions and data from the processor's bus and executing the instructions at its own pace. Flow chart shows software for microprocessor control of interface.

except that digit-output data is supplied on the data-output DO lines and the read/write line is pulsed to write each digit into the RAM. After putting out 3 to 12 digits, the 57109 enters a fetch cycle to obtain the next instruction.

Extending a processor

Software overhead can be staggering for microprocessor applications requiring mathematical functions or BCD operations. Sophisticated subroutines must be written for multiply, divide, square root, log, exponential, and trigonometric functions. The data must be scaled to fix the decimal-point position and to assure there will be no register overflow as a result of an operation. Further conversion is necessary if the result is to be given in floating-point or scientific notation.

However, the Number Cruncher provides a microprocessor with a convenient peripheral unit for performing these specialized calculations. The microprocessor controls the NCU simply by supplying it with valid instructions, directly or through a buffer memory. Overlapping execution in the two devices gives much greater throughput than when the microprocessor performs the calculations itself.

A straightforward processor-NCU interface can be built with a pair of latches (Fig. 4); one for instructions and input data, the other for output data. The processor suspends the NCU's operation through the latter's HOLD signal. When the microprocessor is ready, it loads the

instruction latch with a 6-bit instruction code and sets HOLD low.

The Number Cruncher executes the 6-bit code. The microprocessor senses succeeding RDY signals from the 57109 (as an interrupt or jump-condition input) and then loads the latch with the next instruction. It supplies input data to the Number Cruncher on a digit-by-digit basis in the same manner as it does 6-bit instructions.

When the NCU has data to send back, it uses a 4-bit latch. The microprocessor reads and stores this data as it is loaded into the latch.

Using a FIFO

In another method for extending a microprocessor system with the Number Cruncher, a first-in, first-out buffer memory is a dynamic instruction store (Fig. 5). The microprocessor loads the FIFO, and the NCU draws instructions from it. Another FIFO is used for output data from the 57109. Since these memories are totally asynchronous, with separate input and output controls, the processor and the Number Cruncher can run at full speed in parallel for maximum system throughput.

This setup is useful in applications where the sequence of instructions executed by the NCU may change. Since the FIFO is a dynamic memory, it permits easy alteration of the sequence. Because instructions are stored only until the 57109 removes them, it is possible to load a very large sequence in a very small space.

When the microprocessor has a job for the NCU, it

loads a linear sequence of instructions (no branches) into the instruction FIFO, which was initially cleared. Once loading has been completed, the processor is free to process data or control devices. The FIFO can be used as the storage medium for many different instruction sequences with only minimum microprocessor software required for loading.

The FIFO stacks the instruction words in the same order as they are entered and makes them available at the output in the same sequence. The processor treats instructions to the 57109 as output data, as if they were to be written into a RAM or loaded into a register. But it selects the FIFO as an I/O device by putting that memory's address on its address bus. Next it puts the NCU instruction data on the data bus followed by a write strobe, which the FIFO uses as an input data clock.

This sequence is repeated each time a word is loaded into the FIFO. Before transmitting each instruction word, the processor checks the FIFO's status-indicator flag. If the FIFO is full, the microprocessor waits until it is ready before resuming data transfer.

While the processor is loading data into the FIFO, the NCU is fetching instructions from the FIFO output ports at its own speed, executing them one by one. An output-indicator flag signals the 57109 when the ports are ready (FIFO not empty) or not ready (FIFO empty). When the processor has loaded the first instruction word, the FIFO is ready and may be interrogated. The Number Cruncher's ready line is used as a FIFO output clock to extract

data and gate it onto its instruction input lines.

The last instruction executed empties the FIFO, which forces its output indicator to not ready. This flag is the hold input for the NCU and an interrupt input for the microprocessor, which senses that the Number Cruncher has completed its instructions.

The 57109 continues to execute instructions until it has completed its specialized calculations. It sends its results to the output FIFO using an OUT instruction. If output data is present in the FIFO, the processor senses this via an interrupt or jump condition. It obtains the results if needed or sends them on to an output device.

Control by a ROM

To transfer instructions where only a few sequences are necessary, a ROM can be programmed to contain the sequence of instructions for the NCU. This setup is similar to the stand-alone system in Fig. 3. It permits conditional test instructions not possible with the FIFO interface.

An AIN instruction suspends the Number Cruncher until the microprocessor requests a calculation. At that time the processor sets the asynchronous data ready (ADR) to 0 and supplies a 4-bit starting address code. The NCU decodes the starting address, branches to that address in the ROM, and executes the calculation routine there. As in the FIFO setup, an interrupt notifies the microprocessor when the 57109 has completed its task.

In this setup, the microprocessor does not have to load

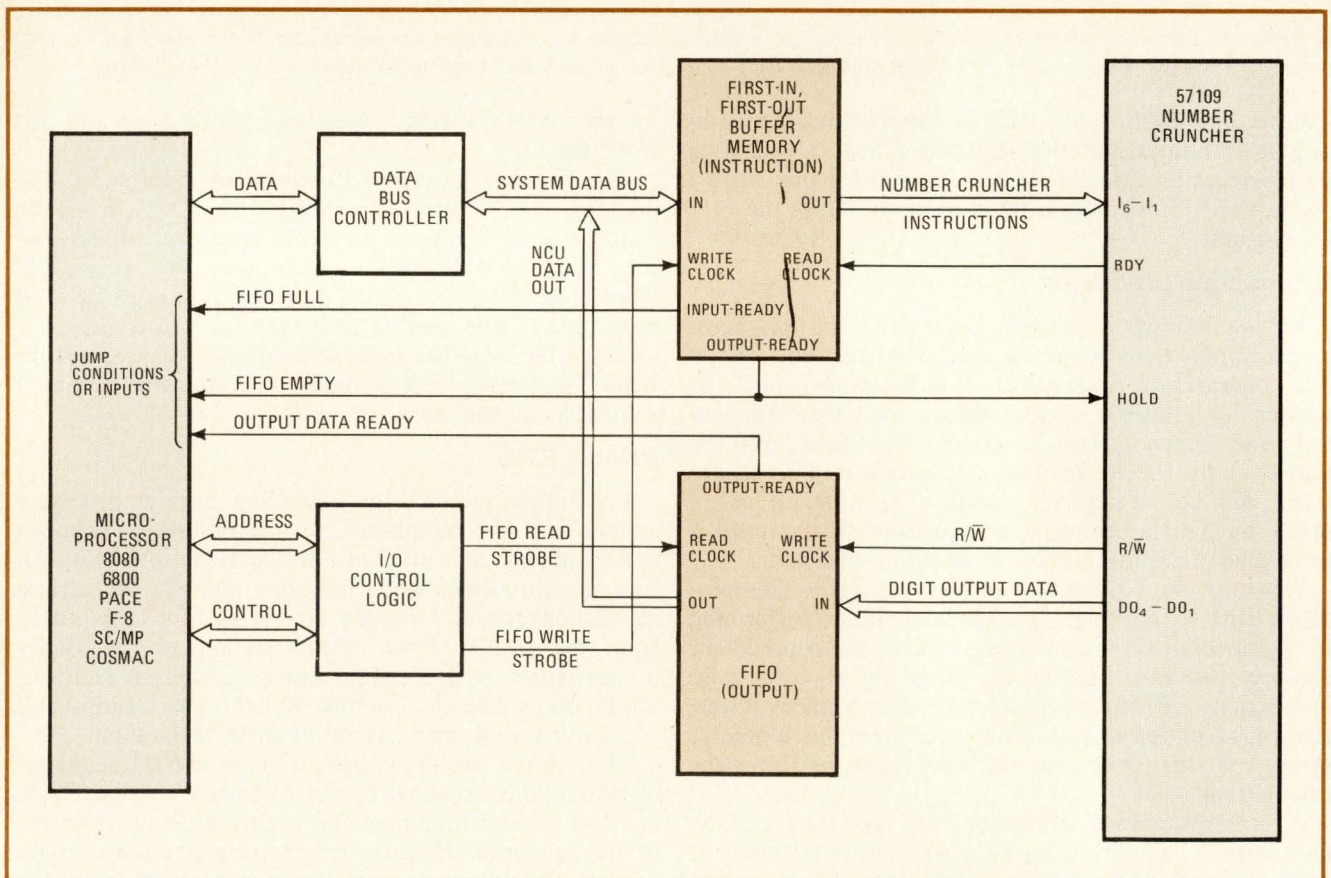

5. FIFO interface. A microprocessor can control the Number Cruncher through first-in first-out memories. The microprocessor enters data and instructions into the instruction FIFO, and the Number Cruncher extracts them asynchronously.

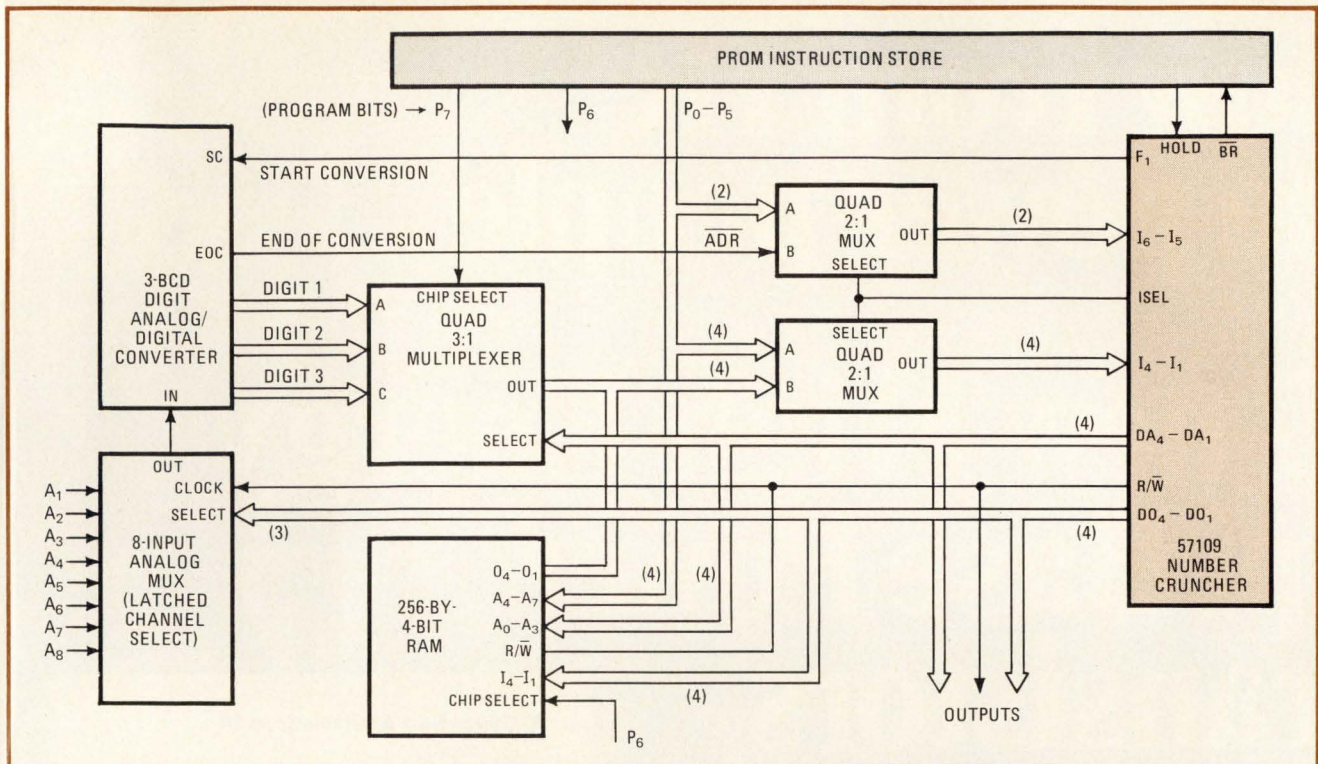

INSTRUCTION FORMAT							CODING						
Type of instruction	P ₇	P ₆	P ₅	P ₄	P ₃	P ₂	P ₁	P ₀	P ₇	P ₆	P ₅₋₀	Comment	
Select analog channel	1	1							1	1	4	number of channels to be input	
Analog-to-digital input	0	1							1	1	MS	store in M	
RAM I/O	1	0							1	1	SMDC 1	mantissa digit count = 1	
Others	1	1							LOOP	1	1	MR	retrieve channel number
										1	1	OUT0	select analog channel
										1	1	PF 1	start A/D converter
										1	1	EN	push stack
										0	1	AIN (3)	read A/D converter digits 1 to 3 when EOC = 0
	1	1						1	1	DBZ DONE	update channel number and check		
									1	1	JMP LOOP	if 0	

6. Data acquisition. The Number Cruncher can handle complex data in an analog system by controlling the analog multiplexer, which sends analog data to an analog-to-digital converter. The program listing shows how single instructions from the NCU handle complex operations.

a buffer memory to provide the NCU with instructions, but merely switches it on by supplying a single input (ADR). The result is very high system throughput and parallel processing.

In the analog data-acquisition system in Fig. 6, the PROM program controls the Number Cruncher. It makes the NCU measure analog variables, perform some digital transformation on them, compare the results to certain specified limits, and send out control information on the DO lines.

Acquiring analog data

An eight-input analog multiplexer selects the desired analog input channel based on a 3-bit address supplied by the NCU on DO₃₋₁. This address is latched by the multiplexer and will not change during the conversion time of the three-BCD digit analog-to-digital converter via Flag 1. After starting the conversion via Flag 1, the NCU's AIN instruction waits for the end-of-convert signal before reading one of the three digits through the 3:1 digital multiplexer. The second and third AIN instructions read the second and third BCD digits with the results stored internally.

The PROM program updates the analog address and tests to see if all analog channels have been interrogated. If so, the program will output the digitized data to the RAM or will process the data as required. If not all analog channels have been interrogated, the PROM program scans the next one.

This system uses internal NCU storage for simultaneous calculations on four three-digit numbers. Additional storage is provided by the 256-by-4 RAM so that the 57109 can operate on an array of data. Addressing the data in the RAM is facilitated by the IN and OUT instructions. The first instruction word is either IN or OUT, and the second supplies a 5-bit address to select one of 32 numbers in the RAM. This address is stable on the instruction input lines (I₆₋₁) and is valid throughout the data transfer cycle.

The Number Cruncher generates a 4-bit address (DA₄₋₁) to select a digit each time it is ready to input or output 4-bit data. For an OUT instruction, digit data is output on DO₄₋₁ and clocked into the RAM by the R/W strobe. For an IN instruction, the high level on R/W causes the RAM to go into a read cycle and supply digit data to the NCU through the quad 2:1 multiplexers. □

Now from IR the power people...

97 new High Energy Epi Base Power Transistors built to last!

We see no reason why all power transistors shouldn't live longer. That is why we're introducing 97 high energy, epi base power transistors and Darlington's, rated 40 to 140 Volts V_{CE0} sus, and 170 Volts V_{CEX} sus, with the same tough, hard glass passivation used on our high voltage line. It reduces high temperature leakage current to 1/10th that of others.

You benefit from our years of development of glass passivation processing by getting the added high temperature stability at no extra cost. It's typical of the extra value we've been putting into power semiconductors for more than 30 years.

These new transistors have higher switching speeds and lower V_{CE} saturation levels than single diffused types, a wide safe operating area, and high gains at 150°C junction temperature.

Delivery is off-the-shelf. Contact your nearest IR Salesman or Distributor for prices, spec sheets and samples, or write to International Rectifier, 233 Kansas St., El Segundo, CA 90245. Telephone (213) 322-3331.

97 Types Now Available from IR

VOLTS	PNP	NPN	VOLTS	PNP	NPN
5 AMPERES					
100V	2N6226	2N5758	60V	2N6050*	2N6057*
120V	2N6227	2N5759	80V	2N6051*	2N6058*
140V	2N6228	2N5760	100V	2N6052*	2N6059*
8 AMPERES					
60V	2N6053*	2N6055*	40V	2N6469	2N6470
	IR900*	IR1000*	60V	2N5879	2N3055
80V	2N6054*	2N6056*		2N6246	2N5881
	IR901*	2N6534*			2N6471
		IR1001*	80V	2N5880	2N5882
100V		2N6535*		2N6247	2N6472
		2N6536*	100V	2N6029	2N5629
120V		2N6537*	120V	2N6030	2N5630
10 AMPERES					
40V		2N6383*	140V	2N6031	IR3773
60V	2N3789	2N3713			IR6302
	2N5791	2N5715			2N5631
	2N5875	2N5877	20 AMPERES		
	IR2500*	2N6384*	60V	2N5745	IR3772
	IR645*	IR1010*		2N6285*	2N6282*
		IR1020*	80V	2N6286*	2N5303
		IR3000*			2N6283*
		IR640*	100V	2N6287*	2N6284*
80V	2N3790	2N3714	25 AMPERES		
	2N3792	2N3716	60V	2N5883	2N5885
	2N5876	2N5878	80V	2N5884	2N5886
	IR2501*	2N6385*	30 AMPERES		
	IR646*	IR3001*	40V	2N4398	IR3771
		IR641*			2N5301
100V	2N6229	2N5632*	60V	2N4399	2N5302
	2N6248	IR642*	90V	IR4502	IR802
	IR647*				
120V	2N6230	2N5633			
140V	2N6231	2N5634			

*Darlington

International Rectifier

... the innovative semiconductor people



Exercising the functional structure gives microprocessors a real workout

New test method combines stored-response testing with monitored 'native-tongue' pattern generation

by Douglas H. Smith, Tektronix Inc., Beaverton, Ore.

□ Testing MPUs and playing Russian Roulette have more in common than the casual observer might think. "Winning" at testing often depends too much on the same kind of luck that the pistol-packing game player relies on. And "losing" can be just as serious.

Luck is a test ingredient because most techniques fail to fully test all the functions and capabilities of micro-processing units. The root of this failure is the conceptual inadequacy of the testing methods: they have lagged behind the technology.

At Tektronix, studies have shown that three widely used methods—"actual use," algorithmic pattern generation, and stored response—do not yield 100% accuracy in sorting good MPUs from bad in a minimum amount of time. Nor do they give any assurance that a syntactically correct set of instructions will function properly with the microprocessor.

Another way

A new test method, called Wisest, overcomes the deficiencies of these older procedures. It combines stored-response testing with monitored "native tongue" pattern generation. Its genesis lies in an approach that

considers the structure of the MPU's functional blocks as the real targets of the test. It is this approach to testing, as much as the test devised, that gives success.

An example of a pattern generated by the new method is shown in Fig. 1. This 17-step pattern tests the call-if-minus (CM) instruction of the Intel 8080, a subroutine that tests if its accumulator is negative. The logic state of column 1 (1 valid, 0 false) determines the validity of the address contained in columns 2 through 17, and the state of columns 18 and 19 determines whether the I/O bus columns are in the output (11), don't care (01), or input (00) states. These results are not possible with the older methods because they are not capable of the complex kinds of interactions necessary to exercise the 8080 to the fullest.

Wisest came about after a hard look at the deficiencies of the three older test methods. A review of these drawbacks will also point to some of the criteria for the approach that generated the new test method.

The "try it, you'll like it" school of testing also goes under the name of actual use. The approach is: if it works, ship it. If it doesn't work, reject it, plug in a new microprocessor, and ship that one (if it works).

The method of testing is fast and fairly simple. Just

	0	0	0	0	
	1	2	3	4	
1	2345678901234567	89	01234567	89012345	6789012345
1	0000000000011010	00	11111100	00000000	0000010000
0	1111111111111111	01	01110111	00000000	0000010000
0	1111111111111111	01	00000000	00000000	0000010000
1	0000000000011011	11	00000000	10000010	0000011000
0	0000000000011011	01	00000000	10000010	0000110000
1	0000000000011011	00	10101010	00000000	0000010000
1	0000000000011100	11	10100010	10000010	0000011000
1	0000000000011100	01	00000000	10000010	0000110000
1	0000000000011100	00	10101010	00000000	0000010000
1	1111111111111110	11	00000000	00000100	0000011000
1	1111111111111110	01	10100010	00000000	0000010000
1	1111111111111110	11	00000000	00000000	0000000000
1	1111111111111101	11	01110111	00000100	0000011000
1	1111111111111101	01	00000000	00011101	0000010010
1	1111111111111101	11	00000000	00011101	0000000010
1	1010101010101010	11	00000000	10100010	0000011010
1	1010101010101010	01	00000011	10100010	0000110010

1. Ones and zeroes. This pattern generated by the Wisest's test system fully checks the subroutine for the CALL IF MINUS instruction of the Intel 8080. The logic states of columns 1 to 17 check the validity of system addresses, while columns 18 to 35 check the status (input, output, don't care) of the I/O bus lines of the microprocessor.

OBJECT

Prove existence and uniqueness of 8080 registers

Instructions Used

LXI H (Load registers H&L with effective address)
PCHL (Load PC with HL)
MOV r_1, r_2 (Move the contents of r_2 to r_1)

ALGORITHMIC METHOD

- 1) Load Hardware Counter #1 with Zero
- 2) Via the "LXI H" command, transfer the contents of counter #1 to H,L
- 3) Transfer H to all other 8080 registers
- 4) Transfer each 8080 register in turn back to H (via MOV r_1, r_2) and then check each HL content (via PCHL)
- 5) Do 3 & 4 above using L
- 6) Increment counter #1
- 7) Check counter #1 less than 256 -- END
- 8) Go to Step 2.

2. Scratch pad. The scratch pad registers of the 8080 are often checked with this algorithm. It is an incomplete test, since the algorithm only checks for the existence of the PC or HL registers. Additional software instructions and hardware would be required to check all the 8080's registers completely.

install the MPU into the finished product, then test the system using application-related software. For low-volume, low-risk products, it is certainly a fast, inexpensive way to test. For other products, it suffers from several distinct disadvantages.

One is that the application software won't necessarily check the central processing unit completely. Both the Intel 8080 and the Motorola 6800 CPU chips can address 64,000 locations in memory. Chances are that very few applications will actually use this many addresses. If the tester tests the 4,000 needed in a typical application, then the other 60,000 won't be exercised at all. In many applications it is possible to rip half the leads off a CPU and have it still pass the actual use test.

Bus stop

A finished product can go out of the factory stamped OK, but then one of the unused address lines may short out and affect the address lines in use. Similarly, latent problems with the program counter or stack pointer won't be detected.

Nor does such testing check the MPU input/output bus structure. Since the circuitry of the bus pins can act as input or output lines, it would be nice to know that they are functioning correctly. Actual use testers usually don't have the proper interconnections to exercise and to check the structure of the input/output bus of the microprocessor.

Another problem with actual use tests occurs with marginal MPUs. It is quite possible to test and pass a chip that will fail in the field. In a typical test, all clocks are set properly, timing signals are right on, voltage levels are perfect, and the laboratory temperature is thermally controlled at 25°C. Under such conditions, marginal MPUs can pass testing. But, when cold or heat

gets to the processor, or the line voltage is low, or the power supply or system timing drifts, then an apparently good device can fail in use.

There's another consideration in actual use testing, which may be called the "implication of the failure." It relates directly to the end use of the processor. If the MPU goes into consumer applications, a failure in use is an inconvenience. In a critical avionics system, failure can have serious, even fatal, consequences.

So, considered against implication-of-failure criteria, the actual use test method is valid for only a noncritical few applications. In general, the rigor of the test should relate to the final application from the standpoints of both cost-effectiveness and safety.

Testing . . . I,O,1,0 . . .

Another widely used testing method is algorithmic pattern generation. A high-speed pattern generator under microprogram (algorithmic) control of the main test system forms a sequence of real-time patterns based upon a simplified sequence of instructions. The basic premise is that these sequences will show up defects in logic or timing if the algorithmic sequence represents the operating sequence.

An in-depth look at algorithmic pattern generation discloses the implication that testing a few, simple, limited instructions many, many times can weed out the good MPUs from the bad. Yet this creates a situation not usually met in device usage. For instance, an algorithm to verify the existence and functioning of the 8080's program counter would be simple enough to write—just specify 64,000 NOP (increment-counter) instructions. But the contents of the PC can be changed in many other ways besides a straight incremental count and cannot be tested effectively as a simple counter.

While the repetitive structure of the algorithmic test suits it to checking memory, it is not adequate for testing microprocessing units, which work with programs, instructions, and functions—all distinct and variable. One can prove that all gates of the MPU's integrated circuits exist and work as gates, but it is not possible to prove the validity of their interrelationships and functions. The test method ignores the heart of the microprocessor: its ability to understand instructions and to perform functions.

An actual test shows up the inflexibility of this procedure, as in the algorithm in Fig. 2, which is commonly used to check the internal scratch pad registers of the 8080. Since each load onto registers H or L is followed by an immediate transfer back and then out via the instruction PCHL, the test doesn't prove the existence of any registers but the PC or the HL combination.

If a user wants to check the existence and unique function of each register, he has to insert another instruction (such as increment register) between steps 3 and 4. This would not only cause an additional PC increment, but would also require another counter to verify the PCHL output data on the address bus.

Also, standard memory-referencing instructions needed to implement added instructions will cause the number of clock cycles to vary with each instruction. The cycle variation cannot be followed by the pattern genera-

tor, which runs off a fixed clock cycle or its multiples.

Instructions such as conditional subroutine calls or multiply/divide pose the same type of problems. They require different numbers of clock cycles depending on previously established conditions, as in the case of the divide instruction of the TMS 9900 from Texas Instruments Inc., Dallas Texas.

The test's weaknesses do point out two criteria for a useful tester. To thoroughly check the flexibility of the MPU, it should program in a high-level language like Fortran or Tektest 3 (for Tektronix's S-3260 large-scale-integrated tester). And the tester should use a built-in computer capable of interpreting strings of characters exactly compatible with the MPU's software, unlike algorithmic pattern generation.

Getting the goods

Another possible test procedure to consider is the "stored response" method. Here a known-good device is exercised, under nominal conditions of timing and voltage, with a set of input stimuli that corresponds to a given set of instructions and data. The resulting output data is transferred via a hardware/software routine to a storage device. Then each subsequent device is measured against this stored data on a go/no-go basis.

There are three questions that this procedure should answer:

- How good is the known-good device?
- What generates the input stimulus?
- How syntactically correct is the input stimulus—that is, do correctly composed statements conflict?

In the method's simplest form, the user creates the input stimulus in its entirety and enters it into the tester. Then the known-good device's output is recorded. Unfortunately, there is no guarantee that the known-good device functioned as predicted.

With older, simpler LSI devices (logic arrays and memories), it was reasonably easy to check the output data. With an MPU, a user cannot realistically work out all the right answers because of the enormous number of possibilities. Also, modifying the input stimulus in any way will obviously modify all subsequent output data.

There is a means of eliminating these problems: an interactive, monitored pattern-generation technique. It includes a dictionary to translate from the test language to a language the device under test understands. Now the MPU can be tested completely, filling in the gaps of other test systems. At Tektronix, this procedure has been trademarked as Wisest, which stands for Write, Interpret, Store, Execute, Save, Test.

Wisest uses the S-3260, a complete test system composed of a PDP 11/35, software, and a test fixture. In effect, the computer builds a pattern of variables drawn from the instruction set of the device under test. Then it checks the pattern for conditions defined by the user. It operates in two modes, with all software, stimuli preparation, and syntax checking accomplished in the secondary, background mode.

As Fig. 3 shows, a simple, interactive dictionary-writer routine generates a tester-to-MPU dictionary (a data set) for the device under test and stores it on a magnetic disc. Another set of software, the editor, employs that dictionary to enter into the test module mnemonics and arguments in the language of the MPU under test.

The peripherals labeled input media can control the editor. The feedback loop between test module and editor permits detection of syntax errors before generating the input stimulus. Users can easily enter and modify instructions and can change input stimuli. The monitoring capability lets testers find out (via the editor command STATUS) the MPU's response at any point.

Now the user can spot known-good devices instantly

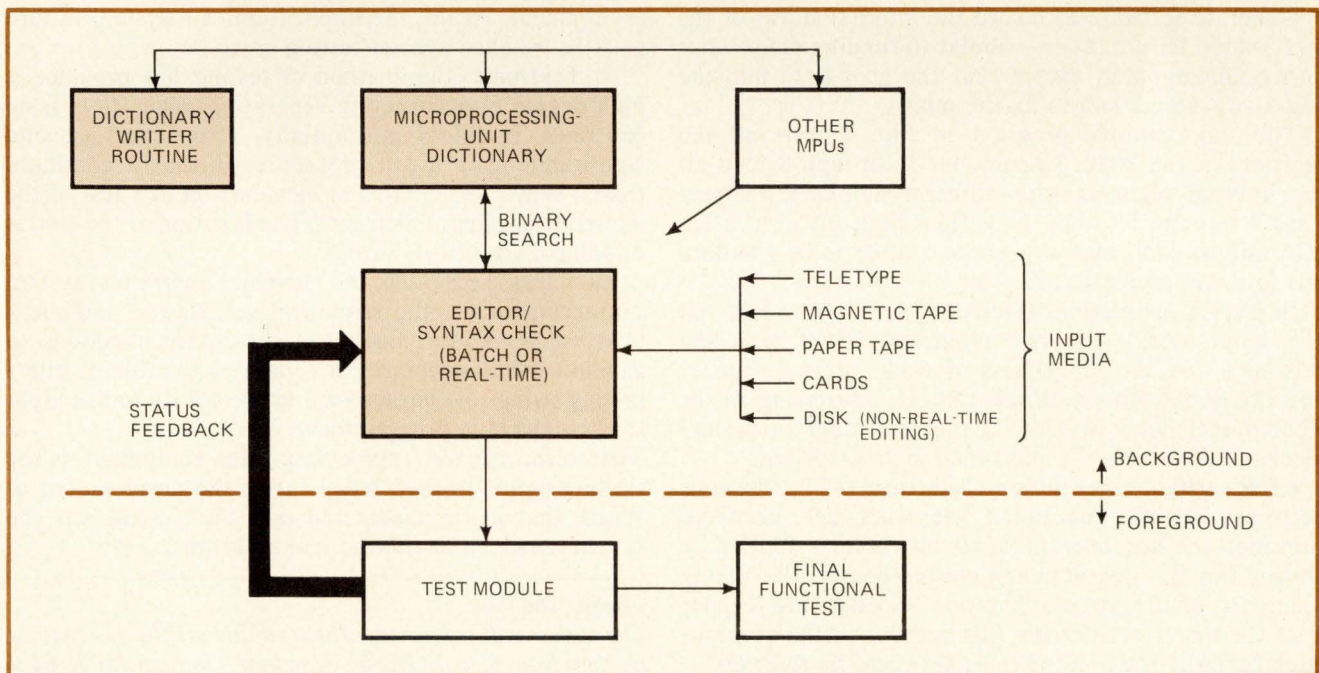

3. The Wisest flow. The Wisest test system eliminates the deficiencies of older microprocessor test methods. By using the MPU dictionary and an editor, the system can enter mnemonics and arguments in the native language of the MPU under test.

1	MVI	A	(000) ₈
2	MVI	B	(001) ₈
3	MVI	C	(002) ₈
4	MVI	D	(004) ₈
5	MVI	E	(010) ₈
6	MVI	H	(020) ₈
7	MVI	L	(040) ₈
8	LXI	SP	(125) ₈ , (252) ₈
9	MOV	M, A	
10	MOV	M, B	
11	MOV	M, C	
12	MOV	M, D	
13	MOV	M, E	
14	MOV	M, H	
15	MOV	M, L	

4. Register test. This short Wisest program verifies the existence and uniqueness of all 8080 registers. All together, the 15 instructions include 4,500 1s and 0s and 108 clock steps.

and store their responses for each instruction, and the test module can generate long sequences of instructions quite rapidly and in any syntactically correct order. The process is similar to that of debugging while writing computer programs. Moreover, changing from one processor type to another only requires writing a new instruction dictionary in the software language of the new microprocessor.

The best approach

The combination of stored response and monitored pattern-generation techniques helps implement the test approach of structural verification and analysis. There are three general principles to this approach:

- Verify the existence and uniqueness of every functional element of the MPU.
- Verify the various interactions that can occur between the elements of the MPU.
- Generate software to record the internal status of the MPU should failure occur—similar to running diagnostics on a minicomputer, except that the goal is to find the bad MPU, rather than to fix the mini.

The short sample program in Fig. 4 tests all the registers in the 8080. Instructions 1 through 8 load all the internal registers with different numbers. Instructions 9 through 15 store the various registers in location HL, and so each register's content appears on the data bus in the appropriate time slot.

In just 15 instructions (including 4,500 1s and 0s and 108 clock steps), the test program verifies both the existence and the uniqueness of each internal register and the 8080's ability to use the HL addressing mode. Similar techniques will verify that the other functional blocks in the MPU exist and function as predicted.

After verifying the MPU's architecture, the interactions between various functional elements are checked. Consider the sequence of 8080 instructions in Fig. 5. During the first instruction, a checkerboard (alternating 1s and 0s) of 125₈ in octal notation is loaded into register C of the CPU. Transferring this number to the accumulator partially tests interactions between the registers.

During instruction 3, the accumulator rotates left into carry, which clears carry and partially tests the arith-

1	MVI	C, 125 ₈	Put 0 1 0 1 0 1 0 1 in C
2	MOV	A, C	Transfer C to A: A←0 1 0 1 0 1 0 1
3	RLC		Rotate A left through carry C←0, A←1 0 1 0 1 0 1 0
4	ADD	C	A←1 1 1 1 1 1 1 1
5	PUSH	PSW	Store A & flags on stack

5. Interaction. Wisest software can generate this instruction sequence for checking interaction between functional elements of the 8080. A checkerboard pattern of 1s and 0s checks interrelationships between registers, accumulator, ALU, and data flags.

metic/logic unit. Adding the contents of C to the accumulator in instruction 4 will set A to 377₈ only if C was loaded with 125₈ and only if instructions 2, 3, and 4 worked. The first four instructions are then verified by storing the accumulator and flags on the stack of the MPU (a reserved area of memory).

This sequence proves the architecture exists and is unique. Only short instruction sequences are needed to verify the interrelationships. In fact, experience shows that about five tester instructions will verify the correct operation of one instruction for the device under test. The typical test patterns take about 5,000 steps (clock cycles) for both the 8080 and the 6800.

Once software of this type is established for testing microprocessors under nominal conditions, it is possible to program the tester to repeat the procedure for incremental changes in the operating environment—temperature, humidity, power supply voltage, and timing. Since test time consumed and interconnection costs for environmental testing are both high, it is necessary to carefully consider how much of this additional testing is required to assure proper operation in the anticipated environment. Again, the implication of a system failure must be weighed against testing cost.

At Tektronix, this method of testing has provided a high degree of accuracy in separating good MPUs from bad ones. It differs substantially from actual-use and algorithmic-pattern test procedures in that it continues from a simple verification of elements on to a test of the interrelationships of elements. The function of the MPU is examined, not just its form.

As well as the S-3260, the Fairchild Sentry test system can accommodate the structural verification and analysis test procedure. Each has the interconnections to handle I/O bus structures, a computer capable of interpreting strings of characters, and the ability to use high-level language in programming.

However, the test approach, not the equipment, is the starting point. In fact, it was after the development of Wisest that it was discovered that the S-3260 was the system on which to run the test procedure. □

Closing the loop

The author will answer questions on this article. He may be reached from 9 to 5, Pacific Standard Time, at (503) 644-0161. Written inquiries should be addressed to: Tektronix Inc., P. O. Box 500, Beaverton, Ore. 97077.

Test finds instantaneous power capability of resistors

by Fred Chitayat
Canadian Marconi Co., Montreal, Quebec, Canada

A watch, a variable dc power supply, and either a thermometer or a thermocouple with a readout can supply a resistor specification seldom given: the instantaneous power dissipation. Knowing this rating can save you valuable component space by avoiding selection of a resistor with higher continuous-operation specification than needed, or it can increase circuit reliability by prompting the selection of a component with a greater power rating to handle transients.

The key to the time-power product of any resistor is its thermal-circuit model, as in Fig. 1. The thermal behavior of the resistor is simulated by the thermal source P, the resistor's thermal resistance R_{θ} , and its thermal capacity C_{θ} . From the thermal circuit, we can derive equations analogous to its electronic counterpart by drawing thermal-power-to-current and temperature-to-voltage parallels.

For a constant power dissipation P, the steady-state temperature (T_{ss}) will be:

$$T_{ss} = T_A + R_{\theta}P \quad (1)$$

where T_A is the ambient temperature, usually room temperature, or about 24°C. But it may be higher within a piece of equipment.

The resistor temperature will respond exponentially to a step change in its power dissipation with a time constant τ , where:

$$\tau = R_{\theta}C_{\theta} \quad (2)$$

just as in the electronic analog of an RC charging network.

An instantaneous power P dissipated for a duration that is very short in relation to the thermal time constant

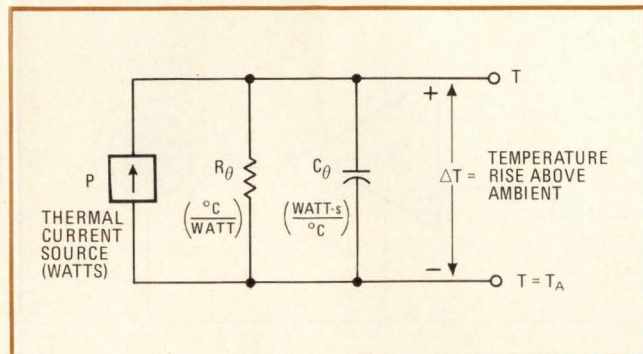

1. Thermal model. Circuit of resistor's thermal characteristics provides insight into its instantaneous power capabilities. Like its electronic analog, the thermal circuit charges to a temperature T with a time constant $\tau = RC$, where R and C are thermal parameters.

τ , will produce an instantaneous rise in the resistor temperature given by:

$$\Delta T = Pt/C_{\theta} \quad (3)$$

Once C_{θ} is known, you can find how high the instantaneous temperature of the resistor would be for a given pulse of energy dissipated.

For example, a test is to be made on a 1/2-watt, 150-ohm carbon-composition (type RC20) resistor. To measure the temperature of the resistor as a function of time when it is dissipating its rated power, 8.7 volts is applied across the resistor. That voltage causes it to dissipate the 1/2-watt continuous rating.

Starting from $t = 0$, when the 8.7 volts is first applied, the temperature of the resistor is plotted every 5 or 10 seconds up to about two minutes, depending on the accuracy desired. A thermocouple clamped to the resistor measures this most accurately, but securing a thermometer to the device should suffice. The graph and table of Fig. 2 show the results for this example.

Applying equation (1), we can find R_{θ} :

$$R_{\theta} = \frac{T_{ss} - T_A}{P} = \frac{55^{\circ} - 24^{\circ}}{0.5} = 62^{\circ} \text{ C/Watt}$$

From equation (2), we can find the value of the thermal capacity C_{θ} if we know the time constant τ . Just as in the electronic analog of the thermal model, the time constant can be found from the exponential equation of the curve in Fig. 2.

The basic equation of the exponential curve is:

$$T = (T_{ss} - T_A)(1 - e^{-t/R_{\theta}C_{\theta}}) + T_A \quad (4)$$

which can be checked by inserting the known limits of

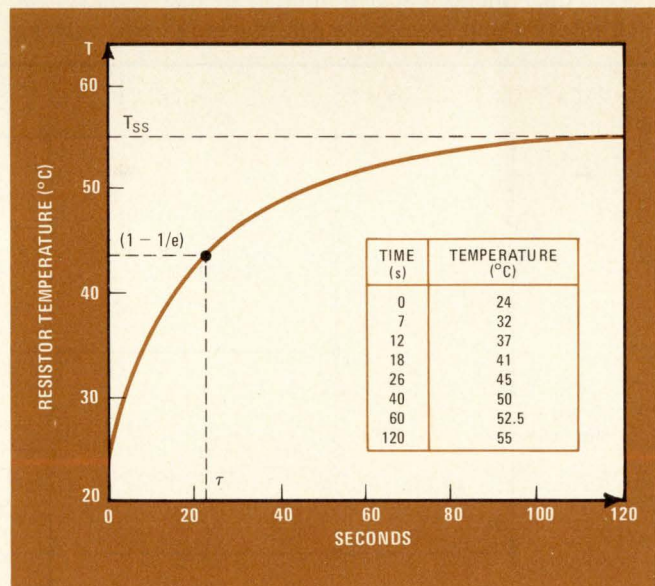

2. Rise in temperature. When 1/2 watt is dissipated in the resistor, the temperature gradually rises from 24°C ambience to a steady-state value of approximately 55°C. Plotting curve of temperature vs time permits calculation of thermal characteristics.

the curve into the equation. Since we know that in the steady state ($t \rightarrow \infty$) the exponential term in the parentheses tends to zero, equation (4) then simplifies to $T = T_{ss}$. At the other extreme, when $t = 0$, the exponential term becomes unity, and equation (4) reduces to $T = T_A$.

When $t = \tau$ (the period of one time constant), the temperature has risen to $1 - 1/e$, or 0.63, of its steady-state value. By substitution in equation (4), this value comes to 43.6° . Reading off the curve, τ is the value of t at 43.6° , which is about 23 seconds.

The value of thermal capacity can now be found:

$$C_\theta = \tau/R_\theta \text{ or } (23 \text{ s})/(62^\circ\text{C/W}) = .37 \text{ W-s}/^\circ\text{C}$$

Before solving for the time-power product Pt , the absolute maximum power dissipation allowed in the resistor by the specified maximum voltage rating must be calculated. In the case of the type RC20 $\frac{1}{2}$ -W resistor,

the manufacturer rates the device at a maximum voltage of 350 v. The absolute maximum power would then be $P = V^2/R = 350^2/150 = 817 \text{ w}$.

Limiting the instantaneous temperature in the resistor to a safe value of 75°C (well below the 125°C point of destruction), the rise above ambient, or ΔT is $75^\circ - 24^\circ = 51^\circ\text{C}$ maximum. Solving equation (3) for the amount of time that 817 watts can be dissipated in the resistor:

$$51^\circ = Pt/C_\theta = 817t/.37$$

gives $t = 23$ milliseconds and $Pt = 18.9 \text{ w-s}$

Any other combination of P and t maintaining the same product of 18.9 w-s will raise the temperature of the resistor to 75°C . For example, 100 watts can be dissipated in the resistor for 189 milliseconds, and 10 W can be dissipated for 1.89 s. Following the steps outlined above, this procedure can be applied to any resistor to determine instantaneous power capability. \square

Calculator notes

SR-56 sequence timer gives audible alarm

by Tom Martin
Rockwell International, Dallas, Texas

Programming your calculator as a timer is easy, but devising a way to trigger an external alarm that avoids surgery for interconnections takes a little ingenuity. With a photocell detector circuit, you can have the timer trigger the alarm with only the light of the display.

An SR-56, programmed as shown in the table, can time up to eight different intervals sequentially, each as long as 99 minutes and 99 seconds. The basic timing scheme decrements a scaled number by one in a loop for each interval and branches upon reaching zero, pausing

for display before going on to the next interval.

During the timing of each interval, the execution of a fix-zero command holds the display dark except for the right-most digit. At the end of each interval, an algorithm dividing 8 by 9 causes the display of .8888888888. This figure's light triggers the photocell detector.

A cadmium-sulfide photocell taped to or mounted above the calculator at the left of the display is illuminated only by the leading digits of a 10-digit number. The simple trigger circuit shown in the figure makes the SR-56 sound a Sonalert alarm for the duration of the pause function—just under a second.

The circuit is built around a 741 operational amplifier but any general-purpose unit can be used. The op amp is configured as a comparator, and a sensitivity control adjusts for different photocell responses and ambient-lighting conditions. The value of R_1 , given as 4.7 kilohms, may have to be changed, depending on the

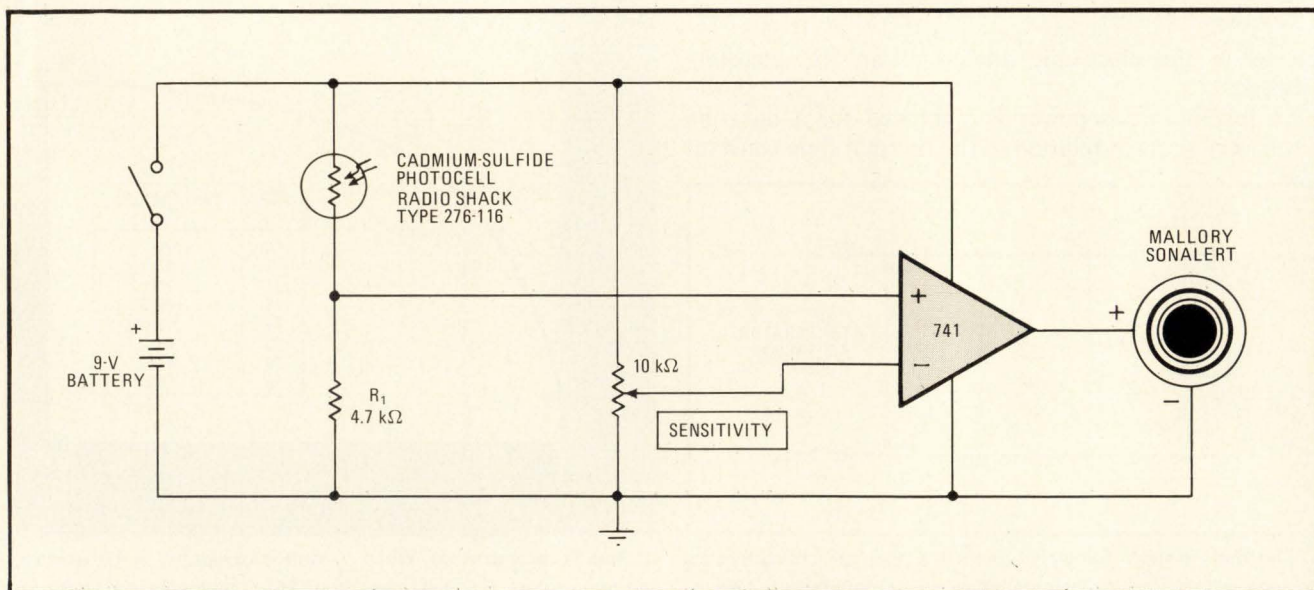

Photocell trigger. Cadmium-sulfide photocell, illuminated by digits on left side of calculator display, trips comparator, turning on Sonalert. Operational amplifier can be any general-purpose type. Sensitivity control should be set so that only display digits trigger alarm.

When and why to build your own DIP switch

You need a dual in-line switch for a circuit where the switch positions won't change often? Then it's cheaper and better to make your own DIP switch, says Louis Matte of Lowell, Mass. **Just solder one or more short links of bus wire across a DIP component carrier**, which then plugs directly into a wire-wrapped board or a DIP socket. To toggle it, pull up the carrier, flip it around 180°, and re-insert it. A 14-pin carrier makes up to a four-pole double-throw switch, a 16-pin carrier makes up to a 5pdt switch, and if you plug a 14-pin carrier into a 16-pin socket, the carrier has four possible orientations and can be wired as a 3p3t or dp4t switch. Break-before-make switching action is inherent, of course, and the carrier-switch also dodges the danger of being toggled in the wrong sequence. Better yet, current capacity is limited only by the DIP socket and board wiring, not by the small contact area found inside commercial DIP switches.

An easy way to find out what I²L can do for you

Alas, most off-the-shelf integrated-injection-logic devices are microprocessors and memories—so if you wanted to use I²L's high density, fast speed, and low power for some other function, you've been forced to take your chances with an expensive custom-designed chip. But no more. Micro Components Corp., a small semiconductor firm in Cranston, R.I., has an alternative and more economical solution. It's **selling more than 30 I²L structures as bondable breadboarding elements, so that you can now prototype an I²L design and modify it cheaply and easily**. The line includes standard digital building blocks like shift registers, flip-flops, OR and NOR gates, a divide-by-2 device, a ring oscillator, and a seven-stage inverter chain.

Ispice program adds to its talents for circuit analysis

What with the ever-increasing demands placed on circuit performance and the escalating costs of design and prototyping, the power of circuit-analysis computer programs is continually being extended with added capabilities. For example, take Ispice (Interactive Simulation Program with Integrated-Circuit Emphasis), a program available through the international time-sharing computer services of National CSS, Norwalk, Conn. **Just added to Ispice's ac/dc, transient, and temperature analyses are a sensitivity analysis and a worst-case analysis**. The first automatically tags those circuit values that change sign, and the second lets you select the components to be varied.

All you need to know about printed circuits

Whether you buy printed-circuit boards or design them, you'll want to get a copy of the newly updated "Printed Wiring Design Guide," a 600-page volume that covers all aspects of designing rigid and flexible single-sided boards, as well as double-sided and multilayer boards. About 150 pages of added material **update the specifications for printed boards and provide new information on design layout and documentation**. In the works is more new data—on double-sided boards and computer-aided design. Copies of the guide are available from the Institute of Printed Circuits, 1717 Howard St., Evanston, Ill. 60202. Cost to members is \$50, \$100 to nonmembers.

Lucinda Mattera

HP displays.

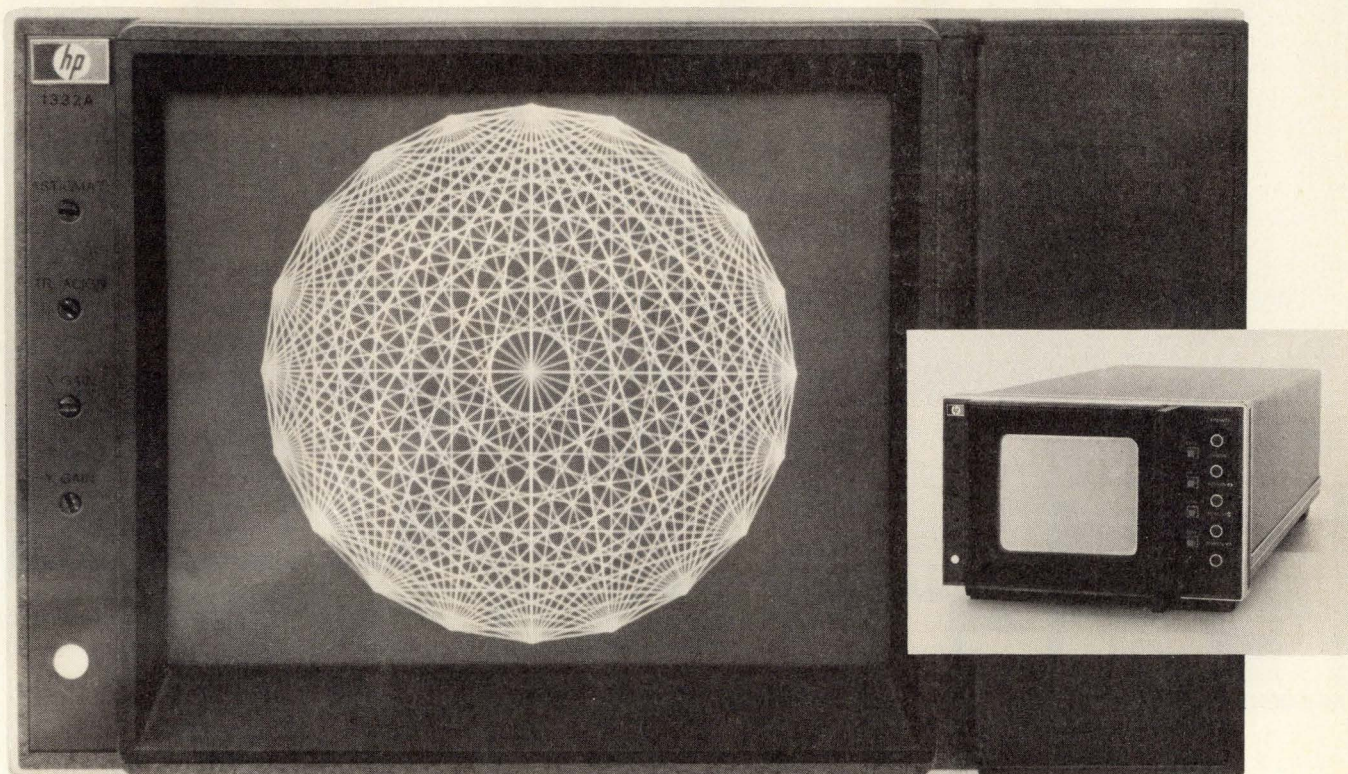

Because your system deserves a bright, sharp image.

You put a lot into each OEM system: good circuit design, quality components, careful testing. But end users will judge it by the information they get from the display. They expect bright, sharp images. That's why HP's 1332A, 1333A, and 1335A CRT displays make excellent choices for all types of systems—from spectrum, network, and chemical analyzers, to automatic test systems.

Each display has a very small spot size that focuses uniformly over the complete viewing area, regardless of writing speeds or intensity level. This eliminates the need to refocus at each intensity setting and assures crisp images, even around the outer edges of the screen. Fine image detail with excellent contrast and uniformity make them particularly well suited for applications involving complex graphics, especially those with alphanumeric data.

The 1335A, a variable-persistence, storage, and non-storage display, introduces a totally new CRT design optimized exclusively for information display. It offers exceptionally good resolution over the entire 8 x 10 cm screen. And the 1335A is versatile too. Any operating mode—erase, store, write, conventional, or variable persistence—can be selected with manual front-panel controls, remote program inputs, or a combination of both. Manual controls can be inhibited entirely during remote operations. The 1335A is a welcome

addition to medical and instrumentation systems.

OEMs who need a larger viewing area and a brighter image at faster scan rates like the 1332A. They appreciate its 9.6 x 11.9 cm viewing area, its superior performance, and the ease with which the 1332A, like the others, integrates into a variety of racks and cabinets.

For photographic recording of displayed data, the new 1333A offers new performance levels. Its extremely small spot size of 0.20 mm (0.008 in.) provides the exceptional quality necessary for easy and accurate photo evaluation. And its 8 x 10 cm screen allows reproduction on Polaroid film with very little optic reduction. For convenience, all frequently used controls on all of these displays have been placed on the front panel for maximum accessibility.

Which display best fits your requirements? Let your local HP field engineer help you decide. Or write for specific details. We'll help you pick a display that makes your system look as good as it actually is.

085/9 A

HEWLETT  PACKARD

Sales and service from 172 offices in 65 countries.
1507 Page Mill Road, Palo Alto, California 94304

You Don't Have To Beg, Borrow Or Buy...

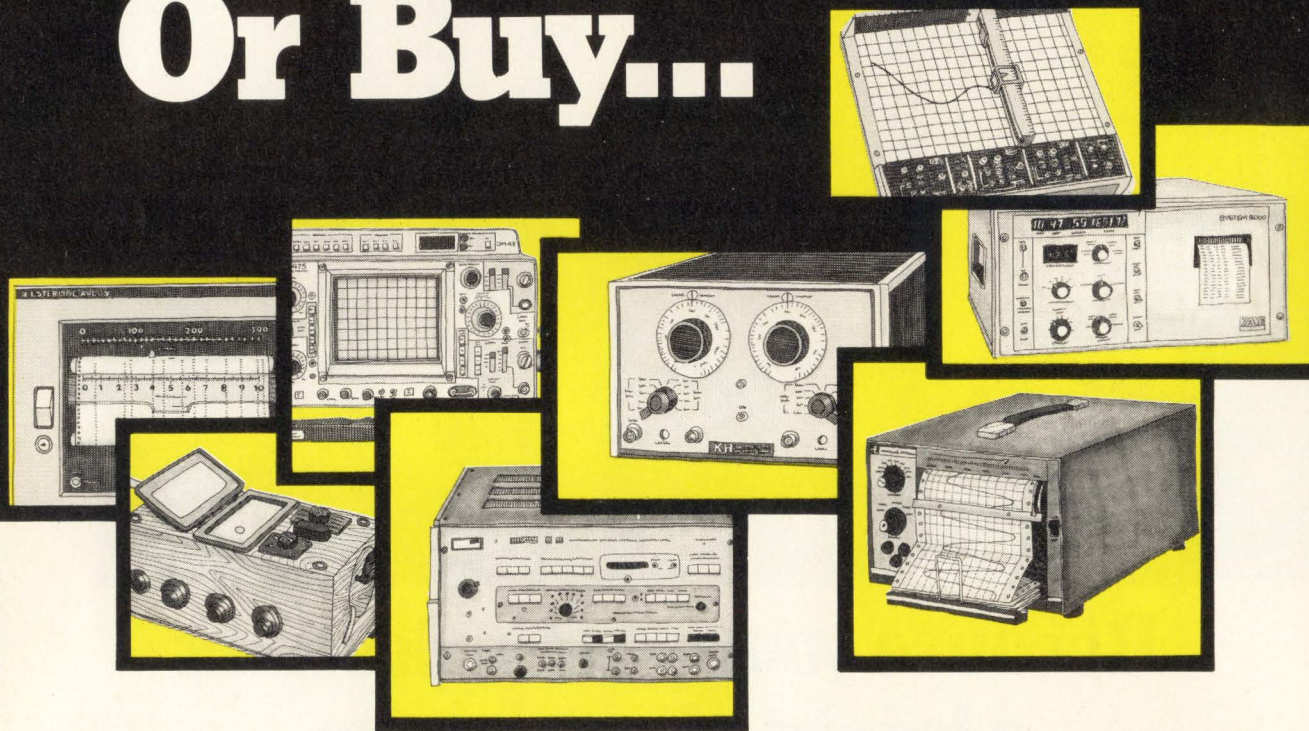

Rent'em From GE

Short or long-term instrument rentals give you flexibility and economy.

GE has over 9,000 instruments available for immediate shipment: □ Tek Scopes □ Biddle Megger Insulation Testers □ H-P Signal Generators □ Honeywell Oscillographs □ Complete Data Systems □ Esterline Angus Recorders □ GE Chart Recorders □ Modems □ Communication Terminals . . . all calibrated to the manufacturer's specs.

We have over 100 Sales/Service Centers,

and one of them is near you. In addition to maintaining our Rental Inventory, they can also repair and calibrate your own equipment.

Don't borrow someone else's GE Rental Catalog. **Call collect (518) 372-9900** or your nearest Sales/Service Center.

**Quick-rental[®]
instruments**

GENERAL  ELECTRIC

ALA. BIRMINGHAM (205) 925-3101 • ARIZ. PHOENIX (602) 278-8515 or 8516, TUSCON (602) 294-3139 • CAL. LOS ANGELES (213) 674-7900, SAN FRANCISCO (415) 436-9260 • COL. DENVER (303) 371-1260 • CONN. SOUTHINGTON (203) 261-4059 • FLA. JACKSONVILLE (904) 751-0610 • GA. ATLANTA (404) 458-2231 • ILL. CHICAGO (219) 933-4500 • IND. INDIANAPOLIS (317) 639-1565 • KY. LOUISVILLE (502) 452-3311 • LA. NEW ORLEANS (504) 367-6528 • MD. BALTIMORE (301) 837-4500 • MASS. BOSTON (617) 396-9600 Ext. 160, SPRINGFIELD (413) 781-1111 • MICH. DETROIT (313) 285-6700 Ext. 212 or 209 • MINN. MINNEAPOLIS (612) 522-4396 • MO. KANSAS CITY (816) 231-4377, ST. LOUIS (314) 965-7115 • N.J. CLIFTON (201) 471-6556 • N.Y. BUFFALO (716) 876-1200, SCHENECTADY (518) 385-2195 • N.Y.C. CLIFTON, N.J. (201) 471-6556 • N.C. CHARLOTTE (704) 525-0311 • OH. CINCINNATI (513) 874-8512, CLEVELAND (216) 523-6382, TOLEDO (419) 691-3501 • OR. PORTLAND (503) 221-5101 • PA. PHILADELPHIA (609) 424-4450, PITTSBURGH (412) 462-7400 • TEX. DALLAS (214) 357-7341, HOUSTON (713) 672-3569 • VA. RICHMOND (804) 232-6733 • WASH. SEATTLE (206) 854-0211 • W.V. CHARLESTON (304) 346-9421 • WISC. MILWAUKEE (414) 744-0110 • PUERTO RICO PONCE (809) 843-4225.

New products

Chip programs most CRT functions

MOS LSI device housed in 40-pin dual in-line package can replace 40 to 60 integrated circuits in generating all of terminal's timing signals

by Bruce LeBoss, New York bureau manager

While many leading semiconductor manufacturers are developing circuits that will integrate a healthy portion of a cathode-ray-tube terminal's electronics onto just one chip, Standard Microsystems Corp. of Hauppauge, N.Y., looks like it will be the first to make such a chip available off the shelf. The company will be supplying samples of its user-programmable CRT video timer-controller chip later this month and plans to market it in production quantities early this summer.

Designated the 5027, the metal-oxide-semiconductor device contains—as shown below—the logic functions required to generate all the timing signals for the presentation and formatting of interlaced and

noninterlaced video data on CRT monitors. But unlike some of the firm's other chips, which are revolutionary in concept, the CRT chip "is an evolutionary product," says Standard Microsystems' senior vice president, Gerry Gollub. "It doesn't perform any functions that aren't being done now. It simply replaces a section of what's already in wide use, but does it all on one chip." So Gollub sees the chip's market "taking off almost immediately on a continuously building volume curve."

He claims the 40-pin dual in-line package can replace upwards of 60 but typically 40 integrated circuits. It will be priced at \$50 in single quantities, \$25 in 1,000-piece lots,

and \$10 to \$12 at 5,000 units and above. In itself, therefore, it may cut component costs only slightly, says sales vice president Art Sidorsky, but "there also will be a significant savings in incoming inspection, production-test and assembly costs, and inventory."

Perhaps more important than the cost savings, the 5027 and its planned counterparts from other vendors should save on printed-circuit board space. "It will keep CRT display electronics on one card," says Gollub. "And, because it's programmable, it will enable a manufacturer of CRT terminals to build a universal video card for the different character displays that his marketing department sells. Pre-

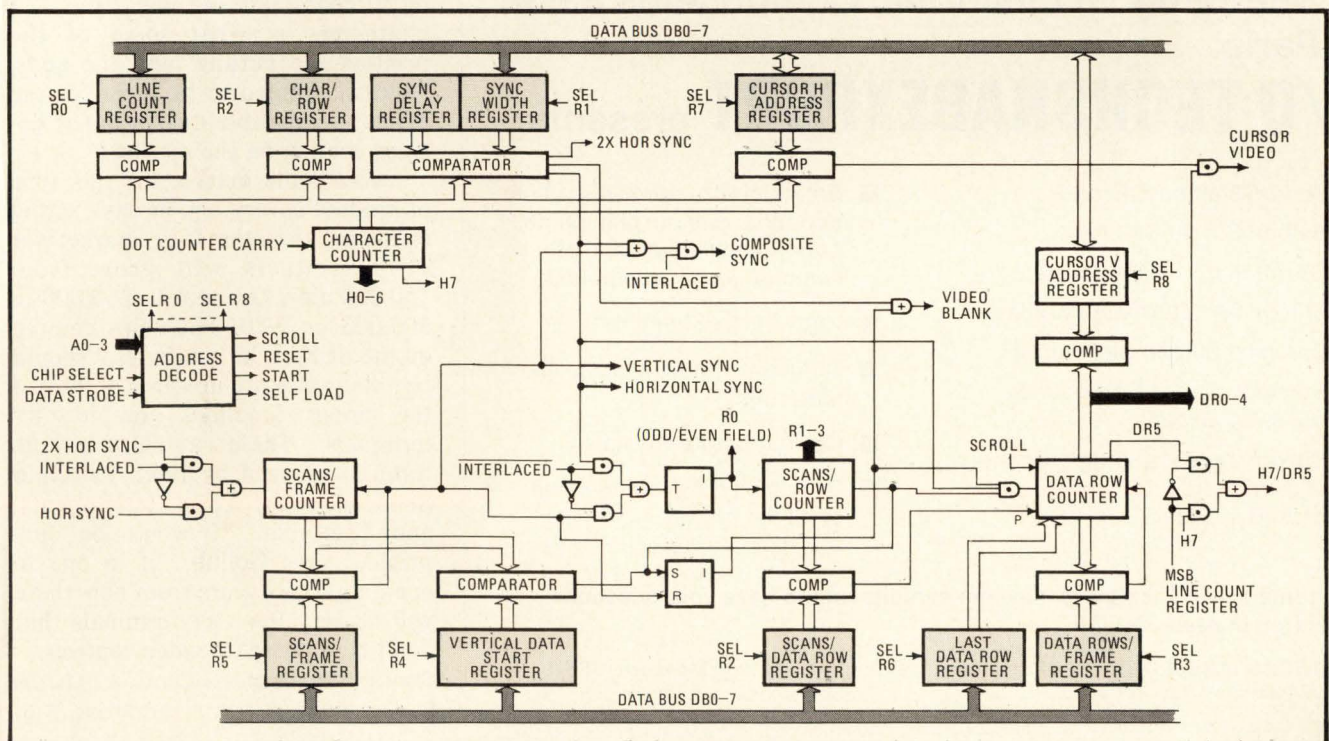



March 31 to April 6, 1977

at International Electronic Components Salon
in Paris

V/O TECHSNABEXPORT presents:

- Polycrystalline Silicon
- Silicon Single Crystals
- Germanium Single Crystals
- Silicon and Germanium Slices
- Epitaxial Silicon Structures
- Semiconductor Compounds of $A_{III}B_V$ Group
- Polycrystals and Single Crystals of Semiconductor Compounds of $A_{III}B_{VI}$ Group
- Epitaxial Structures of gallium arsenide, gallium phosphide, cadmium sulphide and other semiconductor compounds
- High-Purity Elements
- Diffusants and Other Auxiliary Materials
- Optical Single Crystals
- Crucibles for growing single crystals

Welcome to our Display, to view the exhibits and to have your questions answered in every detail!

V/O TECHSNABEXPORT · 32/34 Smolenskaya-Sennaya · 121200 Moscow · USSR
Tel. 244-32-85 · Telex 7628



Techsnabexport

Sole Agents in France:
COPCI · 44 Rue La Boétie · 75008 Paris
Tel. 563 11 22 · Telex 280837

120 Circle 120 on reader service card

New products

viously, a manufacturer would have to design a different set of logic for each type of display."

Programming is done by loading seven 8-bit control registers directly off an 8-bit bidirectional data bus. Four register-address lines and a chip-select line provide complete microprocessor compatibility for program-control setup. The chip may also be "bootstrap loaded" by an external programmable read-only memory tied on the data bus, or formatting may be programmed by an optional read-only-memory mask. With the exception of the dot counter, all frame formatting is totally user-programmable. This includes items such as horizontal, vertical and composite synchronization, characters per data row, data rows per frame, and raster scans per data row or frame.

Use of the company's Coplamos n-channel technology "provided a high density for making a product that's economically feasible," Gollub says. It also produced a high-speed chip capable of generating as many as 132 characters per line and as many as 64 data rows per frame. Most CRT terminals on the market, Gollub notes, display about 25 rows of 80 characters per line. "But 132 characters is what some of the printers are putting out," he adds, "and we wanted to be there for the printer-compatible CRT-terminal designs coming on the market."

Overall, the market for this type of product is very big, he says, citing estimates that the U.S. market for CRT terminals will grow from 150,000 units this year to 250,000 to 300,000 in 1980. The chips coming on the market, he continues, "should be able to capture upwards of 90% of the circuit functions now in CRT terminals." These CRT chips include those announced by Intel, Fairchild Semiconductor, Texas Instruments, and Motorola. "I won't be surprised," says Gollub, "if in one to one-and-a-half years from now there will be very few CRT terminals that don't have some LSI video controls."

Standard Microsystems Corp., 35 Marcus Blvd., Hauppauge, N.Y. 11787. Phone (516) 273-3100 [338]

Current Sensing-- The New Way by F.W. Bell, Inc.

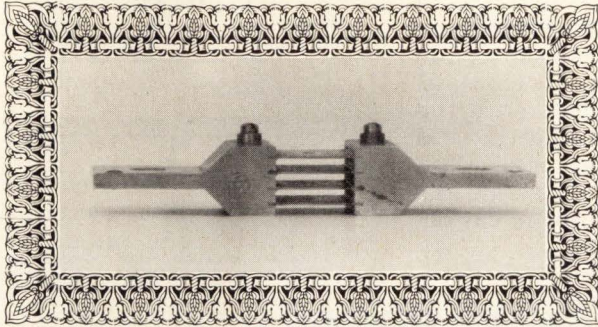

the shunt, used for years to measure electric current

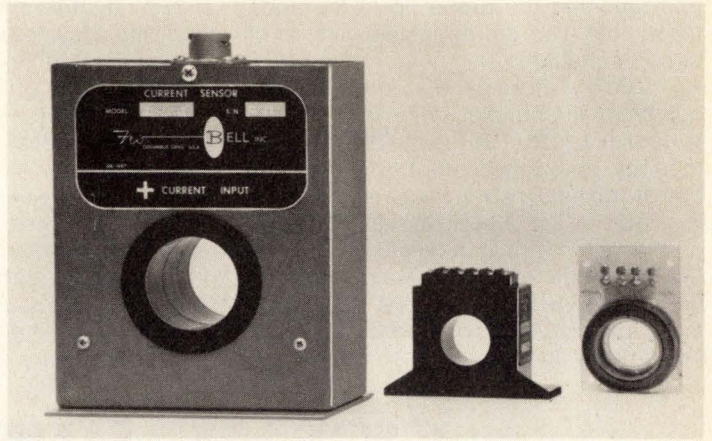

the Bell current sensors, used for years in special applications, now replacing the shunt

SHUNT

BELL CURRENT SENSOR

none, must be provided externally	isolation	yes, intrinsically isolated in the kV range
yes, the shunt resistance is in series in the measured circuit adversely altering some circuit characteristics	circuit influences	none on dc, virtually none on ac (under 1 μ H)
yes, dc to kHz	ac, dc operation	yes, dc to kHz
good, affected by shunt heating at high currents, conductive dirt deposits, and corrosion	accuracy	excellent, some may be affected by external magnetic fields (Bell models are extremely insensitive to this)
low millivolt range, non-isolated	output	high millivolt range, isolated
the measured circuit must be broken and two terminals added	installation	the measured circuit must be passed through the aperture
wide measurement range	current range	wide measurement range
tens of dollars	cost	tens of dollars

From traction motors to micro-processors, Bell non-contact current sensors are replacing shunts. They are phasing out current transformers and ferromagnetic saturation devices too. In the OEM, Research & Development, and Systems Project areas the new sensors are proving their advantages. Applications include mass transportation, process control, motor control, overload sensors and more.

The only coupling between the Bell sensor and the current carrying conductor is magnetic. This offers the advantages of complete isolation, zero dc and negligible ac insertion loss. The common measurement problems associated with shunts (lack of isolation, high power dissipation and excessive heating effects) are totally eliminated. Also the dangerous shock hazard of shunts is eliminated by the safe non-contact operation.

Contact F. W. Bell, Inc. to receive a complete information package. There are a number of Bell current sensor models to meet your needs. If you are interested in clamp-on current measuring probes, Bell is the leading supplier.

F.W. BELL, INC.
4949 Freeway Dr. E.
Columbus, Ohio 43229
phone 614/888-7501



A subsidiary of the Arnold Engineering Company

Logic Probe 1 is a compact, enormously versatile design, test and troubleshooting tool for all types of digital applications. By simply connecting the clip leads to the circuit's power supply, setting a switch to the proper logic family and touching the probe tip to the node under test, you get an instant picture of circuit conditions.

LP-1's unique circuitry—which combines the functions of level detector, pulse detector, pulse stretcher and memory—makes one-shot, low-rep-rate, narrow pulses—nearly impossible to see, even with a fast scope—easily detectable and visible. HI LED indicates logic "1", LO LED, logic "0", and all pulse transitions—positive and negative as narrow as 50 nanoseconds—are stretched to 1/3 second and displayed on the PULSE LED.

By setting the PULSE/MEMORY switch to MEMORY, single-shot events as well as low-rep-rate events can be stored indefinitely.

While high-frequency (5-10MHz) signals cause the "pulse" LED to blink at a 3Hz rate, there is an additional indication with unsymmetrical pulses: with duty cycles of less than 30%, the LO LED will light, while duty cycles over 70% will light the HI LED.

In all modes, high input impedance (100K) virtually eliminates loading problems, and impedance is constant for all states. LP-1 also features over-voltage and reverse-polarity protection. Housed in a rugged, high-impact plastic case with strain-relieved power cables, it's built to provide reliable day-in, day-out service for years to come.

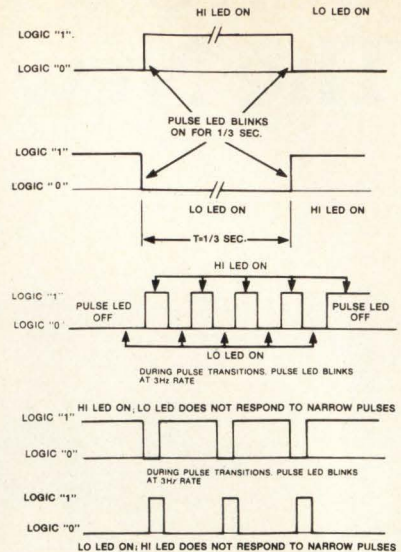

CSC'S MULTI-FAMILY LOGIC PROBE 1. AT \$44.95, IT DIGS UP A LOT OF INFORMATION WITHOUT BURYING YOUR BUDGET.

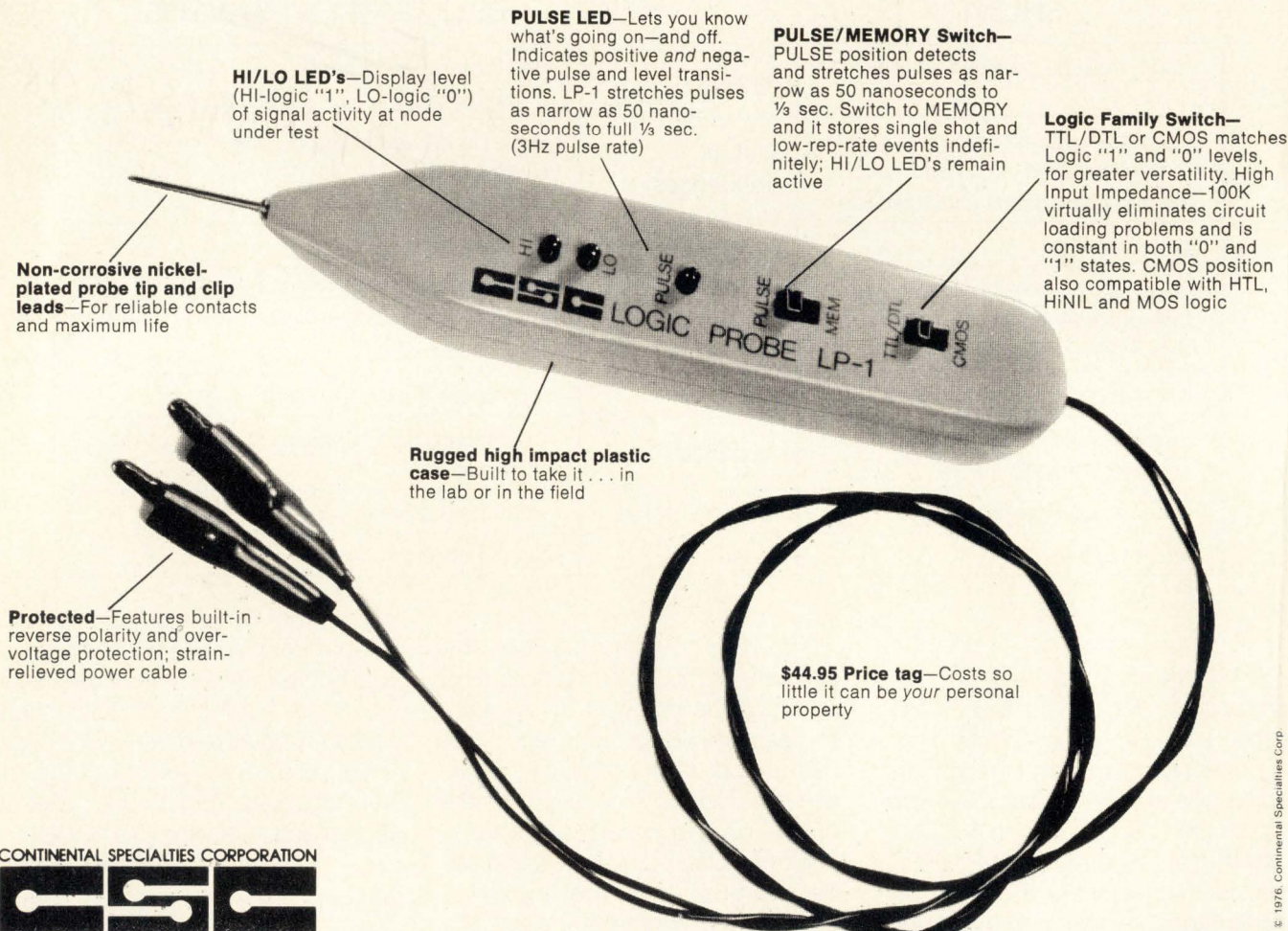

HI/LO LED's—Display level (HI-logic "1", LO-logic "0") of signal activity at node under test

PULSE LED—Lets you know what's going on—and off. Indicates positive and negative pulse and level transitions. LP-1 stretches pulses as narrow as 50 nanoseconds to full 1/3 sec. (3Hz pulse rate)

PULSE/MEMORY Switch—PULSE position detects and stretches pulses as narrow as 1/3 sec. Switch to MEMORY and it stores single shot and low-rep-rate events indefinitely; HI/LO LED's remain active

Logic Family Switch—TTL/DTL or CMOS matches Logic "1" and "0" levels, for greater versatility. High Input Impedance—100K virtually eliminates circuit loading problems and is constant in both "0" and "1" states. CMOS position also compatible with HTL, HiNIL and MOS logic

Non-corrosive nickel-plated probe tip and clip leads—For reliable contacts and maximum life

Rugged high impact plastic case—Built to take it... in the lab or in the field

Protected—Features built-in reverse polarity and over-voltage protection; strain-relieved power cable

\$44.95 Price tag—Costs so little it can be your personal property

CONTINENTAL SPECIALTIES CORPORATION



EASY DOES IT

44 Kendall St., Box 1942 New Haven, CT 06509
TWX: 710-465-1227
West Coast office: Box 7809, San Francisco, CA 94119
TWX: 910-372-7992

See your CSC dealer or call 203-624-3103 (East Coast) or 415-421-8872 (West Coast) 9 AM to 5 PM local time. Major credit cards accepted. Add \$2.50 for shipping and handling in the U.S. and Canada on direct orders of \$50.00 or less; \$3.00 for orders over \$50.00. On all foreign orders add 15% to cover shipping and handling.

Testing entire microcomputer board

Low-cost system from Fluke Trendar checks out microprocessor and peripheral logic together, exercising them at their normal speed

by Bernard Cole, San Francisco bureau manager

Using a "merged sequencing" technique, Fluke Trendar Corp. has developed what it says is the industry's first low-cost digital board tester specifically designed for microcomputer boards. Designated the 3040A, the system tests the microprocessor and the rest of the board together—as a unit—at normal operating speed.

Don Allen, vice president of marketing, explains that most low-cost test systems use either a stored sequence (truth table) or a pseudo-random automatic sequence to exercise the processor and board separately. These tests are usually conducted at a fraction of the system's normal operating speed—a few thousand or hundred thousand input words per second for user-defined truth tables or 1 or 2 kilohertz for auto-sequencing.

For future, too. With the model 3040A, either approach can be used on the board at speeds at least 1,000 times faster. User-defined test sequences can be processed at rates up to 1.5 million input words per second, "more than a match for the instruction-execution times of today's microcomputer boards," says Allen, "with enough left over for testing microprocessors not yet announced."

At the same time, the 3040A Logictester can also run automatic sequences at rates up to 5 megahertz. In addition, it enables the programmer to intermix both programming techniques, thereby significantly reducing programming time and gaining a higher test confidence, he says. A powerful set of auto-sequences minimizes programming of the large numbers of

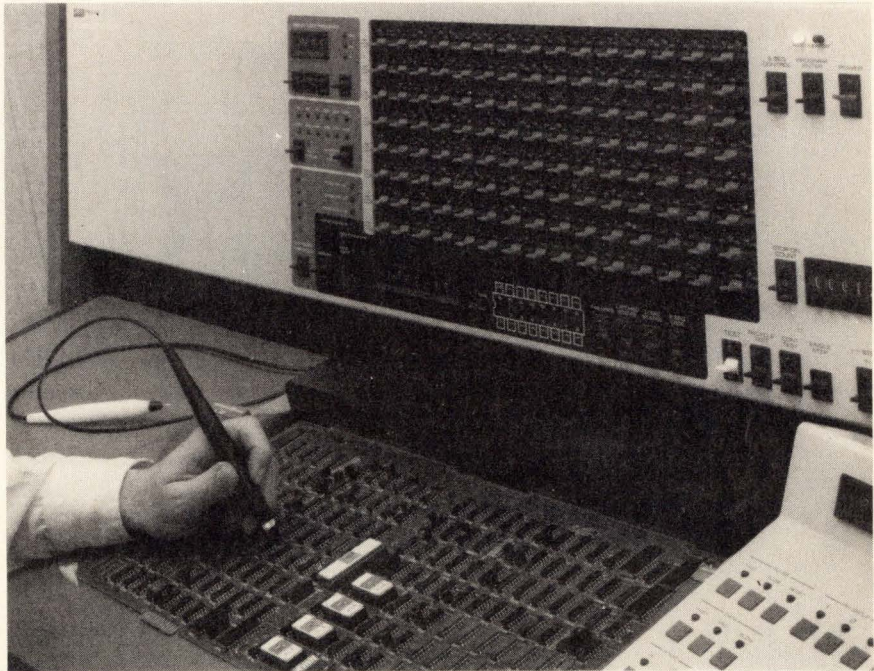

conventional boards that do not need manually defined bit patterns.

The only kind of test system that even approaches this performance, claims Allen, is the minicomputer-controlled multiprocessor used by high-volume manufacturers. Prices start at about \$250,000 for these systems, which use semicustomized test heads and procedures. "We offer a standard system capable of testing any kind of advanced digital logic board for about a tenth the cost," says Allen. Depending on options, the Logictester ranges in price from \$60,000 to \$95,000.

16-bit Pace. The 3040A provides substantially the same performance as the high-end testers by using a 16-bit p-channel metal-oxide-semiconductor Pace microprocessor from National Semiconductor Corp. for

control. The system includes a keyboard and display, floppy disk, input/output and detect circuitry, 512,000 bits of random-access memory, and three special-purpose high-speed processors built with Schottky transistor-transistor logic for pin control and sequencing.

In addition to the unusual capability of combining fast stored and automatic sequences, the 3040A provides interface and control capabilities for dynamic large-scale-integrated-circuit logic. For example, board-mounted clock oscillators no longer need be used for testing, says Allen, since the Logictester allows the unit under test to clock the tester and control the instant of test where appropriate. "Often, it's necessary to keep the clock from running below a certain rate so that a RAM, for exam-

Introducing
**BROAD BAND
 MODULAR
 SWITCHING
 SYSTEMS**

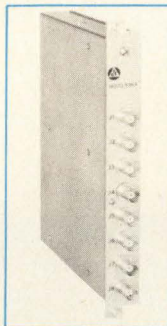

1 x 8 Reed Switch

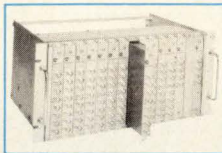

4 x 92 Solid-State Switch

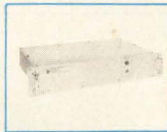

Digital Interface Unit

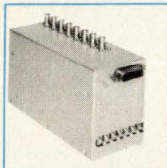

7 x 8 Reed Relay Matrix

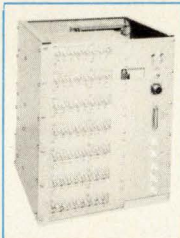

5 x 56 Reed Relay Matrix

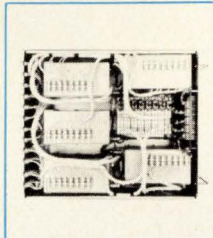

8 x 50 Solid State Matrix

from
**FREQUENCY
 ELECTRONICS**



Perfect for use in

- Automatic Test Equipment
- HF Receiving Systems
- Intercommunications
- High-Speed Data Transmission
- Video Distribution

This is a broad line. All computer-controllable. Each a superior performer.

Combining high-frequency transmission line techniques with state-of-the-art switching elements (reed relays, FET's or PIN diodes, depending upon frequency and distortion requirements).

Manufactured with the same care we're famous for in our high-reliability spaceborne equipment. Plus modular packaging, which facilitates expansion while enhancing maintainability.

And each system comes complete, with power supply, digital interface converter, and I/O equipment.

Get the whole story. Ask for our new catalog. It's yours upon request.

With switching systems, as with everything else at Frequency Electronics, there's No Compromise with Quality!

Frequency Electronics, Inc.
 3 Delaware Dr., New Hyde Park, N.Y. 11040 • (516) 328-0100

New products

ple, will not lose its data," he says.

"With the standard approach, in order to get the data, it is necessary to do exactly the thing that causes loss of data—slow the clock rate." This is overcome in the 3040A I/O and fail-detect circuitry with a specially designed 256-bit-wide and 1-bit-deep logic analyzer that freezes the data from I/O counters affecting the clock rate.

Programming. Although the Logictester runs the same test sequences that were formerly available only on conventional minicomputer-controlled testers, the usual software problems associated with computers have been eliminated, Allen adds.

"Through a calculator-like program panel, all sequence programs are entered directly into tester memory. The tester uses a firmware editor-assembler that is fully transparent to the test engineer," he says. For example, an unconditional jump is programmed simply by depressing a key labeled "Go to Step X" and entering a step number for X. Similar procedures are used to provide functions like conditional branches, loops, and subroutines. Programs are stored on the floppy disk, and the disk operating system is provided in firmware so the operator merely uses the "Enter" and "Record" keys for disk operation.

The 3040A includes diagnostic application of cyclic redundancy checks to testing of digital boards. Long used for error checking in data-transmission applications, CRC signatures can now be used for go/no-go tests and for mode diagnostics. In addition, the Logictester can use a known good reference board for faster troubleshooting.

It also eliminates the need for a data base of expected responses. Processor-guided fault isolation is provided by the 3040A's Autotrack option, supplemented by such semi-automatic diagnostic aids as board-to-board measurements, IC comparison, logic probes, and full display of I/O and IC logic states. The 3040A tester is offered in both 128- and 240-pin versions.

Fluke Trendar Corp., 630 Clyde Ave., Mountain View, Calif. 94043 [339]

The \$995* Solution to a \$100,000 Problem— Superpac!

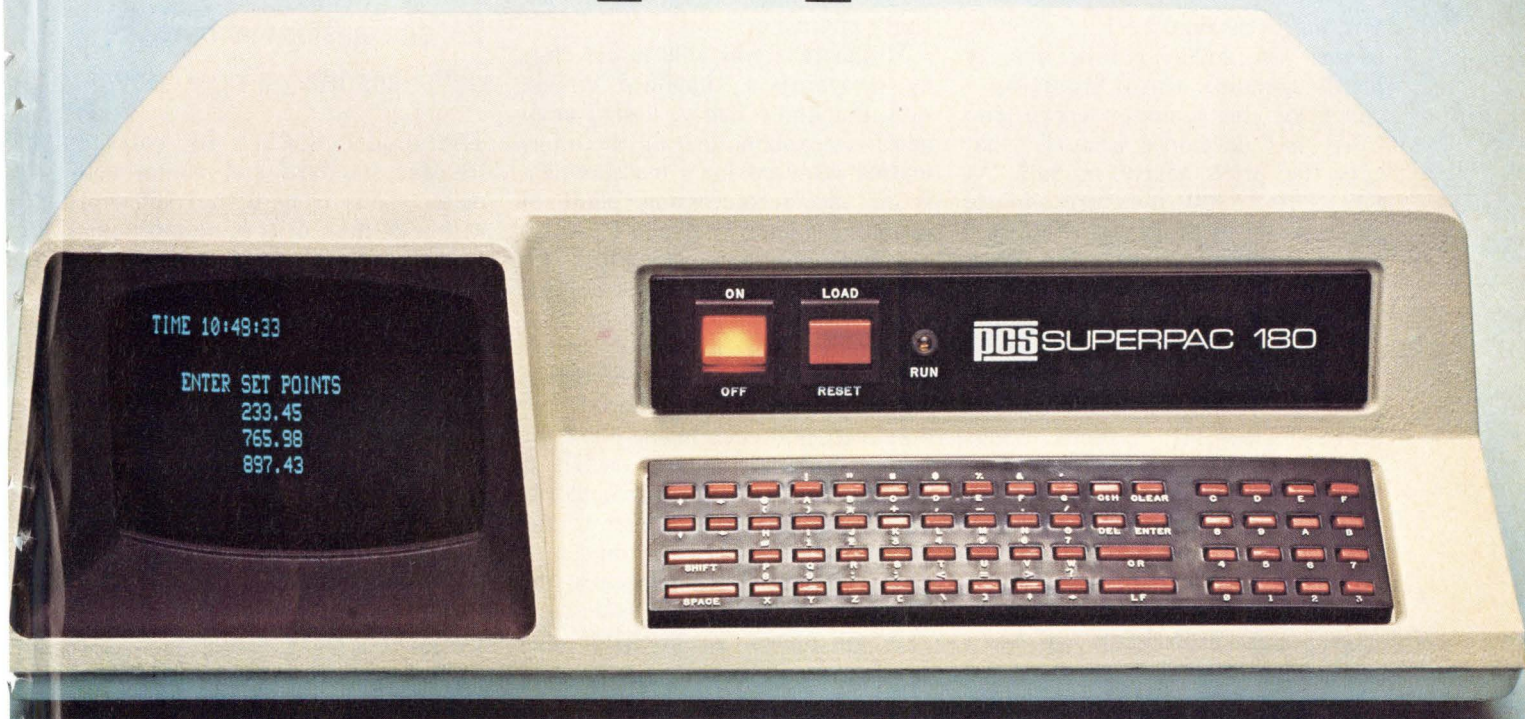

Imagine your systems product with an intelligent front-end that combines TTY keyboard layout and CRT with the best industrial microcomputer money can buy. Now dump those scary development cost estimates in the round file. Because it's here today. At a price that's hard to believe! And behind it is the most complete line of standard industrial microcomputer hardware and software available anywhere. Microcomputer and memory boards. Digital I/O. Analog interfaces. Industrial packages. Complete Real-Time Operating System and FORTRAN compiler.

That's what PCS is all about. And that's why we've sold more industrial microcomputers than anyone else in the business.

Please send me more information about Superpac
 PCS single-board microcomputers PCS packaged systems PCS customer support capabilities.
 Please have a salesman call.

Name _____

Title _____

Company _____

Street _____

City _____ State _____

Telephone _____ Zip _____

*In quantities of 50



PROCESS COMPUTER SYSTEMS, INC.
 750 North Maple Road
 Saline, Michigan 48176
 313-429-4971 TWX: 810-223-8153

New products

Instruments

Phase meter priced at \$795

3½-digit bench-top model offers accuracy within 0.5° and resolution of 0.1°

For the occasional user of a phase meter, who might not be able to justify spending nearly \$1,500 for a bench-top instrument, Krohn-Hite Corp. has developed a model that cuts the price nearly in half. At \$795, its 6200 measures phase angles with an accuracy within 0.5° and a resolution of 0.1°. The Avon, Mass., company claims the 6200 is the only 3½-digit phase meter on the market in that price range.

"The 6200 is a bench-top instrument, not a piece of gear to be used in automatic test systems," says sales manager Ernie Lutfy. A completely automatic instrument, the 6200 provides phase-angle measurements between sine or square waveforms over the range of 10 hertz to 1 megahertz and may be used for reference measurements up to a

frequency of 5 MHz. Input voltage range is from 0.1 volt to 120 v rms. Temperature co-efficient is better than 0.05° per °C. Drift of the instrument is virtually zero for short term and better than 0.2° over a 30-day period.

Phase-measuring techniques are suited to solving problems such as low-impedance measurement, testing and calibrating filter networks, ac power measurements, and adjustment of crystal resonant frequencies, Lutfy points out.

Krohn-Hite was able to cut costs by designing a simplified circuit, says Benjamin Tobey, design engineer. He explains that all the information required for a measurement is in the zero-crossing point of incoming signals, so Krohn-Hite uses a wide-band clipping stage to knock off signal peaks. The clipped signal goes through an amplifier that minimizes the effect of offset voltages, then is fed to a differential switch along with a clipped and amplified reference input. Next the output pulse from the switch is filtered to give a continuous dc voltage that is proportional to the phase angle between the inputs. A digital panel meter measures the voltage and displays the value on a 3½-digit planar gas-discharge dis-

play over a continuous range of -180° to +180°.

Tobey adds that Krohn-Hite also economized by making its own digital panel meters.

The model 6200 measures 3½ by 8⅝ by 11 inches. Delivery time is eight weeks.

Krohn-Hite Corp., Avon Industrial Park, Bodwell St., Avon, Mass. 02322. Phone (617) 580-1660 [351]

7-digit transfer standard drifts less than 1 ppm/day

The model SM215 dc voltage-transfer standard and digital voltmeter spans from 0 to 1,100 volts with a 24-hour drift of no more than 1 part per million of reading. The seven-digit instrument has a maximum overall error of 0.001% of reading plus 0.0001% of full scale. It holds this accuracy for three months between calibrations.

The four ranges can be selected either manually or automatically. On the two lower ranges, 0 to 1.1 and 11 v dc, the input impedance is at least 100,000 megohms, and on the two upper ranges, 0 to 110 and 1,100 v dc, it is 10 megohms. Common-mode rejection is 120 db from dc to 60 Hz with up to 11 kilohms of imbalance, while a switchable input filter provides series-mode rejection ratios of 60 db with filter out and 90 db with filter in. The SM215 sells for \$6,700 and has a delivery time of 30 days.

EMI Technology Inc., P.O. Box 1264, Danbury, Conn. 06810. Phone Peter Simmons at (203) 744-3500 [353]

Synthesized signal generator spans 100 Hz to 1 GHz

Spanning the range of 100 hertz to 1 gigahertz with a constant resolution of 100 Hz, the model 1702 signal generator is a synthesizer-type instrument with a variable output level from 1 volt to 0.1 microvolt. The frequency is set by a bank of seven lever switches, and the output level is

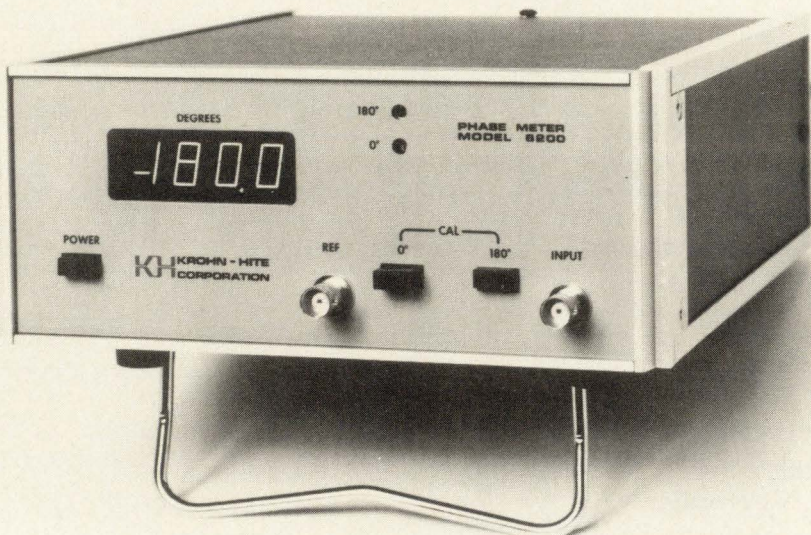

There you are at 30,000 feet.
And whom do
you turn to?
Us.



The entertainment console in the armrest of your passenger seat was most likely made by us. We've supplied at least 85% of all of the entertainment consoles used in today's wide-bodied commercial jet aircraft. So you've had EECO experience all this time without knowing it.

We're telling you now because we thought it's time you knew that we do more than make thumbwheel switches, tape readers, and packaging hardware.

EECO is part of your life.

EECO

1441 East Chestnut Avenue, Santa Ana, California 92701
Phone 714/835-6000

Circle 127 on reader service card

AMP gives you some great lows in high density connectors.

Low mating force. Low cost.

AMP Miniature Rectangular connectors offer stable contact resistance, even with low mating force.

The housings feature molded polarizing keys to eliminate cross mating. And once mated, there's no chance of accidental separation because of an integral latching mechanism. Either half of the housing can be mounted in the same cut-out without additional hardware. And the socket contact is recessed to minimize shock hazard.

Additionally, these .165" centerline MR Connectors provide increased versatility with accessory hardware which is usually only found in more expensive types. Pin headers, strain reliefs, grounding pins, solder tail socket contacts and test connectors, for example.

AMP MR Connectors are recognized under the Components Program of Underwriters' Laboratories, Inc. and certified by Canadian Standards Association.

When you design with AMP MR Connectors, you open a whole world of AMP service: support on the production line, in quality control, in sampling for prototypes and by working with you to help in future designs. And there are AMP plants around the world to serve you. Write or call, Customer Service, AMP Incorporated, Harrisburg, PA 17105. (717) 564-0100.

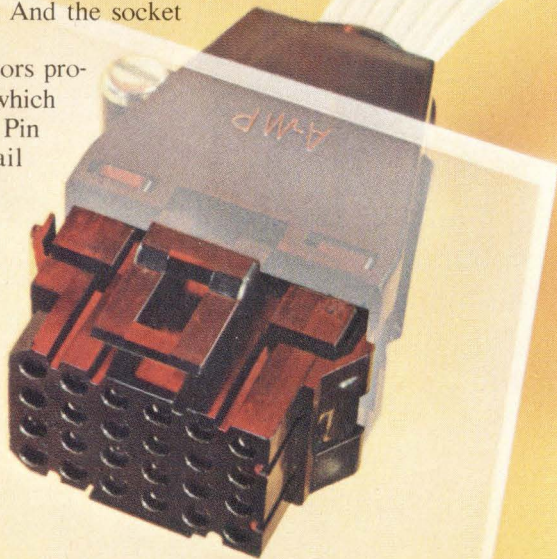

AMP

INCORPORATED

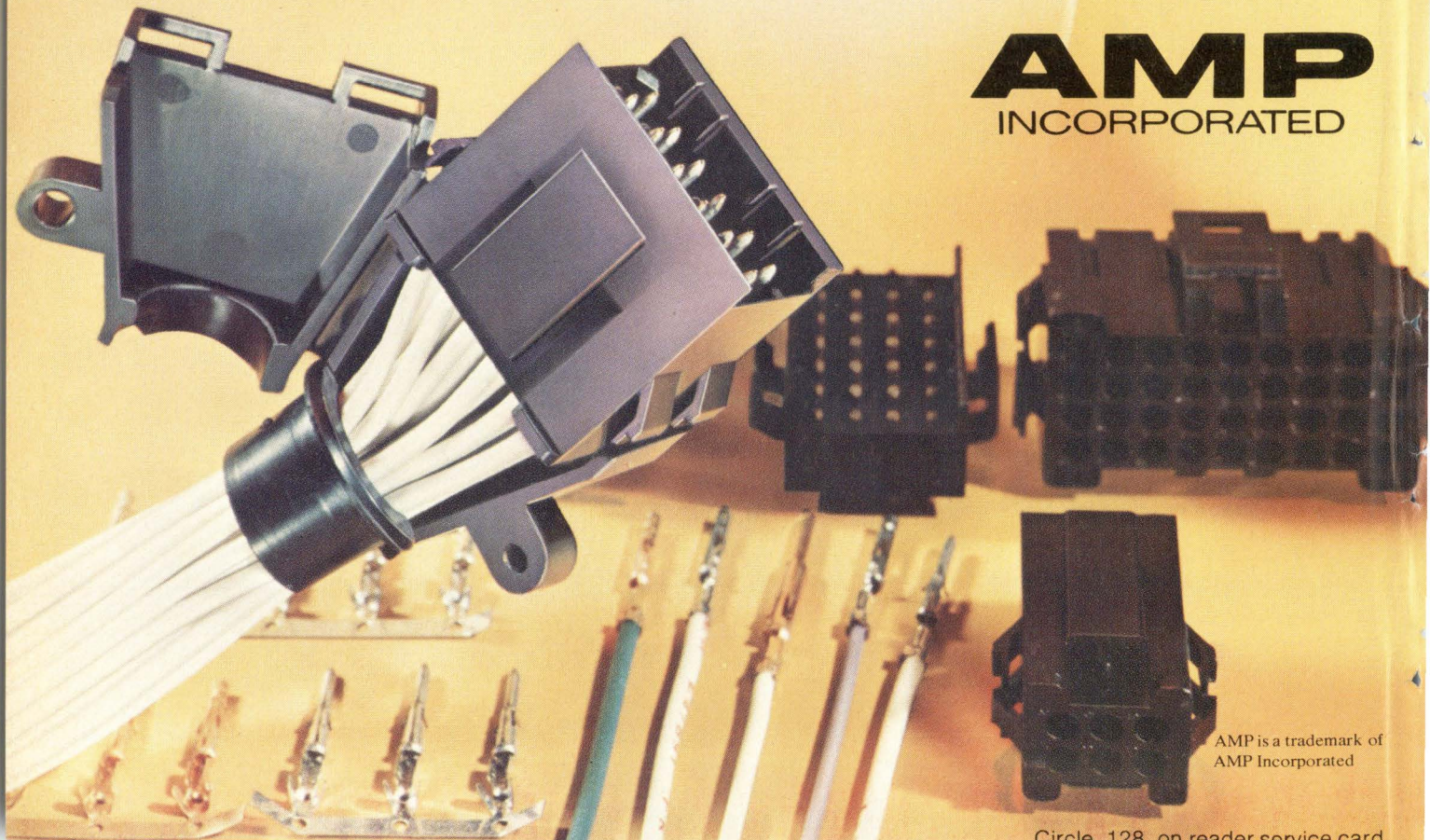

AMP is a trademark of
AMP Incorporated

Circle 128 on reader service card

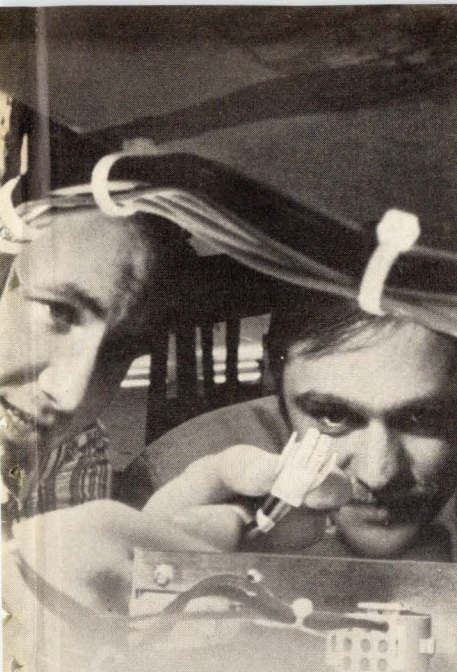

AMP EUROPE

- Austria** — AMP Austria. Branch of AMP Deutschland GmbH. Markgraf-Ruediger Str. 6-8, 1150 Vienna. Phone: 924191/92
- Belgium** — AMP Belgium. Branch of AMP-Holland B.V., Rue de Brabant 62-66, Brussels. Phone: 322.17.55.17
- Finland** — AMP Finland OY. Postilokero 3, 00401 Helsinki 40. Phone: 90/584122
- France** — AMP de France. 29 Chaussée Jules-César. Boite Postale No. 39. 95301 Pontoise France. Phone: 030 82 20, 030 92 30
- Germany** — AMP Deutschland GmbH. Ampérstrasse 7-11, 607 Langen, B. FFM., West Germany. Phone: (06103) 7091
- Great Britain** — AMP of Great Britain Limited, Terminal House, Stanmore, Middlesex, England. Phone: 01-954-2356
- Holland** — AMP Holland B.V., Papierstraat 2-4 's-Hertogenbosch, Holland. Phone: (04100) 25221
- Italy** — AMP Italia S.p.A., Via Fratelli Cervi 15, 10093 Collegno (Torino), Italy. Phone: 785-656
- Spain** — AMP Española, S.A., Apartado 5294. Pedro IV, 491, 495, Barcelona 5, Spain. Phone: 307-75-50
- Sweden** — AMP Scandinavia AB, Datavägen 5, 17500 Jakobsberg, Sweden, Mailing Address: Fack S-175 20 JARFALLA 1, Sweden. Phone: 0758/10400
- Switzerland** — AMP AG, Haldenstrasse 11, 6006 Luzern, Switzerland. Phone: (414) 235421, 235422, 235423

AMP NORTH AMERICA

- Canada** — AMP OF CANADA LTD., 20 Esna Park Drive, Markham, Ontario, Ph: 416-499-2521
- Mexico** — AMP de Mexico, S.A., Apartado Postal 179, Naucalpan de Juarez, Edo, de Mexico, Phone: Mexico City 576-41-55
- Puerto Rico** — AMP OF CANADA LTD., 677 Calé de Diego, Rio Piedras, Puerto Rico 00924, Phone: (809) 766-2346
- United States** — AMP Incorporated, Harrisburg, Pa. 17105, Phone: 717-564-0100

AMP SOUTH AMERICA

- Argentina** — AMP S.A. Argentina 4 de Febrero, 76 Villa Zagla — SAN MARTIN, Buenos Aires, Argentina, Phone: 752-4612
- Brazil** — AMP do Brasil Ltda., AV Comendador Martinelli 185, Lapa, Sao Paulo, Phone: 262-4353

AMP PACIFIC

- Australia** — Australian AMP Pty. Limited, 155 Briens Road, Northmead, N.S.W. 2152 Australia, Mailing Address: P.O. Box 194, Baulkham Hills, N.S.W. 2153 Aus. Ph: 630-7377
- Japan** — AMP (Japan), Ltd., No. 15-14, 7-Chome, Roppongi Minato-Ku, Tokyo, Japan, Ph: 404-7171

Products and services for many specialized industries are provided by the AMPLIVERSAL Division. In the United States, this division is known as AMP Special Industries.

For AMP products and services in other countries, write: AMP International Division, Harrisburg, PA 17105, USA.

New products



determined by two calibrated attenuators—a 100-dB step attenuator and a 20-dB continuously variable attenuator.

Three modulation modes are provided: amplitude, frequency, and continuous-wave. For the a-m and fm modes, the modulating signal can be an internally generated 1-kilohertz waveform, an externally supplied waveform, or a mixture of the two. A three-digit light-emitting-diode readout displays either the percentage of amplitude modulation or the peak fm deviation. Priced at \$4,150, the model 1702 has a delivery time of 30 days.

Systron-Donner Corp., Instrument Division, 10 Systron Dr., Concord, Calif. 94518. Phone Howard Mette at (415) 676-5000 [354]

Real-time spectrum analyzer goes down to 2 Hz full scale

Intended for the analysis of extremely low-frequency signals, the model FFT 512/S-18 real-time spectrum analyzer has 12 ranges from dc to 2 hertz up to dc to 10 kilohertz. Corresponding resolutions, for 400 lines, range from 0.005 Hz to 25 Hz, and corresponding time windows from 200 seconds to 40 milliseconds.

In addition to its 400-line and

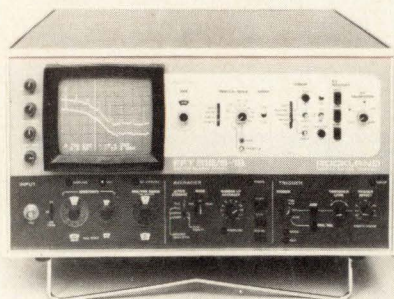

200-line single-display modes, a 200-line dual-display mode can directly compare spectra. The difference between two 200-line spectra may also be displayed. This fourth mode is especially useful in separating background noise from a signal-plus-noise spectrum.

A fast-Fourier-transform instrument, the FFT 512/S-18 can make standard one-third-octave and full-octave measurements, as well as do narrow-band analyses. With a 70-dB dynamic range, the FFT 512/S-18 can handle input levels from 0.33 microvolt to 32 v rms. It is priced at \$9,875.

Rockland Systems Corp., 230 W. Nyack Rd., West Nyack, N.Y. 10994. Phone Joe Flink at (914) 623-6666 [355]

Low-cost function generator can be externally swept

Priced at only \$124.95 (or \$79.95 in kit form), the model 12 function generator can be controlled in frequency by an external voltage from dc up to 1 megahertz. Because the external control goes down to dc, the inexpensive instrument can produce tone bursts as well as fm and frequency-shift-keying signals.

Three outputs are available simultaneously: a TTL-compatible square wave, a triangular wave with a peak-to-peak voltage of 4 v, and a switch-selectable output that can deliver sine, square, and triangular waves with variable amplitude and offset.

A E Corp., 65 Wellesley Ave., Needham, Mass. 02194. Phone Harvey Harrison at (617) 449-3142 [357]

Graphics system speeds instrument calibration

A system built around a cathode-ray-tube display works with the Locost automated precision test system to speed instrument calibration and reduce operator error. The system uses alphanumeric and line art—including three-dimensional representations and flashing ele-

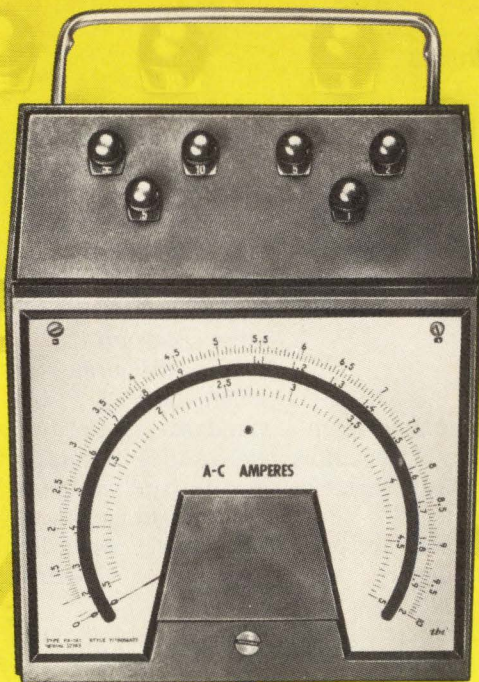

TOUGH CASE.

To mold it for Westinghouse portable indicating instruments indicated Plenco 500 Phenolic. For 5 good reasons.

Sturdy, attractive cases like this one are molded for the Westinghouse Relay-Instrument Division, Newark, NJ, by Squires Plastics, Inc., Verona, PA. Squires points out the reasons:

"Your Plenco 500 Black Impact Phenolic compound was selected," says the molder, "because of its 1) improved impact strength, 2) low gravity, 3) low moisture absorption, 4) excellent dimensional stability, and 5) superior surface appearance."

The cases house Westinghouse Ac and Dc indicating instruments developed for use

where a long scale arc is desirable for quick, accurate reading.

The indications are clear. Consult Plenco on your next molding problem and rest your case.

PLENCO
THERMOSET PLASTICS

PLASTICS ENGINEERING COMPANY
Sheboygan, WI 53081

Through Plenco research . . . a wide range of ready-made or custom-formulated phenolic, melamine-phenolic and alkyd thermoset molding compounds, and industrial resins.

New products

ments—to show the operator exactly the sequence to follow in a calibration procedure. The graphics system uses words and pictures to reduce errors, eliminate the time-wasting consultation of maintenance manuals, and to allow the use of low-skilled personnel for all tasks, from connecting test leads to the proper terminals and setting controls to making internal adjustments.

An extensive collection of master programs enables the operator to produce the layout for an instrument panel in 15 to 30 minutes.

The graphics package, complete with master programs, is priced at \$10,000. The Locost system, which consists of a computer, an array of programmable test equipment, and a comprehensive software package, varies in price according to the test equipment needed to meet the user's needs.

Julie Research Laboratories Inc., 211 West 61 St., New York, N.Y. 10023 [356]

TOPICS Instruments

Electro-Metrics, Amsterdam, N.Y., has introduced a digital interface unit, the DIU-25, for connecting its EMC-25 interference analyzer to the Hewlett-Packard 9825 programmable calculator and to other calculators in the HP 9800 series. . . . **E-H Research Laboratories Inc., Oakland, Calif.**, has developed a 50-MHz word-generator plug-in for its 1320 Digiscope logic analyzer. The 1301 generator, which sells for \$1,120, has two independent output channels. . . . **Non-Linear Systems Inc., Del Mar, Calif.**, has developed a prescaler for its FM-7 60-MHz frequency counter. With the new SC-5, the counter's range is extended to 512 MHz. . . . **Optronic Laboratories Inc., Silver Spring, Md.**, has announced its 750 automatic data-reduction system. An accessory for the 740A spectroradiometer, the 750 is designed to compute and print out the spectral irradiance of sources with wavelengths from 300 to 1,065 nanometers.

New from Centralab...

IMPS PUSHBUTTON SWITCHES

A new miniature modular building block system that offers microprocessor control designers more of what they need.

To meet the special digital and analog needs of today's μ P-based controls, Centralab offers design engineers a whole new system of modular pushbutton switch building blocks. We call it IMPS — Integrated Modular Panel System. IMPS saves PC board and panel area and simplifies front panel design, cuts assembly costs, reduces back-panel space requirements, and meets the digital-analog needs of μ P-based controls. Check these space saving, cost-cutting features.

Simplify front panel interface.

All IMPS switches regardless of function, are uniform in size, simplifying design and selection of front panel hardware. They have high volumetric efficiency, occupying .505" x .388" PC board area and require only .608" of space between PC board and front panel.

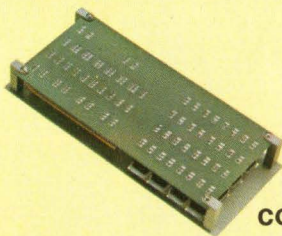
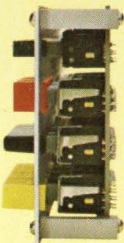

Cut
assembly
costs.

IMPS switches may be mounted on the front panel, and are designed for automatic wave soldering installation and PC board cleaning. Insert molded terminals prevent flux and solder wicking and contact contamination. Integral PC board stand-offs provide for efficient board cleaning.

Meet analog and digital needs.

IMPS switches are available with momentary, push-push and interlocking actions, with a long-life contact system that switches both digital and analog signals. To accommodate critical signal requirements, housings are high-insulation molded plastic with UL 94V-0 rating.

Available options.

Optional installations include ganged assemblies, front-panel mounting and wire-wrapping.

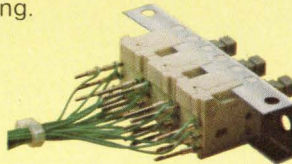

All IMPS pushbutton switches are built to Centralab's highest quality standards (see specifications at right). They're priced as low as 41 cents in 1,000 quantity. For full technical details, samples and quotation, call (515) 955-3770, or write to the address below.



CENTRALAB

Electronics Division
GLOBE-UNION INC.

P.O. BOX 858
FORT DODGE, IOWA 50501

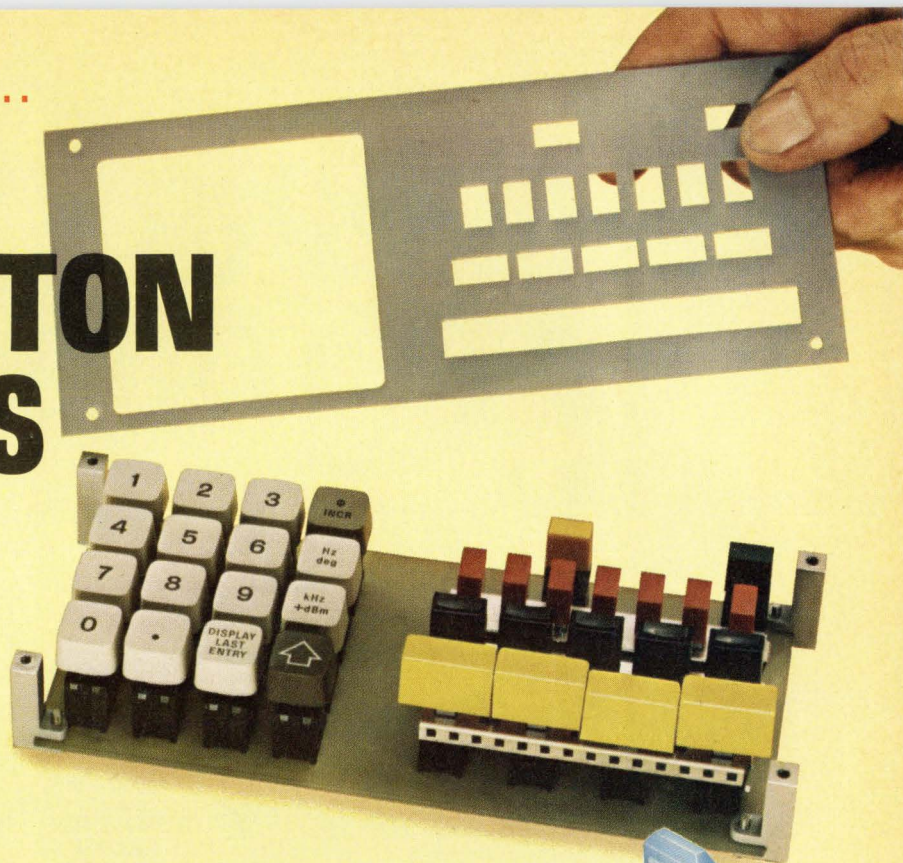

Built To Centralab Quality Specs.

IMPS Pushbutton Switches combine compact size, low cost and highest quality throughout.

- Silver or gold inlay wiping contacts for long-life and low-contact resistance.
- Less than 2 milliseconds contact bounce.
- SPST, SPDT, DPST, and DPDT switch contacts.
- Printed circuit, DIL socket or wire-wrap terminations available.
- 2.5 to 3.5 oz. actuation force (momentary).
- Choice of button interface — square or blade shaft (shown) — permits use of a variety of Centralab and industry standard buttons and keycaps.
- 10, 15, 20 or 25mm center-to-center spacing.

Choosing Systems or Components: Know your weapons.

Developed by Zilog. Manufactured by Zilog. Supported by Zilog. Here are the most powerful weapons on the microcomputer battlefield. Together or separately they herald victory over sluggish speeds and villainish inefficiencies.

Manufactured by Zilog.

Whether you need one or a million and one, Zilog's new facility can deliver. All of our production equipment is state-of-the-art (4" wafers)—the most modern microcomputer manufacturing in the world. You order. We'll deliver, plastic or ceramic. Your choice!



Masterminded by the Z80-CPU.

A single chip, N-channel processor arms you with a super-set of 158 instructions that include all 78 of the 8080A's and the 8085 instructions with *total* software compatibility. The new instructions include 1, 4, 8 and 16-bit operations, such as, memory-to-memory or memory-to-I/O block transfers and searches, 16-bit arithmetic, 9 types of rotates and shifts, bit manipulation and a legion of addressing modes. And that means less programming time, and less end user costs. With these features, the Z80-CPU generally requires approximately 50% less memory space for program storage yet provides up to 500% more throughput than the 8080A or the 8085. Powerful ammunition at a surprisingly low cost (less than \$10 each in large quantities) and ready for immediate shipment.



Deploy the Z80 peripheral devices:

Z80-PIO—Parallel I/O Interface Controller. Two (2) ports for fast I/O transfer under full interrupt control.

Z80-SIO—Serial I/O Interface Controller. Two (2) fully independent full duplex channels that can be programmed to operate in any asynchronous or synchronous modes including Bi-Sync and HDLC/SDLC.

Z80-CTC—Counter Timer Circuit. Four (4) independent channels that can be used to count external events or to generate interrupts at programmable intervals.

Z80-DMA—Direct Memory Access. Programmable circuit that transfers data between memory and peripheral devices at up to 1.2 megabytes per second. The DMA can operate in a transparent mode without slowing the CPU.

Deploy the Z80 software:

Resident Macro Assemblers. With cross-reference and conditional assembly, also relocatable assembler with linking loader.

PLZ Resident Compiler. Most powerful microcomputer compiler available today.

Text Editor and File Maintenance.

Basic Interpreter. For writing programs in Basic.

Cross Software. Available from NCSS.

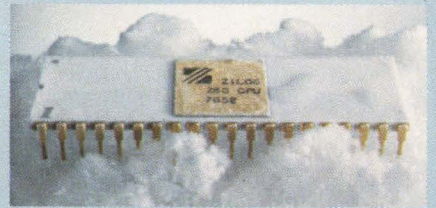

Made for the Military.

You can get Zilog components to meet MIL Spec 883B with extended temperature range of -55°C to $+125^{\circ}\text{C}$. The Z80 component family operates with less power in MIL Temp environments.

For victory over obsolescence:

Deploy these strong components from the leader in microprocessors. We are bound by our pledge to stay a generation ahead and determined to make your components and systems the most powerful in the field. We're ready to dispatch help immediately.



Zilog

10460 Bubb Road, Cupertino, California 95014
(408) 446-4666/TWX 910-338-7621

Boston (617) 890-0640
Chicago (312) 885-8080
Los Angeles (213) 540-7749

In Europe: Zilog, Inc., Nicholson House,
High Street, Maidenhead, Berkshire, U.K.
TEL 0628 36131/2/3/TLX 848-609

AN AFFILIATE OF **EXON** ENTERPRISES INC.

New products

Subassemblies

Sample-and-hold switches fast

Thin-film hybrid for \$70 acquires 10-volt step to within 0.01% in 1 μ s

As analog designers realize, a workable data-acquisition system requires matching of component parts in certain key respects. One critical match is between the analog-to-digital converter and the sample-and-hold amplifier. The high resolution and high accuracy of the a-d can easily be wasted if the sample-and-hold isn't completely compatible, to keep offset errors low and switching times short. Moreover, the sample-and-hold must reach its final output value very quickly and then maintain that output level with very little droop.

Meeting all these prerequisites for 12-bit data-acquisition systems is the MN346, a sample-and-hold amplifier from Micro Networks Corp. Housed in a 14-pin hermetically sealed ceramic dual in-line package, the device offers performance comparable to larger modular units but at much lower cost. It's a thin-film hybrid circuit that boasts a typical acquisition time of 1 microsecond, coming within 0.01% of a 10-volt step input. In quantities of 1 to 24, the MN346 is priced at \$70 each, dropping to \$56 each in lots of 100 and up.

Other performance specifications are also attractive. Designed as an inverting unity-gain device, the circuit holds gain error to within $\pm 0.02\%$ maximum at 25°C, and $\pm 0.05\%$ maximum over its full operating temperature range of 0°C to 70°C. Its aperture time is 30 nanoseconds typical, 60 ns maximum.

In the sample mode, offset voltage for the device is a maximum of 3 millivolts, and 6 mV maximum in the hold mode. However, this offset error may be adjusted to zero exter-

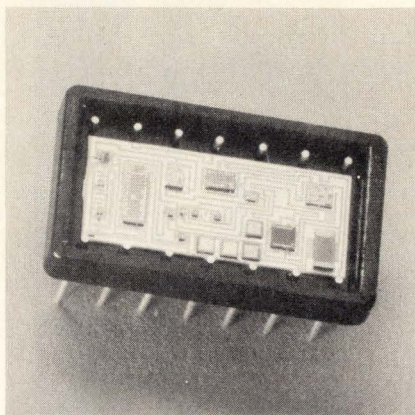

nally. Input voltage may range over ± 10 v typically, while the typical output-voltage swing is over ± 10 v at ± 15 milliamperes maximum.

The circuit, which has its own internal holding capacitor, keeps droop rate to 0.5 mv/millesecond maximum at 25°C, 60 mv/ms maximum at 70°C. Full-power bandwidth is a broad 1.4 megahertz, and output slew rate a fast 50 v/ μ s.

Over the power-supply range of ± 12 to ± 18 v, the device typically consumes 640 milliwatts or a maximum of 795 mw. Typical power-supply rejection ratio is 100 microvolts/v for both the positive and negative supply lines.

A military model, the MN346H, is also available. For the most part, it offers performance identical to the commercial MN346 model, but operates over the temperature range of -55°C to +125°C.

Delivery time for both models is from stock to within four weeks, depending on quantity.

Micro Networks Corp., 324 Clark St., Worcester, Mass. 01606. Phone (617) 852-5400 [381]

Data module broadens use of computer I/O interfaces

Data Translation Inc. has extended the capabilities of its DT-5702 data-acquisition module—originally limited to one microcomputer—to operate with additional interfaces. Developed to enable the firm's analog input/output interface system to function with the Digital Equipment

Corp. LSI-11 microcomputer [*Electronics*, Dec. 9, 1976, p. 121], the DT-5702 now can also accommodate other Data Translation microcomputer-interface boards, including those for Intel Corp.'s SBC-80 series, Computer Automation's LSI series, and National Semiconductor Corp.'s Pace.

The module, which acquires and digitizes low-level signals of 10 millivolts to 10 volts from transducers like thermocouples, pressure sensors, and strain gages, contains the same functional elements as the other models in the company's Datex 11 series. These are a 16-channel input multiplexer, an instrumentation amplifier, high-speed sample-and-hold amplifier, 12-bit high-speed analog-to-digital converter with tri-state outputs for direct connection to microcomputer buses, and all control and programming logic.

Aaron Fishman, engineering vice president, says that previous data-acquisition systems for low-level

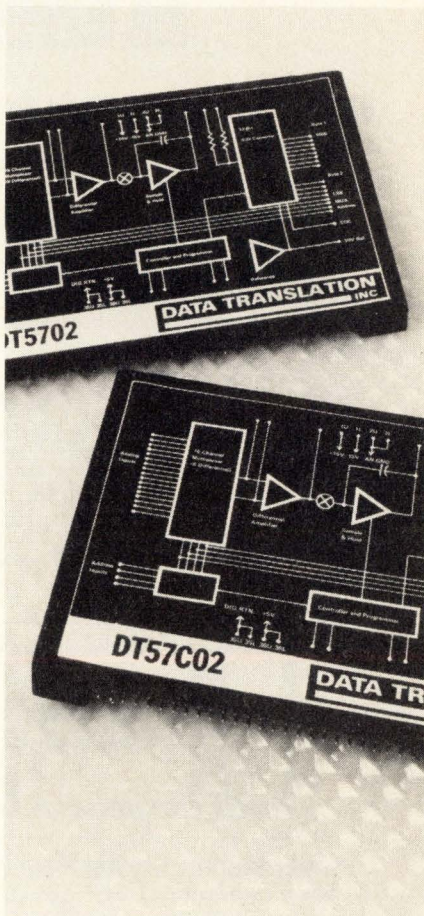

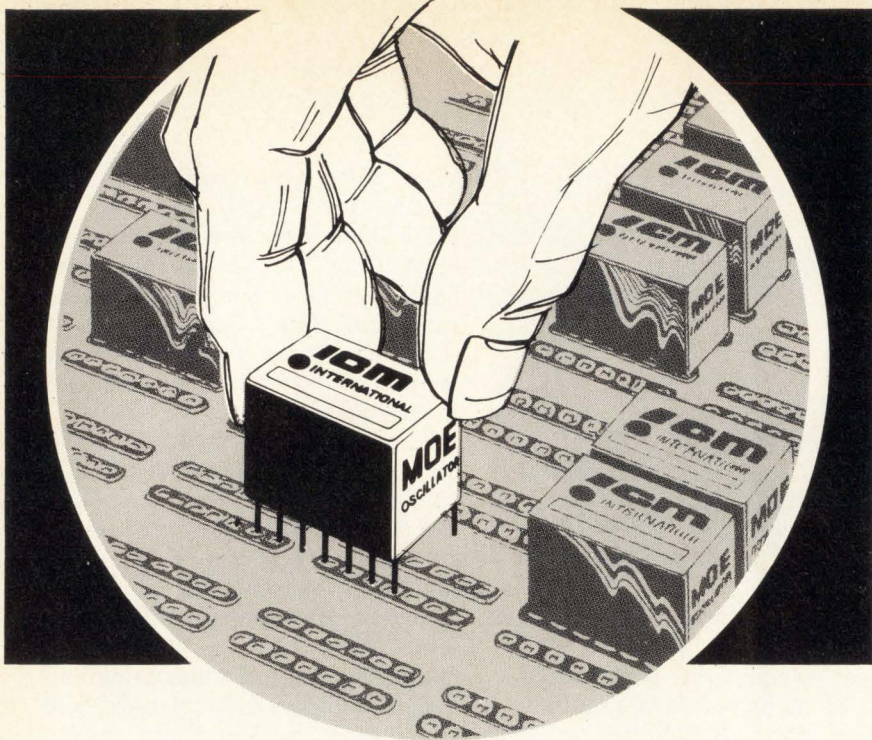

INTERNATIONAL'S
moe
**CRYSTAL OSCILLATOR
 ELEMENTS**

A Complete Controlled Signal Source from 6000 KHz to 60 MHz

The MOE series is designed for direct plug-in to a standard dip socket. The miniature oscillator element is a complete source, crystal controlled, in an integrated circuit 14 pin dual-in-line package with a height of 1/2 inch.

Oscillators are grouped by frequency and temperature stability thus giving the user a selection of the overall accuracy desired. Operating voltage 6 vdc. Output wave shape — non sine.

TYPE	CRYSTAL RANGE	OVERALL ACCURACY	25°C TOLERANCE	PRICE
MOE-5	6000KHz to 60MHz	+ .002% -10° to +60°C	Zero Trimmer	\$35.00
MOE-10	6000KHz to 60MHz	+ .0005% -10° to +60°C	Zero Trimmer	\$50.00

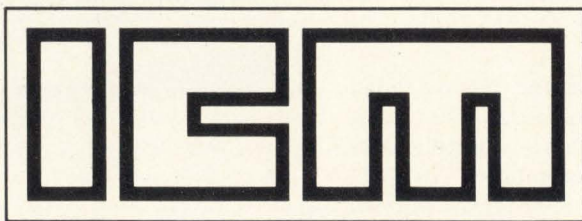

International Crystal Manufacturing Company, Inc.
 10 North Lee, Oklahoma City, Oklahoma 73102

New products

measurements required a bulky instrumentation amplifier that cost as much as \$50 for each data channel. "The DT5702 does this task in the same package size as high-level data-acquisition modules," Fishman says, "and uses the same interface."

Analog-input ranges of ± 10 volts or 0 to 10 v are available, and the addition of an external resistor accommodates an input range from 10 millivolts to 10 v. Throughput times range from 28.5 kilohertz at a gain of 1 in the 10-v range to 3 kHz at a gain of 1,000 in that range. System accuracy at a gain of 1 is within $\pm 0.03\%$, and linearity at the same gain level is within $\pm 1/2$ least significant bit.

The DT5702 is priced at \$275 each and \$175 in quantities of 100. A low-power version, the DT57C02, sells for \$295 singly or \$195 in quantities. Delivery of both is stock to two weeks.

Data Translation Inc., 23 Strathmore Rd., Natick, Mass. 01760. Phone (617) 655-5300 [382]

**Hybrid voltage regulator
 adjusts from 5 to 20 V**

A hybrid voltage-regulator subsystem with an output that can be easily adjusted over the range from 5 to 20 volts delivers up to 5 amperes. With its built-in short-circuit and safe-operating-area protection, the 78HGKC offers all the advantages of monolithic regulators at current levels previously unattainable. The unit's output voltage is determined by a single external potentiometer,

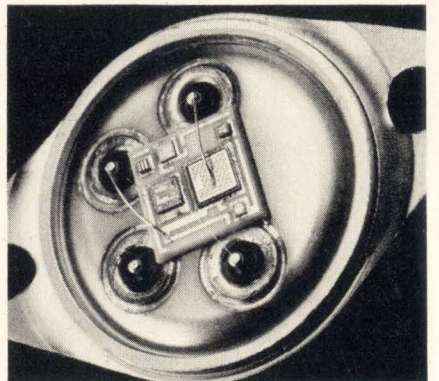

New.

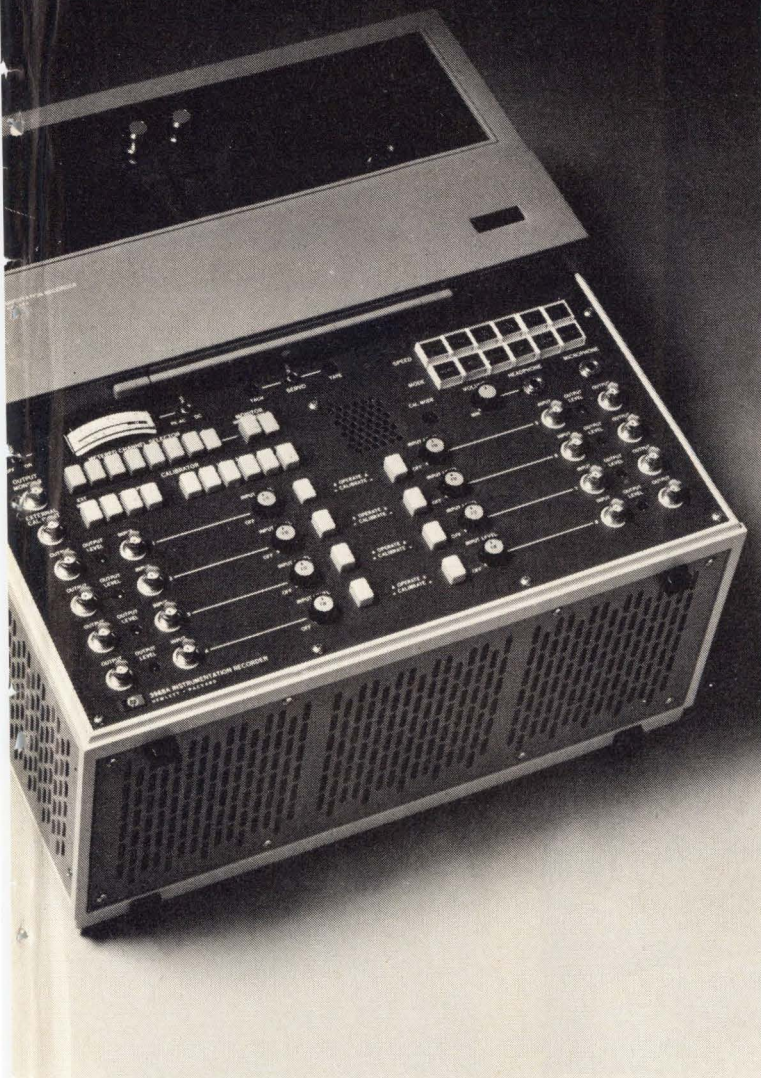

Newer.

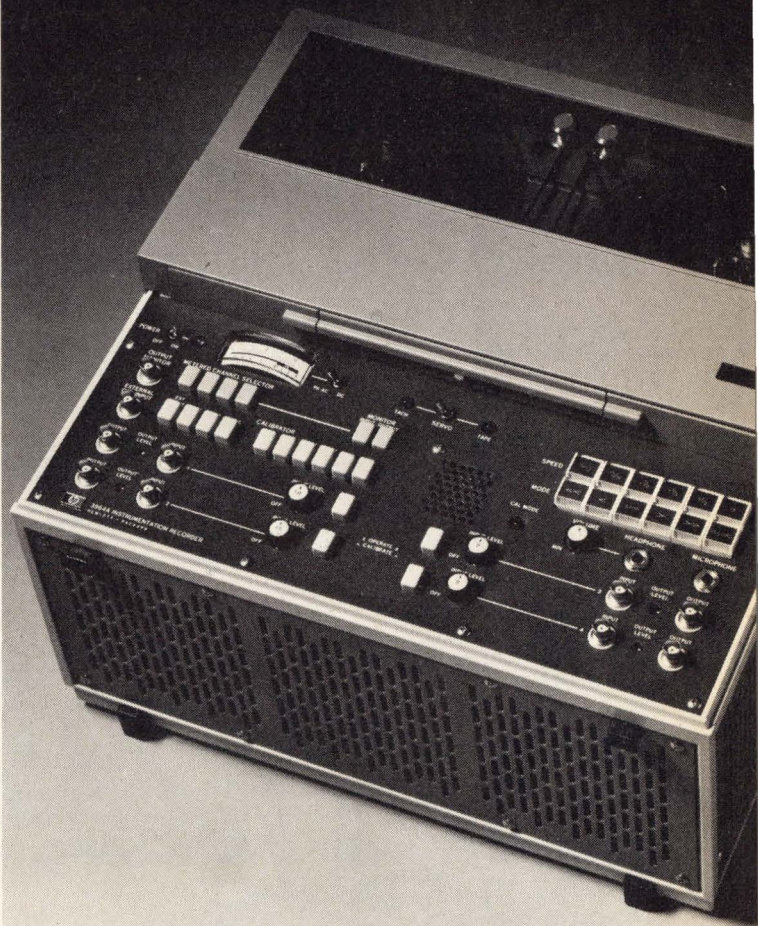

HP's field proven 3968A 8-channel instrumentation tape recorder provides high performance on inexpensive 1/4-inch tape.



Now there's a 4-channel solution to your high performance recorder needs.

If eight channels of high performance data collection is more than you need, Hewlett-Packard now has four of the same. Our rugged new 4-channel Model 3964A Instrumentation Tape Recorder gives you lab quality performance even in tough field environments. And like our 8-channel Model 3968A, you record on inexpensive 1/4-inch tape. The 3964A is compatible with all existing HP four channel tapes. Both

machines have six tape speeds from 15/32 ips to 15 ips to give you a 32:1 time base compression or expansion for flexibility and easy data analysis. Select direct recording from 50 Hz to 64 KHz with SNR up to 38 db.; FM from DC to 5 KHz with SNR up to 48 db. Standard features include TTL remote control, a push button built-in calibration source, tape/tach servo, flutter compensation and voice annotation. For

high performance eight channel recording, or for four of the same, get complete technical details on the 3964A or 3968A from Hewlett-Packard.

11608

HEWLETT  PACKARD

Sales and service from 172 offices in 65 countries.
1507 Page Mill Road, Palo Alto, California 94304

Circle 135 on reader service card

New Press Top Coolers are today's best buy for a nickel.

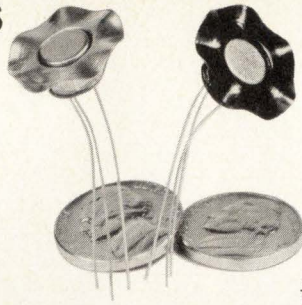

Here's how to really cut cooling costs for TO-5 packages. Wakefield's new 298 Press Top Coolers cost only 5¢ each in 5,000 quantity. This is less than the price of comparable IERC Fan Tops or Thermalloy devices... and at no sacrifice in performance. With ΔT_c -A less than 70°C/W.

The unique wave design of the cooler is responsible for the high cooling efficiency while new automatic tooling allows the low price.

Try one free:

298 Coolers need no board space. See for yourself how they can solve heat problems and improve transistor performance. Send for a free sample.

Cut out and mail for a free sample.



WAKEFIELD ENGINEERING INC.

77 AUDUBON ROAD, WAKEFIELD, MA 01880 (617) 245-5900.
TWX 710-348-6713 AN EG&G COMPANY

Circle 178 on reader service card

Clip DIP troubles in the bud.

Troubleshooting DIP ICs can be a pain in the probe if you can't get at their pins. But you can make the job faster and easier with Super-Grip™ IC test clips from A P. Our "contact comb" design prevents shorting while our superior gold-plated phosphor bronze terminals make contact. Then your probe is welcome aboard its handy topside pins. And this gutsy little spring clip is perfect as an IC puller, too. So use it for its connections or use it for its pull. Either way, you're full speed ahead with A P.

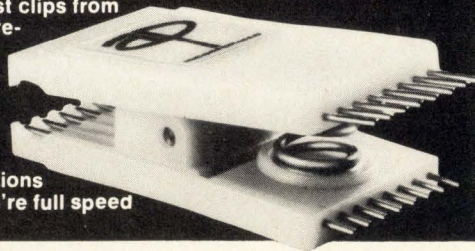

A P has a Super-Grip™ Clip for any DIP.

MODEL	ROW-TO-ROW DIMENSION	PART NUMBER	PRICE
TC-8	.3 in.	923695	\$ 7.35
TC-14	.3 in.	923698	\$ 4.50
TC-16	.3 in.	923700	\$ 4.75
TC-16LSI	.5/6 in.	923702	\$ 8.95
TC-18	.3 in.	923703	\$10.00
TC-20	.3 in.	923704	\$11.55
TC-22	.4 in.	923705	\$11.55
TC-24	.5/6 in.	923714	\$13.85
TC-28	.5/6 in.	923718	\$15.25
TC-36	.5/6 in.	923720	\$19.95
TC-40	.5/6 in.	923722	\$21.00

Order from your A P distributor today. Our distributor list is growing daily. For the name of the distributor nearest you call Toll-Free 800-321-9668.

Send for our complete A P catalog, The Faster and Easier Book.



A P PRODUCTS INCORPORATED

Box 110-E Painesville, OH 44077 (216) 354-2101 TWX: 810-425-2250

136 Circle 136 on reader service card

New products

or two fixed resistors can be used. Automatic thermal-overload protection is provided. Housed in a four-pin TO-3 package, the 78HGKC sells for \$7.50 in quantities from 100 to 999. Delivery is from stock.

Automotive-Hybrid Products, Analog Products Division, Fairchild Camera and Instrument Corp., 464 Ellis St., Mountain View, Calif. 94042. Phone (415) 962-3816 [384]

Digital-to-synchro converter needs no 7% solution

A 14-bit digital-to-synchro converter with a maximum error of 4 minutes of arc can produce radar PPI (plan position indicator) displays that are virtually free of distortion. Designated the DSC5112, the converter has a maximum transformation-ratio error of 0.1% compared with the 7% of most other converters. It therefore does not require a transformation-ratio-correction module to eliminate jitter and distortion.

The converter has a settling time

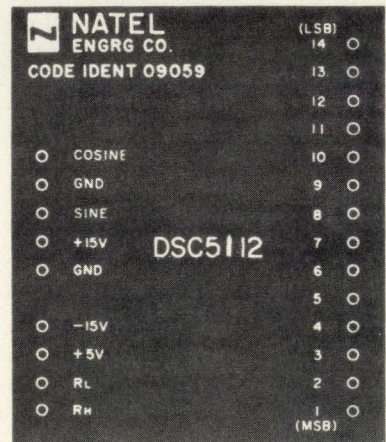

of 50 microseconds for a 180° input step change. Protected against both short circuits and thermal overloads, the unit's transformer-isolated output is rated at 2 watts. It is compatible with any three-wire synchro or four-wire resolver. The reference can be either 26 or 115 v rms. The unit can operate at 400 hertz by itself, or at 60 Hz with an auxiliary transformer. The DSC5112 sells for \$595

Electronics/February 17, 1977

Introductory offer to new members of the **ELECTRONICS AND CONTROL ENGINEERS' BOOK CLUB**

any one
of these great
professional books
for only **\$1.00**
values up
to **\$42.50**

Special \$1.00 bonus book comes to you
with your first club selection

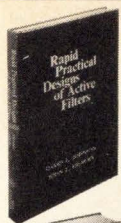

767/556
RAPID PRACTICAL DESIGNS OF ACTIVE FILTERS
by D. E. Johnson
& J. L. Hilburn
Pub. price, \$15.00
Club price, \$11.50



771/480
MANUAL FOR MOS USERS
by J. D. Lenk
Pub. price, \$16.95
Club price, \$12.95

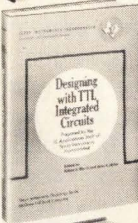

637/458
DESIGNING WITH TTL INTEGRATED CIRCUITS
by Texas Instruments, Inc.
Pub. price, \$26.00
Club price, \$17.50

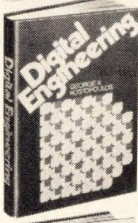

771/456
DIGITAL ENGINEERING, 2/e
by G. K. Kostopoulos
Pub. price, \$24.95
Club price, \$18.95

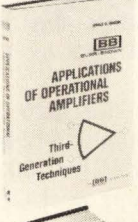

238/901
APPLICATIONS OF OPERATIONAL AMPLIFIERS: Third-Generation Techniques
by J. G. Graeme
Pub. price, \$18.65
Club price, \$11.95

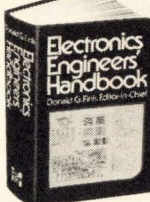

209/804
ELECTRONICS ENGINEERS' HANDBOOK
by D. G. Fink
Pub. price, \$42.50
Club price, \$32.50

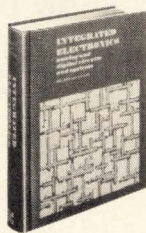

423/156
INTEGRATED ELECTRONICS: Analog Digital Circuits & Systems
by J. Millman
& C. Halkias
Pub. price, \$21.00
Club price, \$15.95

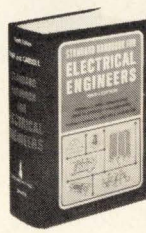

209/731
STANDARD HANDBOOK FOR ELECTRICAL ENGINEERS, 10/e
by D. J. Fink &
J. M. Carroll
Pub. price, \$41.50
Club price, \$28.50

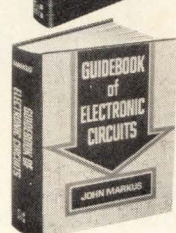

404/453
GUIDEBOOK OF ELECTRONIC CIRCUITS
by J. Markuss
Pub. price, \$26.95
Club price, \$21.50



353/387
MINICOMPUTERS FOR ENGINEERS AND SCIENTISTS
by G. A. Korn
Pub. price, \$23.45
Club price, \$15.50



287/341
STANDARD HANDBOOK OF ENGINEERING CALCULATIONS
by T. G. Hicks
Pub. price, \$19.50
Club price, \$15.25



617/97X
HANDBOOK OF OPERATIONAL AMPLIFIER CIRCUIT DESIGN
by D. E. Stout &
M. Kaufman
Pub. price, \$24.50
Club price, \$17.50



771/189
ELECTRONIC TROUBLE-SHOOTING
by C. N. Herrick
Pub. price, \$13.95
Club price, \$10.95



124/485
ELECTRICAL ENGINEERING FOR PROFESSIONAL ENGINEERS' EXAMINATIONS, 3/e
by J. D. Constance
Pub. price, \$17.00
Club price, \$12.50

save time and money by joining the **ELECTRONICS AND CONTROL ENGINEERS' BOOK CLUB**



Here is a professional book club designed to meet your on-the-job engineering needs by providing practical books in your field on a regular basis at below publisher prices. If you're missing out on important technical literature—if today's high cost of reading curbs the growth of your library—here's the solution to your problem.

The *Electronics and Control Engineers' Book Club* was organized for you, to provide an economical reading program that cannot fail to be of value. Administered by the McGraw-Hill Book Company, all books are chosen by qualified editors and consultants. Their understanding of the standards and values of the literature in your field guarantees the appropriateness of the selections.

How the club operates: Every month you receive free of charge *The Electronics and Control Engineers' Book Club Bulletin*. This announces and describes the Club's featured book of the month as well as alternate selections available at special members' prices. If you want to examine the Club's feature of the month, you do nothing. If you prefer one of the alternate selections—or if you want no book at all—you notify the Club by returning the card enclosed with each Bulletin.

As a Club member, you agree only to the purchase of four books (including your first selection) over a two-year period. Considering the many books published annually, there will surely be at least four you would want to own anyway. By joining the Club, you save both money and the trouble of searching for the best books.

MAIL THIS COUPON TODAY

ELECTRONICS AND CONTROL ENGINEERS' BOOK CLUB
P.O. Box 582, Princeton Road, Hightstown, New Jersey 08520

Please enroll me as a member and send me the two books indicated. I am to receive the bonus book at the introductory price of \$1.00 plus my first selection, plus tax, postage and handling. If not completely satisfied, I may return the books within 10 days and request that my membership be cancelled. If I keep the books, I agree to take a minimum of three additional books during the next two years at special Club prices (guaranteed 15% discount, often more). I will receive the Club Bulletin 12 times a year. If I want to examine the featured selection, I need take no action. It will be shipped automatically. If, however, I want an alternate selection—or no book at all—I simply notify the Club by returning the convenient card always enclosed. I will always have a minimum of ten days in which to return the card and you will credit my account fully, including postage, if this is not the case. Membership in the Club is continuous but cancellable by me at any time after the four-book purchase requirement has been filled. This order subject to acceptance by McGraw-Hill. Orders from outside the continental U.S. must be prepaid. All prices subject to change without notice. Offer good for new members only.

Write Code # of \$1.00 bonus book selection here

Write Code # of first selection here

NAME _____

ADDRESS _____

CITY _____

STATE _____ ZIP _____

EXTRA SAVINGS: Remit in full with your order, plus any local and state tax, and McGraw-Hill will pay all postage and handling charges. **E33311**

Our attenuators will always level with you.



Honest attenuation.

In your equipment or on the bench, Telonic Attenuators provide reliable "specs or better" performance. We make sure, because we use them in our own instruments.

Our thick film resistive elements are made in-house to assure you of top quality. Their operating parameters enable us to guarantee accuracies in some models to $\pm .02$ dB, frequency coverage to 4GHz and power-handling capabilities up to 25 watts. Here's the selection, in 50- or 75-ohm versions:

Variable (Rotary) Types

1, 10, 69, 100, or 110 dB ranges
0.1, 1.0, and 10 dB steps.

Fixed Value Types

3, 6, 10, 20, 30, 40, 50, or 60 dB
SMA, TNC, BNC, or N connectors.

Telonic also supplies bench-top versions incorporating sequenced rotary models, and special versions to fit your requirements. Call us TOLL FREE (except in Calif.) for further specs, prices, more information, or our new Attenuator Catalog. Telonic Altair, 2825 Laguna Canyon Road, Box 277, Laguna Beach, CA 92652. Phone: 714/494-9401 TOLL FREE: 800-854-2436.

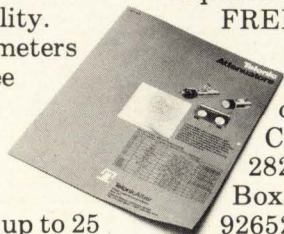

TelonicAltair 

New products

in small quantities. Delivery time is 45 days.

Natel Engineering Co. Inc., 8954 Mason Ave., Canoga Park, Calif. 91306 [385]

Quadrature oscillator in a DIP is resistor-programmable

A precision quadrature oscillator, which is housed in a 14-pin dual in-line package, is resistor-programmable over its entire frequency range from 2 millihertz to 20 kilohertz. The quadrature oscillator—called so because it produces simultaneous sine and cosine outputs—also includes an uncommitted operational amplifier.

As supplied, the model 4423 is a 20-kHz oscillator. External components need only be added to reduce its frequency. Two resistors are required for the range from 2 kHz to 20 kHz, while two resistors plus two capacitors are required to cover the rest of the range.

The oscillator sells for \$16 in small quantities, dropping to \$12 for 25 to 99 units and to \$9.85 for 100 to 999. Delivery time is four weeks.

Burr-Brown, International Airport Industrial Park, Tucson, Ariz. 85734. Phone (602) 294-1431 [386]

Dc-to-dc converter powers microprocessors

Designed specifically for use with microprocessors and such related integrated circuits as random-access and read-only memories, the model R12-5 is a 3-watt dc-to-dc converter that puts out 12 volts at 200 milliamperes and -5 v at 100 mA from a 5-v input. The outputs are protected against short circuits and do not generate potentially damaging overshoots. The power supply is regulated to within 0.02% against both line and load variations. Ripple and noise outputs are only 1 millivolt rms. The unit's input-to-output isolation rating is 300 volts.

Reliability Inc., 5325 Glenmont, Houston, Texas 77036. Phone (713) 666-3261 [387]

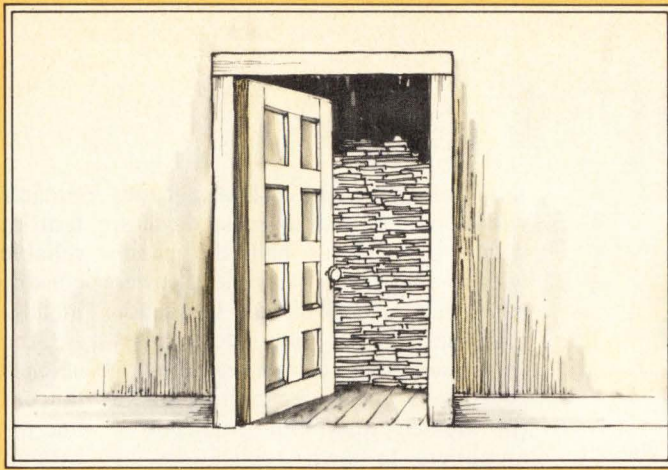

A roomful of boards.

How a leading manufacturer of electronic products repaired over 10,000 defective boards in 30 days using Zehntel's in-circuit tester.

What to do when you've accumulated over 10,000 defective circuit boards?

A major manufacturer of consumer products faced this problem recently.

The boards had piled up because it took technicians an average of over an hour to locate problems and repair a board.

This company got out of the dilemma with a Zehntel TROUBLESHOOTER test system.

Incredible but true, over 10,000 defective boards were diagnosed and repaired in 30 days, using Zehntel's in-circuit inspector.

The roomful of boards evaporated!

Test time per board was reduced to a few seconds with Zehntel's in-circuit measuring techniques which isolate and measure each component and node.

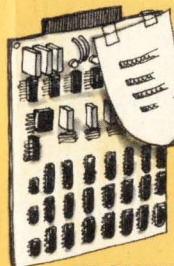

And since TROUBLESHOOTER prints out all of the defects on a board that failed, a technician could repair a bad one in just a few minutes.

Zehntel's in-circuit test system paid for itself on this cleanup job alone — and during the 30 day period also did regular production testing.

This is not an isolated case . . .

Zehntel in-circuit test systems are reducing test/repair time for many of the country's largest companies who build TV sets, AM-FM radios, CB's, automotive

electronics, medical equipment, computer peripheral instruments — literally all kinds of industrial and consumer products. In fact, our customer list reads like "Who's who in electronics".

Easy to use

Using our tester, non-technical operators can inspect hundreds of boards daily. The operator merely puts the board on our test fixture and pushes the start button. If the board is good, that's it. If the board fails, precise rework instructions are automatically printed. Typical test time: 5 to 30 seconds!

Summing up the advantages — TROUBLESHOOTER:

- Tests a wide variety of products
- Detects and pin points single or multiple defects on an entire assembly in seconds

- Eliminates need for technically-oriented operator
- Prints specific rework instructions for defective assemblies
- Is easy to program since each step deals with a single component
- Adapts to any flat assembly regardless of its complexity
- Can generate statistical data on component failures



Zehntel,® Inc.

2440 Stanwell Drive, Concord, CA 94520
Tel: (415) 676-4200 • TWX: 910-481-9471



SEE US AT NEPCON BOOTH 349

Circle 141 on reader service card

New products

Microwave

Uhf transistor offers flat gain

Device holds gain of 6 dB over bandwidth of 112 MHz and puts out 50 watts

For years, designers of ultra-high-frequency equipment have had to make tradeoffs among bandwidth, gain, and performance specifications. When one parameter is optimized, the other two are usually compromised. Now, however, Communications Transistor Corp. has designed a 50-watt uhf transistor—the CM50-12A—that operates from 400 to 512 megahertz in a broad-band configuration with no degradation in performance.

A key specification for the 12.5-volt device is a power gain of 6 dB across the 400-to-512-MHz band, typically for a power input of 12.5 watts. Gains of previous devices have been 10 to 100 times lower, says CTC. They typically require 15 to 17 w of input power for the same output of 50 w. In addition, this 6 dB of gain is

flat over the entire 112-MHz bandwidth, in contrast to most devices, which have about half the bandwidth—about 60 MHz—and a power gain that drops off as frequency increases, points out CTC. James McDaniel, product marketing manager, says these capabilities make the device ideal for high-power amplifiers in such applications as land-mobile communications.

The CM50-12A is made with standard bipolar power-transistor processing technology. The key to the device's enhanced performance is in the use of a semiautomated assembly process to reduce parasitic inductance as well as increase internal input-matching. The bonding wires in most devices are manually placed between the emitter-collector stages and the MOS-capacitor and base stages, but CTC engineers have developed a semiautomated system.

"The drawback to the old approach is that the spacing between bonding wires was highly variable," says McDaniel. "The closer together they are, the higher the parasitic inductance and the worse the performance." The new approach assures maximum separation and therefore more consistent, flatter performance.

Another advantage of the ap-

proach is repeatability and the resultant increase in yields. The device is reliable because of its simple chip construction and aluminum-copper metalization, McDaniel says.

Other features include a collector efficiency of 60%, low thermal resistance, low-inductance ceramic strip-line packages, and hermetic seal for extended life in hostile environments. In 100-piece quantities, the CM50-12A is priced at \$32.80 each. It is available from stock.

Communications Transistor Corp., A Varian Associates Subsidiary, 301 Industrial Way, San Carlos, Calif. 94070 [401]

Low-noise transistors operate from 1 to 4 GHz

Two silicon bipolar transistors are intended for use in low-noise amplifiers operating in the range from 1 to 4 gigahertz. Model HXTR-6103, which has a maximum noise figure of 2.2 decibels along with a minimum associated gain of 11 dB at 2 GHz, is offered as a replacement for the Fairchild FMT 4005. It has a small-quantity price of \$55.

Model HXTR-6104 has a maximum noise figure of 1.6 dB at 1.5 GHz. Its minimum associated gain is 13 dB, and its small-quantity price is \$120. Both ion-implanted devices are housed in a hermetic metal/ceramic package, and both can meet the requirements of MIL-S-19500 and the test requirements of MIL-STD-750/883. The two transistors are available from stock.

Hewlett-Packard Co., 1501 Page Mill Rd., Palo Alto, Calif. 94304 [403]

Coaxial cable contains impedance transformer

By being integrated into a length of semirigid coaxial cable, an impedance transformer does not need the up to four connectors that a discrete series transformer would need. The unit in the photo (p. 144) has an octave bandwidth centered at 1.65 GHz. Built using UT-85 cable, it

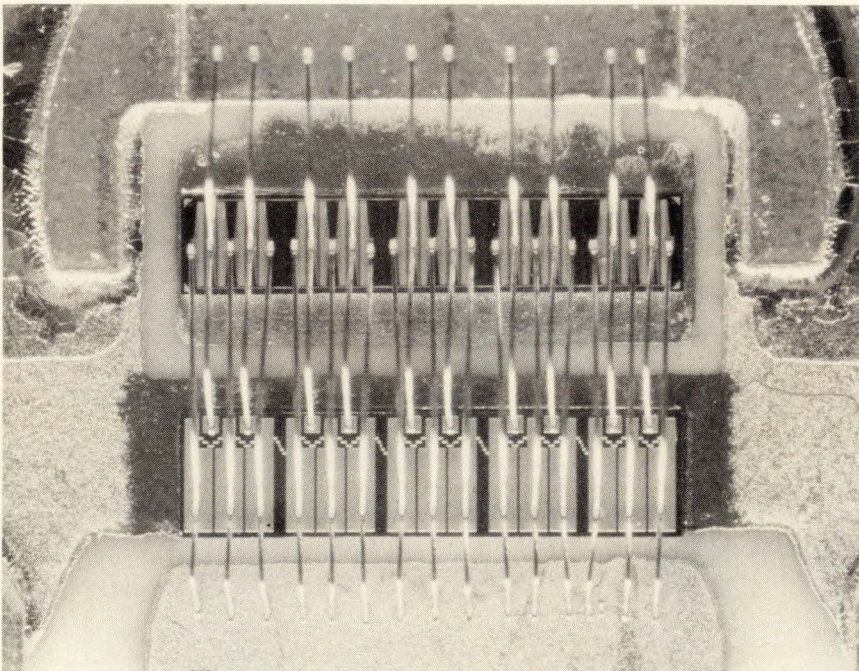

FEATURE ARTICLES FROM *ELECTRONICS* AVAILABLE IN REPRINT FORM

No. of
copies
wanted

New reprints

- ___ R-703 Special report—memories 16 pp \$3.00
- ___ R-702 World market report 1977 24 pp \$4.00
- ___ R-616 Special issue—technology update \$4.00
- ___ R-614 Power supply choices for sophisticated designs 8 pp \$3.00
- ___ R-612 Fiber-optic communications special report 24 pp \$3.00
- ___ R-610 Special report on hybrid-circuit technology 19 pp \$3.00
- ___ R-606 Special issue—microprocessors \$4.00
- ___ R-526 How reliable are today's components 16 pp \$3.00

Charts

- ___ R-516 Electronic symbols \$2.00
- ___ R-213 Electromagnetic spectrum (updated 1976) \$3.00
- ___ R-326 Optical spectrum (6-page report and chart) \$3.00

Books

- ___ R-704 Thermal design in electronics \$5.00
- ___ R-701 Applying microprocessors—Electronics Book Series \$9.95
- ___ R-608 Basics of Data Communications—Electronics Book Series \$12.50
- ___ R-602 Large Scale Integration—Electronics Book Series \$9.95
- ___ R-520 Microprocessors—Electronics Book Series \$8.95
- ___ R-011 Computer-aided Design 135 pp \$4.00
- ___ R-032 Active Filters 88 pp \$4.00
- ___ R-031 Circuit Designer's Casebook 182 pp \$5.50 (outside U.S. \$12.00)

Other Reprints

- ___ R-600 World market report 1976 24 pp \$4.00
- ___ R-524 Special report on bipolar large-scale integration 12 pp \$3.00
- ___ R-522 Special report on power semiconductors 12 pp \$3.00
- ___ R-518 Special issue—productivity \$4.00
- ___ R-514 Eight ways to better radio receiver design 6 pp \$3.00
- ___ R-512 Design of circuits for dangerous environments 4 pp \$2.00
- ___ R-510 Bipolar integration advances with μ L microprocessor 8 pp \$2.00
- ___ R-508 Designing microprocessors with standard logic 12 pp \$3.00
- ___ R-506 The case for component burn-in 7 pp \$2.00
- ___ R-434 Designing automated systems with the new standard interface 12 pp \$3.00
- ___ R-432 An update on communications satellites 8 pp \$2.00
- ___ R-430 Choosing the right bipolar transistor model for computer-aided design 20 pp \$3.00
- ___ R-428 Designing with low-cost lasers 6 pp \$2.00
- ___ R-424 Microprocessor applications 28 pp \$3.00
- ___ R-422 A microprogrammable minicomputer 8 pp \$2.00
- ___ R-420 Computerized text-editing and typesetting 8 pp \$2.00
- ___ R-418 Computer analyses of rf circuits 8 pp \$2.00
- ___ R-414 The ion-implanted n-channel process 6 pp \$2.00
- ___ R-412 Liquid cooling of power semiconductors 6 pp \$2.00
- ___ R-410 Special report on passive components 16 pp \$3.00
- ___ R-406 Designing with the new logic, C-MOS and bipolar 16 pp \$3.00
- ___ R-324 Semiconductor memories are taking over data-storage applications 16 pp \$3.00
- ___ R-322 Special report: new displays complement old 10 pp \$2.00
- ___ R-320 Special report on designing with flat cable 14 pp \$3.00
- ___ R-318 Special report on auto electronics 16 pp \$3.00
- ___ R-316 Hybrid circuits solve tough design problems 16 pp \$3.00
- ___ R-310 Penetration color tubes are enhancing information displays 6 pp \$2.00
- ___ R-308 Program for transition from non-linear to linear transistor model 6 pp \$2.00
- ___ R-306 Charge-coupling improves its image, challenging video camera tubes 8 pp \$2.00
- ___ R-211 Electromagnetic spectrum 16-page report \$2.00
- ___ R-209 Semiconductor RAMs land computer mainframe jobs 15 pp \$2.00
- ___ R-207 Technology gap starts to close for computer peripherals 16 pp \$3.00
- ___ R-205 Bridging the analog and digital worlds with linear ICs 16 pp \$3.00
- ___ R-133 Optoelectronics makes it at last 34 pp \$4.00
- ___ R-104 The new concept for memory and imaging: charge-coupling 12 pp \$2.00

Payment must accompany your order

Make check or money order payable to Electronics Reprints. All orders are shipped prepaid by parcel post. Allow two to three weeks for delivery.

Back issues now available:
1960 to 1969, \$5.00 each
1970 to 1973, \$3.00 each
1974 to 1976, \$4.00 each

USE THIS PAGE AS YOUR ORDER FORM

Cost of orders \$ _____
Plus 10% handling charge \$ _____
TOTAL AMOUNT ENCLOSED \$ _____

Mail your order to:
Janice Austin
ELECTRONICS REPRINTS
P.O. Box 669
Hightstown, N.J. 08520

SEND REPRINTS TO

Name _____
Company _____ Dept. _____
Street _____
City _____ State _____ Zip _____

MILITARY APPLICATIONS

AD CONVERTERS

by

MSK

Accuracy

Speed

Size

Repairability

Military

Temp. Range
-55°C to +125°C

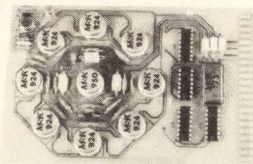

- 4 Bit/50 nSec; Low Cost
- Ideal for Radar Scan Converters
- Holds Absolute Accuracy Over Temperatures
- Tracks a 10 MHz Analog Input

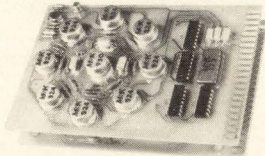

- 9 Bit/ 200 nSec.
- < 2 Bit Drift Over Temperature
- Insensitive to Clock Frequency

For Further Information Call or Write

M.S. Kennedy Corp.

Pickard Drive, Syracuse, New York 13211

Tel. 315-455-7077

144 Circle 144 on reader service card

New products

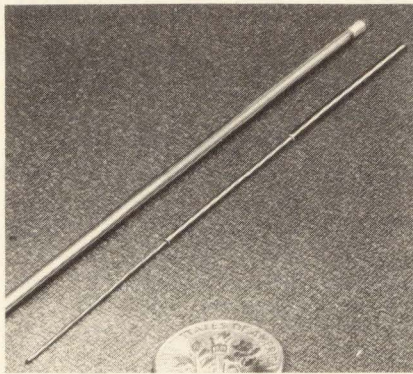

transforms between 10 and 50 ohms with a VSWR of 1.5.

Impedances between 10 and 100 ohms are available. Among the parameters to be specified by the customer are cable length and shape, frequency, bandwidth, insertion loss, and VSWR into a test fixture or termination.

Uniform Tubes Inc., Micro-Delay Division, Collegeville, Pa. 19426 [404]

SWR bridge covers
2 to 18 gigahertz

The model 5282 precision SWR bridge has a minimum directivity of 35 decibels over the frequency range from 2 to 18 gigahertz. Designed to replace several couplers in swept systems or several slotted lines in fixed-frequency systems, the bridge is accurate to within $0.018 + 0.13R^2$, where R is the reflection coefficient being measured.

The bridge comes equipped with precision type-N connectors on its input and output ports and a precision 7-millimeter connector on its test port. It is supplied with a set of 7-mm precision adapters for the test port and short- and open-circuit

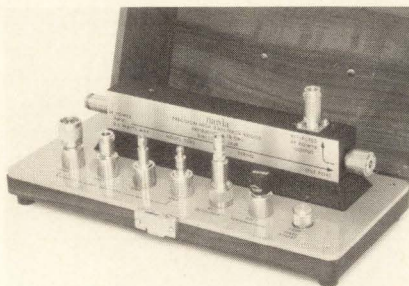

VAC
VACUUMSCHMELZE

VACUZET®

a semi-hard magnetic alloy with rectangular hysteresis loop for impulse controlled self latching relays.

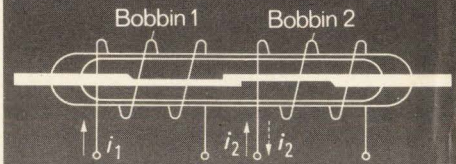

Properties:

- high remanence
- adjustable coercitive force

VACUZET 200 258 655 923

H _c	A/cm	15	30	50	75
B _r	T	1.5	1.45	1.45	1.25
B _r /B ₁₀₀	%	ca. 90			

For data sheet and further information apply to

VACUUMSCHMELZE GMBH

6450 HANAU

W.-Germany · POB 109

Circle 179 on reader service card



The Small Computer

Twenty-five years ago a computer as powerful as the new Processor Technology Sol-20 priced out at a cool million.

Now for only \$995 in kit form or \$1495 fully assembled and tested you can have your own small computer with perhaps even more power. It comes in a package about the size of a typewriter. And there's nothing like it on the market today. Not from IBM, Burroughs, DEC, HP or anybody else!

It fills a new role

If you're an engineer, scientist or businessman, the Sol-20 can help you solve many or all of your design problems, help you quantify research, and handle the books too. For not much more than the price of a good calculator, you can have high level computer power.

Use it in the office, lab, plant or home

Sol-20 is a smart terminal for distributed processing. Sol-20 is a stand alone computer for data collection, handling and analysis. Sol-20 is a text editor. In fact, Sol-20 is the key element of a full fledged computer system including hardware, software and peripheral gear. It's a computer system with a keyboard, extra memory, I/O interfaces, factory backup, service notes, users group.

It's a computer you can take home after hours to play or create sophisticated games, do your personal books and taxes, and a whole host of other tasks.

Those of you who are familiar with small computers will recognize what an advance the Sol-20 is.

Sol-20 offers all these features as standard:

8080 microprocessor — 1024 character video display circuitry — control PROM memory — 1024 words of static low-power RAM — 1024 words of preprogrammed PROM — built-in cassette interface capable of controlling two recorders at 1200 bits per second — both parallel and serial standardized interface connectors — a complete power supply including ultra quiet fan — a beautiful case with solid walnut sides — software which includes a preprogrammed PROM personality module and a data cassette with BASIC-5 language plus two sophisticated computer video games — the ability to work with all S-100 bus products.

Full expansion capability

Tailor the Sol-20 system to your applications with our complete line of peripheral products. These include the video monitor, audio cassette and digital tape systems, dual floppy disc system, expansion memories, and interfaces.

Write for our new 22 page catalog. Get all the details.

Processor Technology, Box J, 6200 Hollis St.,
Emeryville, CA 94608. (415) 652-8080.



The M-600 amp works harder at 2.5 ohms

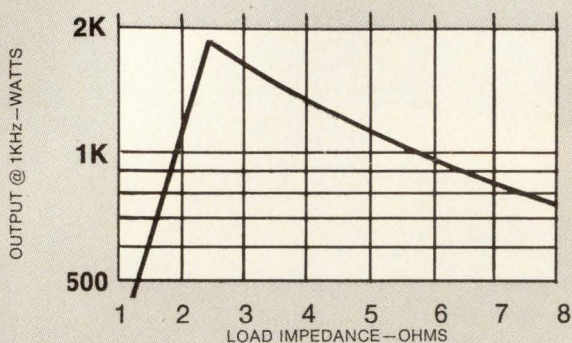

So each watt costs less

You get more watts per dollar from the Crown M-600 power amp if your circuit design lets it look at a 2.5 Ω load.

The M-600 provides power from DC to 20KHz with complete protection against shorts, open circuits, mismatch, RF burnout and thermal overload. The M-600 will even drive a purely reactive load without overheating. Designed for continuous operation at full rated power, at any rated frequency.

One M-600 will cost you \$1,795. A copy of the spec sheet is free. Write today.

We'd also like to hear from you if you have any special amplification problems in the DC-20KHz range. We've already solved some tough, unique problems. We'd like to consider yours.

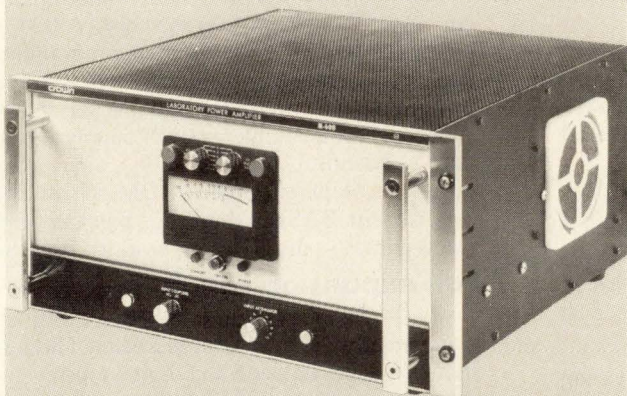

CROWN
INDUSTRIAL

1718 W. Mishawaka Road, Elkhart, Indiana 46514

219/294-5571

New products

terminations that are intended to facilitate calibration.

Narda Microwave Corp., Plainview, N.Y. 11803. Phone J.P. Schindler at (516) 433-9000 [405]

Compact coaxial relay has VSWR of 1.5 at 18 GHz

A miniature coaxial relay that occupies less than 0.75 cubic inch has a maximum VSWR of 1.2 from dc to 4 gigahertz, 1.3 from 4 to 12.4 GHz, and 1.5 from 12.4 to 18 GHz. Over these same bands the minimum isolation is 80, 70, and 60 dB, respectively, while the maximum insertion losses are 0.1, 0.2, and 0.3 dB.

The single-pole two-position device is fitted with SMA connectors and weighs 2 ounces. High-density packaging techniques result in the overall volume of 0.75 cubic inch. Priced at \$99 in small quantities, the switch is available from stock.

RLC Electronics, Sales Dept., 83 Radio Circle, Mt. Kisco, N.Y. 10549 [408]

TOPICS

Microwave

Systron-Donner Corp., Advanced Components Div., Sunnyvale, Calif., has added an 8-to-18 GHz unit to its line of YIG-tuned Gunn oscillators. The model SDYX-3001-111 puts out a minimum of 10 milliwatts and sells for \$1,530. . . **Varian's Microwave Tube Division, Palo Alto, Calif.**, has introduced a line of grid-pulsed traveling-wave tubes for airborne and surface radar applications. Between them, the five tubes cover the frequency range from 8.6 to 9.9 GHz. Peak-power ratings range from 15 kilowatts to 50 kW. . . **Microwave Semiconductor Corp., Somerset, N.J.**, has announced its series MSC9000 line of solid-state power amplifiers. The 35 models in the line cover the frequency range from 570 megahertz to 2.7 GHz and put out up to 20 watts.

VACTEC Photodetectors

The Industry's Broadest Line Provides More Semiconductor Detectors for More Design Applications

Vactec serves manufacturers of a wide range of modern electronic products. Pictured are a few examples. All these devices are both made and sold by Vactec, including complete lines of LDR's (photoconductive cells, CdS and CdSe); silicon solar cells, as well as silicon high speed and blue enhanced cells; NPN phototransistors and darlington's; opto-couplers (LED/LDR, lamp/LDR and neon/LDR); selenium photovoltaic cells; silicon photodiodes, blue enhanced and PIN; and custom C-MOS and bi-polar IC's. Write for technical bulletins on the types that suit your requirements. Or send your application, and Vactec will recommend the right cell for the job.

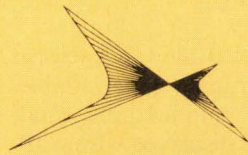

Vactec, Inc.

2423 Northline Industrial Blvd.
Maryland Heights, Mo. 63043
(314) 872-8300

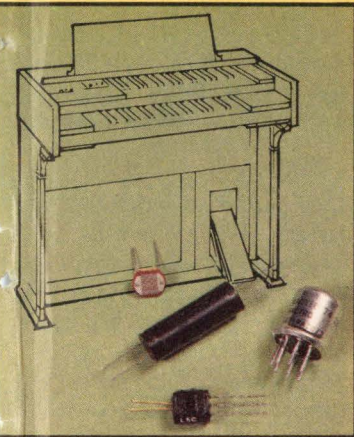

Electronic Organs

LED or lamp/LDR Vactrols for audio, and CdS cells for swell pedal controls.

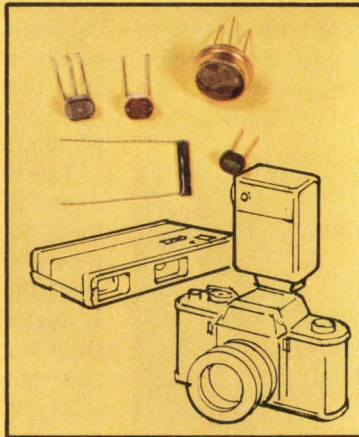

Cameras and Projectors

CdS or blue enhanced silicon photodiodes for automatic shutter timing; aperture servo systems for automatic projector focus; and slave flash controls.

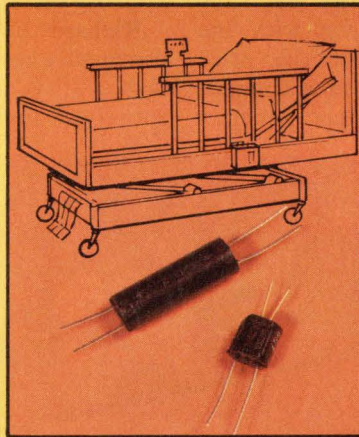

Triac Motor Controls

A special Vactrol gates a triac for forward and reverse motor operation as in hospital beds.

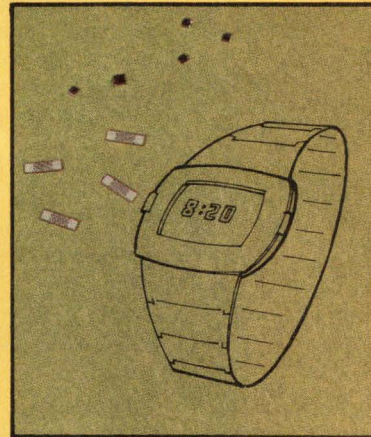

LED Watches

Photoconductive or phototransistor chip controls LED brightness.

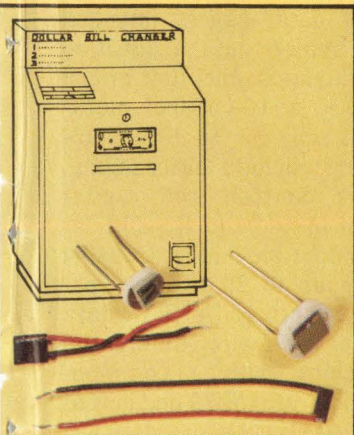

Dollar Bill Changers

Silicon photovoltaic cells analyze optical characteristics.

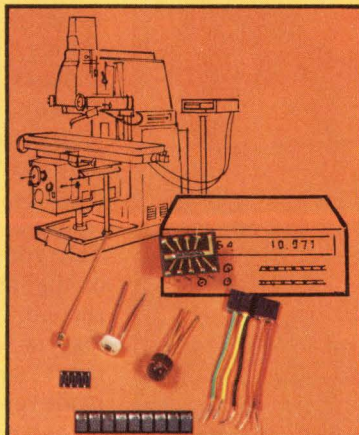

Machine Tool Controls

High-speed photovoltaic cells or transistor arrays help computer control repetitive operations, non-contact sensing, and counting and weighing.

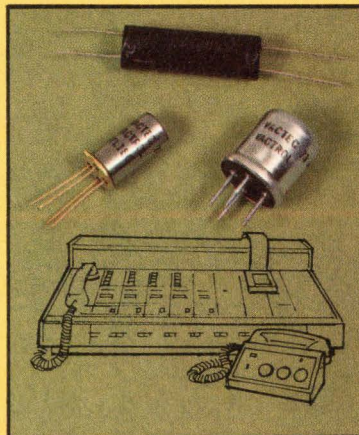

Telephone Equipment

Neon/LDR Vactrols sense ringing. Direct a-c coupling, slow LDR response isolates electronics from noise.

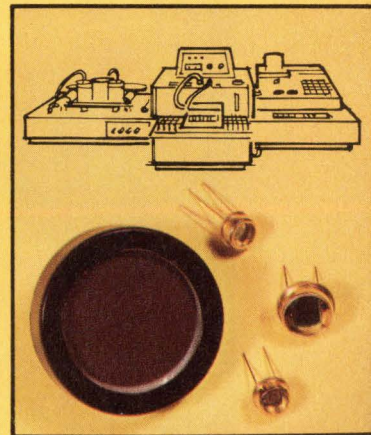

Scientific Instruments

Blue enhanced silicon or selenium photovoltaic cells detect solutions densitometrically for precise blood chemistry and other analyses.

Industrial

Thermometer sells for \$189

Rugged digital instrument
is accurate to within 0.5°
when using standard probe

Designers at ECD Corp., Cambridge, Mass. were aiming for a couple of key capabilities when they began to design a digital thermometer: they wanted it to be rugged enough to withstand the jolts of a maintenance worker's tool box and to be as accurate as more expensive bench-top instruments. They say they have achieved these objectives with the T-Meter and have cut the price substantially below those of competing digital industrial thermometers

that are currently on the market.

The T-Meter, which sells for \$189, can measure and show temperature in either fahrenheit or celsius—selectable by a switch—on its 0.6-inch-high liquid-crystal display. The celsius range is from -100° to +30°, and the fahrenheit range is from -150° to +400°. With its standard probe, included in the base price, the T-Meter delivers accuracies to within $\pm 0.5^{\circ}\text{C}$ while measuring -55° to +125°C, or $\pm 0.9^{\circ}\text{F}$ between -67° and +257°F, according to the company.

Optional probes with accuracies to within $\pm 0.1^{\circ}\text{F}$ ($\pm 0.056^{\circ}\text{C}$) in selected temperature ranges are available for specialized applications, and temperatures are displayed within 10 seconds for the initial reading and updated each 0.8 s after that.

Richard Eckhardt, an ECD vice president who designed the T-Meter, says, "It is a rugged tool that's entirely sealed, is immersible, and

takes impact well. You can throw it in a tool box and dump wrenches on top of it."

All of the circuitry is cast in urethane foam and epoxy, and the thermometer's probes and cables are Teflon-coated to make them virtually impervious to shock, moisture or chemicals, he points out.

Edward W. Costello, marketing director, adds that a variety of probes is available so that users can change them without having to recalibrate the instrument. He says these probes make the T-Meter an inexpensive tool for measuring the temperature of chemical baths; of electronic components such as semi-conductors during wave soldering, for example; or of batches of food during processing. He expects it to find wide use in other industrial and commercial applications, including repair of air-conditioning systems, the biomedical-equipment field, oceanography, and processing photographic film.

Temperature is displayed in four digits, and there are also indicators for a low battery level or a faulty probe. The four type-N batteries will last 2,000 hours when the instrument is used 40 hours a week. Delivery is from stock.

ECD Corp., 196 Broadway, Cambridge, Mass. 02139. Phone Edward Costello at (617) 661-4400 [371]

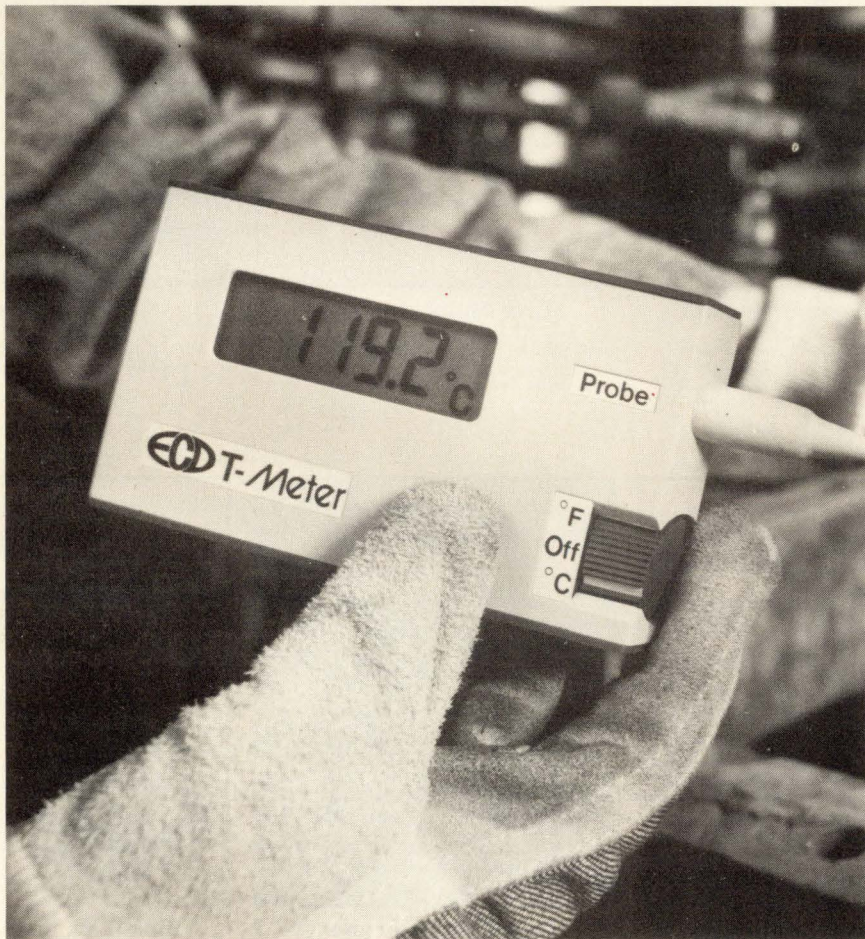

Remote-data logging gets less expensive

A series of data loggers intended mainly for remote-data acquisition includes a single-channel unit priced at only \$995. A 10-channel multiplexing unit sells for \$1,300. Standard features include autoranging, digital-clock control, and digital transmission in ASCII to RS-232- or Teletype-compatible units. Capable of digitizing up to 30 readings per second, the series 14 TY data loggers offer two-wire differential input switching with a common-mode rejection ratio of 70 decibels at 60 hertz.

Best suited for remote operation

The Sinclair DM2 digital multimeter.

3½ digits...

5 functions...

Fully portable...

Under \$100!

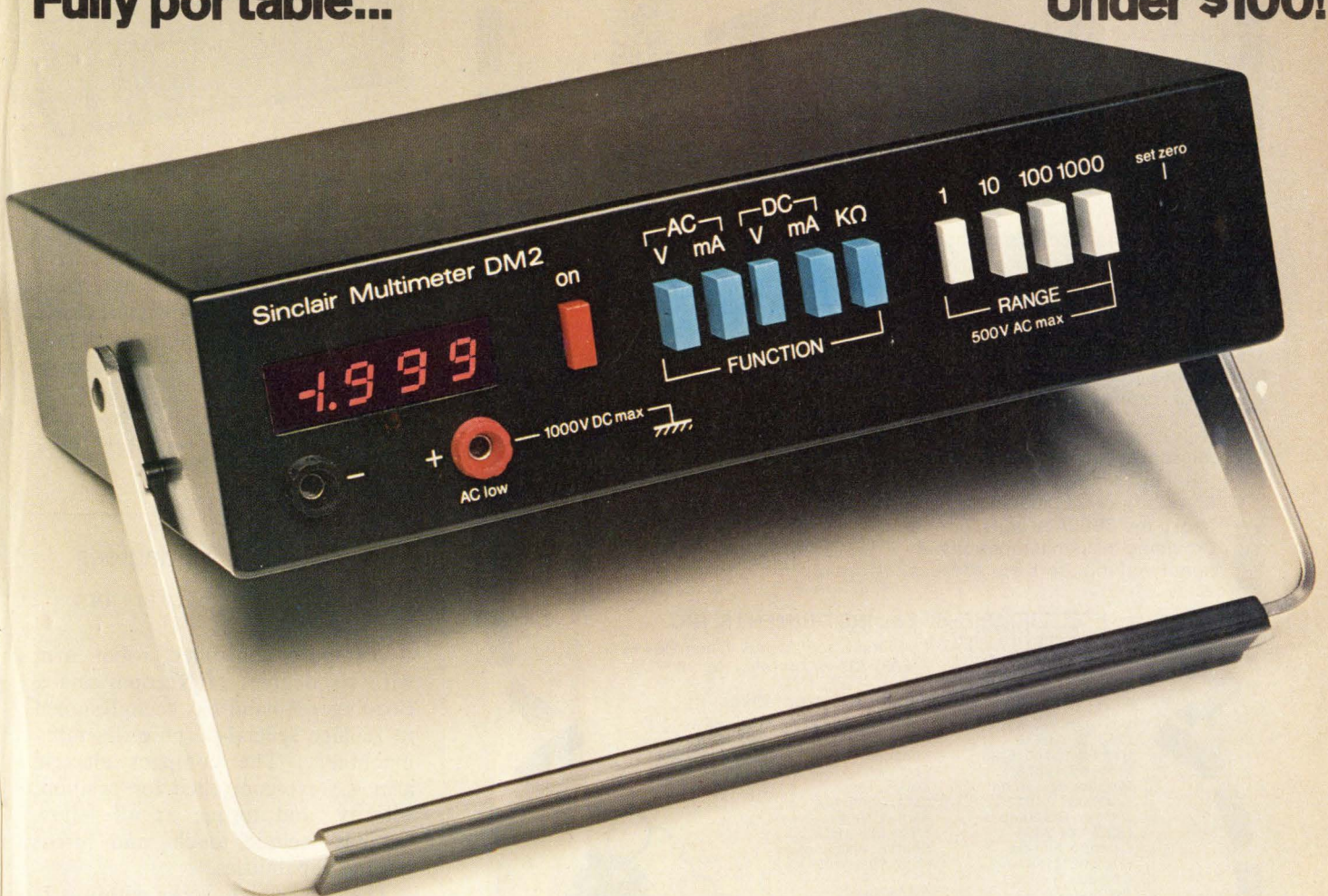

The DM2 provides full digital multimeter facilities for every application including field servicing, testing and laboratory work. Over 15,000 are already in service.

Display

Full 3 1/2 digit display reading to ± 1999 . Large, high-brightness 8 mm LEDs giving clear readings with maximum reliability. Automatic polarity and out-of-range indication.

Ranges

2 functions giving 22 ranges.
DC volts -1 mV to 1000 V
AC volts -1 mV to 500 V
DC current -0.1 μ A to 1 A
AC current -1 μ A to 1 A
Resistance -1 Ω to 20 M Ω
10 M Ω input impedance

Accuracy

High stability integrating A to D converter. Basic accuracy 0.3% ± 1 digit.

Convenience

Automatic polarity. Push-button selection of both functions and ranges from a single-input terminal pair.

Construction

Very rugged mechanical construction with all solid-state components. Fully protected against overload.

Portability

Measures only 56 mm x 160 mm x 224 mm, weighs only 1.25 kg. Basic operation from dry cells providing complete independence of AC supply. Line operation available via optional AC adaptor/charger.

Optional extras

Rechargeable battery pack \$19.95.
Carrying case \$9.95.
AC adaptor/charger \$4.95.

12-month no-quibble guarantee

Sold for more information - now!

If you want more information about the Sinclair Multimeter, clip the coupon. We'll mail you a fact-pack - giving full

specifications, and an up-to-date list of stockists.

sinclair

Sinclair Radionics Inc.,
Galleria, 115 East 57th Street,
New York, N. Y. 10022, USA.
Tel: (212) 355 5005.

To: Sinclair Radionics Inc.,
Galleria, 115 East 57th Street,
New York, N. Y. 10022, USA.

Please send me more information on the Sinclair DM2 Multimeter.

Name _____

Address _____

City _____

State _____

Zip _____

Certain territories still available for stocking presentation. Enquiries to Chris Childs at Sinclair Radionics Inc., New York.

Circle 149 on reader service card

What good is a Micro-Computer if you can't make it work?

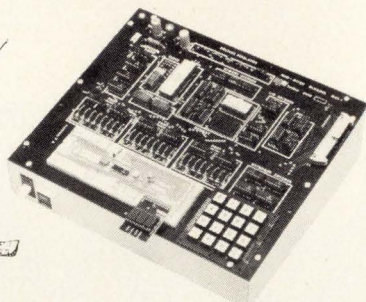

Startup time on micro-computers can be a real problem. We know that. That's why we've developed The Mini-Micro-Designer. The first complete package of hardware, software and educational materials. All with one purpose: to speed microprocessor system design.

How? By providing the only microprocessor test and development system with solderless breadboarding capabilities. At its heart: the 8080A processor chip, providing all signal functions. A panel that monitors the address

and data buses of the micro-processor and allows data I/O with or without an asynchronous terminal. And the Bugbook V, E&L's innovative approach to self-teaching micro-electronics.

So experiment. Design. Test. Because now there's a system that's caught up with imagination. The Mini-Micro-Designer from E&L Instruments. \$422.50 suggested U.S.A. resale price. Contact your local representative listed below. OEM and educational discounts available.



E&L INSTRUMENTS, INC.

61 First Street, Derby, Conn. 06418
(203) 735-8774 Telex No. 96 3536

Authorized Stocking Representatives

Los Angeles, Calif.
(213) 377-0975
San Francisco, Calif.
(415) 961-2828
Woodbridge, Conn.
(203) 397-1461
Denver, Colorado
(303) 744-2501
Orlando, Florida
(305) 351-1841
Chicago, Illinois
(312) 956-8090
Kansas City, Kansas
(913) 649-8952
New York, N.Y.
(201) 467-8585
Syracuse, N.Y.
(315) 699-2651

Dayton, Ohio
(513) 222-0011
Philadelphia, Pa.
(215) 723-8733
Dallas, Texas
(214) 328-5484
Fairfax, Virginia
(703) 273-1803
Seattle, Washington
(206) 938-4166

Canada
Edmonton, Alberta
(403) 455-4122
Winnipeg, Manitoba
(204) 774-6286
or 772-9295

Vancouver,
British Columbia
(604) 687-2621

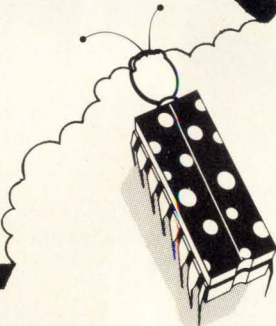

Circle 150 on reader service card

CAREER OPPORTUNITIES

Usually the best opportunity to grow in your field lies within your present company. You have made an investment in them. They have an investment in you.

But occasionally the best opportunity lies somewhere else. No one can decide but you.

Companies looking for good people run their recruitment ads in our Classified Section in the back of this magazine. Perhaps you'll find an opportunity there that's worth following up.

New products

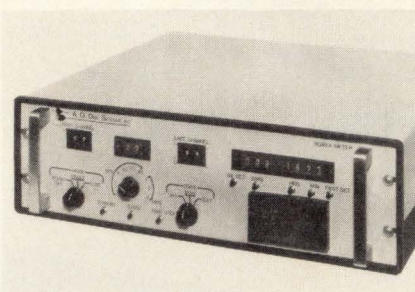

where the data can be transmitted over telephone lines, the series includes units with up to 1,000 channels. Available options include back-up battery operation, a digital clock, an ASR33 Teletype unit, a paper-tape punch, and a magnetic-tape-cassette drive.

A.D. Data Systems Inc., P.O. Box 9209, Rochester, N.Y. 14625. Phone Harry Turner at (716) 381-2370 [373]

Robot arm has six degrees of freedom and two fingers

A computer-controlled robot arm with six degrees of freedom and a two-fingered hand has been designed to replace special-purpose assembly machinery. The compact electric arm is servo-controlled for position, velocity, and torque at all joints. Options include touch- and force-sensing capabilities.

The unit, which works within a 2-meter sphere, has a maximum loading rating of 4 kilograms. It completes most of its motions within 2 seconds. Complete with control system, microcomputer, and analog-to-digital and digital-to-analog converters, the arm sells for \$48,000.

Vicarm Inc., 154 East Dana St., Mountain View, Calif. 94041. Phone (415) 965-0557 [374]

Digital thermometer uses plug-ins for versatility

A portable four-digit thermometer uses Leeds & Northrup Quick-Disconnect thermocouple probes to handle a wide variety of temperature-measuring applications quickly

High-Frequency Transistor Reliability:

Cool logic and cold facts

1. In high-frequency power switching, heat is a prime factor in transistor failure.

2. Turn-off time is the dominant cause of destructive temperature rise.

3. The faster the turn-off, the cooler the transistor, the greater the reliability.

Take a look at competitive transistors in an actual 20 KHz bridge converter circuit:

EDI

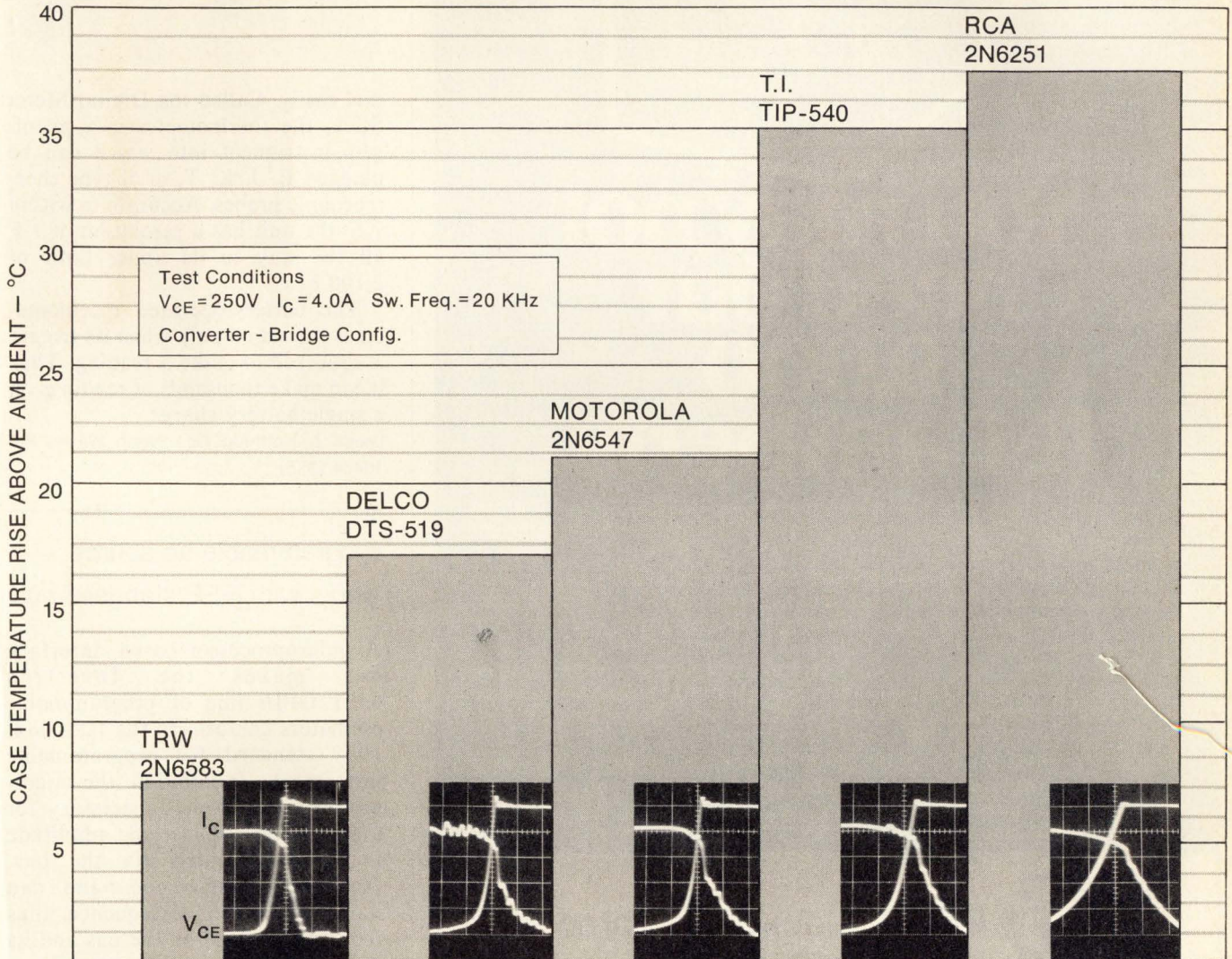

TRW delivers the lowest operating temperatures and the greatest reliability in high-frequency off-line switching regulators.

And **that's** no small thing. When you need superior performance at high frequencies, the best combination of switchoff time and energy capability add up to greater efficiency and longer life. And what circuit are you about to design that doesn't deserve the best?

Particularly when TRW discretes are not only competitively priced, but are also immediately available in any quantity.

But get all the facts on TRW's high-frequency discrete transistors. Use the coupon or telephone John Power at (213) 679-4561.

TRW Power Semiconductors

An Electronic Components Division of TRW, Inc.,
 14520 Aviation Boulevard, Lawndale, California 90260

Please send me data sheets on TRW's switching power transistors.

Have an applications engineer contact me _____ (Phone Number)

Name _____

Company Name _____

Position _____

Address _____

City _____ State _____ Zip _____

E

TRW POWER SEMICONDUCTORS

ANOTHER PRODUCT OF A COMPANY CALLED TRW

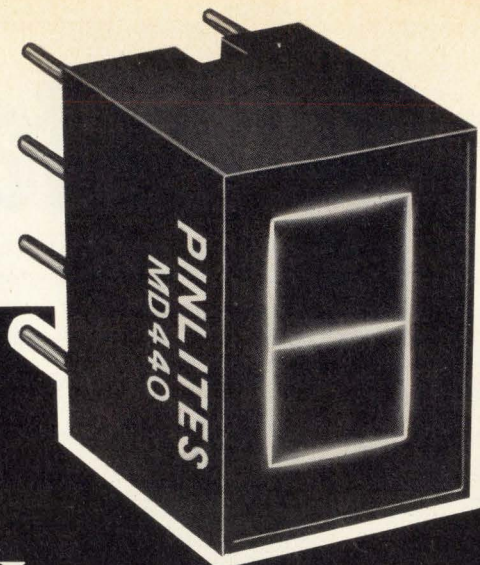

You may not need our 9,000 ft. Lamberts.

Some applications don't require the unusual brightness of a Pinlites directly-viewed incandescent display. But when brightness is important to you, there's no finer choice than Pinlites.

The low power 1/4" model MD-440, above, for instance, produces a dazzling 9000 ft.-lamberts. That, coupled with our 80:1 contrast ratio, means characters are clearly visible even in direct sunlight. And with simple voltage reduction they can be dimmed for night use.

Pinlites numeric and alphanumeric displays offer a 120° viewing angle and are filterable to a wide range of colors. They are available in character heights ranging from 3/16" to 5/8". And provide an average life of over 100,000 hours per segment.

Popular applications include aircraft cockpits, marine navigation, computer peripheral equipment, taxi meters and gas pump readouts.

For a quick answer to your questions, give us a call. We promise a display of brilliance.



REFAC electronics corporation

P.O. BOX 809 • WINSTED, CONN. 06098 • 203-379-2731

Circle 152 on reader service card

HELP WANTED

While it is not our policy to encourage job hopping—quite the opposite, in fact—the headline above must have got your attention for a reason.

Perhaps you should turn to the back of this issue to our Classified Section. One of the job descriptions might fit you.

New products

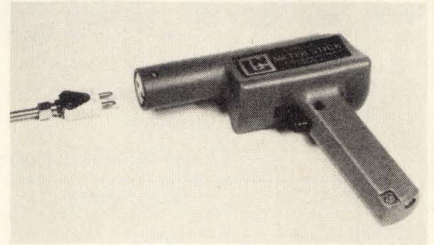

and easily. Called the Digital Meter Stick, the thermometer is a pistol-grip instrument into which can be plugged E, J, K, T, or S type thermocouple probes. Accurate to within 7°F, the unit has a resolution of 1°F all the way to its upper limit of 2,100°F.

The battery-operated thermometer is turned on only when its trigger is squeezed to make a reading. Thus it can make thousands of readings on a single battery charge.

Leeds & Northrup Co., North Wales, Pa. 19454 [375]

Programmable ac source works with IEEE standard bus

A microprocessor-based interface bus makes the Invertron 830T/GPIB line of programmable oscillators conform to the IEEE 488-1975 standard for programmable instruments. In addition, the microprocessor makes it unnecessary for every change of phase and amplitude to be commanded via the bus. Instead, a single command can initiate a predefined sequence, thus reducing the load on the bus and its controller.

In a three-phase ac system, six parameters can be programmed: system frequency, phase-angle B, phase-angle C, and three amplitudes. Manual control by means of thumbwheel switches is provided, along with optional front-panel displays, for nonautomatic operation. Power-input requirements are 105 to 125 volts rms, and operating temperature range is 0°C to 55°C.

Two-phase systems are also offered. Prices start at \$2,150.

Aiken Industries, California Instruments Division, 5150 Convoy St., San Diego, Calif. 92111. Phone (714) 279-8690 [377]

HERE'S HOW TO...

Up-date your electronics know-how
with minimum cost, time,
and effort...

for top potential return in
job opportunities...

The brand-new McGraw-Hill Course in Continuing Education for Electronics Engineers **ELECTRONIC CIRCUIT DESIGN WITH SOLID-STATE DEVICES**

8 no-frills self-study lessons do it!

Let a panel of top electronics experts help put you up front in the newest, hottest areas around today...

- ▶ How to bring yourself up to date with actual information you can use on the job
- ▶ How to design electronic circuits for various applications with the use of solid-state devices and the design data the Course gives you
- ▶ How to understand and design linear, differential, and operational amplifiers
- ▶ How to apply digital and linear integrated circuits in many fields

PLUS these special extras:

- ▶ Master Outline & Course Guide
- ▶ Study Guides for Each Lesson
- ▶ Self-checking Quizzes
- ▶ Electronic Circuits Portfolio (with Lesson 5)
- ▶ Final Exam and Course Completion Certificate

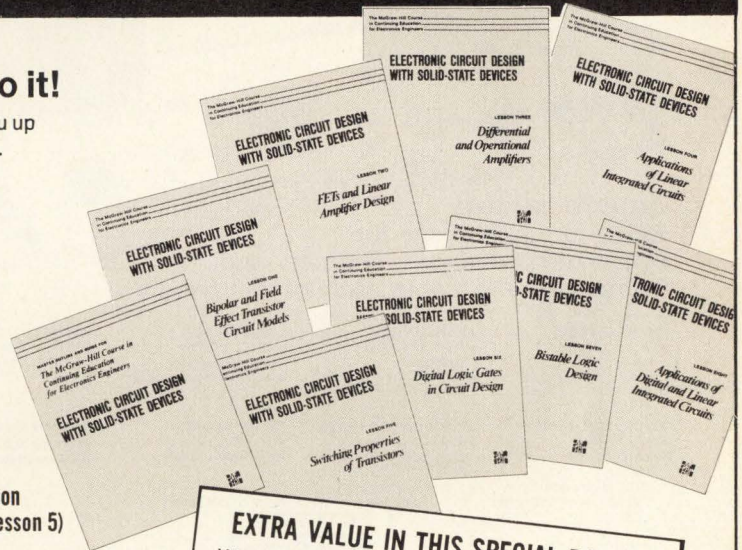

You Can Examine Lesson One and the Master Outline and Guide FREE for 10 Days Before You Decide You Want to Take the Whole Course!

Simply complete and return the "Operation Update" Reply Card and McGraw-Hill will send you LESSON ONE and the Master Outline & Guide—with the Study Guide materials, the Reading Reference List, and your Quiz. Put these materials to the test for 10 days. Apply what you learn from them on any design problem you're grappling with. Then—at the end of the 10 days—and *only* then, need you decide to take the whole course. If, at the end of that time, you decide you do *not* want the course, all you need do is return the Lesson and the Outline and that's the end of any obligation whatsoever on your part.



EXTRA VALUE IN THIS SPECIAL BONUS!
With Lesson Five—at the midpoint in your Course—we will send you **FREE** a 32-page
ELECTRONIC CIRCUITS PORTFOLIO
containing some 150 illustrated circuits! Each of these circuits relates to a specific point made in the Course and gives you additional specific know-how in solving problems right on the job! This valuable Bonus is something you will keep by your side as a handy source of helpful information when you need it!

MAIL YOUR "OPERATION UPDATE" COUPON TODAY!

Be sure to return your Free Examination Coupon today! The sooner you receive Lesson One and the Master Outline and Guide, the sooner you will accomplish a thorough updating of your highly valuable professional skills and the sooner you will steer yourself in the direction of bigger and better professional advantages!

TAX DEDUCTIBLE!

Just a reminder—you are entitled to deduct, tuition fees (and the McGraw-Hill Course in ELECTRONIC CIRCUIT DESIGN WITH SOLID-STATE DEVICES applies here) from your U.S. Federal Income Tax when you take any course to maintain your professional skills!

Your "Operation Update" Coupon

McGraw-Hill Book Company, 1221 Avenue of the Americas, New York, New York 10020

Please send me for 10 days' free examination Lesson One plus the Master Outline and Guide for the NEW McGraw-Hill Course in Continuing Education for Electronics Engineers—ELECTRONIC CIRCUIT DESIGN WITH SOLID-STATE DEVICES.

At the end of ten days, if I want to continue in the Course, I will make my first payment of \$6.95 plus local tax, postage and handling. And I understand that each subsequent Lesson will be accompanied by an invoice for \$6.95 plus local tax, postage, and handling... for a total cost of \$55.60 for the eight Lessons. (The Lessons will be shipped at six-week intervals.)

If I decide not to continue in the Course after the ten-day examination period, I will return the Master Outline and Lesson One and the matter will be closed.

Our Policy: If you're disappointed in the Course at any stage, just notify us and we will stop sending the Lessons and invoices. If you have paid in advance, we will refund the difference between the value of the lessons you have received and the payments you have made.

Name _____

Home Address _____

City _____

State _____ Zip _____

There is no finance charge for monthly payments.
This offer is subject to acceptance by McGraw-Hill.

41-19018

LEADER LAS-5500
AUDIO SYSTEMS ANALYZER
 7 Instruments-In-One!

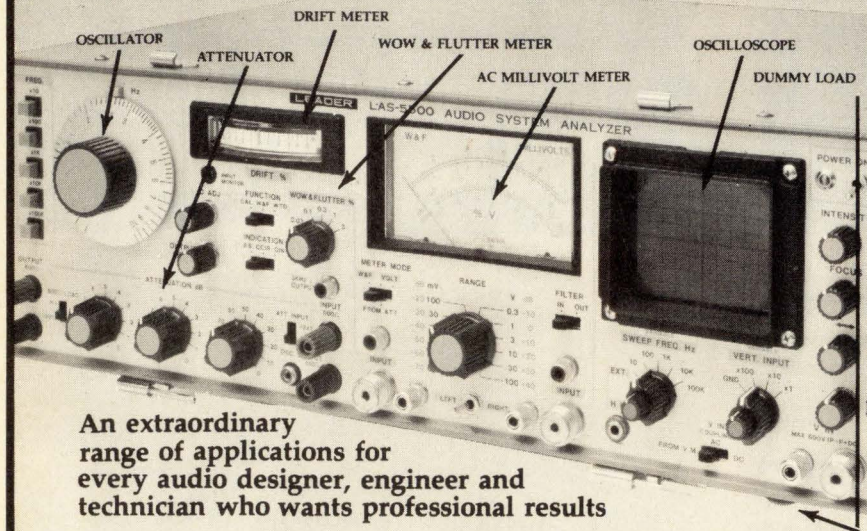

An extraordinary range of applications for every audio designer, engineer and technician who wants professional results

OSCILLOSCOPE

- DC to 10MHz bandwidth; AC 2Hz-10MHz (-3dB).
- 20mV/Div. vert. sens.

AUDIO FREQUENCY OSCILLATOR

- Frequency, 10Hz-1MHz, 5 ranges.
- <0.5% distortion, 500Hz-20KHz and better.

ATTENUATOR

- 600 Ω input/output impedance.
- 0.101dB attenuation range. $\pm 2\%$ accuracy.

AC MILLIVOLT METER

- Reads as low as 30 μ V ranging to 100V, 12 steps.
- $\pm 3\%$ full scale accuracy.
- 5Hz-100KHz freq. resp.

DRIFT METER

- 3KHz $\pm 0.1\%$ test freq. source.
- 0.3Vrms signal output.

WOW/FLUTTER METER

- 3KHz $\pm 10\%$ and 3.15KHz $\pm 10\%$ range.

DUMMY LOAD

- To 100W rated power.
- 8 Ω (L,R) impedance.

At \$1995, the LAS-5500 saves up to 50%... it's a smart investment!

Tests More... Tests Better... for Less!



151 Dupont Street, Plainview, N.Y. 11803 (516) 822-9300

West Coast: 7733 Denmore Ave., Van Nuys, Calif. 91406 (213) 989-2780 In Canada: Omnitronix Ltd., Montreal, Quebec

Circle 154 on reader service card

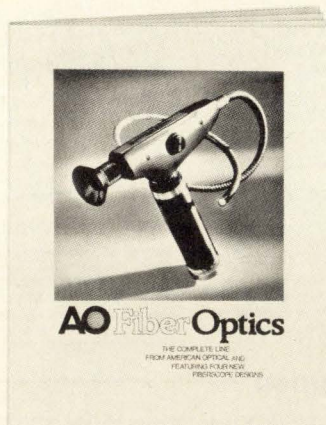

**FREE
 Fiber
 Optics
 Catalog**

Features the complete AO line of fiber optics products—from Inspection Fiberscopes and Light Guides to Illuminators, Image Conduits, Faceplates and Custom Components. Includes the four newest remote inspection fiberscopes now available.

Describes the principle, technology and techniques used to make flexible light and image transmissions a proven, practical fact. Write today for your FREE copy of the AO Fiber Optics catalog to American Optical Corporation, Fiber Optics Division, Southbridge, Mass. 01550.



154 Circle 180 on reader service card

New literature

Income tax. A 44-page booklet entitled "The Engineer and Federal Taxes" has been published by the IEEE. Written by a certified public accountant and a tax attorney, the monograph includes an explanation of the Tax Reform Act of 1976. It costs \$3 for IEEE members, \$6 for nonmembers. Copies can be ordered postpaid from the IEEE Service Center, 445 Hoes Lane, Piscataway, N.J. 08854. Or circle reader service number 421.

Telecommunications growth. According to a study by the Office of Telecommunications of the Department of Commerce, four major barriers are hindering the growth of telecommunications in four technological areas: direct satellite communications, land-mobile radio, non-entertainment broadband communications networks, and fiber-optic communications. The barriers are economic, policy, regulatory, and technical. For a copy of the study, including the Office of Telecommunications' recommendations for solutions, send \$3.25 to the Superintendent of Documents, U.S. Government Printing Office, Washington, D.C. 20402. Ask for "Lowering Barriers to Telecommunications Growth," stock number 003-000-00504-6.

Strip-chart recorders. A 32-page catalog includes data on the Rustrak line of strip-chart recorders, including a new miniature 24-channel event recorder, a new miniature three-channel analog recorder, and a new line of 4-inch servo recorders. Copies of the catalog are available from the Measurement and Control Systems Division, Gulston Industries Inc., East Greenwich, R.I. 02818 [423]

Noncontact thermometry. The line of noncontacting temperature-measuring instruments made by the Williamson Corp. is described in catalog No. 62. The instruments measure product, process, and equipment temperatures. Write to W.R. Barron, Williamson Corp., 1152 Main St., Concord, Mass. [425]

Electrical Engineering '77

Hanover shows you the Electrical Industry of Tomorrow.

Electrical Engineering at work, in research, education life. Through it all areas of the economy receive decisive impulses. This is particularly true of the Hanover Fair, where each year new ideas and suggestions are turned into new developments and innovations.

Here industry, trade and the crafts, public and private supply – and service industries, receive exactly the information which they will need for the solution of very specific problems. In a completeness which is unique in the world.

Use these talks and impulses which Hanover offers so that you know today where you will stand tomorrow.

Conferences increase your knowledge and add to the quality of your information:

The Post Office Engineers' Conference
"Power electronics and power supply in postal services and telecommunications"
Date: 21st and 22nd April 1977

The Railway Engineers' Conference
"Integrated transport control on the German Federal Railway"
Date: 22nd April 1977

Components Symposium
"Optoelectronics"
Date: 26th April 1977

**Something unique at trade fairs: all the wanted information faster
EBI: the Electronic Visitors
Information System gives you and more exactly. In the seven
halls of the electrical group.**

Make sure you use the latest information from 24 different branches of industry at the Hanover Fair. To help you prepare your visit we shall be glad to send you the Fair Diary with the programme of all branches and those sectors with the provisional exhibitors' list which interest you most.

Please return this coupon to
Deutsche Messe- und Ausstellungs-AG, Messegelände,
D-3000 Hannover 82,
Tel. (0511) 891, Telex 09 22 728

- ELS-2
- Fair Diary
 - Branch leaflets:
 - Electric power transmission
 - Electrical energy supply
 - Telecommunications
 - Measuring, testing and automation equipment
 - Electronic components and sub-assemblies
 - Electrical installations
 - Electric lighting

Name: _____

Street: _____

Town: _____



**Hanover
Fair '77**
Wednesday, April 20
- Thursday, April 28

IHM 397/GB-INT

CLASSIFIED SALES REPRESENTATIVES

Atlanta... Joe Lane... 404/892-2868
 Boston... Holt Buchanan... 617/262-1160
 Chicago... Bill Higgins... 312/751-3733

Cleveland... Mac Huestis... 216/781-7000
 Dallas... Mike Taylor... 214/742-1747
 Denver... Shirley Klotz... 303/837-1010
 Detroit... Mac Huestis... 313/873-7410

Houston... Mike Taylor... 713/659-8381
 Los Angeles... Stan Kassir... 213/487-1160
 New York... Dave Hawksby... 212/997-3594
 Philadelphia... Dan Ferro... 215/568-6161

Pittsburgh... Dan Ferro... 412/391-1314
 San Francisco... M.E. Kenny... 415/362-4600
 Stamford... Holt Buchanan... 203/359-2860
 XEROX 400 TELECOPIER... 212/997-6800

ENGINEERS NEW 1977 OPPORTUNITIES MOS SEMICONDUCTORS

We could list the new vacancies we have for 1977, but that doesn't tell the real story. The real story is an expanded Research and Development effort, new directions in packaging and assembly techniques, and advanced Q.A. involvement in qualifying new circuits for transfer to production.

We could list the products we have already developed (custom or standard). That would be past history for us; for others it would be products still to be achieved and wanted. However, we are interested in you and what you want to do as an engineer. You have spent many years in school. If you are experienced, you have learned things to apply—new concepts not compatible in your present circumstance. Either new graduate or experienced engineer, you are ready for a step up in responsibility. NCR could have the circumstance that will satisfy your need to work at what you are prepared for and help us meet the demanding objectives we have in 1977:

- **MNOS**—P and N channel; continual yield improvement, new process techniques, new equipment evaluation
- **Device Design**—Microprocessors, non-volatile memories, electrically alterable devices for use in mass memory applications
- **Reliability**—New packaging techniques and processes; automated assembly and data collection, new product transfer

So, to maintain the excellent performance we have achieved and to do the new things we have set for ourselves, we still need more people!

We will consider all applicants. We do require an appropriate degree (BS, MS or PhD) in Electrical Engineering or Engineering Physics. We will make our offers to those qualified to represent an increase in responsibility. Tell us about your experience and your personal objectives. What are you ready for that you are not doing? Write in confidence to:

**T. F. Wade, Manager
 Personnel Resources
 Microelectronics Division
 NCR Corporation
 8181 Byers Road
 Miamisburg, OH 45342**



An Equal Opportunity Employer

RATES \$46 per advertising inch (1/8"). Commissionable.
SIZES 1/8" to 10" deep in widths of one column (1 3/8"), two (3 3/8"), three (5 1/8"), and four (7").
CLOSING Two weeks prior to mailing.
MAILING One week prior to issue date.
ISSUE DATE Every other Thursday.
AD ORDERS/BOX NUMBER ANSWERS Send to Electronics, Post Office Box 900, New York, N.Y. 10020.

SENIOR SEMICONDUCTOR ENGINEERS

Settle down in Minneapolis, for the same reason we did...

THE GOOD LIFE

Consistently ranked in the top 3 urban areas in terms of QUALITY OF LIFE, Minneapolis offers all the advantages of a major Metropolitan life style in an environment conducive to country living... where you can trade traffic, crime, and pollution, for lakes, chipmunks and scenery.

Honeywell's Solid State Electronics Center, a multi-location Corporate facility providing a full range of silicon integrated circuit technologies for the Corporation, has an immediate requirement to fill the following senior engineering positions, at our Minneapolis research and advanced development facility.

- CMOS DESIGN**
- CCD DESIGN**
- BIPOLAR (CML) DESIGN**
- BIPOLAR PROCESSING**
- E-BEAM PROCESSING**
- PHOTORESIST PROCESSING**
- BIPOLAR PRODUCT ENGINEERING**
- CMOS PRODUCT ENGINEERING**

Qualifications include 3 or more years applicable engineering experience within semi-conductor industry, and appropriate education, and the ability to lead and direct major semiconductor development programs.

If you desire continued career growth and seek an opportunity to utilize your experience within a multi-technology environment dedicated to the development of several unique IC systems applications, please call Gary Clark. Collect at (612) 542-7248. If unable to call, please forward your resume in confidence.

Gary Clark
HONEYWELL, INC.
 12001 State Highway 55
 Plymouth, Minnesota 55441
An Equal Opportunity Employer

ELECTRICAL & ELECTRONIC DESIGN ENGINEERS

As Midwest's exclusive recruiter for Electronic and Electrical Engineers, our client companies have continual needs for growth oriented engineers.

Client Companies Pay All Fees

- BSEE, Integrated Circuit Design, CMOS \$18-20,000
 - BSEE, Induction AC Motor Design, 1500 HP+ \$22,000
 - BSEE, Sr. Design & Development of DC Devices \$18-21,000
 - BSEE, Universal Motor Design \$20,000
 - BSEE, Director of Engineer, AC Motors \$35-40,000
 - BSEE, DC Servo Drive Design \$18-22,000
- Call or send resume to LEN TERESINSKI, ELECTRICAL SPECIALIST in confidence. Office (414) 437-4353. Home (414) 494-4674.

MANAGEMENT RECRUITERS
 Suite 302, 115 S. Jefferson St.
 Green Bay, Wisconsin 54301
Licensed Employment Agent

DON'T forget the Box Number when answering the replies.

CHECK for Accuracy.

INCORRECT Box Numbers may result in a delay in re-forwarding your reply.

Electronics

SR. ELECTRONICS DESIGN ENGINEER

DIGITAL SYSTEMS DEVELOPMENT

We're a leading midwest manufacturer of automated banking and security systems utilizing state-of-the-art electronics technology, well-known for our achievements in EFT equipment and proud of our reputation for continuous growth. Our on-going commitment in digital systems development has created this challenging opportunity for a self-motivated Sr. Electronics Design Engineer.

Selected candidate will assume project level responsibility for the leadership and coordination of engineering and firmware development of automated terminals and communication control systems for the banking industry.

A BSEE or equivalent coupled with 4-6 years solid experience in digital systems design and development are essential. Candidates' background must reflect a proven capability in the design of microprocessing and minicomputer systems in the data communications field and an ability to work well as a key member of multiple discipline technical development teams.

The selected candidate will realize outstanding potential for career growth, professional advancement and industry recognition. Submit letter or resume, in confidence, outlining salary history to:

Diebold Inc.
Canton, Ohio 44711
Attn: C. J. Maurer

An Equal Opportunity Employer M/F

DIEBOLD
INCORPORATED

Doesn't Your Career Deserve the Best?

We are a Phoenix-based computer electronics company that is young, aggressive, and well-financed offering worldwide sales and service. We need talented, ambitious people in engineering, manufacturing and finance. Our corporate growth and new expansion is showing a 50% increase per year and we would like to have you assist us in continuing this outstanding growth pattern. Currently, openings exist at all levels and we invite you to learn more about working with Courier. Please send resume to: Mr. R. Sippel

Courier Terminal Systems

2202 E. University Drive
Phoenix, Arizona 85034
an equal opportunity employer m/f

Electro-optics, Optomechanics, Infrared, Laser, Computer Hardware Development, Radar

The professionals: EEs, physicists

The tasks: advanced and conceptual design; electro-optical sensor analysis; performance analysis; advanced image and signal processing; stabilization/tracking analysis; systems design, including space-based programs; circuit design that uses MOS or bipolar; design of CCDs and microprocessor/microcomputer techniques.

The professionals: EEs, physicists, MEs

The tasks: device development; high-energy-laser alignment-control systems; servos; precision gimbals and mechanisms.

The professionals: EEs

The tasks: computer-controlled test equipment and system integration and checkout, including systems design and application.

The professionals: radar circuit designers

The tasks: analog or digital circuit design and development; radar transmitters; RF subsystems—all using RF power-amplifier components/subsystems, modulators, high-voltage power processing, and control/protection circuits and techniques.

The professionals: radar systems engineers

The tasks: systems design using Fourier analysis, pattern recognition, and radar signal processing using digital techniques.

Degree from an accredited institution required. Please send resume to: Professional Employment, Hughes Aircraft Company, 11940 West Jefferson Blvd., Culver City, CA 90230.

HUGHES

HUGHES AIRCRAFT COMPANY
AEROSPACE GROUP

US citizenship required
Equal opportunity M/F/HC employer

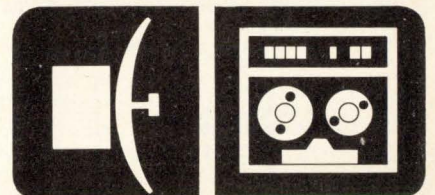
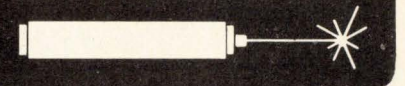

Senior Specialist Electronic Technician, be in charge of your career in Saudi Arabia.

Aramco needs a very good Senior Specialist Electronic Technician in Saudi Arabia.

Opportunity.

The majority of your time will be spent supervising a crew of 2 to 6 technicians in performing the operation, construction, maintenance, and repair work on all the electronic equipment in our communications network. You'll make essential electrical measurements to analyze and locate equipment faults, and the necessary repairs. You'll also supervise routine maintenance.

Qualifications.

A high school education plus 3 years technical school training in specialized communications equipment, 10 years work experience in the maintenance and repair of communications and electronic equipment (3 of which must have been on Aramco-type systems), plus experience in giving on-the-job training, and knowledge of human relations techniques.

Good company.

Aramco is one of the biggest oil companies, and has been operating since 1933. So we know our way around the petroleum industry.

Good money, plenty of travel time.

Working with Aramco in Saudi Arabia has many pluses. You receive top salary. An attractive savings plan. And a generous tax-free expatriate premium.

You also get a liberal paid vacation after only one year, so you can travel all over the world. Plus paid, round trip vacation travel to the U.S. once a year.

In addition, Aramco offers a liberal medical and retirement plan. Excellent benefit program and recreational facilities.

Interested?

If so, and you're qualified, write for an application. We'll get back in touch with you as soon as possible.

For an application, write Dept. EM0210A

ARAMCO SERVICES COMPANY

1100 Milam Building/Houston, Texas 77002

ENGINEERS \$16-30K

UNADVERTISED POSITIONS NATIONWIDE

- Analog. Digital. Microprocessors. Hardware/Software
- Computers. Peripherals. Instruments. Processes.
- Guidance. Control. Radar. Intelligence. EW.
- Communications. R.F. Microwave. Satellites

+ Systems — Circuits — Components +

Degreed Engineers with 2 or more years experience.

Send your resume, with present salary to:

P'n B Consultants, Inc.
Box 261, Wayne, Pa. 19087

OPERATED BY AN ENGINEER WHO TALKS YOUR LANGUAGE SPECIALIZING IN THE ELECTRONICS INDUSTRY

PROJECT ENGRS.

Our client, a well established R & D firm in the greater Boston area, offers challenge and advancement to two design engrs. capable of leading the design/development of state of the art instrument and control hardware. Requires BSEE, 5 yrs. exp., and a solid background in digital OR analog circuit/system design techniques. Exp. with microprocessors a plus. Sal. to 25K. Contact Dave Adams, New England Recruiters, 6 Lakeside Office Park, Wakefield, MA 01880.

Fee paid consultants

We have been placing graduate ENGINEERS



in **FEE-PAID** positions THROUGHOUT THE U.S. since '59. Over 1,000 client companies. We are graduate engineers working full-time for you. Send resume & salary history today or request confidential application.

ATOMIC PERSONNEL, INC.
Suite L. 1518 Walnut St., Phila., Pa. 19102
An Employment Agency
For All Technical Fields

BUSINESS OPPORTUNITY

How To Earn Money As A Consultant (including specimen contracts) \$16 Business Psychology Int'l 2407/44 Pacific Virginia Beach, Va. 23451.

OVERSEAS JOBS GUIDE

Job Hunters Guide & Directory of 600 firms. \$6.00 +\$.50 P&H (US \$ check or MO only). foreign—add \$2.00. Friar Books, Dept EL, 8956 E Ardenale, San Gabriel, CA 91775.

DESIGN ENGINEERS INVENTORS

Manufacturer with USA & Int'l. commercial industrial sales staff has available venture capital, R&D team for production, packaging, marketing your product design. Royalty or proprietorship basis. Send preliminary particulars to

RA-4138 Electronics
Class. Adv. Dept. P.O. Box 900
N.Y., N.Y. 10020

NOW IS THE TIME ... TO HIRE A STUDENT THIS SUMMER.

First, it's later than you think, with schools closing on different semester schedules, and students torn between lining-up "sure" jobs now or gambling that something in their chosen field will come along later.

Second, and most important, it's in our industry's best interest to encourage and hold its life-blood by providing practical experience in their future profession.

And, since there'll always be more applicants than openings, you'll be able to select the cream of the crop, then evaluate them with an eye towards hiring, when

as coveted graduates, the job market might well be in their favor.

Because we believe this program is of mutual benefit to both employer and employee alike, we again offer our services as a clearing-house.

Just fill out and return the coupon below, and we'll include your organization in a free listing to be sent to Placement Directors and Department Heads at leading colleges and universities across the nation. They'll post it, and the students will contact you directly.

Free summer help listing

MAIL TO: ELECTRONICS/POST OFFICE BOX 900/NEW YORK/NY 10020

NAME/TITLE (of individual to be contacted)

ADDRESS: (Mailing address of your personnel office)

ORGANIZATION: (Firm, Company, Government Agency or Institution)

TYPE AND NUMBER OF STUDENTS SOUGHT: Electronics Avionics

Technician

Other: (Draftsman, etc.)



2/17/77

Note: Last date coupons can be accepted for this year's student mailings is 4/15/77.

Job-Seekers:
Be the first to know with McGraw-Hill's Advance Job Listings

By having our new weekly ADVANCE JOB LISTINGS sent First Class to your home every Monday, you can be the first to know about nation-wide openings you qualify for both in and out of your field.

This preprint of scheduled employment ads will enable you to contact anxious domestic and overseas recruitment managers BEFORE their advertisements appear in upcoming issues of 22 McGraw-Hill Publications.

To receive a free sample copy, plus information about our low subscription rates (from three months to 12), fill out and return the coupon below.

ADVANCE JOB LISTINGS
P.O. BOX 900
NEW YORK, N.Y. 10020

Please send a sample copy of ADVANCE JOB LISTINGS to:

 Name

 Address

 City

 State

 Zip



**LSI TECHNICAL SPECIALISTS
 CIRCUIT DESIGNERS
 TEST ENGINEERS**

Enjoy the good life in Florida
 ...with a rewarding future at the
ITT LSI Systems Support Center

This recently established, corporate-funded organization is located in West Palm Beach, where the year-round living is all you could ask for. The career opportunity is the ideal complement, because this Center is charged with providing the means for optimum use of LSI in wide-ranging ITT telecommunications, space, defense, automotive and industrial product areas. This scope and challenge dictate the building of a highly qualified, technology oriented, system sensitive professional staff. True ground-floor positions with unusual reach into the future, offering excellent prospects for career advancement, are available to those who qualify.

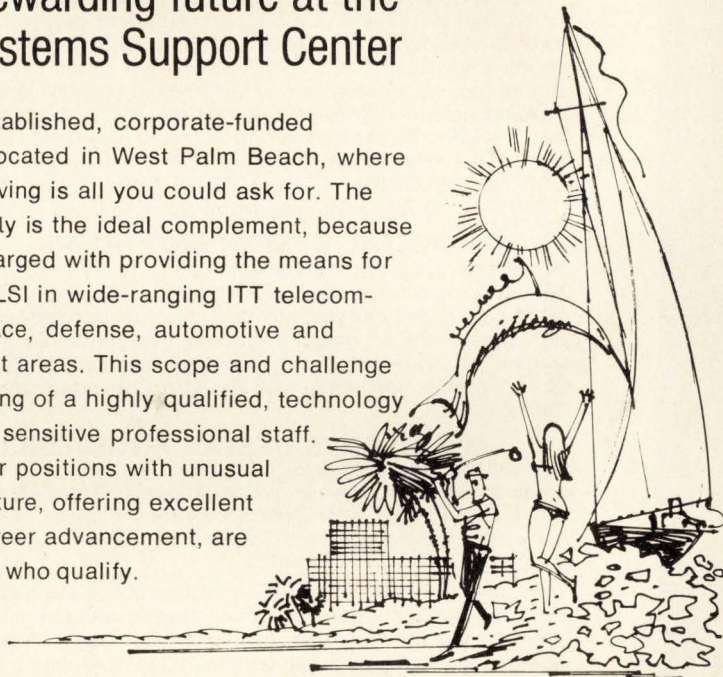

Technical Specialists

Technical expert in advanced large-scale integration. Responsible for interface with ITT equipment and systems divisions in development of new state-of-the-art applications, from LSI studies through chip design to volume manufacturability. Requires MSEE and minimum 4 years LSI design experience.

Circuit Designers

Experienced designer in advanced LSI technologies. Responsible for design of complex LSI circuits in latest bipolar and MOS technologies. Requires BSEE and

2 years design experience using sophisticated computer-aided techniques.

Senior Test Engineers

Interface with ITT equipment and systems divisions in testing philosophy and testability for new applications. Generate and debug test and characterization programs for custom and standard LSI circuits. Requires BSEE and 4 years in product and test engineering. Sentry experience and knowledge of MIL-38510 qualification techniques preferred.

Positions also available at lesser experience levels.

PHILADELPHIA INTERVIEWS
Wednesday thru Friday (Feb. 16-18)

To arrange an appointment, call on the above dates.

Robert VerNooy, (215) LO 8-7466

If not convenient to meet with us in Philadelphia, send your resume in confidence to Mr. Robert VerNooy, Personnel Manager, ITT LSI Systems Support Center, 3301 Electronics Way, West Palm Beach, Florida 33407.

**ITT LSI SYSTEMS
 SUPPORT CENTER**

An Equal Opportunity Employer, M/F

Get on TOP of these Design Projects!

and the internationally known electronics firm we represent will have a new set of challenges for you. A series of high technology projects are scheduled through the 1980's and beyond.

SIGNAL PROCESSING DESIGN ENGINEERS

This position requires a BSEE or equivalent plus 8-15 years' diversified experience in DIGITAL LOGIC DESIGN with emphasis on SIGNAL PROCESSING techniques. Your background should include leadership responsibility in the development of complex equipment design and a thorough knowledge of DIGITAL HARDWARE. You should have recent experience in one or more of the following disciplines: RADAR PRINCIPLES, TIMING CODING/DECODING, FORMATTING, DATA TRANSFER and CONTROL LOGIC, including Worst Case Analysis.

DIGITAL DESIGN ENGINEERS

You will need a BSEE or technical degree in a related area plus 3-7 years' experience in GENERAL PURPOSE LOGIC DESIGN using high speed integrated circuit logic devices and familiarity with state-of-the-art digital devices and computer aided design techniques. You should also have experience in DIGITAL CIRCUIT DESIGN, including A/D and D/A Converters and Worst Case Design.

MICROWAVE DESIGN ENGINEERS

You will be responsible for conceptual definition, design and development of microwave circuits and components necessary in the DESIGN OF ANTENNAS including PHASED-ARRAYS. Knowledge of advanced techniques in computer applications for analysis and control is essential.

If you meet the qualifications for one or more of these disciplines, we would like to arrange a personal meeting with one or more of our client's senior engineers or department heads. Please send your resume, including salary history, in confidence to LRK ASSOCIATES, 6845 Elm Street, (EL-03), McLean, Virginia 22101. U.S. CITIZENSHIP REQUIRED. Representing an Equal Opportunity Employer M/F/H.

LRK
ASSOCIATES

Radio Electrical Engineer—Our client company, a New England based manufacturer of industrial machinery is seeking a well-rounded Electrical Engineer with experience in the following areas: vacuum tube design for broadcast frequency (medium to high); power supply circuit design; high frequency generators in power ranges to 100KW; power oscillating circuit experience; knowledge of transformers (design and specifications); background in industrial use of high frequency applications is essential. The qualified candidate will possess a BSEE and 5-7 years experience in the stipulated areas. Compensation for the position will be commensurate with the level of experience presented. Interested candidates are asked to forward a detailed resume including salary history to: Michael Ingoldsby, Executive & Technical Recruiting, 230 Gardner Street, Hingham, Mass. 02043. 749-4080.

Electronic Specialist to maintain, repair and operate magnetic resonance instrumentation. Requirements: strong electronic background with theoretical and practical knowledge of transmitting and receiving circuitry, good knowledge of computer theory and operations. Experience in NMR operations and a chemistry-oriented educational background desirable. Send resume with salary history and references to Dr. John Funkhouser, Chemistry Department, Michigan State University, East Lansing, MI 48824. An Equal Opportunity/Affirmative Action Employer.

Electronics Engineers—All Disciplines, Microwave, Analog, Digital, Circuitry, Instrumentation and Controls, openings nationwide for design, applications and sales. \$14-40K. Fee Paid. Write, in confidence, to Mr. C. Robin, P.E., Dunhill Tech Search, 182 Forbes Road, Braintree, MA 02184, 617-848-6320.

STILL LOOKING FOR YOUR DREAM JOB?

Then be sure to check out the employment opportunities contained in ELECTRONICS' Classified Section.

Or, why not consider placing a Position Wanted ad? The cost is low (only \$1.25 per line) and the results are often rewarding. For more information call or write:

ELECTRONICS Post Office Box 900
New York, N.Y. 10020 • Phone: 212/997-2556



Electromechanical Project Leader

This position will participate in the technical planning and design of new and modified electrical electronic switching components. Responsibility includes technical supervision and administration for engineers, technicians, and draftpersons in the design group.

Background should include two to five years experience in switch design and a BS or equivalent experience, an electrical background and/or supervisory experience is desirable.

Tektronix, Inc., develops, manufactures and markets internationally recognized precision electronic measurement instruments, computer peripherals and related electronic instrumentation. Located near Portland, Oregon, we are within a two hour drive of the Cascade Mountains or Ocean Beaches. The close-by nature playgrounds and the City of Portland provide a variety of recreational and cultural interests.

Salary is open. Benefits include liberal educational support, insurance and profit sharing programs.

Please send detailed resume and salary history to: Roy Epperson, TEKTRONIX, INC., P.O. Box 500, E28, Beaverton, Oregon 97077.

An Equal Opportunity Employer M/F.



POSITIONS WANTED

Engineering Technician with 10 years hands-on experience in analog, digital, rf, prototype design or assembly and troubleshooting. PW-4088, Electronics.

Electronic Technical/Engineering Aide—8 years experience radars and CPU's. 4 years weapons system design. 12-15K. Interested in relocation. PW-3760, Electronics.

Experienced Product Innovator and Engineering Administrator—Fifteen patents, several successful products and various publications. Admin. experience includes OD, product planning, resource allocation, etc. Searching for rapid growth or turn-around situation. Objective is to make meaningful contribution to significant technical programs. Ideally to participate in "State of the Art" advances in controls, instrumentation, or EDP technologies. PW-4051, Electronics.

COMPUTER DESIGN ENGINEER

Small group specializing in advanced highspeed TTL AND ECL hardware needs a creative logic designer, who enjoys difficult problems to participate in the development of complex processors. Substantial digital design experience is required.

SYSTEMS CONCEPTS, INC.
520 Third St.
San Francisco, CA 94107

An Equal Opportunity Employer

—NOW—

Major new contracts provide outstanding new career opportunities with one of the nation's largest developers of tactical missiles and gun systems. The Pomona Division of General Dynamics is located 27 freeway miles from the heart of Los Angeles, and just minutes from mountain resorts.

RADAR TRANSMITTER ENGINEERS

Electronic design engineers for work with high power and low noise transmitters are needed. Experience should include one or more of the following areas: high voltage power supplies, high PRF grid modulators, high power amplifiers, high power static inverters, and transmitter protective circuits. Applicants should also be familiar with transmitter mechanical packaging problems. Positions are open for both lead engineers and electronic designers.

RADAR / GUIDANCE SYSTEM ANALYSTS

Engineers with experience in radar fire control and guidance receiver functional design analysis. A Masters degree and a background in detection theory, estimation theory, clutter analysis and ECOM analysis are highly desirable. Familiarity with math modeling techniques for advanced radar receiver block diagrams is necessary. Positions are open at several experience levels.

RADAR RECEIVER / SIGNAL PROCESSOR ENGINEERS

Electronic design engineers with experience in the design and development of receivers and signal processors. Skills with either or both analog and digital processing are desired. Analog designers should have experience with low noise IF strips, AGC, AFC and APC loops. Digital designers should have experience with techniques such as FFT's, digital filters and/or microprocessors. Lead engineer and electronic designer positions are available.

NUMEROUS OTHER OPENINGS EXIST FOR DEGREED EE's, ME's and IE's

Excellent benefits program, including life and medical insurance, dental and prescription drug plan, savings, stock investment and retirement plans.

Send complete resume including salary history and requirements, in confidence to:

Mail Zone 4-15 EM

GENERAL DYNAMICS

Pomona Division

P.O. Box 2507
Pomona, CA 91766

An Equal Opportunity Employer M / F
U.S. Citizenship Required.

Introducing the Son of "Microprocessors"

Second and third generation microprocessor technology is here, and covered in this new 200 page book "Applying Microprocessors," which picks up where its best-selling predecessor, "Microprocessors", left off. Includes 26 detailed applications from data networks to video games. Indispensable. A *must* for every electronics engineer.



Since the publication of "Microprocessors" only one year ago, enough has happened in the microprocessor revolution to fill a book. That book has just been published.

"Applying microprocessors" is expected to surpass the first book's record sales—over 20,000 copies, now in the fourth printing. The new book completes the engineer's transition from the old methods of electronic design to the new world of microprocessor engineering. The book contains the up-to-date and ready-to-use information that every designer needs to know about the new technology:

Part 1: The hardware. Microprocessors and peripheral devices. Overview of what's available to designers. Descriptions of the latest generation from on-chip devices with erasable memory to 16-bit minicomputer-like devices.

Part 2: Programming and prototype design. Surveys of available software and systems (including in-circuit emulation techniques). Computer-programming approach

to design contrasted with hardware-oriented approach.

Part 3: Actual applications. How the microprocessor is fulfilling the most optimistic hopes for its potential. Detailed descriptions of the ways today's devices already control all types of systems.

The new book focuses on actual applications, with specific how-to-do-it information on 26 applications of the new technology, including . . .

- data networks
- engine temperature monitors
- radar coordinate converters
- teleprinters
- telephone systems
- oscilloscopes
- blood analyzers
- cash registers
- video games
- weighing systems
- analog data processing
- data acquisition systems

No-risk trial offer

To prove the importance of this book to every engineer, the publishers are making a ten-day trial offer. You must be completely satisfied that the book fulfills its promise or your money will be refunded.

Electronics Book Series

P.O. Box 669 Hightstown, N.J. 08520

Send me _____ copies of "Applying Microprocessors" at \$9.95 per copy.

I must be fully satisfied or you will refund full payment if the book is returned after 10 days trial examination.

Payment enclosed Bill firm Bill me

Credit Cards Charge My Book To

American Express Master Charge Acct. _____
 Diners Club BankAmericard No. _____

Date Card Expires _____ Interbank No. _____

1st No.'s. above name on Mastercharge only.

Name _____ Title _____

Company _____

Street _____

City _____ State _____ Zip _____

Signature _____



Abbott Transistor Labs Inc.	6	Intel Corporation	77,79	* S.E. Labs. (EMI) Ltd.	21E,68
Advanced Micro Devices	10-11	Intel Memory Systems	18-19	* Sfernice	22E
* AEG Telefunken	10E	International Crystal Manufacturing Company	134	* Shell Intern'l Chemical Co. Ltd.	46
■ Airpax Electronics	41	■ International Rectifier Corp., Semi. Div.	108	* Siemens A.G. Munich	52
Allen Bradley Company	24	Intersil Inc.	15	Sinclair Radionics Ltd.	149
■ AMP Incorporated	128-129	M. S. Kennedy	144	Sorensen	35
AP Products Incorporated	136	■ Kepco Inc.	5	‡ Tally Corporation	56A,56B,56C,56D,56E,56F
Associated Electronics	166	* Kienzle, Apparatebau Gmbh Villingen	44,45	* TEAC Corp.	118
AVX Ceramics	3rd Cover	■ L.C.C.	17E	Teledyne Relays	17
Bell, F.W.	121	Leader Instruments Corp.	154	Telonic Altair	140
■ Bourns Inc.	2nd Cover	LH Research Inc.	40	Texas Instruments Incorporated Components Div.	60-61
■ Centralab Electronics Division of Globe Union Inc.	131	McGraw-Hill Book Company	153	Texas Instruments Incorporated Digital Systems Division	22-23
* Centronics	71	Micro Power Systems	75	Thomson CSF	13
Chomerics Inc.	42	* Murata Corporation of America	68	TRW Power Semiconductors	151
■ Clairex Corporation	4th Cover	‡ National Semiconductor Corporation	43,44,45,46	* Ultra Electronics Components Ltd.	11E
Continental Rentals	8	‡ NEC America, Inc., Electron Devices Div.	13	Unitrode Corporation	39
Continental Specialties Corporation	122	■ Non-Linear Systems	166	Vacuumschmelze	144
Coors Porcelain	64	* Oscilloquartz	24E	Vactec Inc.	147
Crown Industrial	146	* Pertec-Ped	4E-5E	Varo Semiconductor Inc.	166
Data I/O Corporation	37	* Philips ELA	2E-3E	V/O Technabexport	120
■ Data Precision	67	* Philips Elcoma	14E,15E,17E	Wakefield Engineering Inc.	136
Data Translation Inc.	76	* Philips Test & Measuring Instruments	9E	* Wandel und Goltermann	43
Delco Electronics Division General Motors Corporation	62-63	■ Phoenix Data Inc.	70	Wavetek San Diego Inc.	80
Delevan Division American Precision Industries, Inc.	20	Plastics Engineering Company	130	* Wilmot Breeden Electronics Ltd	19E
Deutsche Messe AG	155	Powercube Corporation Division of Unitrode	33	Wima Westermann	16
Eastman Kodak Company Graphics Markets Division	27	■ Powermate	154	Zilog	132
ECD Corporation	97	Precision Monolithic Inc.	7	Zehntel	141
EECO	127	Princeton Applied Research Corp.	8		
■ E&L Instruments Inc.	150	Process Computer Systems, Inc.	125		
Electronics & Control Engineers Book Club	137,138,139	Processor Technology	145		
Electronics Memories and Magnetics Corporation	100	Pro-Log Corporation	28		
Elfab Corp.	76	* Racal Instruments Ltd.	12E-13E		
Esterline Angus Instrument Corporation	165	Ramtek	21		
Fairchild Semiconductor Inc.	50-51	RCA Solid State Division	9		
‡ Ferroxcube Corp.	52	Realistic Controls	165		
Figaro Engineering Inc.	8	Refac Electronics	152		
Frequency Electronics	124	‡ Rental Electronics Inc.	54		
‡ General Electric Instrument Rental Division	118	Reticon Corporation	73		
■ Hewlett-Packard	1,2,49,117,135	Rockwell Microelectronic Device Division	58-59		
Intech/Function	14	Rogers Corporation	165		
		* Rohde & Schwarz	1E		
		* SDSA	23E		

Classified and employment advertising

F. J. Eberle, Manager 212-997-2557

Aramco Services Co.	158
Atomic Personnel Inc.	158
Courier Terminal Systems	157
Diebold	157
General Dynamics, Pomona Div.	161
Honeywell	156
Hughes Aircraft Co.	157
ITT	159
LRK	160
Management Recruiters	156
NCR Microelectronics Div.	156
New England Recruiters	158
P.B. Consultants	158
Systems Concepts	161
Tektronix	161

■ For more information of complete product line see advertisement in the latest Electronics Buyers Guide
 * Advertisers in Electronics International
 ‡ Advertisers in Electronics domestic edition

33% more power to the people.

**Power/Mate presents
Econo/Mate II.**

The open frame power supply.

Now Power/Mate brings you 33% more power in the same package size with the second generation of our Econo/Mate series.

The size is the same, the basic components are the same for easy interchangeability. But that's where the similarity ends.

Econo/Mate II adds features like dual AC primary and a plug-in IC regulator for improved regulation.

And Econo/Mate II is tough. Computer design, quality control, and Power/Mate's experience helps insure 100,000 hr. MTBF even at this higher power output.

But for all its features, Econo/Mate II is still, most of all, economical.

We wouldn't call it Econo/Mate if it wasn't.

Econo/Mate II is in stock, ready for delivery. Send for our free brochure.

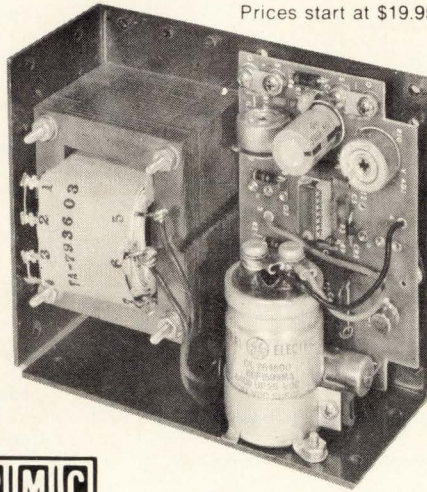

Prices start at \$19.95.



POWER/MATE CORP.

World's largest manufacturer of quality power supplies:

514 South River Street/Hackensack, N.J. 07601/Phone (201) 343-6294 TWX 710-990-5023

Circle 164 on reader service card

Advertising Sales Staff

Advertising sales manager: Paul W. Reiss
1221 Avenue of the Americas, New York, N.Y. 10020
[212] 997-4371

Atlanta, Ga. 30309: Glen N. Dougherty
100 Colony Square, 1175 Peachtree St., N.E.
[404] 892-2868

Boston, Mass. 02116: Frank Mitchell
607 Boylston St.
[617] 262-1160

Chicago, Ill. 60611
645 North Michigan Avenue
Robert W. Bartlett [312] 751-3739
Robert M. Denmead [312] 751-3738

Cleveland, Ohio 44113: William J. Boyle
[716] 586-5040

Dallas, Texas 75201: Albert J. Liedel
2001 Bryant Tower, Suite 1070
[214] 742-1747

Denver, Colo. 80203: Harry B. Doyle, Jr.
123 Speer Blvd. #400
[303] 837-1010

Detroit, Michigan 48202: Robert W. Bartlett
1400 Fisher Bldg.
[313] 873-7410

Houston, Texas 77002: Albert J. Liedel
601 Jefferson Street, Dresser Tower
[713] CA 4-8381

Los Angeles, Calif. 90010: Robert J. Rielly
Bradley K. Jones, 3200 Wilshire Blvd., South Tower
[213] 487-1160

Minneapolis, Minn. 55435: Robert M. Denmead
4015 W. 65th St.
[312] 751-3738

New York, N.Y. 10020
1221 Avenue of the Americas

Michael J. Stoller [212] 997-3616

Matthew T. Reseska [212] 997-3617

Philadelphia, Pa. 19102: Matthew T. Reseska
Three Parkway
[212] 997-3617

Pittsburgh, Pa. 15222: Matthew T. Reseska
4 Gateway Center
[212] 997-3617

Rochester, N.Y. 14534: William J. Boyle
1175 Pittsford-Victor Rd., Pittsford, N.Y.
[716] 586-5040

San Francisco, Calif. 94111: Don Harris
Robert J. Rielly, 425 Battery Street,
[415] 362-4600

Paris: Alain Offergeld
17 Rue-Georges Bizet, 75116 Paris, France
Tel: 720-73-01

Geneva: Alain Offergeld
1 rue du Temple, Geneva, Switzerland
Tel: 32-35-63

United Kingdom & Scandinavia: Robert Ghey
34 Dover Street, London W1
Tel: 01-493-1451

Scandinavia: Andrew Karnig and Assoc.
Kungsholmsgatan 10
112 27 Stockholm, Sweden
Tel: 08 51 68 70 Telex: 179 51

Milan: Luigi Rancati
1 via Baracchini, Italy
Phone 86-90-656

Brussels: Alain Offergeld
23 Chaussee de Wavre
Brussels 1040, Belgium
Tel: 13-73-95

Frankfurt/Main: Fritz Krusebecker
Liebigstrasse 27c, Germany
Phone 72 01 81

Tokyo: Tatsumi Katagiri, McGraw-Hill
Publications Overseas Corporation,
Kasumigaseki Building 2-5, 3-chome,
Kasumigaseki, Chiyoda-Ku, Tokyo, Japan
[581] 9811

Australasia: Warren E. Ball
IPO Box 5106, Tokyo, Japan

Business Department

Thomas M. Egan,
Production Manager [212] 997-3140

Gayla Black
Production Manager [212] 997-2044

Carol Gallagher
Production Manager International
[212] 997-2045

Dorothy Carter
Production Manager Domestic
[212] 997-2908

Frances Vallone
Reader Service Manager
[212] 997-6057

Electronics Buyers' Guide

H.T. Howland, General Manager
[212] 997-6642

Regina Hera, Directory Manager
[212] 997-2544

Gayla Black, Production Manager
[212] 997-2044

Classified and Employment Advertising

Frank Eberle, Manager
[212] 997-2557

**The Answer Book.
It makes your job
easier. \$25.**

"What companies make the products I need? How do I contact them locally? How do I get their current catalogs fast?"

Ask The Answer Book. Over 4000 products, 6000 manufacturers with their local contacts, directory of trade names and catalogs, inquiry "bingo" card for 5-second ordering of current catalogs.

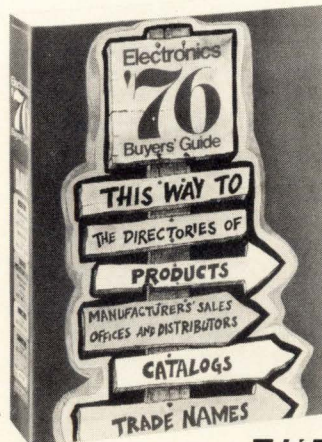

Electronics Buyers' Guide

1221 Avenue of the Americas, N.Y., N.Y. 10020

Yes, send me a copy of The Answer Book. I've enclosed \$25 (USA and Canada only, elsewhere send \$35). Full money back guarantee if returned within 10 days.

Name _____

Company _____

Street _____

City _____

State _____

Zip _____

new data system

For production/traffic/experimental studies

NEW Count/Time Data System (C/TDS) counts switch closings, totalizes ON/OFF time on up to 248 channels. With it and your own switches you have everything you need for a sophisticated production or statistical activity monitoring system — with on-board printout, plus tape records, calculator or computer feeds. Even provides time-of-event data on selected channels!

Keyboard sets all channel inputs, crystal clock timing, reset intervals, channel scale, outputs and more. Counts 10 events/channel/sec. The C/TDS is like a giant event recorder, but with output tabulated by channel the way you want it. It's a low cost way to replace a roomful of counters, recorders, timers, and man-hours. Request Bulletin B130 from Esterline Angus Instrument Corporation, P.O. Box 24000, Indianapolis, IN 46224. Tel. 317-244-7611.

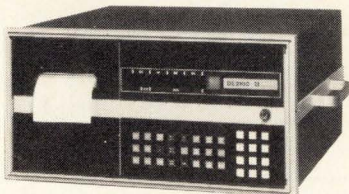

Circle 165 on reader service card

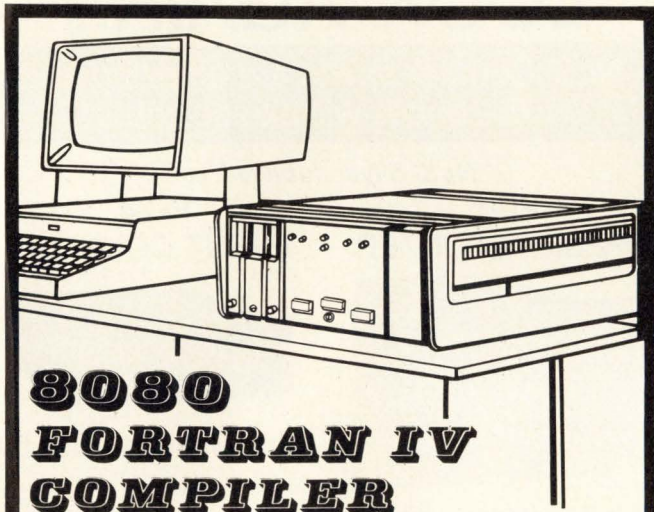

8080 FORTRAN IV COMPILER

- **IT'S HERE** — FORT//80, a resident FORTRAN IV Compiler. Produces directly executable object code.
- **IT'S COMPACT** — Compiler fits in 11K of memory! — No overlays!
- **IT'S COMPATIBLE** with most floppy disk operating systems. Available in paper tape too.
- **IT'S POWERFUL** — IBM format, single and double precision floating point, signed arithmetic, subroutine library.
- **IT'S CAPABLE** of using 8080 hardware features — Direct I/O to 8080 ports ● FORTRAN control of interrupts and condition codes ● Memory mapped I/O
- **IT ALLOWS** Embedded machine code ● Custom I/O Drivers
- **IT'S PRICED RIGHT** — \$750, plus \$25 for media and documentation.

rcc realistic controls corporation

3530 Warrensville Center Road • Cleveland, Ohio 44122 • (216) 751-3158

Licensed U.S. distributor for Unified Technologies Inc. of Canada.

Circle 181 on reader service card

with MINI BUS[®]

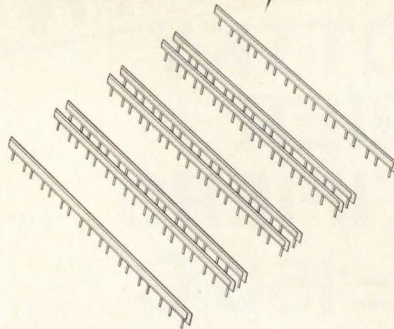

all these MOSTEK MK 4096 memory packages

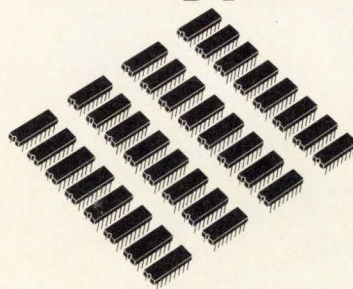

go on this 2-layer board

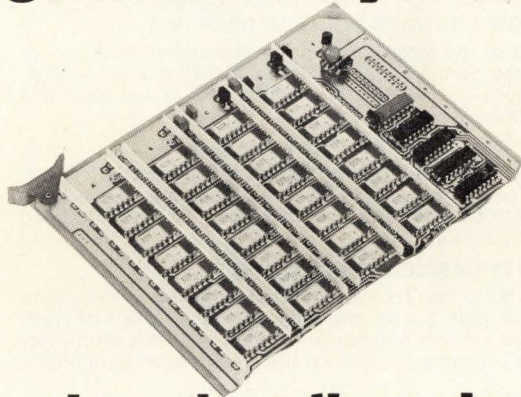

and work as they should!

... and these weren't needed!

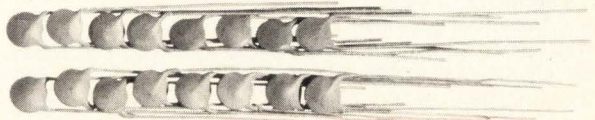

Rogers Application Note No. 1976 tells the full story of how Mini/Bus makes PCB space-saving design easier, eliminates multi-layer PCBs, drastically reduces use of de-coupling capacitors. Write or call for a copy, so you'll know what others know!

© Rogers Corporation 1976

R ROGERS CORPORATION
Chandler, AZ 85224 (602) 963-4584

EUROPE: Mektron NV, Ghent, Belgium JAPAN: Nippon Mektron, Tokyo

Circle 182 on reader service card 165

AVAILABLE
FROM STOCK

40V PIV

SCHOTTKY BARRIER RECTIFIERS

WITH $T_J = 150^\circ\text{C}$

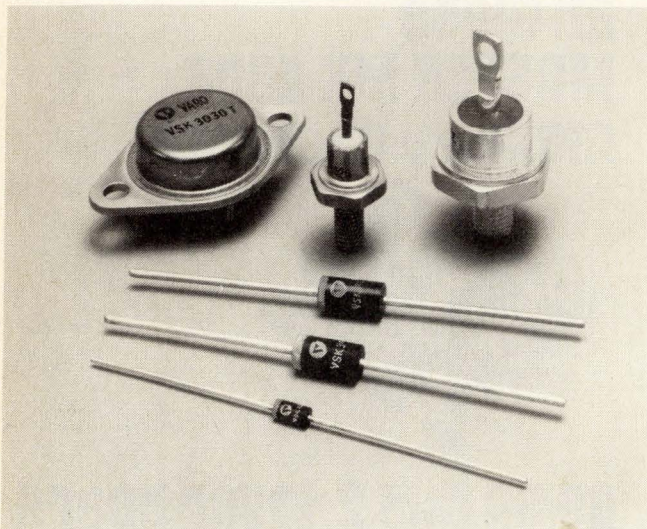

VERY LOW FORWARD VOLTAGE DROP (V_F)

Because of the large metal-barrier-to-silicon junction, V_F ranges are from 550 mV, $I_F = 1$ A, to 620 mV, $I_F = 40$ A. This results in less heat dissipation, low power loss, and greatly improved efficiency.

EXTREMELY FAST RECOVERY TIMES (t_{rr})

Typically ≤ 10 nsec. Schottkys are ideally suited for low-voltage power supplies, free-wheeling diode and flyback diode applications, and polarity protection in high-speed switching circuits.

MAJORITY CARRIER CONDUCTION

In addition to fast recovery, Schottky barrier construction results in high surge capacity and low stored charge. Schottkys are not subject to conventional P-N diode forward and reverse recovery transients caused by minority carriers.

OTHER VARO SCHOTTKY FEATURES ARE:

- -65 to +150°C junction operating temperatures
- 1 A, 3A, 5A, 15A, 30A and 40A (I_O) ratings
- 20V, 30V, and 40V (V_{RRM}) ratings
- Low reverse leakage
- Epoxy axial lead, DO-4, DO-5, and TO-3 package configurations
- Competitive pricing

Try one in your circuit; you will see for yourself these advantages and more.

For more information and data sheets on all Varo Schottky Barrier Rectifiers call Mike Hawkins, 214/272-4551



Design us in . . . we'll stay there
VARO SEMICONDUCTOR, INC.

P.O. BOX 676, 1000 N. SHILOH, GARLAND, TEX 75040
(214) 272-4551 TWX 910-860-5178

EUROPEAN OFFICE: UK: VARO SEMICONDUCTOR INTERNATIONAL, INC.
Deepdene House, Bellegrave Road, Welling, Kent, England DA163PY, 01-304-6519/0

166 Circle 166 on reader service card

1702A MANUAL EPROM PROGRAMMER

Features hex keypad, two digit hex address and two digit hex data display. Controls include load, clear, go! (step), key/copy, data in/data out, and counter up/down. Profile card includes high voltage pulse regulator, timing, 8 bit address and 8 bit data drivers/receivers. Two 6 1/2" x 9" stacked cards with spacers. Allows programming in 20 minutes - copying in 5 minutes. Requires +5, -9, and +80 volts.

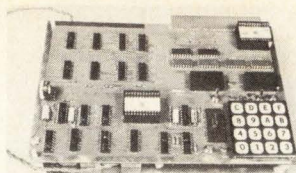

ASSEMBLED \$299.95
KIT \$189.95

NOW

The best of two worlds... use our 1702 EPROM programmer as a manual data/address entry programmer... or connect it to your processor.

IMSAI/ALTAIR computer interface (requires 3 output ports, +1 input port) and software \$49.95

Briefcase unit with power supplies and interface connectors (assembled and tested only) \$599.95

ANNOUNCING

Our NEW 16K Byte Pseudo-Static, IMSAI/ALTAIR compatible RAM. Single card slot. Uses less power than equivalent low power RAM. All memory chips socketed. Uses all prime, factory fresh ICs. High quality, two-sided, through-hole plated circuit board. Crystal controlled, totally invisible refresh system requires NO software management. Just plug it in and use like STATIC memory.

Complete kit \$349.95
Assembled, tested, and burned in \$549.95

ASSOCIATED ELECTRONICS

12444 Lambert Circle • Garden Grove, CA 92641
(714) 539-0735

Circle 183 on reader service card

LOOK AGAIN!!

NLS' Counter specs are amazing and the prices will please you.

NLS' Silver Jubilee Year

PR-5
PRESET COUNTER

PC-4
EVENT COUNTER

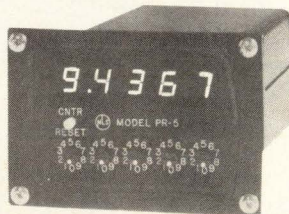

Unit Quantity—\$54.50

Unit Quantity—\$149

Features Include:

- Five-digit LED display of count plus 5-digit preset.
- Counts at 500 kHz pulse and 300 Hz contact closure.
- Small: 2.25" H x 3.25" W x 4.0" D; fits in the palm of your hand.
- Permits multiple presets.
- Optional battery pack for standby operation.
- Solid-state LSI circuitry with high noise immunity.

Features Include:

- Counts to 19999 events @ up to 200 kHz.
- Programmable decimal.
- TTL or switch input.
- Electronic reset.
- Display inhibit/dimming and lamp test.
- Leading zero suppression capability.
- Multiplexed BCD output.
- Multiple units may be cascaded.
- Large 0.3" LED display.
- Small size: 1" H x 2.5" W x 3.25" D.
- Operates from +5 vdc supply; using less than 0.75 watts.
- Optional 115 vac operation.

See your local distributor!

Distributor inquiries invited.



Non-Linear Systems, Inc.

Originator of the digital voltmeter.

Box N, Del Mar, California 92014 Telephone (714) 755-1134

For PR-5 circle 184 and PC-4 circle 185