

FEBRUARY 3, 1977

WHAT THE FINAL FORD BUDGET ADDS UP TO FOR ELECTRONICS/77

High-reliability semiconductors: are they worth the cost?/101

Low-cost scope option eases time measurements/113

FOUR DOLLARS A MCGRAW-HILL PUBLICATION

Electronics®

1420 1/2 CHURCH ST. SEP 78
STATE TECHNICAL INST
FREEMAN LIBRARY 017823
5983 MACON COVE
MEMPHIS TN

SPECIAL REPORT

**Boosting
power supply
performance
with ICs**

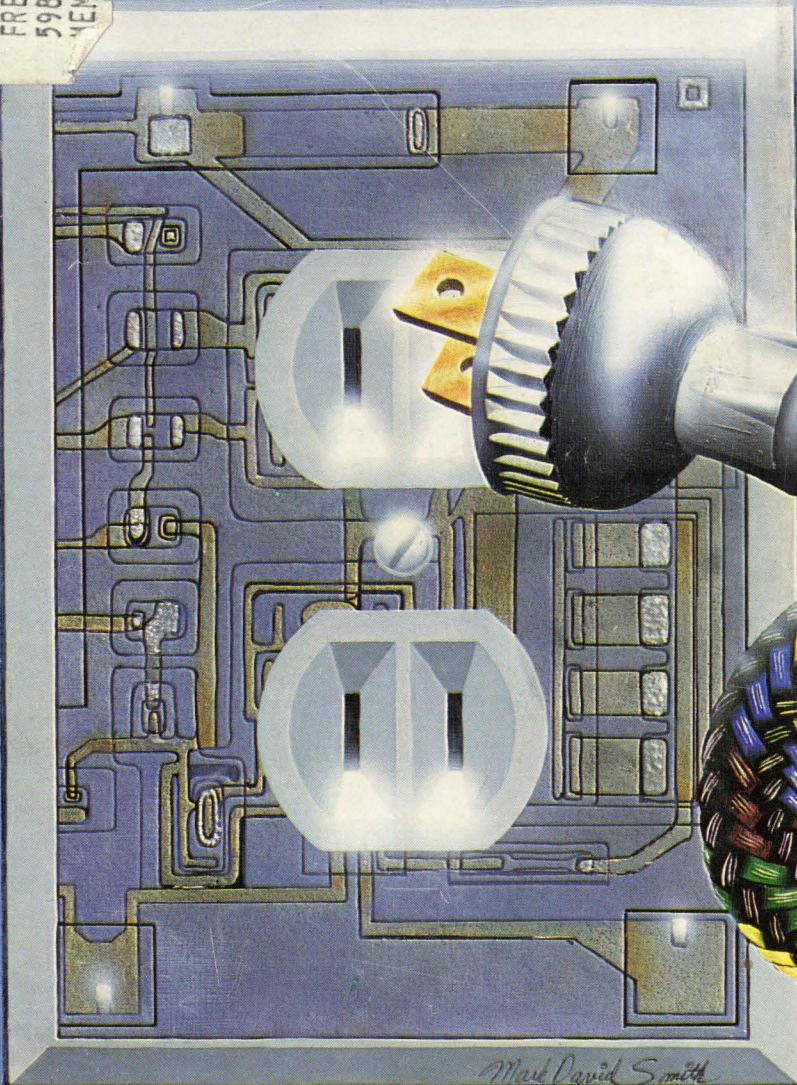

STATE TECHNICAL INSTITUTE
MEMPHIS

HP quality, convenience and low prices mean big value in DMM's.

\$225*—The HP 3476A—3½ Digits—Autoranging, automatic polarity and automatic zero make the 3476 a big value. It's a convenient size to hold in your hand or carry in your briefcase. Just \$225* for the "A" version for AC line operation in your lab or \$275* for the portable "B" version (with built in batteries and recharging circuit).

\$375*—The HP 970A—3½ Digits—Handheld, autoranging, automatic polarity and zero, the 970 is totally self-contained and totally convenient. And the readout can be inverted with a flick of your thumb for easy reading. On the job measurement has never been easier.

\$400*—The HP 3435A—3½ Digits—Autoranging or manual operation and wide-range operation, plus built-in batteries and recharging circuits bring you laboratory

accuracies and portability in the same unit. If you don't need battery operation, option 001 gives you line operation only for just \$335*.

\$500*—The HP 3465B—4¼ Digits—1μV sensitivity gives you performance you'd normally expect from a 5½-digit multimeter. Fully portable too, with its own nickel-cadmium batteries and recharging circuit. Dry-cell operation and a rack-mount version are available in the 3465A for as low as \$425*.

Confidence in low-cost DMM's comes from knowing you've made the right decision. HP's quality and service give you assurance. Contact your local HP field sales engineer or write today for more information.

*Domestic U.S.A. price only.

**HP DMM's...
the right decision.**

097/42



Circle 900 on reader service card

HEWLETT **hp** PACKARD

1507 Page Mill Road, Palo Alto, California 94304

For assistance call: Washington (301) 948-6370, Chicago (312) 255-9800, Atlanta (404) 955-1500, Los Angeles (213) 877-1282

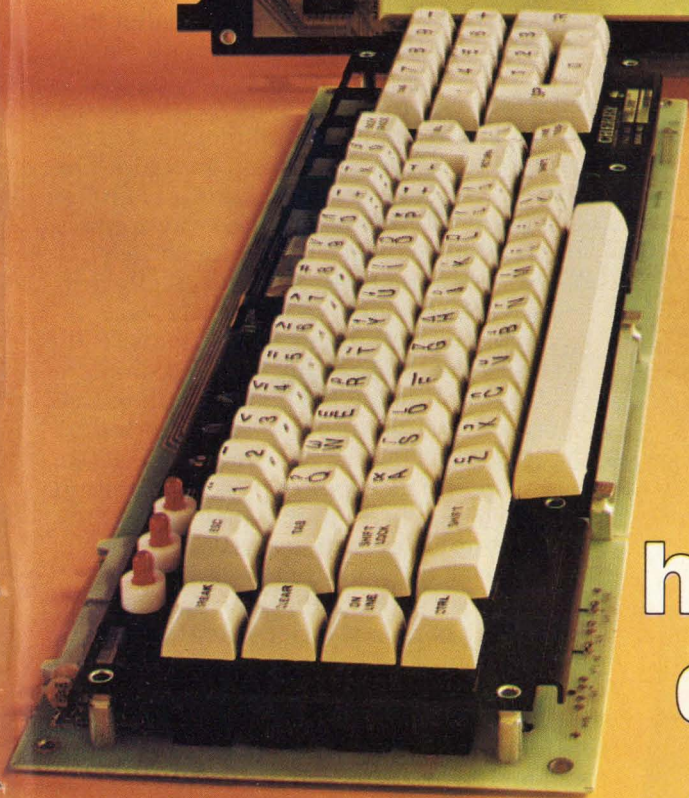

The keyboard switch with a heart of gold

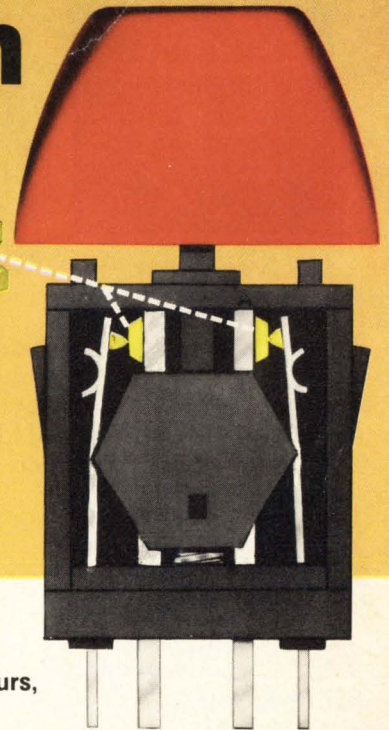

...keeps your product WORKING year after year...after year.

In your keyboard or ours, Cherry key switches just don't fail. The knife-edge contact area is so small (9 millionths of a square inch)... the contact pressure so great (about 5,000 psi) ... the gold alloy so pure and film-free ... that you are assured of positive contact every time. For 50 million operations and beyond. (Which is probably beyond the life expectancy of your product!)

Cherry "heart of gold" keyboard switches are available as part of a fully encoded Cherry Electronic Keyboard or individually, with or without two-shot molded keycaps. *We have keycaps...* in more legends, sizes, type faces than you're likely to find anywhere else. Sculptured keycaps? We've got 'em. Smooth or matte finish? We've got *both*. Colors? Lighted? Specials? Sure! Some "off the shelf"... all at prices that make it obvious why the *Cherry* way is the *economical* way to put a heart of gold in any keyboard.

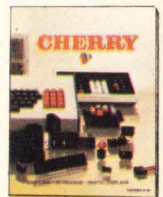

For free test sample switch and catalog, just TWX 910-235-1572... or PHONE 312-689-7700.

CHERRY



CHERRY ELECTRICAL PRODUCTS CORP., 3608 Sunset Avenue, Waukegan, IL 60085

Cherry switches now available locally from distributors.

Circle 1 on reader service card

What this country needs is a good \$39 DPM.

And we've got it.

The AD2026 from Analog Devices. Priced at \$39 in hundreds*, it's the first real alternative to the measurement grade analog panel meter. And the first to give you all the advantages of a DPM at a practical price. Advantages like visual appeal, accuracy, resolution, small size and reliability.



The AD2026 is a three digit, logic powered DPM that measures and displays voltages from -99mV to $+999\text{mV}$ on $0.5''$ LEDs. It consumes only $\frac{3}{4}$ Watts of 5V power. And because the AD2026 can be scaled with a simple resistive divider on its input pins, you can get direct readout in any engineering unit with equal or better resolution than APMs.

With an accuracy of 0.1% of reading ± 1 digit, the AD2026 is again far superior to conventional APMs, where their inherent inaccuracy usually limits the total performance of the instrument.



The AD2026 conserves on space, too. Its small front panel size of $3.4'' \times 2.0''$ and only $0.64''$ needed behind the panel makes it smaller than $3\frac{1}{2}''$ scale APMs. But its performance outclasses $4\frac{1}{2}''$ APMs.

When it comes to reliability, the AD2026 is unsurpassed. Its I²L technology combines most of the active analog and digital circuitry on *one* chip. The AD2026 has only 14 components and a MTBF of 250,000 hours at 25°C . In a 24-hour-a-day application, you shouldn't expect a failure for 28 years.

A new commercial tester automatically tests all AD2026's for defects such as bad components and solder shorts. It also fully tests both the LSI chip and the complete DPM. Following 168 hours of failure free burn-in, the units are again 100% tested.

The AD2026. Its low price (\$39/100s), small size, superior performance, and remarkable reliability make it the only sensible alternative to APMs. Which is just what this country needed.

Check it out. Return the coupon with your check or money order today to order an evaluation sample at the low 1-9 quantity price of \$62. And when you receive your evaluation samples you will also receive a Credit Certificate for \$23 redeemable when you place your order for the first hundred or more AD2026's.

ANALOG DEVICES

The real DPM company.

Box 280, Norwood, MA 02062
Telephone: East Coast: (617) 329-4700,
Midwest: (312) 894-3300,
West Coast: (213) 595-1783,
Texas: (214) 231-5094.



Please send me _____ AD2026 for testing and evaluation at the low (1-9) price of \$62. (Enclose check or money order.)

Enclosed is my purchase order for 100 AD2026 DPMs at the unbelievably low price of \$39 in 100s.

I'm not ready to order my AD2026 DPM for testing and evaluation, but I would like to receive all available technical information.

P.O. # _____

Name _____

Company _____ Telephone _____

Address _____

City _____ State _____ Zip _____

*Substantial quantity discounts available.

43 Electronics Review

MICROPROCESSORS: Peripheral circuits up 8-bit-device throughput, 43
PACKAGING & PRODUCTION: Socket accepts four chip carriers, 44
PHOTOVOLTAICS: Sandia to fund 10-kW array, 44
IEEE: Search begins for Schulke replacement, 45
MEMORIES: Half-size 16-k ROM signals price break, 46
FIBER OPTICS: Bell link to give in-service experience, 48
CAREERS: EMC adopts tighter demand-data policy, 48
CONSUMER: Microprocessors come to home pinball games, 50
SOLID STATE: Laser diode emits at 7,276 angstroms, 53
NEWS BRIEFS: 53
COMMUNICATIONS: SBS approval limits IBM's role, 54

65 Electronics International

WEST GERMANY: Microwave module detects moving objects, 65
AROUND THE WORLD: 65
JAPAN: ECL master slice developed for phone exchange, 66

77 Probing the News

GOVERNMENT: Final Ford budget pushes military, space, 77
ELECTRONICS ABROAD: Electronics may outpace Italian economy, 82
CONSUMER ELECTRONICS: Here come the watch/calculators, 86

91 Technical Articles

SPECIAL REPORT: Powering up with linear ICs, 91
Controls for switching supplies gain in popularity, 92
Series-pass IC regulators—still the perennial favorite, 96
Voltage references—the ultimate in stability, 100
COMPONENTS: Hi-rel semiconductors: paying more may not pay, 101
DESIGNER'S CASEBOOK: Shift registers as a processor interface, 106
Adjustable TTL clock maintains 50% duty cycle, 107
2.4-V battery backup protects microprocessor memory, 109
MICROPROCESSORS IN ACTION: Avoiding program missteps, 110
INSTRUMENTS: Dual delayed sweep eases measuring time, 113
ENGINEER'S NOTEBOOK: Microprocessor reads BCD on 3 lines, 118
CALCULATOR NOTES: Program analyzes spectrum of waveforms, 119

129 New Products

IN THE SPOTLIGHT: ICs streamline plasma-display terminals, 129
INSTRUMENTS: ECL speeds capture of spikes, other signals, 133
PACKAGING & PRODUCTION: Tester checks modules and cards, 138
SEMICONDUCTORS: D-MOS invades analog markets, 144
DATA HANDLING: Core ROM takes aim at industrial jobs, 155

Departments

Publisher's letter, 4
Readers' comments, 6
News update, 8
Editorial, 12
People, 14
Meetings, 30
Electronics newsletter, 35
Washington newsletter, 57
Washington commentary, 58
International newsletter, 63
Engineer's newsletter, 122
New literature, 162
New books, 165

Services

Employment opportunities, 166
Reader service card, 175

Highlights

Cover: ICs sway power-supply design, 91

One of the last bastions of discrete components, power supplies are yielding to integrated circuits. Already the field shows the kinds of changes that swept signal processing in the wake of circuit integration.

This special report details IC developments for the fast-developing switching-regulated power supplies and for the more popular series-regulated units. It also explores the role of ICs in making possible simple but ultrastable voltage references.

Mark David Smith illustrated the cover. The circuitry behind the faceplate is derived from an RCA Corp. IC voltage regulator.

Ford's last hurrah: the 1978 budget proposal, 77

Sharp increases in military spending and major new space programs mark President Ford's \$440 billion fiscal 1978 budget proposal. Any changes President Carter suggests are unlikely to affect major electronics spending.

The budget proposal includes a record \$123 billion for defense, up 12% over fiscal 1977, and \$3.9 billion for space programs—only a 5.3% increase but leading to an 11% increase in fiscal 1979. Better than a third of the proposed civilian R&D outlays of \$9.4 billion will go to energy-related projects.

High reliability can cost too much, 101

An 18-month test study of almost 190,000 high-reliability semiconductors suggests strongly that it is not worth paying extra for hi-rel integrated circuits. But for diodes and transistors, premium prices do guarantee lower failure rates most of the time.

And in the next issue . . .

Major new solid-state products bow at the International Solid State Circuits Conference: a special report . . . are plasma panels or cathode-ray tubes better for data terminals? . . . a chip that easily performs complex calculations.

EDITOR-IN-CHIEF: Kemp Anderson

EXECUTIVE EDITOR: Samuel Weber

MANAGING EDITOR: Arthur Erikson,
International

SENIOR EDITORS: Laurence Altman,
Ray Connolly, Lawrence Curran,
John Johnsrud, H. Thomas Maguire,
Stephen E. Scrupski, Gerald M. Walker

ART DIRECTOR: Fred Sklenar

ASSOCIATE EDITORS: Howard Wolff,
Alfred Rosenblatt

DEPARTMENT EDITORS

Aerospace/Military: Ray Connolly
Circuit Design: Raymond P. Capece
Communications & Microwave:

Richard Gundlach
Components: Lucinda Mattera
Consumer: Gerald M. Walker
Industrial: Raymond P. Capece
Instrumentation: Stephen E. Scrupski
New Products: H. Thomas Maguire,
Michael J. Riezenman
Packaging & Production: Jerry Lyman
Solid State: Laurence Altman

CHIEF COPY EDITOR: Margaret Eastman

COPY EDITORS: Everett C. Terry, Ben Mason

ART: Charles D. Ciatto, *Associate Director*
Paula Piazza, *Assistant Director*

EDITORIAL SECRETARIES: Janet Noto,
Penny Rothman, Marilyn B. Rosoff

FIELD EDITORS

Boston: Lawrence Curran (Mgr.), Pamela Leven
Los Angeles: Larry Waller (Mgr.)
Midwest: Larry Armstrong (Mgr.)
New York: Bruce LeBoss (Mgr.)
San Francisco: Bernard Cole (Mgr.)
Judith Curtis
Washington: Ray Connolly (Mgr.)
Frankfurt: John Gosch
London: William F. Arnold
Paris: Arthur Erikson
Tokyo: Charles Cohen

McGRAW-HILL WORLD NEWS

Editor: Michael Johnson
Brussels: James Smith
Milan: Andrew Heath
Moscow: Peter Gall
Paris: Joel Stratte-McClure
Stockholm: Robert Skole
Tokyo: Colin Gibson

PUBLISHER: Dan McMillan

ADVERTISING SALES MANAGER:

Paul W. Reiss

MARKETING ADMINISTRATION MANAGER:

Wallis Clarke

CIRCULATION MANAGER: Karl Peterson

MARKETING SERVICES MANAGER:

Tomlinson Howland

RESEARCH MANAGER: Margery D. Sholes

With integrated-circuit techniques fast finding their way into power supply design, there's good news for designers who have to come up with, say, yet another switching supply. As you'll find out in our special report on the impact of linear ICs on power supplies, which starts on page 91, the discrete component approach is giving ground ever more rapidly.

Based on lengthy traveling and interviewing by our components editor, Lucinda Matterna, and backed up by reporting by our field editors, the 10-page survey is a valuable status report on power-supply design trends today. Contributing to it were Larry Armstrong, Midwest bureau; Bruce LeBoss, New York; Bernard Cole, San Francisco; John Gosch, Frankfurt; William F. Arnold, London; and Arthur Erikson, Paris.

The annual Federal budget is an important document to us because its thousands of pages contain guideposts on the directions spending for electronic goods and research will take. So every year we devote a major chunk of pages to covering the budget (see page 77).

Our budget team, which included Washington bureau chief, Roy Con-

nolly, and Associate Editor, Howard Wolff, went in mid-January to the usual prepublication briefings held in Washington for the press. A veteran of many such annual rounds of department-by-department briefings, Wolff is now something of an expert on the ways the bureaucracy deals with the public. Last year, for instance, President Ford, in a departure from the norm, attended, and the security was tight.

This year, though, things were different. Says Wolff: "I heard one official say it was more like the last day of school than a budget briefing. Security precautions were virtually nonexistent—because President Ford, with a week left in office, decided to not to attend. But the other lame-duck officials who had to attend—such as Alan Greenspan, head of the Council of Economic Advisers, and Frank Lynn, head of the Office of Management and Budget—were friendly, jocular, and somehow just not as serious as in previous years."

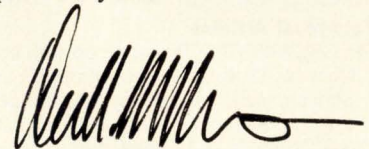

Computer editor wanted

An exciting and rewarding opportunity is available in New York on the editorial staff of *Electronics* for an electronics engineer with writing skills. As our computer editor, he will report, edit, and write articles on important developments in computer design and applications, ranging from microprocessors to big mainframes.

Candidates should have a BSEE and appropriate experience. Send résumé with salary requirements to the Executive Editor, ELECTRONICS, 1221 Avenue of the Americas, New York, N. Y. 10020.

February 3, 1977 Volume 50, Number 3 93,873 copies of this issue printed

Published every other Thursday by McGraw-Hill, Inc. Founder: James H. McGraw 1860-1948. Publication office 1221 Avenue of the Americas, N.Y., N.Y. 10020; second class postage paid at New York, N.Y., and additional mailing offices.

Executive, editorial, circulation and advertising addresses: Electronics, McGraw-Hill Building, 1221 Avenue of the Americas, New York, N.Y. 10020. Telephone (212) 997-1221. Teletype 12-7960 TWX 710-581-4879. Cable address: MCGRAWHILLNEWYORK.

Subscriptions limited to professional persons with active responsibility in electronics technology. No subscriptions accepted without complete identification of subscriber name, title or job function, company or organization, and product manufactured or services performed. Based on information supplied, the publisher reserves the right to reject non-qualified requests. Subscription rates: in the United States and possessions: \$14.00 one year, \$35.00 three years; company addressed and company libraries: \$20.00 one year, \$50.00 three years; APO/FPO addressed \$35.00 one year only; Canada and Mexico \$16.00 one year, \$40.00 three years; Europe \$40.00 one year, \$100.00 three years; Japan, Israel and Brazil \$65.00 one year, \$165 three years; Australia and New Zealand \$90.00 one year, \$240 three years, including air freight; all other countries \$45.00 one year, \$112.00 three years. Limited quota of subscriptions available at higher-than-basic rate for persons allied to field served. Check with publisher for these rates. Single copies: \$4.00. Please allow four to eight weeks for shipment.

Officers of McGraw-Hill Publications Company: Gordon L. Jones, President; Paul F. McPherson, Executive Vice-President; Group Vice-President, Gene W. Simpson; Senior Vice-Presidents: John B. Hoglund, Controller; David G. Jensen, Manufacturing; Ralph R. Schulz, Editorial; Vice-Presidents: James E. Boddorf, Planning & Development; Robert L. Leyburn, Circulation; Edward E. Schirmer, Sales.

Officers of the Corporation: Harold W. McGraw, Jr., President, Chief Executive Officer, and Chairman of the Board; Robert N. Landes, Senior Vice President and Secretary; Ralph J. Webb, Treasurer.

Title registered in U.S. Patent Office. Copyright © 1977 by McGraw-Hill, Inc. All rights reserved. The contents of this publication may not be reproduced in whole or in part without the consent of copyright owner.

Subscribers: The publisher, upon written request to our New York office from any subscriber, agrees to refund that part of the subscription price applying to copies not yet mailed. Please send change-of-address notices or complaints to Fulfillment Manager; subscription orders to Circulation Manager, Electronics, at address below. Change-of-address notices should provide old as well as new address, including postal zip code number. If possible, attach address label from recent issue. Allow one month for change to become effective.

Postmaster: Please send form 3579 to Fulfillment Manager, Electronics, P.O. Box 430, Hightstown, N.J. 08520.

**"It's everything
I've always wanted
in a function generator...
and log sweep too!"**

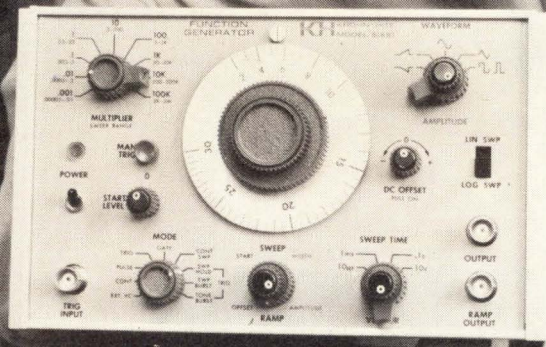

When your function generator is Krohn-Hite's Model 5300, the only limit to its application is your imagination. KH's 5300 gives you the versatility and performance to take you to the state of your art.

- It generates sine, square, triangle, positive and negative ramps and sawtooth waveforms from 0.002 Hz to 3MHz
- features linear and logarithmic sweeping
- offers 9 modes of operation including bursts, sweeps and pulses

It's the most function generator for your design dollar at only \$695. Invest in your design future with a Krohn-Hite Model 5300.

For fast action call us direct or contact your local KH representative listed below.

KROHN-HITE CORPORATION  **Electro77**

See Us At Booth #1423-1425

Avon Industrial Park, Avon, Mass. 02322 • (617) 580-1660, TWX 710-345-0831

SALES OFFICES: ALA., Huntsville (205) 534-9771; ARIZ., Scottsdale (602) 957-9110; CAL., San Jose (408) 292-3220, Inglewood (213) 674-6850; COL., Denver (303) 773-1218; CONN., W. Hartford (203) 525-7647; FLA., Orlando (305) 894-4401; GA., Atlanta (404) 237-7272; HAWAII, Honolulu (808) 941-1574; ILL., Arlington Hts. (312) 394-3380; LA., Lafayette (318) 232-8390; MD., Baltimore (301) 321-1411; MASS., Burlington (617) 273-0198; MINN., St. Paul (612) 645-5816; MO., St. Louis (314) 423-1234; N.M., Albuquerque (505) 255-2330; N.J., Cherry Hill (609) 482-0059; N.Y., Elmont (516) 488-2100, Rochester (716) 328-2230, Syracuse (315) 437-6666, Vestal (607) 785-9947; N.C., Burlington (919) 227-3639; OHIO, Chesterland (216) 729-2222, Dayton (513) 434-8993; OKLA., Tulsa (918) 299-2636; ORE., Portland (503) 297-2248; TEX., Dallas (214) 661-0400, Houston (713) 688-1431; VA., Falls Church (703) 573-8787; WA., Bellevue (206) 454-3400; CANADA, Montreal, Quebec (514) 341-7630, Ottawa, Ontario (613) 235-5121, Toronto, Ontario (416) 445-9900, Vancouver, British Columbia (604) 253-5555, Halifax, Nova Scotia (902) 454-8321, St. John's, Newfoundland (709) 726-2422.

When Clear Displays Count

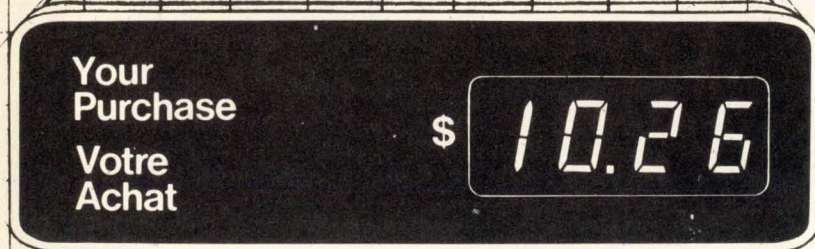
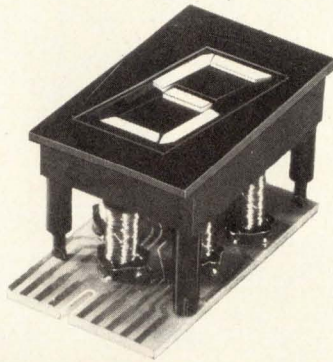

You can count on Ferranti-Packard's electromagnetic 7-Bar display module to give you the electronic compatibility you need plus the reliability and visibility your customers demand.

Only 7 moving parts to each display module — no complex mechanical linkages to wear out, or incandescent lamps and neon tubes to burn out. Performance-proven for over 5 years, the simple design and construction, backed by Ferranti-Packard research and engineering, gives you the combination of reliability, visibility and flexibility that no other read-out component can match.

When you design an electronic read-out system, Ferranti-Packard display modules will help you do it better. It's clearly the display module you should consider. See the difference for yourself, write or call us and we'll prove it.

When clear displays count — Specify Ferranti-Packard.



Ferranti-Packard Limited

Electronics Division,
121 Industry Street,
Toronto, Ontario, M6M 4M3, Canada
Telephone: (416) 762-3661
Telex: 06-22007

Readers' comments

Why \$7,800 a year?

To the Editor: In the Dec. 9 issue, you report that electrical engineers with 10 to 20 years' experience, some with Ph.D.s, were getting as little as \$7,800 a year in 1974 ["IEEE lobbies for legislation to protect engineers working for service contracts," p. 16]. But would they relocate? Did they have one year's experience 20 times?

An engineer is quoted as saying Huntsville, Ala., is hard-hit. But in industry there is even advertising on television to attract engineers and technicians.

My friend who used to be with the National Aeronautics and Space Administration says, "I went with one of those contract companies because they paid me a little more. They didn't tell me we would be the first to be laid off. Now the people I worked with are GS-14s, or at least -13s. Wish I could go back."

Rudy Holman
Chattanooga, Tenn.

Corrections

The proper identification of the curves in the illustration accompanying the analysis of the 1977 U.S. communications market [Jan. 6, p. 85] is "Market potential for digital signaling transmission and reception equipment." In addition, the last part of the accompanying caption should read: "... the market for digital signaling equipment could reach \$3.6 billion by 1980 and climb to \$6.1 billion by 1985, when electro-optic penetration could account for \$1.28 billion."

The 100-picosecond bipolar large-scale-integrated logic [Jan. 6, p. 71] to be discussed at this month's International Solid State Circuits Conference comes from Musashino Electrical Communications Laboratory of the Nippon Telephone and Telegraph Public Corp.

1976 Index is available

The index of articles in *Electronics* in 1976 may be obtained by circling 340 on the reader service card.

RCA announces...

COS/MOS-B. The new standard in CMOS.

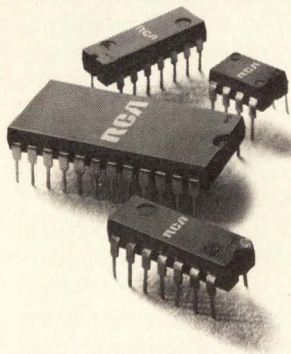

COS/MOS-B is a comprehensive series of 130 high-voltage digital ICs which set new performance standards—yet conform fully to all JEDEC specs. This is what COS/MOS-B offers:

Unprecedented performance

- 20-volt rating
- 100% tested for quiescent current at 20 V
- Maximum input current (leakage) of $1 \mu\text{A}$ at 18 V over full package-temperature range; 100 nA at 18 V at 25°C
- Standardized symmetrical output characteristics
- 5, 10 and 15 V parametric ratings
- Noise margin (over full package-temperature range): 1 V at $V_{DD} = 5 \text{ V}$; 2 V at $V_{DD} = 10 \text{ V}$; 2.5 V at $V_{DD} = 15 \text{ V}$

New design options

You can either take advantage of these higher ratings—or gain some extra insurance by electing not to design to maximum limits.

Add all this performance and flexibility to the inherent advantages of COS/MOS, plus the multiple-source advantage that comes from conformance to JEDEC specs, and you have an IC product line in a class by itself.

The RCA COS/MOS-B product guide gives you all the basic information you need to move into your new high-voltage design. For your copy, contact your RCA Solid State distributor. Or RCA.

Write: RCA Solid State,
Box 3200, Somerville,
NJ 08876; Sunbury-on-
Thames, Middlesex
TW16 7HW, England;
Ste.-Anne-de-Bellevue,
Quebec, Canada; Fuji
Bldg, Tokyo, Japan.

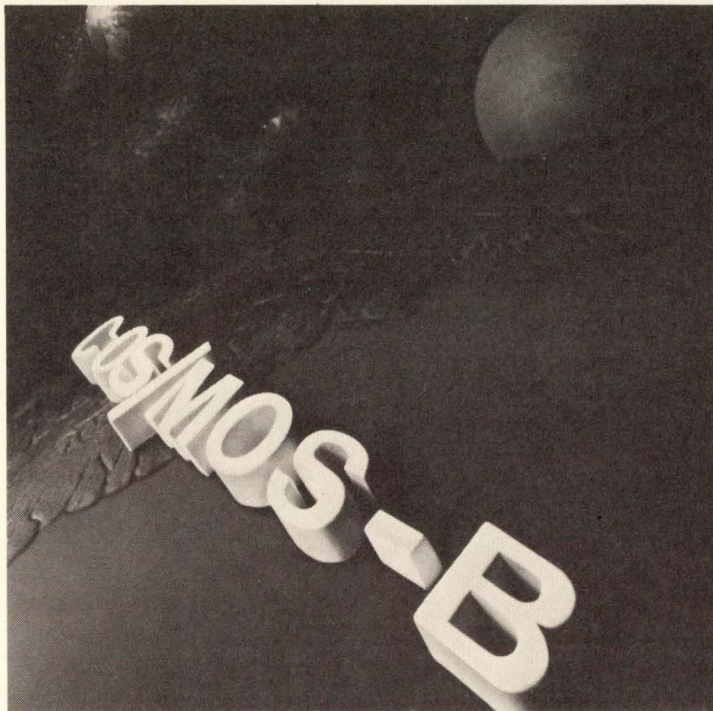

RCA

RCA. First house in CMOS.

Circle 7 on reader service card

THE NEW BIBLE



For test Instrument users.

Continental's 1977 rental catalog lets you compare *detailed* specs and prices on more than 500 instruments from 90 manufacturers! No other source offers this much information on this many products! And they're conveniently grouped by categories you understand.

Call Continental Rentals

Div. Continental Leasing Co., Inc.
175 Middlesex Turnpike, Bedford, MA 01730
(617) 275-0850

FOR IMMEDIATE RESPONSE CALL:
N.E. (617) 275-0850; L.I. (516) 752-1622;
NY, NJ (201) 654-6900; Gtr. Phila. (609) 243-5100;
Wash., D.C. area (301) 984-4310; Mid West (312) 439-4700;
So. Central (214) 690-1706; Costa Mesa, CA (714) 540-6566;
L.A., CA (213) 477-7521; Santa Clara, CA (408) 735-8300.

Circle 8 on reader service card

News update

■ Lockheed Electronics Co. of Plainfield, N.J., has delivered to the Naval Electronics Systems Command an omnidirectional antenna system with radically new features to improve airspace coverage and shipboard control of aircraft.

The new system, the first of two to be delivered to the Navy under contracts totaling \$835,000, uses an electronic-beam steering concept for 360° airspace coverage [*Electronics*, Feb. 5, 1976, p. 38]. The Navy plans to test the system on land, then conduct an evaluation at sea before deciding whether to enter production for shipboard and/or land-based tactical identification-friend-or-foe (IFF) systems. Tests are being conducted by the Test & Evaluation Detachment of the U.S. Naval Engineering Station, St. Inigoes, Md.

Designated the OE-120 (XN-2)/UPX, and better known as the AIMS antenna, the system has a 12.5-foot-diameter antenna with 64 beam radiators around its perimeter. Unlike conventional IFF systems, which radiate beams to only one airspace sector at a time, the AIMS unit can activate all its radiators at once to scan 360° about a ship, says a Lockheed Electronics spokesman. This capability, he adds, gives the radar operator improved coverage and faster and more accurate aircraft identification information.

The AIMS antenna can scan and hold on the radar presentation a specific area by energizing a group of radiators. And, notes the spokesman, AIMS operators can go from one sector to another or fluctuate the scan $\pm 10^\circ$ about an indicated bearing. Since no moving parts are involved, switching is said to be extremely fast: the beam can be steered from one position to the next in about 25 microseconds. This system flexibility and speed are achieved through a Lockheed-developed power distribution concept that integrates two 3-decibel couplers and two 6-bit phase shifters, which change the phase of energy applied to individual radiating elements. This permits the antenna's beam to bounce from one direction to another at 25 μ s levels.

Chip City.

Engineers whose job descriptions include designing far-out hybrid circuits are invited to shop at PMI's Chip City.

We've got lots of chips for you, and will gladly sell you any quantity, large or small. Op amps. DACs. Comparators. References, including our new REF-01 (+10V) and REF-02 (+5V) chips. All triple passivated, all 100% visually inspected, all 100% electrically tested to guaranteed limits. Obviously, we can't test for temperature drift (since the chips aren't packaged), but we can assure you they will all operate over the full MIL temp range.

FREE CATALOG

We've just put the finishing touches on a catalog listing all the chips we sell. It will be a useful reference and will give you the specs you'd expect to see for packaged IC's. Write, wire or phone for your copy. It's free.

Precision Monolithics Incorporated
1500 Space Park Drive,
Santa Clara, CA 95050
(408) 246-9222. TWX 910-338-0528.



Circle 9 on reader service card



**Micro-
processing
becomes
a buyer's
market.**

If you're a MOS microprocessor customer, the last few years haven't been a whole lot of laughs.

One supplier had all the good stuff, made all the rules, told you what you could buy. And when. And for how much.

But something happened to change all that: Advanced Micro Devices.

We make the best microprocessor in the world, the Am9080A, and we make all the support circuits you need. They're yours now, off the shelf, at competitive prices. That's right. Competitive.

But we make more than microprocessor products. We make you a promise:

We'll sell you any part, in any quantity, bundled or unbundled. You're the customer.

So, if you suddenly find yourself having an easier time buying microprocessors, just remember why. And who.

If you're shy, and you're just not sure how to say thank you, an order would be really nice.

Write or phone Advanced Micro Devices, The Buyer's Market.

Ours and Theirs.

(The 9080A & 8080A)

Specification	Intel	AMD
Minimum Instruction Cycle Time	1.3 microseconds	1 microsecond
Maximum Power Dissipation (at 1.3 microsec. 0-70°)	1307 milliwatts	829 milliwatts
Output Drive	1.9mA @ .45V	3.2mA @ .4V
Minimum Input High Voltage	3.3V	3.0V
MIL-STD-883	Special	Standard

Ours and Ours.

(Am9080A System Circuits)

AMD Part Number	Description	Availability
CPU		
Am9080A/-2/-1/-4	0 to +70°C	Stock
Am9080A/-2/-1	-25 to +85°C	Stock
Am9080A/-2	-55 to +125°C	Stock
STATIC READ/WRITE RANDOM ACCESS MEMORIES		
Am9101A/B/C/D	256 x 4, 22 Pin	Stock
Am91L01A/B/C	256 x 4, 22 Pin	Stock
Am9102A/B/C/D	1K x 1, 16 Pin	Stock
Am91L02A/B/C	1K x 1, 16 Pin	Stock
Am9111A/B/C/D	256 x 4, 18 Pin	Stock
Am91L11A/B/C	256 x 4, 18 Pin	Stock
Am9112A/B/C/D	256 x 4, 16 Pin	Stock
Am91L12A/B/C	256 x 4, 16 Pin	Stock
Am9131A/B/C/D/E	1K x 4, 22 Pin	Stock
Am91L31A/B/C/D	1K x 4, 22 Pin	Stock
Am9141A/B/C/D/E	4K x 1, 22 Pin	Stock
Am91L41A/B/C/D	4K x 1, 22 Pin	Stock
DYNAMIC READ/WRITE RANDOM ACCESS MEMORIES		
Am9050C/D/E	4K x 1, 18 Pin	Stock
Am9060C/D/E	4K x 1, 22 Pin	Stock
MASK PROGRAMMABLE READ-ONLY MEMORIES		
Am9208B/C/D	1K x 8, 250 nsec. max.	Stock
Am9216B/C	2K x 8, 300 nsec. max.	Stock
Am8316A	2K x 8, 850 nsec. max.	Stock
Am8316E	2K x 8, 550 nsec. max.	Stock
ERASABLE READ-ONLY MEMORIES		
Am1702A	256 x 8, 10 μsec.	Stock
Am2708	1K x 8, 450 nsec.	1st Q 1977

CPU: 9080A = 480 nsec. -2 = 380 nsec. -1 = 320 nsec. -4 = 250 nsec.
MEM: A = 500 nsec. B = 400 nsec. C = 300 nsec. D = 250 nsec. E = 200 nsec.

AMD Part Number	Description	Availability
SECOND SOURCE SUPPORT		
Am8212	8-bit I/O Port	Stock
Am8216	Non-Inverting Bus Transceiver	Stock
Am8224	Clock Generator	Stock
Am8226	Inverting Bus Transceiver	Stock
Am8228	System Controller	Stock
Am8238	Extended Write System Controller	Stock
Am8251	Prog. Communications Interface	Stock
Am8255	Prog. Peripheral Interface	Stock
Am8257	Direct Memory Access Controller	2nd Q 1977
Am8259	Priority Interrupt Controller	2nd Q 1977
IMPROVED SUPPORT		
REPLACES		
Am8238-4	High Speed System Controller	N/A Stock
Am9511	Arithmetic Processing Unit	N/A 2nd Q 1977
Am9517	Multi-mode DMA Controller	8257 2nd Q 1977
Am9519	Universal Interrupt Controller	8259 2nd Q 1977
Am9551/-4	Prog. Communications Interface	8251 Stock
Am9555/-4	Prog. Peripheral Interface	8255 Stock
Am25LS138	1-of-8 Decoder	8205 Stock
Am25LS139	Dual 1-of-4 Decoder	8205 Stock
*Am25LS273	8-bit Common Clear Register	N/A Stock
*Am25LS373	8-bit Transparent Latch	8212 2nd Q 1977
*Am25LS374	8-bit 3-State Register	8212 1st Q 1977
*Am25LS377	8-bit Common Enable Register	8212 1st Q 1977
*Am25LS2513	Priority Encoder	8214 & 8212 Stock
*Am25LS2537	1-of-10 3-State Decoder	8205 (2) 1st Q 1977
*Am25LS2538	1-of-8 3-State Decoder	N/A 1st Q 1977
*Am25LS2539	Dual 1-of-4 3-State Decoder	N/A 1st Q 1977

*All combine high performance and low power in space saving 20-pin package.

Advanced Micro Devices

Bipolar LSI. N-channel, silicon gate MOS. Low-power Schottky.
Multiple technologies. One product: excellence.



Advanced Micro Devices • 901 Thompson Place, Sunnyvale, California 94086 • Telephone (408) 732-2400 •
Distributed nationally by Hamilton/Avnet, Cramer and Schwebel Electronics.

Circle 270 on reader service card

Searching for IEEE's next general manager

The need to search for a new general manager of the Institute of Electrical and Electronics Engineers after the resignation of Herbert Schulke Jr. provides an excellent opportunity to review the definition of the job and the qualifications of the person to fill it. It also raises an important question: how best to organize the search.

In 1974, a committee that some felt had too many members to operate efficiently was appointed to find a replacement for Donald Fink, who was retiring from the position. The committee even drew up guidelines for screening applicants.

The fact that the man signed for the job did not work out and that he had to bring the situation to a head on his own is significant. Perhaps the committee did not function very well and did not follow its own guidelines, or perhaps the guidelines were faulty in not reflecting the job, or perhaps the entire search method was inappropriate. We think it was partly all three, with the last probably the weightiest.

Even in 1974 it was clear that professional activities were going to be an important adjunct to the general manager's job. Yet the search committee set out as though it was going to fill the job for 1965, not 1975. Granted no one could foresee just how disruptive, time-consuming, and politically volatile the whole area of professional activities would become. But there were ample signs that the members would not let this half of the institute's responsibilities fade away.

In fact, so much factionalism has emerged since 1974 that trying to form another search committee today to satisfy everyone would be futile. Instead, why not go to a professional head hunter with the assignment?

There is nothing so rare about the qualifications for IEEE's general manager that a top-notch recruiting firm could not handle. And the job is so important, it deserves the best talent to find the best talent. Defining the job would also be part of the recruiter's assignment, since these people can, in many cases, observe, analyze, and define a candidate's profile better than those who are too close to the situation.

In addition, politics can be kept to a minimum by this third party and if the selection did not pan out, no IEEE leader's reputation would be at stake, and therefore no face-saving would be needed. Finally, the management recruiter operates quietly behind the scenes and can be frank with job candidates.

As for the qualities required for the job, there are the obvious needs: leadership, commitment to member service, understanding of the EE's needs, and so forth. Obviously, too, the general manager has to be a good manager with technical background. Being both an employee and a spokesman for the IEEE, the general manager these days needs to be open constantly to member communication, tough-skinned when subjected to attack, and, above all, a canny politician in the upbeat sense of the word. A good sense of humor would help too.

A SIGNIFICANT ANNOUNCEMENT IF YOU'VE BEEN WAITING FOR A BREAKTHROUGH IN SMALL, PORTABLE DVM PERFORMANCE.

Until now, you haven't had much choice in a small, inexpensive but top-performing portable DVM.

The wait is over.

The Fluke 8040A, 4½-digit DVM has arrived. It's a handheld autoranging DVM, with the sophisticated performance of a benchtop instrument.

It has five measurement functions with a total of 26 ranges. True rms conversion techniques for all ac measurements. Autoranging and autozero. Extensive input overload protection. We made it truly portable, at a mere 2.5 pounds. And it's rugged enough to withstand the rigors of any field environment. We even designed a retractable hood, to make it easier to read in bright sunshine. It's been tested with transient overloads of 6 kV across the input with no damage.

DC voltage measurement from 10 μ V to 1100V with basic accuracy of $\pm 0.05\%$. AC voltage measurement from 100 μ V to 750V rms with basic accuracy of $\pm 0.5\%$. AC and dc current from 10 nA to 1.999A with basic dc accuracy of $\pm 0.3\%$ and basic ac accuracy of $\pm 1\%$. Resistance measurement from 10 m Ω to 19.999 M Ω with basic accuracy of $\pm 0.2\%$.

And true rms sensing means optimum accuracy—even when you've got noise or a distorted waveform.

Ranges can be manually selected or autoranged.

80T-150 Temperature Probe

Sensitivity:	1 mV/°C or 1 mV/°F
Accuracy:	
+15°C to +35°C ambient:	$\pm 2^\circ\text{C}$ (3.6°F) - 25°C to +125°C $\pm 3^\circ\text{C}$ (5.8°F)
-50°C to -25°C and +125°C to +150°C	$\pm 1^\circ\text{C}$ (1.8°F) to above

You can also get temperature measuring capabilities with the 8040A.

There are two battery options: a rechargeable NiCad for 8 hours of line-free operation, or disposable alkaline batteries. 100V, 115V or 230V ac line-powered battery eliminator/chargers are

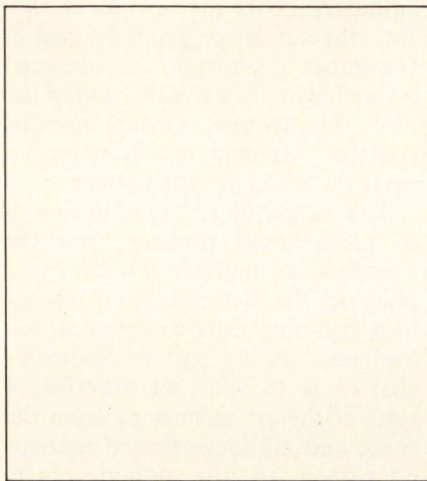

There aren't many small, inexpensive and portable DVM's around that can perform like the 8040A.

available. Accessories include measurement probes for rf voltages, high current ac, high voltage dc, temperature, and deluxe test leads. A carrying case is also available.

At last. A truly portable 4½-digit autoranging DVM that's got everything you need. And for only \$425*.

Because we didn't think you should have to wait any longer.

For data out today, dial our toll-free hotline, 800-426-0361.

John Fluke Mfg. Co., Inc., P.O. Box 43210, Mountlake Terrace, WA 98043

Fluke (Nederland) B. V., P.O. Box 5053, Tilburg, The Netherlands.

Phone: (013) 673-973 Telex: 52237

*U.S. price only.

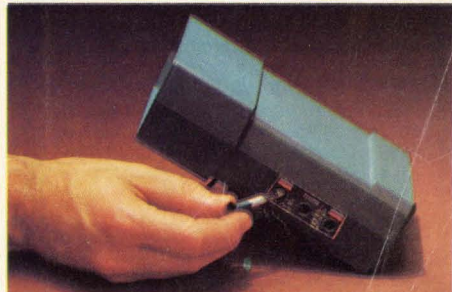
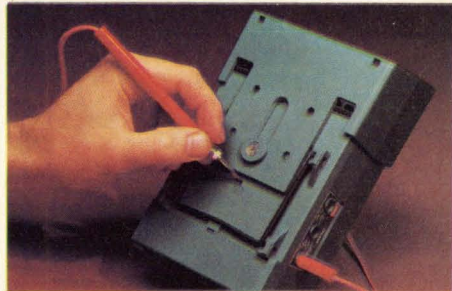
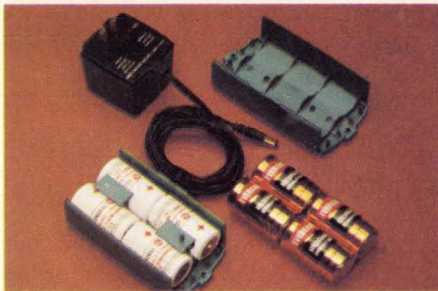
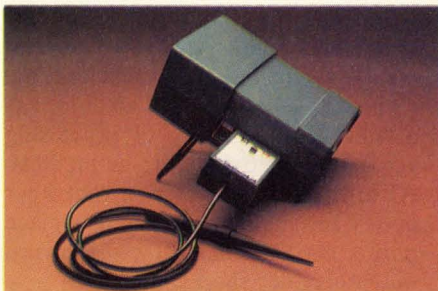

FINALLY, A COMPLETE PORTABLE. 8040A DVM. 



OPTRON OPTICALLY COUPLED ISOLATORS

NEW JAN 4N22A SERIES
OFFERS
HIGHEST RELIABILITY

You can't buy a more reliable optically coupled isolator than one of OPTRON's new JAN 4N22A series. The popular JAN 4N22A, 4N23A and 4N24A all feature fully qualified JANTX and JANTXV ratings.

These new OPTRON isolators consist of a high efficiency, solution grown gallium arsenide LED and a silicon N-P-N phototransistor in a hermetically sealed 6-pin TO-5 package. Minimum input-to-output isolation voltage for the series is 1000 volts and minimum current transfer ratios range from 25% for the 4N22A to 100% for the 4N24A.

New "A" version OPTRON isolators are a significant improvement over the older 4N22 series since the case is isolated from the sensor and LED to eliminate the need for an insulating spacer in many applications.

OPTRON also offers a new JEDEC registered series of high reliability isolators in a 4-pin TO-18 package. The 3N243 series includes three devices with the same reliability and similar characteristics as the JAN 4N22A TO-5 series, yet in a smaller package.



3N243

In addition, OPTRON's complete line of optically coupled isolators includes other immediately available standard devices in high-rel metal cans and low cost DIP and other plastic configurations for almost every application.

Detailed technical information on optically coupled isolators and other OPTRON optoelectronic products... chips, discrete components, limit switches, reflective transducers, and interrupter assemblies... is available from your nearest OPTRON sales representative or the factory direct.



OPTRON, INC.

1201 Tappan Circle
Carrollton, Texas 75006, U.S.A.
TWX-910-860-5958
214/242-6571

People

Maiman: making technology
more useful at TRW

"This is a fantastic situation," says Theodore H. Maiman, bubbling with enthusiasm over his new job at TRW Inc., the aerospace giant. Named in December as assistant for advanced technology to J.S. Webb, head of the TRW Electronics Group in Los Angeles, Maiman is still sizing up what the company has to offer.

The range, he is happy to report, is indeed broad, running "from the tremendous microelectronics capability at the Systems group to our own booming data-communications business." A big part of Maiman's charter is to spur the transfer of state-of-the-art technology from the space and military-oriented Systems operation to the commercially oriented Electronics group. He'll also be developing new products in the Electronics group, which last year had sales of \$400 million.

Digital data. Maiman known worldwide as the inventor of the ruby laser, plans to exploit several trends he believes are accelerating. "The whole country will go digital as a more efficient way of processing voice and video signals," he predicts. Also, there is no question that fiber optics for moving data is one place nature is on our side, since sand is so much cheaper than copper."

TRW is cultivating both fields. A digital-switching operation at its

Vidar division, acquired in 1975, is growing, and the company has just completed a prototype 24-channel fiber-optics multiplexer for a communications systems. The firm, which made all the parts, including connectors and couplings, will demonstrate the optics system to officials of independent telephone companies later this month.

Maiman's move to the firm results from his friendship with corporate vice chairman Simon Ramo, whom he met in 1967 while receiving a science award at the White House. "Working with Si is always exhilarating," he observes.

Since 1968, when he left Korad Corp., the laser firm he founded with Union Carbide, he has been "entrepreneurial," his term for consulting. One wide-ranging assignment was at think-tank Rand Corp., where he looked at "unique transportation ideas such as a levitated train that would travel in an evacuated tunnel." A multibillion-dollar price tag, and the lack of good tunneling equipment, stymied it.

As for progress of his laser brainchild, 17 years old in May, Maiman believes it has developed about on the schedule he foresaw. Although he then dubbed it a "solution looking for a problem," he notes now that "everybody else put communications, uses at the top of the list, but I said it was 20 years away, and that, considering the interest now in fiber optics, is about right."

Simpler languages aiding penetration by small
computers, says Data General's Foster

Although William Foster did not participate in the development of the interactive data-entry and access system that Data General introduced last summer, he thinks that its capabilities open up a new opportunity for minicomputers. The company's new director of software development maintains that such systems are increasingly penetrating applications once considered the domain of the large mainframe.

The system, built around a Data

General Eclipse minicomputer, works with the company's English-like Idea language, which nonprogrammers can use to develop distributed business-data-processing programs. Since the minicomputer can serve many terminals and use the language, business managers can develop routines for data entry and access without the need for a knowledge of Fortran or Cobol.

"The trend is toward solving more problems with small computers,"

WHAT WE DID FOR DIGITAL VOLTMETERS, WE'RE DOING FOR COUNTERS.

O.K. Wake up out there.

Fluke has got a frequency counter design specifically for communications—the 1920A. It sells for \$895.*

We wouldn't bother you if it wasn't worthwhile.

Let's face it. We've had to forge some new ground to get a good footing in the counters marketplace. When you're coming up fast on the leaders, like we are, you can't afford any ho-hum instruments. Each counter gets a little better. And, of course, the guy at the bench benefits.

That's how it is with the 1920A counter.

Some advanced LSI/MOS circuitry gives the unit exceptional specifications. And makes it a little more portable. There's a 9-digit LED display, sensitivity to 15 mV, AGC standard, and a frequency range of 5 Hz to 520 MHz. Optional internal prescalers to 1000 MHz and 1250 MHz cover the UHF television, 900 MHz telecommunications, and TACAN /DME bands.

Frequency Extension Options	
1000 MHz Prescaler	Covers 50 to 1000 MHz using a scaling ratio of 8. Sensitivity is 15 mV rms, and maximum allowable input is 5 V rms (fuse protected). VSWR less than 2.5:1 50 ohms for levels less than 1 V rms.
1250 MHz Prescaler	Covers 50 to 1250 MHz using a scaling ratio of 8. Sensitivity is 20 mV to 1000 MHz, decreasing to 40 mV rms at 1250 MHz. Maximum input 5 V rms (fuse protected), and VSWR less than 2.5:1 for levels less than 1 V rms.

A few extras take you higher.

Direct and prescaled inputs are color-coded to match their corresponding function switches to facilitate operation. The display incorporates full leading zero suppression, automatic annunciation, overflow, and a self-check mode which lights all digit segments.

Then there are some features we're really proud of—exciting to find in an \$895 unit.

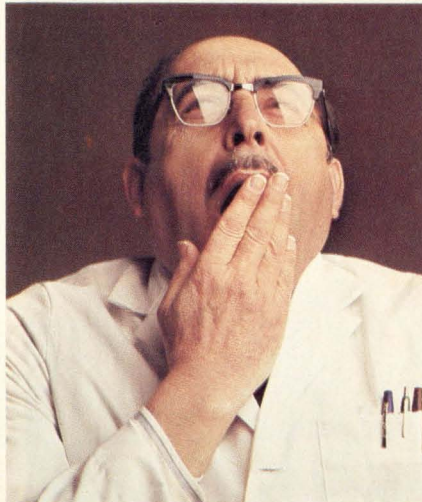

But you knew that, anyway.

Measurement delays have been eliminated. A rapid-access gate free runs in the absence of input signals. It's in position to open the gate for the selected gate time as soon as a signal is sensed. An auto-reset circuit initiates a new measurement every time any front panel switch is activated. The first measurement obtained is always correct.

In addition to normal frequency measurements, there's a burst function.

The unit measures RF bursts of greater duration than the selected gate time. To avoid erroneous reading, the display is automatically reset to zero if the burst width is less than the gate time selected.

An optional resolution multiplier coherently multiplies audio tone signals by 1000, providing a resolution of 0.001 Hz in 1 sec.

But now that we've got your attention, the 1920A really doesn't seem so surprising, does it? Really, it's something you sort of expect, when you come to think about it.

Another great instrument from Fluke. As far as we can tell, it means two things. A promise to you that Fluke is giving their full attention to counters.

And a lot of worry for our competitors. For data out today, dial our toll-free hotline, 800-426-0361.

John Fluke Mfg. Co., Inc., P.O. Box 7428, Seattle, WA 98133

Fluke (Nederland) B.V., P.O. Box 5053, Zevenheuvelenweg 53, Tilburg, Netherlands.

Phone: (013) 673-973 Telex: 52237

**Domestic price only.*



FOR COMMUNICATIONS. 1920A COUNTER. 

New frontiers in electronics:
It's about time



just a flick of the wrist

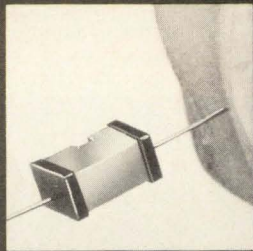

activates the Ney-Nova^{*} inertia switch

This unique noble alloy and miniature magnetic inertia switch has brought a dramatic improvement to popular LED & LCD watches. Ney's proven leadership in both noble alloy and low energy electrical contact technology assures long life and more reliable switch performance. Plus, a greater design freedom for manufacturers. For detailed information contact: Electronics Division, The J. M. Ney Company, Bloomfield, Conn..06002. (203) 242-2281

^{*}patent applied for

NEY

People

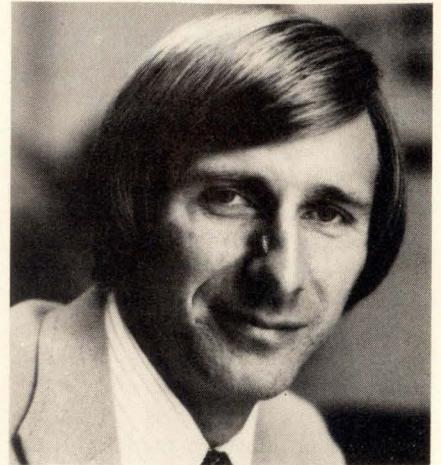

Helper. William Foster is out to help the user do productive work sooner.

says the 32-year-old northern California native, who formerly headed hardware and software development at Hewlett-Packard Co.'s General Systems division. He indicates that more products like Idea can be expected from the Southboro, Mass., minicomputer manufacturer.

End-user software. Foster, who classifies small computer systems as those selling for about \$100,000, says his group's charter is to develop software for the company's computer line and "assist in overall strategy whenever software plays a part." His job is to make sure that as Data General increasingly penetrates end-user markets, the software exists to support the application. "I've worked with end users before," he says, "and I can contribute here." He foresees the expansion of the use of high-level English-like languages on small machines "to the point where the user won't even have to know Fortran or Cobol."

In earlier days, when minicomputers were regarded strictly as original-equipment products, "engineers went off and developed a computer, and then told the software people to program it," he observes. "Now it is a team effort, with the software guys in on the planning from the start. But it is really the user who is pacing the development in our company, because we ask who is going to use a system and then optimize the hardware and software around the applications."

hp MEASUREMENT COMPUTATION **NEWS**

product advances from Hewlett-Packard

FEBRUARY 1977

in this issue

RS-232 interface for
9825 desktop computer

New terminal for APL\3000—
A Programming Language

Transistor offers 1.6 dB
max NF at 1.5 GHz

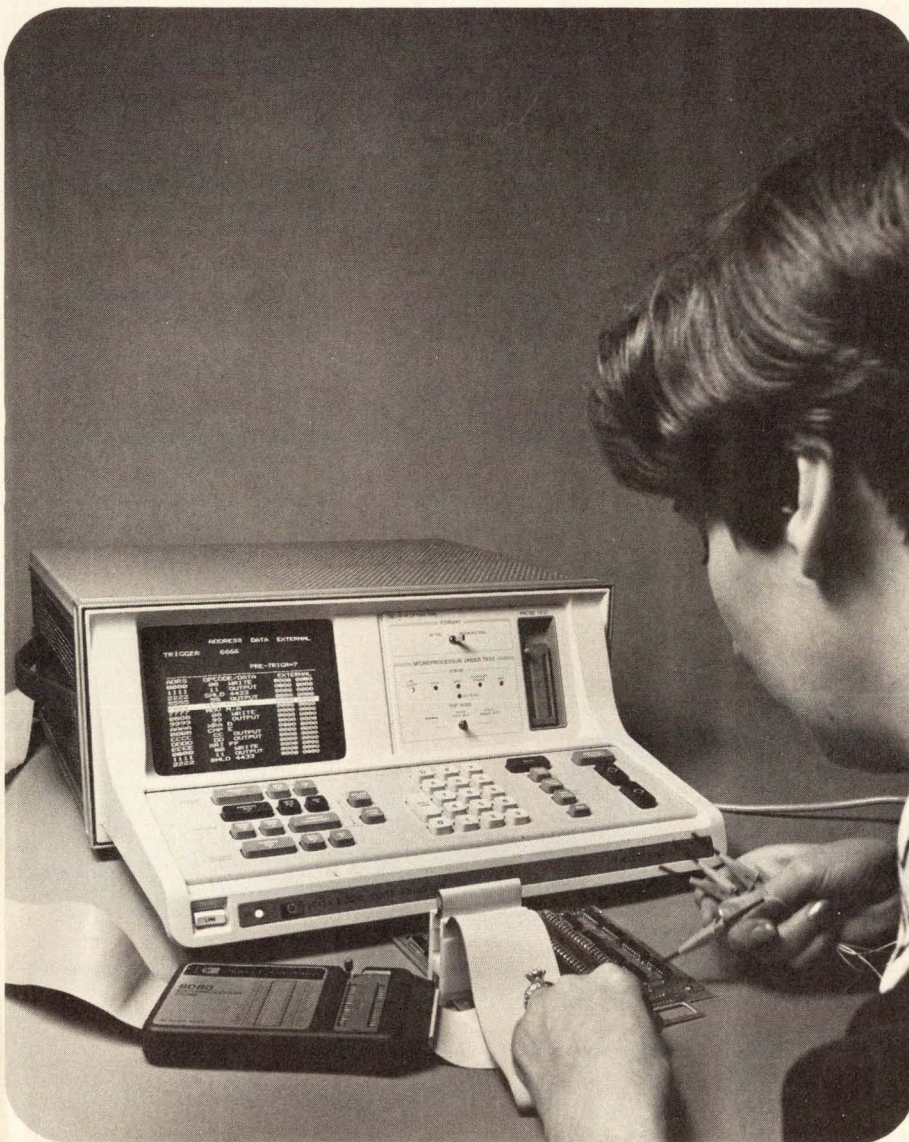

Direct connection is made to the microprocessor with the "clothespin" clip. The EXTERNAL connections are through separate leads. These may plug directly onto test pins, or they may be inserted in pincher-type miniature probes as shown. The display on the CRT is a probe test verifying internal operations of the logic analyzer.

A new logic analyzer dedicated to debug microprocessor-based systems

As new applications for microprocessor-based systems proliferate, Hewlett-Packard recognized the need for an instrument that could handle the vast quantity and complexity of data during system debugging. This measurement need resulted in the development of the new HP 1611A logic state analyzer with powerful triggering capabilities, mnemonic display and time interval measurements, saving you a significant amount of time in debugging microprocessor-based systems.

An extremely important feature of
(continued on third page)

Economical counters



The 80 MHz 5381A and 1.3 GHz 5300B/5305B are two of the choices HP gives you in economical counters. Two of the eleven 5300B modules are at the right; the D/A converter and battery pack.

Many counter problems only require a simple, economical and dependable instrument. It is for this reason that the frequency-only 5380 family and the modular 5300 system were developed.

The 5381A, 5382A, and 5383A represent an inexpensive solution to a frequency only measurement problem up to the frequency ranges of 80 MHz, 225 MHz, and 520 MHz, respectively. All these counters feature direct count-

ing capability (a resolution of 1 Hz in 1 second), as well as an optional TCXO for improved measurement accuracy.

For applications involving counter measurements other than just frequency, the modular 5300 system is an excellent and economical solution. Configurations can be changed to meet different needs by simply snapping on an appropriate module. For example, frequency extensions to 1.3 GHz, time interval measurements to

1 ns, battery operation, digital multimeter, and even "talk" capability on the H-P Interface Bus are just some of the possibilities with the expandable and economical 5300 system.

For the whole story, check K on the HP Reply Card.

HP-IB programmable word generator with pulse parameter control for thorough digital testing

Hewlett-Packard's 8016A word generator is a versatile 50 MHz data source ideal for digital testing applications. Using it, you first set up your test pattern in the generator's 9-channel by 32-bit memory. By adjusting clock and inter-channel delays, pulse widths and amplitudes, you can easily simulate worst case or other conditions.

Multi-channel parametric tests such as set-up times, hold times, propagation delay, critical timing, sensitivity and noise immunity tests, are now easy with the total capability of the 8016A.

Now, you can use the 8016's multi-channel capabilities in CMOS applications as well. A new accessory, the HP 15451A TTL to CMOS translator, amplifies 4 channels of TTL information to CMOS levels with pulse amplitudes determined by the CMOS power supply.

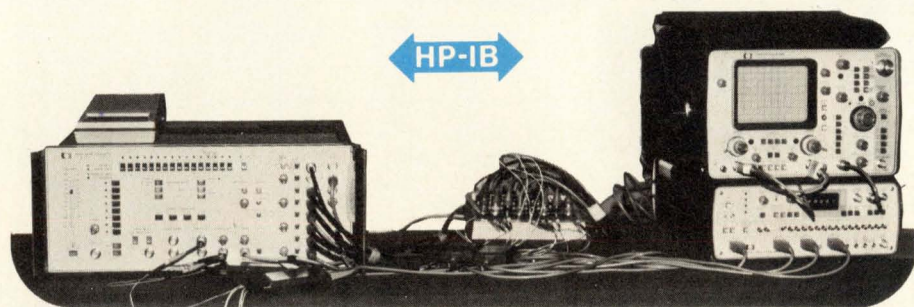

In combination with HP's 1600A logic analyzer, you have a practical stimulus-response combination for observing your logic circuits in action. Functional tests of your logic circuits, memories, microprocessors, etc. can be performed quickly with the 8016A/1600A combination.

A remote programming capability, (Option 001) allows fast loading of data to the instrument's memory with an HP Interface Bus compatible card reader, calculator, or minicomputer—a valuable option for on-line testing where speed and accuracy are important.

For details on this powerful word generator, check M on the HP Reply Card.

Microwave synthesizer application note now available

A new HP Application Note 218-1, *Applications and Performance of the HP 8671A/8672A*, details applications ranging from satellite communications testing to electronic warfare and component test. The 8672A (M/C News, May 1976) has AM/FM modulation and calibrated output usually associated only with signal generators but also resolution, spectral purity, stability and programmability of a high quality synthesizer.

A typical section of the note describes a technique to obtain finer frequency resolution of 1, 2, or 3 Hz at microwave frequencies from 2 to 18 GHz. Another section covers considerations and additional equipment required for microwave coverage to 36 GHz by use of external doublers.

Other sections provide detailed information on the actual operational

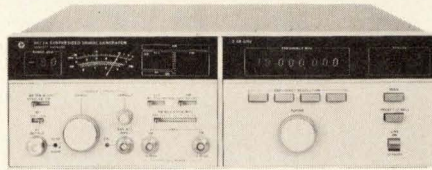

For precision signal simulation from 2 to 18 GHz, the HP 8672A provides +3 to -120 dBm signals with AM and FM modulation, and all front panel functions remotely programmable.

performance of the 8672A, giving the user considerable help in getting the synthesizer applied to his job quickly. For example, specific synthesizer programming subroutines are listed and annotated to assist in writing application programs.

For your free copy, check R on the HP Reply Card.

Dedicated logic analyzer (continued from first page)

the 1611A is its ability to display the mnemonic set used by the microprocessor in the system. If cycle-by-cycle analysis is desired, the data can be displayed in the absolute mode where the display is in hex or octal machine language. Eight additional uncommitted probes allow you to relate activity elsewhere in the system.

With new highly sophisticated triggering capabilities, the 1611A permits the framing of a real-time data window around virtually any event, or set of related events or desired sequence of

system operations. The 1611A also accurately measures execution time or counts selected events between two keyboard-selected events.

Mnemonic display has been made possible by the use of "personality" modules—consisting of special circuits and microprocessor probe—to monitor specific microprocessors. Presently, two options are available: Option 080 for the 8080 and Option 068 for the 6800. Additional optional modules will be available shortly. To reconfigure your analyzer, parts can be ordered as a kit and easily exchanged in about 15 minutes.

An internal 8-bit MOS microprocessor is used as a controller in this new keyboard controlled logic state analyzer. The CRT displays both the measurement conditions and results.

For detailed information, check B on the HP Reply Card.

ADDRESS	DATA	EXTERNAL
TRIGGER	0157	
ADRS	OPCODE/DATA	EXTERNAL
0137	JMP 0130	0000 0000
0138	CALL 01DF	0000 0000
37FD	01 WRITE	0000 0000
37FC	33 WRITE	0000 0000
01DF	LDA FBC0	0000 0000
FBC0	3C READ	0000 0000
01E2	CPI FC	0000 0000
01E4	JZ 01CB	0000 0000
01E7	CPI C0	0000 0000
01E9	JNC 00B9	0000 0000
01EC	LDA 2C07	0000 0000
2C07	82 READ	0000 0000
01EF	ANI 0F	0000 0000
01F1	LXI B, 0862	0000 0000
01F4	CPI 02	0000 0000
01F6	RET	0000 0000

Con conversationally interactive programmable data logger also operates in unattended mode

A programmable data logger is a system to collect and analyze data, make decisions based on the data and interact with the test, process, experiment, instrument, or the system which generates the data.

The 3051A system can measure dc from 1 microvolt to 200 V with 1 μ volt resolution, ac from 10 μ v to 200 V with 10 μ volt resolution, and ohms from 1 milliohm to 10 Megohms with 1 milliohm resolution. The system measures dc at five channels per second, ohms and ac at 4 channels per second.

System configuration includes the HP 3455A high accuracy/resolution 6½-digit DVM, a 3495A input multiplexer, a 9815A computing controller, and a 9815A HP-IB I/O card.

The user communicates with the system via an alphanumeric keyboard; the system communicates with the user by a numeric display and an alphanumeric thermal strip printer. This conversational interaction capability allows the system to be operated by personnel with no formal knowledge of programming or data logging. Auto start capability allows the system to operate unattended.

For more information, check D on the HP Reply Card.



The Hewlett-Packard 3051A data logging system scans from 1 to 80 channels of analog data. A ten channel relay actuator card provides alarm and multiple switching functions.

Easy tape duplication with expandable storage up to 1 Mbyte using new external memory unit

The HP 9877A External Tape Memory is a self-contained peripheral that can hold up to four cartridge drives to expand the capabilities of the HP 9825A desktop programmable calculator. Using the same cartridge unit, storage capacity from 250,000 to 1 Million bytes is now provided in increments of 250,000 bytes.

Each tape cartridge unit has a built-in two-track drive which provides rapid access to data and programs with automatic verification of all stored information. A 2,750 byte/second data transfer rate and a 228.6 cm/second search speed makes it a very fast and inexpensive method of storing, retrieving or duplicating data. An HP 9877A, fitted with four tape units, takes about six seconds to locate any file from any tape in the unit.

Using the duplicator program supplied with the 9877A, a full master cartridge can be copied and verified in about 16 minutes. Two copies, from the same master data tape, are sequentially copied and verified in 26 minutes and four copies in 50 minutes.

For more information on expanding tape storage capability, check P on the HP Reply Card.

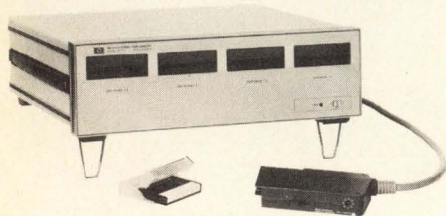

External tape memory presents an inexpensive method of storing large volumes of data plus the convenience of duplicating cartridge tapes.

Now, interface your 9825A desktop to a teletype or a remote computer



Data can now be gathered from a remote terminal or computer, reduced and analyzed by the high speed processing of the 9825A desktop, and results returned to the remote location.

The HP 98036A bit serial interface opens new areas of application for the HP 9825A desktop computer. In addition to bit parallel, binary coded decimal, and HP-IB (Hewlett-Packard's implementation of IEEE Standard 488-1975) interface capability, the advent of the 98036A allows connection to such devices as teletypes, CRT terminals, and telephone modems.

Because of the flexibility of the 9825A desktop computer, the 98036A can be used to configure the 9825A as a timeshare terminal. This allows the keyboard of the 9825A to be used to send information to a remote computer. The 9825A display or an attached printer can be used for output information received from the remote computer eliminating the need for another terminal in a distributed system.

The vectored interrupt capability of the 9825A further enhances the usefulness of the 98036A. The desktop computer's buffered input/output scheme will allow multiple interfaces to communicate simultaneously with different remote devices while locally executing another program. Priority interrupts ensure that more important information can be dealt with quickly to maximize system throughput.

Configuration of the 98036A is ac-

complished via internal switches and by programming the 9825A. The number of bits per character, parity, internal/external data clocking, and bit rate are configured by the user. The 98036A operates in an asynchronous mode with data rates from 75 bits per second to 9600 bits per second.

For complete information, check E on the HP Reply Card.

Three more spectrum analyzer application notes

Three new application notes relating to spectrum analyzers have just been published. Subjects of these brief, informative notes are:

- AN 150-9: Noise Figure Measurement
- AN 150-10: Field Strength Measurement
- AN 150-11: Distortion Measurement

In each case, the theory is reviewed, measurement procedures described, and examples of measurements presented. Advantages and tradeoffs that apply to using the spectrum analyzer are discussed.

For free copies of these new notes, just check Q on the HP Reply Card.

New display station handles both APL and ASCII data

Hewlett-Packard designed the 2641A Display Station to complement the power and elegance of the APL language. Key to the secret of APL's capability is a distinctive set of characters, each one symbolizing a powerful operation.

The 2641A is a member of the 2640 family of HP terminals that pioneered internal mini-cartridge mass storage and offers features such as self-test and "soft keys". The 2641A has these family features, plus a versatile keyboard labeled with both the APL and standard ASCII characters.

The 2641A supports a full 128 APL character set, a 64 character overstrike set and a 64 character Roman set. These sets represent the special symbols used on IBM and Burroughs systems, and most symbols used by timeshare bureaus that support APL.

Overstruck characters, an APL innovation, are a combination of two existing characters and are produced by striking one key, backspacing, and striking a second key. Without the high resolution display of the 2640 family, overstrike characters would be difficult to read. The 2641A assures crisp, clear characters.

After a user inputs an overstrike character, a search and compare with the existing set in memory assures that the character is valid.

The full complement of display enhancements (inverse video, blinking, half-bright, etc.) are standard, and the optional line drawing set allows the creation of readable forms with visual prompts.

For more information on the 2641A, or other family members, check C on the HP Reply Card.

Use the power of APL on a small general purpose computer

With the advent of APL\3000 in conjunction with the HP 3000 Series II computer and a new interactive terminal, the 2641A, designed especially for the language, APL is now more readily available as a new dimension in computational capability.

APL\3000 is the first APL software available on a low-cost general purpose computer. Patterned after APLSV, this enriched version from Hewlett-Packard is particularly useful for business, education, scientific and engineering applications involving the manipulation of large data arrays.

```

DVP 'NEUQUEENS'
ANS←NEUQUEENS;MESU;MUSE;R;X;J;I;K
MESU←MUSE+1;X,X←R←8*0
J←I 0 1-78
CYCLE←REGRESS+R*K~1+((0+(1-1)+R*8((J-1)+MESU)+(8-J)*MUSE))1
X(J)←K 0 PLACEQUEENS J;X
←OUT+18(J)-J+P-1 0 1=1
JOIN;R(K)←MUSE((0+K-(J-P))+MESU*(J-P)-1)-P
←CYCLE
REGRESS←MOSOL *P=0-J-J-1
I←R*(J)
←JOIN
MOSOL←ANS←'NO SOLUTION'
0
OUT←ANS←'SOLUTION IS ',X
DVP 'PLACEQUEENS'
PLACEQUEENS X;B
X←B;X
B←X;B
D←DR,ESC,'M',ESC,'H'
D←B;X
D←ESC,'X'

```

APL, A Programming Language, has a large following of users, who embrace its use for its capacity to express complex mathematical applications in a concise manner; numerous computer operations can be compressed into just a few lines of code.

Because of its mathematical power, APL is of growing interest to those in the fields of statistics, finance, forecasting and modeling.

Hewlett-Packard's APL\3000 has the following enhancements:

Large workspaces. Since work spaces are virtual, they are effectively limited only by the on-line disk storage available. As code is needed and used, it is brought from disk into main memory. APL\3000 is infinitely more useable with this close-to-infinite workspace. Microcoding the "virtual workspace" scheme results in faster execution.

Dynamic compiler. APL is implemented as a dynamic, incremental compiler and not a simple interpreter; compiled code is preserved and when possible, used repeatedly without recompiling. The result is faster execution of repetitive programs.

Powerful easy-to-use editor. The APL\3000 editor is a full text editor as well as a function editor. Commands are given in English-like words. Anyone who has made a mistake in editing will appreciate "UNDO" which allows quick recovery from an editing error avoiding long, complex recovery edits typical of most editors today.

Use of microcode. The most time consuming aspects of the subsystem have been microcoded to speed operation.

The 3000 Series II computer treats APL\3000 as a standard language subsystem. When APL is executing, up to 16 terminals may be operating either in batch or interactive mode, with any of the 3000's other languages: FORTRAN, COBOL, RPG, BASIC and SPL.

For additional details, check A on the HP Reply Card.

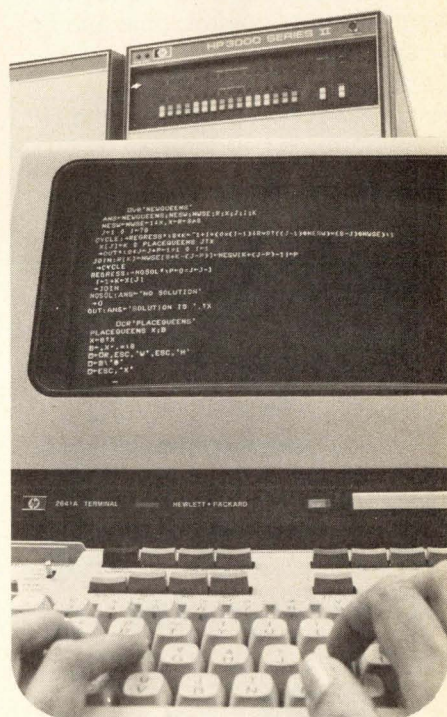

A new interactive terminal designed especially for APL, provides a clear, sharp display. APL is a terse and concise language for describing processes and algorithms.

Multiprogrammer expands your testing capabilities

Test engineers can now plug off-the-shelf units together and assemble their own automatic test and measurement system quickly and economically. A calculator-based HP Interface Bus (HP-IB) multiprogrammer system is designed for ease in communicating bi-directionally with your device under test.

A basic system includes the controller, (a desktop programmable calculator HP 9825 or 9830) connected via the HP-IB to a multiprogrammer interface unit, a 6940B multiprogrammer, and from 1 to 15 randomly-addressable I/O cards that plug into the 6940B mainframe.

Up to 15 extender mainframes, each holding 15 plug-in cards, can be combined permitting system expansion up to 240 I/O channels controlled by a single calculator.

Input card functions include current or voltage monitoring, digital input, counting, and event sensing. Output functions cover stimulus and control including voltage, current, resistance, relay contacts, digital bit patterns, stepping motor control, time and frequency references.

For more details, check L on the HP Reply Card.

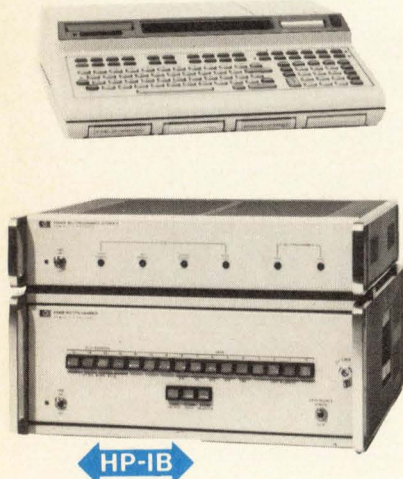

HP-IB multiprogrammer building-block components bring the power, economy, and ease of programming of HP desktop programmable calculators to your automated testing system.

Step attenuators now operate dc to 26.5 GHz

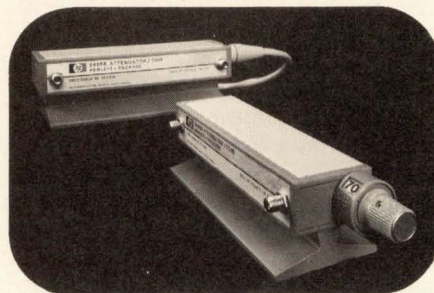

The APC-3.5 connectors used on these HP 8495D/K 70 dB step attenuators are fully compatible with the industry-standard SMA.

Considerable microwave activity is now focusing on coaxial designs above 18 GHz. Such diverse areas as satellite communications and electronic warfare require measurement components operating to 26.5 GHz and beyond.

The new HP-developed APC-3.5 coaxial connector provides a mode-free, beaded, air line for operation to 34 GHz (*Microwave Journal*, July '76). By use of this new connector, a step attenuator from the HP 8495 series is able to operate dc to 26.5 GHz.

HP 8495D manual step attenuator offers 70 dB range in 10 dB steps. HP 8495K is the programmable version with the same specifications. Solenoids operate from 20-30 volts at 110 mA. These attenuators are composed of four attenuator sections (one 10 dB card, and three 20 dB cards) connected in cascade. Each section consists of a precision thin-film attenuator card, a lossless thru line, and a ganged pair of gold plated center conductor contacts that switch the attenuation card in and out. This combination results in high accuracy and excellent repeatability (typically 0.03 dB).

For details, check N on the HP Reply Card.

Take your instrumentation tape recorder with you

Now HP instrumentation tape recording quality is available to you in the field, where and when you need it. A dc to ac inverter, capable of operating your HP 3964A or 3968A instrumentation tape recorder, from either a 12 or 28 dc voltage source is now available as Option 021.

This new inverter option is included as part of the recorder itself and is specified as part of the original purchase. Total weight of the recorder with inverter is 31.3 kg (69 lbs).

If you have need for a rugged, portable tape recorder to be used in a variety of applications, send for data on the HP 3964A and 3968A recorders. Please check F on the HP Reply Card.

A 66-page catalog describing consumables available for HP plotters, x-y recorders, strip chart recorders, oscillographic recorders, and instrumentation tape recorders is available.

Check G on the HP Reply Card.

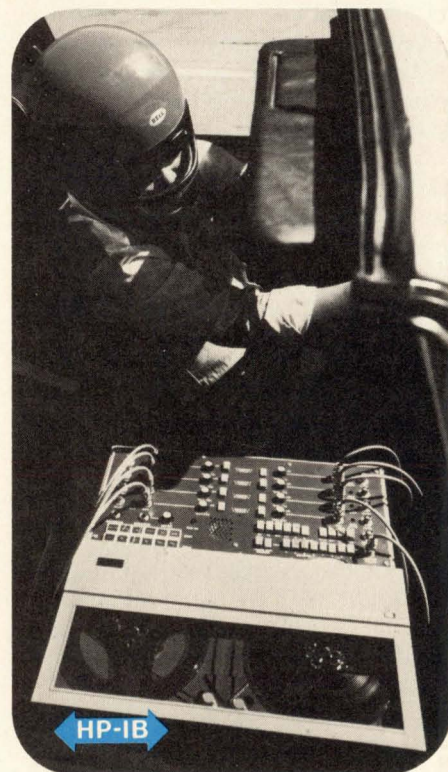

Analysis of vibration is possible when you transport your instrumentation tape recorder with you. Shown above is a Hewlett-Packard ITR recording data 'live' on a speedway.

HEWLETT-PACKARD COMPONENT NEWS

Two new low-noise microwave transistors

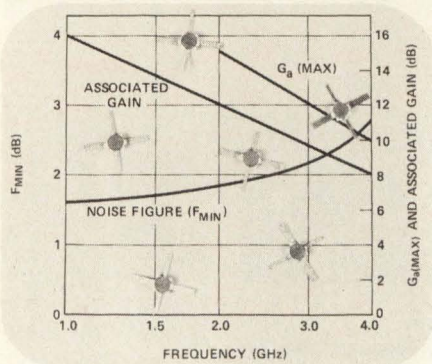

Packaged in the hermetic HPAC-100, a rugged metal/ceramic package, both devices can meet the requirements of MIL-S-19500 and the test requirements of MIL-STD-750/883.

With only 1.6 dB maximum noise figure at 1.5 GHz, the HXTR-6104 is ideal for use in low-noise amplifiers, in communications equipment and radar preamps. Associated gain at NF bias conditions is 13 dB minimum.

The HXTR-6103 with 2.2 dB maximum NF at 2 GHz and 11 dB minimum associated gain is a replacement for the Fairchild FMT 4005.

Ion implantation techniques and titanium-platinum-gold metallization are used in both devices.

For details, check J on the HP Reply Card.

Two new technical notes

AN 967 describes the design of a single-stage state-of-the-art low noise amplifier at 4 GHz using the HXTR-6101 silicon bipolar transistor. Both the input and output matching networks are described. For a copy of AN 967, check T on the HP Reply Card.

AN 968 discusses IMPATT amplifier design. A waveguide amplifier produced 2 watts of power with 10 dB gain at 11.2 GHz. Using a coaxial structure, similar performance was obtained at 8.4 GHz. For a copy of AN 968, check U on the HP Reply Card.

No dc bias needed with new Schottky detector diodes

These new zero bias Schottky diodes eliminate the problem of temperature compensation of the dc current required in sensitive detector circuits using conventional detector diodes. The high voltage sensitivity of these diodes makes them especially suitable for narrow-band video detectors in high-frequency receivers and measurement equipment.

The HSCH-3000 series diodes have a typical voltage sensitivity of 10 to 50 millivolts of output per microwatt of input power (depending on device type) at 10 GHz. Conventional Schottky detector diodes with dc bias applied produce 5 to 10 mV/ μ W. Both low impedance (2000 to 8000 ohms) and high impedance (80,000 to 300,000 ohms) devices are available).

For a technical data sheet, check I on the HP Reply Card.

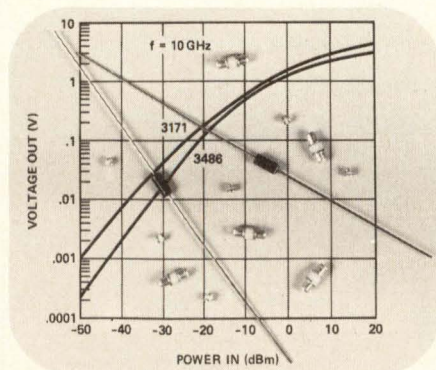

The HSCH-3000 series zero bias Schottky diodes are available in either ceramic or glass axial lead packages.

New isolator rejects 100X more common mode noise

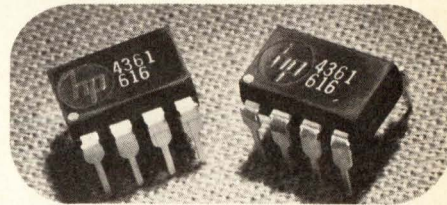

Combining a GaAsP LED and an integrated high gain photon detector, this high speed gate provides maximum dc and ac circuit isolation while achieving TTL compatibility.

A design using an internal shield for high common-mode rejection (CMR) which guarantees common-mode transient immunity of 1000 volts/ μ sec minimum is the key feature of these new optically coupled isolators.

The 5082-4361 is designed for use in high-speed, high-noise line receiver applications, logic-to-logic isolation applications and high-noise power control related applications.

For details, check H on the HP Reply Card.

How to use optically coupled isolators in linear applications

Application Note 951-2 describes how isolators can be useful in applications where analog or DC signals need to be transferred from one module to another in the presence of a large potential difference or induced noise between the ground or common points of these modules.

Applications are those in which large transformers, expensive instrumentation amplifiers or complicated A/D conversion schemes are used.

The note covers the basics of opto-isolator operation. Specific HP devices are recommended.

For your free copy, check S on the HP Reply Card.

High performance and precision PLUS wideband coverage—all in one RF sweeper

HP 86222B/8620C RF sweeper covering 10 MHz-2.4 GHz generates crystal markers that add frequency identification to wideband polar plots made with the HP 8410B Network Analyzer.



Hewlett-Packard's 10 MHz-2.4 GHz RF plug in (models 86222A and B) for the 8620C sweeper mainframe offers performance capabilities that make it a truly multi-purpose test signal source. It can cover the 10-2400 MHz range in one continuous sweep and deliver calibrated RF output from 0 to +13 dBm with full range flatness of ± 0.25 dB. For each of its key performance characteristics—e.g. frequency accuracy, linearity, stability, residual FM, harmonics, spurious content—the 86222 matches or ex-

ceeds other wide-range RF sweepers. For overall performance specifications, the 86222 stands alone.

This excellence of performance also commends the 86222 for narrow-band sweep testing as well. In fact, many CW test requirements can be filled with this sweeper.

The 86222B version adds precision crystal-controlled "birdie" markers (1, 10, 50 MHz) for additional precision and convenience in setting or identifying frequencies. These digitally-processed markers are uniquely com-

patible with such analysis systems as the HP 8410B (vector) Network Analyzer and the HP 8755 (scalar) Frequency Response Test Set. An applications-oriented data sheet presents many ideas on how this sweeper contributes to better RF testing.

For all the details, check O on the HP Reply Card.

East-4 Choke Cherry Road, Rockville, MD 20850,
Ph. (301) 948-6370.

South-P.O. Box 10505, Atlanta, GA 30348,
Ph. (404) 434-4000.

Midwest-5201 Tollview Dr., Rolling Meadows, IL 60008,
Ph. (312) 255-9800.

West-3939 Lankershim Blvd, North Hollywood, CA
91604, Ph. (213) 877-1282.

Europe-7, rue du Bois-du-lan, P.O. Box, CH-1217, Meyrin-2,
Geneva, Switzerland, Ph. (022) 41 54 00.

Canada-6877 Goreway Drive, Mississauga, Ontario,
L4V 1M8, Ph. (416) 678-9430.

Japan-Yokogawa-Hewlett-Packard Ltd., Ohashi
Bldg., 1-59-1 Yoyogi, Shibuya-ku,
Tokyo 151, Ph. 03-370-2281/92.

HEWLETT  **PACKARD**

Sales and service from 172 offices in 65 countries.

MEASUREMENT **news**
COMPUTATION
product advances from Hewlett-Packard

January/February 1977

New product information from

HEWLETT-PACKARD

Editor: Iona M. Smith

Editorial Offices:

1507 Page Mill Road
Palo Alto, California, 94304 U.S.A.

The \$995* Solution to a \$100,000 Problem— Superpac!



Imagine your systems product with an intelligent front-end that combines TTY keyboard layout and CRT with the best industrial microcomputer money can buy. Now dump those scary development cost estimates in the round file. Because it's here today. At a price that's hard to believe! And behind it is the most complete line of standard industrial microcomputer hardware and software available anywhere. Microcomputer and memory boards. Digital I/O. Analog interfaces. Industrial packages. Complete Real-Time Operating System and FORTRAN compiler.

That's what PCS is all about. And that's why we've sold more industrial microcomputers than anyone else in the business.

Please send me more information about Superpac
 PCS single-board microcomputers PCS packaged systems PCS customer support capabilities.
 Please have a salesman call.

Name _____

Title _____

Company _____

Street _____

City _____ State _____

Telephone _____ Zip _____

*In quantities of 50

PCS

PROCESS COMPUTER SYSTEMS, INC.

750 North Maple Road
 Saline, Michigan 48176
 313-429-4971 TWX: 810-223-8153

Circle 27 on reader service card

MOSTEK 3870 SINGLE

The solution to low-cost

Cost advantages increase potential applications.

Mostek's new single-chip 3870 microcomputer is the answer to maximum cost effectiveness in a wide range of control and logic replacement applications. Most obvious advantages are software flexibility, fewer components, low power and a 40-pin plastic package. The device now makes it economically feasible to replace as few as 12 TTL packages in an existing system while increasing capability. And the 3870 pinout allows applications to be implemented on single-sided PC boards, further reducing system costs.

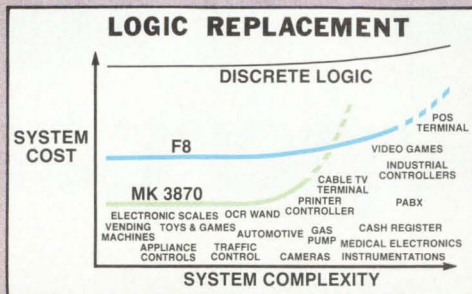

Full-capability on one chip.

The 3870 is the first single-chip microcomputer offering full compatibility with a multi-chip processor family. The device can execute the complete F8 instruction

set of more than 70 commands, providing complete software compatibility with the versatile F8 multi-chip family. It features twice the program storage as other single-chip devices—2048 bytes of ROM, 64 bytes of scratchpad RAM, four 8-bit I/O ports and a single +5 volt power supply requirement. If more memory (RAM, ROM or PROM) or I/O is eventually required, the system can be simply upgraded to the expandable MK 3850 (F8 CPU).

Low-cost, development tools.

Development represents a significant investment in your program. Mostek offers one low cost

Under

Versatile single phase 4 MHz clock

2Kx8 mask programmable ROM

Software compatible with existing F8 family

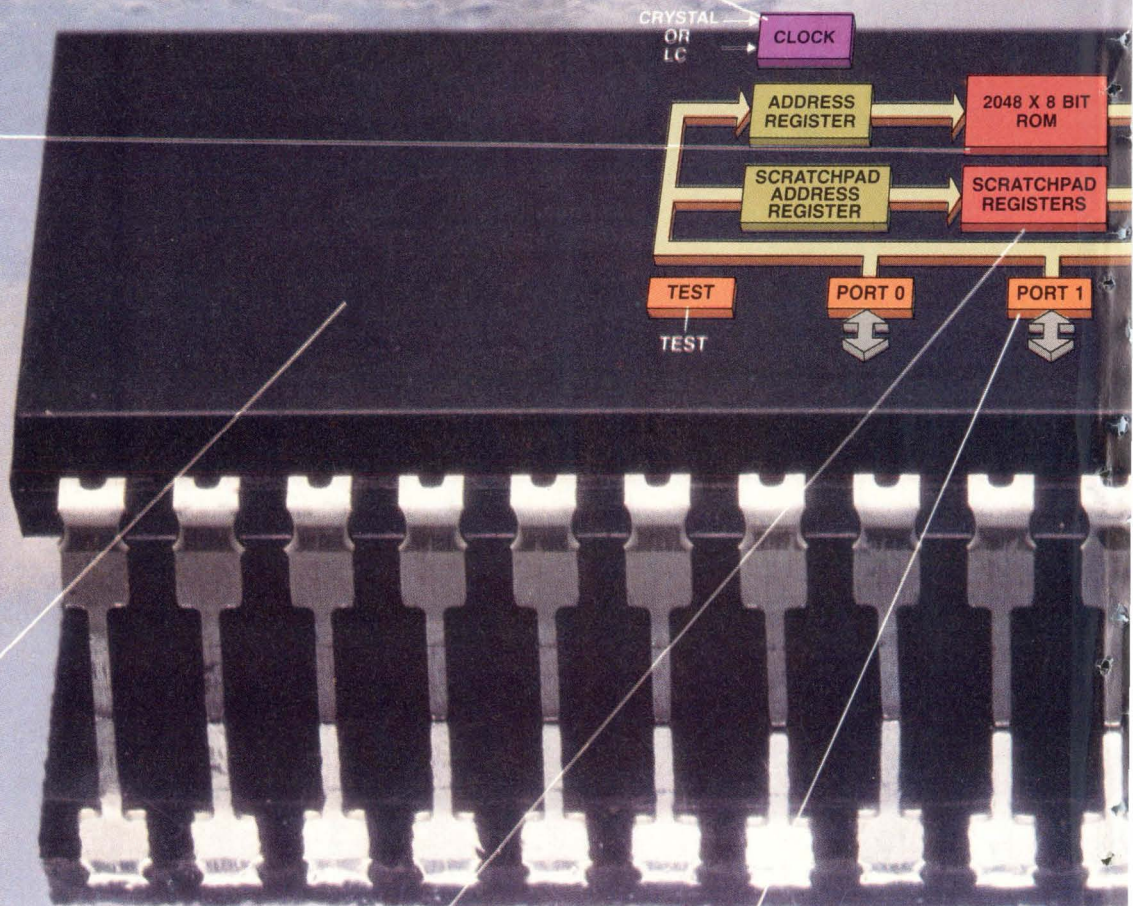

64x8 scratchpad RAM

32 bits (4 ports) bidirectional TTL compatible I/O

CHIP MICROCOMPUTER. logic replacement.

line that supports both the 3870 and FB multi-chip family. Included are the Software Development Board (SDB-50/70), Application Interface Module (AIM-70), and an Emulator (EMU-70) for PROM prototyping.

With completion of software development and debugging, your 3870 prototype may be emulated for field-testing and evaluation with the compact PROM-based EMU-70. This allows exact verification of code prior to committing to mask programmed MK 3870's.

From low-cost application development to low-cost delivery, your Mostek representative or distributor

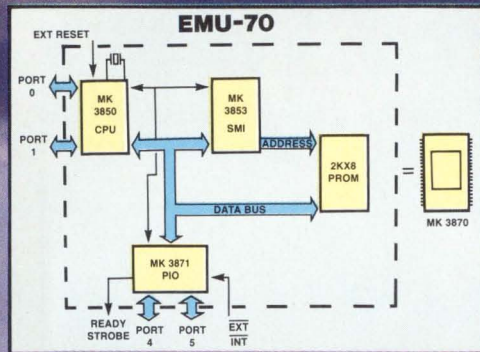

has all the answers. Call or write today for a free brochure describing the versatile 3870 single-chip microcomputer.

MOSTEK

1215 West Crosby Road
Carrollton, Texas 75006
(214) 242-0444

In Europe, contact:
MOSTEK GmbH
Telephone: (0711) 701096

MOSTEK ASIA
Telex: 85148 MKA HX

\$10.00*

Modulo "N" binary readable timer

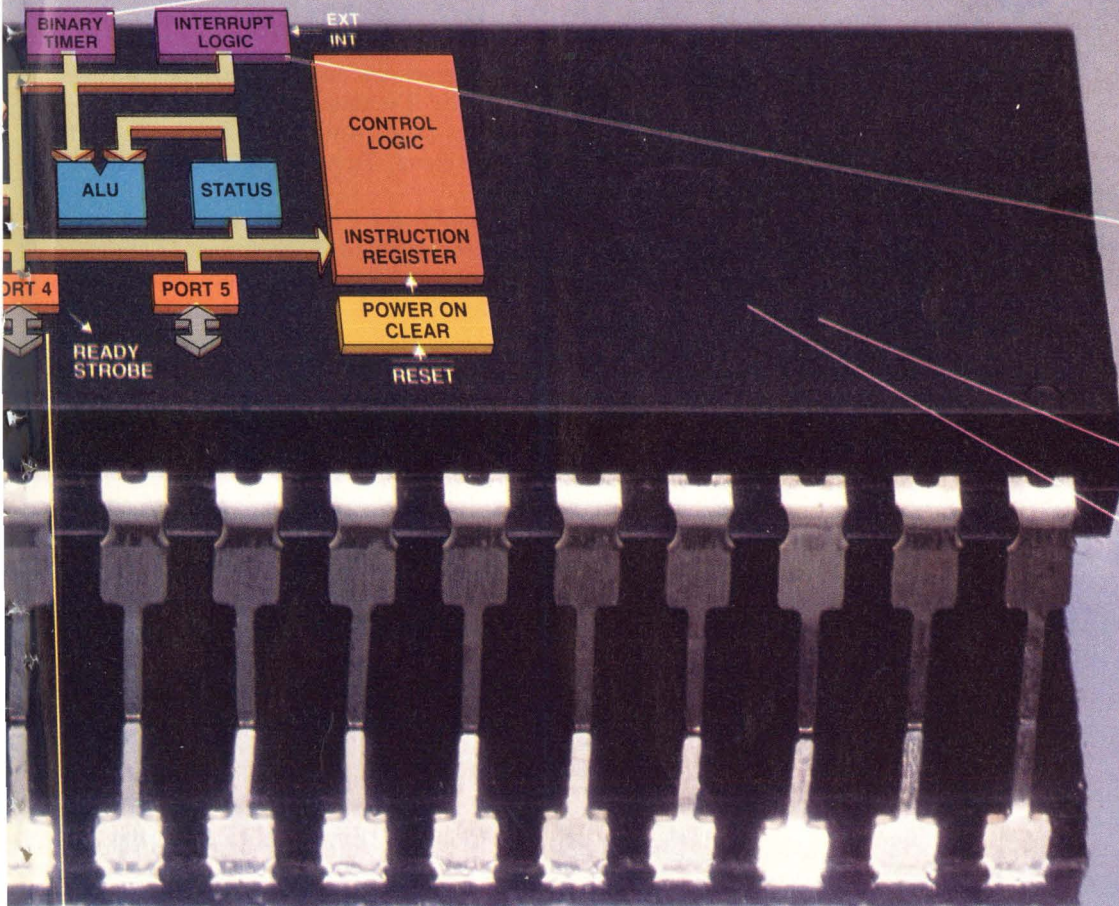

Four modes of vectored interrupts

Low Power (typ 300mW)

Single +5 volt $\pm 10\%$ power supply

Ready strobe provides handshake capability with port 4

*1000 piece quantities, 40-pin plastic package

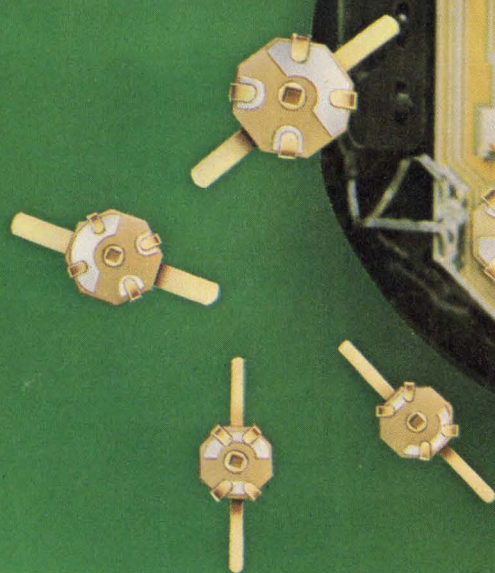

Thin-Trim[®] capacitors

Tucked in the corner of this Pulsar Watch is a miniature capacitor which is used to trim the crystal. This Thin-Trim capacitor is one of our 9410 series, has an adjustable range of 7 to 45 pf, and is .200" x .200" x .050" thick.

The Thin-Trim concept provides a variable device to replace fixed tuning techniques and cut-and-try methods of adjustment. Thin-Trim capacitors are available in a variety of lead configurations making them easy to mount.

A smaller version of the 9410 is the 9402 series with a maximum capacitance value of 25 pf. These are perfect for applications in sub-miniature circuits such as ladies' electronic wrist watches and phased array MIC's.

Johanson Manufacturing Corporation
Rockaway Valley Road
Boonton, New Jersey 07005
(201) 334-2676 TWX 710-987-8367

Meetings

Comcon Spring, IEEE, Jack Tar Hotel, San Francisco, Feb. 28 - March 3.

1977 SAE International Automotive Engineering Congress and Exposition, Society of Automotive Engineers, Cobo Hall, Detroit, Feb. 28 - March 4.

Nepcon '77 West—National Electronic Packaging and Production Conference, Industrial and Scientific Conference Management Inc. (Chicago), Anaheim Convention Center, Anaheim, Calif., March 1-3.

First Annual Joint Symposium on Ultrasound in Medicine, Ultrasonic Industry Association Inc. (New Rochelle, N.Y.), Hyatt-Regency Hotel, San Francisco, March 14.

Fourth Energy Technology Conference and Exposition, Government Institutes Inc. (Washington, D.C.), Sheraton-Park Hotel, Washington, D.C., March 14 - 16.

Symposium on Numerical and Asymptotic Techniques for Electromagnetics and Antennas, University of Arizona, Tucson, March 14 - 18.

Southwest Printed Circuits and Microelectronics Exposition '77, Industrial and Scientific Conference Management Inc. (Chicago), Market Hall, Dallas, March 16 - 17.

Vehicular Technology Conference, IEEE, Orlando Hyatt House Hotel, Orlando, Fla., March 16 - 18.

IECI '77: Industrial Applications of Microprocessors, IEEE, Sheraton Hotel, Philadelphia, March 21 - 23.

Fourth Annual Computer Architecture Symposium, IEEE, Sheraton Silver Spring Motor Inn, Silver Spring, Md., March 23 - 25.

Data Processing Technology: 1977-1981, American Institute of Industrial Engineers (Santa Monica, Calif.), Americana Hotel, New York, March 23 - 25.

THE NEW DIT-MCO SERIES 8210 AUTOMATIC WIRE CIRCUIT ANALYSIS SYSTEMS

Obsolete is Obsolete...

The DIT-MCO Series 8210, comprised of systems 8211, 8212, and 8213, offers the most complete package of automatic wire circuit test capabilities available to serve your present and continuing test needs. In fact, Series 8210 obsoletes the word obsolete. You can select the system to fit your current test requirements with certain knowledge that as your needs expand your DIT-MCO system can be upgraded to deliver!

Powerful Software / Hardware...

Series 8210 are real-time disc operating systems with disc file maintenance in the system.

Series 8210 systems are driven by fully interactive computer systems yet require no specialized operator training. A unique and comprehensive group of programs for testing, maintenance, and diagnostics are standard. Software is the evolutionary culmination of over five years experience and proven field use.

Eeny, Meeny, Miney...

You get a choice...to fit your budget. To fit your test needs. You get versatility, flexibility, the ability to expand and adapt. And remember, when you choose DIT-MCO you have chosen Number One.

A CHOICE...FLEXIBLE, EXPANDABLE, POWERFUL SOFTWARE/HARDWARE TEST SYSTEM PACKAGES

Too New to be Copied...

So new you won't find anything like it available anywhere else.

System 8210 incorporates all the "state of the art" advancements with some new wrinkles only DIT-MCO could provide.

So if you are going to look around for a comparison you will just have to compare the systems within the 8210 Series. None of the others come close.

Hand in Hand...

When you select DIT-MCO equipment you have bought not only the hardware and software you also get the Company...our over 25 years leadership in the field, our just reputation for treating every customer, big or small, with the same respect and dedicated service. With DIT-MCO you get it all!

Call or Write for Full Information

A DIT-MCO representative can show you how Series 8210 or any of our complete line of interconnect test systems can accommodate your test requirements. Call or write us for full information.

DIT-MCO—The Difference in Testing...



DIT-MCO INTERNATIONAL

5612 Brighton Terrace
Kansas City, Missouri 64130
Telephone (816) 444-9700
Telex Number 42-6149



European Technical Representative Radix House

Central Trading Estate
Staines, Middlesex, TW18-4-XA
England
Telephone (0784) 51444
Telex Number 935023

Intel 8080 peripherals

Now you can get microcomputer based products out of the lab and into production faster than ever before. Intel® 8080 programmable LSI peripherals give you the competitive advantage by helping you reduce design time, component count and manufacturing and inventory costs. Most of all they'll help you get to market first.

Intel 8080 programmable peripherals are software controlled LSI replacements for hardwired SSI/MSI logic assemblies. You simply attach the appropriate peripherals to the system bus and the +5V supply. Then, with system software, you personalize device operating configurations to suit your applications. Reconfiguration and design changes are made with software. No expensive and time consuming hardware redesigns are necessary.

One peripheral, the 8253 Programmable Interval Timer, is the first LSI solution to system timing problems. It counts out I/O servicing delays, eliminating software timing loops and increasing CPU throughput. It also saves hardware when you need event counters, rate generators or real-time clocks. Each 8253 contains three 16-bit timer/counters.

Our 8257 Programmable DMA Controller is the lowest cost way to handle applications that require high speed data transfer such as disks, magnetic tape, analog interfaces and high speed communication controllers. The four channel 8257 contains all the logic necessary for bus acquisition, cycle counting and priority resolving of the channel requests.

The 8259 Priority Interrupt Controller replaces complex TTL arrays and minimizes component costs. The CPU can change interrupt structure "on the fly" to suit changes in the operating environment, such as time of day or process control parameters. The 8259 handles up to eight vectored priority interrupts. Multiple 8259's can control up to 64 interrupt levels.

Use the 8251 Programmable Communication Controller for "serial I/O." The first true USART in a single chip, the 8251 implements all popular com-

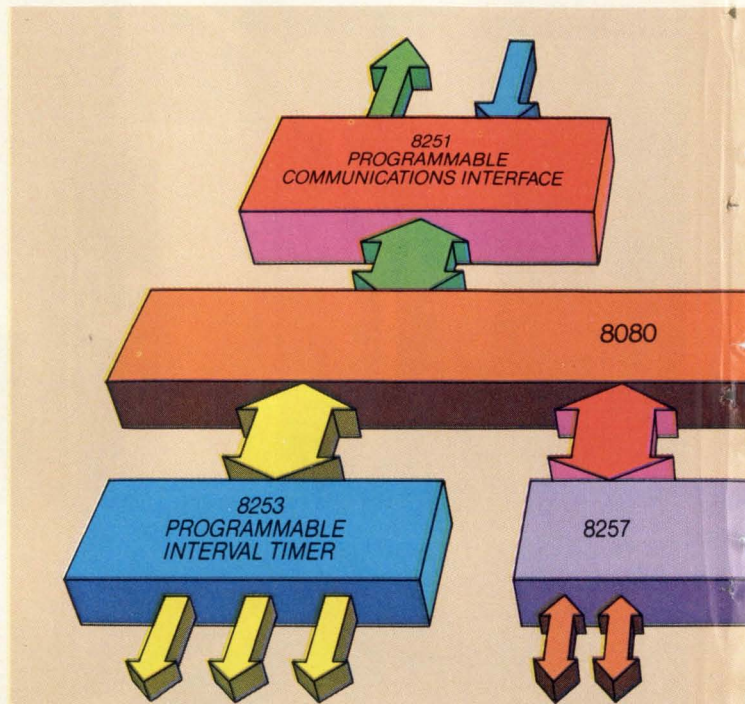

get you to market first.

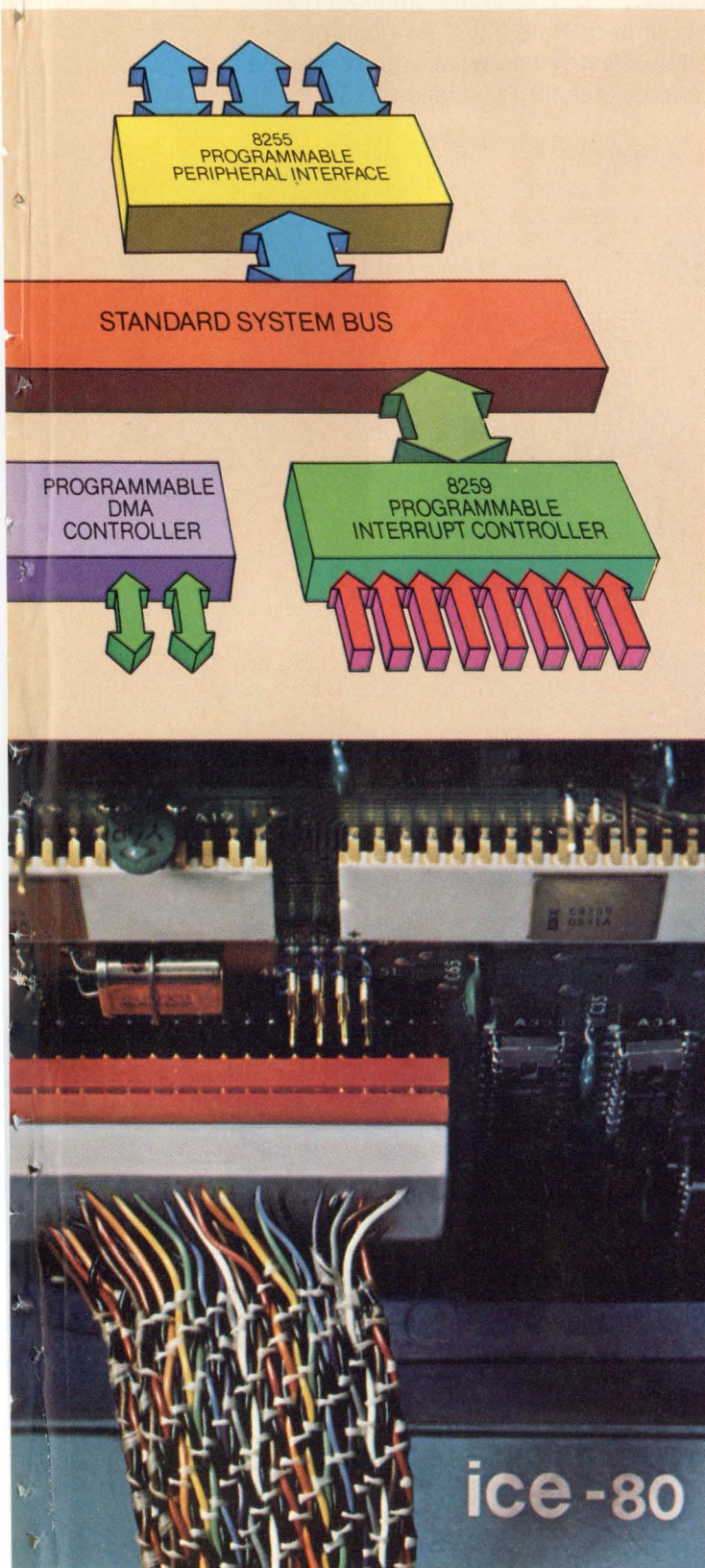

munication protocols, including IBM Bi-Sync. For "parallel I/O," each 8255 Programmable Peripheral Interface gives you 24 versatile I/O lines to interface relays, motor drives, printers, keyboard/display and other parallel equipment.

Once you've selected the peripherals to fit your application, use the Intel[®] Microcomputer Development System for both software and hardware development. Using the Intel[®] CRT terminal, call up the resident text editor. Write the source program to initialize the peripheral and the subroutines for peripheral/system operation. Then you assemble or compile the source programs into an object file using resident macroassembler or resident PL/M compiler—and store the object file on the Intel[®] diskette. With the relocation and linkage capability of the Intel[®] ISIS II diskette operating system, these routines can be added to a system library and called from user programs as needed. Once the main system program is written, the new peripheral device routines are easily linked in. The entire program is now ready to be run on your prototype via the Intel[®] ICE-80™ in-circuit emulation module. ICE-80 lets you debug your software and hardware in your actual prototype environment. Move from system integration and debugging to production in a fraction of the time previously required.

Intel also provides applications assistance, training programs, the largest user's program library, and volume production support. Intel's 8080 programmable peripherals give you the competitive advantage from start to finish. Be first to market.

To order the new peripherals, contact our franchised distributors: Almac/Stroum, Components Specialties, Components Plus, Cramer, Elmar, Hamilton/Avnet, Industrial Components, Liberty, Pioneer, Sheridan or L.A. Varah. For your copy of our 8080 System brochure write: Intel Corporation, 3065 Bowers Avenue, Santa Clara, California 95051.

intel[®]

Microcomputers. First from the beginning.

The one variable the world can standardize on.

Our new Type M conductive plastic variable resistor is hard metric. A 10 mm cube that's tiny, flexible and rugged. The MINI-METRIC is the smallest dual pot available today. Manufactured in the United States, it's dimensioned the way the rest of the world thinks. Allen-Bradley has what you need; or, it can be ordered through our distributors. Ask for Publication 5239.

Choices
single or dual pot or
pot/switch combinations

100 ohms to 1 megohm

conductive plastic resistance
elements, $\pm 20\%$ tolerance,
standard resistance values
conform to IEC.

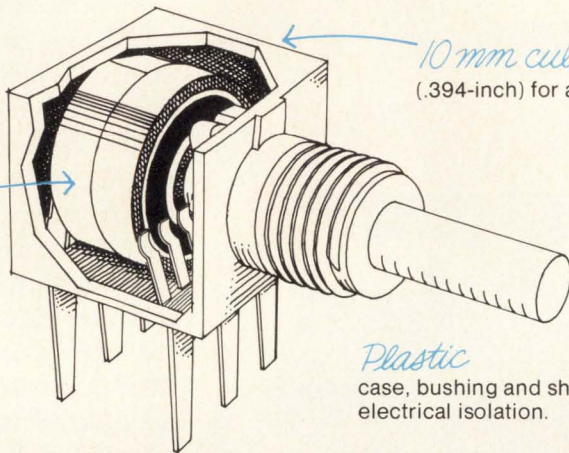

10 mm cube
(.394-inch) for all combinations.

Plastic
case, bushing and shaft for
electrical isolation.

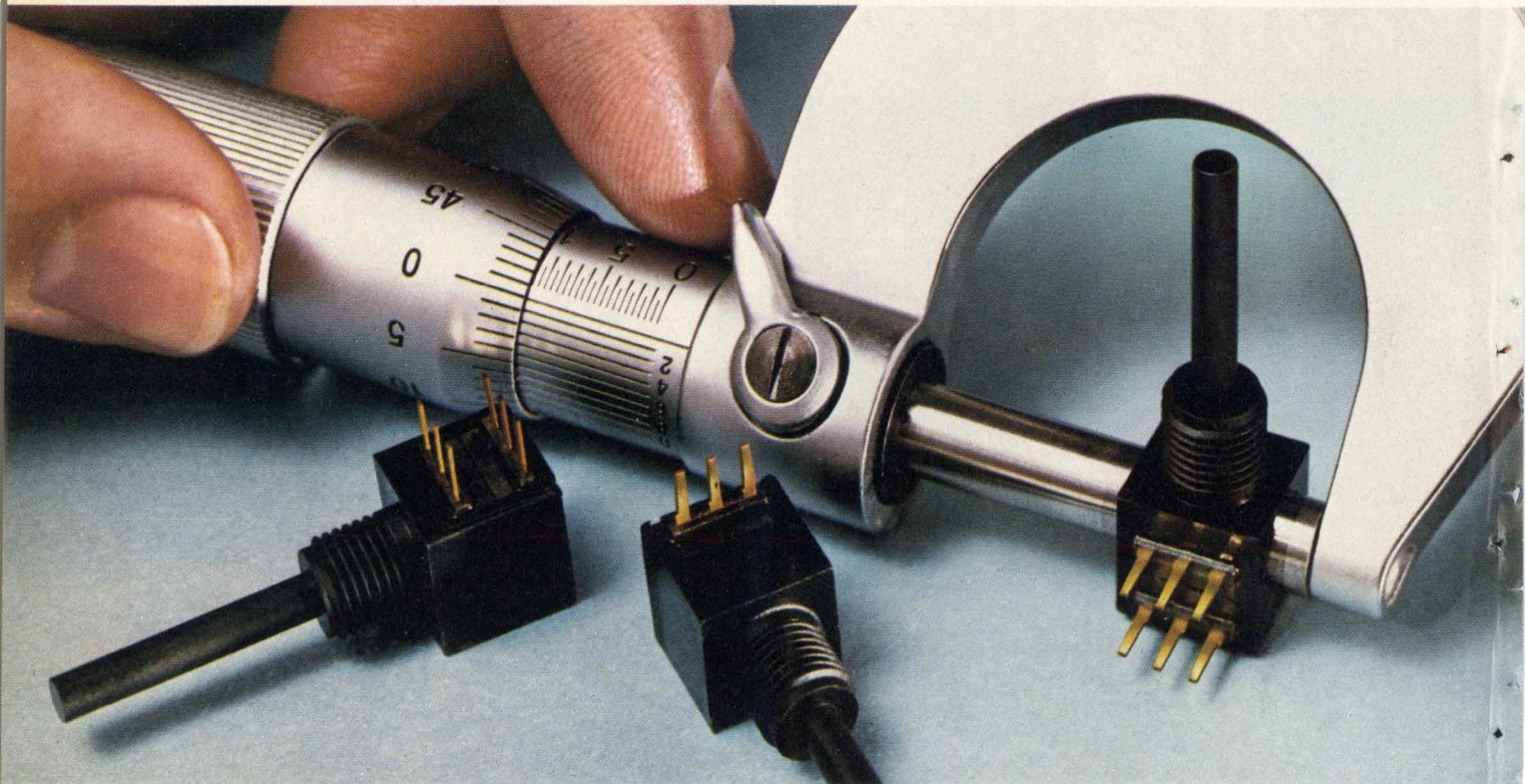

Quality in the best tradition.



ALLEN-BRADLEY
Milwaukee, Wisconsin 53204

EC131

RCA maps concerted push in SOS circuits . . .

A semiconductor industry that continues to view silicon on sapphire as exclusively a performance-oriented military technology, and not price-competitive, may be in for a surprise. This is the year that RCA's Solid State division, which sold nearly \$250 million worth of semiconductors last year, will be putting its two years of commercial investment in SOS on the line with a host of digital C-MOS-on-sapphire circuits. Says Philip R. Thomas, division vice president and director of MOS operations, "**We are moving our sapphire line into full manufacturing status** at our LSI facilities in West Palm Beach."

In microprocessors, the company will have samples of a sapphire version of its 1802 C-MOS microprocessor, the 1802-S, which executes instructions typically in 1 microsecond, or two and a half times as fast as the bulk version. In random-access memories, the company will have eight static C-MOS-on-sapphire RAMs, priced to compete with n-MOS statics for microprocessor and peripheral applications. Two 4,096-bit static RAMs (4,096-by-1-bit and 1,024-by-4-bit) will operate in the 200-to-300-nanosecond range, dissipate a mere 10 milliwatts of power, and have a 28,000-mil-square chip that will make them smaller and potentially cheaper than some n-MOS equivalents. RCA engineers also are working on read-only memories, ultraviolet-erasable programmable ROMs, timing circuits, watch chips, and analog-to-digital converters, all in sapphire.

. . . and prepares to sign processor second source

Meanwhile, RCA expects soon to pick up another domestic alternate source for its microprocessor line—Solid State Scientific Inc. of Montgomeryville, Pa. Leonard Kedson, president, confirms that the two companies are **about to complete a deal covering the 1800 microprocessor family**, (1802 central processor, RAMs, ROMs, and peripherals) in both the C²L (closed C-MOS) version and, eventually, the sapphire version. Hughes Aircraft's MOS division is now a supplier of the 1800 bulk devices.

RCA itself is filling out its microprocessor family with a multitude of peripheral parts slated for 1977 entry: bus and data buffers, n-bit decoders, memory interface chips, computation extenders, and some programmable input output chips. The firm also is introducing a TV display chip, the 1861, that works with the 1802 and other processors. Its first application will be in microprocessor-based video games.

Univac jumps into business-computer arena

Convinced that small business computers form the "fastest-growing marketplace in the computer industry," Sperry Univac is preparing to deliver its first system, the BC/7, in April. The Sperry Rand Corp. division predicts that the demand for small machines in the U.S. **will grow 21% annually through 1981, nearly doubling to \$6.1 billion from \$3.27 billion.** The market is now dominated by IBM's System 32 and Burroughs Corp.'s B-80.

The wholesale/distribution and manufacturing markets, as well as general accounting applications, are the initial targets of the BC/7, which is riddled with microprocessors. Intel Corp.'s 8080 devices turn up in the control processor, operator console, work stations, and as a device controller, while Intel's 3000 series processor slices are used for direct-memory-access control and in a macro-instruction processor for improved program execution. Main storage, 32 to 64 kilobytes expandable in 16-kilobyte increments, uses 4,096-bit random-access memories, Intel's 2107 and its Texas Instruments counterpart, the 4060. Typical purchase prices

range from \$43,725 to \$57,434, or about \$933 to \$1,304 per month on a five-year lease.

Lloyd, National's MOS LSI chief, to start own firm

Robert Lloyd has left his job as group director of MOS LSI at National Semiconductor Corp. The 43-year-old Lloyd, who founded Advanced Memory Systems in 1968, says he is now forming a company that will cash in on **"applying microprocessor technology to the power-supply business."**

Lloyd was replaced quickly at National by Roy Thiels, who has been National's European technical director and managing director for its United Kingdom operations.

Participants hope solar program will heat up

"A feeling of anticipation" that changes are in the offing permeated late January's quarterly integration meeting in San Diego on the ERDA-JPL program to develop a low-cost silicon-solar array. "Nobody knows what to expect from the new Administration," admitted one participant, but he noted a hopeful attitude that more impetus will be put behind all the photovoltaic-energy efforts sponsored by the Energy Research and Development Administration and the Jet Propulsion Laboratory. The low-cost program, **slow in getting started in 1975, has lagged even more since then.**

Speculation at the meeting also centered on which of the nine industry bidders will win the prime contract for Sandia Corp.'s 10-kw solar-cell concentrator array (see p. 44). Front-runners are said to be giants Westinghouse Electric, Martin-Marietta, and small Spectrolab Inc.

Microwave oven sales to soar another 38% in '77

Sales of microwave ovens leaped 60% in 1976 and will show another 38% gain this year, growing to 2.2 million units valued at \$900 million retail. That is what William W. George predicts, president of Litton's Microwave Cooking division, America's largest manufacturer. What's more, models with electronic touch controls—first introduced last year—**will account for half of this year's sales.**

George pegs 1978 sales at \$1.2 million, outstripping the combined markets for conventional gas and electric ranges, and figures that by 1985, half of all American homes will have microwave ovens.

Addenda

After a year of product refinement, Monroe Calculator Co. is bringing out a ledger-card computer manufactured in Sweden by the Datasaab division of Saab-Scania. Monroe is marketing the self-contained desktop computer, called the LCC/60, **in hopes of filling a gap it sees** in small- and medium-sized business-accounting systems, below expensive minicomputer systems. . . . IBM's Office Products division, which dominates the word-processing market, has caught on to the fast-growing competition for CRT-display text-editing terminals. With typical CRT systems running about \$35,000. to \$40,000, **IBM has introduced the Office System 6 priced at \$31,850.** This package includes the display, diskette storage, magnetic card reader/recorder, high-speed ink-jet printer, and paper-handling equipment. The terminal without printer is \$16,450. Also, a communication option is available for \$4,270.

All aerosol cleaners are not alike.

What do we mean by this statement? Simply, that not all industrial cleaners have kept pace with the increasing demands for purity in the electronics industry.

For years now, we've recognized industrial cleaning as a vital link in maintaining component and system purity and reliability. And here's what we've done to make sure Miller-Stephenson aerosol cleaners can help achieve the system integrity you need.

PURITY COMES FIRST In laboratory testing, Miller-Stephenson aerosol cleaners have the lowest residual contamination in the industry — some approaching 5-7 parts per million. The general industry range is 50-130 ppm.

We believe the purer *our* product, the better the performance and reliability of *your* product.

ATTENTION — FILTER AT WORK We use only the highest grade certified virgin solvents and propellants (all propellants are nonflammable — TWA 1000ppm — the surest, safest propellants available.)

We *double filter* our Freon solvent and propellant, first with a 5 micron filter, then with a Millipore 0.2 absolute filter. The filtered product goes directly into seamless cans, eliminating any possibility of flux contamination from seamed cans. We have complete quality control, from tanker to customer.

WE'RE FUSSY ABOUT OUR LOADING ENVIRONMENT Our loading room environment is immaculate, controlled by Clean Room conditions. Each loading line is kept exclusive for an individual product. This avoids the danger of contamination often caused when loading lines are used for multiple products.



MS CLEANERS CAN BE SHIPPED WITH SAFETY Here's an important bonus! Because of our special formulating most Miller-Stephenson aerosol cleaners can be shipped Air Transport. They are exempt from all the federal regulations listed under the heading, "Restricted Articles".

WHY DO WE TELL YOU ALL THIS? *Because we believe no other aerosol cleaner now on the market meets these purity standards.* And we think the rigid standards we demand of our products will help you meet your own high level of safety and reliability.

But let us send you a can of MS-180 Freon TF Solvent to try for yourself.

"Freon" is DuPont's registered trademark for its fluorocarbon compounds.

miller-stephenson

Danbury, Connecticut 06810 (203) 743-4447

- Enclosed is \$2.00, please send trial unit of MS-180 Freon Solvent
- Enclosed is \$5.00, please send trial units of MS-180 and Cobra Brush
- Please send FREE literature and prices on complete line of MS cleaners

Intended Use _____

Name _____ Dept./Title _____

Company _____

Address _____

Since our products are For Industrial Use Only, government labeling regulations prevent our sending these trial units to your home address.

LOS ANGELES • CHICAGO • DANBURY, CT. • TORONTO

E2V



Our exclusive **Cobra extension brush MS-226** will convert any Miller-Stephenson aerosol cleaner into an efficient metered spray with scrubbing action. Insures maximum cleaning accuracy with minimum solvent waste.

Circle 37 on reader service card

GI microprocessors "dedicated" to help you compete

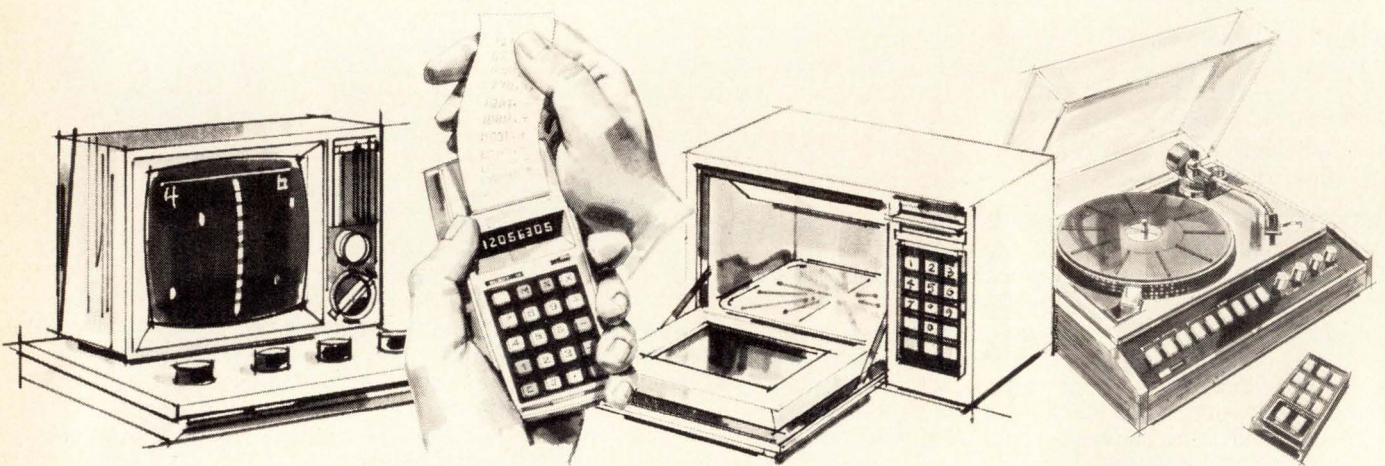

The TV Games Microprocessor

Put your boss in the corner by challenging him to a TV game. Or two. Or maybe six. GI makes six-games-on-a-chip—tennis, squash, soccer, practice and two target shooting games. Plus microprocessors for many more games including two intriguing tank battle games. And advanced ball and paddle games. It's not surprising that we're the leader in TV game chips. After all, GI Microelectronics was the **first** to achieve high volume capability in microprocessors for TV games. Today, we make them in three types: dedicated home games, programmable "Interactive" games and custom arcade games... Tennis anyone?

The Calculator Microprocessor

For the record... our hand-held printing calculator circuits are making the revolution possible. General Instrument Microelectronics makes all kinds. From a simple 4/5 function chip to a full scientific microprocessor. Printout or display. Or printout and display. Hand-held or desktop. We've been a major supplier of MOS/LSI circuits for hand-held display calculators from Day One. Today, GI chips are compatible with a whole new generation of low-cost miniaturized print mechanisms... Any way you figure it, our calculator chips make you more competitive.

The Appliance Microprocessor

Things are really happening in the kitchen... thanks to GI microprocessors. A good example: the microwave oven. One of our circuits masterminds the entire operation. Cooking. Defrosting. Time display and timing. Reset. Right down to the beep. Our circuits can do the same for your products, too. Need a 24-hour programmable, repeatable on/off switch with 24-hour clock? How about a count-down timer? You name it... chances are we already make it. If not, we can "cook up" one just for your requirements... For the best in appliance microelectronics... come to the circuit "chefs".

The Music Microprocessor

Have you ever wished for a "smart" record player? That is, a turntable you could control to select any or all tracks on a long-playing record. Play them in order. Or skip and repeat. Today, the "intelligent" turntable is a reality... and a General Instrument Microprocessor controls the 25 commands you can give it, either by push buttons or remote control. We're big in other areas of the home music field, too. Our piano circuit makes almost anyone a pro. You'd swear the sound comes from a real piano. That goes for GI's electronic organ circuits, too.

General Instrument is dedicated to microprocessors and GI Microprocessors are dedicated.

GI Microprocessors are *optimized* for the application they serve. And GI *minimizes* the additional circuits needed to interface the microprocessor to your specific application. As a result, you pay only for the circuitry that's relative to the performance of your product.

For example, a standard microprocessor designed as a numbers cruncher isn't the optimum vehicle for appliance control. It requires too many external circuits to interface it with the appliance and it carries along overhead hardware you simply don't need. In contrast, the GI approach provides a dedicated microprocessor that permits you to program the functions your appliance requires for its own personality... The optimum cost solution to the application.

Here are a few examples of how GI's "dedicated" approach to microprocessors is working for customers whose applications call for high volume and minimum cost.

GENERAL INSTRUMENT CORPORATION MICROELECTRONICS

600 WEST JOHN STREET, HICKSVILLE, NEW YORK 11802

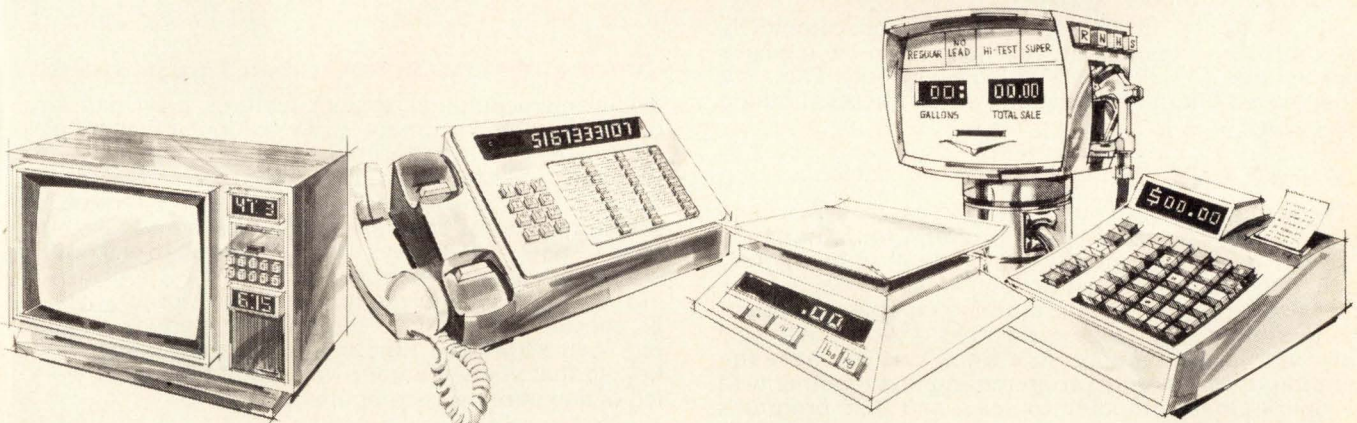
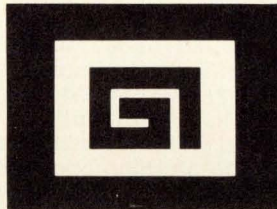

The Television Microprocessor

These TV circuits can turn on your sets... and turn on your customers. GI makes digital tuning systems for the most advanced sets on the market. Like yours. One microprocessor lets the user select 82 channels with on-screen channel display. It fine-tunes all channels independently and retains tuning data in its memory when power is off. Without CMOS and without a battery. It's remoteable, too. How about radio circuits? We make a radio receiver frequency circuit that counts and displays MW, SW and VHF. And another for AM/FM with a 12-hour clock... If it's TV/radio circuits you need, you need our "dedicated" microprocessor line.

The Telecommunications Microprocessor

GI microprocessors are opening the way to advanced telephone technology. Our MOS/LSI circuits make the telephone almost human. They're making possible today's third generation, solid-state phone. And tomorrow's "superphone". Take one-button dialing. Instead of dialing, you simply push a button. The phone dials for you. Instantly. Automatically. And if you get a busy signal, the phone will re-dial until you hang up. You can even change your phone into a data transmission center. And we have circuits that convert push button input to rotary dial pulses... and decode them... Making phoning easier is another job for GI Microelectronics.

The "Anything" Microprocessor

Our PIC1650 circuit exemplifies GI's most advanced dedicated microprocessor technology. To date, that is. It's a great little miracle worker—a micro-computer on a single chip. Other manufacturers have simply upgraded one of their calculator chips or merely combined an old multiple chip processor and called it a single-chip computer. But the PIC1650 is the genuine article. We designed it from the ground up with true computer architecture. Our PIC1650 chip contains a microprocessor. A 512x12-bit ROM. A 32x8-bit register file. Four sets of eight I/O lines. And more... including the software that lets you

program it to do the things you want it to do. The PIC1650 can do wonders for vending machines. Automatic gasoline pumps. Commercial and consumer scales. Fast-food cash registers. Telephones. Appliances. Postage stamp meters... the possibilities are endless. You probably have a product right now that can use the PIC1650 to broaden its range of useful functions at less cost. Or you may prefer one of our other dedicated microprocessors.

**We help you
compete.**

Microcomputer pro with the Iasis Co

The fact is that right now microcomputer programming is a bear. Microprocessors are loaded with subtleties which make software development a long, arduous process. That's why we developed the ia7301 Computer in a Book*. It's a fully operational microcomputer system and a 250 page programming course all contained in a 3-ring binder. This is not a kit or a toy but a powerful, microcomputer system (based on the industry standard, the 8080) and a practical programming course specifically designed to quickly bring you up to a high level of understanding and proficiency in programming 8080 based microcomputer systems.

The Computer in a Book comes to you completely assembled and tested. All you need is an inexpensive dual voltage (+12V & +5V) power supply. The -5V is generated internally in the computer. There is nothing else to buy.

A super programming course

The programming course text is easy to follow and begins with a one instruction program to determine if a switch is open or closed. This is built upon and expanded through all 78 instructions until 250 pages later, you become adept at programming complex problems like multi-byte arithmetic and games of skill like Pong™. Only with Iasis Computer in a Book can you have the advantages of a handy programming text together with an operational computer to load and test programs each step of the way and thereby learn the intricacies of microcomputer programming at a comfortable pace.

And since this microcomputer has a special built in monitor program which allows you to look into the operational parts of the system you'll never get bogged down in debugging or editing. The ia7301 Computer in a Book is the fastest way to learn everything about microcomputer programming.

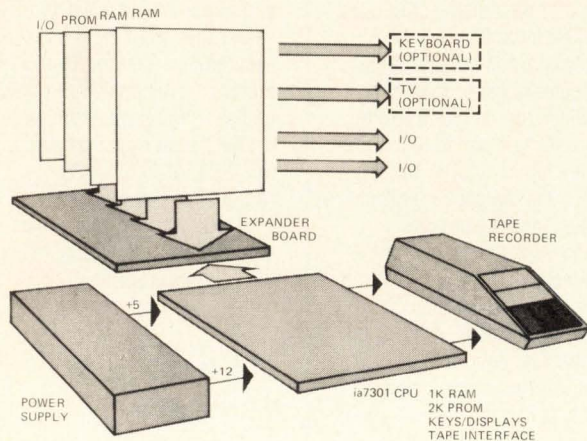

*U.S. Patent Pending
Pong is a trademark of Atari, Inc.

Some great microcomputer features, too

The microcomputer system features a 24 pad keyboard, 8 seven segment LED readouts that display information in hexadecimal code which is far more versatile and advanced than binary or octal coded systems, and an onboard cassette tape interface for saving programs. The hexadecimal keyboard also contains 6 special mode keys which allow you to call up and change any data or instructions in the CPU registers or in the system's RAM memory. Likewise programs can be executed instantly or they can be stepped through one instruction at a time using the appropriate mode key, so that you learn your way around the inner working of an entire microcomputer system.

Also the write tape and read tape mode keys have been carefully designed for accurate and convenient operation with any home cassette tape recorder that has an earphone and remote microphone jack. Two LED indicator lamps tell how long it takes to dump or reload programs from the system's memory onto tape and back again. But in the reloading cycle, if any errors have occurred such as a lost piece of data or the volume knob is too low, the readout displays will indicate errors. This little feature prevents untold problems in debugging a reloaded program.

Upwards expandability from the start

We designed the Computer in a Book to be upwards expandable and not become a kluge in the process. The microcomputer contains 1K bytes of RAM memory, 1K bytes of PROM memory (containing the monitor program), and 2 I/O ports. The Computer in a Book is expandable to virtually any level you want, i.e. up to 65K bytes of memory and 256 I/O ports.

Optional expander boards are available and attach to the ia7301 computer at the top edge connector. A wide variety of standard interface boards can be plugged into the system to give add on memory, TV and teletype interface, and much more.

Thus what served as an educational system can now be upgraded for many new applications. We've included a machine language coding pad for writing and documenting programs, working out subroutines and pro-



Programming is a snap Computer in a Book

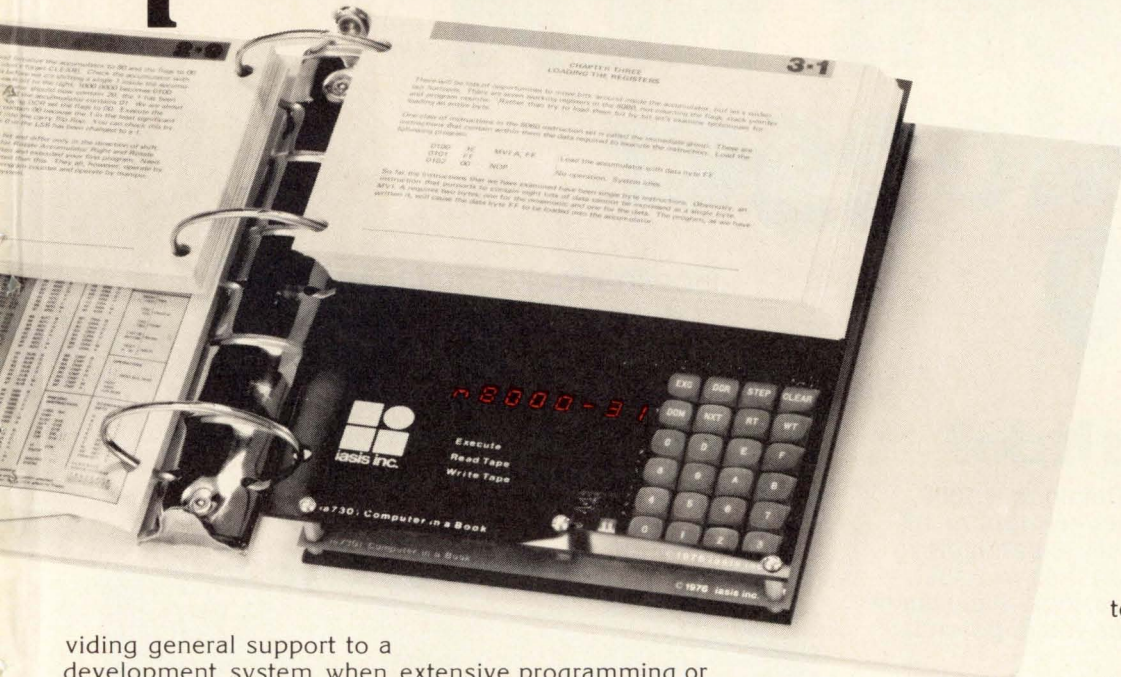

providing general support to a development system when extensive programming or debugging is necessary. The Computer in a Book may also be used to train field service technicians by putting verbal information and programs on cassette tapes. We are coming out with preprogrammed PROMs and extension tapes containing new application packages such as floating point arithmetic and micro-assembler programs. Our goal is simple. We want to provide microcomputers that are useful and practical.

A college assistance program

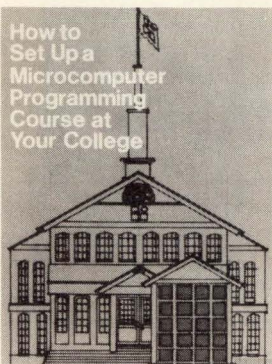

Educators interested in exposing their students to a comprehensive background in Microcomputer programming should look into the Iasis Microcomputer Instructional Courses for their college or university. Send for our free pamphlet which describes ways of setting up short microcomputer programming courses. It offers some advice on structuring a coordinated and comprehensive program, so your students can learn

programming and get valuable hands-on experience with operational systems at very reasonable prices.

The price

The complete Computer in a Book which includes an operational 8080 based system, 250 page programming course, machine code pad, hexadecimal conversion card all in a 3-ring binder is offered for only \$450. The Computer in a Book has a 90 day parts and service warranty. Iasis also provides a check out list and start up instructions with each system. Please allow 30 days for delivery.

A free bonus

If you order your Computer in a Book before April 15, 1977, Iasis will give you an \$8.00 Microcomputer Applications Handbook as a free bonus. It contains 144 pages of text, diagrams, and tables on hardware design and microcomputer applications. Order today. If the Computer in a Book isn't everything we say it is, then

return it within 15 days for a full refund and keep the Applications Handbook as a gift. We're sure you'll find that microcomputer programming is a snap with the ia7301 Computer in a Book.

Here's my check or money order for _____ complete ia7301 Computer(s) in a Book at \$450 each. Since I ordered my Computer in a Book before Apr. 15, 1977, I want the Microcomputer Applications Handbook as a free bonus. (Calif. residents add 6½% sales tax).

Charge my order to the credit card below:
 BankAmericard No. _____
 Master Charge No. _____
 For Master Charge card, put 4 digit number from above name here _____
 My Signature _____
 Credit card expiration date _____
 Name _____
 Firm _____
 Address _____
 City _____ State _____ Zip _____

Please send me your pamphlet on setting up a Microcomputer Programming Course.

Mail to: Iasis Inc., 815 W. Maude, Suite 31, Sunnyvale, CA 94086

(408) 732-5700



iasis inc.

U.S.A. cash orders shipped freight prepaid.
 C.O.D. and overseas orders freight collect.

United Systems' NEW Datalogger 1000

What does it do?

For only \$1995 your Datalogger 1000 comes complete, ready-to-monitor 10 data points and is easily expandable to 100. Unattended, it watches your test, experiment or process, logs all pertinent information and warns you of potential problems.

It provides continuous display of time, channel and 20,000 counts of measured data for instant visual analysis while the hard-copy printout permanently records the same information for future reference... all standard.

With the Datalogger 1000, you only pay for the capability you require. A minimum initial investment will meet your present measuring needs, while low-cost field-installable modules provide the flexibility to change parameters as required.

Simplicity of front panel controls provides straightforward operation... easy enough for anyone to use without special training.

Compact and portable, the Datalogger 1000 can be used by Research, Engineering or Manufacturing, in the plant or in the field, to provide a quick return on investment.

At \$1995, there is nothing comparable.

For additional information contact your United Systems Representative or call the factory (513) 254-6251.

Doesn't make mistakes, take coffee breaks or get sick...

Doesn't watch the clock (although it has one)...

Doesn't get premium or overtime pay and never complains...

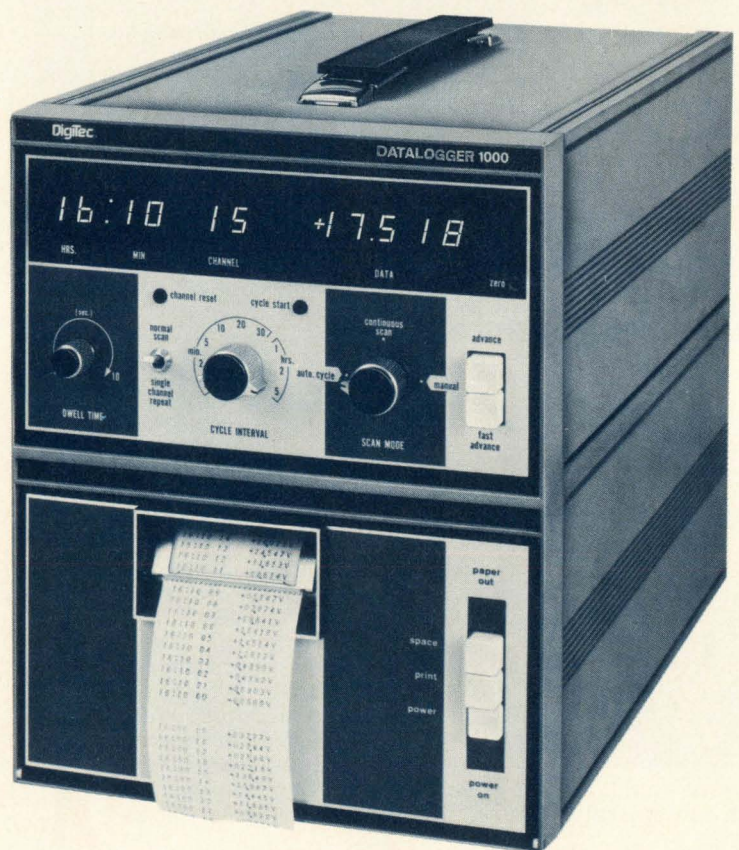

Digitec UNITED SYSTEMS CORPORATION

918 Woodley Road, Dayton, Ohio 45403
(513) 254-6251, TWX (810) 459-1728

United Systems Corp.:
Precision measurements to count on

AM9511 APU, by comparison, enables an 8-bit CPU-based system, such as the 8080A, to do floating-point multiplication in about 200 μ s, square roots in 400 μ s, and sine functions in 2 ms. A faster 4-MHz version, designed to operate with AMD's 1- μ s version of the Intel 8080A, the AM9080A-4, does the same operations in half the time.

Bit slice. Such an increase in throughput is achieved, Allison says, because the APU is essentially a special-purpose "slave" processor with an instruction set designed to perform such complex arithmetic calculations on command from its host 8-bit CPU. Combining its depletion-mode MOS technology [*Electronics*, May 13, 1976, p. 65] with the bit-slice approach to com-

puter architecture of its 2900 bipolar bit-slice family, AMD has built a 16-bit arithmetic-oriented processor on the 200-by-200-mil AM9511. Included are a 16-bit arithmetic/logic unit, a microprogram-sequence controller, an 8-level operand and stack register, a 10-level working-register stack, command and control registers, and a control read-only-memory array.

Also in the works, using the same special-purpose slave-processor approach are a multimode direct-memory-access controller, the AM9517, and a universal priority-interrupt controller, the AM9519. Both are programmable, says Allison, and capable of doubling the throughput of 8-bit CPU-based systems. □

Packaging & production

Standards project leads to universal socket for four chip carriers

For many large mainframe producers, the dual in-line package may be reaching the limits of its usefulness. As a vehicle for mounting large-scale integrated circuits onto printed-circuit boards, package limitations show up in the multileaded 40- and 64-pin versions, where excessive lead length adversely affects chip rise time.

It is no wonder, then, that many large users of LSI are seriously considering the use of chip carriers in their upcoming equipment. Chip carriers, which are small leadless ceramic or plastic reflow-solderable packages about a third the size of a comparable DIP, have nearly three times the upper-frequency capability of DIP packages.

Prodded by Sperry Univac and the IEEE Computer Packaging Committee, Jedec task group JC 11.3.1 of the Electronics Industries Association has written an unusually comprehensive standard for a family of 50-mil-spaced LSI chip carriers and sockets for pc-board use. This document, drawn up by the task group's computer, semiconductor, and pack-

age, and socket representatives, is only one segment of an overall LSI-packaging standard that will also include chip carriers with 40-mil spacing, DIPS, and quad in-line packages. The other segments are still in the planning stage, but an EIA meeting on DIPS is scheduled for Feb. 7 in Santa Clara, Calif.

Interchangeable. With the chip-carrier standard, a pc-board user may interchange four and possibly five types of chip carriers without having to redesign his board. Dan Amey, engineering manager of packaging techniques at Sperry Univac, Bluebell, Pa., and chairman of the task group says, "Our committee recognized quite early that a chip-carrier standard built around only one technique is not practical."

The standard, which has been mailed out for member approval, is designed around four different types of chip carriers, all of which have their contacts on 50-mil spacings. The first two types are single-layer and multilayer metalized ceramic carriers, both of which normally are reflow-soldered to ceramic sub-

strates in hybrid applications. The multilayered type is similar to parts already commercially available. Since the temperature coefficients of the carriers' ceramic and the board's epoxy glass are not close, these two carriers require a socket.

The third type of package specified, now under development at Berg Electronics, is a small square ceramic carrier with edge clips on all sides. The compliant leads of these clips can be reflow-soldered to a board or plugged into a socket. The fourth package is a premolded plastic package with compliant leads being designed at AMP, Inc.

Fifth possibility. In addition, the footprint that holds the universal socket will take General Instrument Corp.'s Minipak, a low-cost glass-epoxy carrier too large for the proposed socket, giving a user a fifth possibility—a Minipak soldered directly to the board. The proposed carrier family would cover devices having 28 to 156 leads with square package sizes ranging from 0.450 to 2.050 inches on a side.

Sockets, which would be attached to the universal footprint on the board by reflow soldering, would have internal corner posts and locating features for positioning the various types of chip carriers. The socket is the subject of a concurrent effort under the EIA standard P5.2 committee. A meeting is scheduled March 2 at Nepcon West to set socket dimensions. □

Photovoltaics

Sandia to fund 10-kW array

January saw the startup of its 1-kilowatt photovoltaic optical concentrator array—and 1978 will see a 10-kw unit in operation, if plans at Sandia Corp. go well. While Sandia built the 1-kw array itself from its own solar cells, it will delegate the entire manufacture of the 10-kw unit to a prime contractor, to be picked from nine industry bidders.

"We'll be picking and announcing

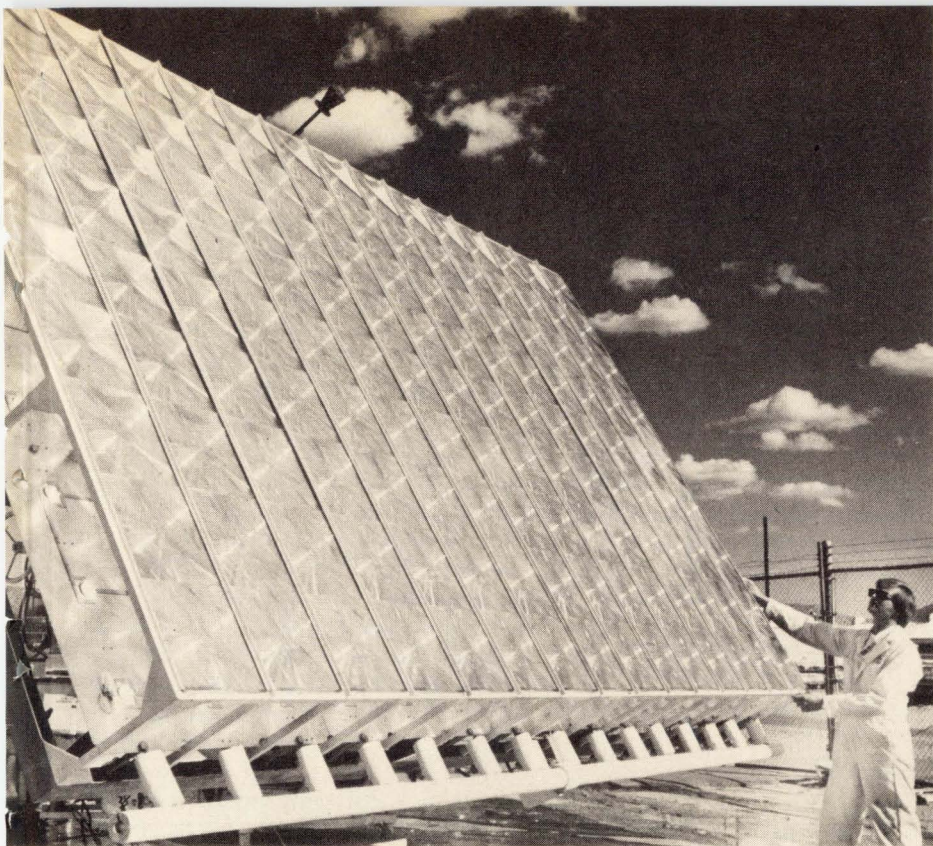

Arrayed. Lenses in front of the 135 solar cells in Sandia Laboratories test concentrate sun's rays for 1-kilowatt output. Next step is 10-kW array.

the contractor within the next few weeks," predicts Donald G. Scheuler, supervisor of Sandia's Photovoltaic Systems Definition Projects division. He would not name the bidders, but he says they include all current cell producers like Spectrolab Inc. and Solarex Corp. Not included are any of the large semiconductor firms like Texas Instruments, Rockwell International, and Motorola Semiconductor, which have contracts in a separate project—the low-cost silicon-solar-array program administered by the Jet Propulsion Laboratory. Both programs are funded by the U.S. Energy Research and Development Administration [*Electronics*, Nov. 11, p. 86].

\$2 a watt. The nine bidders for the 10-kw unit are being asked, in part, for "demonstrated technology to get the cost to \$2 a watt in 1978 when the array will start operating," Scheuler says. This goal is at least several years ahead of JPL's program schedule. The lowest ERDA photovoltaic energy cost now contemplated is 50 cents a watt by 1986, and Sandia is increasingly confident that concentrator arrays can achieve that figure by the early 1980s. For that reason, they hope for an increase in

their program funds, which now run at about a quarter of JPL's level.

The 1-kw concentrator array has 135 plastic Fresnel lenses that focus sunlight, with a 50 times greater intensity boost, on 135 silicon solar cells [*Electronics*, July 22, p. 41]. This concentration produces a peak output of 1 kw from 2.9 square feet of cell area. Scheuler says the 1-kw array is "a continuing test bed that will be repopulated with better next-generation cells and [will be used] to evaluate the lens lifetime and reliability of the system." It is cooled by circulating water that reaches temperatures of 90°C, producing energy that could be used for space heating and air conditioning. However, the proposed 10-kw array will be designed to operate passively without water or forced-air cooling. □

IEEE

Search begins for Schulke replacement

The surprise resignation late last month of Herbert A. Schulke Jr. as executive director and general manager of the Institute of Electrical

and Electronics Engineers has started the organization's leadership on a forced march to find a replacement within the next six months. IEEE president Robert Saunders, professor of electrical engineering at the University of California—Irvine, is now in the process of organizing a search committee, which, he says, will be kept to a minimum size to ensure fast action.

On Feb. 18 and 19, Saunders plans for the executive committee and then the full board of directors to review and approve the search group. The institute might hire also an executive-search consultant.

"I'm not interested in politicizing the search committee," Saunders remarks. "In 1974, the last time there was a committee organized—when Donald Fink was retiring—there was too much attempt to get many voices, and the result was unwieldy. I think nothing is more effective than a small committee."

Duties questioned. The reason Schulke gave for his sudden resignation may cause some rethinking of the general manager's job description, as well as the management structure he directs. Schulke pointed out in his letter of resignation that attending to IEEE professional activities had taken more of his time than anticipated, to the detriment of the institute's technical and publishing activities. Along with the professional activities, of course, have come the politics, contested elections, and other internal struggles that apparently were not to Schulke's liking, nor fully appreciated when he was hired.

"When I looked at what I was doing and what I thought I would be doing, it didn't come close enough for me to deliver the performance required of the job," he explains. "In my case, professional activities didn't permit time for the technical activities I considered so essential. I have to stay close to technology or I'm not happy."

Although under fire a year ago during a staff shake-up and a budgetary crisis accompanied by a dues increase, Schulke appeared to have survived the internal battles

and was still in command for 1977. He leaves on something of a high note, with financial allocations and spending under better controls and the satellite offices in Washington, D.C., and Piscataway, N.J., running more smoothly than before.

"I certainly do feel a sense of satisfaction. The New Jersey service center is equal to that in any technical society. We have gone from a \$1 million deficit in 1974-75 to meeting the target surplus budget in

1976. And we know where we stand for 1977," he says.

On the minus side, he has been criticized for his handling of staff cuts, turmoil in the IEEE standards operations, and general lack of accessibility to members. Others have blamed the last search committee for misjudgment in recommending the former director of communications for the U.S. Joint Chiefs of Staff for the IEEE position in the first place. □

Memories

Half-size 16-k read-only memory may signal start of price break

Now that 32,768-bit read-only memories are becoming available, users should expect the price of 16-k devices to decrease rapidly. What may be the start of the trend is the pair of 16,384-bit entries being readied by General Instrument Corp.'s Microelectronics division, Hicksville, N.Y.

Later this month, the firm will offer samples of its n-channel, metal-oxide-semiconductor devices with maximum access times of 300 nanoseconds [*Electronics*, Jan. 6, p. 25], or at least as quick as the faster 16-k parts coming to market.

But speed is only half the story. The firm is giving the higher performance away for free by pric-

ing the new parts, RO-3-9316C and RO-3-8316C, in the \$8 range for 1,000 pieces, or as low as most suppliers charge for slower ROMs.

Perhaps more important for the rapidly expanding consumer market, where GI is seeing an increasing number of large-quantity ROM purchases, the firm plans even lower pricing. "We intend to get into the \$4 or \$5 range for 10,000 to 100,000 pieces," says Robert McDonald, manager for memory products. He will be relying on a tightened silicon-gate process that almost halves the chip area—under 19,000 square mils (115 by 165 mils)—from the current size of 36,000 mils² (180 by 200 mils) for GI's 9316B with a 450-ns

access time.

Even more significantly, the firm's designers see their process as allowing them to build 32-k ROMs that will be introduced in the second quarter of the year. They also will undercut their competitors in price and size. "We'll be aiming the price of the 32-k ROM, in production, at the current level of 16-k ROMs," McDonald says.

At these prices, GI looks to replace many functions implemented with programmable and erasable programmable ROMs. For instance, many equipment makers using more costly PROMs early in systems development have been sticking with them into small-scale production. Such companies "will no longer be able to justify any production with PROMs because of the even lower cost per bit and fast [4-week] turnaround times we'll be offering," says McDonald.

Whether the firm's bold price move will start a trend for 16-k ROM parts is open to question. Dick Konrad, sales manager at Mostek Corp. in Carrollton, Texas, notes that certain factors, such as fast turnaround time transcend pricing. "The general marketplace for very large quantities—10,000 to 100,000 pieces—of 16-k ROMs seems to be in the \$8 to \$10 range, depending on the speed, number of patterns, and the quantity per pattern type" he says. As business improves, he sees prices firming up from the low figures quoted when the overall market became soft last October.

However, Harry Neil, product marketing manager for ROMs at Electronic Arrays Inc. of Mountain View, Calif., doesn't think GI's large-quantity pricing will be a hard target to hit. "At 100,000 pieces, I don't see why 16-k ROMs can't go for around \$5," says Neil. "If we can get the equally-complex 4-k random-access memory down to the \$3-to-\$4 level in those quantities, I don't see why we can't get the 16-k ROM down to \$5."

32-k ROMs coming. Paralleling GI's planned introduction of a 32-k ROM about the same size as the current B versions in the firm's 16-k ROM

A new ROM design

When General Instrument Corp.'s Microelectronics division in Hicksville, N.Y., enters volume production of its new 16,384-bit read-only memories in late March or early April, it will employ some new design techniques. The new ROMs are organized as 2,048 words by 8 bits, dissipate about 300 milliwatts, and are available in the usual 24-pin dual in-line package. One unit, 8316C, is a pin-for-pin replacement for Intel Corp.'s 8316A ROM (850-ns access time); the other unit, the 9316C, for Intel's 8316E (420 ns). Both are powered by a single +5-volt power supply.

According to GI's manager for memory products, Robert McDonald, the firm is able to shrink cell size about 35% by doing away with the dedicated ground column, usual for every two access columns. Instead, a logic-switching technique is used in which ground terminals are timeshared. The room opened up was used to add split-decoding circuits for the read-only access line, helping to lower the access time. Also, gate lengths were substantially reduced.

We have the low-cost oscilloscopes that aren't expensive



Selection on the basis of price alone often results in high cost of ownership—in many ways. If a low-cost 'scope fails after rough treatment, after a line-voltage surge, or during hot weather, and requires expensive maintenance—cost of ownership rises. Perhaps, to lower the price, the manufacturer oversimplified key circuits, resulting in poorer performance or more maintenance or both—again, cost of ownership rises. If, after a couple of years, reliability decreases and replacement becomes necessary—then again, cost of ownership rises.

Tektronix firmly believes that there's more to consider than just purchase price when you buy a low-cost oscilloscope. Reliability, performance, design excellence, and long life are all necessary considerations. If these qualities are less than optimum, your cost of ownership is increased.

That's why such qualities, and more, are designed into our T900 Series of low-cost oscilloscopes—a T900 is a sound buy, a safe investment. Ask a T900 owner.

Before you buy any low-cost oscilloscope, get the full T900 quality story from your nearest Tektronix Field Engineer. Or write Tektronix, Inc., P.O. Box 500, Beaverton, OR 97077.

For Technical Data circle 46 on Reader Service Card
For Demonstration circle 47 on Reader Service Card

T921—Dc to 15 MHz; single trace, single time base	\$ 695
T922—Dc to 15 MHz; dual trace, single time base	\$ 850
T932—Dc to 35 MHz; dual trace, single time base	\$1195
T935—Dc to 35 MHz; dual trace, single time base with delayed sweep	\$1395
T912—Dc to 10 MHz; storage; dual trace, single time base	\$1300
T922R—Dc to 15 MHz; rackmount, dual trace, single time base	\$1175

U.S. Sales Price F.O.B. Beaverton, Oregon.



TEKTRONIX®

committed to
technical excellence

family, Texas Instruments Inc., of Dallas, and Mostek have announced future availability of 32-k static ROMs. TI will have quantities of its TMS 4732 available late in the first quarter. Mostek's 32000 will be available in samples then, with volume available in the second quarter. TI hasn't disclosed prices for its 32-k chip, but Mostek's Konrad says his firm's unit "will be about 0.9 times the price of two 16-k ROMs, or about \$15." □

Fiber optics

Bell link to give in-service experience

When AT&T's fiber-optic communications system starts operating under the streets of Chicago by midsummer, it will be proving more than just the efficacy of light communications. "What we want is to gain installation experience with fiber-optic systems," explains Ira Jacobs, director of the Wideband Transmission Laboratory at Bell Telephone Laboratories Inc. in Holmdel, N.J. "We want to put cable in the ground, pull it through real ducts and into manholes, and do it under real conditions—rough handling by craftspersons of Illinois Bell and exposure to water, dirt, and freezing temperatures."

Cooperation. The system, to carry voice, data, and video signals, is an undertaking among four Bell System entities: American Telephone & Telegraph Co., Bell Laboratories, Western Electric Co., and Illinois Bell Telephone Co., which will provide the facilities for the tests.

Bell will be relying on equipment it began trying out early last year in a field trial at Western Electric facilities in Atlanta [*Electronics*, July 22, p. 43]. But the tests in Atlanta were not held under actual operating conditions. Light sources will be gallium-aluminum-arsenide injection lasers and infrared light-emitting diodes. Like much of Bell's phone traffic, information in the test system will be digitized except for an

analog voice order line. It will be transmitted at the 44.7-megabit/second rate needed to carry several Picturephone video signals.

"At a 44.7-Mb/s data rate, we can go no more than 3 kilometers with LEDs before inherent material-dispersion loss in the graded-index, germanium-doped silica fibers cuts us off," points out Joe Mullins, who heads Bell Labs' Fiberguide Trunk Development department in Holmdel. "The laser sources will go 6 or 7 kilometers." The solid-state lasers have an average output of 0.5 milliwatt at a 0.82-micrometer wavelength. The simpler and cheaper LEDs are desirable, however, for transmitting over shorter hops. Detectors are silicon avalanche diodes sensitive enough to provide an extra 15 decibels of margin.

Ribbons in cable. A 1/2-inch-diameter cable in Chicago will carry a pair of flat, 12-fiber ribbons—24 of the 100 micrometer-diameter fibers in all, instead of the 144 used in the Atlanta trials. One ribbon will be used for commercial traffic. "The rest will be used for other tests,

including the order wire for maintenance [messages] and some fibers for measuring losses," says Mullins. A single pair of fibers will be able to carry 576 conversations.

Two central offices will be connected over an almost-1-mile link. A second 1/2-mile link will connect one of the offices and an office building. However, no single cable run will be longer than 1,000 feet, and Illinois Bell will gain the needed field experience of installing and splicing the cable through manholes in the field.

Two of the fibers will be used to implement voice trunks; a second pair will carry about 80 subscriber loops, even though its capacity is 1,120. All four will be backed by redundant fibers that will take over if the first sets fail—determined by measuring the system's bit-error rate. The remaining four fibers in the ribbon are dedicated to a pair of two-way Picturephone links. In addition, Bell's Digital Data Service will be tested on one of the links and, according to Jacobs, the black-and-white 4-MHz Picturephone signal will be transmitted at the 44.7 Mb/s rate using a differential pulse-code-modulation encoder recently developed by Bell Lab engineers. □

Careers

EMC adopts tighter demand-data policy

Round one of the dispute over the manpower-demand data compiled and published by the Engineering Manpower Commission, research arm of the 36-society Engineers' Joint Council, goes to the EMC's critics. Responding to growing complaints that the demand projections have encouraged colleges to pump too many engineers into an already overcrowded marketplace, the full commission unanimously adopted last month a policy statement on manpower demand studies.

Essentially the same as the final draft adopted by the EMC's executive committee late last year [*Electronics*, Jan. 6, p. 40], the statement calls for

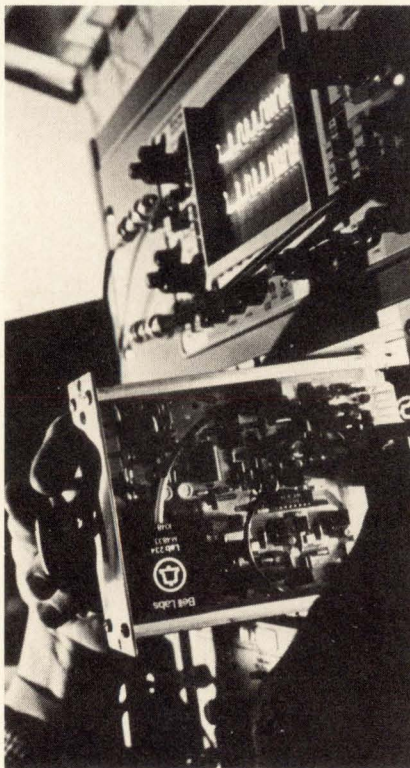

Trial. Receiver module for Bell System's fiber-optic link fits in equipment rack.

BUSS® Fuses

FOR QUALITY-RELIABILITY

For anything you need in protecting electronic circuits and devices —

FUSETRON® dual-element — time-delay fuses

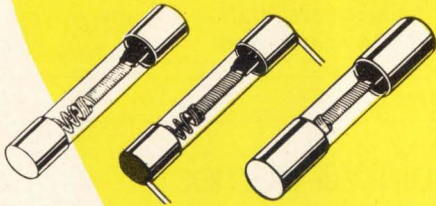

Avoid nuisance opening, yet get full short-circuit protection. Available from 1/100 amp. to 40. Size ¼ x 1¼ in. and 9/32 x 1¼ in.

TRON® rectifier fuses

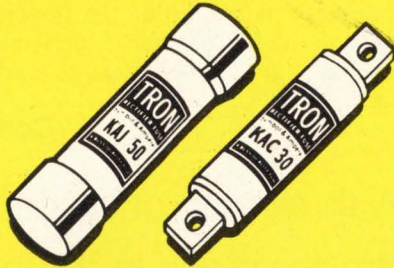

Provide extremely fast opening and high degree of restriction of let-thru current to protect Solid State Devices. Ampere rating ½ to 1000 in voltages up to 1500.

BUSS GLASS TUBE FUSES "quick-acting"

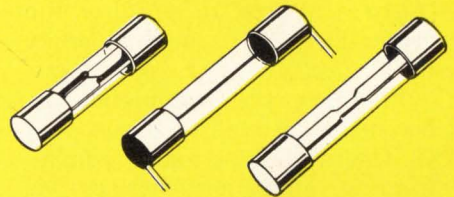

Provide high speed action to protect delicate instruments and apparatus. Available from 1/500 to 30 amp. Size ¼ x 1 in. and ¼ x 1¼ in.

BUSS Signal-Indicating Alarm-Activating FUSES



Available with time-delay or quick-acting characteristics. Available from 1/10 to 30 amp. Size ¼ x 1¼ in. and 13/32 x 1½ in.

BUSS Sub-Miniature GMW fuse



and HWA fuseholder.
Full size .270 x .250 in. with window to check fuse element. Available 1/200 to 5 amp.

BUSS Fuses for TELEPHONE COMMUNICATIONS Similar equipment



Series 70

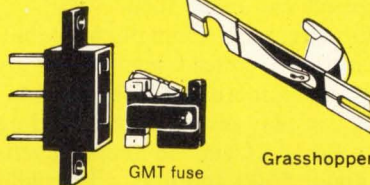

HLT holder

GMT fuse

Grasshopper

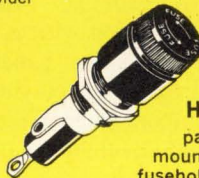

HKA
panel
mounted
fuseholder
for ¼ x 1¼ in.
fuses.

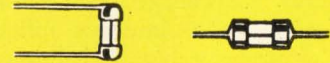

TRON® Sub-Miniature Pigtail Fuses

Size only .145 x .300 in. Glass tube permits visual inspection. Hermetically sealed. Available from 1/200 to 15 amp.

BUSS SNAP-LOCK FUSEHOLDER



Rear panel mount fuseholder for ¼ x 1¼ in. fuses. Snaps into place. Specify HTA-00 for space saver type. HLD-00 to take visual indicating fuses. HKP-00 for standard fuseholder. HJM-00 to take ¼ x 1 in. fuses.

BUSS FUSES and FUSEHOLDERS

to meet military specifications.

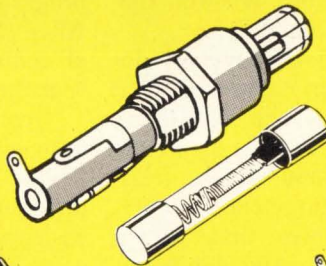

HKA
lamp
indicating,
signal-activating
fuseholder.

BLOCKS FOR BUSS FUSES

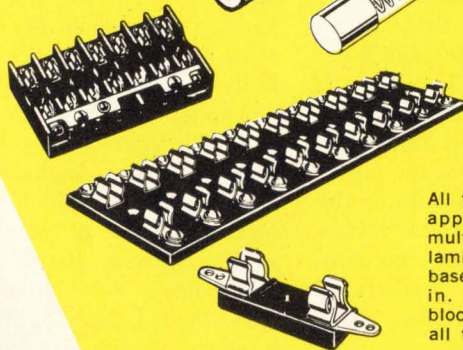

All types available for every application. Single pole, multiple pole, small base, laminated base, porcelain base for fuses from ¼ x ⅝ in. up. Also signal fuse blocks and special blocks of all types.

FOR THE
PROTECTION OF ALL
ELECTRONIC
CIRCUITS

Write for Bulletin SFB
— See for yourself —



BUSSMANN MANUFACTURING
a McGraw-Edison Company Division
St. Louis, Missouri 63107



the commission to downplay the "predictive" nature of its demand studies. The move goes part way—areas like data accuracy and gathering methods are also under fire—toward meeting the chorus of critics who have been demanding that the EMC either change the way it gathers and disseminates demand data [*Electronics*, Sept. 16, p. 75] or altogether abandon its demand projections [*Electronics*, Oct. 14, p. 36].

"I think the commission has become more realistic," says Hans C. Cherney, a personnel administrator at International Business Machines Corp. in Poughkeepsie, N.Y., and vice chairman of the U.S. Activities Board of the Institute of Electrical and Electronics Engineers. Cherney has charged that industry and educational interests influence EMC's forecasts, but he believes the policy statement "certainly is a step in the right direction."

Another view. Robert A. Rivers, president of Aircom Inc. in Union, N.H., and a member of the EMC, has been another strong critic of the demand studies. He thinks it's "a good thing" that the policy statement has been adopted. In his view, "most of EMC's verbiage is aimed at maintaining the educational input and output of engineers." But now, he says, "we've finally got something that will keep them from making all those wild predictions. We won the all-important first round."

Some EMC officials, however, do not think the policy statement will bring any changes. John D. Alden, executive secretary and the man who conducted the demand surveys, feels that the policy statement "simply spells out principles that we've always followed. I really don't see anything new that would alter the way in which we've been gathering or disseminating demand data."

Alden also believes that the policy statement will put no restraint on the predictive nature of the EMC's conclusions because he insists the commission has not made predictions. "You can project ahead, but that's not predicting," he asserts.

The same opinion is held by commission chairman Art Gilmore

of Grumman Aerospace Corp. in Bethpage, N.Y., and its vice chairman, Paul Doigan of the General Electric Co. in Schenectady, N.Y. Gilmore, though, does not believe that the work of its *ad hoc* committee on supply and demand has been for nothing. "We now have a much better understanding of the importance of and problems in deriving demand data, processing it, and

presenting it." He believes that more work is needed in the demand area but will require greater effort and money—"money that is not in our current budget."

Thus, while those seeking a revamping have gained some ground, those who wanted an end to the studies might win by default. The budget doesn't allow for any surveys in the near future. □

Consumer

With microprocessors, pinball games aim for place in the home

Lacking only a coin-slot, the first microprocessor-controlled pinball machines for home use have rolled into the consumer market, joining the popular video games. The machines are as close to the arcade types in looks, feel, sound, and performance as the microprocessor programs can make them.

For example, Fireball, a pinball machine introduced last month by Bally Manufacturing Corp. of Chicago, can play seven songs, including "The Party's Over" to losers. It sells for about \$900 and uses a Fairchild F8 microprocessor set. Bally is already in production with a follow-up machine, called Evel Knievel, reprogrammed for a new playing field. All of the components in Fireball are of commercial machine quality except the switches.

"Arcade pinball machines are designed to make money as well as be fun to play. The home unit is different only in that scoring is easier since people are not putting coins in it," says Jack O'Donnell, Bally field service manager.

Another home pinball machine has just gone into production at Allied Leisure Industries Inc. of Hialeah, Fla., which markets a successful line of consumer video games as well. Based on an MOS Technology 8-bit microprocessor, the Allied Leisure units also have standard arcade-size playing fields (22 inches by 42 in.) and use commercial components. However,

while the Bally Fireball has a standard table and scoring panel, the two Allied Leisure machines are coffee-table height, are played sitting down, and are covered when not in use. "The idea was to make the machine useful as furniture so that it can be put into a room and played only when desired," explains Ian Richter, chief engineer. This machine will sell for about \$900, he adds.

Both the Bally and Allied Leisure games feature programmed diagnostics run by the microprocessors to check out the working parts for user maintenance. When put into the diagnostic mode by a switch in the back, Bally's system first checks the entire playing program to ensure that the control circuit board is operating properly. The six-digit light-emitting-diode score panel is a convenient way of displaying test results to the user. If the panel comes out all zeroes, for instance, the program test is positive. If not, the entire circuit board can easily be replaced.

The second sequence covers all the numbers, lights, and solenoids (the user listens for five thumps to indicate all's well with the solenoids). The third test is for all the switches. If one or more are sticking, an identifying code number appears on the scoring display.

The Allied Leisure system is similar. At the flip of a switch the program sequences first the scoring program, then the switches (where it

Ask CONTROL DATA about the improved Model 9427H "Hawk" OEM Cartridge Disk Drive with double-the-uptime performance.

We have it.

"Hawk:" updated, simplified, field-tested and proven for twice-the-reliability of previous models. 12 MByte standard; 6 and 3 MByte optional. Average access 35 ms. Data rate: 2.50 MHz.

Test "Hawk." Evaluate it for new high-uptime standards of performance and reliability. Compare it with competition. Once you do, you'll use "Hawk" with confidence. And get such key advantages as these:

Versatility

For interface versatility, you can choose CDC or one of several competitive interfaces. Star or daisy chain configuration. The unit in daisy chain configuration is removable without affecting other units.

For control versatility, the control panel module is removable for placement in a remote location.

Ease of Maintenance

"Hawk's" modular design offers individually replaceable sub-assemblies that simplify maintenance, keep downtime down.

An independent blower motor assures continuous standby capability and clean disk area—and improved reliability.

The power supply is self-contained; the input is universal 100-250 VAC, 50/60 Hz.

"Hawk" even offers a Fault Isolation and Retention Module! This optional device provides diagnosis to board level and stores fault information. Even when power is removed!

Whether large OEM, or small, check into "Hawk." For reliability, performance, options. For Cartridge Disk Drives you can sell with confidence in your system.



Call (405) 946-5421 or return coupon to: Terry J. Hardie, Product Sales Manager, Control Data Corporation, 4000 NW 39th Street, Oklahoma City, OK 73112

Please send more information on your Cartridge Disk Drives.

NAME _____ TITLE _____
COMPANY _____ ADDRESS _____
CITY _____ STATE _____ ZIP _____ PHONE _____

Ask the CDC OEM people

GD CONTROL DATA CORPORATION

SCIENCE/SCOPE

Clear, color closeups of the giant planet Saturn, its rings, and its satellite Titan will be transmitted to earth beginning in 1979, when Pioneer 11 is closest to the planet. Regular observations will begin in July 1977. Two instruments aboard the spacecraft were built by Santa Barbara Research Center (SBRC), a Hughes subsidiary. One, an imaging photopolarimeter, will take the pictures; the second, an infrared radiometer, will measure the temperatures of the planet and its rings.

Once the spacecraft has arrived, the temperatures it takes will be telemetered home so that scientists can continue to study the delicate heat balance of the solar system.

As part of the US Navy's standard hardware program, the Hughes-built AN/UYK-30 microprocessor has been designed onto six Standard Electronic Modules (SEMs) in a 20-cubic-inch space. The SEM-2A modules are 1.9 x 5.6 inches. The 16-bit UYK-30 has already been integrated in 11 military-system programs that involve application with the Navy, Army, and Air Force.

Like the existing production version of the UYK on three 5.6 x 6.5 inch modules, this new SEM version will use multisource, off-the-shelf, bipolar Schottky TTL LSI microprocessor chips for a capability of 340-660 thousand operations/sec, using up to 65,000 words of memory. Value of the SEM concept, of course, is a family of off-the-shelf, reliable, electronic modules, each performing certain standard functions. This facilitates the design, production, and support of electronic systems.

Hughes Missile Systems Group has many immediate openings, in Canoga Park, California, for engineers and scientists in new, expanding, long-range R&D. Typical openings include circuits engineers (RF/IF, digital, or analog), systems analysts (missile-system preliminary design), electronic product engineers (product designs for state-of-the-art systems), RF systems engineers (microwave systems design & test), RF product engineers (product designs of state-of-the-art RF components), and many others. Graduation from an accredited university, varying amounts of experience, and US citizenship are all required. Please send resume to: Engineering Employment, Hughes Aircraft Company, Canoga Park, California 91304.

During the recent Big Thompson River disaster in Colorado, lives were saved through use of a heat-sensitive infrared viewer. A police sergeant aboard a US Army helicopter, during a 2-day period, scanned the entire length of the canyon through a Probeye^(R) Infrared Viewer, which identifies heat, rather than light, patterns. The sergeant was able to locate people stranded or clinging to the canyon walls in woods and heavy brush. The scanning operation enabled the rescue teams to avoid searching the canyon by foot.

Electronics review

also identifies which are stuck), then the lamps, and finally the "bonus" procedure, which rewards high scorers with extra turns. Practically all of the breakdowns uncovered by the diagnostics can be repaired by the user, so that maintenance, the biggest headache with the old electromechanical machine, is kept to a minimum. □

Solid state

Laser diode emits at 7,276 angstroms

While progress in semiconductor laser technology tends to be incremental—more efficient material here, a better junction there—from time to time the increments add up to make new applications possible or old ones more attractive. For a case in point, look at the improvements in a new laser at RCA Laboratories, Princeton, N.J. It uses gallium arsenide alloy to operate continuously at room temperature at wave lengths as short as 7,276 angstroms.

That emission frequency is the highest reported to date for a continuous wave laser diode with any material at room temperature. Presently available long-life cw laser diodes generally emit in the spectral

range of 0.8–0.85 micrometer.

Henry Kressel, head of the semiconductor device materials research lab, says the higher frequency could become important in scanning applications because the device's high-intensity beam can be more sharply focused in high-resolution systems. It also provides a better spectral match with the coding inks used in much equipment.

What's more, he notes, photographic materials have increased sensitivity at shorter wavelengths. Higher-frequency emissions can also handle more information in optical communications and provide a better, more accurate beam in laser-guiding systems.

A key feature of the work, supported by the Hampton, Va., Longley Research Center of the National Aeronautics and Space Administration, is that the achievement came not from using exotic material structures, but from optimizing the fabrication process. It involved overcoming or reducing the technological problems connected to the behavior of dopants, the structural quality of layers in the diode, and the stresses caused by lattice mismatch in high-frequency-laser emission.

The devices consist of fairly standard double heterojunction materials ($\text{Al}_x\text{Ga}_{1-x}\text{As}/\text{Al}_y\text{Ga}_{1-y}\text{As}$) enriched in

News briefs

Rockwell unveils new microcomputers

Rockwell International's Microelectronics Device division is bringing out two single-chip microcomputers for immediate delivery. They join its first such device, the MM77, introduced in March 1976. The new MM76 has 640 8-bit words of read-only memory and 48 4-bit words of random-access memory; the MM78 offers 2,048 8-bit words of ROM and 128 4-bit words of RAM. Three new versions of the MM76 are scheduled for production later in the year, with an optional counter, 12-bit converter, and expanded ROM. What's more, an economy device, the MM75, is also being readied. It will reduce input/output lines from 31 to 22. Volume prices are \$5 for the MM76, \$9 for the MM77, and less than \$3.50 for the MM75.

First airborne data terminal delivered by Hughes

Hughes Aircraft Co. has delivered for performance testing to the Boeing Co. the initial time-division multiple-access terminal for the Air Force's E-3A airborne warning and control system aircraft. Designated AN/ARC-181, the terminal will provide continuous real-time information exchange over a single network on a time-ordered basis, resulting in a data pool that is constantly updated and available to all members.

The Hughes family of industrial electronic products ...from Carlsbad, California



IMAGE AND DISPLAY PRODUCTS

Direct view storage tubes, cathode ray tubes, scan converter tubes, image memories, interactive graphics display terminals, Probeye® infrared viewers.



PRODUCTION EQUIPMENT

Microcircuit welders, bonders and soldering systems; automatic wire terminating machines, NC positioning tables and computer controlled microcircuit bonders.

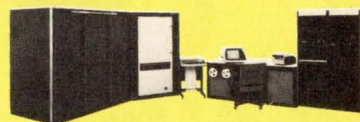

AUTOMATIC TEST EQUIPMENT

FACT® Flexible Automatic Circuit Tester for high speed continuity and leakage testing of complex wired assemblies. Computer controlled digital logic test systems.



INDUSTRIAL AUTOMATION

Lasercutting systems for automated pattern cutting of fabric, paper, wood, metal and advanced composites. Computerized pattern graphics systems and NC.



LASER PRODUCTS

He-Ne laser plasma tubes, power supplies, optics and subsystems for industrial, OEM and laboratory applications. Also CO₂ and custom gas lasers.

For information, write: Hughes Industrial Products Division, 6155 El Camino Real, Carlsbad, CA 92008. (714) 438-9191.

HUGHES

HUGHES AIRCRAFT COMPANY

Industrial Products Division

FORGET EVERYTHING YOU EVER KNEW ABOUT IMAGE PROCESSING & DISPLAY

"You want to process electronic information.
You need an image display.
You're thinking of using digital scan converters,
direct view storage displays,
or computer memories . . ."
"Don't."

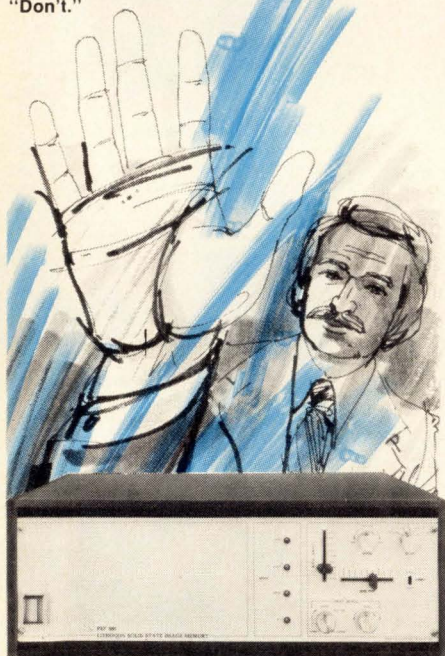

A revolutionary new instrument will help you solve virtually all of the problems associated with processing electronic information for image displays. From ultrasound scanners. Computers. Nuclear gamma cameras. Telephone lines. X-ray sources. Or outer space.

The **PEP 500** Lithocon® Solid State Image Memory/Scan Converter

Pull it out of the carton. Plug it in. Knock it around. Heat it. This is a field-tested workhorse. Not a laboratory device.

It's the first beam-addressed, solid-state image memory and scan converter that has been designed for industrial and commercial use. In the field. Under extreme operating environments. In tropical heat. In sub-zero temperatures. Anywhere. Everywhere. A new dimension in electronic imaging. It's a revolution.

Call: 201-297-4448.

 **PRINCETON ELECTRONIC PRODUCTS, Inc.**
Box 101, North Brunswick, New Jersey 08902

Electronics review

aluminum content to reach emissions below $0.8 \mu\text{M}$. Zinc is used instead of germanium for p-type doping. Telluride was used as the n-type doping in preference to the more conventional tin, which could not be incorporated in sufficient concentrations for the desired high-frequency emissions.

The RCA work improves several aspects of this aluminum-rich process. For one thing, an accelerated growth rate is employed with very careful control of timing during the process. Moreover, gross structural defects could be eliminated by maintaining low optical levels in the furnace and by carefully cleaning the substrate. □

Communications

SBS approval limits IBM's role

The threat of a Federal court appeal still lingers, but it looks like the Federal Communications Commission's approval of Satellite Business Systems' plan for the nation's first 12-14-gigahertz all-digital domestic satellite communications system will stand. The key elements to the lengthy FCC ruling, still being written, are the limitations placed on relations between SBS, its three corporate partners, and their parent companies, particularly International Business Machines Corp. Parents with IBM are Comsat General Corp. and Aetna Casualty & Surety Co.

The commission ruling stressed that SBS could not have a "bundled" or "packaged" offering of communications and data processing services. IBM will not be permitted to sell, promote, offer discounts or other preferences to its customers for SBS services. Conversely, SBS will not be able to sell or promote IBM equipment or services.

For interconnections, the commission will require SBS technical specifications be available to all equipment makers and users, limit its ability to dictate specs, and require any contracts between the joint

venture and its parents be submitted to the commission for prior review.

Anticompetitive and antitrust issues were raised against the SBS proposal by its 12 opponents—a list that includes virtually all U.S. carriers, including AT&T and the Justice Department. But the FCC concluded that "public interest benefits outweigh potential anticompetitive concerns, and the proposal viewed as a whole serves the public interest—particularly in view of the conditions imposed."

Moreover, the FCC said it "will scrutinize this market and SBS on a continuous basis," and take further action as appropriate. Opponents of SBS have not yet indicated whether they will appeal the commission's decision in the courts.

Plan. Although SBS rates remain to be determined on the basis of experience, the two-phase operating plan calls for a six-month program to evaluate equipment performance using IBM earth stations at Poughkeepsie, N.Y., and Los Gatos, Calif., with a rented 4-6-GHz transponder from a domestic satellite.

In a second phase, the same two earth stations plus five others will provide private-line communications to IBM and others on a common-carrier basis. The five new stations will be chosen from IBM locations at Gaithersburg, Md., Manassas, Va., Boca Raton, Fla., Atlanta, Ga., Lexington, Ky., Greencastle, Ind., Rochester, Minn., Austin, Tex., and Boulder, Colo.

The operational system will use two satellites in stationary orbit, a ground spare, and several hundred small earth stations with 5-7-meter-diameter antennas. Tracking and telemetry command centers will be in New Jersey and California.

SBS will be funded at \$165 million—\$55 million from each partner—for the period between FCC approval and the beginning of operations. The firm puts the system's costs from the January 1971 beginning by its predecessor—CMB Satellite Corp.—to the start of commercial operations at \$235.5 million and outlays through 1986 at \$406.9 million. □

PLASTICS BETTER THAN HERMETICS?

See for yourself.

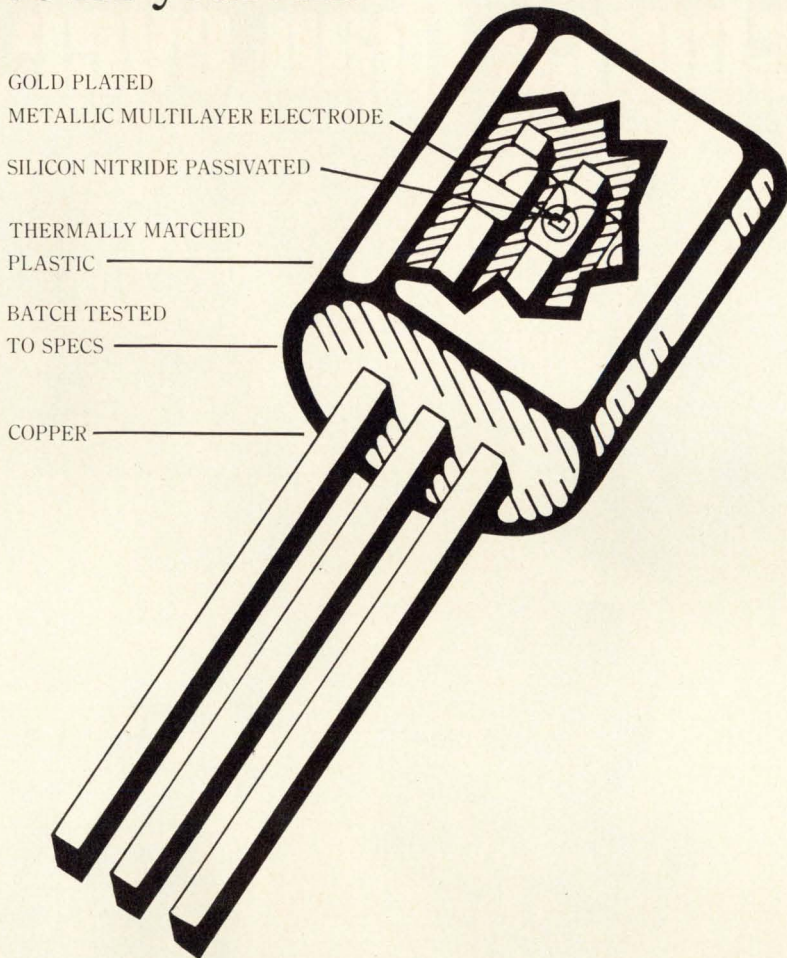

- GOLD PLATED METALLIC MULTILAYER ELECTRODE
- SILICON NITRIDE PASSIVATED
- THERMALLY MATCHED PLASTIC
- BATCH TESTED TO SPECS
- COPPER

- High Reliability TO-92 Transistor (Pc MAX.=300 mW)
- TO-18 Metal Case Transistor (Pc MAX.=300 mW)
- X- Conventional Mold Transistor (Pc MAX.=250 mW)

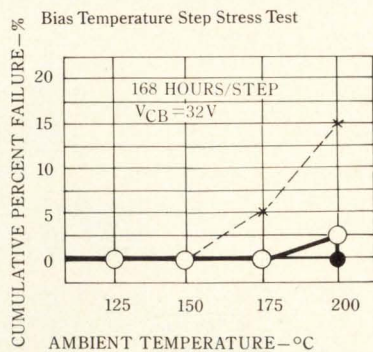
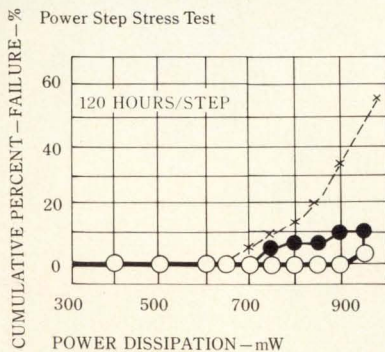

“Standard practice” can now change for the better—and cheaper. Up to now, industrial transistors have been specified in cans, to get reliability under heat and humidity. Consumer products have been able to tolerate the less expensive but less stable plastics. Now NEC has incorporated 5 technical advances that make these TO-92 plastics the equal of any hermetic metal case for most applications—and you get the lower price to boot!

1. GOLD-PLATED, MULTILAYER METALLIZATION. Because gold is electrically noncorrosive and inert to acids and alkalis. And moisture resistance and bonding strength are greatly improved over aluminum construction.
2. SILICON NITRIDE PASSIVATION. Increases moisture resistance, while protecting against unreliability due to impurities. And, the operating characteristics improve, such as higher dc amplification factor and better noise figure.
3. A UNIQUE PLASTIC MATERIAL. Developed especially to match thermally the lead wires and other component parts. This minimizes or eliminates internal stress on the bonding wires.
4. COPPER LEAD WIRE. Thermally matched to the plastic, copper also resists corrosion. A significant bonus is the much greater power dissipation stemming from copper's high heat conductivity.
5. RIGID QC. Every production batch is thoroughly tested, and quality certification tests of the production process are run monthly. This stringent, continuous monitoring insures the best quality in the world, bar none.

THEY ADD UP TO SUPER SPECS. The two charts shown are only a sampling—NEC's 8-page brochure of TO-92 specifications is the real convincer. Write or call for your copy if you're seriously interested—our line of small-signal transistors for telecommunications, instrumentation, etc. is so broad we can provide almost any device you may require in TO-92. And if you're into hybrids, ask for data on our MINI MOLD transistors—plastics uniquely configured for reliability with big savings in assembly time and cost.

NEC America, Inc., Electron Devices Division, 3070 Lawrence Expressway, Santa Clara, CA 95051. Tel: (408) 738-2180. TLX: 35-7475.

NEC
NEC America, Inc.

Now! Fujitsu pc board relays in a wider choice than ever.

The Fujitsu BR-series relay lineup of general-purpose devices for printed circuit board applications is now wider than ever for greater coverage in meeting your demanding on-board mounting applications. Yes, the Fujitsu BR-series miniature and ultra-miniature relays, so well known throughout the industry for unbeatable performance and size and for their outstanding design that makes for flow-soldering-safe mounting, now give you even greater coverage to meet your full range of applications in vending machines, control equipment, business machines, communications gear, entertainment products, and a wide range of other applications. Take the smallest members of the BR-series lineup—the ultra-miniature BR211 (1 form C) and BR221 (2 form C) relays. You get a choice of two pin configurations, two load classes (including low-level), and a wide range of coil voltage ratings to meet almost any switching application up to one amp load. And if you need a model to handle loads up to 3 amps, you've still got a wide selection available in our other models. So when it comes to picking a performance relay, come to the maker with the solid performance, compact, and ultra-reliable products. Come to Fujitsu. Our BR-series miniature and ultra-miniature relays are available right now in volume quantities at prices that can't be beat. Call or write now for additional information and our new catalog detailing the full Fujitsu relay lineup. You'll be glad you did.

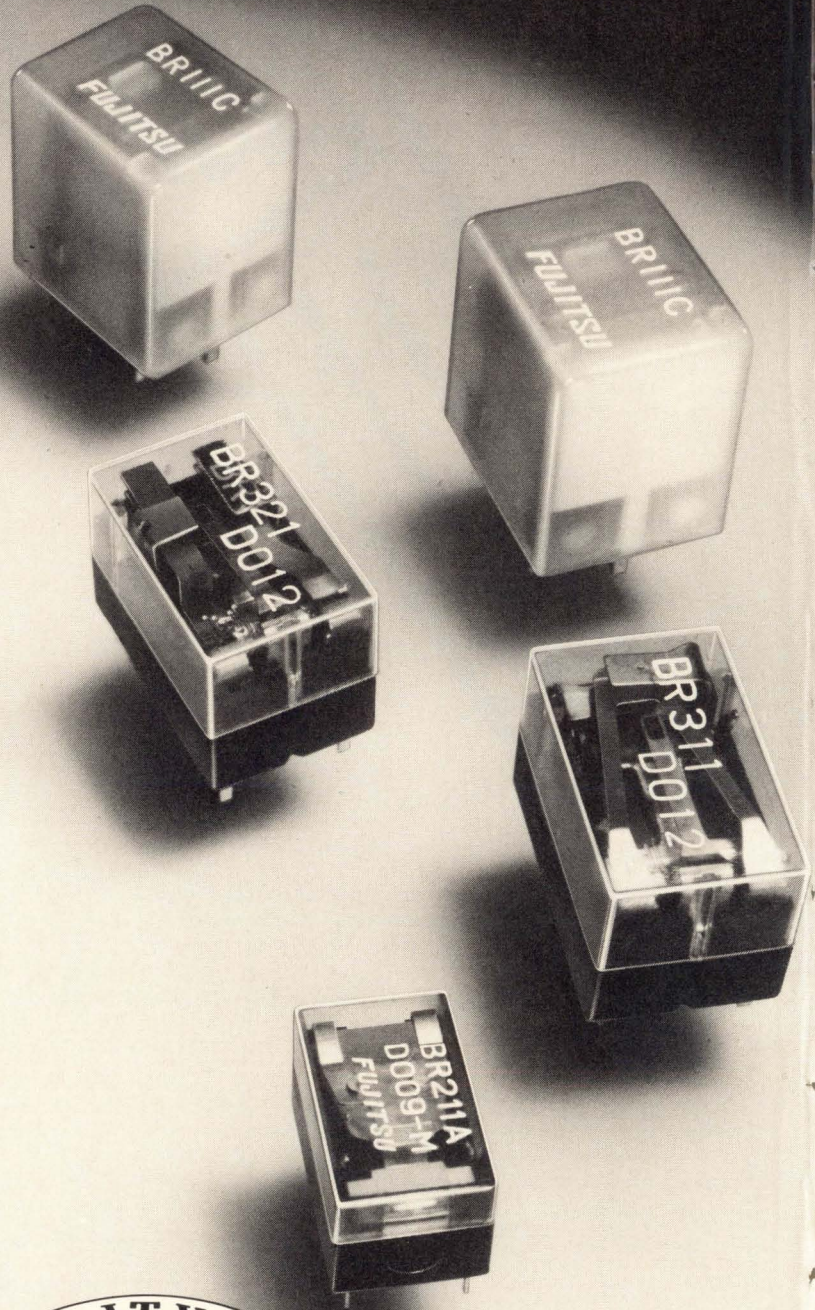

Model	Contact Arrangement	Contact Rating	Coil Voltage
BR111	1 Form C	3A 24V DC or 100V AC	5/6/9/12/ 24V DC
BR211	1 Form C	1A 24V DC or 0.5A 100V AC	1.5/3/5/6/9/ 12/24V DC
BR221	2 Form C	1A 24V DC or 0.5A 100V AC	1.5/3/5/6/9/ 12/24V DC
BR311	1 Form C	3A 24V DC or 3A 100V AC	5/6/12/ 24V DC
BR321	2 Form C	3A 24V DC or 3A 100V AC	5/6/12/ 24V DC



FUJITSU LIMITED

Communications and Electronics
Tokyo, Japan

For further information please contact:

■Components Group (Head Office): Syuwa Onarimon Bldg., 1-1, Shinbashi 6-chome, Minato-ku, Tokyo 105, Japan Phone: 03-437-2111 Cable: FUJITSULIMITED TOKYO
Telex: 2424511 FT SIN J ■Fujitsu America, Inc., Los Angeles Office: 1251 West Redondo Beach Blvd., Suite 304, Gardena, Calif. 90247, U.S.A. Phone: 213-538-3397 ■London
Office: Norman House, 105/109 Strand, London W.C. 2, England Phone: 240-0461/0462 Telex: 51 22305

Circle 56 on reader service card

Washington newsletter

Wage council hits plan to curb TV imports

Color-TV prices will go up and American consumers will be the losers if the International Trade Commission supports the position of domestic manufacturers and imposes a quota or increases tariffs on receiver imports, says the White House Council on Wage and Price Stability. **The council challenged the position taken by U.S. color-set producers** and 11 of their unions before the commission that they will be wiped out by imports unless limits are imposed [*Electronics*, Jan. 20, p. 49].

To illustrate its point, the council claimed an annual quota of 1.3 million imported receivers, based on the 1971 to 1975 level, would boost the price of "a typical color set" by \$43 to \$323, forcing consumers to pay \$317 million more per year. While \$211 million of this would go to the industry, "the remaining \$106 million would be lost to the American economy" because of reduced import activity. Alternatively, either a 10% boost in tariffs on top of the present 5% or a tariff-quota combination of 10% on imports above the 1.3-million-set level would hike set prices by \$28. Consumers would then pay \$221 million more a year, of which industry would get \$132 million and the Government \$36 million.

Raising tariffs or invoking quotas to raise domestic jobs by 4,150 to 31,900 would cost an annual \$70,000 per job, the council noted. Instead it urged the commission "to consider adjustment assistance to workers to find other employment as a less costly method."

NATO commonality behind Brown's cuts

There is more than a desire for short-term savings behind Defense Secretary Harold Brown's proposal to cut the Air Force's fiscal 1978 purchase of Boeing's E-3A airborne warning and control system (AWACS) from six planes to four, his supporters contend. "He is very strong on NATO systems standardization and cost-sharing," says one, "as well as upgrading our own AWACS fleet." Thus, **Brown will push harder for NATO purchases of a new version of the system**, upgraded with automatic initiation of tracking of low-flying aircraft, increased tracking capacity, and an electronic support capability. The U.S. R&D budget for this NATO version is \$15.7 million.

Once developed, the Air Force and NATO versions would become standard. Of the nearly \$529 million sought for six more of these planes, \$411 million is for procurement, some 10% less than this year's price for six planes, while RDT&E costs of \$117.6 million are 12.4% more.

White House OTP loses funds to Commerce, may fold

The White House Office of Telecommunications Policy is not going out of business—yet. Nevertheless, the outlook is not good. The fiscal 1978 budget submitted by Gerald Ford to Congress **cuts proposed OTP outlays by 64%** from this fiscal year to \$2.94 million. Most of the lost money turns up in the Commerce Department's Office of Telecommunications, whose fiscal 1978 funding request of \$6.93 million is 350% more than 1977's.

Officials at OTP contend that the shift represents nothing more than an accounting change that gives the Commerce office the responsibility for spectrum-management functions that OTP had been paying it to perform anyway. But a number of OTP staff members are looking for jobs.

One way to salvage OTP would be to merge it into the rejuvenated White House science adviser's shop now known as the Office of Science and Technology Policy. There, the budget is up nearly 40% to \$3.2 million. But most friends of OTP fear the telecommunications policy functions would lose too much visibility to remain effective if that occurs.

Washington commentary

Harold Brown's planned program changes

President Jimmy Carter's Secretary of Defense, Harold Brown, clearly agrees with the final watchwords of Donald Rumsfeld, his predecessor, to the Congress. "In strength there is freedom," Rumsfeld said in concluding his final annual report on America's defense posture. Near the end of January, Brown modified those words only slightly in his first official appearance before Congress as Pentagon chief. "The hallmark of our enterprise must be strength *and* flexibility," he observed.

Brown still has some weeks before detailing to Congress how the Carter Administration proposes to achieve that flexibility through amendments to Gerald Ford's last defense budget (see p. 77). In fact, he has already indicated that Carter wants more time—a month or two—beyond the February deadline for a production decision on the Rockwell B-1 bomber.

However, the new Pentagon chief is expected to recommend killing the Navy's request for a new strike cruiser in view of Carter's desire to develop a navy made of larger numbers of smaller, faster ships. Terminating that program would cut more than \$203 million from the Ford budget request. That cut is almost a certainty, even though it would remove one platform for RCA's Aegis missile for fleet air defense, leaving it for deployment on the DDG-47 class destroyers.

An M-X slowdown?

More distressing to military professionals, however, is the prospect of a major cutback in the \$294.4 million sought for beginning full-scale development of the M-X strategic intercontinental ballistic missile as a follow-on to the Air Force Minuteman series. Gen. George S. Brown, chairman of the Joint Chiefs of Staff, appeared before Congress with the new Secretary of Defense and made a point of defending the M-X as "the most significant strategic initiative being proposed" in view of its "improved guidance and increased numbers of highly accurate MIRV warheads, together with a mobile, highly survivable basing mode." Nevertheless, secretary Brown is considering a call for reducing the fiscal 1978 level of effort unless the Air Force can rejustify its need for—and ability to spend—\$294.4 million in a single year. The new DOD boss believes that nothing will be lost if the M-X effort is limited for another year to continued work on the guidance and warhead subsystems.

Large carryovers of unspent funds from one fiscal year to another throughout the military command chain troubles Harold Brown, just as

it has troubled large numbers of congressmen and senators, who have long lamented that they lose track of DOD's unspent funds from prior years. Brown calls it an "inefficiency" that he intends to correct. Those carryovers, whether intended or not, limit DOD's flexibility, Brown believes. Best remembered as one of Defense Secretary Robert McNamara's "whiz kids" during the Kennedy and Johnson Administrations of the 1960s, Brown knows how the Pentagon works from his prior experience as Secretary of the Air Force and as Director of Defense Research and Engineering.

How will Brown achieve results? Clearly, he faces strong opposition from the military chiefs who favor long-term funding programs and shudder at the prospect of zero-base budgeting, which requires justification of existing as well as new spending programs each fiscal year. Whether Brown fully adopts this budgeting technique within the Pentagon, the concept is getting strong support throughout the Carter Administration, and lines of bureaucrats and industry reps are already forming for the Feb. 25 Washington seminar on the subject by its originator, Peter A. Phyr, and other experts in the field.

The rush to zero-base budgeting

Now financial vice president of Alpha Wire Corp., Phyr developed zero-base budgeting while at Texas Instruments Inc. and served as a special consultant to Georgia's then-Governor Jimmy Carter. "I can't afford to miss this," said one military electronics contractor's man. "It's got to be a bargain at \$15," he said of the registration fee to be charged by the sponsoring Association of Government Accountants. The seminar is expected to pack George Washington University's Lisner Auditorium, one of the larger meeting halls in the Capital.

An investment of one day and \$15 will hardly make anyone an expert in the technique, particularly someone lacking a background in accounting. Certainly it is going to provide little, if any, insight into how President Carter is going to direct his new Secretary of Defense to amend Gerald Ford's budget proposals. But, as one middle-management budget planner in the Pentagon expressed it, "we need all the help we can get."

In view of Harold Brown's proposals—coupled with the fact that he is the first Secretary of Defense with professional training in science and high technology—many military bureaucrats are going to need help keeping up with their new leaders.

Ray Connolly

NEED

low-pass passive devices that perform as well as active filters but don't cost nearly as much? Investigate Sprague Series JW33 Audio Filters . . . you'll be pleasantly surprised at all they can do for you . . . at a price you can afford.

AUDIO

filters in this new series utilize stock parts, permitting quick and precise construction to your requirements . . . your choice of attenuation characteristics (Chebyshev or Cauer), your choice of cut-off frequency (1 to 50 kHz), and your choice of operating impedance (250 Ω to 10 K Ω).

FILTERS

shown here are metal-encased to reduce pickup or cross-talk, hermetically-sealed to ensure dependable operation at environmental extremes, and solidly constructed to resist physical damage. Standardized pin terminal spacing and low profile (.500" height) make them ideal for PC boards.



FAST?

Because Series JW33 Filters are pre-engineered and can be quickly customized to match the needs of your equipment, all orders are efficiently processed for fast shipment. Whether you want a few pieces for prototype use or a large run for production purposes, you can count on rapid delivery.

*For complete information, write or call
Harris Johnson, Sprague Electric Company,
P.O. Box 39, Annapolis Junction, Md. 20701.
Telephone 301/792-7657*

. . . and you thought we only make great capacitors.



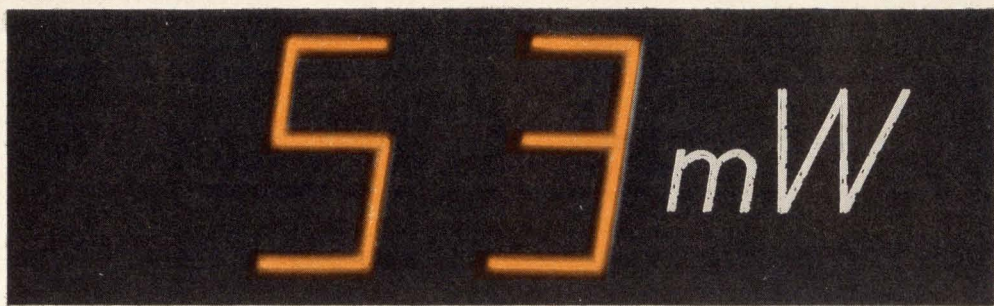

PLANAR GAS DISCHARGE DISPLAY →

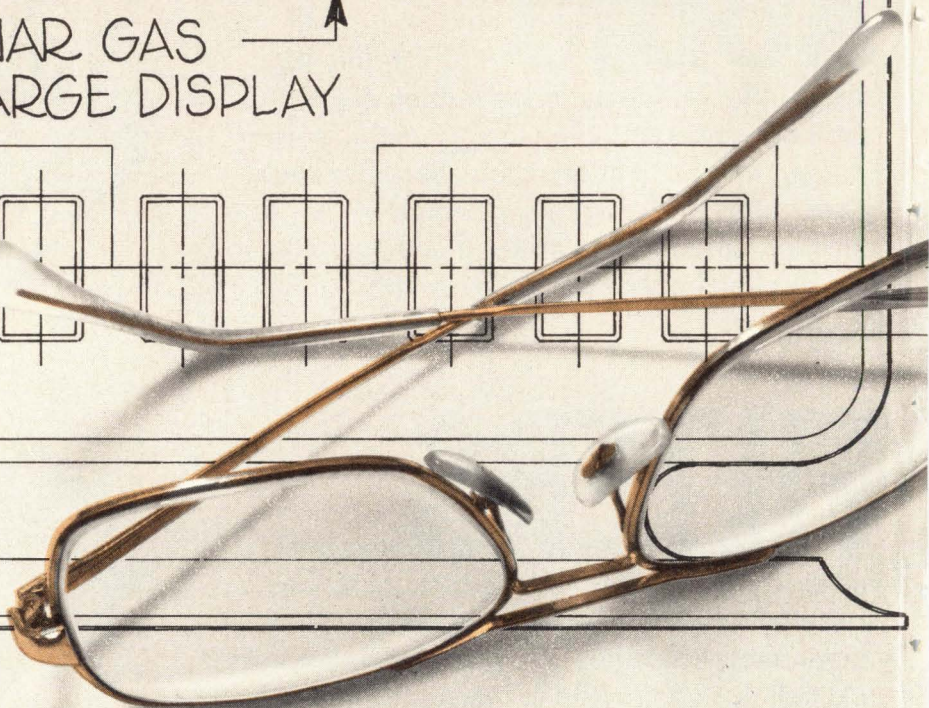
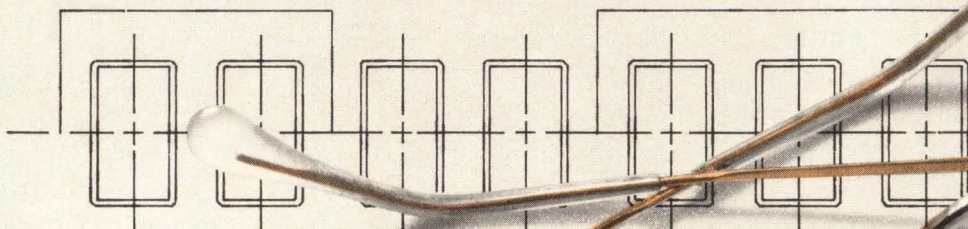

LED DISPLAY ↘

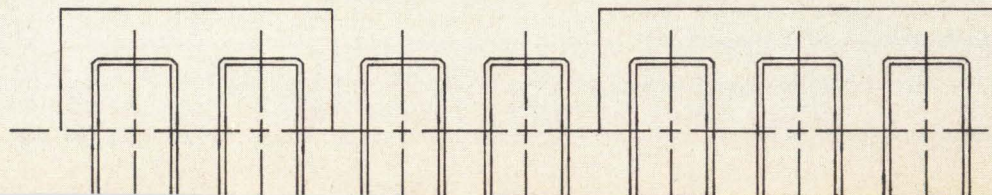

You can see the difference

...in the brighter, more readable Beckman PGD displays. But, what about the other advantages...the non-visible benefits that shine just as bright...like:

- Lower power consumption.
- Lower-cost designs.
- Smaller (less expensive) power supplies.

You may want to look a little further. *For example:*

PGD uses less power than LEDs

LEDs consume more power than PGD displays of similar character size. That's fact. Look at the power-consumption comparison chart that follows. Among others, it compares the Beckman SP-350 display with the efficient Litronix 747. Both were essentially half-inch displays. Both were measured at factory-recommended, typical current levels.

In this case, specified voltage drop across the LED is 3.4 volts. When it's driven from 5 volts, total power consumption for the LED and driver is 100 mW per segment. That's 700mW for a complete figure "8". Conversely, total per-segment power consumption for the SP-350 is 53 mW; or, 371 mW for a figure "8"...about one-half that of the LED.

And, that's only part of the story. Check the chart and compare the resulting, readable brightness figures for three different

sizes of Beckman PGD displays with those of comparable LEDs.

As you know, for equal power consumption, high voltage means low current. More importantly, high voltage is easy and inexpensive to handle with Beckman adjustable, UL-recognized converters, and DD-700 Decoder/Drivers. As a result, you can save money on your designs; and, use smaller, less expensive power supplies, too.

PGD and RFI

Beckman PGD displays are being used in many aircraft applications — with no RFI shielding. The Pulsed-DC Technique makes it possible to dim from Sunlight Brightness to easy-on-the-eyes night viewing without annoying buzz. They're used also in a full line of automotive aftermarket products — speedometers, tachs, fuel-flow meters, rally clocks. And, they're used in other consumer products, like clock-radios,

as well as in sophisticated counters and scientific instruments — with no fear of RFI from the display itself, when DC-driven.

PGD is reliable

No other display manufacturer offers a warranty that is equivalent to that of Beckman's Information Displays Operations.

In fact, Beckman is so confident of the reliability of its display products that, almost two years ago, we invented "Warranty Plus".

Simply stated, Warranty Plus means that Beckman warrants its raised cathode display for the period the customer warrants its product in which the display is employed. We're with you all the way!

How do we do that? With great care.

Every Beckman display undergoes 100% burn-in before it goes to market. As a result, infant mortalities are eliminated; and, so are all visually unacceptable products.

PGD is MOS-compatible

Hook up any Beckman raised-cathode display to one of the off-the-shelf AMI, EA, or National MOS chips — for example, the 40-pin, S1998 and, watch it operate without any components between it and the MOS part.

PGD is most things to most engineers

Superior technology. Human-engineered. Letter-perfect numbers. Vibrant color. Modular. Plug-in. Raised-cathode construction. Optimum visibility.

A designer's joy!

PGD is bright

The bottom line. Superior readability, any way you look at it. An even glow, segment-to-segment...digit-to-digit. And, brightness uniformity from unit-to-unit.

Clarity and visibility of Beckman PGD displays provide The Visible Edge. That's what makes the difference between a winner and a washout; and, that's just what other displays do — in competing environments.

For discussion of features important to you, request Beckman application notes on: "Display Power Supply Requirements" and "DC Clock Application"; the data sheet on DD-700 Decoder/Drivers; or, the Short Form Catalog. Write: Beckman Information Displays Operations, P.O. Box 3579, Scottsdale, AZ 85257. Phone (602) 947-8371.

Spec-for-spec, eyeball-to-eyeball, Beckman Planar Gas Discharge displays are better. And, brighter.

As anyone can see.

LED vs. PGD Power Comparison

	Litronix 747	IEE 1720	Monsanto MAN6610	HP 5082*	SP-101	SP-350	SP-330
Size	.6"	1.0"	.5"	.43"	1.0"	.55"	.33"
Segment Current	20mA	20mA	20mA	20mA	700 μ A	330 μ A TYP	180 μ A TYP
Forward Voltage Drop	3.4V	3.3V	2.0V	2.1V	135V	135V	135V
Power Per Digit (+DP) (Display Only)	510mW	495mW	320mW	336mW	690mW	330mW	190mW
Power Per Digit (+DP) (Display and Driver)	700mW	800mW	800mW	800mW	820mW	371mW	225mW
Brightness in F.L. Approx. Measured Value	35 F.L.	14.4 F.L.	65 F.L.	130 F.L.	225 F.L.	208 F.L.	208 F.L.

*NOTE: Operating Temperature Range at This Brightness is only +50°C

BECKMAN®

INFORMATION DISPLAYS OPERATIONS

For product catalog, circle 60
For application notes, circle 61

We got the order a few hours ago. The relays will be there a few hours from now.

Our customers think we're 'bout the fastest there is when it comes to shipping relays. This order was extra hot so we got it out in a matter of hours. But we frequently ship orders in 24 hours. And, we can generally promise production and shipment of any order is 360 hours (3 weeks).

We're fast—but we're also something else—good. We make our own switches so we know what our relays will do. But just to make sure,

we run over 3 billion test cycles every day! We make over 6000 variations of dry reed relays so we undoubtedly have what you need. And the cost? Well, you better call and get a quote to believe it! Here in Wabash, money goes a lot further than it does in the big city. We know because we get to the city every so often—though not as frequently or as fast as our relays do.



The Econo-Miser. The most automatically manufactured dry reed relay available. 1 and 2 pole standard types. Less than one dollar in quantity.

Coils, Relays & Transformers
wabash
of
Wabash, Indiana
and Huntington, Indiana; Farmington, Missouri;
Tipton, Iowa and South Boston, Virginia
For information and quotes write or call:
Wabash, Inc., Dept. RB-8, 810 N. Cass St., Wabash, Ind. 46992 Tel: 219/563-2191 TWX 810-290-2722
Circle 62 on reader service card

Europeans ponder their future in semiconductors . . .

Prodded mainly by West Germany and the Common Market Commission, European semiconductor makers and the governments behind them figure to step up their efforts to put together strategies to hack down the overwhelming share of European integrated-circuit markets taken by U.S. producers and ward off the threat of Japanese inroads. The stimulus has come from a study of the European semiconductor industry by the British firm Mackintosh Consultants at the behest of the West German government, with support from France, the United Kingdom, the Netherlands, and the commission. The study's conclusions are still secret, but after late-January briefings in Bonn and Brussels, some information has come out.

The UK has just announced its own modest program for spurring components development, and France also has one painfully taking shape. But commission officials hope they can find enough common ground among governments and industry to start drafting proposals for an aid program that will bolster the community's technology arsenal in computers and building blocks for them. **The commission wants its nine member governments to set up a fund of roughly \$120 million to subsidize cross-frontier R&D from 1978 through 1981.** Most of the money would go for peripherals and software development, but some \$13 million would be earmarked for key components like big memory circuits and microprocessors. The fund would add up to about 10% of the amount spent on strictly national programs during the four-year period.

. . . and British to boost components industry with \$34 million

The British government has set aside about \$34 million to help components companies improve their efficiency and competitiveness. The three-pronged plan offers partial support for new-product development, restructuring a company or a group of companies, and buying associated capital equipment needed for either. **For projects costing more than \$85,000, selected applicants, which need not be British-owned companies based in the United Kingdom, may receive support ranging from 15% to 50% of costs,** depending on the category. More money may be made available.

Motorola bucks trend in acquiring Italian subsidiary

Though other companies are backing off from investments in Italy, Motorola spa in Milan has bought the outstanding 38% of the shares to take complete control of the consumer-electronics firm Autovox spa. Motorola even plans to develop new product lines and won't necessarily restrict them to the consumer sector, says Levy Katzir, Motorola's vice president in charge of Autovox operations in Rome. The company's annual sales are estimated at \$34 million, mainly in Western Europe.

Motorola was persuaded to increase its investment because of **help from government officials, especially in overcoming financial obstacles, a reversal in labor-union views toward competitiveness of products, and the dedication of talented Italian workers.** The company was also encouraged by the recent fall in the lira's exchange value, which effectively lowers Italian production costs in relation to those of international competitors. Moreover, many of the components are available in Italy for manufacturing Autovox product lines—car radios and cassette recorders, as well as color and monochrome television sets.

If you're designing equipment that requires a numeric or alphanumeric printer here's an opportunity to upgrade capabilities, increase reliability, and maybe even cut costs, too.

"Spanning Hammers" Reduce Parts, Raise Reliability
Our innovative microprinters have only about one third the number of parts you'll find in conventional single hammer per column printers. Ours are simpler, so they're more reliable. Each spanning hammer forms the characters for three columns, therefore, only five hammers are required to print all fifteen columns.

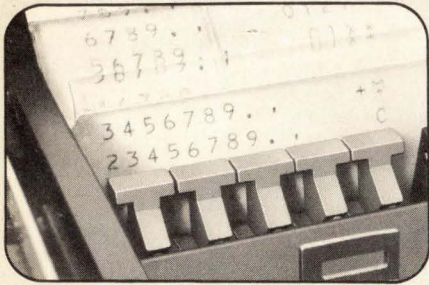

Full 54 Character Printing In All Columns Our special bar matrix character formation permits printing of A-Z, 0-9, and eighteen symbols in all columns at speeds at up to 90 lines/minute.

More Good News Users of your equipment will like our easy-handling snap-in ribbon cartridges, the economy of printing on inexpensive plain paper, and the flexibility of being able to make multiple impressions when the need arises. In addition, there are also optional ticket and ticket/tape mechanisms available.

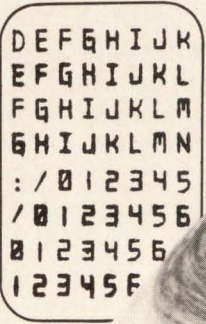
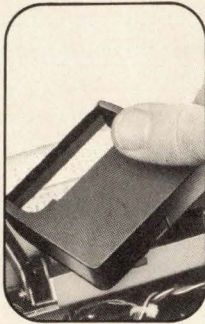

And you'll like the fact that our printers are made right here in the U.S.A. So your design and engineering people can have easy access to our design and engineering people.

Let's Exchange Print-Outs
Send us a sample of your present printout and we'll send you a copy of ours. Plus, we'll send you full details on our series PR 1500 printer. Sheldon-Sodeco, 4 Westchester Plaza, Elmsford, N.Y. 10523; Phone (914) 592-4400. *in 100's

SHELDON-SODECO
A COMPANY OF

LANDIS & GYR

**NOW... A FULL
ALPHANUMERIC,
15-COLUMN
IMPACT PRINTER...
FOR LESS
THAN
\$110.00***

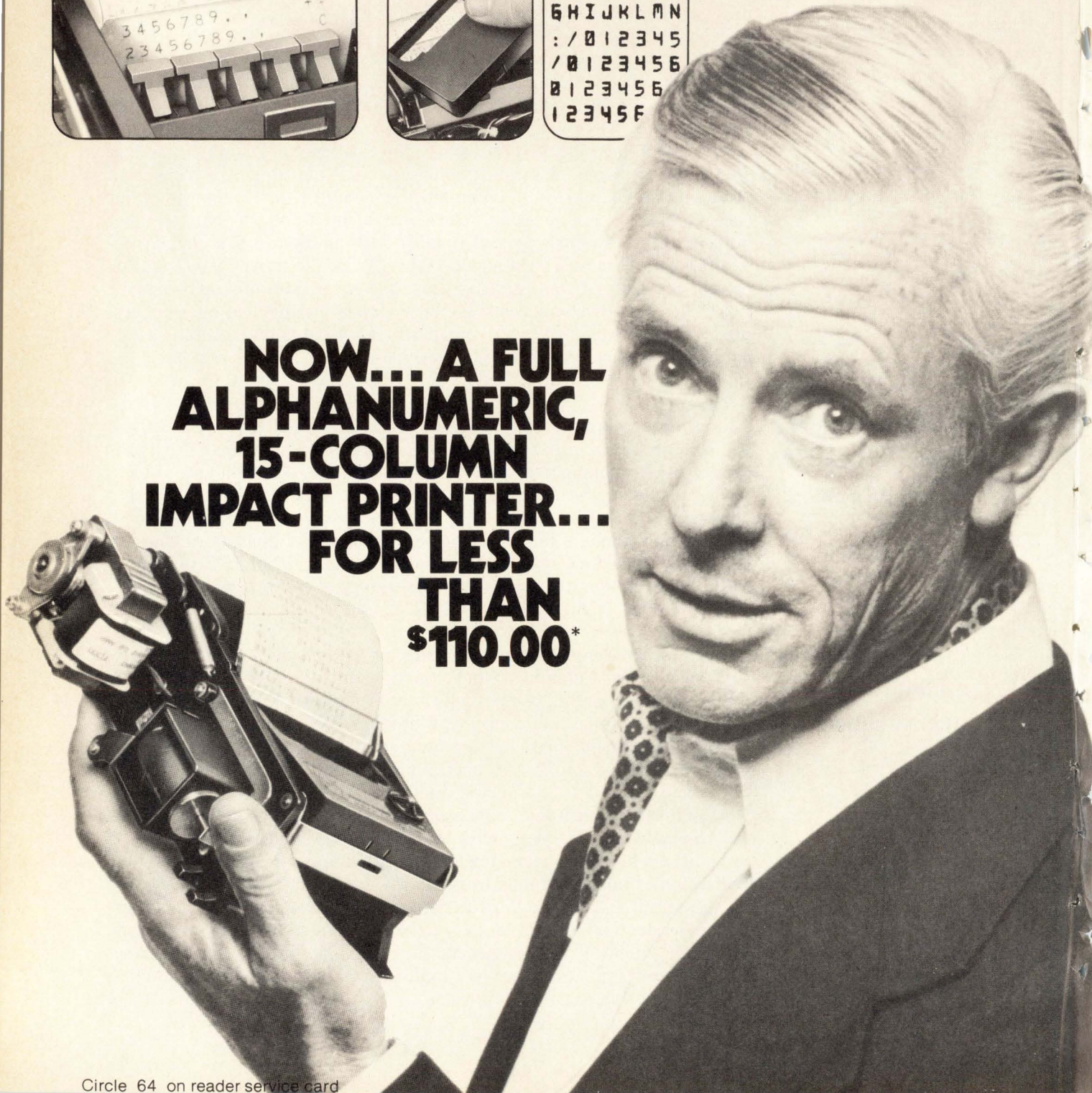

Valvo microwave module detects moving objects for burglar alarm

Although still relatively small, the market for electronic burglar alarms and object-protection systems in Europe is developing fast. In fact, an exhibition dedicated specifically to protection equipment was launched in Europe several years ago, and by now, a growing number of component firms have developed electronic equipment for just that market.

One of the latest protection products is a microwave module that Valvo GmbH in Hamburg, West Germany, is offering producers of motion-detection systems. Using a Gunn-oscillator source, the MDX0520 module sets up an electromagnetic field and, by radar-doppler principles, detects any object that moves within the field. Capable of sensing a moving human within a range of about 15 meters, the module sends its output to an evaluation unit that gives the alarm when motion is detected.

Its geometry and small dimensions distinguish the Philips subsidiary's MDX0520 from competing products, points out Jürgen Siebeneck, who developed it. Only 70 millimeters in diameter and 25 mm deep, the module is smaller than a typical tuna-fish can. This tiny space contains a microwave transmitter and receiver, the antenna with associated filter networks, and a voltage-stabilization circuit.

Antenna. The module's unusual planar antenna, an integral part of the module, consists of microstrips on Polyguide plastic material. Arranged in a single plane are the antenna's transmitting and receiving segments, each consisting of two parallel-coupled half-wavelength resonators. The microstrips are produced by etching the copper-layered Polyguide material. The antenna's aperture is 50° in the horizontal direction and 30° in the vertical, referenced to the 3-dB points. Its

gain is 9 dB and bandwidth is 200 MHz.

Because it is so compact, the module with the antenna on the front plate can easily be installed flush with the surface of a ceiling or wall in much the same way as those familiar household wiring or electrical distribution boxes. The unit can be covered with wallpaper.

The MDX0520, approved by the German Post Office, transmits in the X band at 9,350 megahertz. Since the doppler frequency lies within the

low-frequency spectrum, designers can use conventional design techniques for the signal amplifiers in the motion-detection equipment.

Stability. The Gunn oscillator, which is supplied with a stabilized 12 volts, has a radio-frequency output of 10 to 15 milliwatts. Within the range from -10°C to +40°C a high-frequency stability of less than -0.5 MHz/°C is guaranteed, but adequate operation from -30°C to +70°C is possible, Siebeneck says. A band-rejection filter eliminates un-

Around the world

Electret-foil form data cells for display

At Thomson-CSF's Corbeville Research Laboratories near Paris, researchers are working on units based on bistable electret foils for large wall displays. Although considerably more development is necessary before electret displays will be ready for the market, their inherent characteristics are very promising. A low 50-microampere current can switch the basic cell from on to off in 200 milliseconds—plenty fast for the display—and no holding current is needed between switchings. To be sure, the switching pulses have to be fairly high—typically, close to 500 volts, so far—but they can be provided by high-voltage transistors or pulse transformers.

The basic cell design is a plexiglass block 30 millimeters long and 11 by 11 mm in cross section, with a deep notch cut at one end and a frosted face at the other. The polypropylene electret foil, blackened to make it opaque, is fixed in the closed end of the notch, but it is free at the open end. Depending on which side of the notch it is switched to, the electret blocks out backlighting or lets it pass to the front face (reflective versions are also possible). The contrast ratio between the two positions is higher than 1,000. Because of the permanent electric charge it carries, the electret adheres to the metallic electrodes on either side of the notch until switched.

FFT processor aimed at pleasure-boat radars

Britain's Mullard Research Laboratories has developed a digital fast-Fourier-transform processor using MOS shift registers. It could lead to a reliable low-power radar unit for use up to 25 miles, the range usually needed by small-boat owners. MRL employs a frequency-modulated continuous-wave (fmcw) radar that needs only 10 watts of mean radiated power, well within the capability of solid-state sources. Computer simulation showed that one 1,024-point FFT using 12-bit arithmetic would give adequate spectrum analysis to derive target range and size.

A potential low-cost commercial version awaits two developments that are out of MRL's control—cheap charge-coupled-device shift registers and monolithic FFT arithmetic units, both under development in other companies. MRL's developmental hardware consists of three basic parts: the data collector, including the fmcw radar head, amplifier, and analog-to-digital converter; the FFT processor, and the "reshuffling" part, which rearranges the processor's output into the right order for analog display on a scope.

wanted second-harmonic signals.

The module's tangential sensitivity is -85 dBm at a signal-to-noise ratio of 6 dB. The high sensitivity, Siebeneck explains, is achieved by using in the receiver's mixing stage a number of beam-lead diodes integrated in hybrid fashion into the antenna structure. To obtain optimum sensitivity, the diodes are supplied with direct current by the stabilized voltage-supply circuitry. □

Japan

ECL chip developed for phone exchange

The master-slice approach has been adopted for the high-speed large-scale-integrated circuits to be used in Japan's upcoming generation of electronic telephone exchanges. Internal gates with low-level emitter-coupled logic powered by a -2 -volt supply provide fast operation with minimal power dissipation.

External gates, which are compatible with Motorola MECL 10,000 devices, operate from a standard -5.2 -v power supply. The small dissipation of the low-level gates makes possible about 200 gates with the relatively low propagation delay of 2 nanoseconds per gate.

The basic device, the first large-scale-integrated logic chip to be used by the Nippon Telegraph and Telephone Public Corp., was designed by its Musashino Electrical Communication Laboratory. It will be manufactured by NTT's four electronic-exchange suppliers—Nippon Electric Co., Hitachi Ltd., Oki Electric Co., and Fujitsu Ltd. These suppliers may get permission to sell the same device or variations of it to other customers and may also put other devices in the 72-pin ceramic package, which was developed by the laboratory in cooperation with Kyoto Ceramic Co.

Interchangeable. Devices made by these four companies will vary only slightly because of slightly different fabrication methods, but they will be interchangeable because of fine-

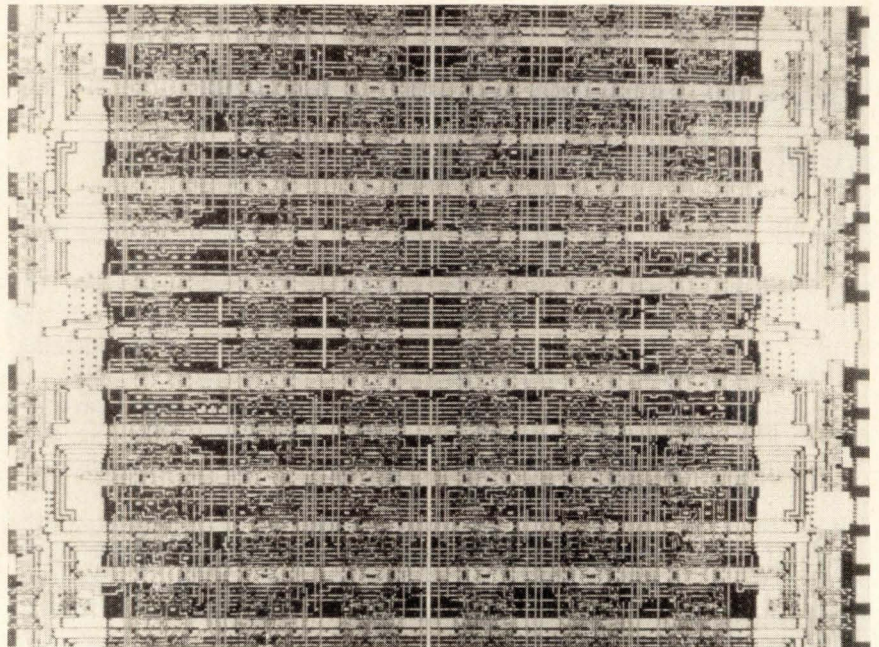

Cellular. Master-slice emitter-coupled-logic chip for Japanese electronic telephone exchange ALU and peripheral interface has 12 rows and 14 columns of cells.

tuned processing to obtain the target speed and current specifications. The chips are nominally 5 millimeters square, but each company makes a slightly different size and shape. Although the exchanges to be built with these ICs will have the same capacity as the present ones—about 40,000 lines—their higher speed will enable them to handle more traffic at one time.

Researchers have completed development of two devices that will be used in the electronic exchanges, and the four manufacturers have delivered samples to the laboratory. One is a 4-bit-slice arithmetic/logic unit that has the equivalent of more than 200 gates, including a shift register that is 2 bits wide by 4 bits long. Eight of these devices will be used in each central processing unit to get a data width of 32 bits. Each exchange requires 16 chips because the equipment is duplicated. The second device, a peripheral interface, consists of data latches in addition to a multiplexer.

Cellular. The basic chip has 168 gate cells, arranged in 12 rows and 14 columns. The chip also contains 12 reference-voltage power supplies—one for each row—and 22 cathode followers to match 50- or

75-ohm terminations. When operated from the -2 -v supply, the gates, for internal logic, dissipate only 3 milliwatts.

When operated from a -5.2 -v supply, the gates are used for output to drive adjacent chips with an MECL-10,000-compatible logic swing. They draw 15.6 mw. Either way, the delay is only 2 ns. When two or three gates are operated in a series arrangement, they are connected to a -5 -v power supply, and spare transistors, either in the same or a nearby cell, can provide the level shift. The emitter followers, connected to the -2 -v supply, draw 22 mA.

An extensive arrangement of connecting two or three internal gates in series can provide a chip with the equivalent of about 250 gates, but a level of about 150 to 200 is more common. For standard functions, gates are interconnected by two levels of metalization, separated by a layer of silicon dioxide or a proprietary dielectric. The ceramic package, 28 mm square, has thermal resistance of 17°C per watt. Maximum dissipation rating is 1.5 w. Pins, arranged in two nested squares, are spaced so that they fit in a 2.54-mm grid pattern. □

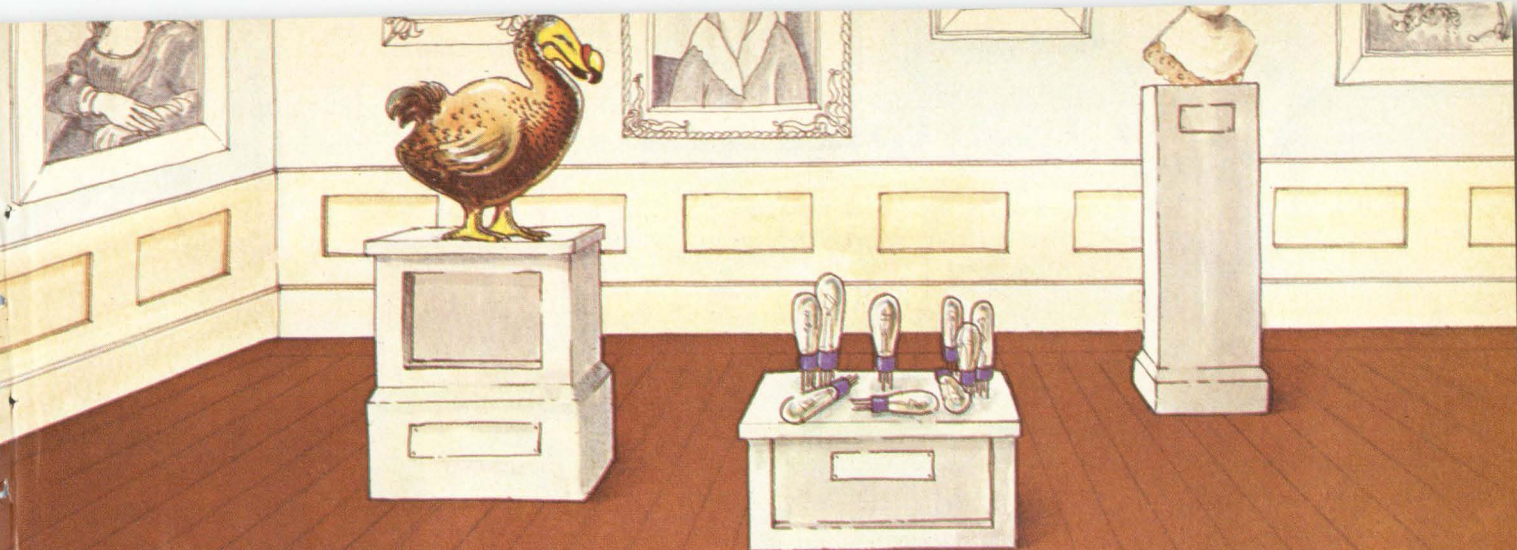

Take your costly, old-fashioned I.C. custom boards to the museum to visit the Dodo Bird and the Vacuum Tube . . . and leave them there.

Scanbe's New CustomCards Are Here!

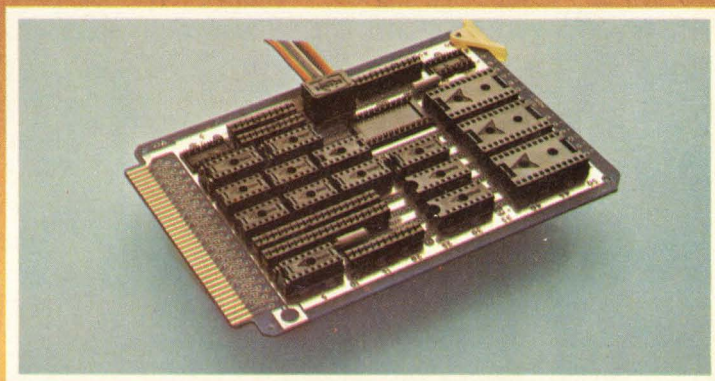

- Lower Cost** Save up to 25% on each custom board — Scanbe's CustomCard I.C. packaging system features our all new, money-saving DIP socket line with built-in discrete Vcc and GND pins and integral capacitors . . . plus the new low-cost NoCap™ pin strips. Results are dramatic . . . you save dollars on every unit and still get a simple, reliable custom design . . . only from Scanbe.
- Custom Patterns** Conventional boards in unconventional patterns — Over the years, Scanbe experts have produced thousands of custom I.C. card variations. The result is unlimited pin patterns and board configurations to answer your specific needs — and promote improved design. CustomCard provides the most economical, reliable solution possible. Again, savings to you.
- Standard Components** ... High reliability through field-proven elements — Scanbe's complete assortment of standard, field-proven socket card components guarantee superior performance and longer life. No costly "hybrid" designs, no unexpected delays or expensive "fixes". Instead CustomCard gives you the right solution the first time . . . every time.

Send For

Scanbe's new 28-page design/application catalog on I.C. packaging products. It tells the whole story on how to save money on your custom card requirements.



NAME _____

COMPANY _____

ADDRESS _____

CITY _____ STATE _____

ZIP _____ TELEPHONE _____



Scanbe Manufacturing Corporation
 3445 Fletcher Avenue, El Monte, CA 91731
 Telephone: (213) 579-2300 • TWX: 910-587-3437

We question the logic of some of the most successful companies in the world.

Mosler
An American Standard Co.



ITT Gilfillan

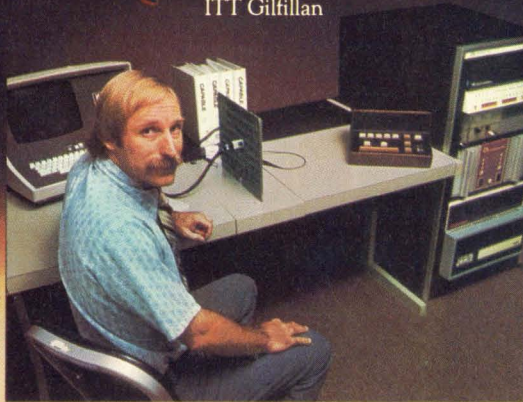

Raytheon Company

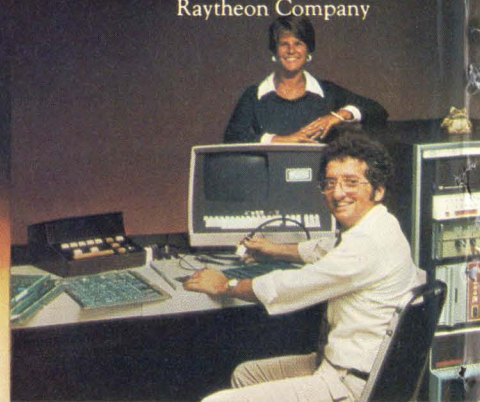

NCR Corporation



GTE Information Systems, Inc.



North Electric Co.



CMC, A Division Of Pertec
Computer Corporation

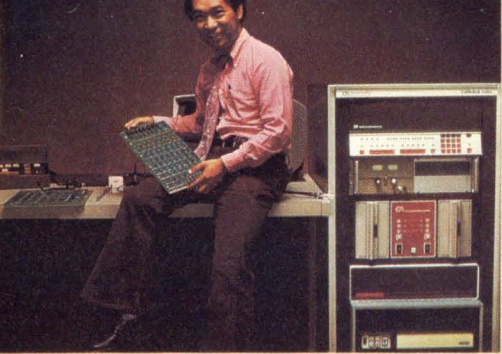

Admiral Group/Rockwell International



Bell Northern Research, Ltd.



Ampex Memory Products



Northern Telecom, Ltd.

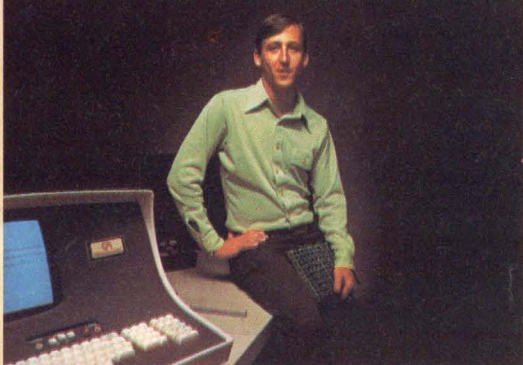

Guidance & Control Systems Division
Litton Systems, Inc.



Some of the world's most successful companies have reached a logical conclusion about ComputerAutomation's CAPABLE testers: when it comes to logic board testing, they're the safest buy available today.

One reason is experience. We've been designing and manufacturing automatic test systems since 1967. Our first customer was our own company's Naked Mini Division, the industry's second largest shipper of OEM mini-computers. Solving their 35,000 board-a-year testing problems has given us the first-hand experience necessary to meet high-volume test requirements in hundreds of installations for other companies around the world.

And because every company that tests logic boards has their own unique problems and requirements, we make our line of CAPABLE testers modular. That way, we can build a CAPABLE system to closely match your test needs and provide a custom-designed solution at standard-equipment prices.

All CAPABLE testers are 100% compatible, too. Any model can be upgraded or reconfigured to any other model. Anytime. So you buy exactly what you need today. And add to it later, should the need arise. That means you never have more tester than you're using or more boards than you can test.

We build every CAPABLE tester from the ground up. 80% of our components are produced in-house, including our own minicomputer — the powerful ComputerAutomation 16 bit LSI-II. And being part of a large, computer-based company gives us the advantages of on-going R&D support and quantity purchasing leverage not enjoyed by other test equipment manufacturers.

It also keeps our CAPABLE testers years ahead of the field. Our design and technology have been responsible for one first after another. First to implement an Automated Fault Isolation System to

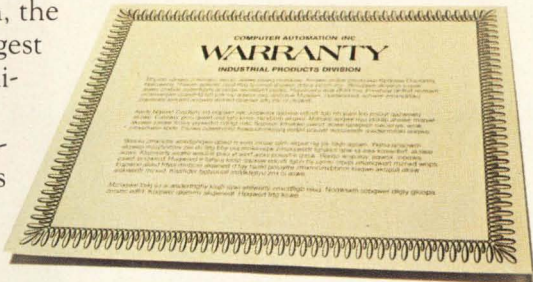

increase throughput. First with a Fault Detect Verification System to aid test generation and lower implementation costs. And first again with an IC Clip for Guided Fault Isolation to speed troubleshooting, using less-skilled operators.

CAPABLE systems are also available with analog capability and an add-on simulation system that has a unique offer attached: we'll buy it back at full price anytime you need to upgrade to one of our larger stand-alone simulators.

Then, because we build our testers better, we're able to back them better. Starting with free customer training, including user group seminars that cover operation, maintenance and programming. (And, of course, free installation.)

Then, once you're testing, we don't disappear. Every CAPABLE tester comes with the best warranty in the business — a full one-year, on-site, no-questions-asked warranty. And we offer expert maintenance on a contract basis, even after your warranty expires.

We're also available for applications and engineering consultation on a continuing basis.

Whether you need assistance with hardware and software

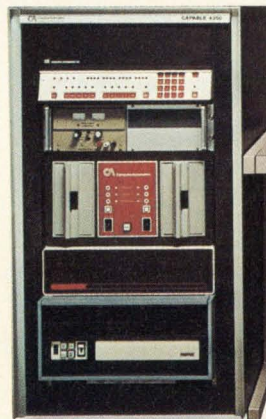

interface requirements or simply updates. Again, free of charge.

But the bottom-line is performance, and repeated side-by-side benchmark tests have proven that CAPABLE systems provide more accurate tests with higher throughput and lower implementation costs than any other tester on the market.

Of course, there are a lot more reasons you should consider our CAPABLE logic board test systems. But we don't expect you to take our word for it, even if we are a satisfied CAPABLE customer ourselves. So we invite you to question the logic of some of the other successful companies shown in this ad. For details, write or call us.



ComputerAutomation Industrial Products Division

18651 Von Karman, Irvine, CA 92713, (714) 833-8830. Or, in the following areas, call: New York City (201) 338-8300, Boston (617) 890-7190, Cleveland (216) 777-8700, Chicago (312) 956-6400, Dallas (214) 358-0278, Los Angeles (714) 833-8830, San Francisco (408) 988-1220. In Toronto (416) 445-1635. In Europe, CAI Ltd. (09 237) 71211.

Circle 69 on reader service card

LINEAR INNOVATIONS
FROM TI

BRIEF

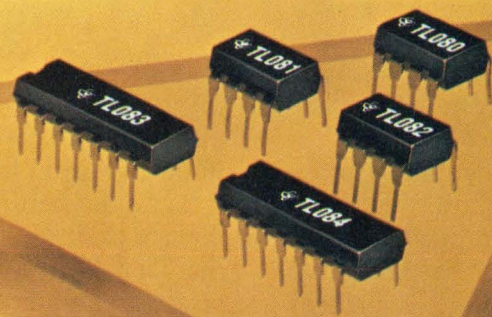

First BIFET op amp family. TI's new TL080 series.

High performance single, dual and quad op amps.

Here's a unique solution to your operational amplifier design needs...Texas Instruments new TL080 op amp family.

The first BIFET op amp family ever. With two singles; two duals and a quad that can meet most of your op amp requirements:

Both singles have offset voltage null capability. The TL080 requires external frequency compensation. The TL081 has internal compensation.

The duals, TL082 and TL083, both offer internal frequency compensation. The TL083 also provides offset voltage null capability.

The quad, TL084, has internal frequency compensation. It's the industry's first four-in-one BIFET op amp.

High performance

Each device in the TL080 series uses BIFET technology combining well-matched, high-voltage JFET and bipolar transistors on a monolithic integrated circuit. For the outstanding DC performance of Super Beta and excellent AC characteristics:

- 0 Input bias current - 0.4 nA max at 25°C; 10 nA max at 70°C.
- 0 Input offset voltage - 15 mV max at 25°C; 20 mV max at 70°C.
- 0 Unity gain bandwidth - 3 MHz typ.
- 0 Slew rate - 12V/ μ s typ.
- 0 I_{cc} per op amp - 2.8 mA max.

These same parameters apply for each member of the family; the entire series has identical AC and DC specs. For the greatest versatility and broadest user selectivity ever offered in operational amplifiers.

Additional advantages

If you check these specs, you'll find they're the best ever seen at these low prices. And the TL080 series' high performance is specified across the full temperature range.

TL080 Series BIFET Op Amp Prices

Prices for each part in 100-piece quantities. Plastic packages; commercial temperature range (0° to 70° C):

Device	Price	Price per Op Amp
TL080	\$1.04	\$1.04
TL081	0.52	0.52
TL082	0.91	0.455
TL083	1.17	0.585
TL084	1.30	0.325

Even greater performance is available when you order the "A" or "B" versions. For example, the TL081AC has the same 6.0 mV input offset voltage as the μ A741C.

The new TL080 series also features:

- 0 Function-for-function pin-outs with its most popular op amp counterparts.

0 The first high performance duals and quads ever available.

0 And prices competitive with many general purpose, non-BIFET devices.

So you can take advantage of their improved performance without the penalty of greatly increased costs. For example, the 100-piece price of the TL081CP is only 52¢.

Dual-in-line packages

The complete TL080 family is offered in dual-in-line packages for the extra bonus of lower testing and insertion costs. The TL080, 081 and 082 are available in 8-pin plastic DIPs and TO-99 metal cans; the TL083 and 084 in 14-pin plastic DIPs.

It makes sense to check out the greater savings and versatility you can realize with TI's new BIFET op amp family.

Brochure available

Just mail the coupon below for a free copy of TI's brand new 20-page "BIFET Op Amp" brochure. It's packed with data sheets, applications circuits, detailed comparative specifications and price information.

The complete TL080 series of BIFET op amps is available now from Texas Instruments and your local authorized TI distributor.

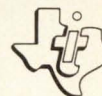

Texas Instruments TL080 Series BIFET Op Amps

Device	# of Op Amps	Internal Compensation	Offset Voltage Null	Pin-out Equivalents
TL080	1	No	Yes	μ A748; LM301A; LM308
TL081	1	Yes	Yes	μ A741; LF13741; CA3140; LF355
TL082	2	Yes	No	LM358; MC1458; RC4558
TL083	2	Yes	Yes	μ A747
TL084	4	Yes	No	LM324

Texas Instruments Incorporated
Inquiry Answering Service
P.O. Box 5012, M/S 308
Dallas, Texas 75222

E

Please send me TI's new BIFET Op Amp Family brochure and information on the following:

- All Linear Control Circuits
- Voltage Regulators
- Switching Regulators
- TL181 Series Analog Switches
- TL600 Series Analog Switches

NAME _____ TITLE _____

COMPANY _____

ADDRESS _____

CITY _____ STATE _____ ZIP _____

TEXAS INSTRUMENTS
INCORPORATED

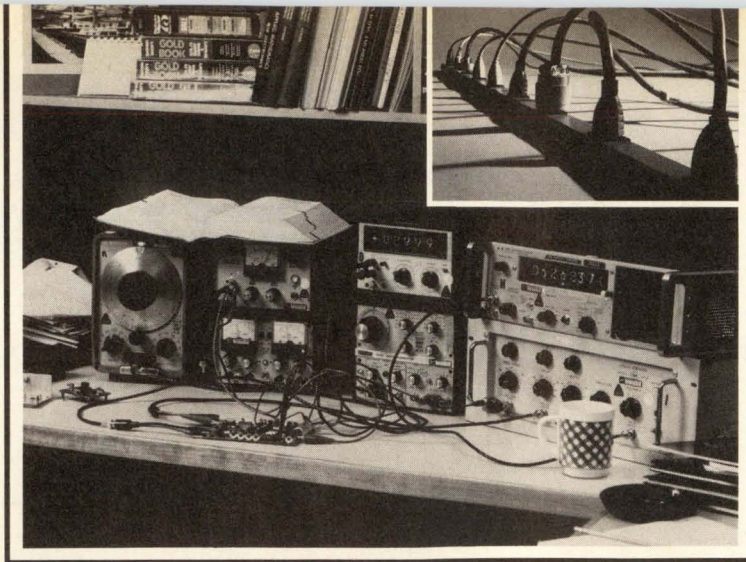

Here's an idea that could change your thinking about test equipment.

A complete test station doesn't have to be an assortment of special-function instruments. A working workbench doesn't have to be crowded and unhandy. And a truly portable test lab doesn't have to be out of reach.

TM 500 offers you an alternative: a modular line of compact, interchangeable plug-ins and mainframes. Multiconfigurable both in packaging and in performance, TEKTRONIX TM 500 is designed around the idea that test equip-

ment which is compatible in every respect can, in fact, cover a broader range of functions and meet a wider variety of measurement situations. To say nothing of its ability to adapt more readily to new challenges.

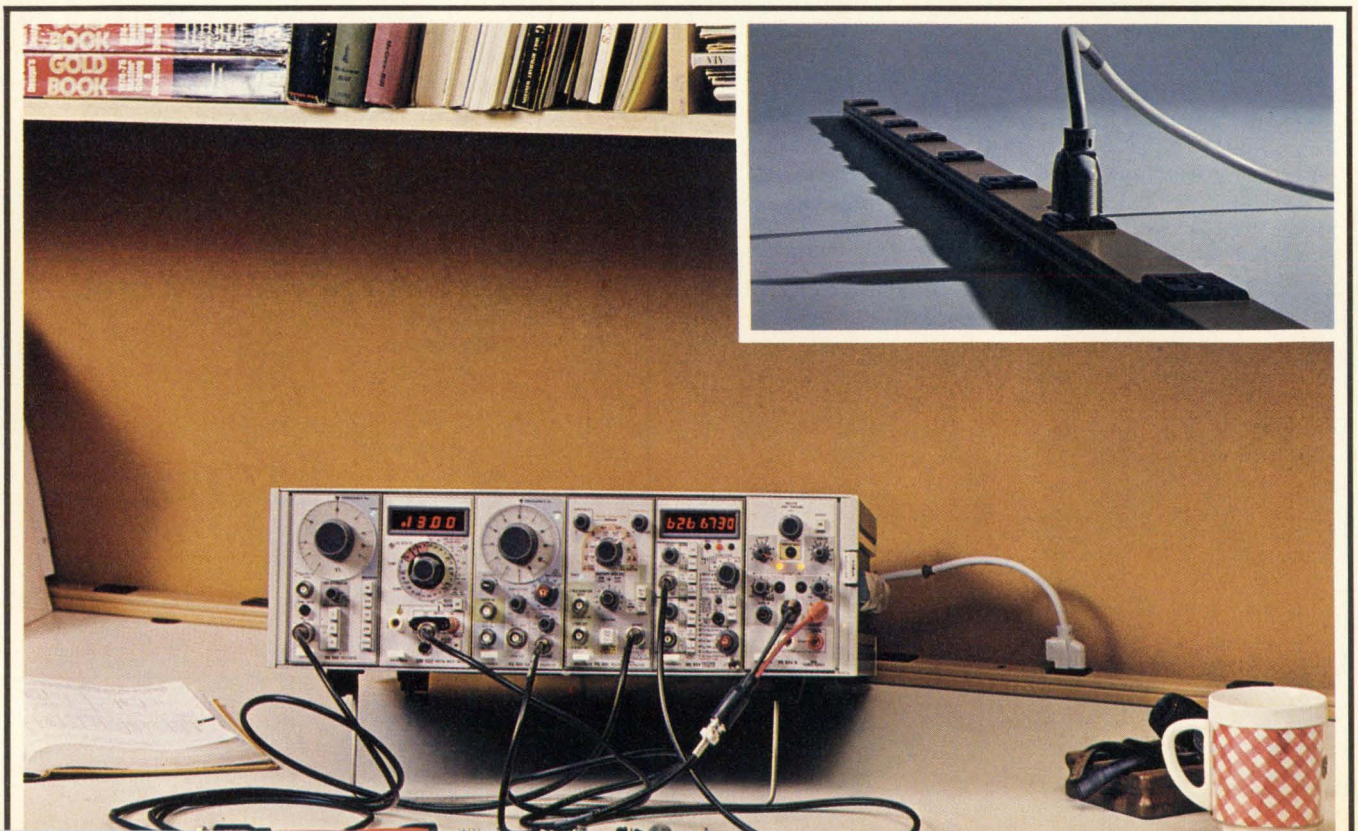

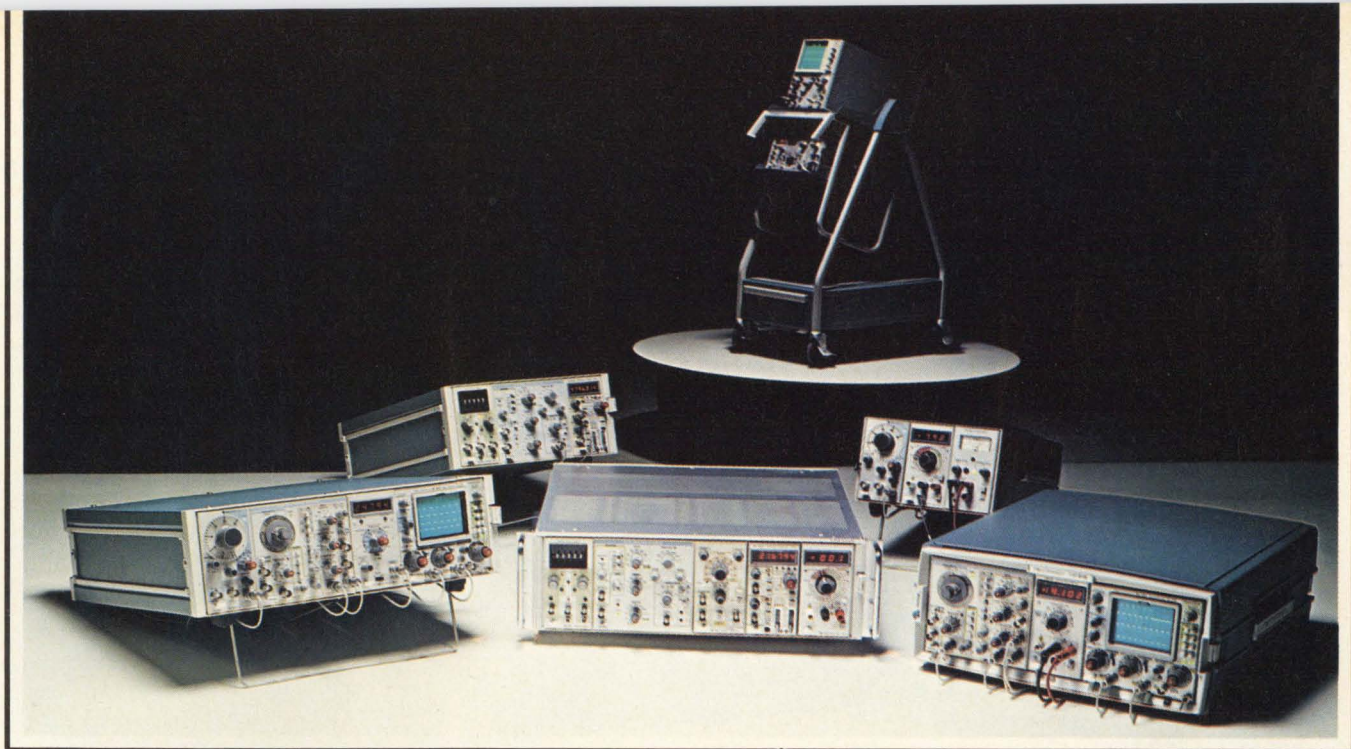

Modular DMMs, counters, generators, amplifiers, power supplies, oscilloscopes, logic analyzers, and word recognizers can be interfaced electrically. Signals



can be routed from one plug-in board to another via the mainframe mother board, thus enabling you to build a test instrument that's more powerful than the sum of its parts.

The plug-ins can be configured together in six widths of mainframe and four types of packages, depending on where and how you'll use them. Select the plug-in modules you need just as you would monolithic instruments, and then combine them in the appropriate mainframe for a

convenient, uncluttered bench setup; mount up to 6 functions



side-by-side in a 5¼-inch rack; build a rollabout station that "follows" you around the lab. Or



pack a portable test station in the small-as-a-suitcase TM 515 Traveler Mainframe, which carries up to 5 modules and typically weighs less than 35 pounds, including the modules.

The result is a total test system that looks like a unit . . . works as a unit . . . yet is still configurable to new or changing measurement requirements. So the next time you're looking into test instrumentation, specify the one product line that's designed for configurability.

For further information or a demonstration of TM 500 Instrumentation, write or phone: Tektronix, Inc., P.O. Box 500, Beaverton, Oregon 97077, (503) 644-0161 ext. 5283. In Europe: Tektronix Limited, P.O. Box 36, St. Peter Port, Guernsey, Channel Islands.



TEKTRONIX®

committed to
technical excellence

TM 500...designed for configurability.

For Technical Data circle 72 on Reader Service Card
For Demonstration circle 73 on Reader Service Card

NEW FROM KEITHLEY: TWO "BEST BUY" DMMs. 4½ DIGITS. 30000 COUNTS. \$525 / \$625.



Model 173



Model 172

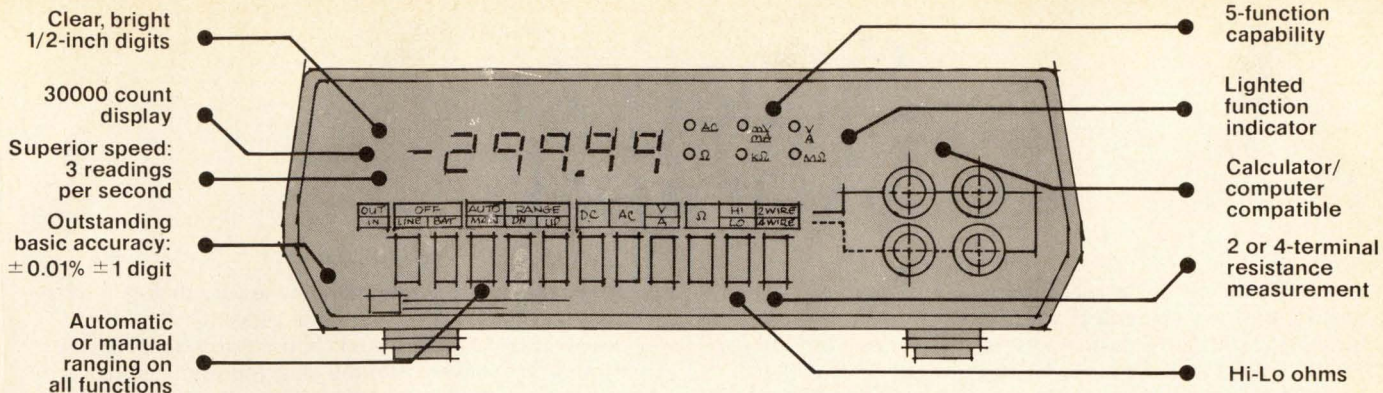

Take a look at the remarkable features of the new Keithley Digital Multimeters. They're unmatched in the industry.

Now consider price. At \$525 we think you'll agree the Keithley 172 is the best buy in a general purpose 4½-digit DMM.

There isn't another 4½ that matches the price-performance value of the 172. Except for its higher-rated companion, the Keithley 173.

For \$525: the exceptional 172.

To begin with, you get a dependable, durable, portable, easy-to-use, autoranging instrument with five functions. Designed for research, engineering or production applications.

Measure from 10 microvolts to 1200 volts dc, 10 microvolts to 1000 volts ac, 10 milliohms to 300 megohms, 10 microamps to 2 amps, ac or dc. DC accuracy is 0.01% ± 1 digit.

There's more: 3 month recal cycle. No-nonsense, full-year guarantee on parts, workmanship, and specs. 30000-count display yields maximum accuracy for 15, 18, 24 and 28-volt measurements.

For \$625: the even more exceptional 173.

The Keithley 173 is our top-rated 4½-digit DMM. It gives you all the performance and accuracy of the 172 plus superior autoranging current measurements from 10 nanoamps to 3 amps. This makes the 173 the most complete and versatile general purpose 4½-digit DMM in the world—at any price.

More versatility. Now or later.

Options and accessories expand the 172 or 173 to your specific needs: Rechargeable battery pack you can buy now or add later. Digital output/control. RF probe. 50-amp shunt. Clamp-

on ammeter. High-voltage probe. Rack mount kits. Test lead sets. Carrying case. IEEE 488 interface.

Make this easy decision.

For most 4½-digit DMM applications, the new Keithley 172 is your best buy. When you require more current measuring capability, the 173 is.

For convincing proof, send for detailed specs or request a demonstration. Or if you're already convinced, send your order to: Keithley Instruments, 28775 Aurora Road, Cleveland, Ohio 44139. (216) 248-0400. Europe: Heighhofstrasse 5, D-8000 München 70, West Germany. (089) 7144065.

DMMs for all your needs.

We know you have a variety of measurement requirements. So we offer a growing family of DMMs — 3½ to 6½ digits — to satisfy your application. And your budget.

3½ digits	4½ digits	5½ & 6½ digits
<p>Model 168 General purpose. Low cost.</p> <p>Model 160B 1 μV and 10 pA sensitivity.</p> <p>Model 616 Super-sensitive. 0.1 pA full-scale.</p>	<p>Models 172 and 173 Two "Best-Buys!"</p> <p>Model 171 1 μV sensitivity. 5-functions.</p> <p>Model 174 0.1 μV sensitivity. (coming soon)</p> <p>Model 180 30 nV sensitivity.</p>	<p>Model 190 Multi-function. Low cost.</p> <p>Model 5900 0.001% accuracy. High stability.</p> <p>Model 6900 Accuracy, stability and sensitivity measured in ppm.</p>

New guide available: "How to get more from your DMM." Send for yours today.

KEITHLEY
The measurement engineers.

Situation Wanted:

Name—Amphenol® 97 Series connector. For consumer, industrial, business equipment. And more. Here's the old pro of standard circular power connectors. It's for service from 250 to 4200 VDC (200 to 3000 VAC, RMS) and wire gauges from 4 to 16. So 97 Series connectors are ideal for all kinds of equipment—TV, computers, machine tools, communications, you-name-it.

And still more qualifications. Including MIL-C-5015. And our pre-aligned non-rotating contacts that mean quick, easy soldering. The 97 Series is also built strong to work hard. With diallyl phthalate insert material (it's highly stable at high temperatures). Molded barriers between contacts for higher voltage ratings. And a few more features you'll want to find out about.

Literally hundreds of configurations. Take your pick of inserts—for a number of wires, all of the same gauge. Or for lots of wire, all of different gauges. And choose the receptacle you want: wall, cable, or box. And the plug you want: straight, quick-disconnect, angle, or panel-mount.

Availability: Whenever you're ready. Amphenol 97 Series connectors are available now for off-the-shelf delivery from your Amphenol Industrial Distributor. Call him soon. Or to find out how Amphenol 97 Series connectors can be tailor-made to match your specific application, just write or call: Bob Ashley, Amphenol Connector Systems, Bunker Ramo Corporation, 900 Commerce Drive, Oak Brook, Illinois 60521. (312) 986-3763.



The right idea
at the
right time.

AMPHENOL Connector Systems **BUNKER RAMO**®

Probing the news

Analysis of technology and business developments

Military and space stand tall



Departing Ford budget officials push military total to \$123 billion and leave Carter Administration virtually forced to accept rise

by Ray Connolly, Washington bureau manager

It was one of his last acts as President, and Gerald Ford had nothing to lose. So with the delivery of his \$440 billion fiscal 1978 spending program to the Congress, he threw Jimmy Carter a curve.

It is a rising curve of Federal outlays for the year beginning Oct. 1. It is marked by sharp increases in military spending and significant new starts in space that are out of sync with President Carter's expressed priorities. Yet the Carter White House indicates it may be forced to watch the ball go by this year, taking a strike and learning from the experience.

A Carter transition staff recommendation now circulating in Washington urges the new President to move cautiously at the start and avoid any major political confrontation with—and possible defeat at the hands of—the 95th Congress. Thus Carter's proposed budget amendments, scheduled for delivery to Congress before March 1, seem un-

likely to significantly alter any major electronics spending programs.

Major proposals to consolidate the nation's energy agencies into a single department and to restructure the executive branch will occupy much of Carter's first 100 days, as will programs to reduce unemployment and Federal income taxes. "We won't truly have a chance to look at many individual military programs for a while," admits a Carter staffer, "so we're going to have to trust the judgement of Harold Brown," the new Secretary of Defense.

What Brown has to deal with is Ford's record proposal for \$123 billion in military obligations, an increase of nearly 12% from fiscal 1977. Of the total, \$110 billion is proposed as expenditures in the new fiscal year. This reflects significant spending increases and new starts in procurement as well as research and development (see tables).

But there is a catch: if Congress approves the Pentagon's 27% jump

to \$23.8 billion in its procurement "wish list" for fiscal 1978, then the Defense Department will be committed to hardware purchases that will require another 21% rise to \$28.8 billion in fiscal 1979.

The 217,000 defense-industry jobs that Ford's budget would create would bring the total of such jobs to more than 2 million, a 12% increase from the present level (itself a jump of more than 9% from last year). "A lot of those will be in electronics and aerospace in view of new program priorities," observes one contractor's budget analyst. Defense Department comptroller Fred Wacker says much of the increase in jobs is attributable to larger outlays for research, development, test, and engineering. Military RDT&E spending in the Ford budget is set at \$11.3 billion, up 13.6% from fiscal 1977's level, which rose 12% from the previous year.

While the National Aeronautics and Space Administration's numbers for fiscal 1978 are less extraordinary

Probing the news

than those proposed for defense, they are at least going up after several stagnant years. Ford's proposal to boost NASA spending by 5.3% next year to \$3.9 billion is modest on its face. But the new and accelerated programs he calls for would push up NASA spending another 11% in fiscal 1979 to \$4.3 billion.

The space agency proposes production starts on three additional Space Shuttle orbiters to complete a fleet of five—a plan that could stall in Congress. And James C. Fletcher, Ford's NASA chief, wants to begin four new programs: the long-delayed Large Space Telescope for 1983 orbit by the shuttle, a Jupiter Orbiter Probe for shuttle launch in 1981, a fourth Landsat for 1981 launch with an information capability 10 times greater than the predecessor Earth Resources Technology Satellites, plus a search and rescue satellite for development with Canada and other countries.

Like those for defense, the space program proposals could prove an embarrassment to Jimmy Carter's White House if it tangles with Congress over trying to alter too many of them too quickly. "Budgets are a little like landslides," smiled one departing Ford official in the Office of Management and Budget as he emptied his desk. "They start slowly but acquire an awful lot of energy and momentum as they build up over the course of a year. Once they begin moving, they are awfully hard to stop. And you can get killed trying to change their direction."

Defense cuts will come hard

Jimmy Carter's reaction to Gerald Ford's proposed 12% increase in fiscal 1978 military outlays to \$110 billion is not yet clear. That's what Defense Secretary Harold Brown was saying when he told a listener during a break in his Senate confirmation hearings that "I wouldn't guess at this point" how Carter will seek to modify Ford's budget plan. The temper of the new 95th Congress, with its large Democratic majority, is not yet measurable either. First industry estimates in Washington are that there is little

MAJOR REQUESTS FOR WEAPONS PROCUREMENT (in millions of dollars; quantities in parentheses)			
	FY 1977	FY 1978	Contractor
ARMY AIRCRAFT			
C-12A cargo	\$16.6 (20)	0	Beach Aircraft
AH-1S Cobra/Tow	128.6 (82)	\$142.8 (83)	Bell/Avco/Hughes
UTTAS, helicopter	213.0 (15)	270.9 (56)	Sikorsky/GE
NAVY AIRCRAFT			
A-4M Skyhawk, USMC	92.7 (21)	7.7	McDonnell
A-6E Intruder	80.2 (6)	185.9 (12)	Grumman
EA-6B Prowler	135.5 (6)	143.6 (6)	Grumman
A-7E Corsair II	220.4 (30)	58.4 (6)	Vought
F-14A Tomcat	700.9 (36)	940.7 (44)	Grumman
F-18 strike fighter	346.9	655.9	McDonnell/Northrop
CH-53E Sea Stallion (1)	105.5 (6)	86.9 (6)	Sikorsky/GE
AH-1T Sea Cobra	64.3 (23)	31.2 (8)	Bell
P-3C Orion	239.3 (12)	321.6 (14)	Lockheed
S-3A Viking	0.4	58.1	Lockheed
E-2C Hawkeye	156.5 (6)	196.6 (6)	Grumman
AIR FORCE AIRCRAFT			
B-1 bomber	1,555.7 (3)	2,153.9 (8)	Rockwell
A-10 close support	613.3 (100)	840.9 (144)	Fairchild
F-15 Eagle	1,524.8 (108)	1,766.3 (108)	McDonnell
F-16 ACF	499.3	1,695.5 (105)	General Dynamics
*Advanced Tanker Cargo (ATCA)	28.8	276.6 (6)	McDonnell/Boeing
E 3A AWACS	564.6 (6)	528.9 (6)	Boeing
ARMY MISSILES			
Chaparral, surface-air	66.4 (2,000)	55.1	Ford Aerospace
Hawk, surface-air (1)	107.3 (526)	111.2 (559)	Raytheon
*U.S. Roland, surface-air	85.0	131.1	Hughes
*Stringer, surface-air (1)	25.8	105.6 (890)	General Dynamics
Dragon, antitank (1)	90.0 (16,080)	93.7 (20,671)	Multiple
TOW, antitank/assault (2)	108.8 (13,051)	102.6 (14,866)	Hughes/Emerson
Lance, surface-surface	75.7 (360)	82.9 (360)	Vought
*Pershing, surface-surface	0	18.7 (6)	Martin Marietta
AN/TSQ-73, Hawk/Nike controls	42.2 (12)	48.0 (12)	Litton
NAVY MISSILES			
Poseidon, FBM	20.9	21.8	Lockheed
Trident I, FBM	1,542.2 (48)	1,500.1 (96)	Lockheed
Sparrow, air-air (3)	169.2 (1,320)	180.0 (1,725)	Raytheon/GD
Sidewinder, IR air-air (3)	95.5 (1,420)	151.8 (2,900)	Raytheon/Ford
Phoenix, air-air	91.2 (240)	95.9 (210)	Hughes
Shrike, air-surface (3)	51.3 (1,275)	41.6 (900)	Various
Standard Arm, air-surface	0.2	3.0	General Dynamics
Harpoon, ship/air-surface	150.4 (245)	155.8 (315)	McDonnell
Standard, MR, surface-air	87.3 (500)	126.7 (480)	General Dynamics
Standard ER, surface-air	55.7 (36)	71.7 (40)	General Dynamics
AIR FORCE MISSILES			
Minuteman II/III, ICBM	770.0 (60)	338.3	Multiple
AGM-69A/B SRAM, air-surface	40.8	70.6	Boeing
*AGM-86, air-surface cruise	79.2	164.5	
AGM-65A/B, E/O Maverick, air-ground	4.9	8.3	Hughes
*AGM-65C, Laser Maverick	40.0	47.9 (100)	Hughes
*AGM-65D, IIR Maverick	11.2	67.2	Hughes
Aerial targets/drones (4)	153.9	176.1	Multiple
NAVY VESSELS			
SSN 688, attack sub	1,290.8 (3)	531.0 (2)	Newport News/GD
DD 963, destroyer	203.6	70.8	Litton
CSGN, strike cruiser (Aegis)	33.3	203.1	Newport News
DDG-47, destroyer (Aegis)	11.0	935.0	Not selected
PHM, hydrofoil/missile	42.6	1.2	Boeing
FFG, missile frigate	1,283.0	1,616.0	Bath Iron/Todd
OTHER PROCUREMENT			
Navstar GPS, Global Satellites	62.0	112.4	GD/Rockwell
Space Shuttle, USAF booster	60.1	167.1	
*M557A1, tracked command post	0	54.2 (565)	FMC Corp.
*MICV, combat vehicle	29.8	89.5 (107)	FMC Corp.
M60A1/3 tank (1)	491.9 (927)	606.2 (960)	Chrysler
Artillery Missile Radar	1.2 (48)	2.8 (140)	Not selected
CLGP, laser shell	36.1	54.1	Martin Marietta
MK-48, torpedo	139.5 (214)	163.8 (300)	Gould
MK-60, ASW mine (Captor)	65.4 (240)	90.2 (550)	Goodyear
*MK-30, mobile ASW target	2.9	21.5 (12)	Northrop
*MK-15 CIWS Phalanx, ship gun	38.9	81.8 (21)	General Dynamics
FLTSATCOM, satellite	72.9	62.3	TRW
DSCS, satcom	219.9	138.2	TRW

(1) Includes Marine Corps procurement (2) Includes Navy/Marines procurement
(3) Includes USAF procurement (4) Includes Army/Navy requirements
† In competition * First major production

Source: DOD

room for fiscal 1978 cuts in programs with high levels of electronics spending.

The Ford plans would push up outlays by more than 10% a year to \$121.3 billion for fiscal 1979 and \$133.8 billion for fiscal 1980. The annual growth rate would taper off to 8.8% for \$145.6 billion in 1981 and 7.5% for \$156.4 billion in 1982.

Carter and future Congresses are

sure to modify those numbers, but Ford's programs will be hard to alter. "Beyond the very real Soviet threat," points out one Pentagon economist, "there are just too many jobs involved in too many industries for Carter's people to tinker much until they develop alternatives."

Hardware. Of the \$35.1 billion in procurement money the Pentagon wants authority to spend—some in

WEAPONS R&D FUNDS
(in millions of dollars)

	FY 1977	FY 1978	Contractor
ARMY			
Advanced Attack Helicopter (AHH)	\$130.8	\$200.0	Bell
AFAADS, air defense	0.2	24.2	
Ballistic Missile Defense Technology	100.1	107.7	McDonnell
BMD Advanced Technology	102.7	107.3	Multiple
Hellfire, helicopter missile	17.8	50.5	
Patriot (SAM-D), surface-air	180.2	214.6	Raytheon
SSM, surface-surface missile	5.0	30.1	
Tri-Tac, joint tactical communications	37.3	58.9	GTE-Sylvania
NAVY			
V/STOL aircraft developments	44.0	101.1	Multiple
LAMPS ship helicopter	73.7	107.3	Multiple
AEGIS, surface-air	26.3	27.2	RCA
HARM, air-surface radiation	30.0	29.7	TI
Tomahawk, sub/air-launched missile	119.5	234.3	General Dynamics
SES, surface effect ship	48.0	43.9	Rohr Ind.
Advanced ASW Torpedo	18.0	26.5	
ELF communications	14.8	23.7	
Wide Aperture Array Sonar	9.2	23.1	IBM
AIR FORCE			
Advanced Medium STOL	29.3	25.0	McDonnell/Boeing
E-4 AABNCP, command post	98.7	65.8	Boeing
*NATO AEW&C aircraft (E-3A)	0	15.7	Not selected
Precision Location Strike System	12.0	30.2	Not selected
*RF-X, tactical air recon.	0	1.0	
*Advanced MR missile, air-air	5.0	42.5	Multiple
*GLCM, ground-launched missile	0	3.9	
*M-X, MIRVed ICBM	69.0	294.4	Boeing
*WVR missile, air-air (AIM-9L folo)	0	5.9	Not selected

*New R&D start

Source: DOD

later years—the Navy is in line for some \$15.4 billion, of which nearly \$6.5 billion is for ships. The Air Force is budgeted for \$13 billion, two-thirds of which will go for aircraft, including beginning production of the B-1 bomber and major purchases of two fighters. The Army is left with \$6.3 billion, with big shares budgeted for a new M-60 tank and missiles for air and tank defense.

Of the \$12 billion in new R&D authority, Air Force and Navy programs also dominate, with respective shares of \$4.4 billion and \$4.2 billion. The Army receives \$2.6 billion. Biggest full-scale development start is the M-X intercontinental missile with multiple warheads to follow the Boeing Minuteman series. The Air Force is ready to spend nearly \$295 million, more than four times its fiscal 1977 program.

Of the other five major Air Force efforts, contractors are watching the accelerated competition for an advanced medium-range air-to-air missile to succeed Raytheon Co.'s troubled AIM-7 Sparrow in the mid-1980s [*Electronics*, Jan. 20, p. 25]. Proposed for the F-14, F-15, F-16, and F-18 fighters, the new radar-guided missile's budget jumps to \$42.5 million from \$5 million this year. Already competing on the project are Northrop Corp., a new entrant in the field, plus Ford Aero-

space and Communications, Hughes Aircraft, General Dynamics, and Raytheon.

A second new air-to-air missile competition is the system known as Within-Visual-Range, or WVR. It begins with \$5.9 million to develop a follow-on to the short-range, infrared Sidewinder AMI-9 that is now produced by Raytheon and Ford Aerospace.

Although the Army's major R&D programs remain essentially unchanged, several are up for significant funding boosts, such as Bell's Advanced Attack Helicopter and Raytheon's Patriot air defense system using the SAM-D missile.

To fill the gap until it gets its Advanced Scout Helicopter, the Army is programming \$18.3 million to design and test a system using a laser target designator for precision-guided munitions fired by attack helicopters or ground forces.

Aircraft. Some of the biggest product allotments next fiscal year will go for aircraft and their associated avionics, with the largest purchases being made by the Air Force. Nearly \$1.7 billion is programmed for 105 of General Dynamics Corp.'s F-16 Air Combat Fighter, for example. Production of the McDonnell Douglas F-15 Eagle holds steady at 108 planes, although funding will rise nearly 16% to \$1.7 billion. Output of Fairchild's A-10 close-support plane is programmed

to accelerate to 144 from this year's level of 100.

While the Navy is phasing out the Marine Corps' A-4 Skyhawk, it wants \$940 million to boost production of Grumman's F-14A Tomcat to 44 planes—eight more than this year. Grumman would also get \$186 million for a dozen of its A-6E attack aircraft—double the fiscal 1977 number—plus \$143 million for six of the all-weather, tactical jamming versions, the EA-6B.

First production money for the McDonnell F-18 fighter is set at \$29.3 million, while RDT&E funds for the plane almost double last year's level to \$626.6 million. Lockheed Aircraft's only big chunk of Navy aircraft money will come from the \$321 million purchase of 14 more P-3C antisubmarine patrol planes.

Missiles. While the Air Force proposes to accelerate development of its new intercontinental M-X, it has slashed production money sought for the Minuteman series by more than half to \$338 million. That cutback is less likely to arouse congressional ire than the doubling of Air Force funds for Boeing's AGM-86 cruise missile to \$164.5 million. Designed for use with the B-52 and B-1 bombers, the missile is sure to stir up a Capitol Hill controversy over claims that it duplicates the Navy's Tomahawk being developed by General Dynamics. McDonnell Douglas is developing the Tercom guidance system for both weapons.

Hughes Aircraft's AGM-65 Maverick air-to-ground missile proves to be a big winner in the Air Force budget with four models funded, including the first purchase of 100

Generating energy. Frank G. Zarb, left, who was President Ford's energy czar, talks over budget request with OMB official.



Probing the news

laser-homing versions. Altogether, Maverick is budgeted for \$123 million.

Ships. The Navy's budget for fleet additions is again dominated by its request for nearly \$2 billion for two more Trident missile-launching submarines from General Dynamics' Electric Boat division. The figure is only 54% more than this year's \$1.28 billion for one boat, but long-lead-time funds already spent will make the boats considerably more costly.

In its only other billion-dollar ship program, the Navy wants a 26% boost to \$1.6 billion for 11 more of its 440-foot guided-missile frigates. This year it is buying eight of the ships under contracts to Bath Iron Works and Todd Shipyards.

NASA looks for upturn

The number of jobs at contractors of the National Aeronautics and Space Administration will slip below the 100,000 mark next September for the first time in 15 years. But NASA Administrator James C. Fletcher—who is fighting hard to keep his own job—foresees an upturn next year, providing Congress approves his \$3.9 billion spending program.

The prospect that Congress will give NASA the authority to spend \$3.9 billion is good. Similarly, Fletcher is also believed to have a good chance to stay on in the Carter Administration, at least for a while.

The space agency's budget requests in Gerald Ford's lame-duck budget for fiscal 1978 are not



Scientific approach. H. Guyford Stever, science adviser to the President, conducts briefing on his office's budget request.

Energy R&D gets 28% increase

The Federal Government is continuing to pack a good deal of its civilian R&D muscle into energy. Of the \$9.4 billion proposed for those outlays—up 6% over fiscal 1977—energy-related projects will consume \$3.7 billion, 28% more than last year.

The Energy Research and Development Administration is the major funnel, planning to spend \$229 million of its \$4.4 billion in total R&D outlays for solar energy work. That's \$68 million more than last year's expenditure and a whopping \$136 million more than the solar energy outlay for fiscal 1976. A key reason for this year's increase is the \$65 million to be spent for a solar electric central receiver pilot plant, a 10-megawatt facility.

At the National Science Foundation, the other agency with a major mission of overseeing and funding scientific R&D, there is a restoration of funds to Research Applied to National Needs. That broad category, which includes such items as earthquake engineering, finding nonconventional food sources, and weather modification, will account for \$78 million, compared to the fiscal 1977 expenditure of \$69 million—a figure about the same as in fiscal 1976.

expected to be altered much by President Carter, according to Administration officials. Ford's Office of Management and Budget pared Fletcher's initial requests by \$170 million before leaving.

One consequence of that beating will be the drop in contractor employment to 98,600 by September. But if NASA gets its way with Congress, the industry job level should rise to 107,200 by September 1978. That figure is far below the 376,700 jobs the agency generated at its June 1965 peak, and not even up to last June's 108,000. "But at least we have bottomed out—I hope," a NASA budget specialist says.

New starts. In addition to the \$1.2 billion sought for Space Shuttle design, development, test, and evaluation, the agency wants another \$141 million to begin production of the final three orbiters for a fleet of five. The bulk of the money for electronics in the DDT&E request is contained in the \$690.5 million for the orbiter itself and the \$133.5 million for the launch and landing systems. While the orbiter request represents a 19% drop from fiscal 1977, the launch and landing systems money represents a 50% boost.

For the 2.4-meter space telescope, NASA wants \$36 million. The promise of the system during its decade or more of operation, Fletcher asserts, is its "unparalleled capability" when operating above the obscuring layers of the earth's atmosphere.

The new Jupiter Orbiter Probe is budgeted for \$20.7 million. However, declines in older programs such as Viking, Pioneer Venus, and the 1977 Mariner probe of Jupiter and Saturn produced a 23% overall drop in planetary program funds to \$148.2 million for next year.

The \$21.9 million NASA wants for a Landsat D earth-resources satellite accounts for nearly all of the 42% gain in the \$92 million earth resources detection and monitoring program.

Transportation. While NASA officials seem relieved at the prospect of minor gains after years of hardship, the atmosphere within the Department of Transportation, its Federal Aviation Administration, and the Coast Guard is grim. Programs with significant electronics content are hard to find, even in the FAA. The \$2.7 million budget of that agency represents a 1.7% increase. A total of \$1.8 billion will be used for air-traffic-control and navigation systems, as well as for enforcement of civil air regulations and for airport administration.

Another \$213 million will go largely for electronics, including automated air-traffic control, new radars, improved air navigation facilities, and landing aids. The FAA's research, engineering, and development budget comes out with a mere \$85 million, a figure that both the bureaucracy and its contractors hope will be increased by the Congress with support from Carter. □

ROLM welcomes DEC to the Mil-Spec computer market.

We've been where they'd like to be.

Complete hardware redesign of a commercial minicomputer to produce a fully nomenclatured Mil-Spec version is nothing new. ROLM did it eight years ago along with Data General.

And today, there are over 3,000 ROLM Mil-Spec minicomputers in airplanes, jeeps, trucks, buoys and just about everywhere else. And they're doing what industrial and military users want them to do: fill the need, and do so reliably.

They work. You can ask any one of our hundreds of users on land, in the air, on the water — or even under it.

But don't take our word for it. Send for the ROLM catalog that describes our five separate models, our memories, I/O's, peripherals and extensive software. We deliver most systems in 30 days. Just send in the coupon and your project will be where you want it to be...on time with ROLM.

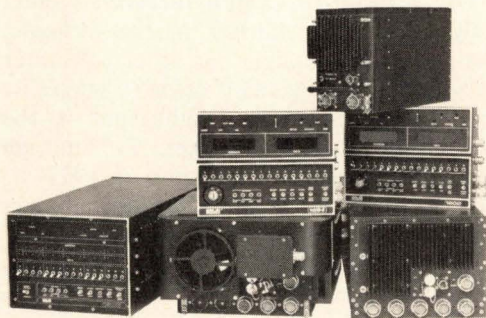

ROLM
CORPORATION

The Rugged Computer Company

Name _____ Title _____

Company _____

Address _____

City _____ State _____ Zip _____

18922 Forge Drive, Cupertino, CA 95014. (408) 257-6440
In Europe: 645 Hanau, Muehlstrasse 19, Germany, 06181 15011, TWX 418-4170.

ITALIAN ELECTRONICS MARKETS FORECAST
(IN MILLIONS OF DOLLARS)

	1975	1976	1977
Total assembled equipment	1,214	1,429	1,664
Consumer electronics	264	348	431
Communications equipment	312	356	406
Computers and related hardware	400	460	527
Industrial electronics	136	155	179
Medical electronics	47	50	60
Test and measurement equipment	33	36	38
Power supplies	22	25	29
Total components	331	398	436
Passives	149	173	191
Semiconductors	94	112	127
Tubes	84	110	114

(Exchange rate: \$1 = 875 lire)

Note: Estimates in this chart are consensus estimates of consumption of electronic equipment obtained from a survey made by *Electronics* in September and October 1976. Domestic hardware is valued at factory sales prices and imports at landed costs.

Italy's electronics to outpace economy

by Andrew Heath, McGraw-Hill World News

While Italy's World Cup skiers battle Austria's, their competition has had to share headlines at home with the crisis-ridden Italian economy, which continues to perform its own version of the downhill and slalom. Yet, in another sense, the economy is actually going nowhere. It is dragging a burdensome international debt of \$18 billion, a 1976 trade deficit of \$5.8 billion, and an inflation that is heating up to the 20% neighborhood.

Government planners have announced that, although Italy's gross domestic product will increase 21% in 1977 to \$190 billion, it will only keep pace with inflation, which is also pegged at 21% for the year. In short, unless the government and the unions come to terms on economic policy, a year of zero growth lies ahead for the Italian economy, say the planners. Still, electronics is expected to fare better this year than the economy as a whole.

For the electronics industries, the

focus of attention is the government's proposed industrial-restructuring plan. Through it, makers of components, telecommunications, computers, and other equipment see the opportunity to inject some coordination and state planning into their operations after many lean years of disordered development.

Moreover, in a "white paper" recently published by FAST (the Federation of Technical and Scientific Associations), electronics manufacturers are making known to the government their need for an electronics-industry plan and for research and development funds. To date, virtually all the R&D in Italy has been commercially financed. Electronics-industry sources say the objective is around \$230 million.

Says Enrico Villa, international sales and planning manager at SGS-Ates, who helped prepare the study, "The industry needs to know which sectors need developing. With state financing of research, funds that

companies have put to R&D could be used in other ways, rather than having to turn to the banking system for financing."

Privately, most industry sources are betting that the unions will win their showdown with the Italian government because they will maintain their wage levels and spend their way past the deflation that the planners predict for the second half of the year. That kind of reasoning, plus Italy's strong lean to the export market with products like semiconductors, telecommunications, and some business machines, leads many companies to look on 1977 as a year in which electronics will outperform the Italian economy.

Color TV ahead. One of the mainsprings of optimism is that Italy is as close to getting color-television broadcasting as it has ever been. CIPE, the government's powerful economic planning committee, has given its nod of approval to color broadcasts by RAI, the national network.

Though no date has been set for the start of colorcasting, the entertainment and components industries are moving ahead as if 1977 will be the year for color TV in Italy. Production of sets, which was nearly 600,000 in 1976, is expected to rise to 750,000 to 800,000 this year and to 1 million in 1978. The industry exported approximately 75% of its production in 1975 and 50% last year. Exports are expected to reach the same level in 1977. Italy's TV manufacturers are aiming at a larger share of the small-screen (up to 20 inches) color market.

Semiconductors for export. *Electronics'* survey pinpoints the Italian components market for 1977 at \$435.7 million, up 9.5% from 1976, with semiconductors at \$126.8 million, up 13%. Manufacturers predict a fair, if lackluster, market at home, buoyed mainly on the consumer side—especially if color TV makes its entry. Another bright spot is the electric-organ market: \$17 million worth of semiconductors in 1977.

For the Western European markets, Italians foresee an average 12% growth. But for most Italian companies, neither Italy nor Western

Now from Amperex— a group of high-performance, 4- and 5-GHz PNP's at prices between \$2.40 and \$3.15.

The ever-growing Amperex line of high-performance, economical, small-signal GHz transistors now opens up still more design possibilities in the GHz region. These six new low-noise PNP's offer the key to both new and retrofit/upgraded circuits for portable pagers and transceivers... for high bit rate communications gear... for high frequency spectrum analyzers and oscilloscopes... for counters... and for CATV/MATV amplifiers.

Like their NPN complements, the six new PNP's have f_T of 4- or 5-GHz at I_C 's from 14 to 30 mA and offer high linearity and low noise; they provide maximum available gain as high as 19 dB. Two of them, the BFR92 and the BFR93 are in the new SOT-23 microminiature plastic

package for high frequency hybrid circuit applications. There's simply nothing else like them available at anything like our prices anywhere else today. For



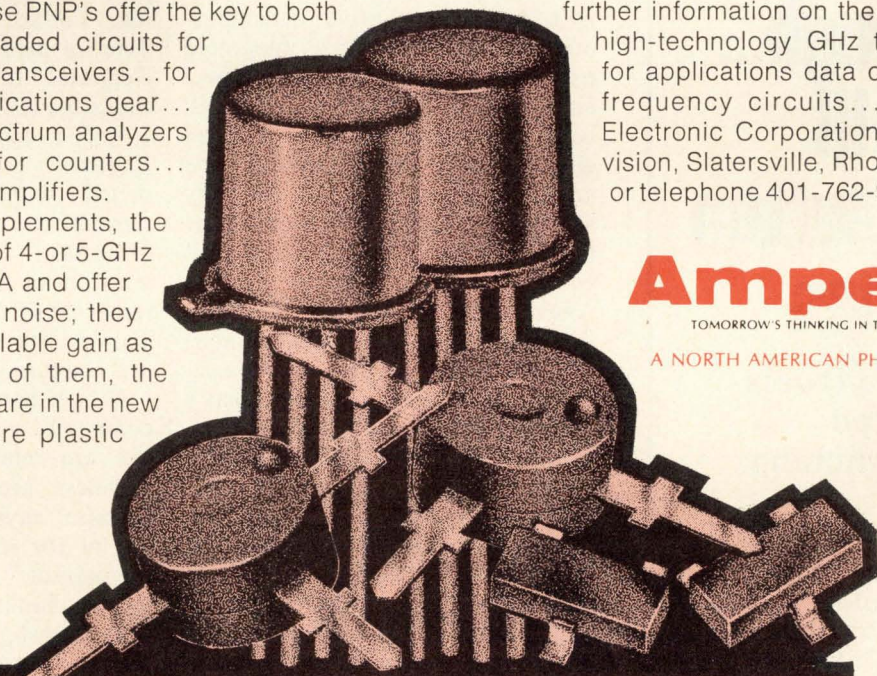



further information on the Amperex line of high-technology GHz transistors... and for applications data on PNP's in high frequency circuits... write Amperex Electronic Corporation, Slatersville Division, Slatersville, Rhode Island 02876, or telephone 401-762-9000.



Amperex®

TOMORROW'S THINKING IN TODAY'S PRODUCTS

A NORTH AMERICAN PHILIPS COMPANY

COMPLEMENTARY PAIRS FOR GHz APPLICATIONS				
New PNP Types			Complementary NPN Types	
TYPE	FEATURES	PRICE*	TYPE	PRICE*
A440 (TO-72) 	f_T ... 5 GHz @ 14 mA NF ... 2.3 dB @ 200 MHz G_{max} ... 18 dB @ 500 MHz	\$2.40	A400 (TO-72)	\$1.65
A441 (TO-72) 	f_T ... 5 GHz @ 30 mA NF ... 2.4 dB @ 200 MHz G_{max} ... 14 dB @ 500 MHz	\$2.65	A401 (TO-72)	\$1.75
ON586 (SOT-37) 	f_T ... 5 GHz @ 14 mA NF ... 2.5 dB @ 500 MHz G_{max} ... 19 dB @ 500 MHz	\$2.85	BFR90 (SOT-37)	\$2.25
BFQ23 (SOT-37) 	f_T ... 5 GHz @ 30 mA NF ... 2.4 dB @ 500 MHz G_{max} ... 15 dB @ 500 MHz	\$3.15	BFR91 (SOT-37)	\$2.45
BFT92 (SOT-23) 	f_T ... 4 GHz @ 14 mA NF ... 2.7 dB @ 500 MHz G_{max} ... 17.5 dB @ 500 MHz	\$2.53	BFR92 (SOT-23)	\$2.30
BFT93 (SOT-23) 	f_T ... 4 GHz @ 30 mA NF ... 2.4 dB @ 500 MHz G_{max} ... 15.5 dB @ 500 MHz	\$2.70	BFR93 (SOT-23)	\$2.45

*In 1000 piece quantities

Custom designs
or off-the-shelf...

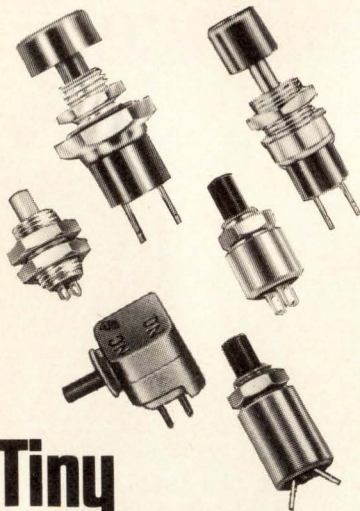

Tiny but tough... Grayhill push-button switches

from logic levels
to UL-listed
power switching

- As small as .250" diameter, .675" over-all length
- Wiping or butt contacts; momentary or alternate action; SPST, SPDT, DPDT
- Bezel, bushing, or sub-panel mounting, variety of button colors and shapes

There's a wide range of options in the Grayhill miniature push-button switch line, but all offer high reliability over a long life span. Off-the-shelf availability of standard types is augmented by a superior custom design capability for unusual circuitry, environmental, usage, or size requirements. For details, consult EEM or write for free literature from Grayhill, Inc., 561 Hillgrove Avenue, La Grange, Illinois 60525, Phone (312) 354-1040



Probing the news

Europe is where the best growth potential lies these days. Aldo Toscano, SGS-Ates' international marketing director, explains that his company will be pushing its semiconductors harder into the United States, Latin American, and Far Eastern markets in 1977. "Only 30% of our sales are in Italy, and in Europe, we have a penetration that would be costly to improve. We'll follow the growth of the European markets, but we expect to double our penetration of the U.S. and Far East markets."

SGS-Ates, Italy's major semiconductor maker, plans to broach the U.S. market mainly with the company's more innovative consumer-oriented products, such as integrated circuits for TV sets, car radios, power amplifiers for portable and citizens' band radios, and MOS electric-organ circuits, such as the rhythm and arpeggio generators. The company also plans to enter the U.S. computer market through the clients that it already has in Europe. In Latin America and the Far East, SGS-Ates will mainly tap the consumer market, although the telecommunications market in Latin America has a potential for products like the company's channel amplifier and channel modulator.

Looking abroad. For telecommunications manufacturers too, the export market appears to be the best bet in 1977. As in other countries, thanks to hearty spending by state telephone agencies, telecommunications has for years thrived in Italy while other areas languished. However, in recent years, installation of electronic switching has not moved ahead fast: the target set at the end of 1973 of 950,000 new subscriber lines per year has not been met. Says one manufacturer: "The number of new lines depends on the availability of funds, and, although SIP [the state-owned phone company] has raised telephone rates, the traffic has been dropped back. Add inflation, the high unit cost of labor in Italy, and the lack of capital, and the future looks somewhat obscure." *Electronics* estimates the Italian telecommunications market at \$400.4 million, up 12.5% from 1976.

The rate of gloom, though, is proportional to each manufacturer's dependence on the domestic market. A big firm like SIT Siemens, with 50% of the Italian market, will push exports hard. On the other hand, Telettra, with a small domestic share, already is in 50 countries.

The 25% fall in the value of the lira in 1976 bore some fruit for Italy's telecommunications companies, as it did for those in other sectors, and the advantages will continue to be felt in 1977. "However," says Mastalli, "we import many components from the dollar and mark areas. We also suffer when the lira falls and have to pass this burden along in our pricing." For the Italian market in 1977, Telettra plans to install in Turin an electronic time-division-multiplexed exchange to be named Sintel.

Italy's computer market, which *Electronics* estimates will rise 14.6% in 1977 to \$526.6 million, is behind those of the other industrial nations of Europe. "That," says Mario Speranza, head of Honeywell's market research in Italy, "is its strength. The less mature a market, the more it is immune to economic trends."

While bank accounts of Italy's communes and other local authorities are relatively lean, they nevertheless are fair sales prospects because, says Speranza, "they are one of the least mature sections of the market."

The banks, whose liquidity is limited to slightly over 40% of deposits, are investing well in the development of existing systems. Honeywell estimates the bank market grew at an annual 18% over the last two years and expects the trend to continue.

Interest a millstone. Overall, Italy's computer manufacturers and distributors estimate that 1977 will be a positive year. What could slow the market is the cost of money and its availability, since 80% of the computers in Italy are rented. Says Speranza: "With bank interest at over 20%, we have a financing problem. In 1975, interest payments were over \$9 million on sales of \$100 million. If we could halve that, we could put \$4.5 million to sales development or to R&D." □

WE'RE WARNING YOU...

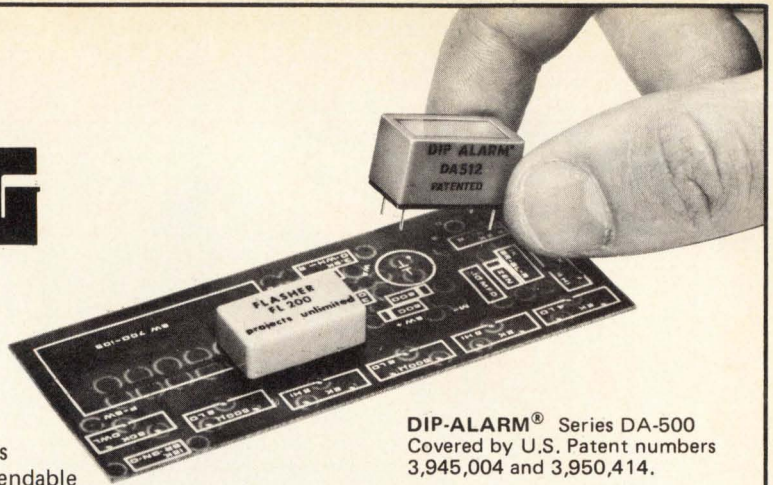

... this unique, miniature solid state sound device has unlimited applications. Plugs into 16 pin DIP sockets or PC boards. Rugged, reliable, loud. Models for 3, 5 and 12 vdc, 35 mA maximum current. Dependable solid state construction means no mechanical contacts, no arcing, no RF noise. 76 dbA at 400 Hz tone radiates in all directions for positive alarm, warning, fault detection.

DIP-ALARM® Series DA-500
Covered by U.S. Patent numbers
3,945,004 and 3,950,414.

Use in conjunction with
DIP-FLASH® Series FL-200
for pulsing operation.

Where to buy an audio indicator for every need:



3680 Wyse Road, Dayton, Ohio 45414
Tel. (513) 890-1918, TWX 810-450-2523

Distributorships and sales territories available.

CALIFORNIA, COSTA MESA
Mar Vac Electronics

COLORADO, DENVER
Waco Electronics Inc.

MASSACHUSETTS, SHARON
Adcour

MICHIGAN, FARMINGTON
CMP Distributor Co.

MISSOURI, ST. LOUIS
Olive Industrial Elec.

NEW YORK, ROCHESTER
Ossmann Component Sales

OHIO, CLEVELAND
CMP Distributor Co.

**OHIO, CINCINNATI
COLUMBUS**
Hughes Peters, Inc.

TEXAS, DALLAS
K. A. Electronic Sales

UTAH, SALT LAKE
Newark Electronics

WASHINGTON, SEATTLE
Frank Jackson & Associates

WISCONSIN, MILWAUKEE
Taylor Electric Co.

B. C., VANCOUVER
Deskin Sales Corp.

ONTARIO, TORONTO
Deskin Sales Corp.

ONTARIO, WILLOWDALE
Electro Sonic, Inc.

QUEBEC, MONTREAL
Deskin Sales Corp.

Circle 85 on reader service card

A/D and D/A Converters... Call the Can-Do Company



CPS specializes in medium-to-high resolution and fast settling time devices for data acquisition, instrumentation, process control and many other signal converter applications where product reliability is a must.

CPS function modules are backed by more than eight years of know-how in producing standard or custom high-technology products which are tailored for specific OEM industrial or

Mil-Spec needs. And we've solved a lot of engineering design problems that others tend to stay away from.

Our production capability is backed by a stringent QC program which ensures a quality product along with on-time delivery schedules.

Call or write CPS, the "Can-Do" company, for the economical answer to your signal converter requirements.

CPS INC.
CYCON

722 E. Evelyn Avenue
Sunnyvale, California 94086
Phone (408) 738-0530 Telex 357-450

Electronics / February 3, 1977

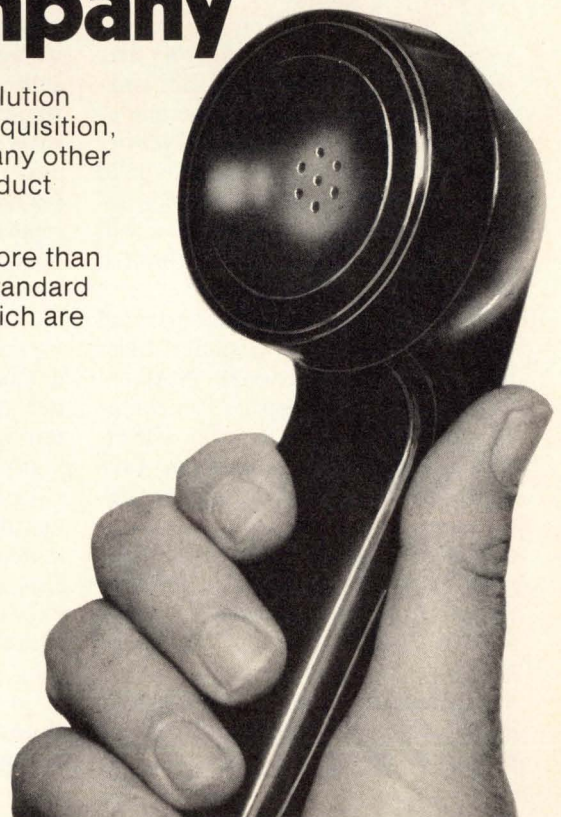

Circle 184 on reader service card

85



Here comes the watch/calculator

by Bernard Cole, San Francisco bureau manager

Don't be surprised if, by the end of this year, the top-of-the-line digital watch and calculator become one and the same—an expensive watch/calculator combination.

The hybrid products will not, however, be as costly as the first model that appeared on the market about a year ago—the \$1,000 five-function unit with light-emitting-diode display that a Japanese manufacturer built for Pulsar. Neither will they be as expensive as the \$500 to \$700 ones marketed last Christmas by Pulsar and Uranus. Nor will this newest generation be as limited in terms of functions.

A bellwether was demonstrated this month at the Consumer Electronics show in Chicago by National Semiconductor Corp.'s Consumer Products division, Santa Clara, Calif. The 20-to-25-function, full-capability watch/scientific calculator has only a six-digit liquid-crystal display, but can present a 12-digit readout in two parts. It will retail to the jewelry-store customer for \$200 to \$350, depending on the retail markup.

Competitors. But that's not all. At least four electronics companies are poised to plunge into the market,

and several digital-watch merchandisers are already offering combinations for less than \$500. Hughes Aircraft Co.'s Solid State Products division, Newport Beach, Calif., is producing an eight-function, complementary-MOS module to operate with LED displays. National, through its Semiconductor division, is also selling C-MOS-based watch/scientific-calculator chips and modules with six-digit liquid-crystal displays and is at work on eight-digit versions. Hewlett-Packard Co. is reported to be developing a combination based on a custom C-MOS chip designed by American Microsystems Inc. Moreover, AMI, Intel Corp., and Harris Semiconductor have announced processor-like watch chips, but to date, they have focused on multifunction chronographs for the high-end digital watch market.

Eric McCleod, National Semiconductor's watch/calculator design manager, comments: "The high-end digital watch is basically a piece of jewelry. The way you get value added to your product in that market is by adding features. The advantage of a ROM/RAM-based processor architecture is that you can add or change features with little additional

Time and total. Module from Hughes features 8-digit display for nine-function calculator and four-function watch.

processing cost. What is involved is basically a change in programming." The multifunction chronograph units built by Intel and AMI represent what can be done at one extreme, says McCleod, and National's watch/calculator chip holds down the opposite end.

Variations. Between these extremes, numerous variations exist "and we'll see them all," says McCleod, "if not from one of the major digital-watch and calculator makers, then from one of dozens of entrepreneurs and assemblers." Other products being considered include true-timing computers in which the calculator, in addition to timekeeping, performs manipulations such as storing dates, calculating past dates, converting days, hours, minutes, seconds in increments down to nanoseconds, and calculating time-zone differences.

Other kinds of sophisticated 20-to-25-function watch/calculator combinations are also being considered. One provides financial notation, and another is devoted exclu-

sively to metric conversions. Another type is the wrist calculator, which has no timing capability, but has more memory and added computing capability. Eventually, say a number of company executives, limited-function watch/calculators of the Pulsar checkbook type should be available for about \$100, "if not this year," says one executive, "then, at the very least, by the middle of '78—in time for Christmas."

The technology that makes this possible also runs the gamut. Pulsar uses an 8-to-10-chip C-MOS hybrid combination, although the chip count of more recent units has been reduced to four to six. Hughes modules are based on a three-chip design—two for calculator functions and one for timing. National uses a two-chip C-MOS design borrowed directly from its p-channel MOS calculator-oriented processor designs. Containing 16 kilobits of read-only memory and 384 bits of random-access memory as well as a 4-bit binary adder to handle arithmetic and logic functions, a 32,000-bit countdown chain provides a 1-hertz program-controlled interrupt function for timekeeping. The device, which operates from a 3-volt supply, has a voltage doubler on chip to provide 5-v switching for the direct-drive liquid-crystal display.

Adaptations. The HP calculator/watch is a one-chip custom C-MOS design somewhat similar to what AMI uses in its standard programmable watch chip, which itself uses an architecture developed for one of the company's calculator chips. However, neither company is revealing any details.

All these watch/calculator designs have produced a fallout of all-C-MOS calculators that carry the concept of nonvolatility one step further. "The closest the industry has come so far to nonvolatility," says McCleod, "is in higher-end calculators where C-MOS memory uses a trickle charge from the battery to retain information when the calculator is turned off." What happens, he asks, when the battery goes dead? One executive predicts that all-C-MOS designs will allow calculators—priced both over \$100 and under \$20—to operate from a set of batteries for a year or more. □

A NEW GENERATION OF IMAGE SENSORS

SIMPLICITY OF USE

Requiring less than a dollars worth of circuitry to drive—and barely more than that for video processing—is just one of the key features of our new "G" series image sensors. Compare the non-critical single TTL clock needed for the "G" device to the complex multi-phase clocks prescribed by others.

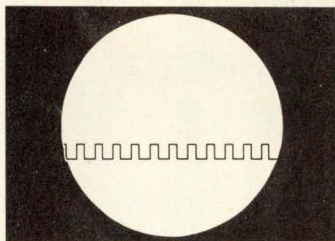

You need only this for Reticon

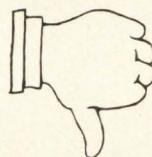
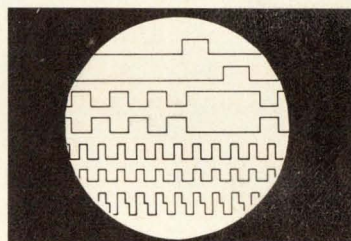

You need all these for others

HALF THE PRICE

Or even less will bring you 256, 512, 768, or 1024 sensor elements on 25 μ centers or up to 1728 elements on 15 μ centers in our "H" series.

SUPERIOR PERFORMANCE

Low dark current allowing low light level operation, on-chip noise cancellation, and smooth spectral response from visible through infrared makes this new generation the unquestionable choice.

APPLICATIONS

Page readers, facsimile, OCR, point of sale readers, non-contact measurements and inspection and many others.

RETICON®

910 Benicia Avenue, Sunnyvale, California 94086
PHONE: (408) 738-4266 TWX: 910-339-9343

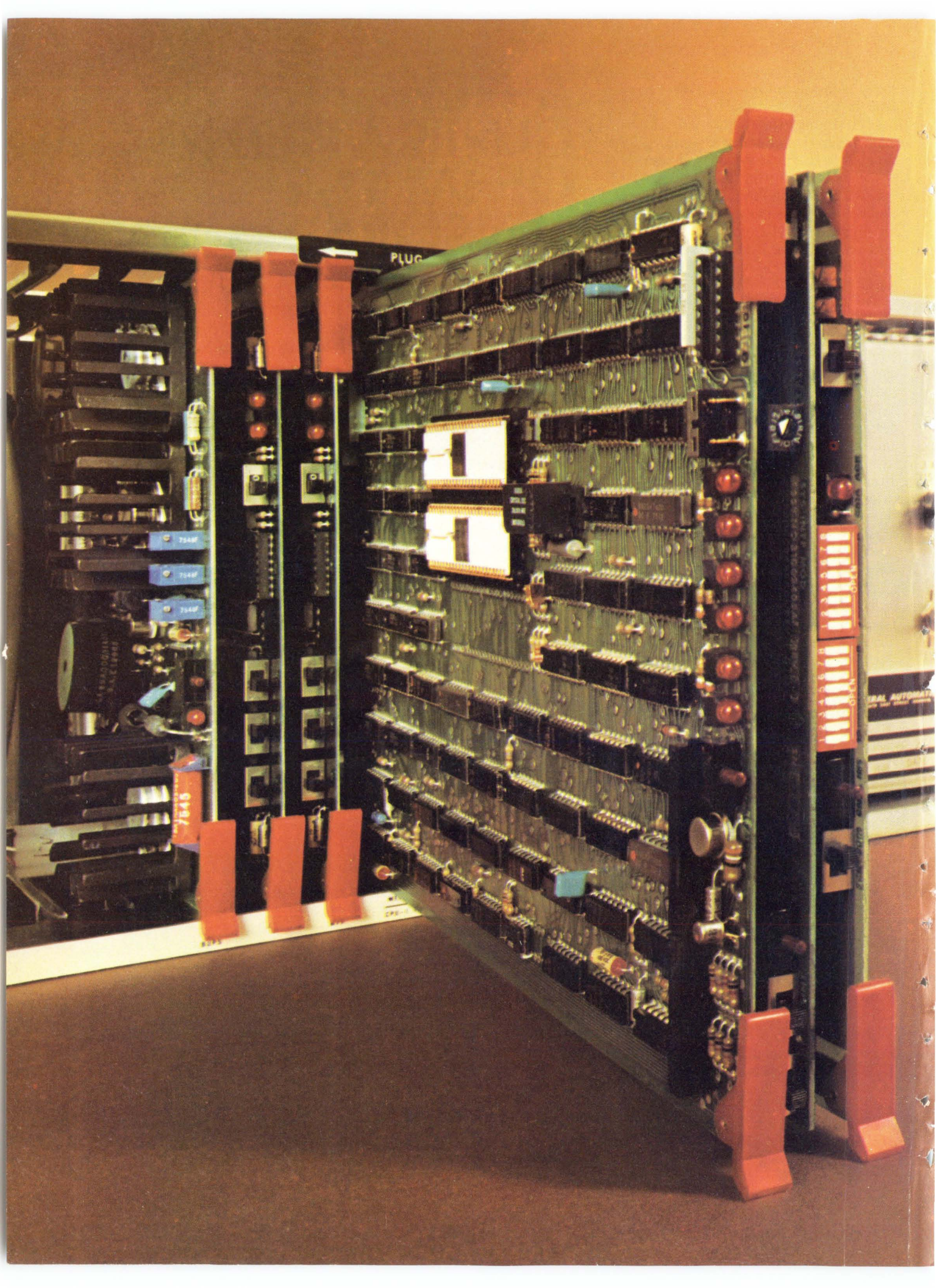

GA counts in microcomputing.

There's not a machine that can touch GA's 220. Not from DEC, Data General, or anywhere else.

- 1. The only μ C with COBOL, FORTRAN and in-depth software support.**
- 2. The only μ C with a full file management system.**
- 3. The only μ C to offer OEMs a wide choice of operating systems:** like FSOS, DBOS, RTX, RTOS.
- 4. The broadest μ C instruction repertoire:** speeds program development, conserves memory, accelerates execution.
- 5. The only μ C that can handle big disks:** I/O rate is 2.0 mB/second.
- 6. The fastest μ C:** LDR/STR (indexed) 2.6 μ s.
- 7. The only μ C with parity built-in:** hardware test, verification, fault isolation, plus write protect.
- 8. The only μ C with a back-up power supply built-in:** protects semiconductor memory from power failures.
- 9. The only μ C with board-level operator controls, switches and displays:** in a microconsole.
- 10. The only μ C with over 100 field-proven I/O controllers.**

GENERAL AUTOMATION

A big break for OEMs: family compatibility, throughout General Automation's extensive micro/mini line, gives GA-16/220 instant access to multiple batch and real-time operating systems, and to software off-the-shelf.

- Rush me full details on GA-16/220 μ C capabilities.
- Contact me for immediate requirements.

Name _____

Title _____

Phone _____ Ext _____

Clip coupon to company letterhead and send to General Automation, 1055 South East Street, Anaheim, CA 92803. Or call (714) 778-4800.

E3

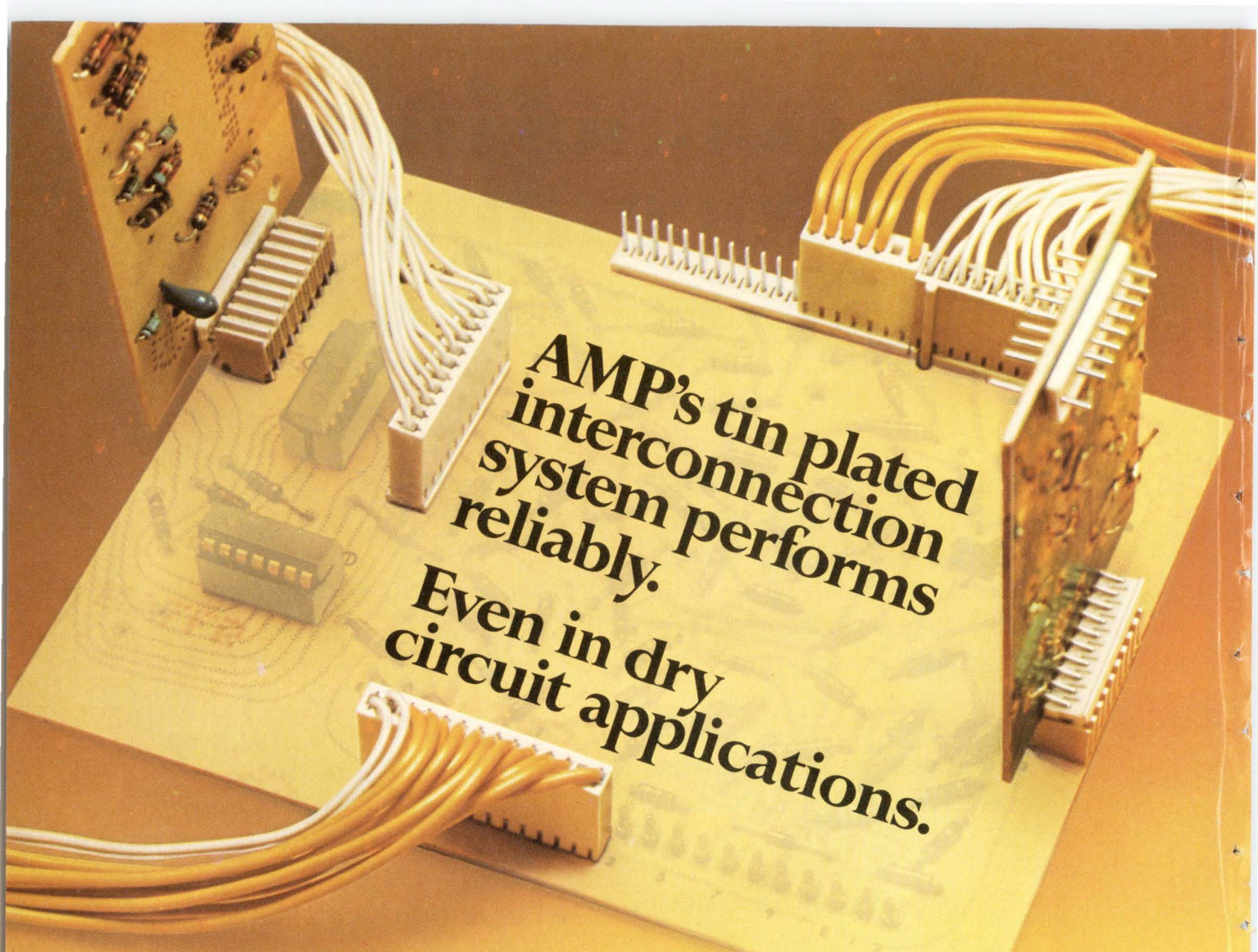

**AMP's tin plated
interconnection
system performs
reliably.
Even in dry
circuit applications.**

Because our Commercial Interconnection System (CIS) features a unique, high pressure, redundant, metal-to-metal contact design, tin plating can be used instead of gold. A choice of fork-to-contacts provides mating forces from 400 to 1,000 grams for maximum application flexibility. And the posts assure positive wiping action for clean contacts and extended stability.

AMP CIS also helps you save on materials other than gold. You can use wider tolerance pc boards because CIS is a two-piece system that assures reliable connections even when boards are warped or bowed.

Receptacle assemblies are designed for fast, easy soldering to boards without need for tooling. And boards can be mated from top, bottom or sides for full packaging versatility. Posts, straight or right-angled, are available for gang insertion, for machine application and in pin headers, to serve any volume efficiently.

The entire System is available on 0.100" and 0.150" centers, with or without polarization features, for full compatibility with today's new generation of components. And that can mean lower costs from initial design right through final production.

There are more reasons for using AMP's tin plated Commercial Interconnection System, including AMP backup, whenever you need it. So why not call AMP Customer Service and find out more about CIS. Just dial (717) 564-0100 or write AMP Incorporated, Harrisburg, PA 17105.

AMP has a better way.

AMP
INCORPORATED

SPECIAL REPORT

Powering up with linear ICs

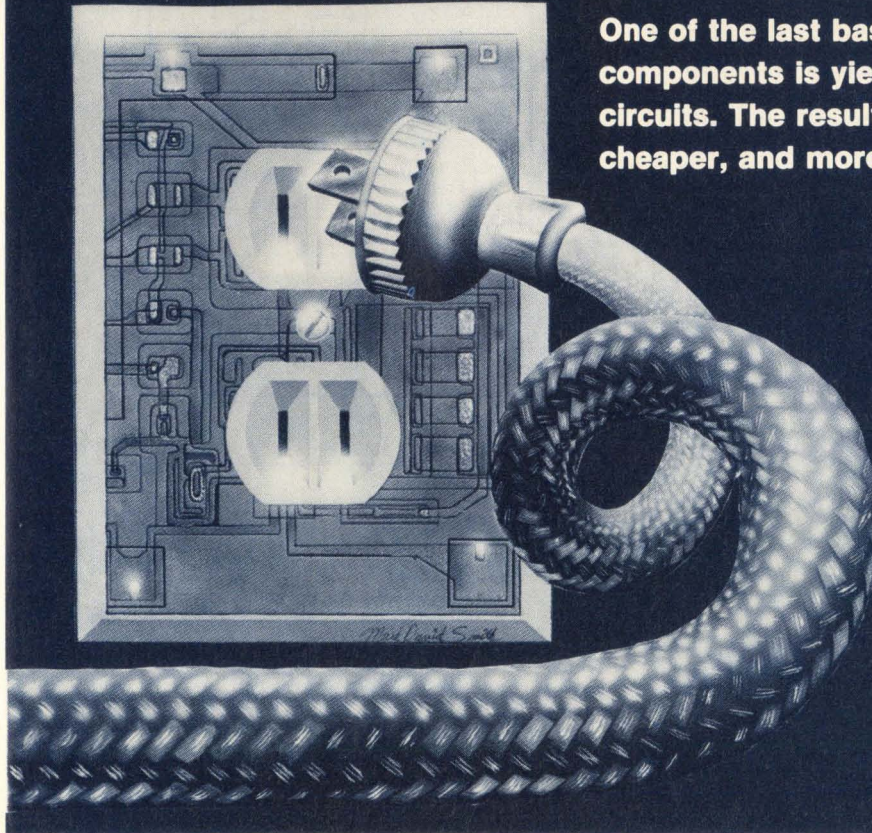

One of the last bastions of discrete components is yielding to integrated circuits. The result, for designers, is simpler, cheaper, and more reliable power supplies.

by Lucinda Mattera, *Components Editor*

Power supplies, the lifeline of electronics, are finally falling under the influence of integrated circuits, and already the field is showing signs of the kinds of changes that surged through analog and digital signal processing in the wake of circuit integration. Switching supplies are suddenly becoming a lot easier to design, and ultrastable voltage references need no longer mean anguished trial-and-error design sessions.

Both developments stem from the increasing use of linear ICs to build power supplies. Besides resulting in units that are smaller, cheaper, and more reliable than those built with discrete components, ICs also simplify their design—a crucial factor in the growth of both switching supplies and ultrastable reference circuits. Performance, too, is frequently just as good as that delivered by supplies built with discrete parts.

Since most power-supply ICs serve as control devices or as sources of a regulated dc voltage, they still require one or more external power transistors for current boosting. But output currents are getting higher, and the near future will bring monolithic regulators that can deliver several amperes of current at a tightly regulated stable dc voltage.

Even within the last year, new classes of these devices have emerged, including conveniently adjustable versions

of inexpensive three-terminal voltage regulators and large-scale ICs, which replace from 20 to 40 discrete parts for controlling switching-mode power supplies. And the next generation of devices is promising both better performance and more applications flexibility.

The switching trend

Not so long ago, switching-regulated power supplies were used only when power levels had to be 500 watts or higher. Below that level the series-regulated supplies prevailed. Unlike series-regulated units, switching supplies involve complex control circuitry and require special filters and shields for low-noise operation. However, they offer high power density as well as high efficiencies, usually on the order of 80% to 90%, whereas the simpler series-regulated units are bulky and relatively inefficient. (For a more detailed review of these two power-supply techniques, see "Brushing up on linears and switchers," p. 93.)

What has recently brought the switching supplies into their own has been the availability of switching power transistors capable of handling many peak watts of power at frequencies of 20 kilohertz or higher. Now that such devices are being sold for attractively low prices, the power-rating crossover point for choosing either a

switching or a series supply has dropped—to approximately 100 watts.

That 100-w boundary may drop even lower, with the advent of monolithic chips for directly controlling the switching power transistors. But even with the crossover at 100 w, switching supplies are being widely used in computers, communications and aircraft equipment, and a variety of other applications where their combination of efficiency and small size and weight is essential.

Still, in terms of sheer numbers, switching supplies are nowhere near ousting series-pass regulators from their No. 1 position. As a result, monolithic versions of series-pass regulators continue to be the best-selling of all power-supply ICs. They encompass both positive-output and negative output regulators, in either fixed-value or adjustable versions, as well as dual-output tracking units.

Most of today's power-supply ICs fall into this or the switching category. A third category, the voltage references, are strictly speaking not power devices at all, but rather are stable sources of a fixed dc voltage. They provide output voltages accurate to within tens of millivolts and excellent stability with both time and temperature—characteristics in great demand for instruments, as well as analog-to-digital and d-a data converters.

Controls for switching supplies gain in popularity

The half-dozen versions of IC controls for switching supplies at present in production are none of them more than 15 months old, so new is the field. Yet already two semiconductor manufacturers—Texas Instruments in the U.S. and Sescosem in France—are promising new models that will give their users more freedom in designing with them.

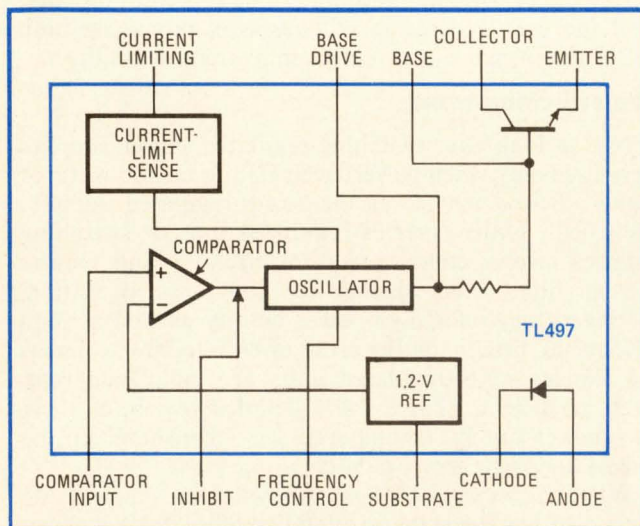

1. Single-ended control. Monolithic switching regulator from Texas Instruments includes its own oscillator, voltage reference, and protection circuitry. With its output of 35 V at 500 mA, the device is primarily aimed at voltage-conversion systems applications.

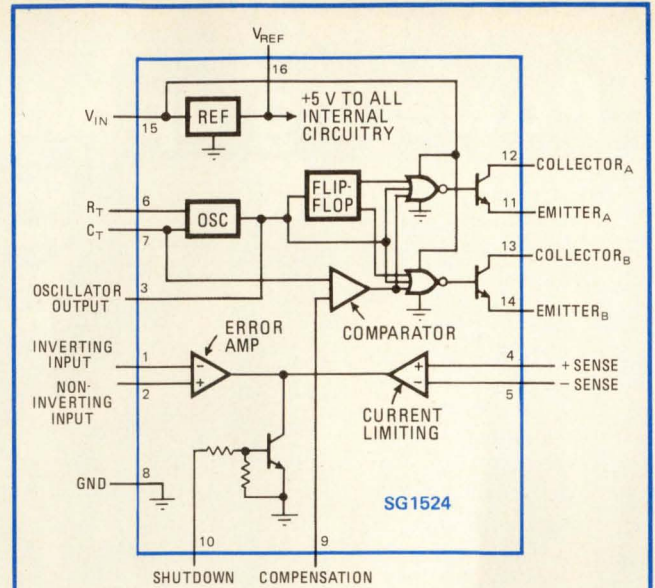

(a)

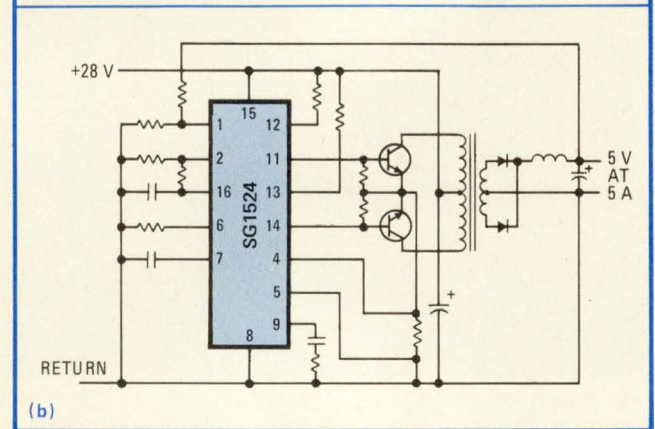

(b)

2. Double-ended control. Because of its dual alternating output switches, this regulating pulse-width modulator (a) from Silicon General can be used for push-pull control of switching supplies. Additionally, it can operate as a dc-dc converter (b).

Existing products (four in the U.S., two in Europe) replace anywhere from 20 to 40 discrete components and put varied assortments of functions on chip. But all contain pulse-width-modulated driver transistors and some kind of voltage reference, and most include an oscillator, error amplifier and on-chip protection.

In the U.S., Texas Instruments Inc. of Dallas was the first to build a monolithic switching-regulator control, announcing its TL497 chip last April. The TI device (Fig. 1) is a fixed-on-time variable-frequency regulator with on-chip shutdown circuitry, current limiting, and an internal reference. Intended for single-ended operation, it requires only a minimum of external parts—two resistors, one capacitor, and an inductor—to produce a supply from an unregulated input. It delivers an output of 35 v at 500 milliamperes.

Voltage-conversion applications are where the TL497 should do best. They are common in transistor-transistor-logic systems where a voltage other than 5 v may be needed for metal-oxide-semiconductor memories, emitter-coupled logic, microprocessors, operational

Brushing up on linears and switchers

At ratings of up to 500 watts, most power supplies are either series-pass-regulated or switching-regulated designs, both of which can take advantage of the convenience of power-supply integrated circuits. These two power-supply design techniques differ significantly in configuration and performance.

With the linear or series-pass supply (a), the ac line voltage passes through a 60-hertz transformer before being rectified, filtered, and regulated by a pass element. This element is usually a series-connected transistor that operates in its active region, varying its voltage drop to keep the output voltage at a constant level.

However, with the switching supply (b), the ac line voltage is generally rectified immediately, chopped up into a regulated dc voltage with a duty-cycle-modulated switching element, and only then stepped down (or up) by a high-frequency transformer. Then it is rectified again and filtered. As a rule, the regulating element is a transistor, which switches between its saturation and cutoff regions of operation.

Because the linear supply is basically a 60-Hz system, it requires fairly bulky transformers and filter components. The switching supply, on the other hand, operates at frequencies of 1 to 100 kilohertz, so its transformers and filter components need not be nearly as large or heavy.

Also, power losses are much higher for the linear supply, because of the continuous operation of the series-

pass regulating transistor in its active region. So it is hardly a surprise that its power efficiency is a relatively poor 10% to around 50%. In the switching supply, though, the regulating transistor is either saturated or cutoff. Power losses are held to a minimum, and power efficiency is very good, ranging anywhere from approximately 60% to better than 90%.

However, the switching supply does not win hands down. Its fairly complex circuitry pushes its cost up to a prohibitive level for power ratings below 100 W, just the region where the comparatively simple series supply provides the best economics.

Furthermore, there are performance parameters as important as efficiency, and in these respects the series supply shines. It provides the lower ripple and noise and can deliver somewhat tighter regulation. In fact, because of its fairly high switching frequency, the switching supply may be troubled not only by noise on its output but also by noise induced or conducted into the ac input lines.

The series supply also has a faster transient response—faster by a factor of 10 or greater. Briefly, the transient response is the time required for the output voltage to return within its regulation limits when there is an abrupt change in either the line voltage or load current.

All things considered, then, the designer must analyze his system needs carefully before choosing either a series or a switching supply.

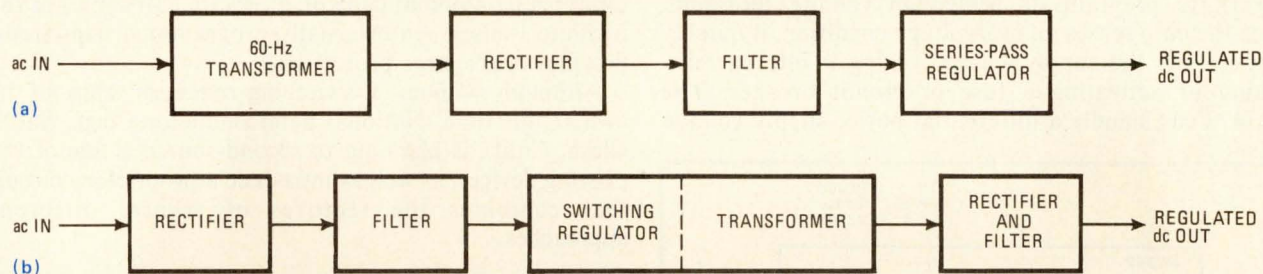

amplifiers, or comparators. But the device can be used in the reverse direction, as it were, in battery-powered systems, like automobiles, or in communications and remote equipment that use TTL circuitry.

Not to be outdone, Silicon General Inc., Westminster, Calif., quickly followed TI with a device of its own—the SG1524, which can be used in push-pull as well as single-ended configurations. Besides its obvious usefulness for switching regulators of either polarity, the SG1524 can serve in transformer-coupled dc-to-dc converters, transformerless voltage doublers, and polarity converters.

On the 75-by-80-mil chip (Fig. 2a) are the inevitable voltage reference, plus an error amplifier, oscillator, pulse-width modulator, pulse-steering flip-flop, and dual alternating switches. Current-limiting and shutdown circuitry are also on chip. The device can operate at frequencies above 100 kilohertz, and it provides line and load regulation to within 0.2%. From an input voltage of up to 40 V at 10 mA maximum, it develops alternating 5-V outputs of up to 100 mA. In the circuit of Fig. 2b, the chip is being used in its push-pull operating mode for a

transformer-coupled dc-dc regulating converter that produces 5 V at 5 A from a 28-V line input.

TI is now gearing up to second-source Silicon General's SG1524. But, according to TI, the 1524's major limitation is the very restricted common-mode input voltage range of the current-limiting sense amplifier. So TI expects to have a third-generation part out this year that will have a current-limiting sense amplifier operable from both the positive rail and from above the positive rail and that, in general, will embody "the best of what's available in switching regulators now."

From Motorola Semiconductor Products Inc., Phoenix, Ariz., comes yet a third version of a monolithic switching control, the MC3420, which the firm is labeling an inverter control circuit. It can be used for pulse-width-modulated push-pull, bridge, and series-type switched-mode power supplies. The device (Fig. 3) includes an on-chip voltage reference and dead-time comparator plus a 100-kHz symmetrical oscillator, a modulator, and a phase splitter.

Output frequency can be varied from 2 to 100 kHz, and both operating frequency and dead time are inde-

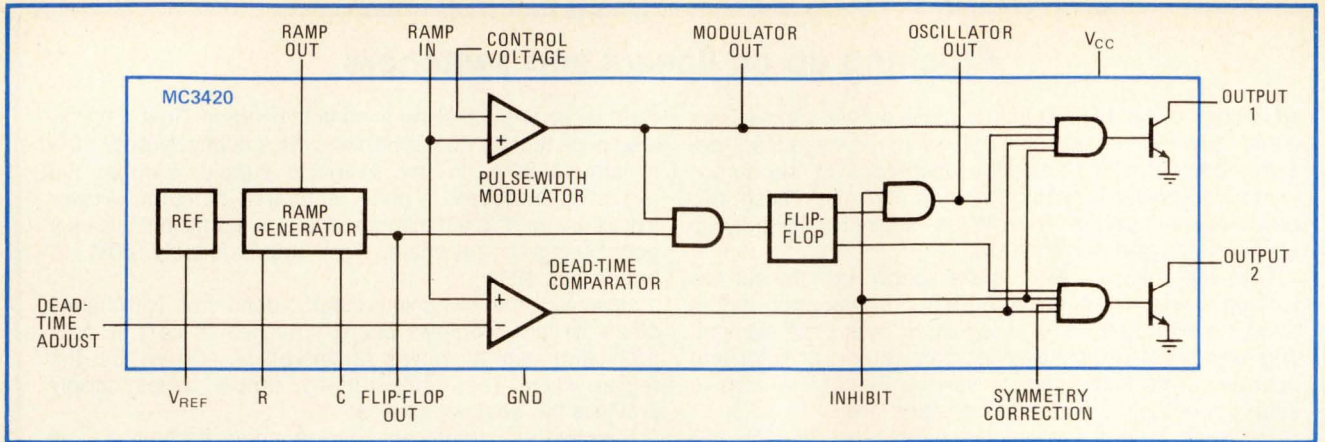

3. With soft-start. Motorola's inverter control circuit has an internal dead-time comparator to avoid transistor overlap at its output. There is also a controlled start-up feature, as well as protection against double pulsing during a load transient condition.

pendently adjustable. The unit's open-collector output delivers up to 50 mA from an input voltage of 10 to 30 v at 16 mA maximum. Moreover, the device has a controlled start-up feature, as well as on-chip protection against double pulsing of the same output during a load transient condition.

(Incidentally, Motorola is also making a monolithic overvoltage sensing circuit, MC3423. Introduced just this past fall, the device requires an external "crowbar" silicon controlled rectifier, plus an appropriate resistor network to program its protection voltage threshold. When the chip senses an overvoltage condition, it quickly short-circuits the supply, either forcing it into current-limiting or activating a fuse or circuit breaker. The MC3423 can handle a differential power-supply voltage

of 45 v, and it has an output of 3 v at 300 mA.)

Lastly, Plessey Semiconductors, Irvine, Calif., has a proprietary control circuit for either series or parallel switching supplies and inverters. The SL442 power-supply control (Fig. 4) has a soft-start capability that allows its output voltage to increase at a predetermined rate to the required level. There is also an on-chip oscillator, the frequency of which is set externally, and the option of phase-locked control for external synchronization. Current limiting is dynamic, with the current limiter reset automatically on alternate half cycles of the oscillator pulses. An externally programmed trip circuit provides overvoltage protection.

Although without a switching-regulator chip of its own at this time, National Semiconductor Corp., Santa Clara, Calif., is planning to second-source a few of the existing devices, as well as introduce a proprietary circuit that combines the features of several different approaches.

European makers offer their own designs

In Europe, switching supplies are also hot. Indeed, England's Ferranti may be said to have beaten TI to the draw, having introduced its device, the ZN1066E, as early as December of 1975.

The chip is made with the firm's collector-diffusion-isolation technology, a bipolar epitaxial process that gives a packing density almost as good as that of MOS and uses only a third the chip area of comparable TTL circuits, says Ferranti.

Onto the 85-mil-square chip, Ferranti packs a shunt regulator, a series regulator, an oscillator, a ramp generator, a comparator, steering-function circuitry, two pairs of push-pull transistor outputs, and two amplifiers. The ZN1066E typically needs fewer than 20 external components to control up to 100 watts. The device can be switched on and off at a frequency of between 20 and 30 kHz. When operated in a push-pull configuration, it develops an output current of 60 mA typical. Also, the chip provides automatic protection against transistor overlap.

In the Netherlands, the Elcoma division of Philips is already making its monolithic control for switching supplies, the TDA1060. Besides a temperature-

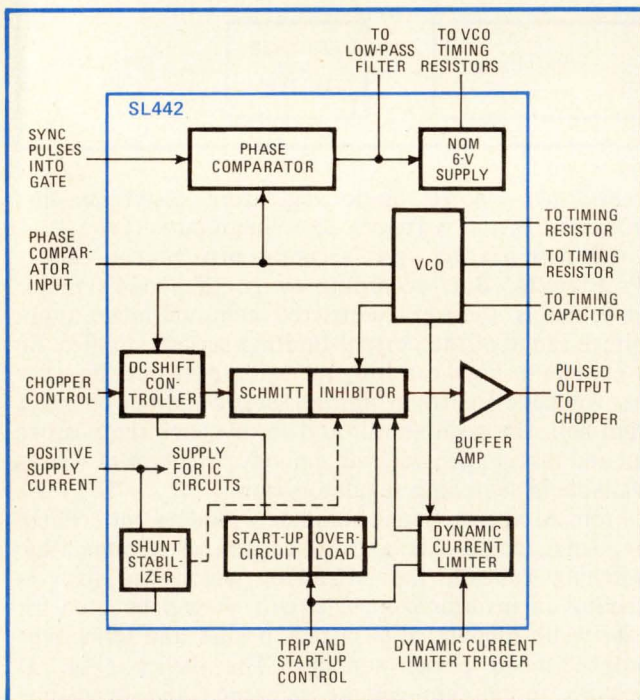

4. Dynamic current limiting. Besides soft-start capability, Plessey's switching-regulator control circuit offers dynamic current limiting—that is, the on-chip current limiter is reset automatically on alternate half cycles of the oscillator pulses.

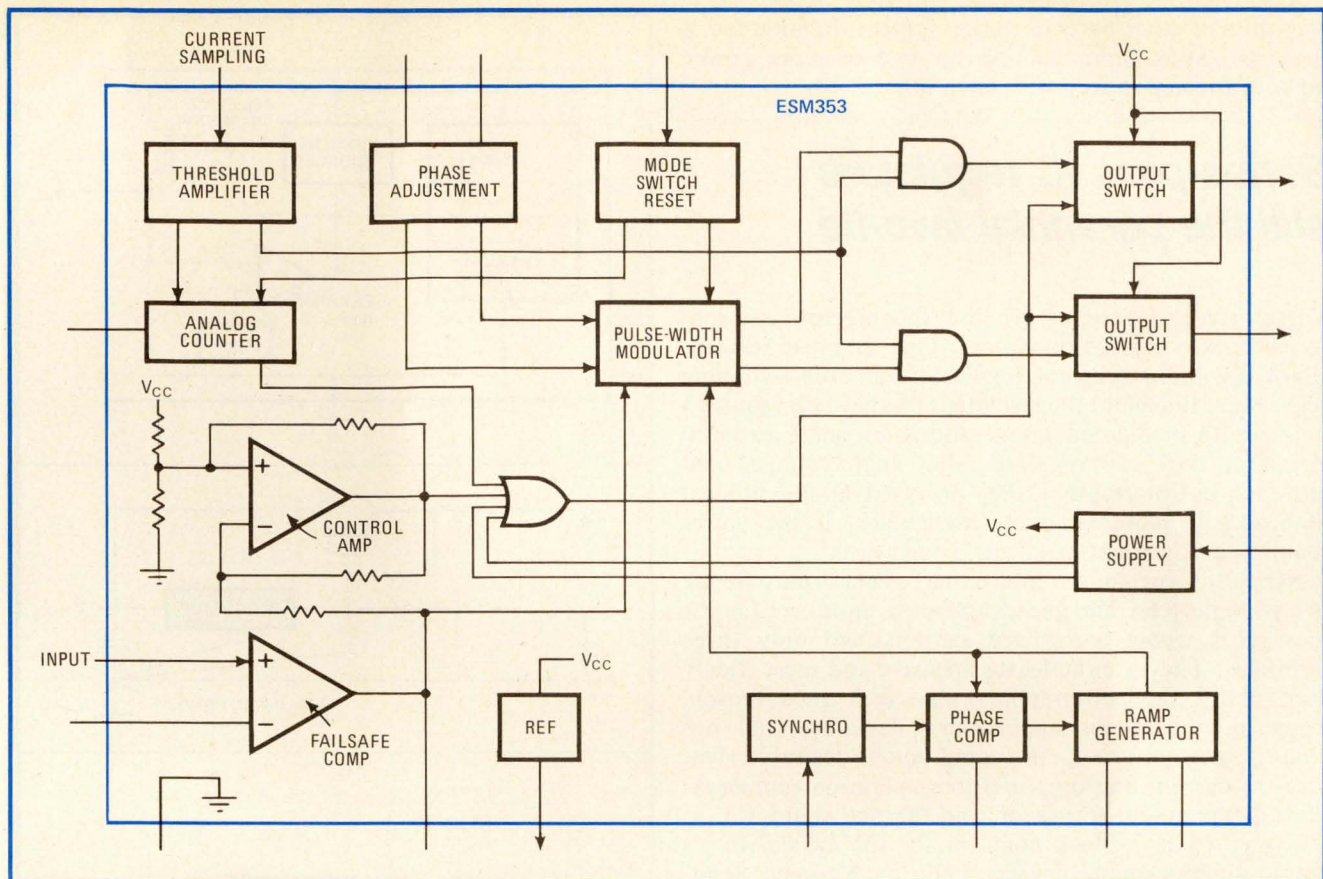

5. Adaptable. From Sescosem in France will shortly come a switching-supply control chip that permits choosing the output pulse train for driving either transistors or thyristors. The device also has an internal analog counter that keeps track of the number of reset attempts.

compensated voltage reference, the chip incorporates: a sawtooth generator, a pulse-width modulator, remote on/off switching, demagnetization, adjustable duty cycle, an external synchronization input, and an internal stabilized power supply. Also on chip are current limiting and protection against low-supply voltage, over-voltage, and loop fault.

The TDA1060 can be driven with a maximum of either 18 v or 30 mA, delivering up to 40 mA at the output. The voltage reference, which is typically 3.73 v, is maintained to within ± 100 ppm $^{\circ}$ C. Maximum frequency for the sawtooth generator is 100 kHz.

Operating on the Miller-integrator principle, the oscillator generates a sawtooth that is applied to the input of the pulse-duty-cycle modulator. The output from the power supply is then compared with the voltage from the reference, generating an error signal that controls the duty cycle of the pulses before they are applied to the amplifier. The oscillator can be either free running, under control of an external RC network or triggered by applied positive-going pulses.

Most exciting of all are the plans of the Sescosem division of France's Thomson-CSF. With an eye towards the tremendous growth potential of switching supplies, Sescosem is both expanding its line of switching-oriented power transistors and planning to bring out its own switching-regulator circuit in the second half of 1977. To be dubbed the ESM353 (Fig. 5), the bipolar chip will provide protection against short circuits, a sudden loss of

load, or serious overvoltage on the line. In addition, it will have failsafe shutdown and a driver transistor that can go as high as 500 mA.

The priority protection will be against overcurrent in the external switching-transistor circuit. This current is to be sampled outside of the chip, and the resulting potential applied to a threshold amplifier having a very precise voltage reference. If there is an output from the amplifier, indicating that the switching-transistor current is too high, a direct cutoff signal will be applied to the gates that control the output stages. Inhibit signals will also develop when the supply voltage to the ESM353 becomes too high or too low, or if there is an out-of-limits output from the on-chip failsafe comparator.

Another plus will be ease of use: the chip design will make it easy to tailor the switching supply to the application. For example, by using an outboarded potentiometer with the ESM353, it will be possible to set the output of the supply at anywhere between zero and the maximum rectified voltage of the output transformer. The designer will also be able to select, via external capacitors or potentiometers, parameters like minimum and maximum control-pulse width, the reference voltage, and the number of reset attempts that an on-chip analog counter will permit.

Then there will even be an input pin that permits choosing output pulse trains for driving either thyristors or transistors. Designers will be able to set the frequency of the on-chip oscillator so that it does not disturb

operation of other parts of the equipment. Finally, too, a synchronization input will permit two or more power supplies to keep in step with each other.

Series-pass IC regulators still the perennial favorite

Versatility and ease of use are the biggest assets of series-pass IC voltage regulators. They can also serve as shunt regulators, current regulators, or even switching regulators, though in the last situation they still require a pulse-width-modulated input. Aided by some external circuitry, they can regulate fairly high voltages and currents, but more often, they are used simply as local on-board dc power sources, particularly if the power requirement is a matter of just a few watts.

Series IC regulators are either general-purpose or precision devices. The general-purpose units are, for the most part, those with fixed outputs and only three terminals. They are the least expensive and most widely used of all the power-supply ICs—with good reason. They offer excellent applications flexibility and are almost blowout-proof, including such desirable features as current limiting, safe-area-operation compensation for the output transistor, and thermal shutdown.

Figure 6a is a block diagram for the typical fixed-output three-terminal devices made by National Semiconductor, a leading vendor of these power-supply ICs. Essentially, the error amplifier compares the reference voltage to the fraction of the output voltage determined by the resistor divider network. The signal developed by the error amplifier controls the base drive of the series-pass transistor, in this way regulating the supply voltage. If any of the protection networks is activated, the base drive to the series-pass transistor is either limited or turned off completely, so that the regulator is not damaged.

Fixed-output regulators of this kind come in both positive and negative models, and they can be adapted to a variety of applications besides voltage regulation. When supplemented with varying amounts of external circuitry, they can be used as current sources, current regulators, or even in combination for dual-output supplies. For example, with just a little external circuitry, a positive three-terminal device can operate as either a high-current regulator (Fig. 6b) or a switching regulator (Fig. 6c).

But there are a few limitations

Although they are easy to use in many applications, fixed-output three-terminal regulators do have some drawbacks. The table includes the performance ranges of available regulators, arranged by nominal output voltages—principally those for powering digital circuitry, like bipolar and MOS logic and memories, as well as analog circuitry, like operational amplifiers and comparators. Output cannot be precisely adjusted from the nominal fixed value, and output current capability is more limited than in other IC-regulator types.

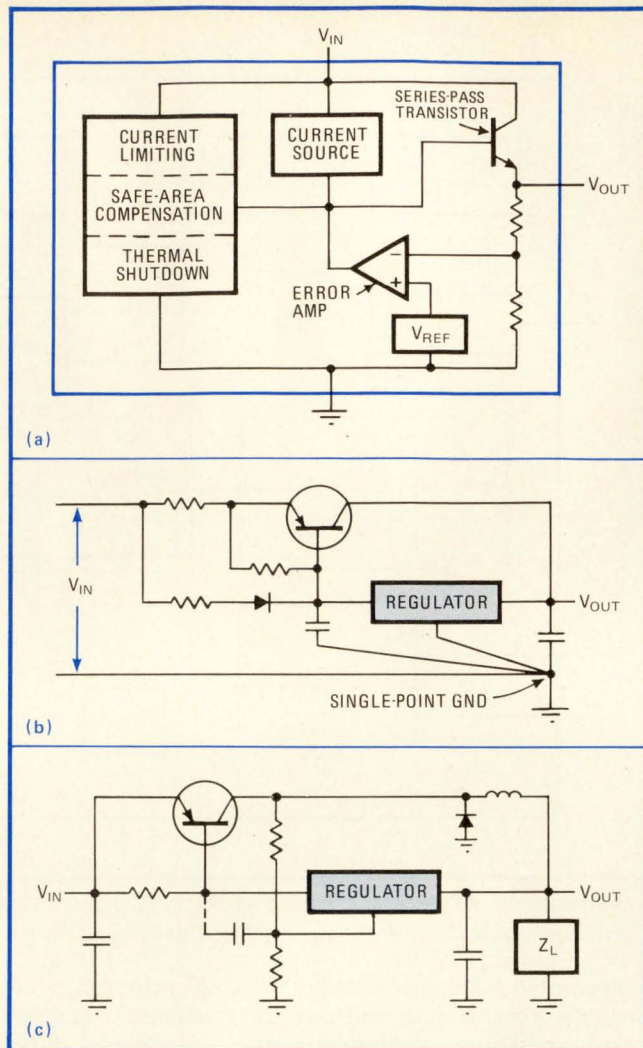

6. Multipurpose. Fixed-output three-terminal series-pass regulators (a) are rugged, including protection against excessive currents, over-voltages, and overheating. A major producer, National, suggests their use as current regulators (b) or even as switching regulators (c).

Still, their performance is improving. Output current, which is now up to 3 A for 5-v models, will be going up to a few amperes for other voltage values.

Breakdown voltage for the series-pass output transistor is also climbing. Philips and its U.S. subsidiary, Signetics Corp. in Sunnyvale, Calif., offer guaranteed minimum breakdowns of 60 v for their 78HV00 family of positive regulators. They achieve this high-voltage performance with a special linear bipolar process that employs a thick sloped oxide on each transistor structure, instead of the conventional stair-step profile. Varying the angle of the oxide slope changes the breakdown voltage from a guaranteed minimum of 60 v up to about 110 or 125 v, depending on the particular constraints of a regulator family.

At Signetics, work is also under way to boost the minimum breakdowns to about 150 v by ion-implantation techniques, without any other substantial changes in processing.

Three-terminal fixed-output regulators are readily available from a number of semiconductor houses,

FIXED-OUTPUT THREE-TERMINAL VOLTAGE REGULATORS

Nominal output voltage (V)	Maximum output current (mA)	Input voltage range (V)	Regulation		Typical ripple rejection (dB)	Output voltage accuracy (mV)
			Maximum line (mV)	Maximum load (mV)		
2.6	100	4.75 — 20	100 — 125	50	51	± 130 — ± 260
5	100 — 3,000	6.7 — 50	3 — 200 typ	10 — 100 typ	70 — 85	± 250 — ± 500
6	500 — 1,500	8 — 35	60 — 120	60 — 120	65 — 85	± 250 — ± 300
6.2	100	8.5 — 20	175 — 200	80	46	± 250
8	100 — 1,500	9.7 — 35	60 — 160	80 — 160	62 — 80	± 400 — ± 800
8.5	1,500	10.5 — 35	85 — 170	85 — 170	70	± 350
12	100 — 1,500	13.7 — 35	100 — 250	100 — 240	42 — 71	± 500 — ± 1,200
15	100 — 1,500	16.7 — 35	100 — 300	150 — 300	60	± 750 — ± 1,500
18	100 — 1,500	19.7 — 35	100 — 360	175 — 360	59	± 900 — ± 1,800
20	500 — 750	22 — 40	100 — 400	400	58 — 70	± 1,000
24	100 — 1,500	25.7 — 40	100 — 480	200 — 480	43 — 70	± 1,200 — ± 2,400
-3	100	-4.7 — -30	60 — 80	72	51	± 150 — ± 300
-5	100 — 1,500	-6.7 — -35	25 — 200	50 — 100	49 — 70	± 100 — ± 500
-5.2	1,000 — 1,500	-6.2 — -35	25 — 105	50 — 105	67 — 68	± 100 — ± 260
-6	500 — 1,500	-8 — -35	60 — 120	120	60 — 65	± 250 — ± 300
-8	500 — 1,500	-10 — -35	80 — 160	80 — 160	59 — 62	± 300 — ± 400
-8.5	1,500	-10.5 — -25	80 — 160	80 — 160	60	± 300
-12	100 — 1,500	-13 — -35	10 — 250	25 — 240	60 — 80	± 500 — ± 1,200
-15	100 — 1,500	-16.7 — -35	10 — 300	25 — 300	59 — 60	± 300 — ± 1,500
-18	100 — 1,500	-18.7 — -35	180 — 360	170 — 360	46 — 60	± 700 — ± 1,800
-20	500	-23 — -35	80	300	58	± 800
-24	100 — 1,500	-25.7 — -40	80 — 480	200 — 480	43 — 58	± 1,000 — ± 2,400

SOURCE: ELECTRONICS

including: National, Texas Instruments, Motorola, Silicon General, Fairchild Semiconductor of Mountain View, Calif., Signetics, Raytheon Co. of Lexington, Mass., Germany's Siemens AG, Philips' Elcoma division in the Netherlands, and France's Sescossem.

Some three-terminal models are adjustable

In the last year, to the relief of all those ever stymied by the fixed output, adjustable versions of positive three-terminal regulators were introduced by National. These LM117 devices supply up to 1.5 A over a 1.2-to-37-v variable output range. Like their fixed-output counterparts, they include short-circuit protection, thermal shut-down, and safe-area compensation for the output transistor. Lacking an internal ground, they are essentially floating regulators, so they can control power supplies of several hundred volts as long as the input-to-output differential of 40 v is not exceeded. Line regulation is about 0.01%/v, and load regulation around 0.1%/v typically.

TI, Motorola, and Silicon General are presently

second-sourcing the LM117 series. However, some time this year, Motorola plans to introduce 100-mA and 3-A versions of adjustable positive three-terminal regulators. Never one to be left behind, National will shortly be coming out with its own 3-A model, the LM150. Also in the works, but four to six months away, are negative versions of both the LM117 and LM150.

Recently, TI also announced a rather unusual three-terminal device—an adjustable shunt regulator, the TL430. A pair of external resistors sets its voltage anywhere between 3 and 30 v. As a result, it can serve as a programmable zener diode that exhibits "a knee as sharp as a tack"—a major advantage over conventional low-voltage zeners, says TI. The TL430 is also as good as many discrete reference diodes available today when it comes to typical temperature coefficient: it achieves 100 to 110 ppm/°C. Other uses for the device are as a current regulator or as a current-limit sense amplifier. It can sink up to 100 mA.

For greater applications flexibility and better supply performance, the designer can turn to the precision

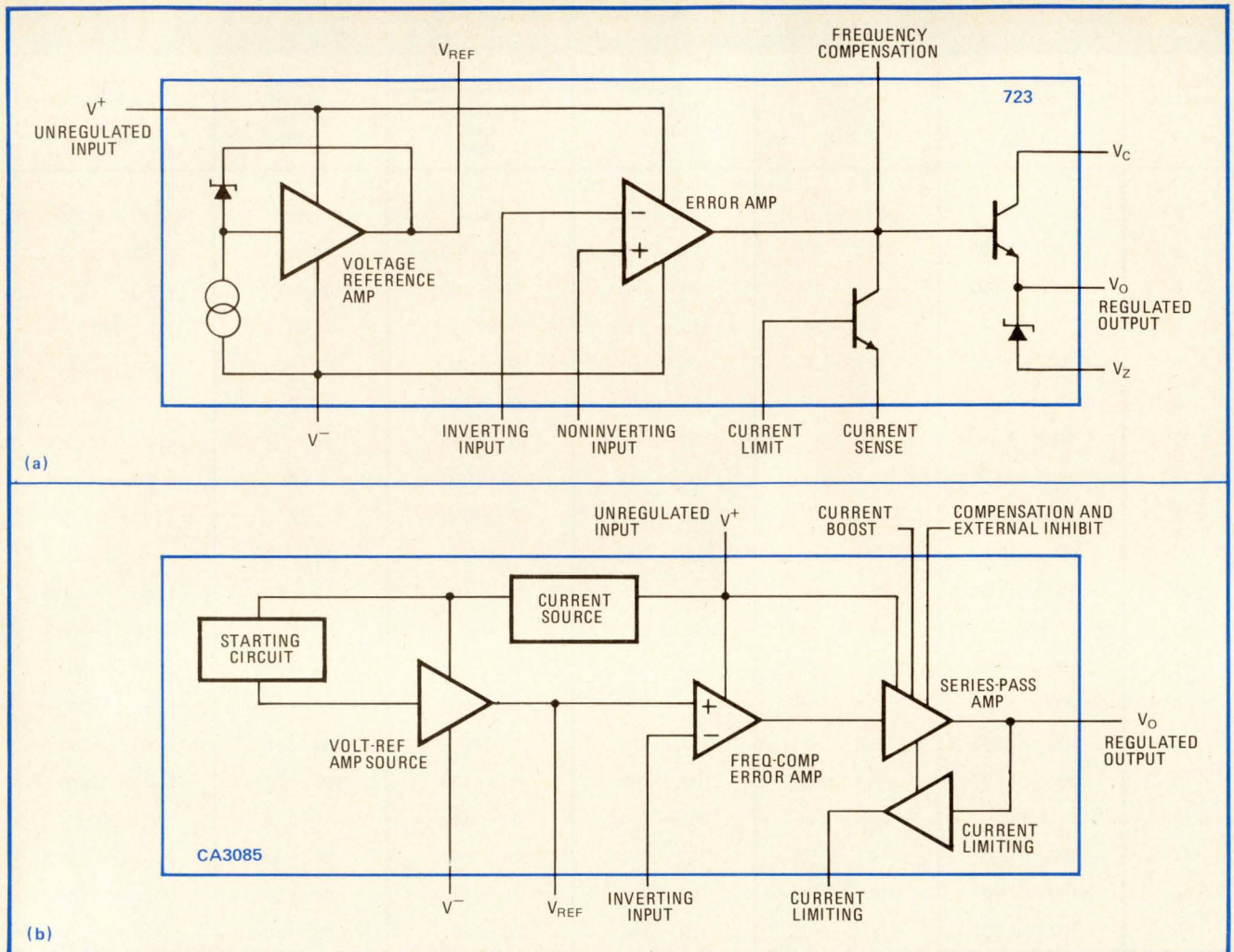

7. Precision. Since its introduction by Fairchild several years ago, the 723 precision regulator (a) has become an industry standard. Some later devices, though, offer better performance—like RCA's CA3085 precision regulator (b), which provides typical regulation of 0.025%.

series-pass IC regulators. Every one of them can operate over a fairly broad range of input and output voltages with no degradation of regulator performance. They have more than three terminals and come in both positive and negative models.

More pins for precision regulators

To some extent, precision variable regulators rely for protection on external devices. The user determines their current-limiting value with an external circuit and can also achieve electronic shutdown with a fairly simple outboarded network, but for thermal shutdown must go to a rather complex external circuit. In compensation, precision regulators do permit him to obtain high output voltage and currents easily, without the addition of many extra components and without sacrificing ultimate supply performance. In general, they are used as series, shunt, switching, or current regulators.

One of the most popular precision regulators is the 723 (Fig. 7a). Originally introduced by Fairchild several years ago, it has since become an industry standard. It includes a temperature-compensated reference amplifier, an error amplifier, a series-pass transistor, and a current-limiting circuit. Inputs for adjustable current limiting

and remote shutdown are independently accessible. From inputs of 9.5 to 40 v, the 723 delivers an adjustable output of 2 to 37 v at up to 150 mA. Typical load and line regulation is 0.03%.

Naturally, later precision regulators improve on the 723's performance. RCA Corp.'s CA3085 positive regulator (Fig. 7b) provides slightly better line and load regulation (0.025% typical) and operates over a wider input range of 7.5 to 50 v, delivering an output that is adjustable from 1.7 to 46 v at a current of up to 100 mA. RCA is now in the midst of forming a regulator program to use its gold-chip technology for higher output currents. Instead of the usual unprotected aluminum metalization, RCA deposits silicon nitride on a tri-metal system of titanium-platinum-gold, making the chip inherently hermetic. Gold interconnections can carry about 10 times as much current as equivalent aluminum interconnects, says the firm.

Other key U.S. companies making precision IC regulators include Motorola, National, TI, Silicon General, Signetics, and Raytheon—not surprisingly, the same firms who lead in general-purpose units.

An entry from Europe should not be ignored. From the Italian semiconductor producer, SGS/Ates, comes a

Bob Mammano: his forte is IC regulators

As an emigré from the aerospace industry, Bob Mammano draws on his systems design experience to create linear integrated circuits that replace entire boards of discrete components. The manager of advanced development at Silicon General Inc., Westminster, Calif., for the last eight years, he has been applying his know-how principally to ICs for power supplies. He has designed all of his firm's voltage-regulator products, including what he says is the industry's first dual-tracking series regulator.

His most recent achievement is the SG1524, a monolithic control for switching supplies that can be operated in single-ended or push-pull fashion (see p. 93). Although the product is only about six months old, it already looks like it will become an industry standard. The largest semiconductor manufacturer, Texas Instruments Inc., is announcing plans to second-source it.

Mammano worked for six years for Arinc Research Inc. in Santa Ana, Calif., a consulting firm that does reliability and design analyses for military systems. Before that, he packed a broad sweep of design experience under his belt, developing guidance and control systems for missiles, as well as power supplies and instruments, for a number of California-based aerospace companies.

He recalls the frustration of designing military equipment in the 1960s, when "the semiconductor industry was concentrating on digital circuits, and the linear area was getting short shrift." So in May 1969 he helped to form Silicon General as a linear specialty house, with the

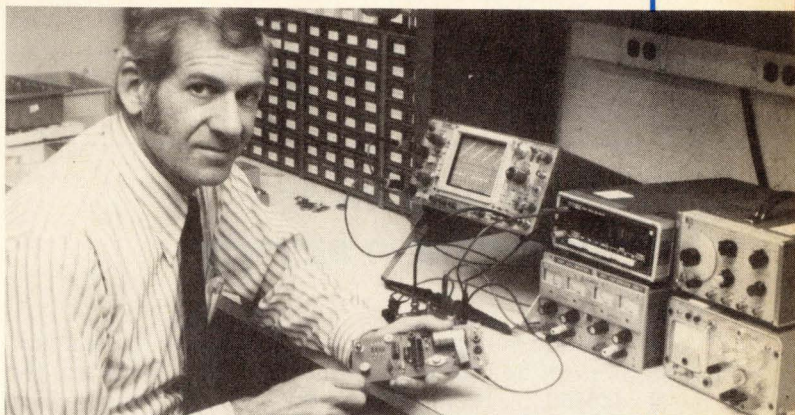

emphasis on custom circuits.

That goal has not changed appreciably. As a small linear-IC specialist, Silicon General "is satisfying needs not otherwise being met by the major semiconductor houses," he says. For the next generation of ICs for power supplies, Mammano declines to make specific predictions. "The added features will include more power-handling capability," he notes.

A native of California, Mammano only left to earn a 1957 degree in physics at the University of Colorado. His outside interests center on backpacking and skiing.

Larry Waller

Los Angeles bureau manager

precision variable regulator, the L200, which should be ready for the market in the second half of 1977. Although tagged as a voltage regulator, the L200 is precise enough to serve as a voltage reference, because of its low thermal drift of just 100 ppm/°C. The device's output voltage can be set anywhere between 3 and 30 v by outboard potentiometers or resistors. What's more, its output voltage can be selected by a digital input by pairing open-collector logic to the outboard resistors. Nor is additional control circuitry necessary if two of the devices are operated in parallel.

The L200 handles fairly heavy currents—up to 3 A for an input-output differential of 17 v—so it has been thoroughly protected against thermal overloads and short circuits. The maximum input voltage is 40 v, but the circuit has second-breakdown and overvoltage protection that can handle spikes up to 60 v. Typical load regulation is 0.1%, and ripple rejection is better than 70 decibels, even at high voltages.

Tracking outputs from dual regulators

Dual tracking regulators are actually two regulators, one positive and the other negative, in a single package. Their two output voltages literally track each other—that is, the midpoint between the positive and negative output voltages stays at ground potential. They are primarily intended for powering operational amplifiers, MOS logic circuits, or a combination of TTL and MOS circuits, and National, Motorola, and Silicon General are among the few companies to make them.

National's three series of tracking regulators accept

input voltages of up to ± 30 v and have outputs of ± 15 , ± 12 , or $+5$, -12 v at output currents of up to 100 mA. They are protected internally against thermal overload, and their current limiters are externally adjustable. Typical line and load regulation is 0.06%.

Motorola's dual ± 15 -v 100-mA regulator, the MC1468, has outputs balanced to within 1%. Although output voltage is internally set, it can be varied externally from 8 to 20 v for both output polarities. Standby current drain is 3 mA, and the outputs vary by no more than 1% because of temperature changes. Current limiting is externally adjustable.

From Silicon General comes what may well be the industry's oldest dual tracking regulator, the SG1501A. Its nominal output voltages are ± 15 v at currents of up to 200 mA, but they can be simultaneously varied from 8 to 23 v with a single external adjustment. Input voltages can be as high as ± 35 v. The same company also has an adjustable dual-voltage regulator, which develops positive and negative outputs that can be independently adjusted from 10 to 28 v. Output current goes up to 100 mA for this SG1502 regulator, while line and load regulation is 0.1%.

Just this past August, the Munich-based Siemens AG announced its dual regulator, the FZY101/105, which it designed mainly as a power-supply for high-noise-immunity IC-logic families, as well as for powering MOS and complementary-MOS devices.

Each device can accept inputs of up to 30 v maximum. But one regulator delivers selectable outputs of 12, 13, 14, 15, or 17 v at 120 mA, while the other provides an

output voltage of 12 or 17 v for a load of up to 25 mA.

The outputs of both voltage sources are connected internally to an on-chip pnp transistor. The purpose of this is to keep the output impedance low when there is no supply voltage—the idea is to prevent the outputs of logic devices from being inadvertently activated under no-supply conditions.

Voltage references— the ultimate in stability

Monolithic voltage references are perhaps the simplest answer to the need of instruments or data converters for a dependable standard voltage. Certainly the chips perform as well as and often better than zener circuits put together from discrete parts—and without all the troublesome backup that discrete reference diodes frequently need, like precision current sources and thermostatic controls.

Motorola, National, and Ferranti all offer models, and two prominent manufacturers of data converters, not otherwise interested in the IC regulator business, have also had the foresight to get involved here.

Analog Devices Inc. of Norwood, Mass., makes a monolithic three-terminal band-gap reference to complement its line of data converters in systems applications. The AD580 develops a fixed output of 2.5 v from inputs of 4.5 to 30 v. It operates at a low quiescent current of only 1 mA, maintaining its output to within $\pm 1\%$. Over the temperature range of 0°C to 70°C , output drift is held to 10 ppm/ $^\circ\text{C}$, and long-term stability is a tight 25 microvolts/month.

Within a few weeks, the company will be offering another monolithic reference—one made with on-chip silicon-chromium thin-film resistors that are laser-trimmed at the wafer stage for both absolute reference value and temperature coefficient. The new device will maintain its 10-v output to within ± 2 mv and offer a temperature coefficient of below 10 ppm/ $^\circ\text{C}$.

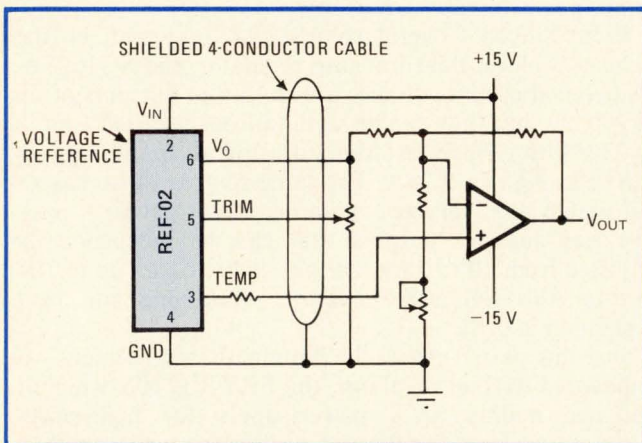

8. Monolithic thermometer. Adjustable voltage reference from Precision Monolithics has an unusual application—as a temperature transducer. One of the unit's output pins develops a voltage that is directly proportional to the temperature of the device.

Precision Monolithics Inc., Santa Clara, Calif., the other data-converter maker, has two band-gap voltage references, the REF-01 and the REF-02, for converter applications. Both contain on-chip compatible thin-film resistors that are trimmed at the wafer stage for output voltage and temperature coefficient. A zener-zap trimming technique avoids the surface damage typically caused by laser trimming, says the firm.

The REF-01 develops a 10-v output from inputs of 12 to 40 v, requiring only 1 mA of current. Its output, which is accurate to within ± 30 mv, can be adjusted over a $\pm 3\%$ range. The REF-02 is a 5-v reference, accurate to within ± 15 mv and adjustable over a $\pm 6\%$ range. It accepts inputs of 7 to 40 v, operating at a low current drain of 1 mA. Interestingly, it can also function as a monolithic thermometer. One of its output pins develops a voltage that is directly proportional to device temperature, permitting the unit to be used as a remote transducer in temperature-sensing applications (Fig. 8).

Just released by Motorola is its MC1403, a precision laser-trimmed low-voltage reference. For use with data converters, the device delivers a nominal output voltage of 2.5 v, ± 25 mv. It operates over an input range of 4.5 to 35 v at a typical quiescent current of 1.2 mA. Output current can go up to 10 mA, and typical temperature coefficient is 10 ppm/ $^\circ\text{C}$.

Two-terminal references vie with discrete zeners

Some monolithic references are two-terminal devices, so they even compete for the same pins as discrete reference diodes. National has a selection of such two-terminal bipolar ICs—a pair of band-gap references, as well as a pair of buried-zener references.

The LM113 is a band-gap device providing a low breakdown voltage of 1.220 v and a dynamic impedance of 0.3 ohm from 500 μA to 20 mA. Its temperature stability is typically 1% over a range of -55°C to $+125^\circ\text{C}$. The other band-gap reference is the LM136, which has a 2.4-v breakdown.

The buried-zener references are the LM199 and the LM129, which each have a breakdown voltage of about 6.9 v. Dynamic impedance is under 1 ohm for both, and operating current range is wide—0.5 to 10 mA for the LM199, 0.5 to 15 mA for the LM129. An on-chip temperature-stabilization network is the main difference between the two—the LM199 has one, the LM129 does not. This integral heater maintains chip temperature at a constant value for the LM199, giving it a temperature coefficient of 1 ppm/ $^\circ\text{C}$ or better without the need for special external circuitry or environmental controls.

From Ferranti in England came two low-voltage two-terminal band-gap references—the ZN423T, a 1.26-v device, and the ZN458T, a 2.45-v device. Priced attractively low, these sources also offer very low slope resistance over their full operating current range and freedom from the need of a precisely controlled operating current. The ZN423T can operate from a 1.5-v input, while the ZN458T requires 2.6 v. For a 5-v input and a 2-mA reference current, line and load regulation is 0.03%/v for the ZN423T, 0.1%/v for the ZN458T. \square

Reprints of this article cost \$3.00 each. Write to Electronics Reprint Dept., P.O. Box 609 Hightstown, N.J. 08520. Copyright 1977, Electronics, a McGraw-Hill publication.

High-reliability semiconductors: paying more doesn't always pay off

The premium paid for high reliability is usually worth it for discretes, but not necessarily for integrated circuits

by Eugene R. Hnatek, DCA Reliability Laboratory, Mountain View, Calif. *

□ Is it worth paying extra for high-reliability semiconductors? No, probably not for integrated circuits, whether digital or linear. But the large premiums paid for hi-rel diodes and transistors do guarantee lower failure rates—well, most of the time.

Those are the eye-opening conclusions of a recent extensive test study of nearly 190,000 devices, procured over an 18-month period from a variety of reputable semiconductor vendors.

But the study has implications beyond reliability and cost. Hi-rel semiconductor devices have such long delivery times—sometimes a year or more—that they can introduce serious delays into a project. Needless to say, these delays are pointless if, in the end, they yield devices that make little or no difference in system reliability.

The 190,000 device total breaks down into over 42,000 diodes, more than 51,000 transistors, about 32,500 linear ICs, around 41,500 bipolar digital ICs, and approximately 20,500 complementary-metal-oxide-semiconductor ICs. Each group consists of a reasonably adequate mix of

device types that have four ascending levels of reliability. In all cases, the lowest reliability level is the military-temperature-range grade, which undergoes none of that extra screening that inflates costs.

For discrete semiconductors, the other three reliability grades are JAN (for Joint Army Navy), JANTX (where TX stands for extra testing), and JANTXV (where V represents visual). JAN diodes and transistors also do not undergo any additional screening but are made on production lines certified by the Defense Electronics Supply Center to the provisions of MIL-S-19500. In contrast, JANTX devices, which are made on certified production lines, too, are subjected to screening to the requirements of MIL-S-19500 and MIL-STD-750. Similarly, JANTXV products fulfill all JANTX prerequisites, but they also undergo a "precap visual"—a visual inspection before capping.

The differentiation among the reliability grades for ICs is not quite as clear-cut. Beyond the mil-temp category, some devices satisfy MIL-STD-883, to either a class A or class B quality level, and others meet the requirements of MIL-M-38510, to the class B quality level. The fourth product grade mostly consists of mil-

*Now with Monolithic Memories Inc., Sunnyvale, Calif.

GRAPH 1: RELIABILITY COST COMPARISON

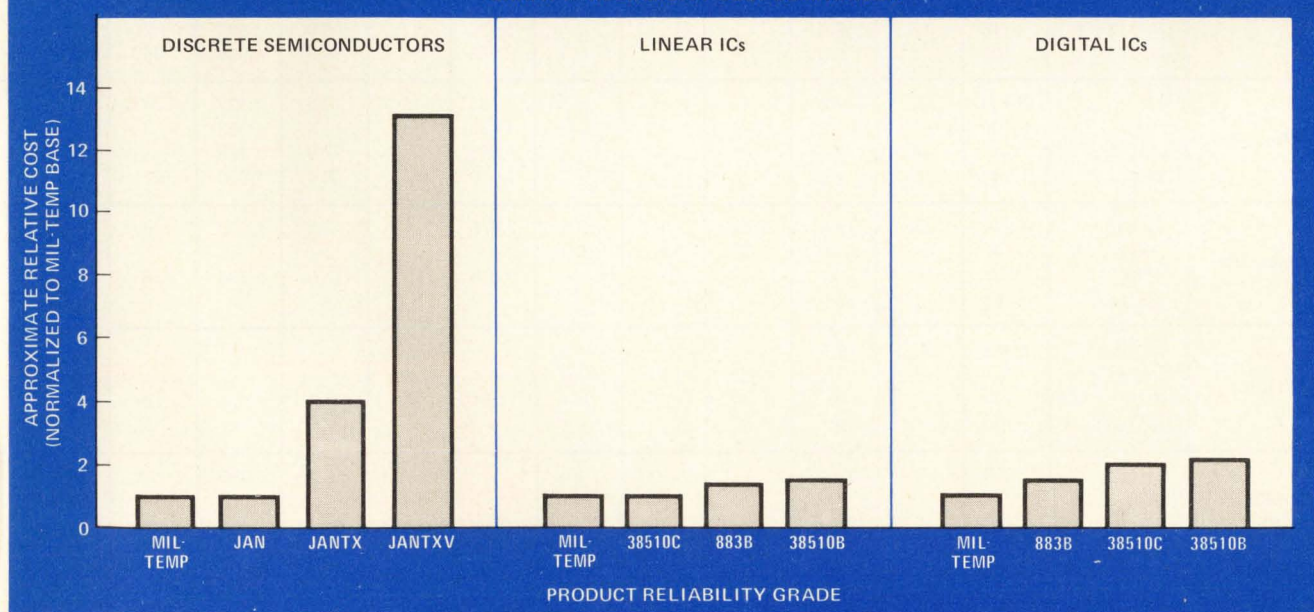

TABLE 1: SCREENING SEQUENCE VS. PROGRAM

PROGRAM	SCREEN												
	External visual	Temperature Bake	Fine Centrifuge	Gross hermeticity	Electrical at 25°C X-ray	Burn-in 168 hours	Burn-in 240 hours	Electrical at 25°C	Electrical at -55°C	Electrical ac at 125°C	Electrical ac at 25°C	External visual	External visual
HEAO	•	•	•	•	•	•	•	•	•	•	•	•	•
Space Shuttle	•	•	•	•	•	•	•	•	•	•	•	•	•
GPS*	•	•	•	•	•	•	•	•	•	•	•	•	•
Pioneer Venus*	•	•	•	•	•	•	•	•	•	•	•	•	•
Block V **	•	•	•	•	•	•	•	•	•	•	•	•	•
Fleet Sat Comm	•	•	•	•	•	•	•	•	•	•	•	•	•
Program M	•	•	•	•	•	•	•	•	•	•	•	•	•
Program N	•	•	•	•	•	•	•	•	•	•	•	•	•
Program W	•	•	•	•	•	•	•	•	•	•	•	•	•

*For diodes and transistors: 168-h reverse-bias burn-in, plus 168-h forward-bias burn-in
 For all ICs: 240-h operating burn-in
 **For all devices: electrical test at 25°C after 168-h burn-in, followed by another 168-h burn-in

temp devices receiving a level-A precap visual inspection at the water stage with a scanning electron microscope (SEM), but which are not subjected to any environmental screening.

Graph 1 indicates the approximate relative costs of the four grades of reliability for discrete semiconductors, linear ICs, and digital ICs. It is based on price schedules for lot sizes of 100 to 999 devices. For linear and digital

ICs, the highest reliability grade is about 1.5 to 2.5 times as expensive as the unscreened mil-temp category. However, hi-rel discrete semiconductors may cost over 10 times as much as their unscreened equivalents.

The parts tested for this study were purchased under nine Government programs, which put them through a variety of screening sequences (Table 1).

Outlining the programs

Most of the nine programs are for putting special-task satellites into orbit. To list all nine, however, they are:

- The High-Energy Astronomical Observatory (HEAO) satellite, a National Aeronautics and Space Administration program to measure quasars, pulsars, and black holes in outer space.
- The Space Shuttle, another NASA program, which is intended to transport workers and/or objects between earth and space and to place satellites in low earth orbit.
- The Global Positioning System (GPS), a satellite program run by the Air Force's Space and Missiles Systems Organization (Samsco) for aiding air, land, and sea navigation.
- Pioneer Venus, the satellite probe to Venus from the NASA/Ames Research Center.
- Block V, a group of satellites for Samsco that form the radar/weather sensor portion of a defense/meteorological system.
- Fleet Satellite Communications (Fleet Sat Comm), a Navy program for communications between ships, as well as from ship to shore.
- Three classified Government programs, designated here by the letters M, N, and W.

TABLE 2: PROGRAM DATA SUMMARY

Component	Product grade	HEAO			Space Shuttle			GPS			Pioneer Venus		
		Number tested	Number types	% failure	Number tested	Number types	% failure	Number tested	Number types	% failure	Number tested	Number types	% failure
diodes	1N	3,150	26	18.8	—	—	—	1,840	4	13.5	486	6	17.5
	JAN	2,270	15	12.3	—	—	—	1,866	6	6.4	15	1	0*
	JANTX	3,116	12	9.8	—	—	—	5,006	11	5.9	531	7	3.2
	JANTXV	100	1	9.0*	—	—	—	9,286	25	8.5	1,930	35	6.7
transistors	2N	3,463	34	19.8	—	—	—	1,183	10	18.6	1,332	23	15.8
	JAN	2,409	14	23.6	—	—	—	1,438	3	11.9	103	3	17.5*
	JANTX	715	3	7.7	—	—	—	1,848	9	22.9	488	8	20.9
	JANTXV	240	6	7.5	—	—	—	7,010	16	8.4	1,660	21	6.6
linear ICs	mil-temp precap/SEM	4,279	23	18.0	4,734	1	9.4	3,070	1	7.5	38	2	39.5*
	883B	—	—	—	4,058	4	30.0	—	—	—	—	—	—
	38510B	57	1	51.0*	—	—	—	3,616	10	17.6	1,206	24	17.0
TTL ICs	mil-temp precap/SEM	15,918	30	9.5	—	—	—	—	—	—	—	—	—
	883B	—	—	—	629	3	12.0	—	—	—	—	—	—
	38510B	100	1	0*	—	—	—	781	7	20.9	528	13	13.4
C-MOS ICs	mil-temp	1,328	4	33.4	—	—	—	—	—	—	386	3	18.4
	883A/SEM	—	—	—	—	—	—	—	—	—	7,066	47	10.7
	883B	85	1	25.9	—	—	—	—	—	—	34	1	11.8*
	38510B	100	1	10.0*	—	—	—	—	—	—	—	—	—

*Extremely small population, so valid conclusion cannot be drawn

No matter what the program or procured reliability level, every part went through an initial visual inspection, followed by a stabilization bake, temperature cycling, acceleration testing via a centrifuge, and hermeticity checks. It also underwent some form of burn-in, preceded by an electrical test and followed by another for dc parameters at room temperature. Some of the programs, however, added X-ray examination, a second burn-in, post-burn-in electrical tests at minimum and maximum operating-temperature extremes, and a final visual inspection. (All the extra screening was done at an independent test facility by program mandate.)

Furthermore, each program had a common requirement—certain screening tests, selected at random, had to be witnessed by Government-source-inspection personnel, who then validated the test results. Additionally, GSI personnel were on hand when the fully screened parts were shipped.

Establishing electrical-test criteria

All transistors and diodes, including unscreened mil-temp devices, were tested electrically against the appropriate "slash sheet" of MIL-S-19500 for both specification limits and excessive parameter drift. In contrast, only MIL-M-38510 ICs were tested electrically in accordance with this military document's conditions and parameter limits. All other ICs were tested against their published data-sheet electrical conditions and limits, as well as against program-established post-burn-in parameter-drift criteria.

Table 2 summarizes the test results for all the programs, showing the number of different part types involved and the percentage of devices that failed at each

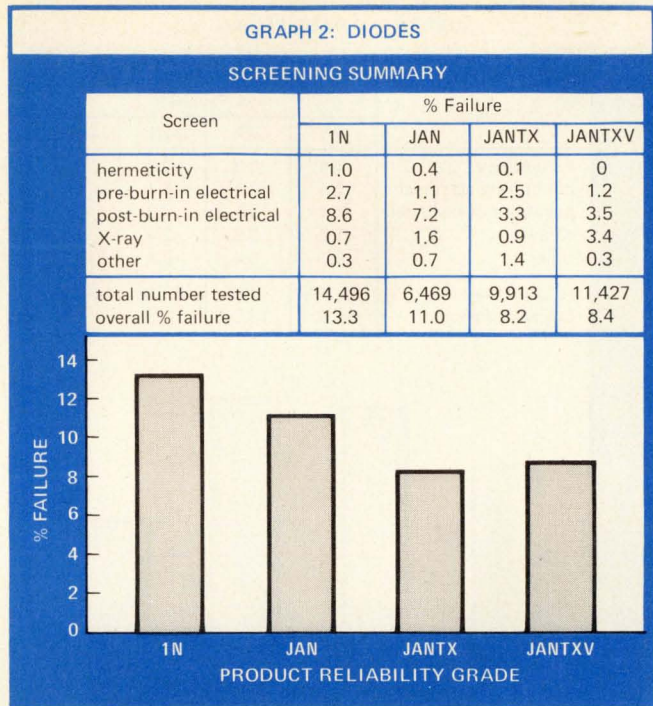

level of reliability. In some instances, the same part type number was procured with two different grades of reliability—for example, the JANTX 2N2222A and the JANTXV 2N2222A transistor types—because of a program's delivery constraints and the availability of certain reliability grades. For the most part, all the devices, as well as the mix of different part types, came from a broad spectrum of vendors, with one restriction—

Block V			Fleet Sat Comm			Program M			Program N			Program W		
Number tested	Number types	% failure	Number tested	Number types	% failure	Number tested	Number types	% failure	Number tested	Number types	% failure	Number tested	Number types	% failure
199	6	13.6	1,288	20	13.8	—	—	—	6,899	8	10.5	634	9	12.9
138	1	2.9	312	6	3.9	—	—	—	1,335	6	15.7	533	7	16.1
109	1	5.6*	—	—	—	—	—	—	203	2	66.0	948	16	4.2
111	6	9.9*	—	—	—	—	—	—	—	—	—	—	—	—
144	1	20.1	1,210	12	13.3	—	—	—	24,552	14	9.7	1,408	18	21.2
—	—	—	47	1	2.1*	—	—	—	856	5	5.0	13	2	0*
25	1	8.0*	—	—	—	—	—	—	—	—	—	962	11	10.8
142	2	9.8	—	—	—	—	—	—	—	—	—	—	—	—
27	2	22.2*	1,009	11	7.6	—	—	—	9,403	11	14.3	750	11	15.2
—	—	—	—	—	—	—	—	—	—	—	—	—	—	—
156	4	21.2	21	2	0*	—	—	—	—	—	—	130	1	26.9
—	—	—	—	—	—	—	—	—	—	—	—	—	—	—
652	15	16.0	2,807	23	3.5	—	—	—	18,149	30	3.2	823	30	8.0
—	—	—	—	—	—	—	—	—	—	—	—	—	—	—
219	7	23.7	—	—	—	—	—	—	—	—	—	201	10	20.9
—	—	—	—	—	—	713	5	7.0	—	—	—	—	—	—
—	—	—	—	—	—	11,465	31	12.0	—	—	—	—	—	—
—	—	—	—	—	—	—	—	—	—	—	—	—	—	—
—	—	—	—	—	—	—	—	—	—	—	—	—	—	—
—	—	—	—	—	—	—	—	—	—	—	—	—	—	—

GRAPH 3: TRANSISTORS

SCREENING SUMMARY

Screen	% Failure			
	2N	JAN	JANTX	JANTXV
hermeticity	1.4	1.8	0.8	0.7
pre-burn-in electrical	2.4	2.1	6.1	1.4
post-burn-in electrical	7.1	8.5	7.3	3.6
X-ray	1.0	3.6	2.4	2.1
other	0.1	0.4	0.4	0.2
total number tested	33,292	4,866	4,038	9,025
overall % failure	11.9	16.5	17.0	8.0

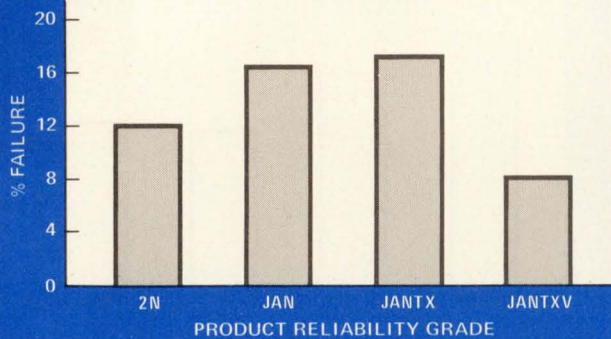

all of them appear on the qualified-parts lists written by various Government agencies.

For all devices, electrical failures before burn-in were primarily due to out-of-specification defects. But electrical failures after burn-in were due to both out-of-spec defects and critical parameter-drift faults—indeed, parameter drift accounted for approximately 30% to 40% of the post-burn-in rejects. Causes of most other failures were hermeticity faults and X-ray rejects, and there were also some visual failures from the centrifuge test and the like.

Out of all five component groups, diodes most nearly delivered what they promised. Graph 2 shows the test results for the diode population, which is made up of switching, zener, and reference types.

As should be the case, the overall failure rate is lower for prescreened JANTX and JANTXV devices than it is for unscreened JAN and 1N devices. However, it is hard to understand why prescreened burned-in JANTX diodes exhibit twice as many pre-burn-in electrical failures as JAN products, which are not burned in.

The rate of post-burn-in electrical failures for prescreened JANTX and JANTXV diodes is approximately half that of unscreened JAN and 1N parts, which is as it should be. But again, it is hard to understand the similarity of the JANTX and JANTXV diode failure percentage, particularly since the JANTXV devices did much worse on the X-ray examination than any other reliability category.

The picture for transistors is cloudier than that for diodes but still clear enough (Graph 3). This population reflects general-purpose and high-speed switching types, as well as a range of power devices. Although the JANTXV devices have the lowest reject rate, inexplicably the JANTX parts have the highest. In fact, even though JANTX transistors have already been through a burn-in, their pre-burn-in electrical failure percentage is nearly

GRAPH 4: LINEAR ICs

SCREENING SUMMARY

Screen	% Failure			
	mil-temp	precap/SEM	883B	38510B
hermeticity	1.3	4.7	1.8	0
pre-burn-in electrical	5.4	2.1	4.1	21.0
post-burn-in electrical	4.4	14.8	6.6	28.1
X-ray	0.9	8.1	4.9	1.7
other	0.7	0	0.3	0
total number tested	23,310	4,058	5,129	57
overall % failure	12.8	29.8	17.7	50.9*

*Extremely small population, so valid conclusion cannot be drawn

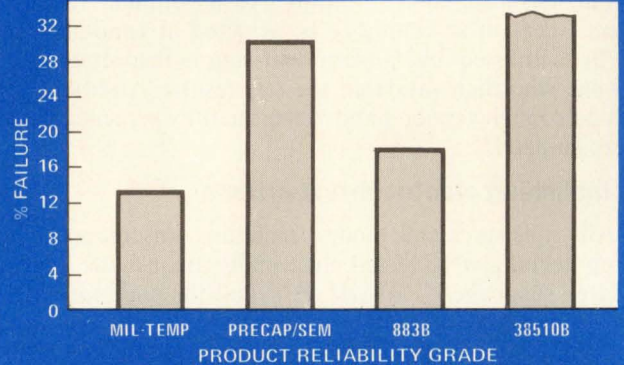

three times higher than JAN and 2N devices, which have not been burned in. Also, both JANTXV and JANTX products have abnormally high reject rates for post-burn-in electrical. Moreover, unscreened 2N products have the fewest X-ray failures.

To sum up for discrete semiconductors, then, the most cost-effective procurements appear to be JANTX or JANTXV reliability levels for diodes and 2N or JANTXV for transistors. But for high-reliability applications, additional screening of these products to a "TX" test sequence is probably advisable.

Unscreened mil-temp ICs are the best buy

To be fair to the three IC groups, their test results are somewhat skewed by the presence of one or more single-vendor populations.

The linear ICs (Graph 4) are no exception. They represent quite an assorted population, including operational amplifiers, comparators, voltage regulators, analog switches, diode arrays, and digital-to-analog converters. For this group, unscreened mil-temp devices unquestionably have the lowest failure percentage. But the population in the highest reliability category (38510B) is very small, and all the parts are the same type number and came from the same vendor—too slim a basis for valid statistical conclusions.

Ironically, prescreened burned-in 883B linear ICs have more pre-burn-in electrical failures than the precap/SEM devices, which are neither burned in nor prescreened. What's more, unscreened mil-temp parts have the lowest reject rate after burn-in, and precap/SEM products exhibit an extraordinarily high number of X-ray failures. (But the precap/SEM devices all came from one vendor.)

Graph 5 summarizes the test data for bipolar digital

GRAPH 5: TTL ICs

SCREENING SUMMARY

Screen	% Failure			
	mil-temp	precap/SEM	883B	38510B
hermeticity	1.1	0.8	9.4	0
pre-burn-in electrical	1.0	0.3	1.3	0.1
post-burn-in electrical	2.1	1.1	2.9	6.0
X-ray	1.4	9.5	4.1	0
other	0.4	0.3	1.0	0.1
total number tested	38,349	629	1,729	813
overall % failure	6.2	12.1	18.8	6.3

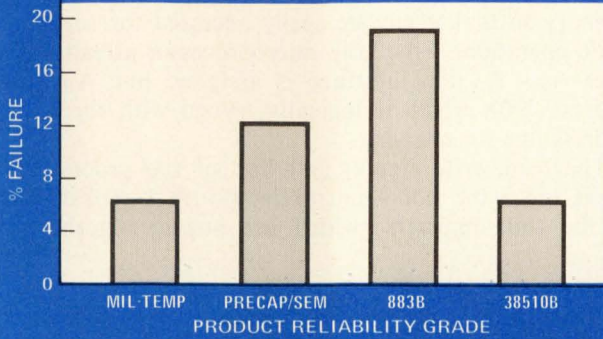

GRAPH 6: C-MOS ICs

SCREENING SUMMARY

Screen	% Failure			
	mil-temp	883A/SEM	883B	38510B
hermeticity	2.3	0.2	0	0
pre-burn-in electrical	6.4	1.5	2.5	1.0
post-burn-in electrical	4.0	2.0	19.3	9.0
X-ray	1.7	4.1	0	0
other	0.1	2.9	0	0
total number tested	13,179	7,066	119	100
overall % failure	14.6	10.7	21.8*	10.0*

*Extremely small population, so valid conclusion cannot be drawn

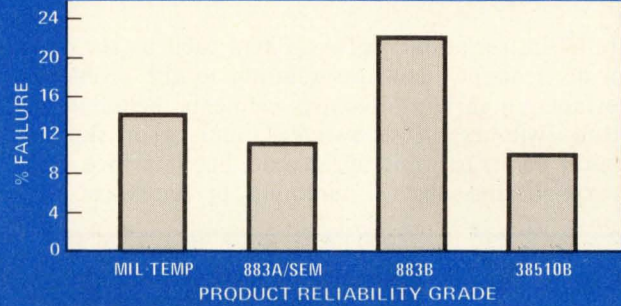

ICs. These are mainly transistor-transistor-logic circuits, divided about equally between small-scale and medium-scale devices. Once again, as with linear ICs, unscreened mil-temp parts exhibit the lowest reject rates, although the prescreened 38510B products also make a similar showing. (But the sample size for this group was extremely small, involving only six part types from two suppliers.)

Hermeticity rejects are very high for the 883B devices, though supposedly they had already been subjected to this test at the vendors' facilities. Also, while pre-burn-in electrical failures are consistently low for all reliability categories, post-burn-in electrical defects are higher for burned-in 883B and 38510B parts than for the non-burned-in precap/SEM and mil-temp products. Curiously, just like linear ICs and diodes, the bipolar ICs in the reliability grade with the most stringent precap visual requirements (precap/SEM, in this case) have the highest X-ray reject rate.

The population of C-MOS ICs (Graph 6) is almost as varied as that of linear ICs and ranges from simple gates all the way up to complex memories. However, this data is skewed to some extent because most of the parts came from a single vendor. Further, although the highest reliability grade (38510B) exhibits the lowest reject rate, the population of this category (and that of 883B) is really too small for making conclusive inferences.

Still, the indications are consistent with the results for other IC groups. Post-burn-in electrical failures are higher for C-MOS ICs that were supposedly already burned in than for unburned-in parts, and X-ray and visual reject rates are highest for the visually prescreened 883A/SEM products.

For ICs then, the results of this study indicate that the most reliable product category is the unscreened mil-temp grade for linear and TTL ICs, and the 883A/SEM parts for C-MOS ICs. In all cases, however, the failure

percentages caused by subsequent screening are quite high, so additional testing is obviously mandatory.

One area of particular concern is the surprisingly high reject rate of 883B TTL ICs when, as products of a reasonably mature manufacturing process, they should be very reliable.

Summing up

There are no decisive answers to the many questions raised by the data presented here. The high incidence of post-burn-in electrical failures may be due to different or more stringent burn-in conditions for the programs surveyed here, or perhaps the large number of devices that failed because of parameter drift.

The higher number of X-ray rejects for precap visually inspected products over noninspected or lower-level parts does not invalidate the effectiveness of precap visual inspection. Essentially, there is no real correlation between X-ray examination and precap visual. X-ray examination locates package-seal defects and die-attach residue, as well as undesirable wire dress, only the last of which may be found with a precap visual inspection. In effect, defects discovered by X-ray examination are a measure of how good the vendor's assembly process is and how clean his manufacturing operation is.

The major difference in the results—that is, for discrete semiconductors, the highest-level devices are the most reliable, whereas this is not generally true for ICs—may have two simple reasons. Discretes are both less complex than ICs and more mature. In all likelihood, as IC production processes become more refined, the highest-level ICs will become the most reliable.

At present, however, the most expensive semiconductor devices are not necessarily those that will provide the best reliability. Substantial cost savings may be realized by making an intelligent selection from the other product grades. □

connecting their shift-in and shift-out lines, as shown. This technique transforms the many parallel monitor points into a more manageable serial sequence of bits.

When a write operation is performed by the microprocessor at its interface address (A_{10}), the information is transferred from the switches and keys to the shift registers in parallel format. A series of read operations are then started at the interface address.

In a read operation, the R/W line from the microprocessor goes low, causing the shift registers to work in the serial mode. The read operation shifts the contents of all the 74165s one location, allowing the microprocessor to examine a new bit. The first parallel input of the first shift register is not wired to a switch since the first shift operation occurs before the microprocessor samples the input bit. The input bit is connected to the most-significant-bit input of the microprocessor, D_7 .

Since the bit being examined is the MSB of the word being loaded, the read operation sets the condition code of the microprocessor to indicate whether the input word is negative ($MSB = 1$) or nonnegative ($MSB = 0$). A branch on the condition code will then allow immediate action to be taken by the processor, based on the state of the switch just tested. Thus the input routine of the microprocessor can determine most efficiently whether

the bit that is being read is a 1 or a 0.

It is very simple to expand this circuit to examine more switches by adding additional shift registers. If a group of switches is located at a distant point, only three pairs of differential line drivers and receivers (which provide noise immunity) are required. Two pairs are used for the read/write and clock lines controlling the sampling and shifting, and the other carries the incoming data.

The software needed for this interface will vary according to the type of devices being monitored and the application for which they are used. For the application in the figure, the main functions are: keeping track of which point is being examined; switch debouncing (for momentary contacts); and differentiating between newly and previously closed switches (for keyboards).

The problem of key bouncing can be circumvented by waiting a long enough time for the keys to settle before rescanning. This is usually about 20 to 50 milliseconds. If the initial scan of the keys is done while a key is bouncing, it doesn't matter if the key is being read or not, as it will have settled by the next scan.

A microprocessor register or memory location should be used as a counter to keep track of which switch or monitor point is being examined. □

Adjustable TTL clock maintains 50% duty cycle

by Wilton Helm
Seventh-day Adventist Radio-TV-Film Center, Thousand Oaks, Calif.

The utility of the basic free-running transistor-transistor-logic clock can be greatly increased by adding a few components to provide a variable-frequency output

over a 5:1 range or better, while still maintaining a 50% duty cycle of the square-wave output.

A common design of the free-running oscillator is shown in Fig. 1. Three inverters are connected as a three-stage inverting amplifier, with intermediate stages biased by the output of the previous stage, and the last stage pulled up to +5 volts by a bias resistor to provide a TTL-compatible output. Capacitor C, connected across the second amplifier stage, provides the necessary time delay to ensure positive feedback, and thus determines the frequency of oscillation.

Adding a resistor, capacitor, and potentiometer (R_2 ,

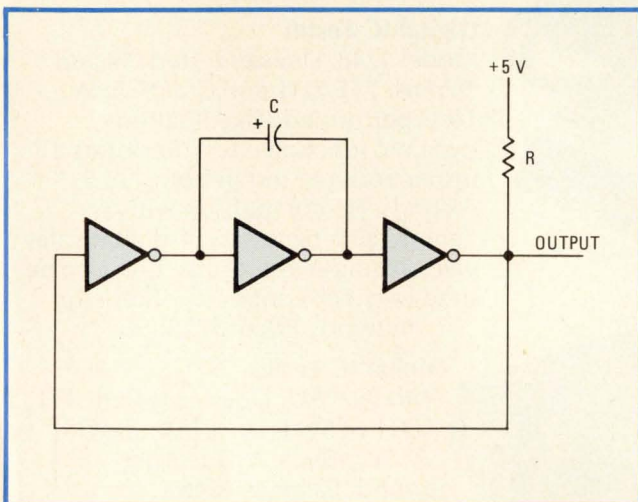

1. Free-running oscillator. Simple design of a TTL clock uses inverters. Frequency is determined by time constant of capacitor C with internal chip resistors. Low component count and good symmetry make it a natural for noncritical applications.

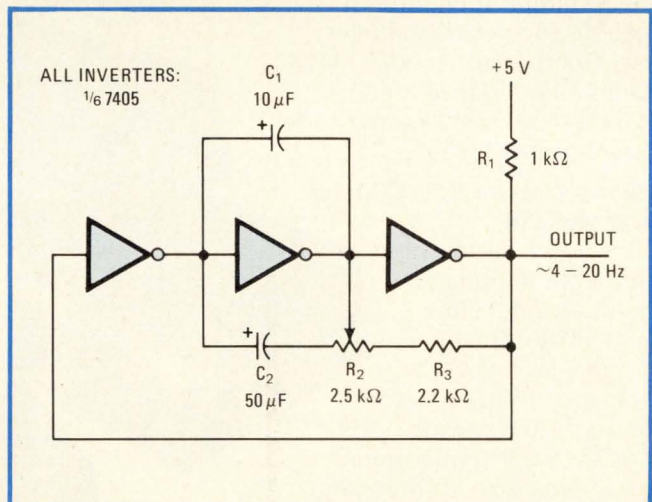

2. Adjustable counterpart. With the addition of three parts, the frequency of oscillation can be adjusted over a 5:1 range, while the attributes of the original design are maintained: the component count and cost is low, and the duty cycle is constant at 50%.

Weed 'em out before you plant 'em...



Low volume component testing with the ESI family of "Easy Weeders."

Now Test Resistors, Capacitors and Inductors the Way They Are Specified: + or - % Tolerance.

This high performance Impedance Meter combines with our newest Universal Comparator to create a low cost, fast sorting system and GO-NO GO testing. The Model 251 measures R, L, C and G at 0.25% accuracy. The Model 1412B Comparator offers limits from -100% to +100% or -10.00% to +10.00%.

Makes incoming inspection fast, easy, reliable and accurate. Prices: Universal Comparator Model 1412B, \$980; Digital Impedance Meter Model 251, \$1400; Test Fixture Model 1304 (four terminal), \$105.

New Microprocessor R, L, C Meter with D, Q and ESR

Everything you could want in programmable impedance testing—the Model 296 starting at \$4700. Dual 4½-digit displays of C/L and D/Q; dual frequencies of 1 kHz and 120 Hz; wide ranges (C to 200,000 microfarads); 0.1% basic accuracy; autoranging; selectable test voltages; measurement speed as low as 100 milli-seconds; many low cost options such as GPIB interface,



Model 251

Model 1412B

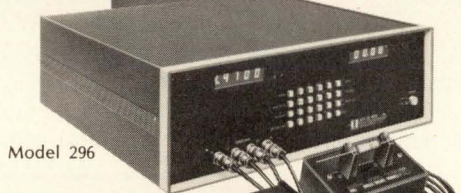

Model 296

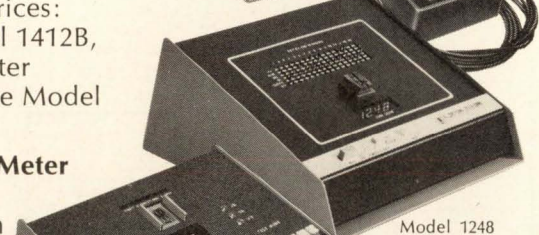

Model 1248



Model 1234

Model 1249

multiple limits and % deviation. Select function, range, voltage, frequency on 24-button panel, or program it remotely.

Linear IC Tester

Model 1234. Devices tested: Monolithic or Hybrid Operational amplifiers. Tests performed: E^{OS} , 1^{B-} , 1^{B+} , DC open loop gain, DC CMRR, oscillation detection. Remarks: 3-digit direct reading digital display which enables GO-NO GO testing. Price: \$1265.

Digital IC Tester

Model 1248. Devices tested: 14 and 16 pins. TTL, DTL and CMOS @ 5V. Tests performed: Fixed pattern, dynamic functional test. Performs 2^{20} inspections per test in from 1 to 5 seconds. No comparison with a "good" IC is necessary. 4-digit display gives absolute test results. Can also be used to check continuity of resistor network. Price: \$725.

Digital IC Tester

Model 1249. Devices tested: TTL, DTL @ 5V, HTL @ 15V, CMOS @ 5V, 10V, 15V. Tests performed: Same as 1248. Interfaces with manual and automatic handlers. Multiple voltages for CMOS. Price: \$1325.

Prices U.S. only.

esi
ELECTRO
SCIENTIFIC

Electro Scientific Industries
13900 N.W. Science Park Drive
Portland, Oregon 97229
(503) 641-4141

For Literature circle 109
For Demonstration circle 108

C_2 , and R_3), as in Fig. 2, enhances the versatility of the circuit. Capacitor C_1 performs the same time-delay function as C in the design of Fig. 1, but now serves to determine the upper limit of oscillation frequency, since it is paralleled by C_2 .

The combination of C_2 and R_2 adds a time delay to the transitions of the second amplifier stage, additional to the delay of the upper-limit capacitor C_1 . But the resistance in series with C_2 could tend to upset the symmetry of the square wave, as is usually the case when attempts are made to vary the frequency of the free-running-oscillator design of Fig. 1.

Symmetry of the square-wave output is maintained by connecting the right side of R_2 through resistor R_3 to the output of the third amplifier stage. This changes the

charging current to the capacitors in proportion to the setting of frequency-adjusting potentiometer R_2 . Thus, a duty cycle of 50% is constant over the entire range of oscillation.

The lower frequency limit is set by capacitor C_2 . With the components shown, the frequency of oscillation can be varied by R_2 from about 4 to 20 hertz. Other frequency ranges can be obtained by changing the values of C_1 and R_3 , which control the upper limit of oscillation, or C_2 , which limits the low-frequency end.

Note that the inverters used in the adjustable oscillator are open-collector types, such as the 7405. The inherent low impedance of other types of inverters would swamp the effect of charging-current resistor R_3 and should not be used in this application. □

2.4-V battery backup protects microprocessor memory

by Raymond N. Bennett
Advanced Technology Laboratories Inc., Bellevue, Wash.

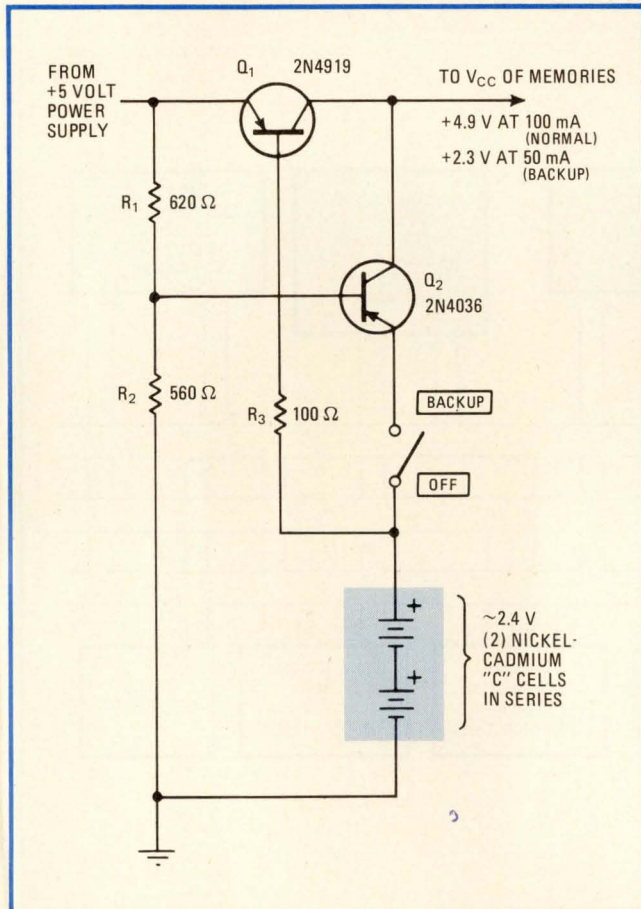

Memory saver. A series pair of nickel-cadmium "C" cells, each nominally rated at 1.25 volts, puts out about 2.4 volts and can deliver 2.3 volts to microprocessor memories to prevent loss of data in the event of supply failure. Transistors saturate to less than 100 mv.

Using diodes to isolate a backup battery from the power supply of microprocessor memories works fine—if the 0.7- to 1.0-volt drop across each diode can be tolerated. A more efficient circuit (see figure) substitutes saturable switching transistors that have a drop of less than 100 millivolts, which minimizes current drain and therefore extends battery life.

Moreover, the voltage of the nickel-cadmium battery supply need only be 2.4 volts, since during a power failure a saturated transistor then delivers all of 2.3 v to the memories. That is more than enough for such metal-oxide-semiconductor devices as the 2102 static random-access memory, which begins to lose data if its supply drops below about 2 v.

The circuit shown in the figure is connected between the +5-v power-supply line and the supply input of the memories. When the 5-v supply is functioning normally, transistor Q_1 is biased heavily into conduction by the difference between the supply voltage and that of the Ni-Cad batteries: $5\text{ v} - 2.4\text{ v} = 2.6\text{ v}$. The voltage delivered to the memories is then about 4.9 v, since the drop across Q_1 is at most 100 millivolts. During this time, the R_1 - R_2 voltage divider holds transistor Q_2 off, and the batteries receive a charge of about 20 milliamperes through R_3 and the base-emitter junction of Q_1 .

When power failure occurs and the 5-v supply drops below about 3.1 v (which is $2.4\text{ v} + V_{BE}$), Q_1 begins to cut off, isolating the dying 5-v supply from the load. At the same time, Q_2 , biased by the R_1 - R_2 voltage divider, begins to conduct, connecting the backup batteries to the load. The reverse bias on transistor Q_1 prevents the Ni-Cads from discharging through the supply circuit.

Both Q_1 and Q_2 were chosen for their very low saturation characteristics. Although their current ratings seem far in excess of what is needed, the result is that they exhibit a $V_{CE(SAT)}$ of less than 100 millivolts. But any pnp power transistors of the same general qualifications as those specified, such as the GE Powertab series, should suffice.

The standby switch has been included to permit defeating of the battery backup feature. □

Designer's casebook is a regular feature in *Electronics*. We invite readers to submit original and unpublished circuit ideas and solutions to design problems. Explain briefly but thoroughly the circuit's operating principle and purpose. We'll pay \$50 for each item published.

Avoiding missteps in programming and memory

by Norman E. Peterson
Digitech Data Industries Inc., Ridgefield, Conn.

Designing programming flexibility and enough memory into microprocessor-based equipment is something like walking a tightrope: a misstep can turn into a disaster. If the designer does not anticipate users' needs well enough, he—and his design—will fall on their faces.

Anticipation of how the equipment will be used is especially important when it must handle a wide variety of user-written programs. The designer must have a good idea of how much instruction code is required and the amount of memory the user will need for applications programming.

Not all requirements can be pinned down beforehand, but some design foresight can make operational program changes just a matter of adding a stand-alone piece of instruction code without rewriting existing programs. Such foresight is important. Rewriting a major program to accommodate the new code is costly, especially since it will again require extensive debugging.

Case in point

The importance of these considerations was borne out by the design process of a data-line monitor and interactive simulator based on the Intel 8080A. The unit, the Pacer (Fig. 1) lets the user configure and execute a custom test program and view the test results on an alphanumeric display.

It was designed to provide comprehensive diagnosis of data networks, to isolate hardware problems, and to debug network software. It selectively monitors and displays all protocol, control, and test characters, and it detects and controls the status of the EIA RS-232

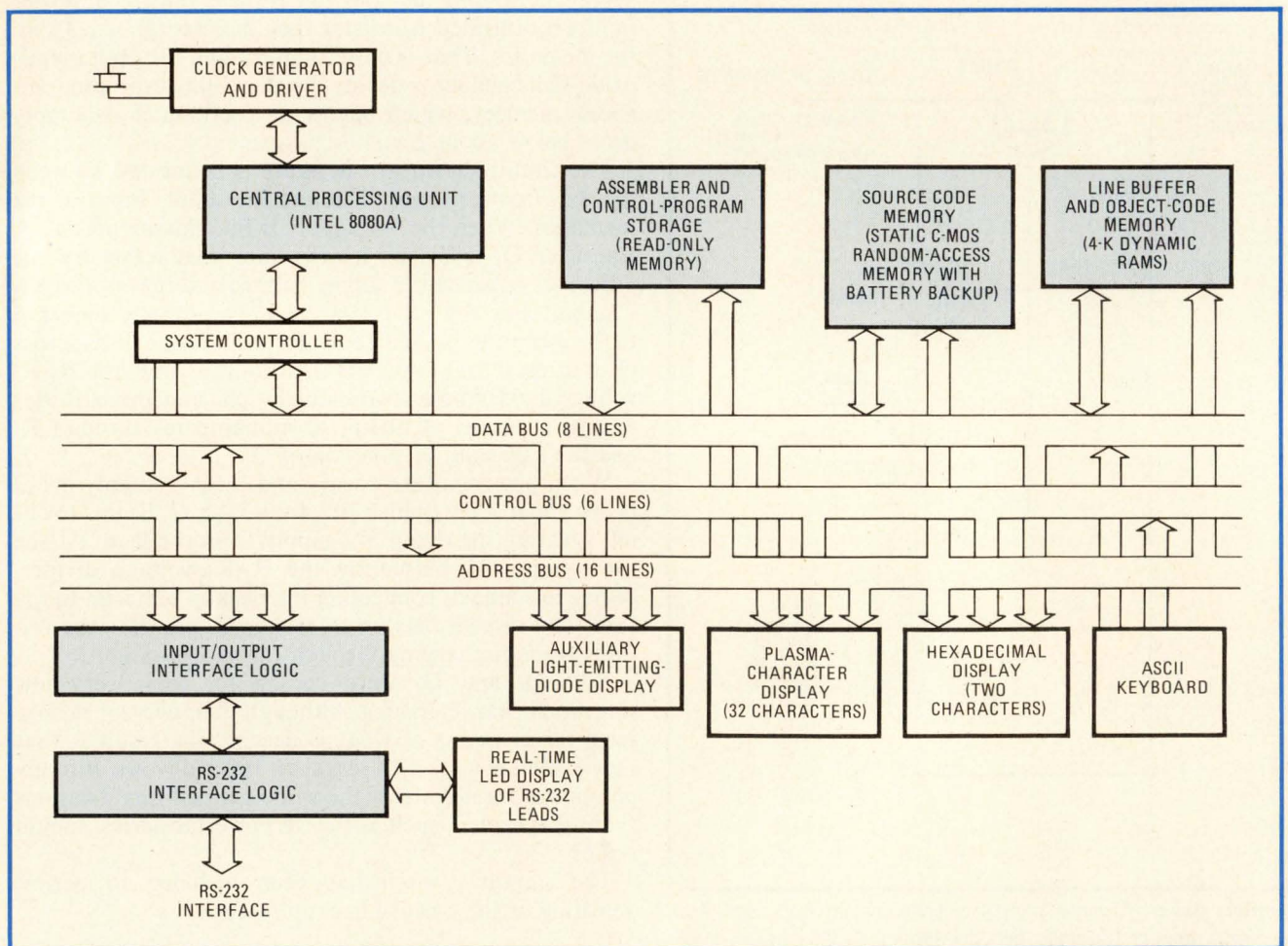

1. The inside view. The hardware design of the Pacer follows conventional microprocessor architecture. The major design effort was the input/output and the RS-232 interface logic, which allow the instrument to monitor and simulate any line discipline under CPU control.

interface lead. Moreover, it actively transmits polling/response sequences and variable test messages to simulate operating performance of data-terminal or communications equipment.

Getting flexibility

The RS-232 interface is a natural entry point for testing telecommunication networks and equipment. But providing both passive monitoring and active simulation has always posed a design problem of flexibility. Although the number of elemental operations that can be performed at this 25-pin interface is small, the permutations, combinations, and sequences that make up a particular line discipline is infinite. It is virtually impossible to design sufficient universality into a test instrument with only hard-wired logic.

The answer is the low-cost microprocessor. Its programmability proved the only way to provide custom performance from a standard developmental program of macroinstructions (a group of instructions for a particular function) for each of the elemental operations at the RS-232 interface. With the macros, the user can compile specific applications programs to test each line protocol with the resident line assembler.

Selecting a device

Since 8-bit data from the interface must be handled, the choice of an 8-bit microprocessor was obvious. After comparing the performance of available 8-bit processors, it also was obvious that all would perform at least adequately.

The Intel 8080A was chosen only because it had the highest production volume and the best second-sourcing. Selecting a technically superior chip and finding out after initial production that it is no longer available would require a total rewrite and debugging of the program.

The hard part

Choosing a microprocessor was the easiest part of the tightrope walk. Writing a developmental program suited to user needs and deciding how much memory was enough yet not too much proved to be more of a balancing act.

During field tests of the Pacer, it turned out that users wanted to write longer test programs than anticipated. Rather than use several small test programs to test individual functions one at a time, they wanted to punch a button and have the instrument do the rest. What they asked for was equipment that would permit them to write instruction codes testing each of the functions and then to combine the codes into a single program.

The initial design did not include enough memory space to accommodate the application-program lengths users wanted. In structuring the program code, then, a key requirement was enough memory to allow program

SAMPLE PROGRAM			
Program step	Code	Instructions	Argument
00	63	Program identifier	monitor NAK responses
01	37	Turn off display	—
02	11	Turn off receiver 2 or 3	3
03	51	Set counter A	ϕ
04	30	Clear display	—
05	55	Display contents of counter	A
06	31	Display characters	NAK sequences
07	13	Receive and log through sequence	NAK
08	53	Add one count to counter	A
09	04	Branch back	-5

2. Sample program. This 10-step instruction code programs the instrument to detect and count the number of messages on lead 2 of the RS-232 interface that were received in error and had to be retransmitted. The negative-acknowledgement (NAK) sequences displayed after step 06 are not destroyed when the program branches back to step 05 and redisplay the contents of counter A.

expansion without a rewrite. But blindly adding more memory just increases the cost of the instrument and lowers its competitive edge. So the designer must know how it will be used.

The solution was to initially write a developmental code that could handle a buffer random-access memory that can be expanded as needed. Delimiting in the instruction code tells the user the limits of the available memory.

As well as providing access to enough memory, the developmental code must be long enough to handle the number of instructions anticipated. A two-digit code is sufficient for more than 10 and less than 100 instructions, and so one was devised. A brief sample program that uses a 10-step instruction code to detect messages received in error is shown in Fig.2.

However, if it appears that about 90 instructions will be needed, it is best to go to a three-digit code. Such a code does not cost much more initially, but it avoids a major software rework if additional instructions are needed later on.

Freedom of choice

The initial consideration for the read-only memory containing the developmental program was programmable ROMs tailored to each user's needs. But they would effectively put the designer into the user's loop before settling finally on the design—a practice that is

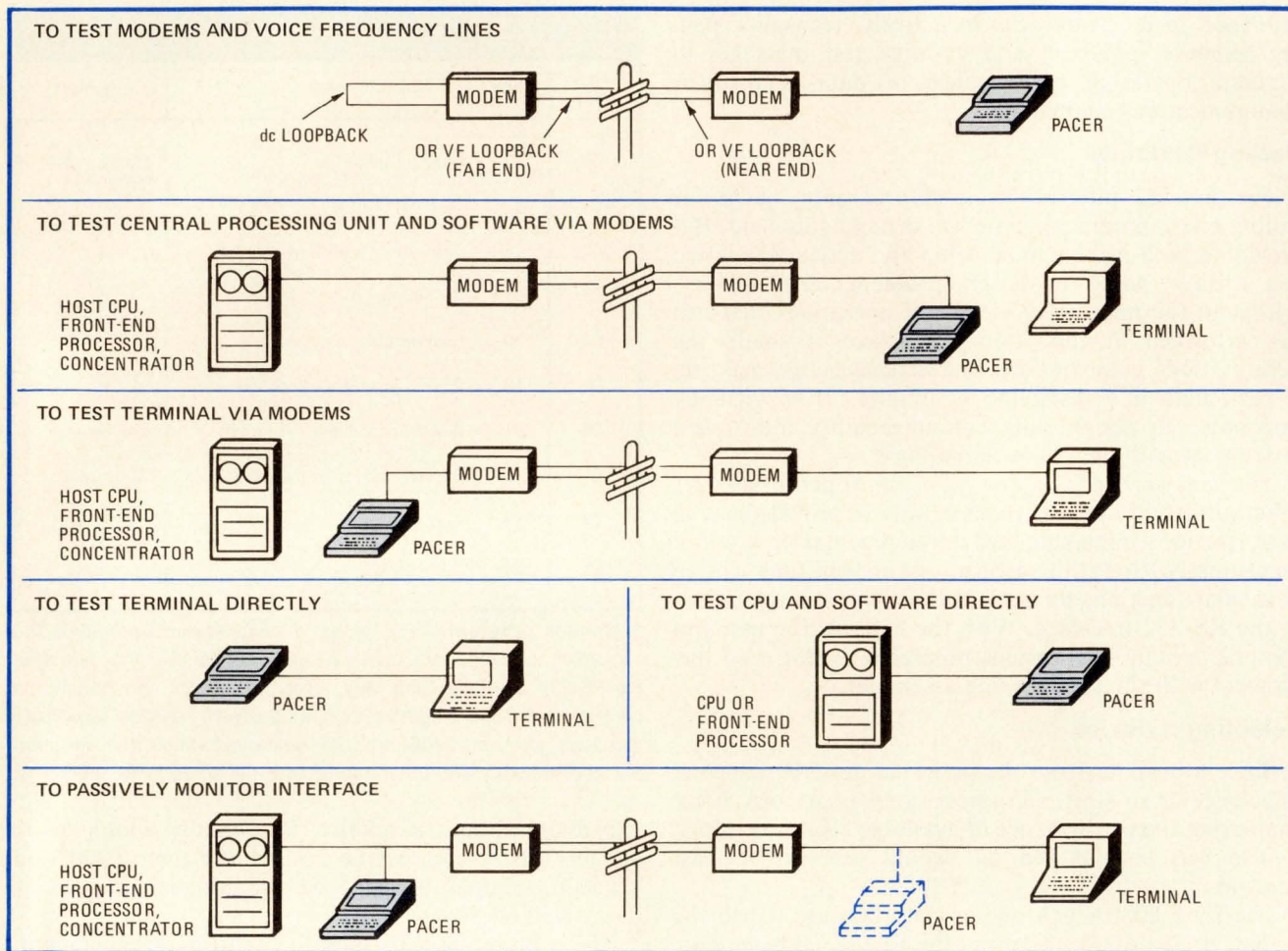

3. Many uses. Through simple keyboard commands, the user can quickly configure and execute custom test programs for checking interfaces, terminals, CPUs, and software, as well as modems and voice-frequency lines, and view the results on the alphanumeric display.

all too frequently fraught with errors.

Instead, a relatively simple two-pass ROM assembler was included that lets the user build his own program on the spot. In the first pass, he selects the required macros, which consist of machine codes for one of the elemental interface functions, and transfers them from ROM to buffer RAM, where the program is assembled. During the second pass, he adds the jump addresses for the instruction code and arguments (specific instructions).

Lasting memory

Re-entering the longer, more complex applications programs every time the instrument is turned on would be a chore. A nonvolatile memory was needed to store the users' programs in source-code statements, which are called out and compiled as required. The Pacer uses a small battery-supported complementary-metal-oxide-semiconductor RAM. Under typical operating conditions, it was found that two 5.6-volt mercury batteries will last about a year.

Even with these changes in software and memories, the instrument was brought into full production status with a minimum of hardware changes. Almost all the bugs were removed by software rewrite. A number of the more typical applications of the Pacer are shown in brief outline in Fig. 3.

Long life

Furthermore, a simple software update extends the life of the Pacer beyond the normal cycle. The instrument can be made to track the improving capabilities of telecommunication circuits and equipment. Thus it avoids obsolescence as new line protocols are developed and are put into use.

A bonus with these microprocessor-based instruments shows up when testing personnel are unfamiliar with programming. Users can simply load source codes into the instruments from a central location by using modems and telephone lines. All the field technicians have to do is to perform the tests. □

Low-cost dual delayed-sweep method eases measuring time

Extending the oscilloscope's circuitry with mostly standard components produces sophisticated time-interval tests

by Bill Law and Abraham Taghioff, Tektronix Inc., Beaverton, Ore.

□ Adding dual delayed-sweep capability to oscilloscopes takes no more than a technique relying on simple logic. Incorporated into a topside option, the technique eases and speeds the scopes' measurements of time intervals and their inverse, and, as a bonus, voltage, resistance, and temperature measurements.

The DM44 option incorporates the latest in oscilloscope time-measurement techniques (see "Simplifying time measurement," p. 116). Like other dual delayed-sweep techniques, it is faster and simpler to use than earlier techniques, but it is cheaper.

The option achieves lower cost by using vastly simpler circuitry than do other dual delayed-sweep scopes, which rely on a microprocessor-like chip, digital-to-analog conversion, and two comparators. Without using a

processor chip, it extends the scope's circuitry to provide dual delayed sweeps. A single-supply quad operational amplifier provides buffer and comparator functions. Maximum use of standard components permits automatic insertion on the production line, and the main printed-circuit board has interfacing circuitry that mates with most of the 400 series of portable scopes.

Simplifying circuits

The DM44 circuit (Fig. 1) uses the oscilloscope's delay-time-position potentiometer to provide the first delay voltage. This voltage feeds a resistive network through a buffer amplifier, A_1 . The A_1 output, V_{A1} , sets the first delay time after the trigger.

To produce the second delay voltage, two approxi-

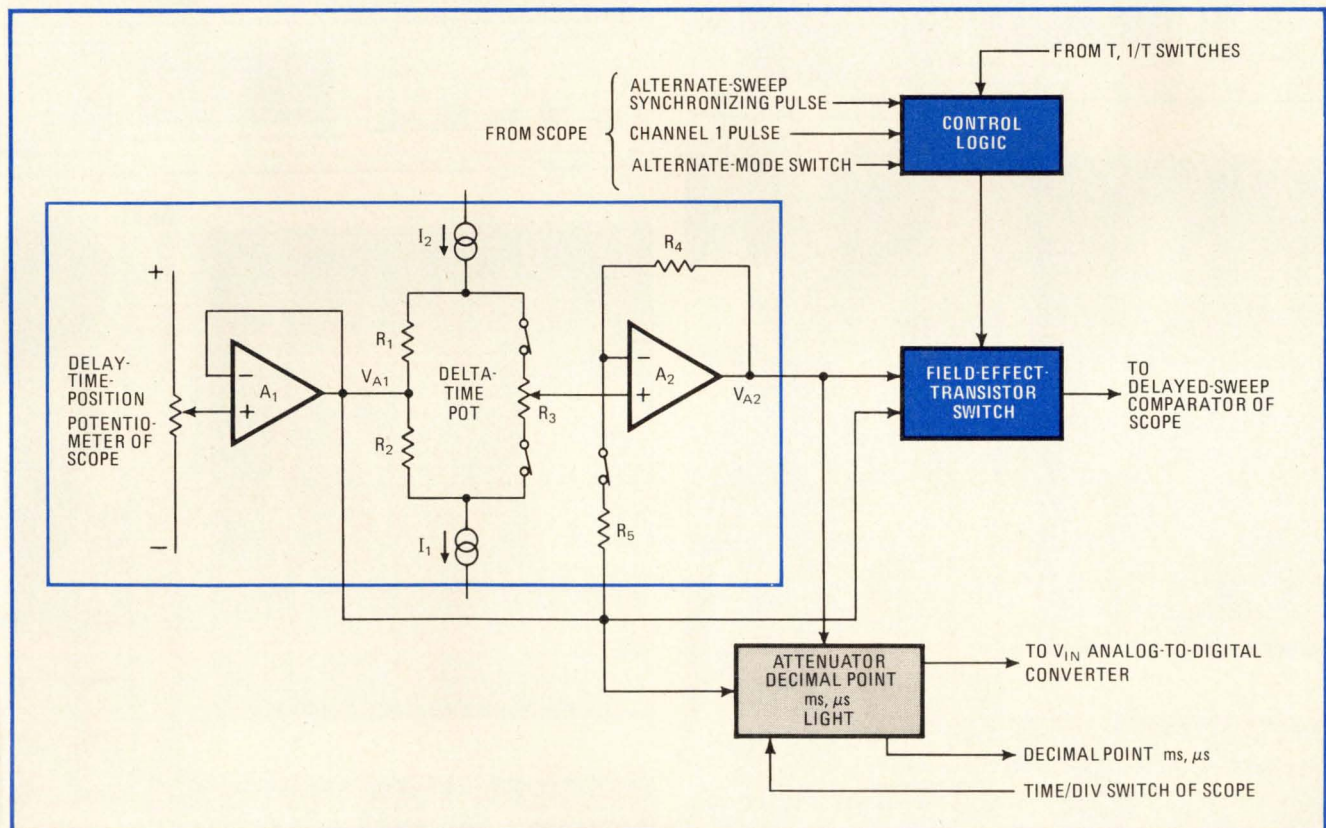

1. Teamwork. An input from the oscilloscope's delay-time-position potentiometer results in V_{A1} , which sets the first delay time after the trigger. The amplified output voltage, V_{A2} , of the DM44's delta-time pot sets the second delay time after trigger.

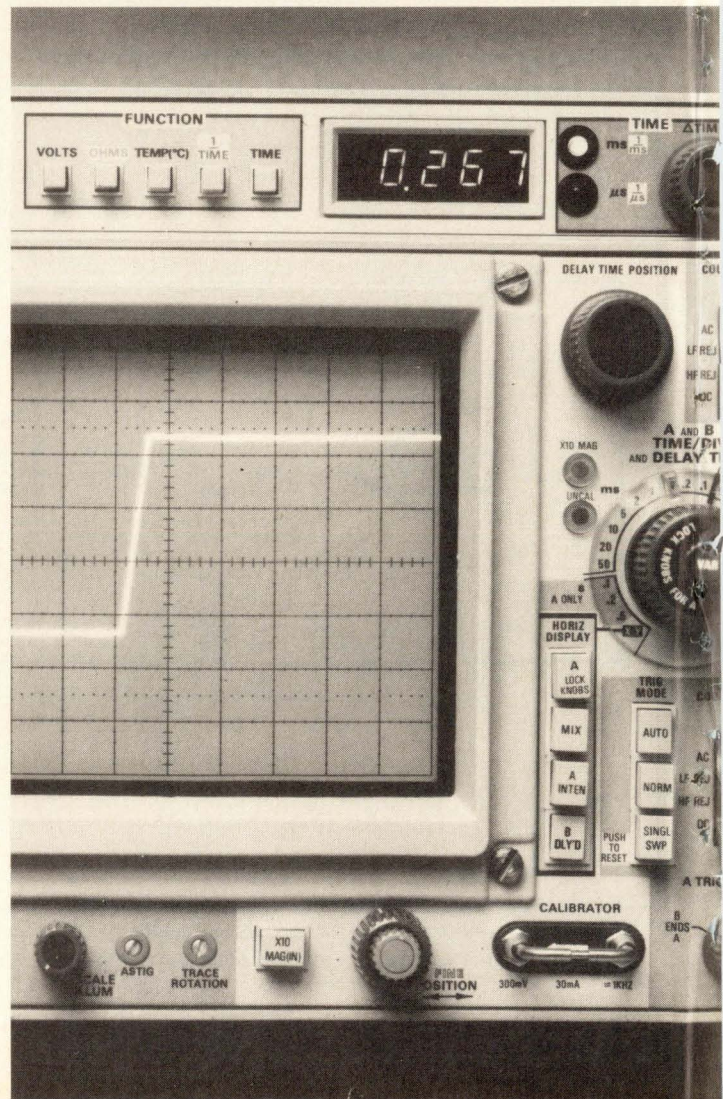
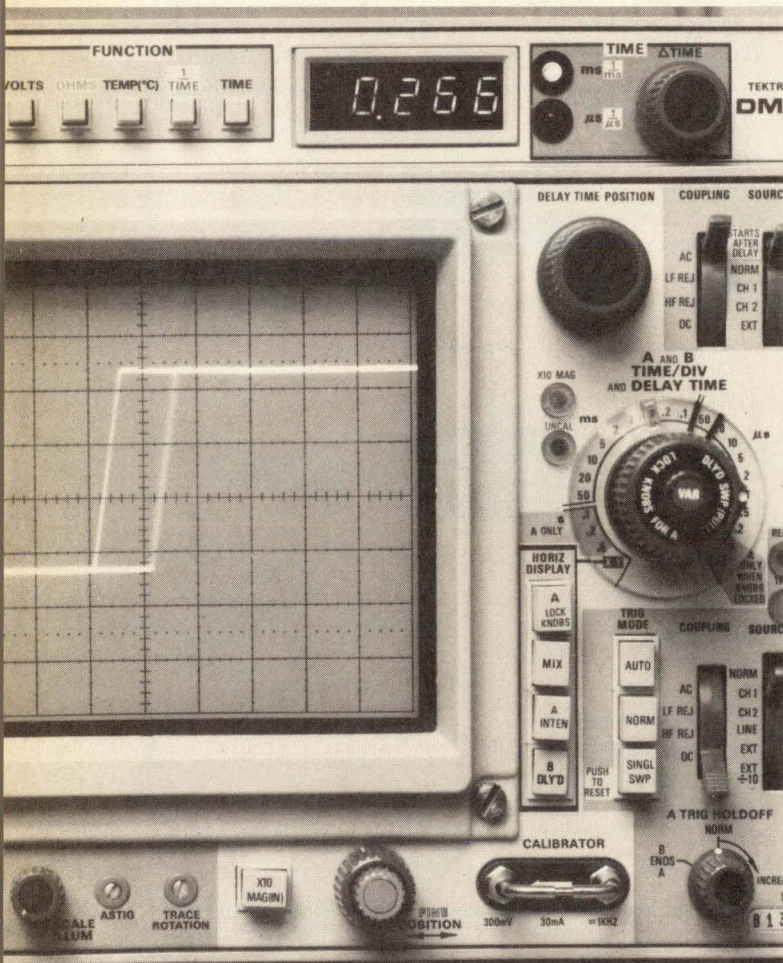
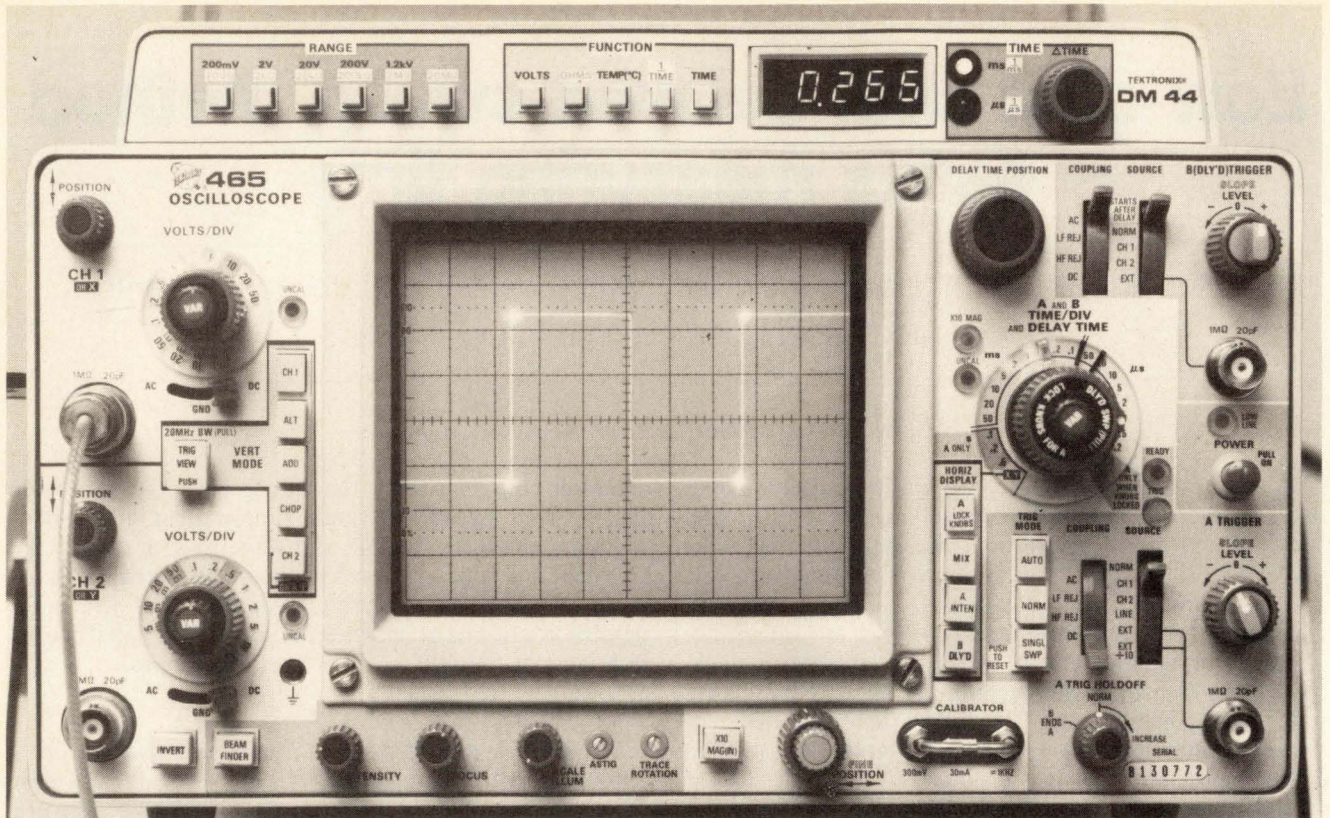

Easy does it

Measuring time intervals with the DM44 option and the oscilloscope is a simple two-step procedure. The operator sets the scope in its intensified mode and uses the dial of its delay-time-position potentiometer to position two intensified spots at the beginning and end of the time interval (left).

He switches the scope to its delayed-sweep mode and uses the delta-time dial to superimpose the end of the interval on the beginning (below, far left). The light-emitting-diode readout will give the value of the time interval with 1% accuracy (below, near left). Switching to the DM44's 1/time mode will give a direct readout of the reciprocal of time, which is often the frequency of the interval (below).

By eliminating the need for the operator to read dials, align traces precisely and make calculations, the equipment decreases the probability of errors. It also reduces measurement time, thereby facilitating the measurement process.

The dual delayed-sweep technique is particularly useful for checking and adjusting the timing on computers and their peripherals and other digital electronic equipment. It is especially handy when measuring the number of different time intervals that may be necessary when testing microprocessors during design, while troubleshooting, and in servicing.

mately equal floating-current sources, I_1 and I_2 , develop a voltage across the DM44's delta-time pot, R_3 . This voltage is twice that produced by the scope's delay-time pot. The output voltage of the delta-time pot equals V_{A1} plus or minus some ΔV determined by the pot setting. When amplified by A_2 , this output voltage, V_{A2} , sets the second delay time after trigger. Thus the operator may generate two intensified spots or two delayed sweeps independently.

The two voltages, V_{A1} and V_{A2} , feed an inexpensive field-effect-transistor switch controlled by simple integrated-circuit logic. For voltage, resistance, and temperature measurements, the FET switch locks on V_{A1} since time is not being measured. For time measurements, the switch alternately gates the voltages to the scope's delayed-sweep comparator.

In the channel 1, channel 2, add, and chop modes of the scope, the alternate-sweep synchronizing pulse instructs the control logic to alternately feed V_{A1} and V_{A2} to the comparator at the end of each main sweep. In the scope's alternate mode, the channel 1 signal provides the instruction to ensure that V_{A1} is present to the comparator during the channel 1 display and V_{A2} during the channel 2 display.

The coincidence of the main-sweep voltage and V_{A1} or V_{A2} generates a delayed-sweep trigger. During display of the main sweep, the delayed sweep produces a bright segment on the trace. The position and length of this

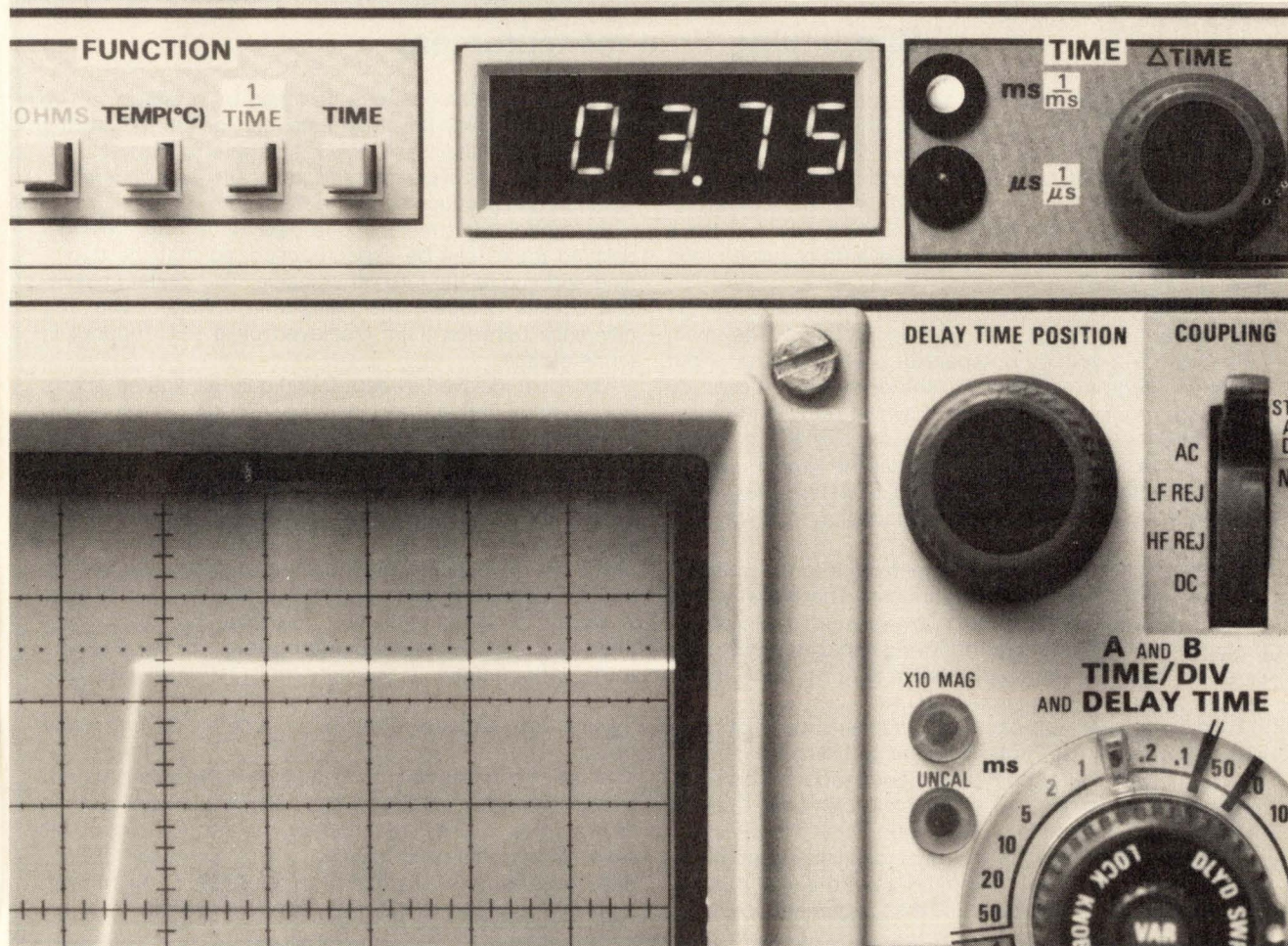

segment reflect the delay time and the rate of the delayed sweeps. During the scope's delayed-sweep mode, the sweeps are displayed and can be positioned independently on the X axis of the cathode-ray tube by the operator.

Simple circuitry simultaneously provides the time-interval readout. A voltage differential, $\Delta V = V_{A1} - V_{A2}$, dependent only on the setting of the DM44's delta-time pot, is applied to the scope's time/division switching circuit for automatic selection of the proper attenuator. The attenuated voltage then feeds an analog-to-digital converter in the DM44, and the equivalent time is displayed on a 3½-digit light-emitting-diode readout on the option's face. The same circuits operate the millisecond and microsecond indicator lights that are next to the readout.

Inverting measurements

In many cases, the oscilloscope operator wants the reciprocal of the time interval, which is often the frequency of the pulse. Direct readout on the LED display of $1/t$ is easily obtained from the a-d converter consisting of the Siliconix LD110/111 digital voltmeter chip set. In this chip set, the net count to be displayed is equal to $k_1 (V_{in}/V_{ref})$.

For most measurements, V_{ref} is about 6.2 volts, V_{in} is less than 2 v, and the net count varies directly with V_{in} . To obtain $1/t$, V_{ref} is varied and V_{in} is kept constant so

that the net count equals k_2/V_{ref} , where $k_2 = V_{in}k_1$. Furthermore, varying V_{ref} directly with ΔT , where $\Delta T = V_{A1} - V_{A2}$, means the net count varies with $k_2/\Delta T$. This procedure allows a direct readout of $1/t$.

Speeding the process

A step-by-step comparison against the conventional method for time-interval measurement gives an idea of the speed of the dual delayed-sweep technique. It also points up the ease with which 1% accuracy is achieved.

The conventional method requires a highly linear delay-time-position potentiometer with a vernier dial to keep track of the positions set in by the operator. Although reasonably accurate, this method requires seven steps to measure a time interval:

1. Set the oscilloscope in its intensified mode and use the delay-time dial to set the intensified spot at the beginning of the interval.
2. Switch to the delayed-sweep mode and precisely position the beginning of the time interval to a selected vertical graticule line.
3. Record the reading on the dial.
4. Return the scope to its intensified mode and position the intensified spot at the end of the time interval.
5. Switch back to the delayed-sweep mode, and, using the dial, precisely position the end of the time interval on the same graticule line as in step 2.
6. Record the new reading on the dial.

Simplifying time measurement

The calibrated time base made possible the measurement of time intervals with oscilloscopes. The interval between any two points on the scope's screen could be measured, within the limits of such factors as time-base accuracy, linearity, parallax errors, trace width, and the operator's visual acuity. The most crippling limitation was that there was no way to isolate and magnify events occurring long after a sweep begins.

The delayed-sweep technique, with two independently adjustable time bases, solved this problem. The main sweep feeds a voltage comparator, with the other input being a voltage proportional to the delay time chosen by the operator. The coincidence of sweep-ramp and delay-time voltages generates a trigger, starting the delayed-sweep ramp. The operator can adjust the second sweep, from the other time base, to a much faster speed. This magnifies the isolated event and increases measurement resolution.

Although the delayed-sweep technique is a significant advance, it still has several limitations. There always are the possibilities of human error in aligning a trace with a graticule line, of thermal drift between measurements, and of errors in the complex procedure that includes taking dial readings and making calculations.

One simplifying approach is to replace the calibrated dial of the delay-time potentiometer with analog calculation circuitry and a light-emitting-diode readout. This eliminates the calculations and the inaccuracies characteristic of dial readings. But there still is room for improvement.

A further refinement is the dual delayed-sweep technique, incorporating two comparators and digital calculation circuits. This eliminates the alignment problem

because measurements can be taken by overlapping two traces. Two delay-time voltages are generated in the conventional fashion and applied on alternate sweeps to the comparators. Two delay triggers are thus generated, which in turn produce separate delayed sweeps.

By careful adjustment of the delay-time pots, the two delayed traces can be superimposed, so that the beginning and end of the interval coincide. The digital calculation circuits compare the delay-time voltages, with the difference between them displayed on a LED readout in terms of time.

The dual delayed-sweep technique eliminates errors from thermal drift in the delaying sweep since both delays are affected equally. Measurement accuracies within 1% can be achieved. However, the technique adds about \$1,000 to the scope's cost when it employs a microprocessor and a digital-to-analog converter as well as two comparators.

The microprocessor monitors the main sweep setting and generates the result: $\Delta T = k \Delta V$. The d-a converter is necessary because signals from the microprocessor must be converted to analog form before being supplied to the comparators. A summing network adds the delta delay signal (the operator-selected variation in interval) to the first delay signal in order to produce the second delay signal.

However, simpler circuitry can provide the dual delayed-sweep technique at lower cost. Such an approach is incorporated in the DM44 option to the Tektronix 400 series of portable oscilloscopes. The price of the option, described in the main article, adds \$325, or \$410 with temperature probe to the basic oscilloscope price.

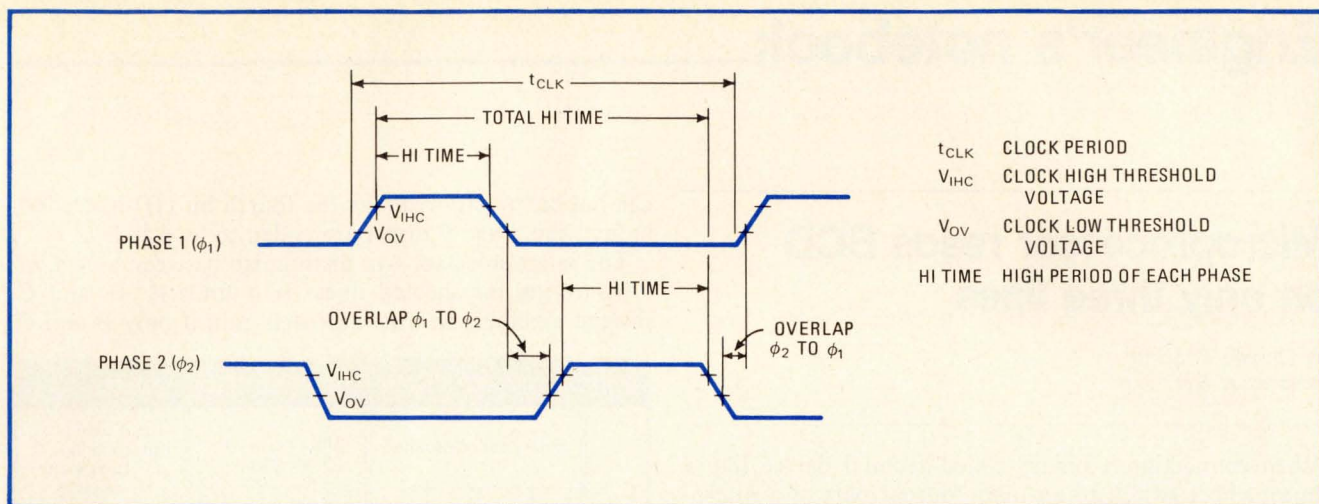

2. Checking out a chip. Microprocessor testing often involves the measurement of various time intervals: clock period, or cycle time; pulse width, or the high period for each clock phase; total high time for both clock phases, and the delay between phases, or clock overlap.

7. Subtract the step 3 reading from the step 6 reading. Multiply the result by the main sweep's time/division setting, ensuring that the decimal point is properly positioned.

The result is an accurate measurement of the time interval, assuming no errors in dial readings, trace alignments, or calculations. These error sources are eliminated in the two-step measurement by the DM44 shown in the photographs on pp. 114-15:

1. Set the scope in its intensified mode and use its delay-time dial and the DM44's delta-time dial to position two intensified spots at the beginning and end of the time interval.

2. Switch the scope to its delayed-sweep mode and use the delta-time dial to superimpose the end of the interval on the beginning. The LED readout gives the value of the time interval with 1% accuracy. Switching to the DM44's 1/time mode will give a direct readout of the reciprocal of time.

As well as decreasing the probability of error, elimination of dial readings and computations reduces measurement time. Time-interval measurement becomes so easy that it is almost second nature to make measurements.

Applying the technique

The dual delayed-sweep technique allows easy checking and adjustment of timing on computers and their peripherals and other digital electronic equipment. A particularly useful application is in testing microprocessors—during design, while troubleshooting, and in servicing. For a typical microprocessor system, the scope operator may want to measure a number of different time intervals (Fig. 2): clock period, or cycle time; pulse width, or the period in which each clock phase is high (HI time); the delay between phases; or clock overlap, and total HI time. The DM44 simplifies making these measurements.

To measure clock period, the operator sets the scope's vertical mode to channel-1-only and its horizontal mode to main-sweep-intensified and the DM44 to its time mode. He sets the main sweep to display several clock periods and the delay sweep for the desired resolution.

This displays only the phase 1 clock pulse. Using the two-step procedure described gives the scope operator a readout of the clock period.

To then measure pulse width, the operator leaves the scope's vertical mode in channel-1-only and returns the horizontal mode to main-sweep-intensified. Using the scope's delay-time dial and the DM44's delta-time dial, he moves the two intensified spots to the beginning and end of the HI-voltage threshold level (V_{IHC}) of a single clock pulse. Then he switches the scope's horizontal mode to delayed sweep so that the rising and falling edges of the pulse intersect at the V_{IHC} points. The LED readout will show the HI time for phase 1. For the phase 2 pulse width, the operator switches the scope's vertical mode to channel 2 and repeats the procedure.

Another variation

To measure clock overlap, the operator sets the vertical mode to alternate and the horizontal mode to main-sweep-intensified. Both channels now can be seen on the cathode-ray tube. After setting the two intensified spots at the LO-voltage threshold levels (V_{OV}) of phases 1 and 2, he switches the horizontal mode to delayed-sweep. Using the delay-time-position and the delta-time dials, he sets the V_{OV} levels to the same vertical graticule line. The readout will show the clock-overlap time from phase 1 to phase 2. To measure overlap from phase 2 to phase 1, a similar procedure may be used.

Total HI time can be measured by once more setting the vertical mode to alternate and the horizontal to main-sweep-intensified. The operator sets the first spot at the start of the V_{IHC} level in phase 2. He switches the horizontal mode to delayed-sweep and adjusts the DM44's delta-time dial to set both V_{IHC} levels to the same vertical graticule line. The LED display then shows the total HI time of the two clock pulses.

These procedures are much simpler and less time-consuming than those of conventional time-interval measurements. The savings in time, as well as the elimination of possible measurement errors, means greater efficiency and economy of operation in critical applications. □

Microprocessor reads BCD on only three lines

by Darwin T. Scott
Albuquerque, N.M.

When connecting a binary-coded-decimal device like a thumbwheel switch to an input/output port of a microcomputer, you could free some valuable I/O pins if the switch could be coded on three lines instead of the usual four. But everyone knows that 4 bits are required to encode 10 digits—or are they?

A BCD switch can be coded on three lines if the I/O ports can switch from input to output. Figure 1 shows the necessary wiring configuration. A Motorola 6820 peripheral interface adapter is shown as the I/O device, but the bidirectional ports on other PIAs or the Fairchild F8 chip set would work equally well.

The thumbwheel switch is coded in BCD complement, the simplest and most widely used configuration; that is, a logic 0 is placed on an output line by shorting that line to the common terminal. Hence, all lines with a 0 output are shorted together. For example, setting the switch to 4 ties lines A (2^0), B (2^1), and D (2^3) together. Notice how the most significant bit (D) of the switch is rerouted to ground, and the common lead is left unconnected.

The table showing the BCD coding indicates that for digits 0 to 7 the decimal number is correctly coded on lines A, B, and C. For digits 8 and 9, however, the code

can not be directly read, as the fourth bit (D) is needed; in fact, the 8 and 9 digits are coded to look like 7s.

The microprocessor can distinguish between a 7, 8, or 9 by testing for shorted lines. If it finds A, B, and C shorted together, an 8 is indicated, and if only B and C

CODING INFORMATION FOR BCD ON THREE LINES										
Digit	Binary-coded decimal				Input with all lines set up as inputs			Input with zero output on line C and lines A and B set up as inputs		
	D (2^3)	C (2^2)	B (2^1)	A (2^0)	C	B	A	C	B	A
0	0	0	0	0	0	0	0	X	X	X
1	0	0	0	1	0	0	1	X	X	X
2	0	0	1	0	0	1	0	X	X	X
3	0	0	1	1	0	1	1	X	X	X
4	0	1	0	0	1	0	0	X	X	X
5	0	1	0	1	1	0	1	X	X	X
6	0	1	1	0	1	1	0	X	X	X
7	0	1	1	1	1	1	1	X	1	1
8	1	0	0	0	1	1	1	X	0	0
9	1	0	0	1	1	1	1	X	0	1

X = not applicable

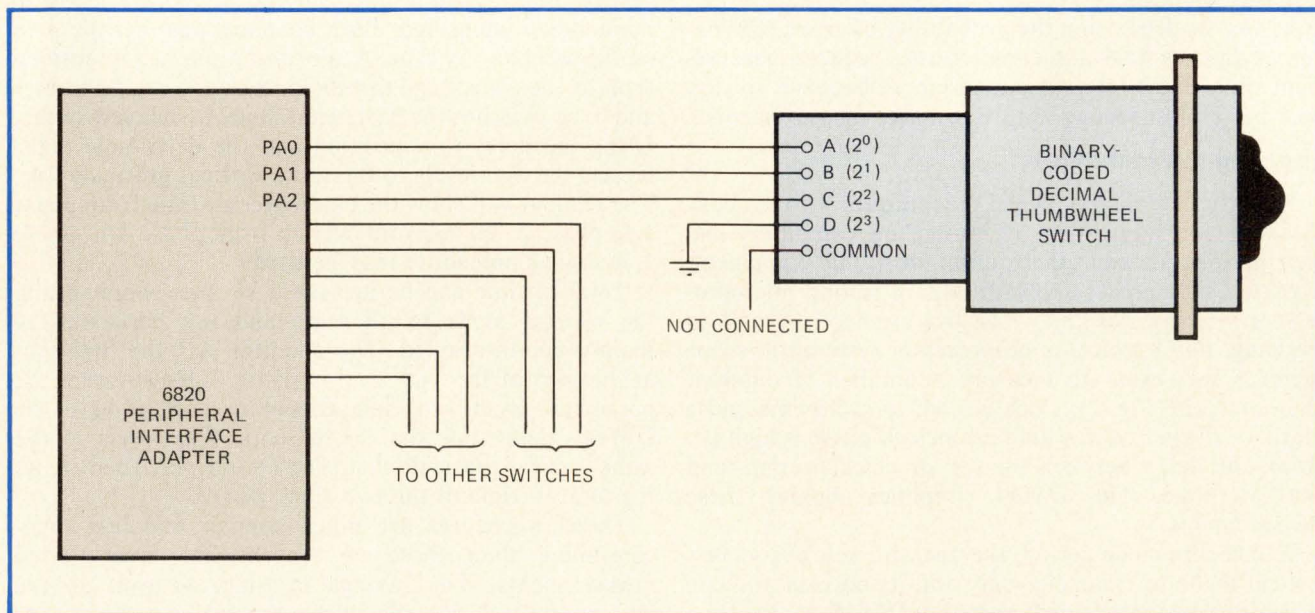

1. Three-line BCD? Binary-coded-decimal thumbwheel switches can be coded on three lines instead of four if the I/O port is switched to output to test for shorted lines. The 6820 peripheral interface adapter is shown, but any chip set with bidirectional I/O ports will work.

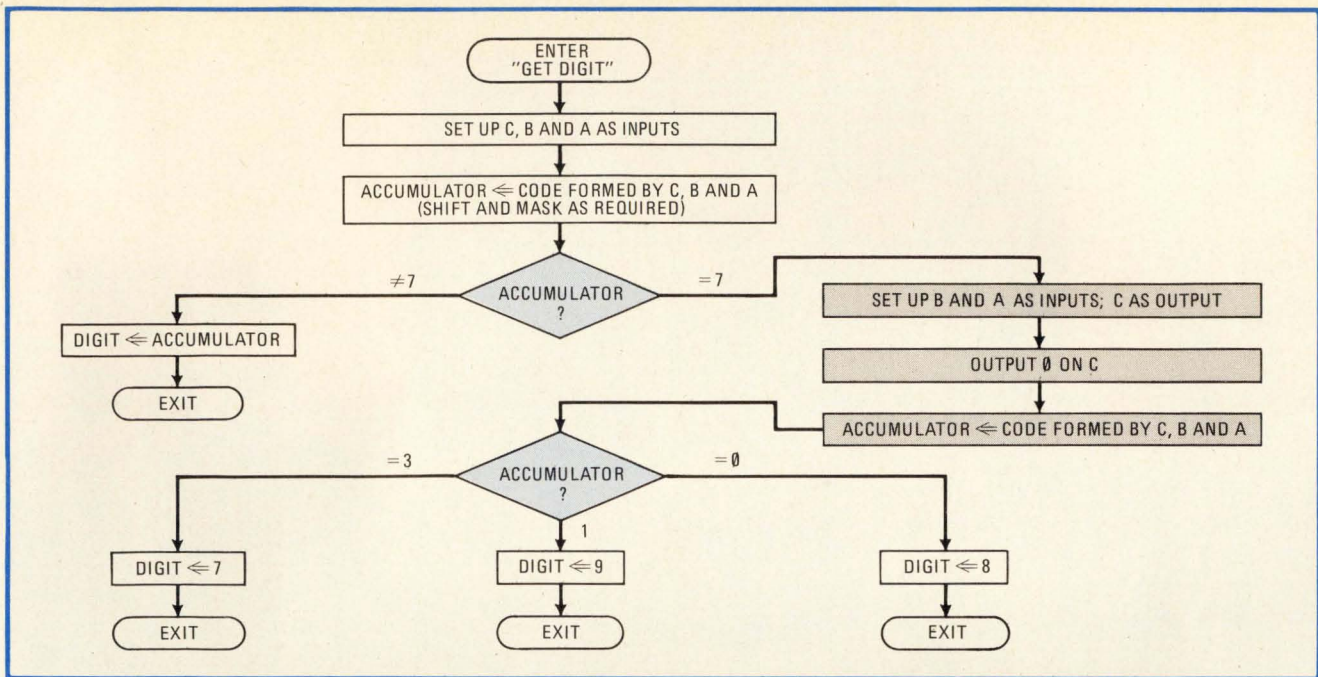

2. Procedure flow. This input routine, which requires about 50 more bytes than a conventional BCD-input scheme, discerns between digits 7, 8, and 9 by changing line C to an output and testing for a short between A, B, and C of the thumbwheel switch.

are shorted together, a 9 is indicated. Thus, using the I/O ports for output and testing for shorted lines, the CPU can acquire decimal information on only three lines.

Figure 2 shows the flow diagram of the procedure

used to determine the position code of the switch. Coding on three lines increases the input routine of the central processing unit from 10 to about 60 bytes, depending on the microprocessor used.

Calculator notes

Program analyzes spectrum of oscilloscope waveforms

by Alan D. Wilcox
Walter Kidde & Co., Charlottesville, Va.

Thanks to Fourier, 19th century scientists knew that any periodic wave shape can be described by a series of harmonically related sinusoidal components of varied amplitude and phase. Thanks to Fourier and this HP-25 program, you can perform spectral analysis accurately on any waveform displayed on an ordinary oscilloscope.

The analysis is straightforward. A number of equally spaced data points are taken from the waveform displayed on the scope's screen—the more points, the better the accuracy. A good guide, from sampling theory, states that accurate representation of a waveform requires sampling at a frequency at least twice as high as that of the waveform itself. If accuracy in the 10th harmonic is required, at least 20 points must be taken. But avoid sampling at exactly twice the highest harmonic to be calculated, as for example, 10 points to calculate the fifth harmonic. In such cases, the high-frequency sine wave would be repeatedly sampled at the same point on its curve.

Spectral analysis begins with an HP-25 programmed

as shown in the table. Next, key in the number of the desired harmonic, [J], followed by ENTER, and then the number of data points [N]. Keying R/S initializes the procedure, and 0.0000 is displayed, signalling that the calculator is ready for data-point entry. The value at each point is entered, followed by R/S. After each entry,

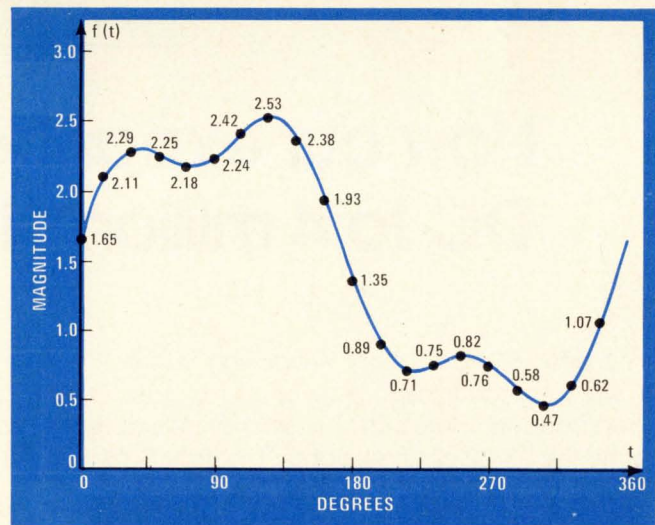

Oscilloscope display. A typical scope waveform is shown with data-point values that could be measured off the graticule. These data points, once entered into a suitably programmed HP-25, can yield accurate spectral information.

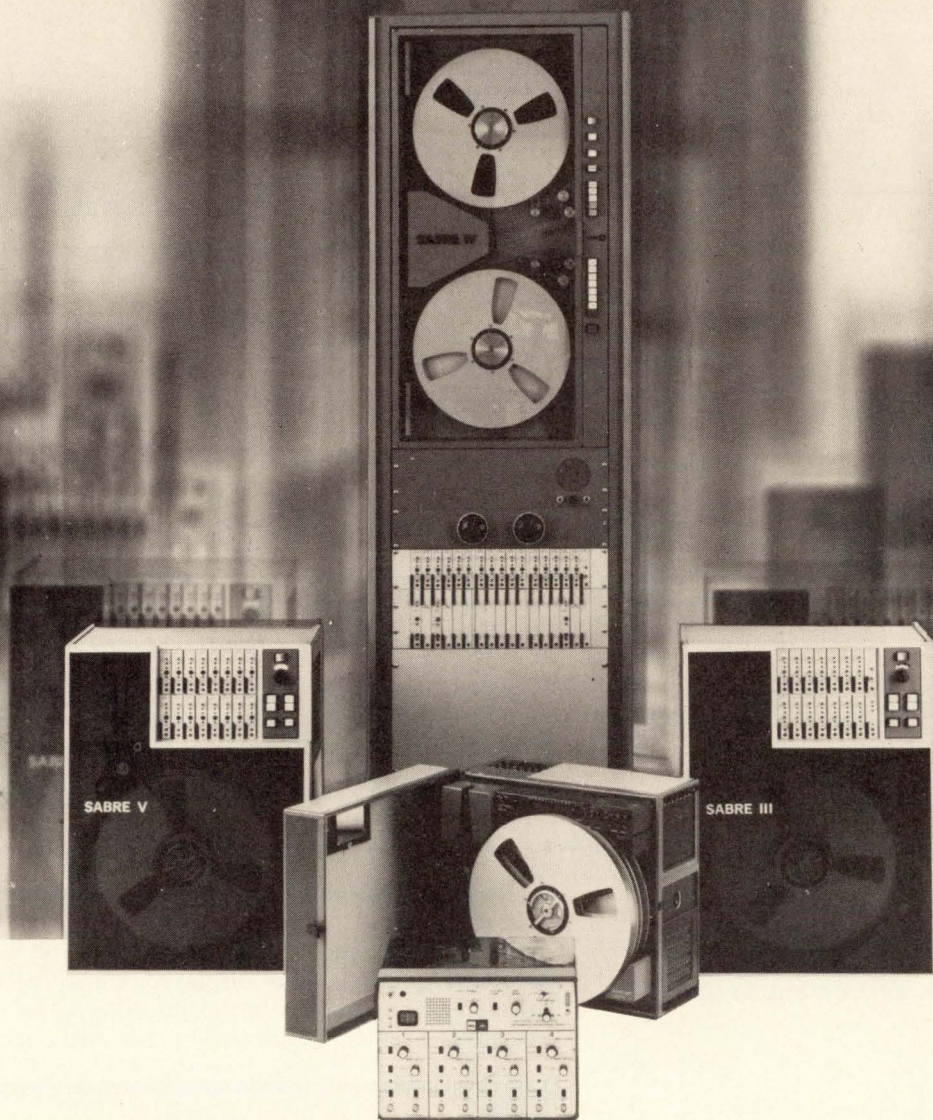

Now our expandable line offers DC to 4 million bits per second!

We offer PCM capability, in addition to Direct and FM electronics, in three of our recorder/reproducers. There's the 7 to 14 channel Sabre III and the 28/32 channel Sabre V, both IRIG all-band portable recorders; and the Sabre IV, a 7 to 48 channel laboratory recorder/reproducer.

In addition our line includes the new Sabre VI which offers superior performance plus ultra-portability, and the Tandberg TIR-115, a 4-channel, FM, 25-pound system.

Those basic five recorders are actually an almost unlimited line because each is designed and built to adapt to an amazing variety of functions. Just tell us what you want one to do!

For information write: Sangamo Data Recorder Division, P.O. Box 3347, Springfield, Illinois 62714. 217, 544-6411. Telex 406-461. Sales and service representatives worldwide.

SANGAMO WESTON
Schlumberger

HP-25 FOURIER ANALYSIS PROGRAM

LINE	CODE	KEY	COMMENTS
01	14 33	f REG	
02	14 11 04	f FIX 4	
03	15 32	g DEG	
04	23 01	STO 1	
05	03	3	
06	06	6	
07	00	0	
08	71	÷	
09	15 22	g 1/x	
10	23 06	STO 6	
11	22	R ↓	
12	23 00	STO 0	
13	00	0	
14	74	R/S	
15	23 02	STO 2	
16	24 05	RCL 5	i-1
17	24 00	RCL 0	J
18	61	X	T
19	24 06	RCL 6	T
20	61	X	
21	23 07	STO 7	T × J (i-1)
22	14 05	f COS	
23	24 02	RCL 2	
24	61	X	
25	23 51 03	STO + 3	accumulate A
26	24 07	RCL 7	
27	14 04	f SIN	
28	24 02	RCL 2	
29	61	X	
30	23 51 04	STO + 4	accumulate B
31	01	1	
32	23 51 05	STO + 5	
33	24 01	RCL 1	
34	24 05	RCL 5	
35	14 61	f x ≠ y	
36	13 14	GTO 14	display i
37	14 74	f PAUSE	display last i = N
38	24 03	RCL 3	
39	24 04	RCL 4	
40	15 09	g → P	
41	02	2	
42	61	X	
43	24 01	RCL 1	
44	71	÷	
45	74	R/S	display C _N
46	13 01	GTO 01	

initialization

i-1

J

T

T × J (i-1)

accumulate A

accumulate B

display i

display last i = N

display |C_N|

Repeat calculation for each f_i

INSTRUCTIONS:

- Key in program.
- Enter harmonic number: [J], ENTER ↑
- Key in number of data points: [N], R/S
- Input value of function: [f_i], R/S
- After last input, f_N, magnitude is displayed.
- Exchange x and y registers to display phase: x ↔ y
- For next harmonic, press [J], ENTER ↑, etc.

REGISTERS

R ₀	J
R ₁	N
R ₂	f _i
R ₃	A
R ₄	B
R ₅	i
R ₆	T = 360/N
R ₇	T × J (i-1)

NOTE: J < N/2 REQUIRED

the index (i) of that value is displayed. Once the last data point (i = N) is entered, the program automatically solves for and displays the magnitude of the Jth harmonic. The phase angle, located in the y register, is displayed by exchanging the contents of the x and y registers.

Fourier analysis tells us that we can represent a function f(t) in a way best suited to spectral calculations by the infinite series:

$$f(t) = a_0 + \sum_{n=1}^{\infty} c_n \cos[(2\pi n t/T) + \theta_n]$$

where c_n = (a_n² + b_n²)^{1/2}, θ_n = tan⁻¹(-b_n/a_n), and T is the period of the fundamental wave, which for our purposes will be normalized to unity. Coefficient a₀ is simply the dc component of the signal, found by taking the average of the function over a single period.

Coefficients a_n and b_n are found by integrating:

$$a_n = 2 \int_0^1 f(t) \cos(2\pi n t) dt$$

$$b_n = 2 \int_0^1 f(t) \sin(2\pi n t) dt$$

Program efficiency is realized by approximating the integrals using the trapezoidal rule:

$$\int_0^T f(dt) \approx \sum_{i=1}^N 1/(2N) [f(t_i) + f(t_{i+1})]$$

The coefficients may then be found by the summations:

$$a_n \approx 2/N \sum_{i=1}^N f(t_i) \cos[2\pi n (i-1)/N]$$

$$b_n \approx 2/N \sum_{i=1}^N f(t_i) \sin[2\pi n (i-1)/N]$$

where, since t₁ = 0, the t_i become (i-1)/N.

A typical problem might be to determine the level of the third harmonic in the waveform shown in the figure. To do so, it is necessary to measure at least seven equally spaced data points, but preferably 10 or 20 points for greater accuracy. The 20 points are entered into the program and yield a third-harmonic component that has an amplitude of 0.3 and phase shift of 30°. Using the data points, you can calculate the amplitude and phase of the second and other harmonics as well.

In addition, the HP-25 enables easy calculation of the rms values of the harmonics. The total rms value, V_{rms}, is the sum of the dc component a₀ and the ac component, V_{rms(ac)}. These values are related by the equation:

$$V_{rms} = (a_0^2 + V_{rms(ac)}^2)^{1/2}$$

and can be found using the statistical firmware:

- Enter each data point and hit the Σ+ key.
- Obtain a₀ by pressing x̄.
- Since register R₆ holds the sum of the squared values, and R₃ holds the index, obtain V_{rms} by taking the square root of the quotient R₆/R₃.

The actual function of time used to generate the waveform in the example is:

$$f(t) = 1.5 + \sin(t) + 0.3 \sin(3t + 30^\circ)$$

Note that, since the waveform is symmetrical about its dc level, it necessarily contains no even harmonics. □

Engineer's notebook is a regular feature in Electronics. We invite readers to submit original design shortcuts, calculation aids, measurement and test techniques, and other ideas for saving engineering time or cost. We'll pay \$50 for each item published.

String of diodes sets new hysteresis

A few diodes and a resistor will easily adjust the hysteresis of any Schmitt trigger, says M. S. Suresh of Bangalore, Ind. The voltage drops across diodes added to the input circuit do the job, independent of the upper trip point. A diode (or string of diodes) that has its cathode connected to the Schmitt input sets the upper point. **Then the lower one can be set to any lower number of diode voltage drops by placing another diode (or string) in inverse parallel across its upper-trip-point counterpart.**

However, there's a trick to getting different current paths for upper and lower points: connect a feedback resistor on the order of a megohm or so from the Schmitt trigger's output back to between the Schmitt input and the parallel diode network. Then the trigger's on/off condition will either forward- or reverse-bias the upper-trip or lower-trip diode strings. Zeners may be used in place of longer diode strings, of course.

The only point to keep in mind, adds Suresh, is that the output impedance of the signal source should be very much less than the feedback resistor. In most applications, this is no problem.

Counter/monostable combo gets back to 0 easily

Getting a decade counter to initialize to 0 when the power goes on is easy, says Barton A. Gravatt of Newfield, N.Y. Simply connect the counter's reset input to the Q output of a retriggerable monostable, such as the 74123. Then connect the +5-volt supply to the monostable's positive-transition triggering input. Use a 1-second RC time constant at the monostable's external R and C terminals. **When power is applied to both devices, the Q output will not go high for a second, avoiding contact bounce and resetting the counter.**

Getting more from your spectrum analyzer

If you've discovered there's more to spectrum analyzers than simple display of frequency spectra, you'll be interested in three application notes from Hewlett-Packard. They tell how to use the spectrum analyzer to **measure distortion, field strength, and noise figure.**

The distortion-measurement note (AN 150-11) describes harmonic and intermodulation distortion and explains the concept of intercept point in measuring intermodulation distortion. The field-strength note (AN 150-10) discusses antenna calibration factors and gives an example of measuring the field strength emitted by a garage-door opener. The noise-figure note (AN 150-9) describes a technique that, although perhaps not as precise as conventional noise-figure meters, allows frequency-selective noise-figure measurements without a calibrated noise source. Write to the Inquiries Manager, Hewlett-Packard, 1501 Page Mill Rd., Palo Alto, Calif. 94304

Get a jump on Uncle Sugar

It will soon be time again to calculate your income tax. One aid you might find worthwhile is the 1977 Tax Guide for Engineers, which has over 200 pages showing engineers how to save money on their taxes. The book reviews recent changes in tax law and explains several legal means of making the best of the tax bite. **The publisher guarantees that if you don't save at least \$100 on your taxes, you may return the book within 30 days for a refund.** It's available from Academic Information Service Inc., P.O. Box 31391, Washington, D.C. 20031, for a (tax-deductible) \$14.95, plus 85¢ for postage and handling.

Stephen E. Scrupski

Macrodyne fills the megahertz gap.



The ERDAC 1100 True 8-bit A/D and storage at 20 MHz. Now at a reasonable price.

Macrodyne's new model 1100 transient recorder now provides the user the capability to monitor transients at a 20 MHz rate for a reasonable price. In fact, the Macrodyne ERDAC 1100's price/performance ratio is twice that of competitive models.

The unique A to D converter is the heart of the ERDAC 1100. Accuracy is unsurpassed and resolution is .4%. That's performance you can count on.

The Macrodyne 1100 provides repetitive outputs in analog form for analysis on display devices. Plus, the 1100 has pre-triggering and post-triggering abilities up to 8900 points. And, a storage capacity of 1024 words, with additional capacity available. The 1100 also provides the optional flexibility for computer control and digital output.

Reliability is assured by Macrodyne's performance in the industry. We back our products with a full one-year guarantee and the excellence of service which has come to be synonymous with

Macrodyne. Drop us a line today or give us a call. We'd like you to discover how the Macrodyne ERDAC 1100 can solve your transient measuring requirements.

Tell me more.

Name _____

Title _____

Company _____

Address _____



macrodyne, inc.

1900 maxon road • p.o. box 1079 •
schenectady, n.y. 12301 • 518/372-5619

Stretch your test instrument budget

Does a scope always have to be expensive to meet your needs? At B&K-PRECISION we don't think so. B&K-PRECISION offers a full line of scopes that give you the performance and features you need, at substantial cost savings... plus the advantage of immediate delivery and 10-day free trial through local distributors.

B&K-PRECISION to high-priced

B&K-PRECISION has taken a no nonsense, cost-effective, approach to oscilloscope design. All our scopes will trigger at frequencies typically 50 to 100% beyond their rated band-width. They are rugged, dependable instruments, designed to match the features and performance of far more expensive scopes, without matching their high price. An important part of our approach is that you shouldn't have to buy more scope than you need to get the features you want. Before making your next purchase, compare the features and performance you require with what we have to offer. You'll discover that your budget is a lot bigger than you first thought!

30MHz Dual-Trace 5" Triggered Scope with Signal Delay

For the engineer who requires a full-feature 30MHz scope

- Built-in signal delay line permits viewing of high-frequency pulse risetimes
- Triggers on signals up to 50MHz
- Rise time 11.7ns
- 20 calibrated sweeps—0.2 μ S/cm-0.5S/cm
- Built-in high and low-pass filters
- 5mV/cm vertical sensitivity
- Illuminated graticule
- TTL compatible intensity modulation
- X-Y capability using matched DC amplifiers
- P31 blue phosphor
- Internal .5Vp-p \pm 1% calibration source
- 5mV/cm horizontal sensitivity.

Model 1474 \$930 (Including two 10:1/direct probes)

15MHz Dual-Trace 5" Triggered Scope

Premium features and performance in a 15MHz dual-trace scope

- Ultra—flat in-band response with smooth rolloff past 15MHz
- Triggers beyond 27MHz
- 24ns risetime
- 19 calibrated sweeps—0.5 μ S/cm-0.5S/cm
- 10mV/cm vertical sensitivity
- Algebraic addition and subtraction
- Illuminated graticule
- X-Y capability using matched DC amplifiers
- P31 blue phosphor
- Internal calibration source
- Built-in TV sync separator
- For fast setup, mode automatically shifts between CHOP and ALTERNATE as you change sweep times.

Model 1472C \$720 (Including two 10:1/direct probes)

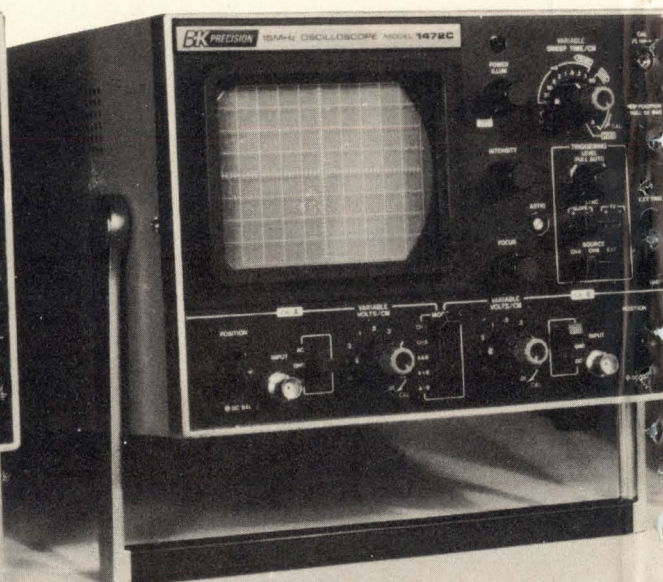
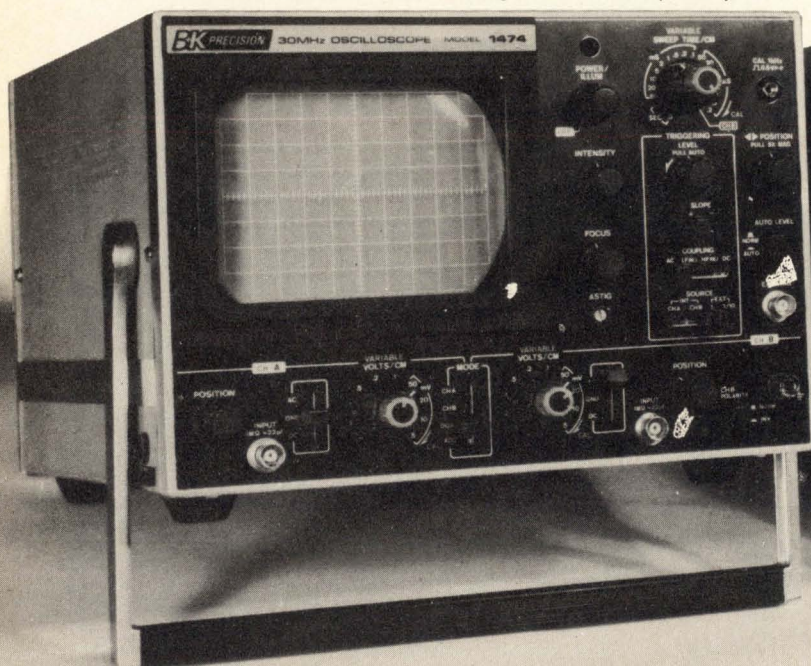

without stretching your standards... has an alternative oscilloscopes

10MHz Dual-Trace 5" Triggered Scope

Our lowest-cost dual-trace scope more than fills the need in applications where extended bandwidth isn't required

- Triggers beyond 15MHz
- Mode automatically shifts between CHOP and ALTERNATE as sweep time is changed
- 18 calibrated sweeps— $1 \mu\text{S}/\text{cm}$ – $0.5\text{S}/\text{cm}$
- 35nS risetime
- P31 phosphor
- X-Y capability using matched DC amplifiers
- Internal calibration source
- TTL compatible intensity modulation
- $10\text{mV}/\text{cm}$ vertical sensitivity

Model 1471B \$570
(including two 10:1/direct probes)

10MHz 5" Triggered-Sweep Scope

A 5" triggered scope with TTL compatible Z-axis

- $10\text{mV}/\text{cm}$ vertical sensitivity
- 35nS risetime
- 18 calibrated sweep ranges— $1 \mu\text{S}/\text{cm}$ – $0.5\text{S}/\text{cm}$
- 5x magnification sweeps to $.2 \mu\text{S}/\text{cm}$
- Vectorscope capability
- Internal calibration source
- Internal TV sync separator
- P31 phosphor
- 11-position vertical attenuator, calibrated in convenient 1/2/5 step sequence
- Built-in calibration source.

Model 1461 \$470
(including 10:1/direct probe)

10MHz 3" Triggered-Sweep Scope

Meets the demands for an uncompromising ultra-compact triggered-sweep scope

- 19 accurate sweep ranges
- Accurate 11-position vertical attenuator
- $10\text{mV}/\text{div}$ vertical sensitivity
- Front panel vectorscope capability
- Internal calibration source
- Only $5.75 \times 7.9 \times 12.9$ • Weighs only 13 lbs
- Capable of writing speeds up to $0.1 \mu\text{S}/\text{div}$ with 5x magnification.

Model 1431 \$420
(not including probe)

5MHz 3" Compact Scope

Ideal for many dedicated applications, freeing more expensive scopes from monitoring tasks

- $10\text{mV}/\text{div}$ vertical sensitivity
- Direct deflection terminals for waveform display to 450MHz
- Only $6 \times 7.5 \times 12$ • Weighs just 8.5 lbs
- 600 Vp-p maximum input voltage
- Can be externally synced.

Model 1403A \$219
(not including probe)



Save up to 50% on probes!

B&K-PRECISION has engineered a full line of cost-effective probes to meet your needs. Our probes are designed for complete interchangeability with those of leading "ultra-sophisticated" brands, giving you compatible performance at about half the price.

FOR IMMEDIATE DELIVERY,
or 10-day free trial, contact your local B&K-PRECISION distributor. Ask him for Catalog BK-77 with complete information on B&K-PRECISION oscilloscopes, probes and more than thirty other fine instruments, or contact us directly.

B&K PRECISION
PRODUCTS OF DYNASCAN

6460 W. Cortland Avenue, Chicago, IL 60635 312/889-9087

For product information circle 124

For product demonstration circle 125

Fujitsu semiconductor memories...

Unsurpassed performance
and reliability.



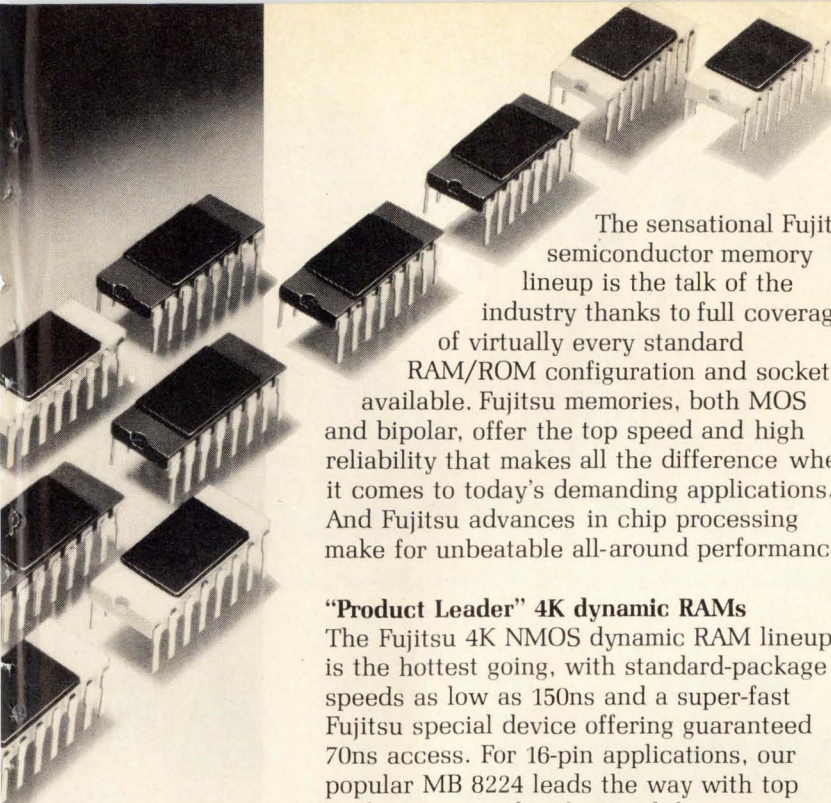

The sensational Fujitsu semiconductor memory lineup is the talk of the industry thanks to full coverage of virtually every standard RAM/ROM configuration and socket available. Fujitsu memories, both MOS and bipolar, offer the top speed and high reliability that makes all the difference when it comes to today's demanding applications. And Fujitsu advances in chip processing make for unbeatable all-around performance.

"Product Leader" 4K dynamic RAMs

The Fujitsu 4K NMOS dynamic RAM lineup is the hottest going, with standard-package speeds as low as 150ns and a super-fast Fujitsu special device offering guaranteed 70ns access. For 16-pin applications, our popular MB 8224 leads the way with top performance and a choice of three versions with access to 200ns. And more is coming, with our MB 8227 device (featuring gated CAS and page mode as standard) to be available in the near future. The MB 8107 is our 22-pin package "leader", offering four versions to 150ns. And when it comes to super-fast 4K applications, the Fujitsu MB 8215 wins running away; you get access times of 100ns and 70ns to choose from, and a great speed-power product for economical operation. Yes, Fujitsu 4K dynamic RAMs win the speed race "hands down".

Full-coverage 1K static RAMs

The Fujitsu 1K static RAM lineup is now bigger than ever. For high-speed sockets, the MBM 2115/25 devices give you superior 16-pin product selection with both open-drain and 3-state outputs available—and with access times as low as our soon-to-be-available 45ns

version. The MB 8101/11/12 chips second-source the industry-standard 22/18/16-pin devices, respectively, and with two versions each to choose from. Fujitsu 1K statics—coverage and performance to meet your exact memory needs.

Ultra-fast bipolar lineup

Fujitsu bipolar RAMs are available in standard bit sizes from 128-bit to 1K, and offer the speed advantages of DOPOS and fine-pattern processing. The Fujitsu MB 7047 (128-bit) ECL memory, with 14ns guaranteed access time, is typical of our high-performance bipolar devices. You also have a choice of any of six other devices including our 15ns 256-bit ECL RAM (the MB 7042), our 35ns 1K ECL device (the MBM 10415A), and our 45ns 1K TTL memory (the MBM 93415A).

Two-speed 8K EROM choice

The Fujitsu MB 8518 8K EROM, with two speed versions for greater selection convenience, is the chip everyone's looking for. Fully UV erasable, and pin-for-pin compatible with your present device, the high-performance MB 8518 makes for superior experimentation and fast turn-around. And as part of our "total support" program, we also have the MB 8308 mask programmable 8K ROM (also with two speeds) for systems initially developed using the MB 8518.

99%-programmable ROMs with fast access

Superior Fujitsu technology gives you the top PROM lineup available today. You get wide coverage (four bit sizes to 4K), both pull-up and 3-state output versions, fast access times, and much more. And Fujitsu PROMs are the first to offer guaranteed 98% (typically 99%) programmability thanks to our unique testing after packaging.

Fujitsu high-performance memories. They're available right now for your most advanced memory needs. Faster, more reliable and with the finest processing technologies, you're assured of the finest performance no matter which you choose. And there are more coming—like our sensational 16-pin 16K RAM (with 150ns access time) and our 18-pin 4K static. From Fujitsu, the semiconductor memory leader. Call or write now for more information to Fujitsu America, Inc., 2945 Oakmead Village Court, Santa Clara, California 95051, phone: 408-985-2300, telex: 357402, twx: 910-338-0047. You'll be glad you did.



FUJITSU LIMITED

Communications and Electronics

Circle 127 on reader service card

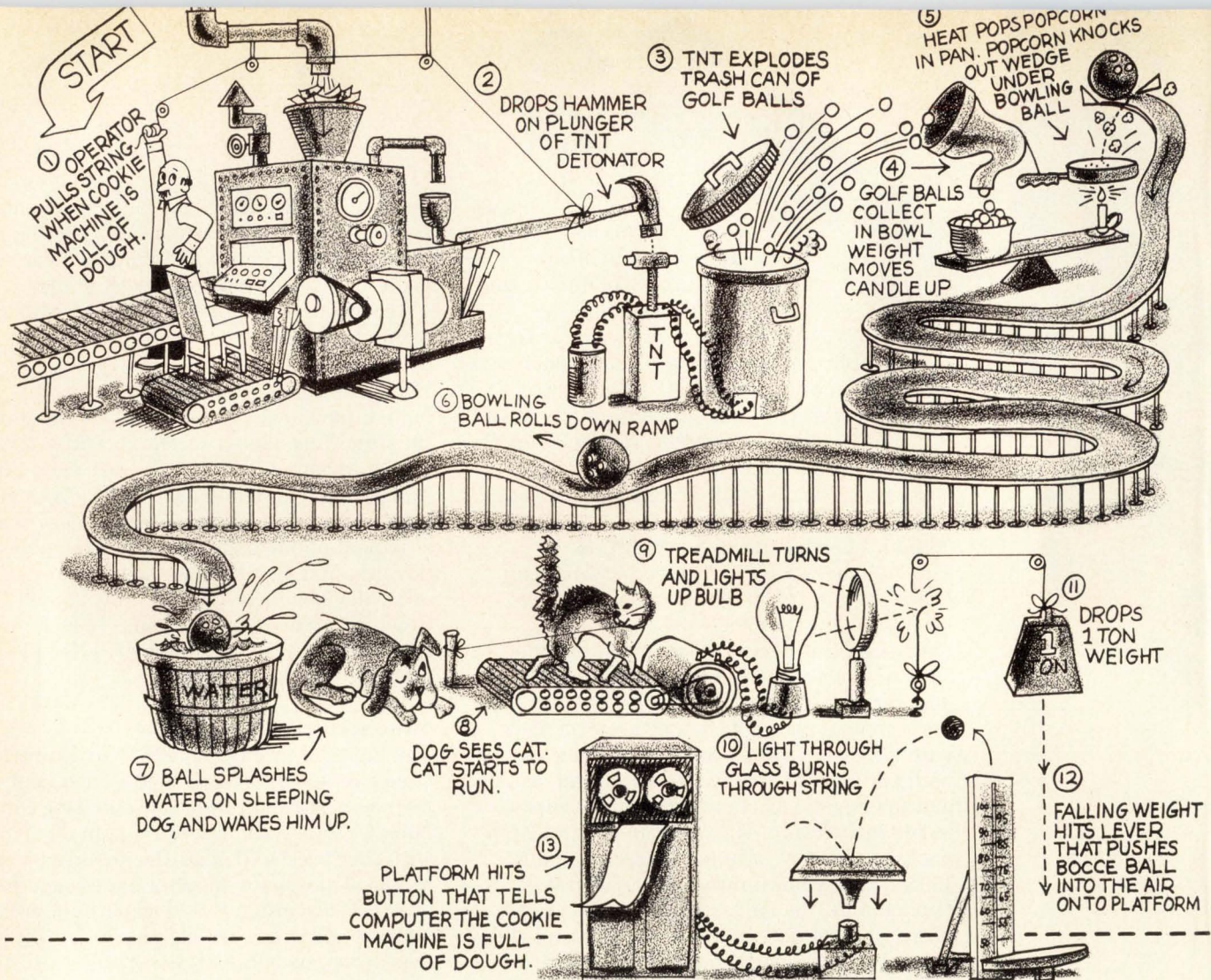

How to avoid the interfacing nightmare.

If you've got a computer, the easiest way to avoid the kind of nightmare interfacing can become with *anybody's* machine is to simply come to us — the world's largest supplier of interface modules.

Besides being number one in sheer volume, we're also number one in technology. With a new line of microcomputer products for the LSI-11: A DMA module, an expansion backplane that doubles card capacity, and a foundation module for custom interfacing. Plus a new

line of high density wire wrap cards for our larger machines. All part of our substantial library of off-the-shelf solid state modules and compatible hardware featuring the best cost-performance ratio in the business.

The Logic Products Group can also help you establish new designs, give all kinds of applications assistance, even develop custom designs from scratch.

Why not send for our new Logic Handbook describing all our products. It'll give you a pretty good

idea of how we can take on the interfacing nightmare.

And turn it into one sweet dream.

For your free Logic Handbook, call 800-225-9480 (Mass. 617-481-7400 ext. 6608). Or write: Components Group, Digital Equipment Corp., One Iron Way, Marlborough, Ma 01752. Canada: Digital Equipment of Canada, Ltd. Europe: 81 Route de l'Aire, 1211 Geneva 26, Tel. 42 70 50.



digital
COMPONENTS
GROUP

ICs streamline plasma-display units

Microprocessor-controlled terminals, designed as 'second-generation' peripherals, are reduced in size, price, and electrical complexity

by Larry Waller, Los Angeles bureau manager

Although compact, light-weight plasma-display terminals have been available since 1971, their high cost has limited them primarily to dedicated military applications. Besides the price of up to \$30,000 each, another barrier to expanded use has been a complex and bulky electronics package, implemented with discrete components.

However, Interstate Electronics Corp. of Anaheim, Calif., has spent a year in developing a family of four plasma terminals that the firm calls the "second generation," since they are generally smaller, cheaper, and perform better than earlier models.

After delivering about 35 first-generation plasma terminals to military customers in its three years in the business, Interstate's redesign goal was to come up with a general-purpose computer-peripheral display. "It is meant to be a mass-market product, rather than a one-shot dedicated version," says Les Turner, applications manager of the project. "That's why we took the family approach, rather than concentrating on a single product." (A rack-mounted and a desktop model are shown in the photo.)

Turner calls the changes in the second-generation terminals "both obvious and subtle." Most apparent is the circuitry redesign and replacement of more than 4,000 discrete parts with fewer than 1,000 integrated circuits, mounted on only four boards. This permits a weight reduction, not including the keyboard, from 125 pounds to about 40 lb. or less for each terminal.

The dimensions have been cut significantly. The 10-inch depth of one model is only half that of

previous displays. The width was shaved from 24 in. to either 18 or 13 in., depending on the model, and the height was reduced from 20 in. to either 19 or 14 in. In addition to cutting size and weight, the simplified design and fewer parts allow more efficient assembly techniques, such as flow-soldering, and therefore lower cost, Turner points out.

The subtle improvements were made in the three redesigned electronics elements. The principal one is employing a single sustainable waveform voltage, rather than the dual voltages used in the past models. This cuts by about 70% the number of components required in the logic control of the waveform-generation function, Turner says. In developing the new family, engineers recognized that a single variable voltage to only one coordinate of the display matrix could generate and sustain alphanumeric and graphics

on the panel face. The company calls this advance important because it eliminates the synchronization problem involved in handling two complex high-frequency waveforms.

In the function of driving the 512 matrix points that are illuminated on the display face, Interstate has substituted IC chips that each drives four points for the 512 diode-transistors previously required. Texas Instruments, which supplies these chips, is now working on 32-point drivers as a further improvement.

Redesigning the power supplies for the terminal was a significant task because nine different voltages were needed, up to 195 v for igniting the neon gas inside the panel sandwich. The existing design used linear supplies that were only 40 to 50% efficient, a characteristic that was improved to 80%, with all supplies contained on one board.

For microprocessor control, Inter-

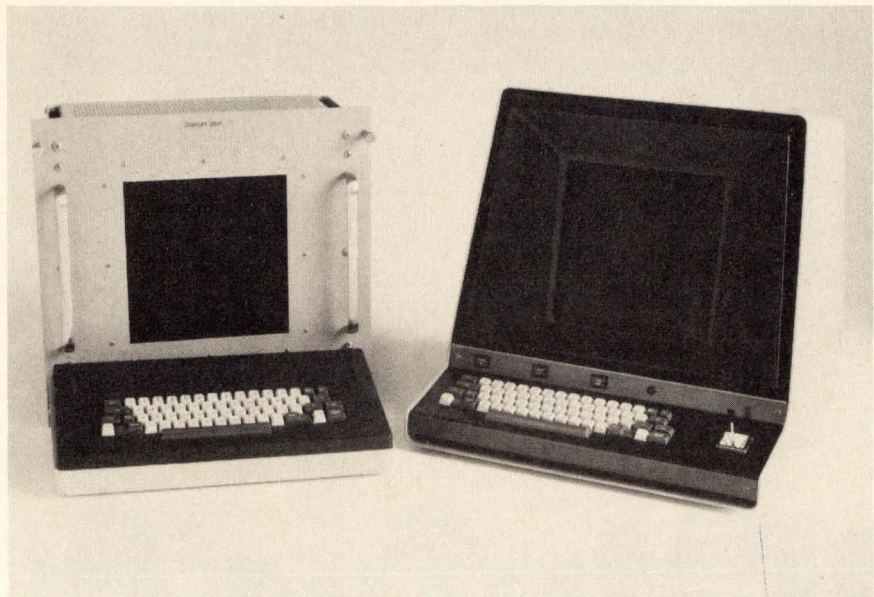

Prime source for capacitors of Mica-Paper & TEFLON* Custom Electronics . . . Growing Bigger to Serve You Better

Custom Electronics has expanded its capabilities and facilities to meet your growing demand for mica capacitors. Plant size alone has increased 30% in the past year; and is seven times its original size.

Our recent acquisition of Balco capacitors expands our product line to include high precision capacitors of TEFLON* and eliminates shopping a dozen sources for capacitors.

We emphasize "rapid reaction time" — the time from your inquiry to quote and from your order to delivery — because your time means money! An IBM System 3 computer handles your order more efficiently, and expedites production.

Fast delivery is half the story. Every Custom Electronics capacitor must meet the toughest quality control standards in our 11 Test Centers,

because you cannot afford failure in the field.

Find out how Custom Electronics can help your production plans.

Send for FREE Brochure which describes the facilities, the products, and the philosophy that have made Custom Electronics the source for capacitors of mica-paper and TEFLON*.

CUSTOM ELECTRONICS, INC.
12 Browne Street, Oneonta, N.Y. 13820
Ph: 607-432-3880 TWX: 510-341-8292

*DuPont's registered trademark.

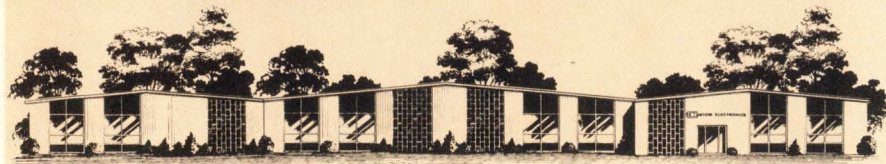
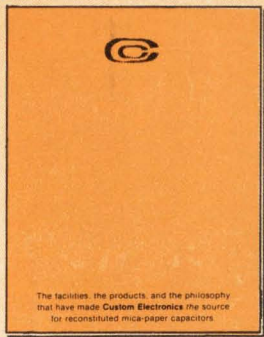

New products

state settled on the AMD 2901 4-bit slice whose 330-nanosecond execution time allowed a configuration producing what Turner calls the "fastest-writing terminal on the market." The need for speed is in generating graphics. For the 5-by-7-in. unit, the rate is 8,333 characters a second; for the 7-by-9-in. model, 6,250 characters a second. Each terminal uses 12 microprocessor chips.

Faster operation includes doubling the data-transfer rate over the first-generation rate to 19,200 bauds, an advantage in time-sharing since the "computer can dump data fast and get off," Turner points out.

Varied usage. The new Interstate family is divided into units for commercial and for military use. At \$8,900, the low-end PD1000 terminal is a commercial product intended for such applications as computer laboratories. The next step up, the PD2000, uses a combination of commercial and military-screened parts for more stringent environments. The two top terminals, the PD3000 and PD4000, are higher-priced, with the top-of-the-line PD4000 fully qualified for military environmental requirements and selling for \$16,000. These two units also are smaller, 13 in. wide by 11 in. deep by 14 in. high. The lower-cost models measure 18 by 10 by 19 in.

Interstate expects production models of the new family to be available in March, with orders requiring about 90 days to fill. Turner says that marketing of the new family of plasma displays as general-purpose computer peripherals required development of extensive software and graphics packages. These represented about 10% to 15% of the total budget.

The four-model family is designed to be compatible with the PDP-11 minicomputer. Its modular design permits interchangeability, and design simplicity ensures that no adjustments need be made by the user.

Interstate Electronics Corp., Subsidiary of ATO, 707 Vermont Ave., P.O. Box 3117, Anaheim, Calif. 92803. Phone (714) 772-2811 [338]

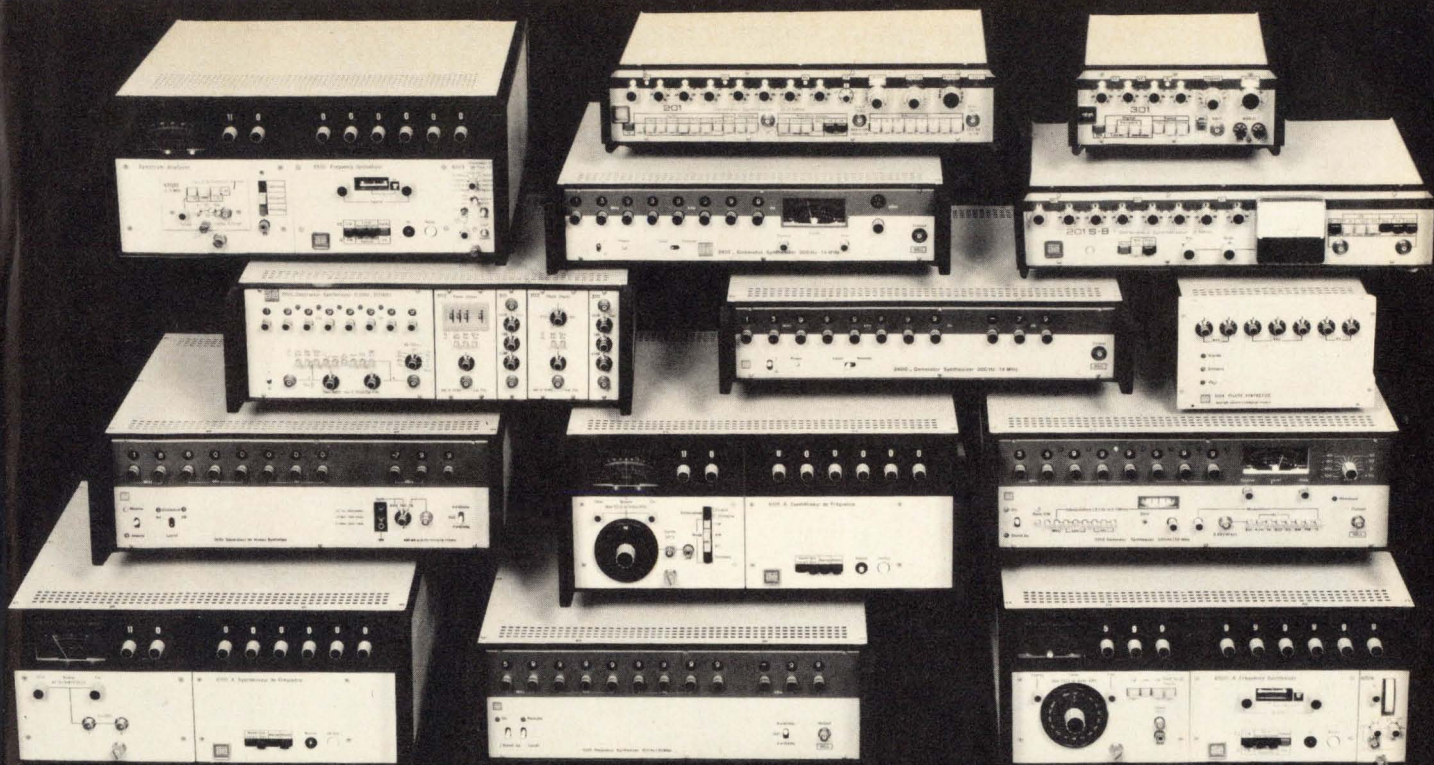

Let ADRET put you on the right frequency

It's never easy to pick the right frequency synthesizer when you have to pore through a thick catalog of all kinds of instruments to make your choice.

Adret makes it easy. Frequency generators are our only business and you'll find more synthesizers in our new catalog than anywhere else. You're sure to find an Adret synthesizer that meets your needs at a very competitive price.

You see, we've been frequency-synthesizer specialists for 10 years now. You get a choice of 15 synthesizers in our 1977 catalog, not counting specials and OEM versions. The frequencies run as low as 0.01 Hz and as high as 600 MHz. But since we offer so many models, you don't end up paying for spectrum and features you don't need.

You get the most for your instrument dollar.

- Our line :**
- Series 6000.** Choose from two mainframes and three plug-in units that cover the range from 10 kHz to 600 MHz, Programmable in frequency and level, AM/FM and PM modulation.
 - Series 3300.** Frequencies from 300 Hz to 60 MHz. The general-use version has AM/FM modulation. For systems, there's a version with programmable frequency and level.
 - Series 2400.** A frequency and level generator. Three versions cover a range from 300 Hz to 18.6 MHz. There's a choice of output impedance and offset frequency for selective measurements.
 - Series 200.** Two versions, for systems and general use, cover the frequency range from 0.1 Hz to 2 MHz.
 - Series 3100.** Generators with a choice of waveforms from 0.01 Hz to 200 KHz, with programmable phase shift and frequency sweep.

so let ADRET guide you to the

right frequency synthesizers ; circle our number on the reader service card, return the coupon or write us on your letterhead. We'll rush you our new 1977 catalog. It gives you a lot of practical tips about frequency measurements as well as the details on our hardware.



1630 Manheim Pike,
Lancaster,
Pennsylvania 17601,
Telephone (717) 569-7059,
TWX 510-672-0516

Circle 131 on reader service card

Name : _____
Firm : _____
Address : _____
City : _____
State : _____
Country : _____

Title : _____
Phone : _____



PHILIPS

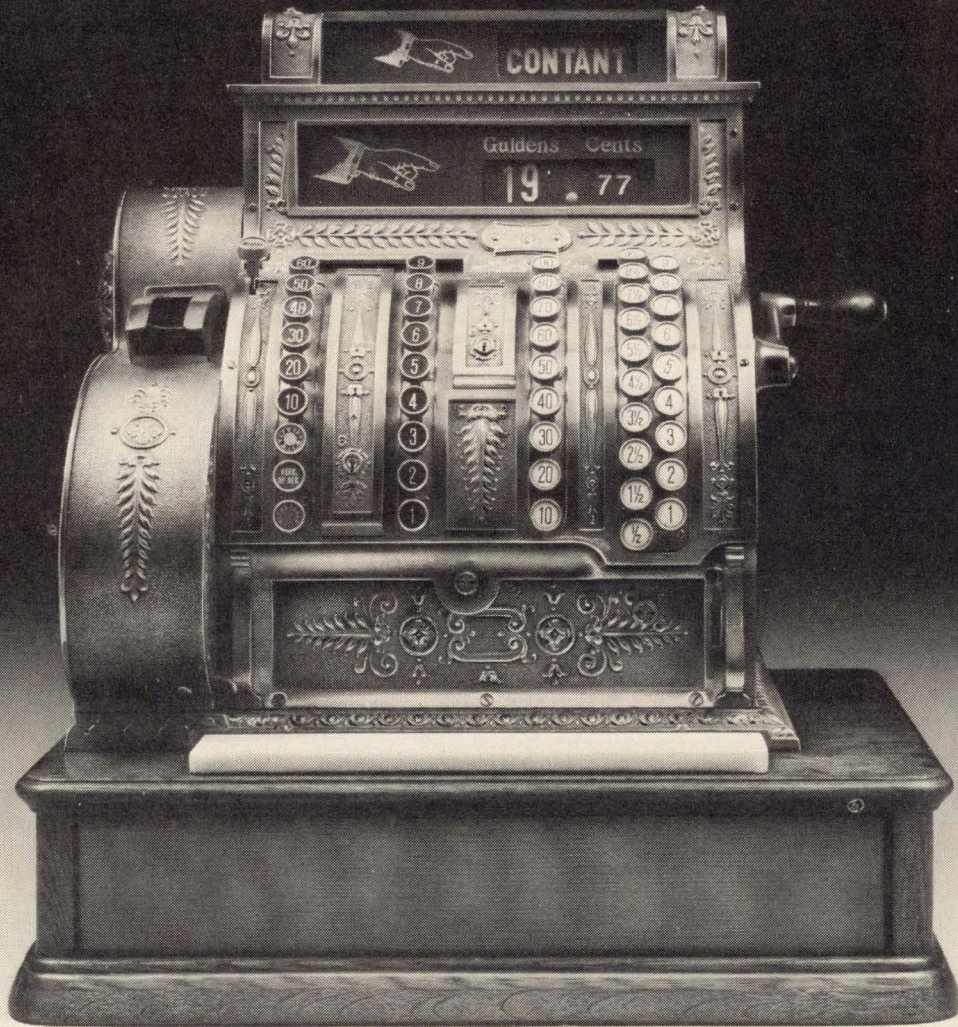

Cash in with us.

Times have changed.

Today's market demands a labour-saving integrated system for recording sales data. A complete system in which data are automatically registered on cassette at the point of sale. The Philips Data Logger is a vital part of such a system.

The Philips Data Logger is based on the Philips digital cassette recording system which is already proved in many different data-recording applications, and meets ECMA-34 specifications.



The Data Logger can be interfaced with electronic cash register systems currently in use or under development. Sales data recorded on cassette can

conveniently and economically be processed by computer to meet all accounting requirements.

Cash in on the electronic cash register market with the Philips Data Logger. It makes electronic cash register systems complete.

For information about the Philips Data Logger or other cassette data-recording applications, contact:

N.V. Philips' Gloeilampenfabrieken
Digital Recording Department HBS-2
Eindhoven The Netherlands
Tel 040-756935 or 757461

New products

Instruments

ECL speeds up signal capture

Emitter-coupled logic in waveform recorder boosts processing rate

Looking to maintain a strong position in a market in which it pioneered, Biomation Inc. has introduced what it calls the industry's fastest waveform-transient recorder, the 500 megahertz model 6500. This kind of instrument records analog single-shot transients or signals as a function of time, converting the information to digital data and storing it in a memory.

Unlike a standard oscilloscope, the model 6500 can record the signal preceding the trigger point, an important feature in applications ranging from shock tests to capture of radar return pulses. This pretrigger capability ensures recording of the leading baseline and rise of a signal without the need for an external delay line. The real-time conversion and storage enables the capture of a large range of signals including one-time events.

Previous waveform recorders, in-

cluding Biomation's model 8100, used standard transistor-transistor logic, metal-oxide-semiconductor shift registers, and linear bipolar technology. Therefore, they were limited to conversion rates up to 100 MHz and bandwidths of about 25 MHz. High-speed emitter-coupled logic in the model 6500 enables Biomation to increase the conversion rate fivefold to 500 MHz and to about quadruple the bandwidth to 100 MHz. The model 6500 has a 6-bit analog-to-digital converter made up in part of 64 ECL-based comparator circuits, and the converter is combined with a 6-bit-by-1,024-word memory made of high-speed 256-bit ECL random-access memories.

Arm and trigger controls and selectable record mode and sample interval allow the user considerable latitude in controlling the recording process. Lever-wheel switch adjustments for arm and trigger delays produce convenient trigger holdoff and delayed sweep. A dual time-base mode allows selection of two internal sample intervals for recording.

The stored information can be presented in one of three ways. A repetitive analog reconstruction of the stored signal is available, along with an appropriate sweep ramp and a retrace blanking signal. This produces a steady analog presentation on a CRT display or a bench

oscilloscope. Alternatively, the analog reconstruction may be produced at a very slow rate for generation of hard copy on a strip chart or other recorder. Finally, the digital information can be extracted via an asynchronous data output when interfaced to a computer or mass-storage device.

Input impedance is 50 ohms, single-ended, and sample intervals may be selected externally or internally from 2 nanoseconds to 1 second. Five selectable input ranges—0.25, 0.5, 1.2 and 5 volts—full scale, are provided. A trigger delay is proportional to sample interval and selectable via three decade switches to 9990 sample intervals in increments of 10. Measuring 6.25 by 17 by 19 inches, the model 6500 is tentatively priced at \$12,000.

Biomation, 10412 Bubb Rd., Cupertino, Calif. 95014 [351]

400-MHz storage scope writes 2,500 cm/ μ s

The high speed of the model 7834 400-megahertz storage oscilloscope, which writes at a maximum rate of 2,500 centimeters per microsecond, allows it to capture single-shot rise times as fast as 1.4 nanoseconds. When signals are repetitive, the scope can measure rise times that

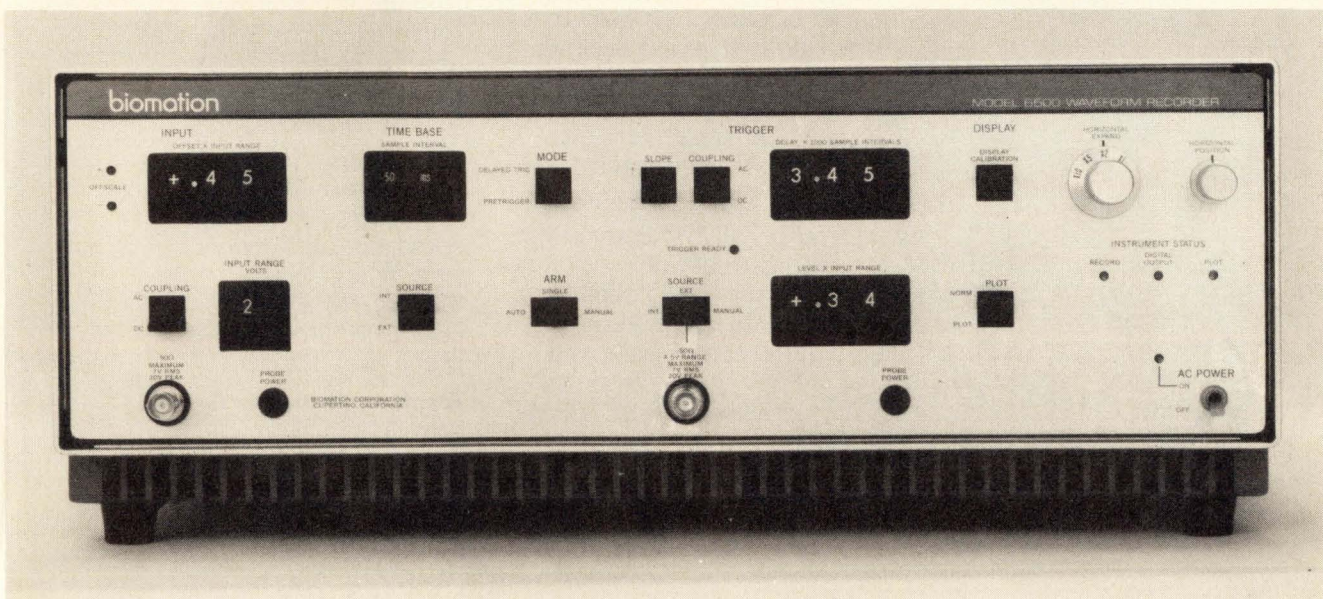

People are beginning to see the light...

Corning is helping them do it!

Today, compact electronic panels are being used to display alphanumeric information on auto dashboards, airplane cockpits, POS

terminals, and in many other areas where CRT's were used.

Problem: The numbers and characters must be clearly visible from a wide viewing angle under a variety of lighting conditions.

Corning FOTOFORM® Opal, a glass-ceramic, helped solve the problem.

FOTOFORM materials can be chemically machined to produce holes and channels

of almost any size and shape, with precise tolerances of ± 0.001 inch. And they have excellent electrical properties. Engineers at the Electronic Components Division of Burroughs Corporation took advantage of these characteristics to produce the new Self-Scan® panel displays.

Previously, a white material with limited machinability was

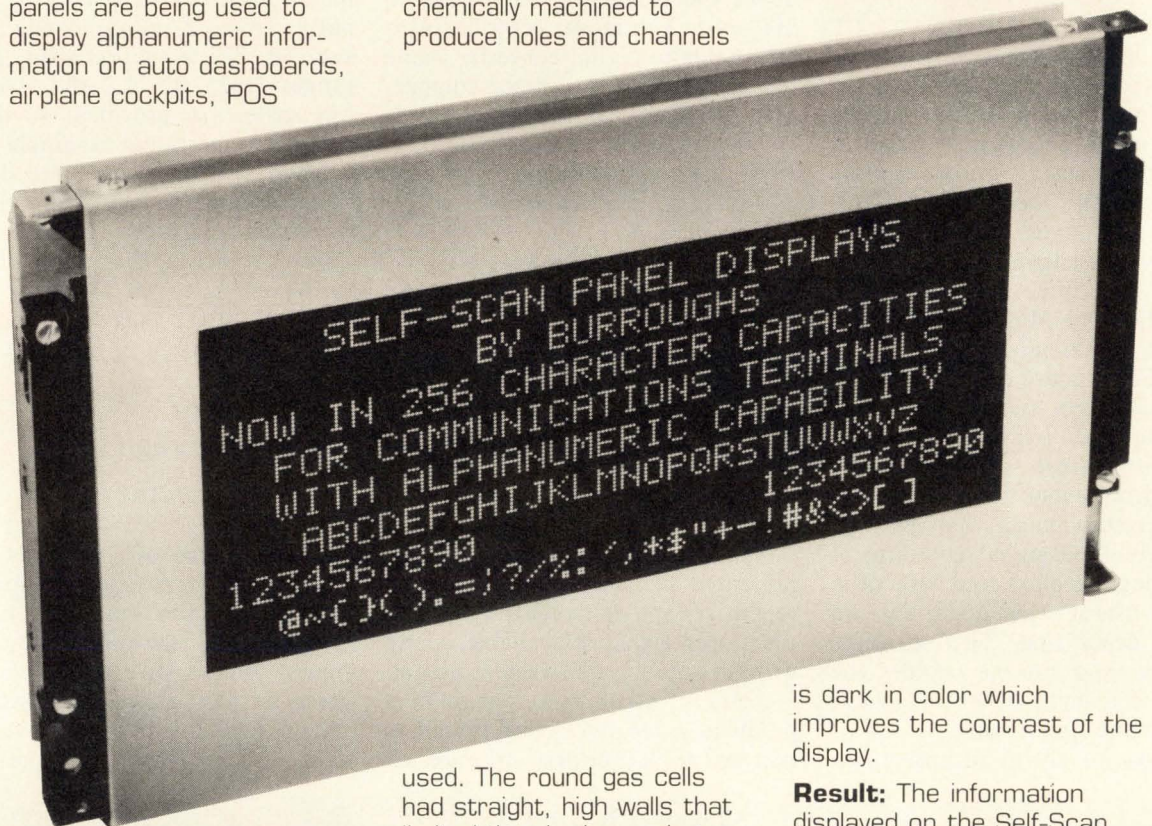

FOTOFORM Opal glass-ceramic cell sheet photo-etched to produce precise rectangular holes.

used. The round gas cells had straight, high walls that limited the viewing angle to about 60°. Light reflections from these walls limited the contrast needed for good viewing in ambient light greater than 50 footcandles.

The FOTOFORM Opal cell sheet consists of rectangular holes separated by angular walls. This configuration results in a 120° viewing angle. In addition, FOTOFORM Opal glass-ceramic

is dark in color which improves the contrast of the display.

Result: The information displayed on the Self-Scan panel is clear and sharp through a wide range of lighting conditions.

At Corning, we can shape your ideas

For details about this application, and more information about FOTOFORM and FOTOCERAM materials phone or write:

Fotoform Products Group
Corning Glass Works
Corning, New York 14830
(607) 974-8583

CORNING

New products

are as short as 900 picoseconds.

The scope mainframe, which has four plug-in compartments, provides both variable-persistence and bistable storage modes. The 2,500-cm/ μ s writing rate is provided in the

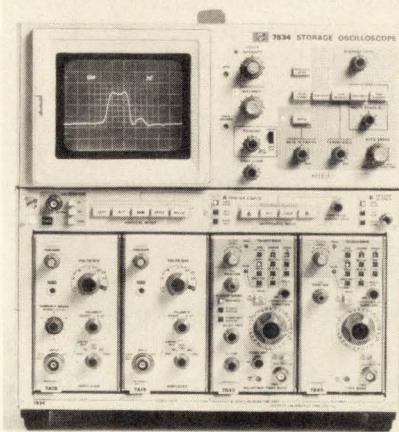

variable-persistence mode only, and to achieve it, the scope must be operated with a reduced scan. In its bistable mode, the scope can write up to 350 cm/ μ s.

Among the capabilities that enhance the 7834's usefulness are a SAVE control, which prevents accidental erasure of the display while increasing viewing time up to 30 times, and an AUTOERASE control, which allows the display to be updated automatically at the end of an adjustable time interval. The 7834 mainframe sells for \$6,900 and has a delivery time of 16 weeks.

Tektronix Inc., P.O. Box 500, Beaverton, Ore. 97077 [353]

50-MHz logic analyzer ignores tiny glitches

An eight-channel logic analyzer with a maximum sampling rate of 50 megahertz can operate in a so-called true sampling mode that excludes all glitches that last less than one sample period. In this mode, the user can avoid being confused by unimportant spikes that occur in synchronous data streams. Like its 20-MHz predecessor, the model 20D, the model 50D can use almost any

oscilloscope or X-Y display to present multiple-trace timing diagrams.

The model 50D contains two 4,096-bit memories, each of which is organized as 512 8-bit words. The two memories can be operated in a delayed mode so that the contents of one is a continuation of the contents of the other. For full 16-channel triggering and recording, two model 50Ds can be bused together, but the manufacturer is working on a factory-option retrofit that can upgrade a single 50D to 16-channel capacity.

Weighing only 18 pounds, the logic analyzer measures 4.5 by 8.5 by 14 inches and sells for \$3,375. Delivery time is six weeks.

BP Instruments Inc., 10601 S. De Anza Blvd., Cupertino, Calif. 95014. Phone (408) 446-4322 [354]

Direct synthesizer spans 160 MHz; sells for \$5,000

Priced at only \$4,975, the model 5600 direct frequency synthesizer covers 0.1 to 160 megahertz with a typical switching time of 20 microseconds. Intended for use in satellite-communications systems, high-frequency receivers, spectrum analyzers, and similar applications, the 5600 keeps its spurious harmonic outputs more than 35 db below the

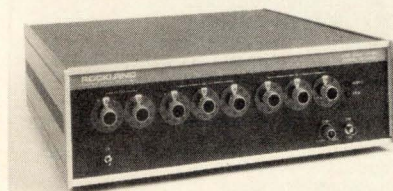

fundamental, and its close-in phase noise is typically more than 70 db down.

Programmable either from the front panel or by remote digital control, the 5600 has a constant resolution of 1 hertz. A buffered

MATERIALS TO SHAPE YOUR IDEAS

FOTOFORM® Glass and FOTOCERAM® Glass-ceramic

These materials are rigid, strong, dimensionally stable and chemically inert. They have excellent electrical and physical properties. And we can precision-etch them with intricate and accurate outlines, holes, slots or cavities of almost any size and shape.



FOTOFORM Opal Glass-ceramic with variety of slots as small as .007"

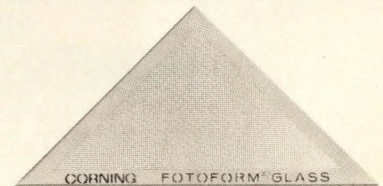

FOTOFORM Glass with .005" square holes on .012" centers

FOTOCERAM
Glass-ceramic
.050" thick with
American flag
pattern etched
.022" deep

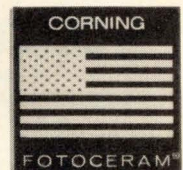

FOTOCERAM
Glass-ceramic
with variety of
holes and slots
as small as .007"

FOTOFORM and FOTOCERAM materials are being used to solve design problems for such applications as: Cell sheets for gas discharge displays, substrates, magnetic recording head pads, fluidic devices, impact and non-impact print heads, and assembly jigs. Chances are they can solve a problem for you.

Fotoform Products Group
Corning Glass Works, Corning, N.Y. 14830.

CORNING

33% more power to the people.

Power/Mate presents Econo/Mate II.

The open frame power supply.

Now Power/Mate brings you 33% more power in the same package size with the second generation of our Econo/Mate series.

The size is the same, the basic components are the same for easy interchangeability. But that's where the similarity ends.

Econo/Mate II adds features like dual AC primary and a plug-in IC regulator for improved regulation.

And Econo/Mate II is tough. Computer design, quality control, and Power/Mate's experience helps insure 100,000 hr. MTBF even at this higher power output.

But for all its features, Econo/Mate II is still, most of all, economical.

We wouldn't call it Econo/Mate if it wasn't.

Econo/Mate II is in stock, ready for delivery. Send for our free brochure.

Prices start at \$19.95.

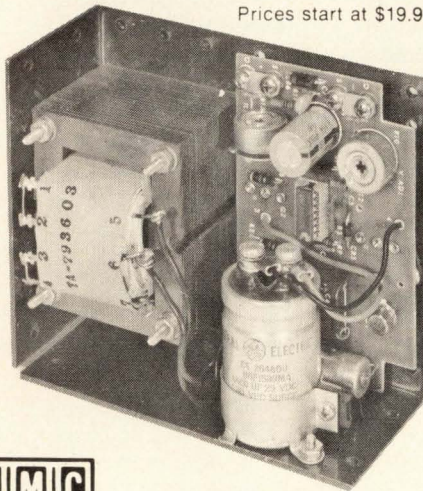

POWER/MATE CORP.

World's largest manufacturer of quality power supplies.

514 South River Street/Hackensack, N.J. 07601/Phone (201) 343-6294 TWX 710-990-5023

Circle 136 on reader service card

It's the decisive contacts you make at Fairs in Hanover



Hanover Fair '77

20th-28th April

● Office and Data Technology (CeBIT) ● Mechanical handling and warehouse handling ● Transportation ● Cleansing Technology and Property Maintenance ● Refuse Removal ● Tools ● Systems Show 'Power Transmission and Control, Industrial Handling': Power Transmission Engineering ● Internal Combustion Engines and Small Gas Turbines - Oil Hydraulics (Systems and Components) - Assembly and Work Handling - Compressed Air Technology including Pneumatic Control Equipment ● Measuring, Testing, Control and Automation Equipment ● Electronic Components and Sub-assemblies ● Telecommunications ● Electrical Specialist Fields, Methods and Processes ● Production and Conversion of Electrical Energy ● Distribution of Electrical Energy ● Electrical Installations and Domestic Appliances - Electro-acoustics (Entertainment Electronics) ● Electric Lighting ● Research and Technology ● Iron and Steel, Non-ferrous Metals, Foundry Products ● Parts and Components ● Building Materials and Components ● Advertising Aids ● Decorative Consumer Goods - Porcelain, Ceramics, Glass - Jewellery, Clocks and Watches, Silverware ● State of 3. 9. 76

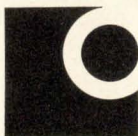

LIGNA HANNOVER '77

International Trade Fair for Machinery and Equipment for the Wood Industries

18th-24th May

Schenkers International Forwarders, Inc.
One World, Trade Center · Suite 1867 · New York, N.Y. 10048
Telex: 222-815 · ☎ 212 432-3043

← Circle 151 on reader service card

New products

reference-frequency output can synchronize other equipment, and the output amplitude can be controlled by one external analog signal. A gated buffer register on the programming inputs stores the last frequency setting.

The 35-pound frequency synthesizer measures 5.25 by 17 by 18 inches. Delivery time is stock to 30 days.

Rockland Systems Corp., 230 West Nyack Rd., West Nyack, N.Y. 10994. Phone David Kohn at (914) 623-6666 [355]

Low-cost pulser

operates up to 50 MHz

The model 850 pulse generator, priced at only \$465, provides pulse widths from 10 nanoseconds to 50 milliseconds, delays that cover the same range, and repetition rates as high as 50 megahertz. Normal and complementary outputs have adjustable amplitudes that can maintain from 250 millivolts to 5 volts across 50 ohms. The output can be offset up to ± 2 v dc, or the offset can be completely disabled at the flick of a switch.

Dytech Corp., 2725 Lafayette St., Santa Clara, Calif. 95050. Phone (408) 241-4333 [356]

Two-channel active filter

covers 0.02 Hz to 2 MHz

A versatile two-channel active filter that covers from 0.02 hertz to 2 megahertz can be operated in four modes: high-pass, low-pass, band-reject, and band-pass. In addition, each of the instrument's two sections can be switch-selected to act as either a Butterworth (maximally flat) or linear-phase filter.

Available options are: floating or differential inputs, battery operation, and greater than unity gain. Prices vary from \$1,400 to \$1,680; delivery time is two weeks.

A.P. Circuit Corp., 865 West End Ave., New York, N.Y. 10025. Phone (212) 222-0876 [357]

How a 2% IC failure can kill off 25% of your assemblies.

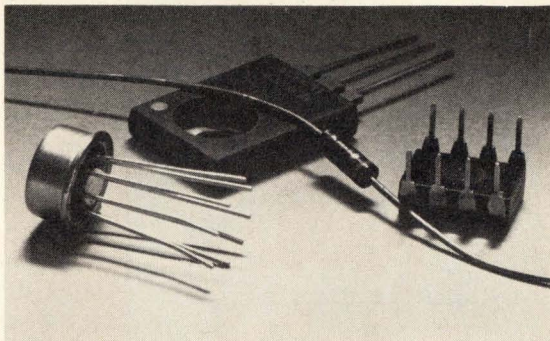

For example—if you produce 100 sub-assemblies that each takes 12 to 13 or more ICs, then with a 2% IC failure rate, you'll end up reworking 25 of those assemblies trying to find the 2 bad ICs.

The 2% is a typical rate to slip by a manufacturer's tests or your own in-coming screening. How come? A simple GO/NO GO test weeds out only the *dead-on-arrivals*, not those flawed ICs destined for *infant mortality*.

The way to find them quickly, economically, is through *preconditioning*—then testing.

With preconditioning procedures specifically tailored to your devices, we can condense a year's worth of stress on an IC down to less than a week.

Then we test.

And you stop reworking 25% of your assemblies.

Usually, a procedure we'll recommend will cut your failure rate down to about .3%. To reduce the rate further usually

costs more than it's worth.

What can preconditioning and testing cost you? And what can it save you?

No two cases are exactly the same. But it's not hard for you to find out—because it's not that hard for our test analyst engineers to develop a recommendation for you.

Call us.

Free. Basic Handbook of Preconditioning and Testing Semiconductors

Here's your quick guide to some of the important ins and outs. It won't replace your need for experts—but it will certainly help you get the most out of them. Included: "Testing—how much, how little?" "The cost of testing vs. not testing." "How to test the test labs." And more.

Just call or write for your free copy.

datatron, inc.

MICROELECTRONIC TESTING LABORATORIES DIVISION

1562 Reynolds Avenue • Irvine, California 92714 • (714) 540-9330 • TWX 910-595-1589

11 Esquire Rd. • No. Billerica, Mass. 01862 • (617) 667-2191 • TWX 710-390-1447

178 Warren Allen Dr. • Wood Dale, Ill. 60191 • (312) 595-0440 • TWX 910-256-4845

Semiconductor Testing

RF Power Amplifiers?

One unit may be all you'll ever need.

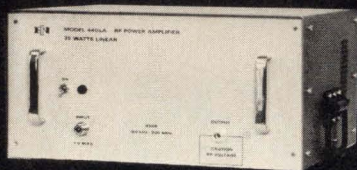

If you have the ENI Model 440LA ultra-wideband solid state power amplifier, all you need is a laboratory signal generator and you've got the ultimate in linear power for such applications as RFI/EMI testing, NMR/ENDOR, RF transmission, ultrasonics and more.

Capable of supplying more than 40 watts of RF power into any load impedance, the 440LA covers the frequency range of 150 kHz to 300 MHz.

We could mention unconditional stability, instantaneous failsafe provisions and absolute protection from overloads and transients, but that's what you expect from any ENI power amplifier, and the 440LA is no exception!

Our catalog contains complete specifications on the 440LA as well as the entire line of ENI amplifiers, and is available without obligation, of course.

For further information or a demonstration, contact ENI, 3000 Winton Road South, Rochester, New York 14623. Call 716-473-6900, or Telex 97-8283 ENI ROC.

ENI

The World's Leader
in Power Amplifiers

New products

Packaging & production

Tester checks modules, cards

Microprocessor controls test sequence in portable, flexible troubleshooter

With the proliferation into the commercial/industrial marketplace of digital equipment such as point-of-sale and electronic banking terminals and electronic games has come a greater need for a low-cost instrument to do on-site troubleshooting and service testing of digital modules, hybrid circuit cards, ICs and large-scale-integrated chips. Bendix Corp.'s Test Systems division believes it can fill the bill with a portable, automatic, microprocessor-controlled module tester that will make its formal debut next month at Nepton '77 West in Anaheim, Calif.

The module tester is the first "catalog" item for the division, heretofore a maker of \$100,000 to \$300,000 custom-engineered, computer-controlled test systems for military and commercial avionics. The tester uses both microprocessor and

erasable, programmable read-only-memory (EPROM) technology to provide a small (18.6 by 18.8 by 7.5 inches), lightweight (30 pounds), flexible system that goes where the trouble is to accomplish on-the-spot testing. Familiarly called "Herbie," the instrument uses an Intel Corp. 8080 microprocessor to run the operating system, control the sequence of events, and maintain system performance by automatically testing itself every time power is turned on.

Test programs for the system are either provided by Bendix or generated by the user with the aid of Bendix's library of automatic test generation (ATG) programs. The library includes programs for changing pins, states, and levels, among other things, so that they are compatible with Flash, D-Lasar, and other standard ATG software packages.

The programs are stored on solid-state PROM cards to provide non-deteriorating, reusable data entry. However, an erasable PROM, Intel's 8,192-bit type 2708, is used so that programs can be changed by clearing with an ultraviolet light and reprogramming electrically in the usual way. The PROM card with the 2708 on it has a 5,120-word capacity, which can be doubled by use of a piggy-back card with a second 2708. This capacity will be doubled again

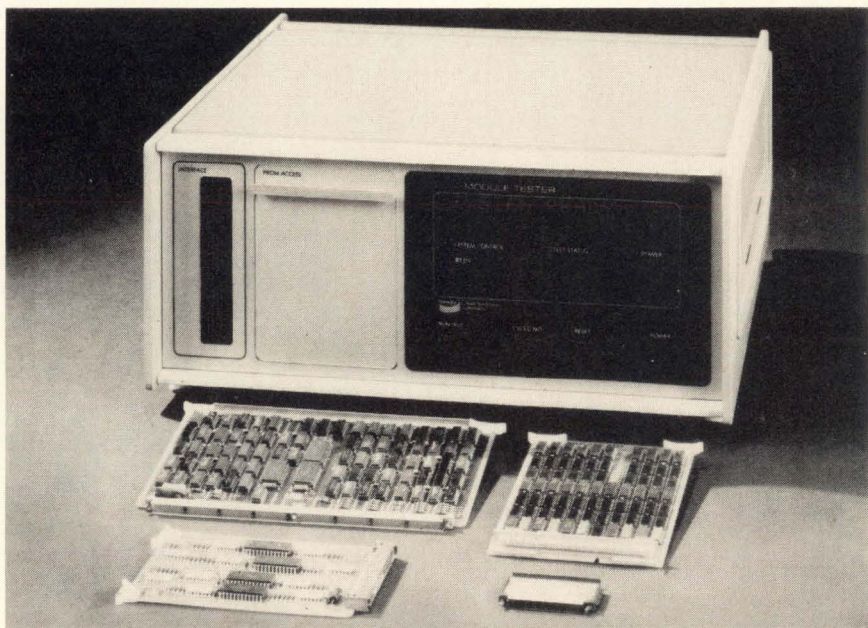

when 2708s with twice the memory become available later this year, says division marketing engineer Ted Schiffner. For very large test programs requiring greater memory, he notes, there is provision for a magnetic-tape cassette to plug in at the back.

The basic module tester, priced at \$10,000, has an input/output capacity of 64 pins (channels), expandable to 256 pins in 32-pin increments at \$1,000 per card. Each channel is compatible with C-MOS, diode-transistor logic, TTL and other 5-volt logic. Available in small quantities now and large quantities by late summer, the basic tester will perform go/no-go testing of digital cards, modules and devices, with a limited debugging capability. It has a 16-segment ASCII character-set alphanumeric readout. A second 2708 erasable PROM card plugs in to provide fault-isolation capability.

For extensive debugging, yet another 2708 would be used to enable the operator to get into an interactive mode and thereby create test programs on line.

The initial module testers offer digital test capability only but will have provision for expansion into hybrid testers via plug-in cards for voltage check, frequency counting, and other analog measurements—when these options become available later this year.

"We're targeting the module tester toward the military as well as the commercial/industrial market," Schiffner says. "We expect it to be used for testing cards and modules on Navy ships and at military depots where there's an increasing amount of digital equipment."

Bendix Corp., Test Systems Division, Teterboro, N.J. 07608. Phone (210) 288-2000 [391]

Plating modules speed up prototyping of pc boards

Many electronic manufacturers have the capability to make relatively simple single-sided printed-circuit boards in prototype quantities. How-

Forethought. The only sure cure for buyer's remorse.



By the time you get all your electronics into the cabinet, get it sold and get it shipped, any weaknesses in the design will show up in spades.

If the levelling legs aren't properly reinforced, they can pop through the bottom under a full load.

If the seams aren't completely welded and sealed, they may begin to open after you install your equipment.

If the internal engineering isn't perfect, the unit may exhibit the Leaning Tower Effect by the time it gets to your customer.

If the external design isn't first class, your product won't have that crisp, professional look.

If the cabinet isn't a Zero Matrix IV, the design engineering probably won't protect you from all the problems you didn't think about.

We think about all those problems. Our design engineering makes a science of forethought. Don't be sorry tomorrow. Send for your free catalog today.

ZERO
We make you look good.

Zero Corporation • Burbank, CA 213/846-4191 • Monson, MA 413/267-5561

Call me, I'm interested circle 189
For Mail Catalog circle 139



LOW NOISE MODULAR DESIGN

Switching Power Supplies!

A new line of compact, modular-design switchers that simplify design for 300-600 watt applications and sell for less than 90¢ per watt! End users benefit from low EMI noise levels and highly reliable operation plus easy add-on and maintenance features. Get everything you need to know to evaluate this high quality, money-saving line from:

Jim Daly
phone (612) 830-5800
TWX 910 576 2978
or write: 7801
Computer Ave. So.
Minneapolis, MN 55435.

**CD CONTROL DATA
CORPORATION**

Circle 140 on reader service card

BIPOLAR MICROPROCESSING #1

INCREASE YOUR PERFORMANCE WITH OUR 8080 EMULATOR.

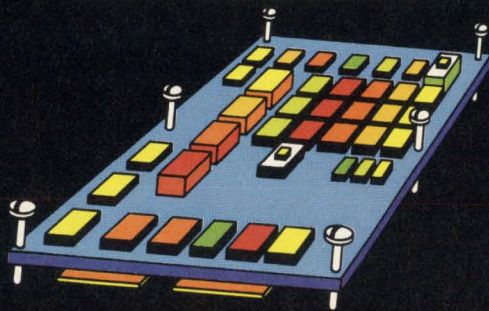

Upgrade existing designs. New 8080 Emulator delivers 5 times increased performance. Reduces micro-code writing time, too.
Order Part #3000KT8080SK.

Clip coupon to letterhead for details on how it makes designing easy.

Name _____ Title _____
Tel. _____ M.S. _____
811 E. ARQUES, SUNNYVALE, CA. 94086

**THINK
Signetics**

a subsidiary of U.S. Philips Corporation

© 1976.

140 Circle 190 on reader service card

New products

ever, double-sided prototypes requiring plated-through holes often must be ordered on the outside, causing considerable delay.

But small, low-cost benchtop plating systems are now available from Proto-Plate Inc., and companies can use them to make their own plated-through pc boards. The new system consists of two plating modules, plus a complete package of chemicals for each. Boards up to 10 by 10 inches may be plated in the modules, which have complete instructions.

A user may choose between a completely electroless process (model 100) or a combination electroless/electrolytic process (model 100/101). Both models are completely portable. Each occupies less than 2 square feet of bench space and only requires a water source and 100 volts ac. Prices on the system range from \$449 for the model 100 to \$899 for the model 100/101 combination. Delivery is stock to two weeks.

Proto-Plate Inc., Box 3274, Allentown, Pa. 18106 [401]

Flat-cable clamp is self-extinguishing

As the use of flat cables becomes more widespread, a need is developing for a cable clamp that can meet key flammability specifications laid down by Underwriters' Laboratories and the Federal Aviation Administration. To meet this demand, TA Manufacturing Corp. has designed a unit with a metal frame covered with a self-extinguishing material instead of the usual plastic compound, which is reported to spread fire by dripping. Actually, two covering materials are offered: nitrile-butadiene and silicone rubber. The latter is a requirement in some military applications.

In addition to its fire-retardant properties, the new clamp is said to provide superior positive restraint. "We use a unique design that looks like a double windshield-wiper blade to provide positive restraint for even the most slippery cables," says Bob

Electronics / February 3, 1977

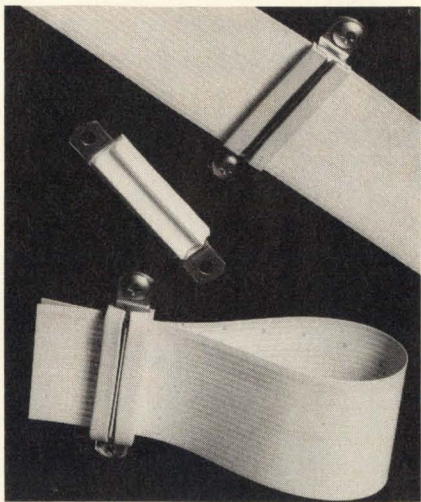

Byerly, product manager. "It works whether the cable is made with round or flat conductors."

The clamps come in two versions—a two-piece type for holding cables away from a surface (model 08311) and a one-piece unit for clamping a cable onto a surface (model 08111). Both are available in 1- and 3-inch widths, and both operate from -65 to 400°F. A representative price, for lots of 1,000, is 35 cents each for the 3-in. one-piece clamp. Delivery is from stock to two weeks.

TA Mfg. Corp., A Viking Industries Co., 375 W. Arden Ave., Glendale, Calif. 91203. Phone (213) 240-4600 [392]

Modular signal source takes aim at automatic systems

A modular, programmable signal source designed for use in automatic test systems can act as a dc voltage source, a pulse generator, a high-performance function generator, and a frequency synthesizer. The basic SPG-800, which sells for \$3,195, is both a programmable dc voltage source and a programmable function generator. The frequency synthesizer option adds \$350 to its price, while the pulse generator adds either \$295 (fixed rise and fall times) or \$590 (variable rise and fall times).

Key features of the SPG-800 include field-installability to its plug-in options, frequency coverage



ELIMINATE NOISE PROBLEMS WITH DELTEC'S

COMPUTER POWER CONDITIONER

5 KVA FOR LESS THAN \$1,500

Only One Computer Power Conditioner Eliminates All Noise Problems. Noise on a computer power line causes data and memory loss as well as mysterious crashes and errors. This noise can pass through voltage regulators and dedicated power lines.

Deltec DLC Series computer power conditioners eliminate noise and regulation problems. Unique shielding provides 120 dB (1,000,000:1) reduction for: Transients—Voltage Spikes—Ground Loops—Line Noise caused by RFI or EMI (radiated noise).

The DLC regulates voltage within 3% over a 30% input voltage range.

For more information, call or write:

DELTEC, 980 Buenos Ave.,
San Diego, CA 92110
Phone (714) 275-1331

DELTEC
CORPORATION

Circle 141 on reader service card

BIPOLAR MICROPROCESSING #2

SEND FOR THE BOOK ON MICROPROCESSING.



Details bipolar microprocessors' memory and interface functions. Includes useful application notes. A complete microprocessor book. All products detailed.

It's free. No obligation. Simply clip coupon to letterhead only.

Name _____ Title _____
Tel. _____ M.S. _____
811 E. ARQUES, SUNNYVALE, CA. 94086

THINK signetics

a subsidiary of U.S. Philips Corporation

© 1976

.150" PROFILE

high density DIP sockets from R-N
ICL SERIES



26% LOWER PROFILE

Slim, low body design—actually 26% lower—cuts packaging space needs drastically.

.100" PROGRESSION

of socket leads permit maximum board density in either end-to-end or side-by-side arrangement. Cuts PC board drilling costs as well.

**IDEAL FOR HI-SPEED
AUTOMATIC PRODUCTION**
Self-lock leads hold socket firmly during high speed wave soldering.

MAXIMUM VIBRATION RESISTANCE

Unique R-N contact design assures that your IC lead maintains solid contact—even in most punishing applications.

CUT COSTS, SPEED PRODUCTION

with these new ICL low-profile DIP sockets from Robinson-Nugent. Designed for high speed automatic assembly and maximum shock and vibration resistance. Has famous R-N "side-wipe" single leaf contacts, body meets UL94V-0 flammability rating. 8 thru 40 leads available.

Check the advantages of these high density sockets today!
Write for complete specifications on this new R-N low-profile ICL DIP socket now.

Call me, I'm interested circle 142
Send product information circle 175

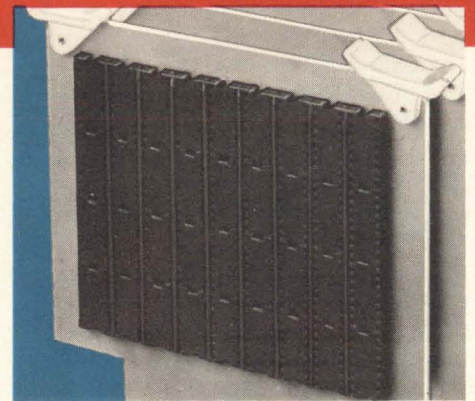

For maximum package density with traditional R-N reliability, specify this new low cost, low-profile ICL DIP socket.

**RN ROBINSON
NUGENT, INC.**

800 East Eighth Street, New Albany, Indiana 47150 • Phone: (812) 945-0211 — TWX: 810-540-4082

New products



that extends from 0.1 hertz to 13 megahertz, and programmability by means of all of the popular interface schemes including: IEEE 488, EIA RS-232-C, parallel binary-coded decimal, 20-milliampere current loop, and ASCII. Optical isolators are available where appropriate.

Interstate Electronics Corp., Dept. 7000, E. Vermont Ave., Anaheim, Calif. 92803. Phone Philip Brance at (714) 772-2811 [393]

Packaging system allows mixing of board sizes

A packaging system that permits the mixing of a variety of wrapped-wire panel sizes and IC densities in the same rack assembly can accommodate panels that contain from 32 to 192 ICs. Panels that range in size from 4.5 by 6.0 inches to 14.9 by 8.0 inches may easily be intermixed.

Each panel size or family is available with many IC socket-layout options, as well as multiple voltage supply planes. Some contain as many as four planes (including ground). The panels plug into three

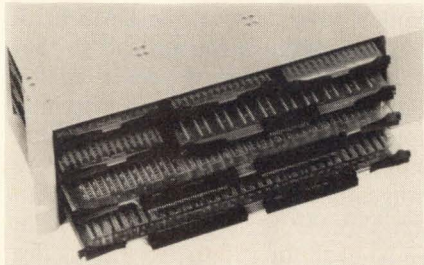

independent back planes, each of which may contain up to three voltage distribution planes, permitting unusual flexibility.

Mupac Corp., 646 Summer St., Brockton, Mass. 02402. Phone Arthur M. Largey Jr. at (617) 588-6110 [394]

NYLON CAPTIVE STANDOFF

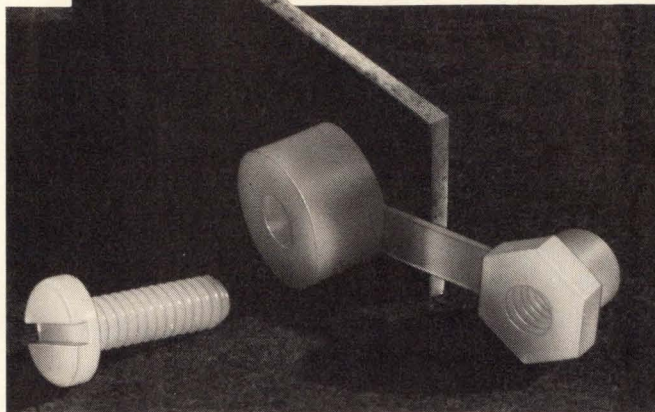

Designed to eliminate mounting problems in hard-to-reach locations. Especially suited for use as a spacer in separating or stacking PC boards ... also for any type of application requiring components to be rigidly mounted and at same time be electrically isolated. All nylon ... 4 sizes, 1/4", 3/8", 1/2" and 1", for both 6-32 and 8-32 screws.

FREE SAMPLES — write for sample packet, literature and prices.

Wackesser COMPANY, Inc.

4444 West Irving Park Road • Chicago, Illinois 60641 • 312/282-8626

Circle 143 on reader service card

BIPOLAR MICROPROCESSING #3

THE INDUSTRY'S LEADING FAMILY OF BIPOLAR MEMORIES TO PICK FROM.

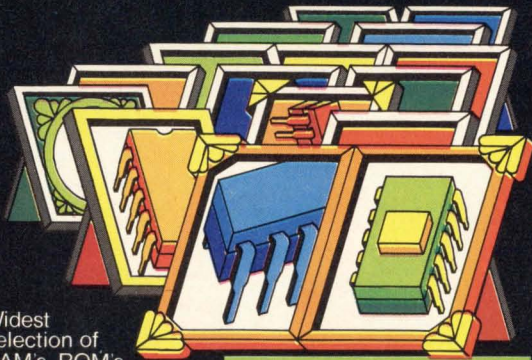

Widest selection of RAM's, ROM's, PROM's, FPLA's from one source... Signetics. The right memory fit saves time, optimizes system performance.

Select from over 101 memories in stock. Clip coupon to your letterhead for full list.

Name _____ Title _____

Tel. _____ M.S. _____

811 E. ARQUES, SUNNYVALE, CA. 94086

THINK
signetics

a subsidiary of U.S. Philips Corporation

© 1976.

Which coloring method do you like?

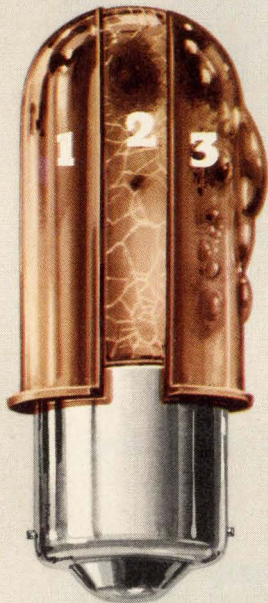

3. Plastic caps? fades & melts
2. Paint? fades & cracks.
1. Silikrome® filters?
No problems!

We're No. 1

Interchangeable and reusable, Silikrome® filters are your best way to provide accurate color selection and extended life for miniature incandescent or automotive lamps. Silikromes are excellent heat dissipators. *They make lamps last 5-6% longer! These snap-on Rub-R-Glas™ boots stay colorfast and pliant even after 40,000 hours at -160°F to 500°F.* To see for yourself why Silikromes are Number One, write or call for literature. Contact: APM-Hexseal, 44 Honeck St., Englewood, N.J. 07631; (201) 569-5700

The Clean Fighters



New products

Semiconductors

D-MOS invades analog markets

Signetics introduces devices in delay-line, FET, and switching areas

The double-diffused metal-oxide-semiconductor process has been hailed as one way of achieving increased complexity in digital LSI devices. Yet the first standard D-MOS products to be introduced by Signetics—the first U.S. company to develop the technique—are in three analog market areas. They are transverse filters and analog delay lines, discrete power field-effect transistors, and high-performance analog switches.

Perhaps the most interesting of Signetics' new products belongs in the first market. It is the SD5350 (shown above), a monolithic dynamic shift register with analog switches and serial outputs. Traditionally, Reticon's charge-transfer-storage MOS device and Fairchild's analog charge-coupled devices have fought for this market.

"With the D-MOS technique, each bit drives a low on-resistance D-MOS analog switch," says Tom Cauge, a marketing manager at Signetics. "Switching takes place on the positive-going edge of the clock pulse. If the clock is held high, all switches will be off, and if it is held low, all switches will be on." The process employs a single clock and a single 12-volt supply and has inputs compatible with transistor-transistor logic. Turn-off and turn-on propagation delay time is 30 nanoseconds, and dynamic operation is guaranteed from 1 megahertz to 10 MHz.

Applications for the SD5350 include those in which a clock controls switches for up to eight analog voltages with a 7-v limit. Cauge says that one of the prime uses is a video delay line to provide time-base correction in videotape recorders, a key

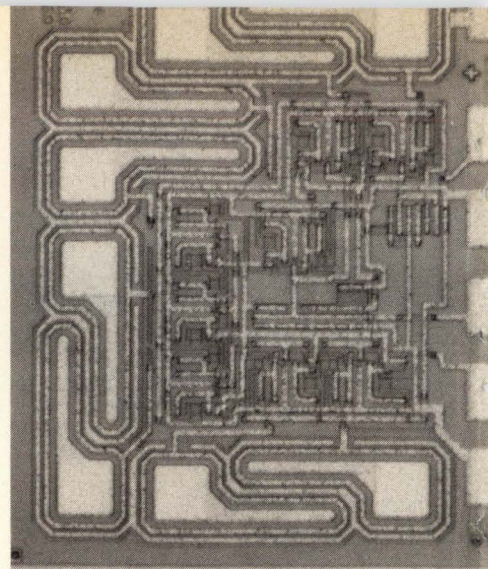

application for the competing CCD delay-line devices. Other applications include a 16-bit synchronous sampled data filter, with two SD5350s in cascade, a multiplexer/demultiplexer, a pattern generator, and a dynamic signal summer. Pricing on the 14-pin, 30-ohm on-resistance device is \$3.70 each for 100 to 999 and as low as \$1.75 each in larger volumes.

Although the first discrete D-MOS parts produced by Signetics were for small-signal applications, the firm is also developing higher-power versions. Siliconix Inc. has already made a big splash in this market with its VMP series of MOS power transistors. The first in Signetics' family of D-MOS-based power FETs is the DMP4025, intended for 500-milliamperere current-drain applications. The TO-39 three-lead device exhibits 5- Ω on-resistance, a 25-v drain-to-source breakdown, and typically 120- Ω transconductance at 15 v, 100 mA and 1 kHz.

Also being introduced is a companion power device, the DMS4025, which contains a fourth lead so that it can be used as a power analog gate, as well as for power-switching applications in which milliamperere inputs switch outputs in the ampere range. These devices, similar to Siliconix' VMP series, are available at \$3.25 each for 100 to 999 and as low as \$1.50 in volume.

Aiming at high-performance analog-switch applications, Signetics is ready with samples of the SD5600, a monolithic D-MOS driver gate patterned functionally after the DG191 series of hybrid analog switches made by Siliconix. Containing four

enhancement-mode D-MOS transistors in a dual single-pole, double-throw configuration, the SD5600 provides make-before-break action with a typical propagation delay of 75 ns. With +15-v power supplies and an analog signal of 7.5 v, the resistance of the device is typically 30 Ω , Cauge says. In the off state, each switch will block voltages up to 20 v peak to peak with a leakage of less than 1 nanoampere. The high-speed driver provides on/off times of better than 100 ns and isolation of better than 50 decibels. It is compatible with TTL, complementary-MOS, and MOS and is housed in a 16-pin ceramic dual in-line package for high reliability and military use.

Signetics Corp., Subsidiary of U.S. Philips Corp., 811 E. Arques Ave., Sunnyvale, Calif. 94086 [411]

Fast power transistors switch inductive loads

A series of npn power transistors, rated for 175-watt operation, offers fast switching of inductive loads even at elevated temperatures. The maximum fall time is just 710 nanoseconds at a peak collector current of 10 amperes and a junction temperature of 100°C. Under the same conditions, the inductive switching time is 5 microseconds.

The series consists of two devices: the 2N6546, which has a collector-base rating of 650 volts, and the 2N6547, which is rated for 850-v operation. The 2N6546 has a dc

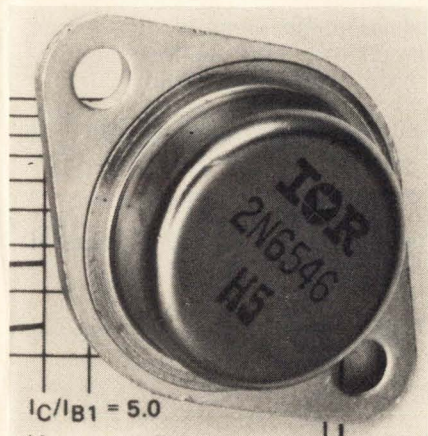

A new source for your custom hybrid needs.

Hydelco is ready to turn your designs into quick reality. We can do big orders. We can do small ones. We can do complex multilayers. We can do trimmers. We can do assemblies. And we can do them all fast, at a price you'll like. Next time you have a hybrid question, call Hydelco - we'll give you a high-quality answer!

HYDELCO INC.
Manufacturer
of Hybrid
Microcircuits

3481 Old Conejo Rd., Suite A-3, Newbury Park, Ca 91320 • (805) 498-3688

Circle 145 on reader service card

BIPOLAR MICROPROCESSING #4

DREAM UP YOUR OWN CONTROLLERS WITH THE 8X300 DESIGNER'S KIT.

You do the programming, we supply all the parts—one 4K PROM half programmed, half available for you to program with diagnostic and demo program, even P.C. board. Order Part #8X300KT-100SK



Clip coupon to letterhead. Kit lets you build your own controller easier, faster, and more efficiently.

Name _____ Title _____
Tel. _____ M.S. _____
811 E. ARQUES, SUNNYVALE, CA. 94086

THINK
Signetics

a subsidiary of U.S. Philips Corporation

© 1976.

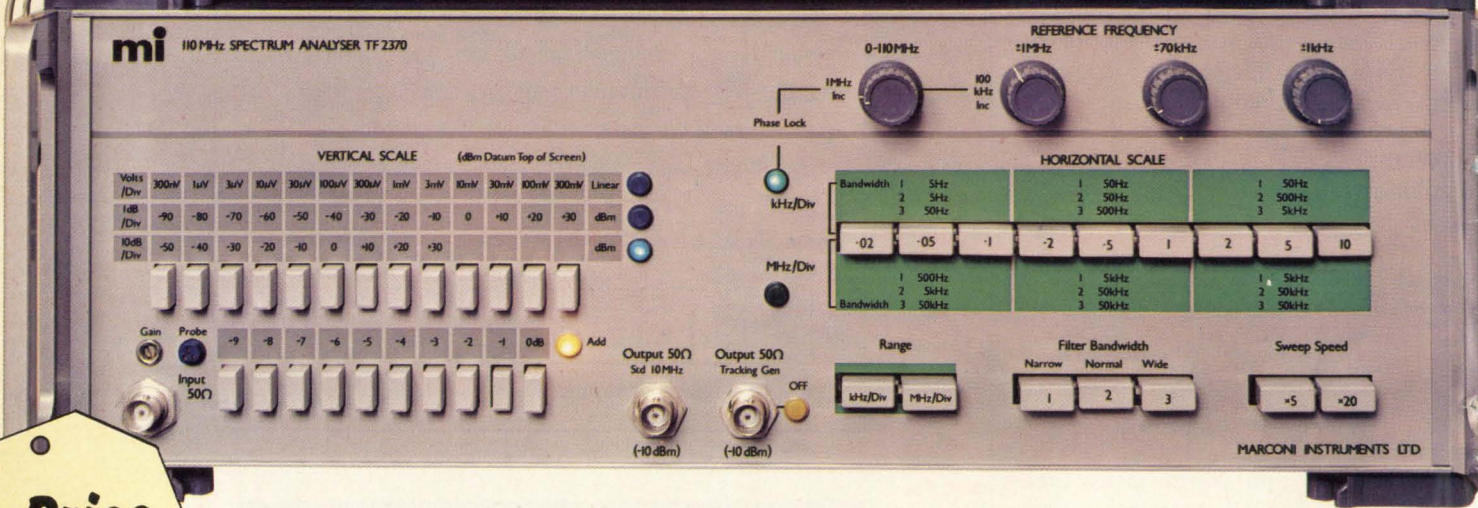
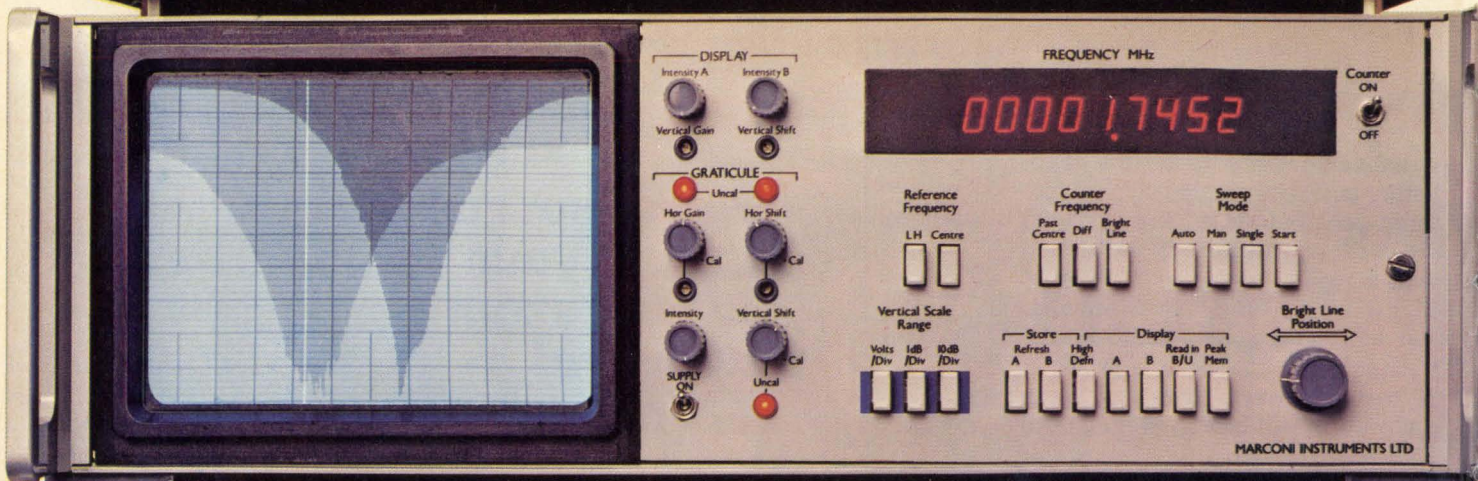

Price Reduced
\$13,795

We've always had unique features and better specs than our competition... now, in addition, **OUR** price is **LOWER!**

Save your skilled engineers for more important work with **mi** Model 2370 Spectrum Analyzer. *Simplify* complicated measurements such as *response, level, gain, signal purity, modulation* and many more. Forget everything you have heard about spectrum analyzers. **mi** Model 2370 is unique. It employs advanced technology to make it as easy to operate as a multimeter. The facts speak for themselves.

- Flicker-free high brightness TV display (No more storage tubes to replace)
- Electronic graticule can pin point position of waveform display for rapid analysis and measurement.
- Choice of vertical scales: linear, 10dB/div for 100dB display, and 1dB/div for 0.1dB resolving power.
- Counter **automatically** displays center frequency, identifies the frequency corresponding to the manually

adjusted 'bright line cursor', or the difference frequency between the two. All to an accuracy of 2Hz.

- Integral synchronous signal source for measuring *networks, filters, amplifiers*, etc.
- For comparative measurements, memory storage can retain one display indefinitely, for simultaneous display with waveform from items under test.
- **Automatic** adjustment of amplifier gain to *optimize* noise performance.
- **Automatic** selection of *optimum* sweep speed.
- With the 5Hz filter, signals 100Hz from a response at 0dB can be measured to better than -70dB.

Such speed and accuracy must be seen to be believed, call us for an enlightening demonstration.

Circle 146 on reader service card



100 STONEHURST COURT, NORTHVALE, NEW JERSEY 07847 • TELEPHONE: 201/767-7250 • TWX: 710-991-9752

New products

current gain of 12 to 60 at a collector-emitter voltage of 2 v and a collector current of 5 A. The 2N6547 has a gain of 6 to 30 at 2 v and 10 A. Both units have peak current ratings of 30 A.

In quantities of 100 to 999 pieces, the 2N6546 sells for about \$7.45, while the 2N6547 is priced at about \$10.70.

Sales Manager, Semiconductor Division, International Rectifier, 233 Kansas St., El Segundo, Calif. 90245. Phone (213) 322-3331 [414]

Op amp has maximum offset current of 200 pA

With a maximum offset current of 200 picoamperes, a maximum bias current of 2.0 nanoamperes, a maximum offset voltage of 0.5 millivolts, and a power consumption of only 18 milliwatts with ± 15 -volt power supplies, the PM108A/308A is intended to compete directly with National's popular LM108A/308A operational amplifiers. By combining ion-implantation super-beta processing with zener offset-voltage trimming, Precision Monolithics believes it has solved the low-yield problem associated with these low-current op amps.

The PM308A, which operates from 0 to 70°C, sells for \$4.50 each in hundreds. The 108A comes in four varieties. All operate from -55 to 125°C, and some are processed to MIL-STD-883A Class B. Their prices, in hundreds, range from \$6.50 to \$21.50 each.

Precision Monolithics Inc., 1500 Space Park Dr., Santa Clara, Calif. 95050. Phone Donn Soderquist at (408) 246-9222 [413]

High-current rectifier withstands up to 1,500 V

The A390 series of silicon rectifiers has an average forward current rating of 400 amperes, a peak one-cycle surge current of 7,000 A, and a repetitive peak-reverse voltage rating of up to 1,500 volts. Available in a

ERASE EPROMS IN MINUTES . . .

Why Wait?

Completely erase your EPROMS fast and efficiently . . . in minutes! Two high intensity systems provide powerful ultraviolet energy. Designed especially for EPROM erasing, they're the UV sources recommended by EPROM manufacturers and users.



The S-52T is the fastest, most powerful UV erasing system. The UVS-54T is a versatile, economical system. Both are equipped with a stand and timer, or can be hand held for on-the-spot erasing.

Call your authorized UVP EPROM lamp dealer today, or write the factory for additional information.

ULTRA-VIOLET PRODUCTS, INC. 
5100 Walnut Grove Ave. • San Gabriel, CA 91778

Circle 147 on reader service card

BIPOLAR MICROPROCESSING #5

ONE-STOP SHOPPING FOR BIPOLAR AND ANALOG MICROPROCESSING INTERFACE PRODUCTS.



All at Signetics. Dozens of bipolar microprocessing interface products. Easy to select and obtain functionally correct interface every time.

We'll send you our total list, if you clip the coupon to your letterhead and mail.

Name _____ Title _____
Tel. _____ M.S. _____
811 E. ARQUES, SUNNYVALE, CA. 94086

THINK
Signetics

a subsidiary of U.S. Philips Corporation

© 1976

Dial Spectrol for Dials!

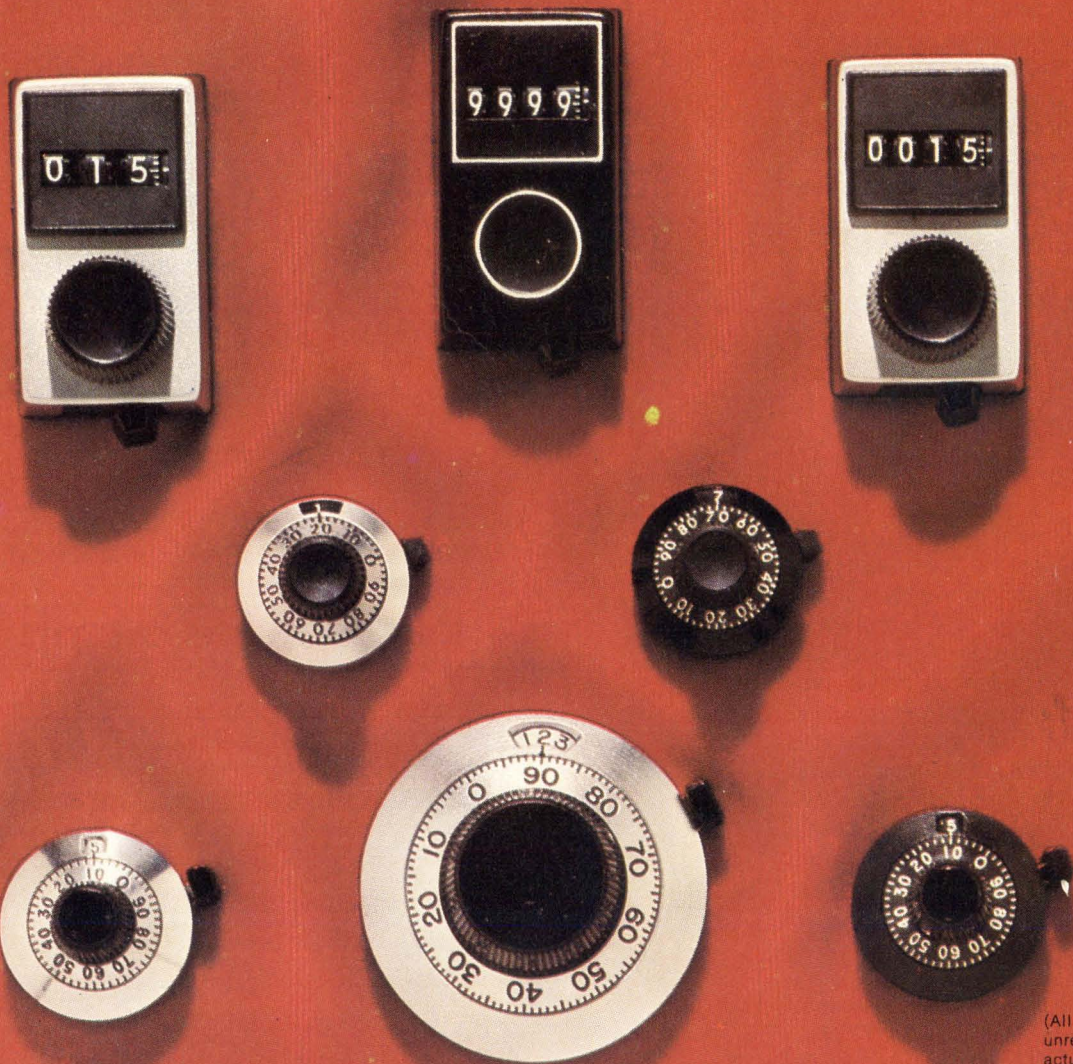

(All dials shown
unretouched,
actual size.)

Highest quality, better readability.

If you've got the pot, we've got the dial. Spectrol has a dial for any standard multi-turn pot. Choose from 7 standard models. Select chrome or black finish. Specify standard 1/4-inch or 1/8-inch shaft bores. Get maximum readability with even our smallest 7/8-inch concentric Model 16 — or swing with the tide to our unique 3- and 4-digit models. Try them, you'll like the action. (If you don't have the pot — we've got those, too.) Call or write.

Spectrol

SPECTROL ELECTRONICS GROUP

UNITED STATES Spectrol Electronics Corporation 17070 E. Gale Avenue, City of Industry, Calif. 91745, U.S.A. • (213) 964-6565 • TWX (910) 584-1314

UNITED KINGDOM Spectrol Reliance Ltd. Drakes Way, Swindon, Wiltshire, England • Swindon 21351 • TELEX: 44692

ITALY SP Elettronica spa Via Carlo Piscane 7, 20016 Pero (Milan) Italy • 35 30 241 • TELEX: 36091

Circle 148 on reader service card

New products

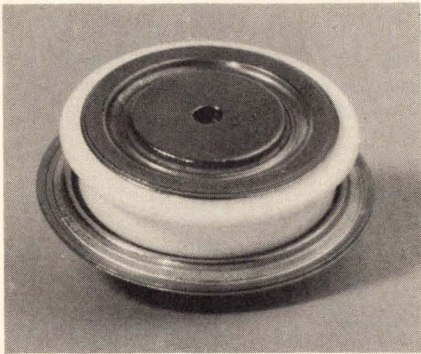

factory-assembled heat exchanger or ready to mount, the rectifier is offered in 15 voltage ratings from 100 v to 1,500 v. A typical price is \$16.75 for the 1,000-v unit in hundreds. Delivery is from stock.

National Electronics, Geneva, Ill. 60134.
Phone (312) 232-4300 [415]

1-ampere rectifiers recover in 100 ns

A series of fast-recovery rectifiers can handle an average forward current of 1 ampere and exhibit a reverse recovery time of 100 nanoseconds. The units have a peak repetitive forward-current rating of 6 A and a peak surge current of 25 A. The SPD series consists of six devices with peak inverse voltage ratings of 50, 100, 200, 400, and 600 volts. Reverse leakage current is 1 microampere.

In thousands, the rectifiers sell for 25 cents to 60 cents each. Delivery of

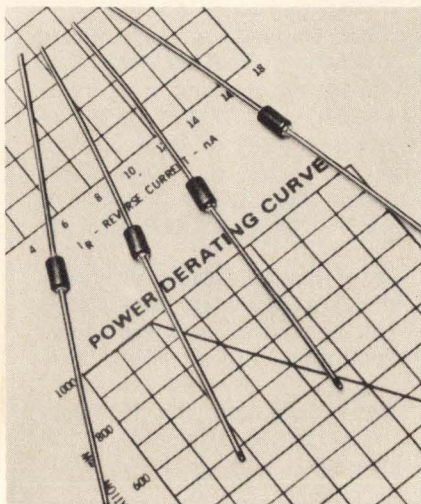

ALCOSWITCH®

OFFERS

WORLD'S SMALLEST TOGGLE SWITCH

made SPECIFICALLY for PC APPLICATIONS

- 60% smaller in volume than existing miniatures.
- 3/8" Max. Height compatible with PC components.
- Terminals match 1/10" centers X-Y axis.
- Gold plated contacts and terminals for dry circuit.
- Available in 1 and 2 poles, On-On or Center-Off.
- Upright or Right Angle mounting.
- Ask us for additional information.

ALCO ELECTRONIC PRODUCTS, INC.
1561 OSGOOD STREET, NORTH ANDOVER, MA 01845 U.S.A.
TEL: (617) 685-4371 TWX: 710 342-0552 A SUBSIDIARY OF **AUGAT** INC.

Circle 149 on reader service card

BIPOLAR MICROPROCESSING #6

INTRODUCTORY BIPOLAR MICROPROCESSING DESIGNER'S KIT

~~\$230⁰⁰~~
\$100⁰⁰

Kit introduces you to the fastest microprocessor in the industry with 100 ns cycle time. \$100 buys you 1 MCU and 4 CPE's at the heart. Plus, 1 Lookahead Carry Generator, 3 Proms, 2 Quad bus Driver/Receivers and much more.

Attach coupon to Purchase Order to save during introductory offer.

Name	Title
Tel.	M.S.

811 E. ARQUES, SUNNYVALE, CA. 94086

THINK Signetics

a subsidiary of U.S. Philips Corporation © 1976.

BIPOLAR MICROPROCESSING #7

**OUR BOOK
DESCRIBES SMS McSIM
AND OTHER
DESIGN SUPPORT SYSTEMS.**

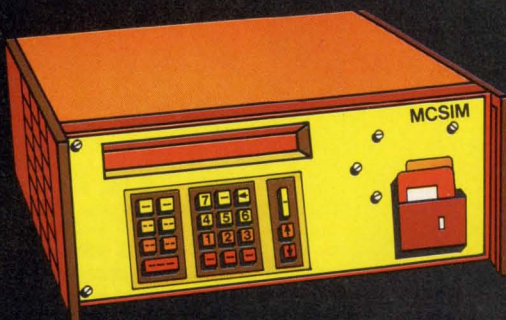

In addition to SMS McSim, the prototyping system, there are details on ROM Simulator, Micro-assembler, SMS McCAP Assembler and more.

Open the door to easier designing.
Clip coupon to letterhead.

Name _____ Title _____
Tel. _____ M.S. _____
811 E. ARQUES, SUNNYVALE, CA. 94086

**THINK
Signetics**

a subsidiary of U.S. Philips Corporation

© 1976.

Circle 150 on reader service card

Amazing AIRBRASIVE[®] "Wonder Tool"

It can cut or etch. Or strip and clean. Or drill and deflash. Amazing!

Try it. You'll wonder why you waited so long. You'll see why the versatile S.S. White Airbrasive tool is *the* low cost production tool for precision work on small electronic parts and components. It works on metals or glass, quartz or ceramics, the most delicate-to-handle semiconductor and crystalline materials. Airbrasive's stream of micro-abrasive particles gives you cool, shockless jet machining to the most critical tolerances. And at real savings in production time *and* labor costs. Wonder how much Airbrasive costs? Just \$825 for Model K—ideal for lab work, pilot runs, and similar light-duty, limited production. Model H, at \$1625, can deliver jet-machined production parts in high-volume to meet your most demanding production schedule.

Write for our illustrated brochure today. Or arrange for a demo and try the Airbrasive Wonder Tool on your parts. Write or call Jim McDonald, S.S. White Industrial Products, Pennwalt Corp., 151 Old New Brunswick Road, Piscataway, NJ 08854 (201) 752-8300.

®Trademark of Pennwalt Corporation

S.S. WHITE
PENNWALT
EQUIPMENT ■ CHEMICALS
HEALTH PRODUCTS

The "Wonder Tool"
AIRBRASIVE[®]

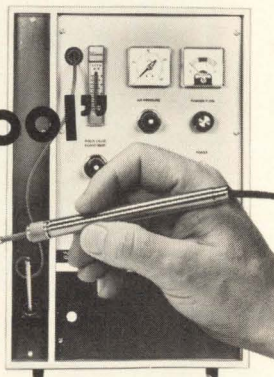

Precise and shockless enough to cut intricate patterns in an eggshell.

150 Circle 198 on reader service card

New products

the SPD series units is from stock. Solid State Devices Inc., 14830 Valley View Ave., La Mirada, Calif. 90638. Phone (213) 921-9660 [416]

Quad op amp slews at
1.3 V/ μ s, minimum

Designed to combine the qualities that make the 741 a popular general-purpose operational amplifier with improved ac response, the RC/RM4156 has a minimum unity-gain bandwidth of 2.8 megahertz, a minimum slew rate of 1.3 volts per microsecond, and all of the dc parameters and offset specifications of the 741.

The unit's high slew rate guarantees it full-power response from 20 hertz to 20 kilohertz. Also its input noise voltage of 2 microvolts rms over that same bandwidth suits it for audio applications.

The 4156 is offered in three temperature ranges, two packages, and as probed wafers or chips.

Raytheon Semiconductor, 350 Ellis St., Mountain View, Calif. 94040. (415) 968-9211 [417]

TOPICS

Semiconductors

Signetics, Sunnyvale, Calif., has introduced its model 2680 4,096-bit dynamic random-access memory as an alternate source to the Intel 2107B and the Texas Instruments 4060. . . .

TRW Capacitors, Solid State Operation, Ogallala, Neb., has raised the maximum current-handling capability of its line of power transistors from 30 amperes to 80 A—a design improvement that has also increased gains and reliability. . . . **Fairchild Camera and Instrument Corp., Analog Products division, Mountain View, Calif.**, has announced a single-supply dual operational amplifier that is said to virtually eliminate crossover distortion. The high-gain model μ A798 is internally compensated.

Electronics/February 3, 1977

Dialight LEDs

The widest choice for your every application.

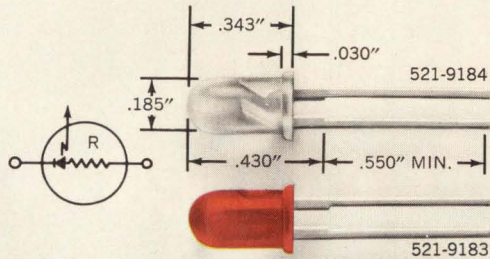

Available in red or clear LED packages with or without a built-in current limiting resistor. Red LED is also made without resistor. Suitable for circuit status indication, alpha-numeric displays and visual indicators. Features long wire-wrappable leads. IC compatible with solid state reliability. High luminous intensity, low power consumption, low cost.

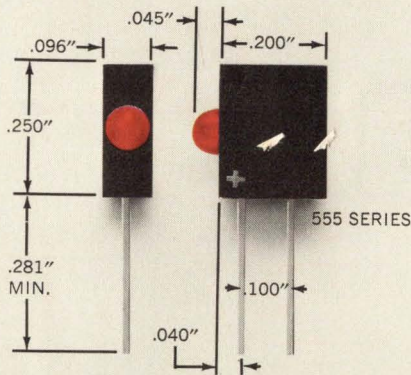

LED logic state fault indicators available in 14 models with voltage ratings from 1.7 to 14. Suitable for dense packaging on printed circuit boards—up to 10 units to the inch—IC compatible. With built-in series resistor. Polarity identified. Low power consumption.

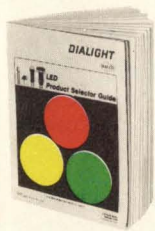

Dialight, the company with the widest choice in switches, LEDs, indicator lights and readouts, looks for needs . . . your needs . . . and then they develop solutions for your every application. No other company offers you one-stop shopping in all these product areas. And no other company has more experience in the visual display field. Dialight helps you do more

with these products than any other company in the business, because we are specialists that have done more with them. Talk to the specialists at Dialight first. You won't have to talk to anyone else. Send for your free new copy of Dialight's current catalog.

DIALIGHT

Dialight, A North American Philips Company
203 Harrison Place, Brooklyn, N. Y. 11237
(212) 497-7600

See Dialight.

Circle 199 on reader service card

This Publication is Available in MICROFORM

from...



Xerox University Microfilms

300 North Zeeb Road,
Ann Arbor, Michigan 48106
(313) 761-4700

PLEASE WRITE FOR COMPLETE INFORMATION

Circle 151 on reader service card

BIPOLAR MICROPROCESSING #8

OUR MICROPROCESSING ANSWERMEN KNOW ALL.

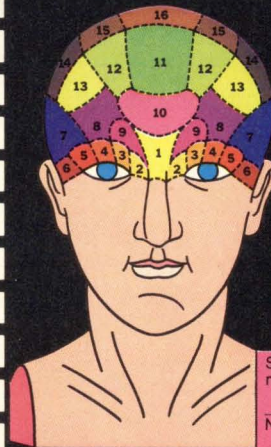

Signetics' field application engineers know bipolar microprocessing—products, benefits, support systems, software, testware, all. Experts help you do it easiest, fastest, cheapest.

Send coupon with letterhead for microprocessing application help.

Name _____ Title _____
Tel. _____ M.S. _____
811 E. ARQUES, SUNNYVALE, CA. 94086

THINK **signetics**

a subsidiary of U.S. Philips Corporation

© 1976.

Circle 200 on reader service card

When Signetics claims our bipolar microprocessors make your design resources go further

How can you switch to bipolar from MOS microprocessing without obsoleting your existing designs? How can you reduce hardware design time, reduce programming time, reduce debugging time? How can you try it before you buy it?

Signetics has put it all together in bipolar microprocessors featuring the industry's most complete product family, fastest 2-bit μ PA (3001), first 8-bit fixed instruction processor (8X300), the 8080 emulator, several designers' kits, interface elements, bipolar memories and all using Signetics superior low power Schottky LSI technology.

1 **8080 Emulator upgrades performance of existing system.** Delivers 5 times more performance, reduces micro-code writing time, operates from existing software, makes designing easy. (Available now.)

2 **A free microprocessing book.** It's filled with memory, logic, interface info and application notes. All

Signetics' high performance bipolar products are listed in detail.

3 **The industry's leading selection of RAM's, ROM's, PROM's, FPLA's, you name it.** Signetics has more configurations and performance levels available from stock. You get the right fit and absolute maximum efficiency in minimum time.

4 **8X300 Designer's Kit.** We supply all the parts you need to build your own general purpose controller—you do the PROM programming, checkout prototype system, order production quantities from Signetics. It's just another example of Signetics total support.

5 **Long list of interface products to pick from.** Signetics has the interface products you'll need to make your bipolar microprocessing shopping easier and more convenient. Now you get everything on your list from one source.

6 **Introductory Designer's Kit. A \$230.00 value, for \$100.00.** You get 12 parts and 1 manual to let you work with bipolar, design with bipolar, program

...we support it.

- 1** Increase performance with the 8080 Emulator.

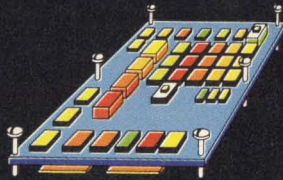

- 2** We have the book on microprocessing.

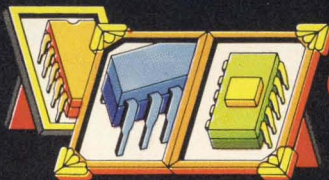

- 3** The industry's leading family of bipolar memories.

- 4** Dream up controllers with the 8X300 Designer's Kit.



- 5** One-stop shopping for interface products.

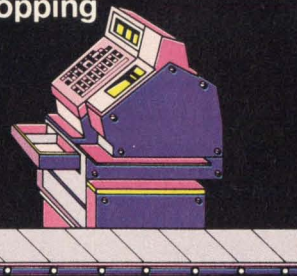

- 6** Introductory Designer's Kit \$100.



- 7** Microprocessor book describes design support systems available.



- 8** Our microprocessor answermen know all.



with bipolar, and prove out all the advantages for yourself. The parts you need to actually try out Signetics' 3000 Total System.

7 **A description of all design support systems.**

Read all about 'em. SMS ROM Simulator, SMS McSim Prototyping System, Microassembler, SMS McCAP Assembler and more, all in the microprocessor book.

8 **Field Applications Engineers that know bipolar microprocessing.** They have the industry's best support systems at hand to help you solve your design problems. They will show you exactly how Signetics' total bipolar microprocessor capabilities will make your design resources go further.

Now you know when Signetics claims to reduce your hardware design time, to reduce your programming time, and to reduce your debugging time... Signetics supports it. Start saving time in the future by mailing the coupon today.

Attach this to your letterhead for fast response.

- Send me information on the 3000 Introductory Designer's Kit.
- Send me information on the 8X300 Designer's Kit—to dream up my own controllers.
- I want to read the book on bipolar microprocessing. Send it ASAP. FREE.
- Send me info now on an emulator that delivers 5 times more performance, the 8080.
- Have a Bipolar Microprocessing Answerman call me for an appointment.

My application is _____

Name _____ Title _____

Telephone _____ Mail Stop _____

THINK Signetics

811 E. Arques Ave., Sunnyvale, Ca. 94086

© 1976.

a subsidiary of U.S. Philips Corporation



All our memories are worth remembering.

Everybody knows NEC Microcomputers makes the fastest and most reliable 4K MOS RAMs on the market.

But that's just the start of our state-of-the-art memories.

We've got both static and dynamic types. In NMOS, CMOS and bipolar technologies. All made with the same care and quality control we give to our more famous products.

And we can deliver them in the quantity you need, when you need them.

At prices that are very competitive.

So if you are in the market for memory components, remember everything we have.

And remember us.

NEC Microcomputers, Inc., Five Militia Drive, Lexington, MA 02173. 617-862-6410.

Product	Description	Organization	Access Times (Max) (ns)
2101AL	NMOS Static RAM	256 x 4	250-450
2102AL	NMOS Static RAM	1K x 1	250-450
2111AL	NMOS Static RAM	256 x 4	250-450
5101	CMOS Static RAM	256 x 4	450
2205	Bipolar TTL Static RAM	1K x 1	45
403	Bipolar PROM (A.I.M.*)	256 x 4	60
405/25	Bipolar PROM (A.I.M.)	512 x 8	70
406/26	Bipolar PROM (A.I.M.)	1K x 4	80
2308	NMOS ROM	1K x 8	450
2316A	NMOS ROM	2K x 8	450

*Avalanche Induced Migration

NEC microcomputers, inc.

REPS: East—C & D Sales 301-296-4306, Contact Sales 617-273-1520, Harry Nash Assoc. 215-657-2213, Tech-Mark 607-748-7473, Trionic Assoc. 516-466-2300; South—Perrott Assoc. 305-792-2211, 813-585-3327, 305-275-1132, Wolfs Sales Serv. Co. 919-781-0164; Midwest—Electronic Innovators 612-884-7471, K-MAR Eng. & Sales 816-763-5385, R.C. Nordstrom & Co. 313-559-7373, 616-429-8560, Technology Sales 312-438-3300; West—Mike Duffy Assoc. 303-934-7392, Electronic Component Marketing 714-524-9899, 213-649-5374, Spedden Assoc. 714-295-6122, Summit Sales 602-994-4587, Trident Assoc. 408-734-5900, Tri-Tronix 206-232-4993, 505-265-8409; Canada—R.F.Q. Ltd. 416-626-1445, 514-626-8324.

DISTRIBUTORS: Century Electronics (Albuquerque, Salt Lake City, Wheatridge CO), Diplomat (Chicopee Falls MA, Clearwater FL, Dayton, Elk Grove Village IL, Farmington MI, Little Falls NJ, Minneapolis, Mt. Laurel NJ, Salt Lake City, St. Louis, Sunnyvale, Woodbury NY), Future Electronics (Montreal, Ottawa, Rexdale, Canada), Harvey Electronics (Fairfield NJ, Lexington MA, Norwalk CT, Woodbury NY), Intermark Electronics (San Diego, Santa Ana, Seattle, Sunnyvale) Lionex (Burlington MA), G.S. Marshall (Sunnyvale), Mirco Electronics (Phoenix), Resco (Raleigh), R-M Electronic (Kentwood MI, Madison Hgts MI), Semicomp (Newport Beach CA) Semiconductor Specialists (Burlington MA, Chicago, Dallas, Dayton, Farmington MI, Hazelwood MO, Indianapolis, Kansas City, Los Angeles, Milwaukee, Minneapolis, Pittsburgh; Malton Canada), Sterling Electronics (Albuquerque, Dallas, Houston, Los Angeles, New Orleans, Phoenix, San Diego, Seattle, Watertown MA), Technico (Columbia MD, Roanoke VA), Zeus Components (Elmsford NY).

New products

Data handling

Core ROM aimed at plant uses

Memory tolerates high electrical noise, offers nondestructive readout

The growing use of microprocessors in industrial controls creates a need for memories that are not affected by power outages and operate reliably in environments with high electrical noise. For these applications, Controlex Corp., Van Nuys, Calif., has introduced a 4-kilobyte ferrite-core electrically alterable read-only memory that is compatible with 8-bit microprocessor-bus systems.

The Controlex CM203 alterable ROM uses conventional cores but includes a proprietary technique to achieve nondestructive readout (NDRO) [*Electronics*, April 1, 1976, p. 31]. "By operating in a true NDRO mode, in contrast to the classical core memory, where data has to be restored as it is read, our EAROM may be selectively read or written at

any random address without affecting data stored at other locations," says Bruce Kaufman, Controlex president. The CM203 thus adds its nondestructive-readout capability to recognized core-memory strengths of nonvolatility and insensitivity to electrical impulse noise. Together, these characteristics allow the CM203 to function as a true nonvolatile RAM, Kaufman notes, with a simple switch control converting it into what is in effect a "RAM/EAROM mix."

The device also has an advantage over semiconductor memories for industrial uses because, he says, dynamic RAMs have to be refreshed, and both these and refreshed static RAMs lose data from a power outage. The Controlex alterable ROM's 350-nanosecond access time makes it competitive with semiconductor memory speed, Kaufman claims.

Other specifications are: 1-microsecond cycle time for read or write; TTL interface; operation with +5-volt and ± 120 -v dc supplies, and an operating-temperature range of 0 to 70°C. The memory is entirely mounted on 0.75-in. centers on a single 8.5-by-12-inch printed-circuit board.

Price of the CM203 is \$500 when

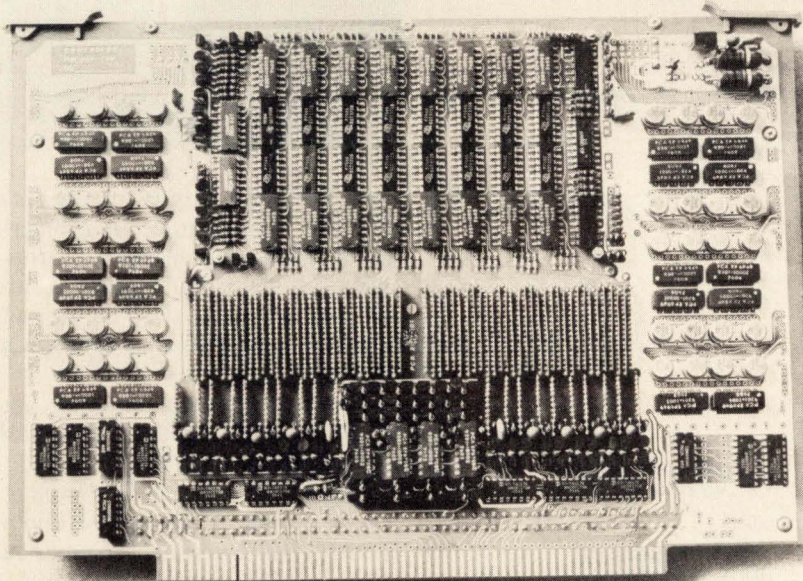

COIL-LER

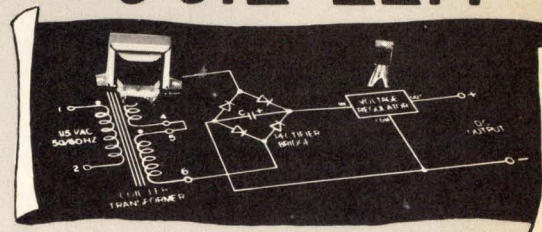

STOCK P.C. POWER TRANSFORMERS

- For use with 3-terminal IC voltage regulators
- Printed circuit mounting
- For power supplies for most integrated circuit families
TTL LOGIC ECL LOGIC
CMOS LINEAR-OP AMPS
- 36 models in stock

Write or phone for complete data sheet.

COIL-LER CUSTOM

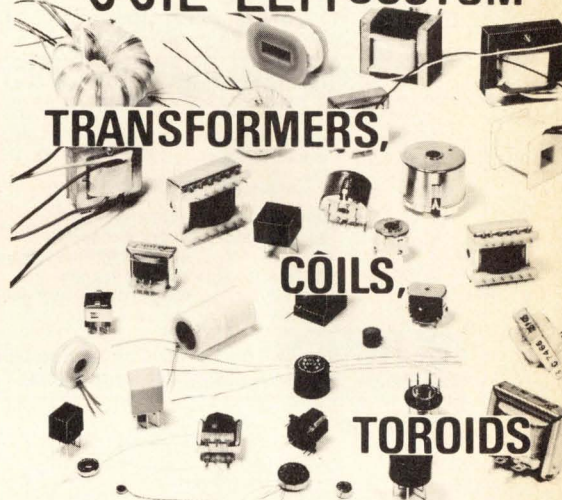

TRANSFORMERS,

COILS,

TOROIDS

Computer aided design of magnetic components and power supply circuits assures exact compliance with specs. Our precision manufacturing facility produces a full range of medium, miniature or ultra-miniature size transformers and coils — bobbin or toroidal wound.

Write or phone for information or quotes.



COIL-LER
MANUFACTURING, INC.

2-E Town Line Circle Rochester, N.Y. 14623
716/442-6630
Representatives in Principal Cities

EFFICIENCY EXPERT.

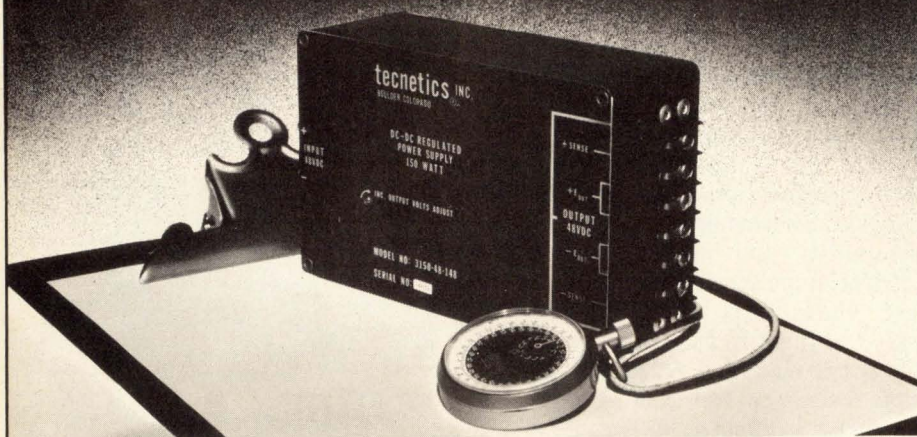

Up to 86% efficiency in Tecnetics DC to DC regulated converters.

When your design calls for a highly efficient regulated converter in a compact package, Tecnetics' 3000 series fits the bill. Efficiencies range from 66% to 86% with packing densities up to 2.78 watts per cubic inch. Our broad product line gives you a choice of models with 25, 50, 100 and 150 watts of power and outputs from 5 to 48 volts.

Standard features of the 3000 series include input-output isolation, overload and short circuit protection, input filters to reduce conducted EMI, and remote error

sensing to insure that the proper voltage is maintained at the point of load. All units are fully encapsulated and designed to meet the vibration, shock, humidity and altitude specs of MIL-E-5400.

So, when you are looking for state-of-the-art power converters, look to Tecnetics, the company with proven expertise. For more information and prices on the 3000 series, or three-hundred other power supplies, write for our 26 page catalog.

3000 SERIES HIGH EFFICIENCY REGULATED CONVERTERS

Output Power	150, 100, 50, & 25 watt models
Output Voltages	13 standard outputs from 5 to 48 V
Input Voltages	28VDC or 48VDC (48 VDC only on 150 w units)

Price range: \$395-\$525.

Dimensions (excluding terminals):

25 & 50 watt:	4x4x2 inches
	36 oz. Fully encapsulated
100 & 150 watt:	6x4x2 1/4 inches
	60 oz. Fully encapsulated

Regulation:

Line (LL to HL)	0.3%
Load (1/2 to FL)	0.1%
Load (NL to FL)	0.4%
Temp	0.01% / °C

tecnetics® The Power Conversion Specialists P.O. Box 910,
1625 Range Street, Boulder, Colorado 80302 (303) 442-3837 TWX 910-940-3246

Circle 156 on reader service card

HOPE

in a word is what we are.

Project HOPE exists because there are people with hope—people who have given 3.5 million men, women, and children on four continents the chance for happier, more productive lives through improved health care.

Give to
PROJECT HOPE

Department A
Washington, D. C. 20007

New products

it is ordered in large quantities. Controlex Corp., 16005 Sherman Way, Van Nuys, Calif. 91406 Phone (213) 780-8877 [361]

LSI chip boosts capability, cuts cost of line printer

The small Glendale, Calif., company that last year developed a microprocessor-controlled electrostatic line printer priced slightly below \$1,000 [*Electronics*, Jan. 22, 1976, p. 40] has already designed that product into obsolescence. Axiom Corp. has replaced the read-only memory and 10 interface-circuitry chips with a single custom large-scale-integrated chip and put the entire printer control on a card 4 inches square. The Intel 4004 microprocessor is used in both versions.

"This design not only makes possible a \$655 price," says vice president Simon Harrison, "but it is greatly simplified and allows the printer to do some things it couldn't before."

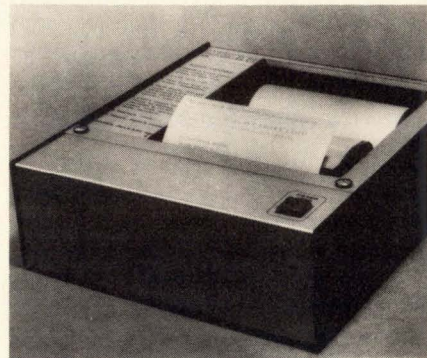

(The \$655 price tag is for the parallel-input printer; price of the serial unit is \$740.) Noteworthy, Harrison points out, is its ability to print three different character sizes on the same line to emphasize words and phrases.

The key LSI chip, built by Intel Corp., is based on the 4308 mask-programmable ROM. It is "affordable for a small company," Harrison says. Along with 8 kilobits of ROM, this chip has 16 input/output lines that may be configured to user specifications. With the Axiom design, the custom Intel device

Beauty comes in different shapes and sizes.

replaces two microprocessor interface chips and eight TTL chips previously used in demultiplexing circuitry. Components on the first Axiom printer were mounted on two cards, one 8 by 6 inches and the other somewhat smaller. The power supply is separate.

Along with the LSI chip, the module card holds 1,024 bits of random-access memory, a power supply, the Intel 4004 microprocessor, a low-paper detector, and a hybrid chip being manufactured offshore. This hybrid converts microprocessor-controlled signals from the RAM to 45-volt pulses that drive the printing head. The only electronic components not on the replaceable card are the transformer and solid-state relay for turning current on and off.

"Our philosophy of building an inexpensive, simple but high-performance printer is letting the microprocessor do as much as possible," explains Harrison. "The 8 kilobits of ROM triple the character-generation capability we had on the first model and thus control sophisticated programs and routines up to three times as complex." The simplified design that reduces the component count cuts their cost by 60%, compared with the first Axiom printer, he says.

Although the first Axiom printer was intended for use in original-equipment systems, the new EX-800 is suitable for stand-alone operation.

Axiom Corp., 5932 San Fernando Rd., Glendale, Calif. 91202. Phone (213) 245-9244 [362]

Display terminals work
with standard protocols

The system 400 series of interactive cathode-ray-tube display terminals is designed to work with Honeywell 7700 VIP, Univac-Uniscop, and IBM 2265 and 3275 protocols. The terminals operate synchronously over dial-up or dedicated lines at speeds to 9,600 bits per second.

The fully buffered terminals allow



These smart looking Optima Accent Cases bring you a wide choice of standard sizes, colors and finishes. But in case you want to bring the world something different, you're not boxed in. We'll cut these special beauties to your own specs. With solid walnut or metal sides, sloped or vertical front panels or whatever. We ship knocked-down to save you money.

Send for our catalog. For freedom of design, we give you freedom of choice.

We make you look better

OPTIMA[®]
Scientific-Atlanta

2166 Mountain Industrial Blvd., Tucker, Ga. 30084 • Tel: (404) 939-6340
Europe: Macmerry, East Lothian, Scotland EH33 1EX

Circle 157 on reader service card

ENVIRONMENTALIZED. OUR DIGITAL PANEL METERS ARE RUGGED.

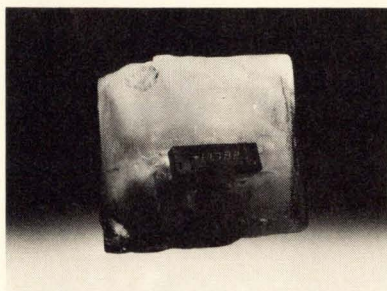

Our IMPAC™ DPMs can withstand extreme temperatures and are totally immersible in water. That's 100% humidity. 15Gs of vibration in any direction and 30Gs of shock is what we call punishment and our tough little DPMs can take it. Available with 3, 3½, 4 and 4½ digit displays. Check our reader service card for more information.



velonex

560 Robert Avenue
Santa Clara, Ca 95050
(408) 244-7370

The hottest news in digital pyrometers is now a cold fact.



from only
\$250.

Measure temperature accurately at lowest cost with Newport's model 267A digital pyrometer.

Available in 30 measurement ranges with direct inputs from thermocouples or RTD sensors on bright 1/2" LED's.

Ranges are bipolar with resolution to 0.01° and conformity to ±0.005°C for RTD's and 0.1°C for thermocouples. Changing ranges in the field is made easy with Newport's plug-in polylog linearizer module.

Opto-isolated BCD outputs are standard while buffered, gated and latched outputs are optional.

Other 267A options include a bench mount all metal case with 1



or 12 switched inputs, rechargeable battery operation, linearized analog output, digital setpoint controller, orange LED display . . . and more. The 267A is now available from World Wide distributors, representatives, or factory direct. For immediate response, call (714) 540-4914.

NEWPORT

Newport Labs
630 East Young Street
Santa Ana, California 92705
In Europe-Tele Amsterdam 20-452052

Circle 158 on reader service card

The Answer Book. It makes your job easier. \$25.

Who makes what? Over 4000 products, 6000 manufacturers with their local contacts, directory of trade names and catalogs, inquiry "bingo" card for 5-second ordering of current catalogs.



Electronics Buyers' Guide
1221 Ave. of the Americas
New York, N.Y. 10020

Yes, send me a copy of The Answer Book. I've enclosed \$25 (USA and Canada only, elsewhere send \$35). Full money back guarantee if returned within 10 days.

Name _____
Company _____
Street _____
City _____ State _____ Zip _____

New products

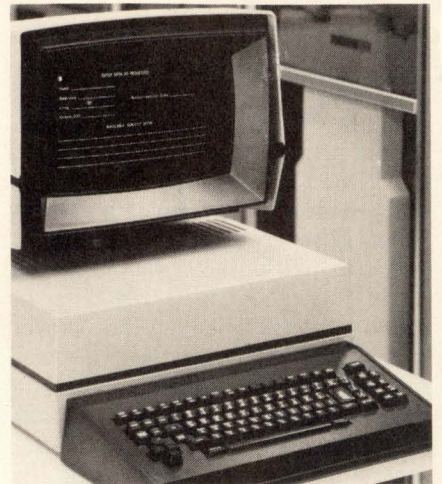

printouts while the operator is entering data on the screen. It also includes such features as dual-intensity display, upper- and lower-case characters, user-defined program-function keys, and self-diagnostics.

Packaged in three modular units—keyboard, display, and control unit—the system 400 does not require cooling fans. Its removable keyboard has audible alarm and light-emitting-diode status indicators. Its keys provide both audible and tactile feedback.

International Communications Corp., 8600 N.W. 41st St., Miami, Fla. 33166. Phone (305) 592-7652 [363]

Vidicon camera system interfaces with computers

Twenty input/output lines enable the C-1000 camera system to exchange queries, information, and commands with analog and digital computers. The high-resolution (1,000-line) system is of modular construction, allowing the user to



Why should you join the
Payroll Savings Plan now?
Maybe you'll find out later.

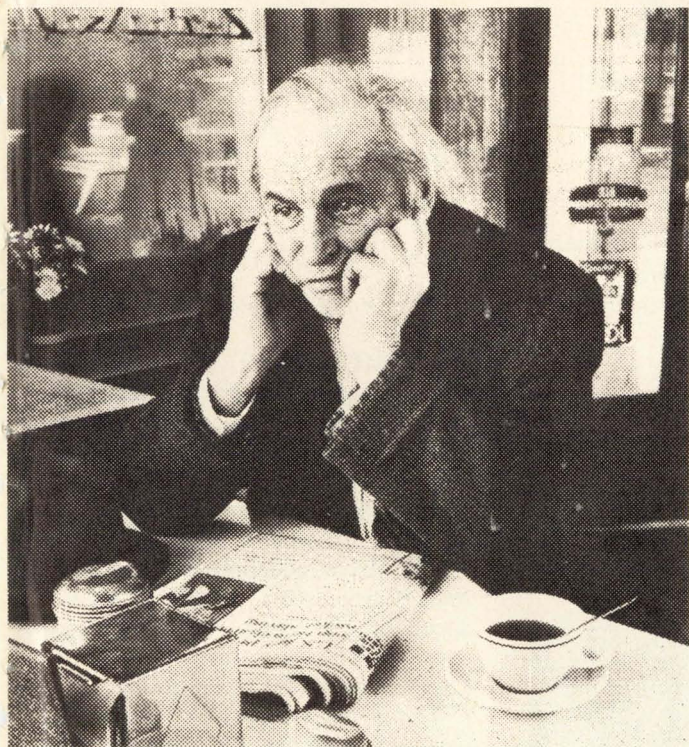

The future can be too late for saving. So if you want security, you'd better start today.

The Payroll Savings Plan makes it easy. Because an amount you choose is automatically set aside from each paycheck to buy U. S. Savings Bonds. That way, your savings build, year after year.

So start today. Because tomorrow, today will be yesterday.

Now E Bonds pay 6% interest when held to maturity of 5 years. 4 1/2% the first year. Bonds are replaced if lost, stolen or destroyed. When needed, they can be cashed at your bank. Interest is not subject to state or local income taxes, and federal tax may be deferred until redemption.



**Take
stock
in America.**
Join the Payroll Savings Plan.

Ad Council A public service of this publication and The Advertising Council

Electronics / February 3, 1977

LOW COST MAGNETIC SENSORS



... for your speed/position
input requirements!

Electro has developed a new competitively priced line of molded plastic magnetic sensors for use in producing input signals for the control of speed and position.

Consider the reliability and economy offered by Electro magnetic sensors proven in these applications:

- Engine timing (position and synchronization)
- Closed-loop motor speed control
- Mixer/blender speed sensing
- Conveyor speed monitoring
- Anti-skid control sensing systems
- Turbine RPM monitoring and control.

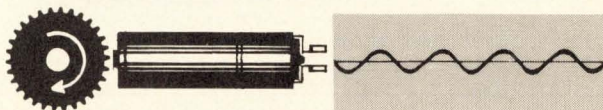

Electro magnetic sensors provide many advantages including: non-contact sensing of any ferrous metal object; trouble-free operation under all conditions such as dust, dirt, oil and other adverse environments; -65°F to +300°F operating range.

Send us your system input sensing specifications. We will provide you with the most economical solution!



**ELECTRO
CORPORATION**

1845 57TH STREET

P.O. BOX 3049, SARASOTA, FLORIDA 33578
AREA CODE (813) 355-8411 • TELEX 5-2683

Circle 159 on reader service card 159

DANA INTRODUCES THE SMART COUNTER.

Series 9000: World's First Microprocessing Timer/Counter.

The Dana Series 9000 is smart enough to make your work a lot easier. Microprocessing controls provide all the features of a premium timer/counter, a reciprocating counter and a calculator. Plus interfacing options and operating capabilities never before available in one instrument.

The Dana Series 9000 Microprocessing Timer/Counter goes so far beyond all other counters it takes a whole brochure just to explain its capabilities. Ask for it. It's the smart thing to do.

Dana Laboratories, Inc., 2401 Campus Drive, Irvine, California 92664, 714/833-1234.



For Product Demonstration Only circle 160
For Literature Only circle 203

CAREER OPPORTUNITIES

Usually the best opportunity to grow in your field lies within your present company. You have made an investment in them. They have an investment in you.

But occasionally the best opportunity lies somewhere else. No one can decide but you.

Companies looking for good people run their recruitment ads in our Classified Section in the back of this magazine. Perhaps you'll find an opportunity there that's worth following up.

New products

purchase only those subsections needed for his particular task. All handshake and control lines are built into the system. Prices of the C-1000 start at \$3,500; delivery time is 30 days.

Hamamatsu Corp., 120 Wood Ave., Middlesex, N.J. 08846. Phone Ralph Eno at (201) 469-6640 [364]

Tape drive operates from 12.5 to 75 inches/second

The TME tape drive, which uses vacuum-column buffering for high performance, efficiency, and operational convenience, can operate at any speed from 12.5 to 75 inches per second. Standard speeds are 12.5, 25, 37.5, 45, and 75 in./s.

The drive accommodates 8.5-in. and 10.5-in. reels. It has a rewind speed of 200 in./s. A fast-forward speed of 150 in./s for search operations is available as an option.

The TME incorporates electronic de-skew, channel by channel, for both read and write. It precisely duplicates the IBM tape path in both guide spacing and guide diameter.

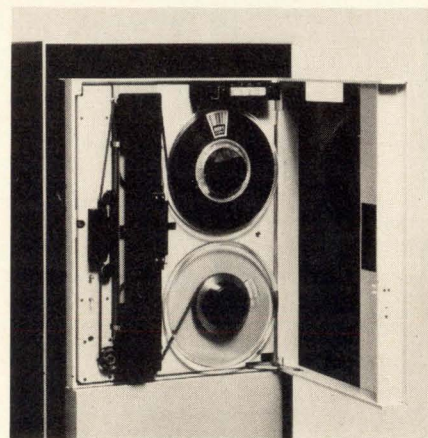

The drive has a transfer rate of 20,000 to 120,000 bytes per second and has a start time, at 75 in./s., of 5.5 ± 1.0 milliseconds. Maximum rewind time is three minutes.

The TME sells for \$4,200 in OEM quantities.

Ampex Corp., 401 Broadway, Redwood City, Calif. 94063. Phone (415) 367-4151 [365]

THE BEST VOLTMETER YOU CAN BUY ISN'T A VOLTMETER.

The Fluke 8500A is an advanced measurement system, but most people buy it because it's the finest high speed 10 ppm voltmeter built.

So why make a distinction?

Simply because all other digital voltmeters have been nothing more than that, voltmeters. As quickly as technology advanced or needs changed, the unit became obsolete. Not so with the 8500A.

The 8500A employs a unique analog/digital bus in conjunction with an internal micro-processor to control measurement and interface modules. The function modules, such as resistance, current, IEEE-488 interface, etc., can be plugged into any available slot in the bus by the user.

The controller then senses the module and measures the new parameter or performs the new function.

So as technology or your needs change, so does the 8500A. You won't be stuck with a dead-ended instrument.

All for a basic system price of \$2,695*.

Obviously, there's a lot more to tell. For data out today, dial our toll-free hotline, 800-426-0361.

**U.S. price only.*

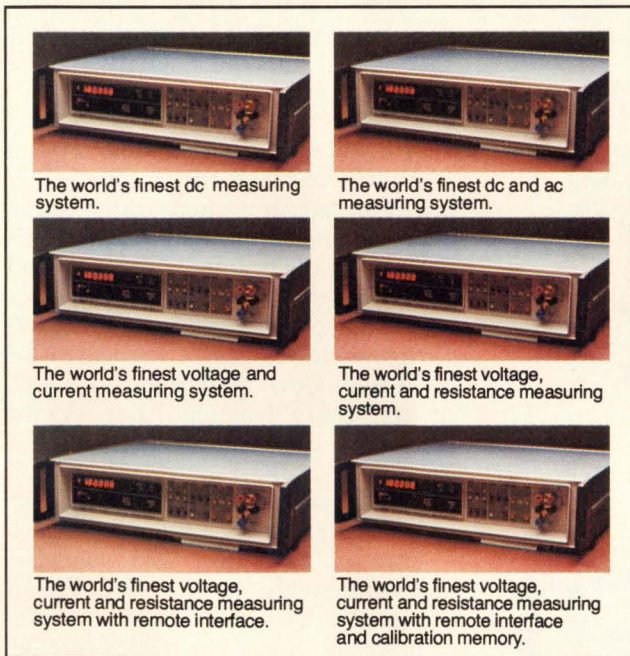
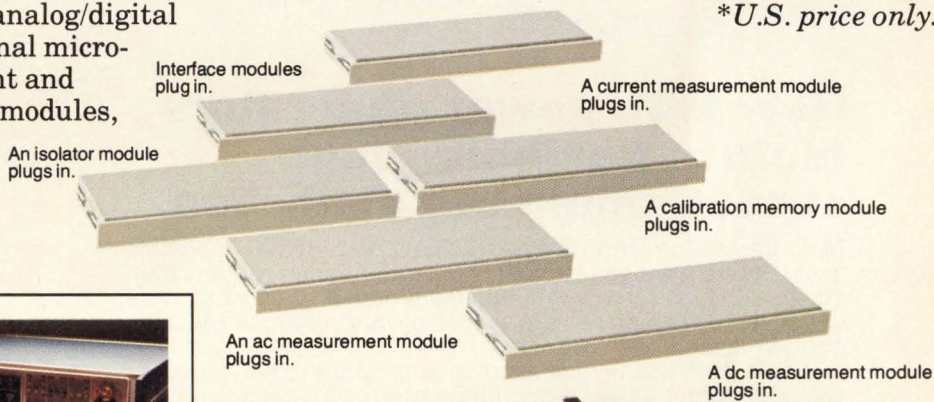

The 8500A can be whatever you want it to be, so it's never obsolete.



The heart of the 8500A is a universal architecture with a unique analog/digital bus.

65 watts, 10 MHz-2.5 GHz



New MCL power generators feature flexibility, high output, minimum distortion.

Main frames for 115 VAC and for 208/220/240 VAC operation. Six standard front panel plug-ins provide frequency range from 10 MHz to 2500 MHz with a minimum output of 65 watts. Two optional plug-in modules are available which produce 100 watts narrow-banded.

Single knob tuning for each plug-in provides exact frequency selection. Front panel, direct frequency readout is accurate to ± 1 percent.

Solid-state mainframe designed for minimum components, optimum reliability. Residual AM held to .1 percent, eliminating nearly all AM distortion in output waveform. Generates continuous or 1 KHz square wave pulsed output. External AM signal generator can be added with single plug-in connection. External pulse circuit is TTL compatible. Automatic VSWR protection.

Write or call for your 4-page power generator brochure: Tom Rys, MCL, Inc., 10 N. Beach, LaGrange, IL 60525. (312) 354-4350.



Circle 162 on reader service card

HELP WANTED

While it is not our policy to encourage job hopping—quite the opposite, in fact—the headline above must have got your attention for a reason.

Perhaps you should turn to the back of this issue to our Classified Section. One of the job descriptions might fit you.

New literature

Polycarbonate capacitors. A line of metalized polycarbonate film capacitors for circuits requiring stable performance over a wide temperature range is described in a catalog



available from the Sales Dept., Union Carbide Corp., Components Dept., Box 5928, Greenville, S.C. 29606. Circle reader service number 421.

Hospital safety. The Directory of Audiovisual Aids for Hospital Safety Programs is a concentrated listing of motion pictures and other aids useful in the training of hospital and health-care personnel. It includes material on electrical safety. The 36-page directory can be purchased for \$4 from Quest Publishing Co., P.O. Box 4141, Diamond Bar, Calif. 91765.

Cosmac manual. Written for electronics engineers with limited knowledge of computers and computer programming, the User Manual for the RCA CDP1802 Cosmac Microprocessor guides the reader through the microprocessor architecture and introduces a set of comprehensive, easy-to-use programming instructions. The 115-page manual, MPM-201A, may be obtained for \$5 from RCA Solid State Division, Box 3200, Somerville, N.J. 08876.

Coaxial cable. Belden's coaxial cable guide describes 35 new or modified

constructions and gives data on more than 60 cables. The 20-page catalog features three cables with foam-polypropylene insulations, which offer better characteristics than solid

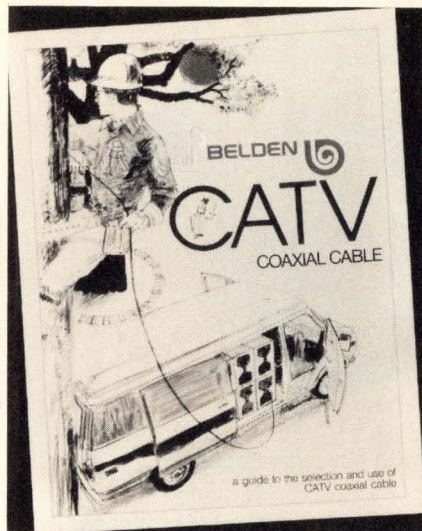

or foam polyethylene in some applications. For a copy, write to the manager, Marketing Communications, Belden Corp., 2000 S. Batavia Ave., Geneva, Ill. 60134 [424]

Transformers. An 84-page catalog from TRW/UTC covers the company's line of audio transformers and inductors, power transformers and inductors, pulse transformers, high-Q inductors, and electric wave filters. Supplementing the data for each product category is a brief explanation of product terms and theory, along with a one-page selection guide. Catalog 771 is available from TRW/UTC Transformers, 317 N. McLewsen St., Kinston, N.C. 28501 [425]

Encapsulated power supplies. A line of ac-dc and dc-dc encapsulated, miniaturized power supplies is described in a 12-page catalog put out by Arnold Magnetics Corp., 11520 W. Jefferson Blvd., Culver City, Calif. 90230. The publication includes complete specifications, prices, and ordering information. A design-as-you-order section provides the instructions and technical data for specifying custom power supplies. [426]

For Sale



70 million optimized filters (in one small box)

For analog or digital signal conditioning, alias-free signal processing, and every kind of spectrum shaping, our Models 452 and 852 wide-range-adjustable dual analog filters are the best choice... and the best buy.

Why best? Because these are *truly* optimized filters — designed without the tradeoffs and compromises that limit the effectiveness and the applications range of other designs. To begin with, both the Model 452 (4-pole) and the Model 852 (8-pole) provide dual, completely independent channels, with *near-ideal* flat-amplitude and linear-phase responses (pushbutton selectable).

But that's not all you should look for in an *optimized* filter. You have a right to expect *negligible* offset and offset drift. *Negligible* feedthrough coupling. *Very* high input impedance. *Very* low output impedance. *Negligible* noise. *Precise* and uniform range-to-range calibration. The *highest* possible time and temperature stability. The *widest* possible dynamic range. *Complete* modal flexibility — high-pass, low-pass, bandpass, band-reject, notch... and freedom to cascade independent channels, as well.

In the 452/852 designs, we deliver *all* of those features — at no higher cost than conventional, heavily compromised designs.

As for applications range, check these parameters: any cutoff frequency from 0.1Hz to 111 kilohertz, (optionally, down to 0.01Hz). Pushbuttons select

High-Pass or Low-Pass; 0dB or 20dB gain; Flat-Amplitude (Butterworth) or Flat-Delay (linear-phase) response. Model 452 gives you 24dB/octave; Model 852, 48dB/octave. Cascade channels to *double* the rolloff. Altogether, there are over 70 million combinations of settings and modes (count them).

BUDGET TIGHT? Get the facts and figures on Models 432/442 — similar range, performance, and flexibility but lower resolution... at *much* lower cost.

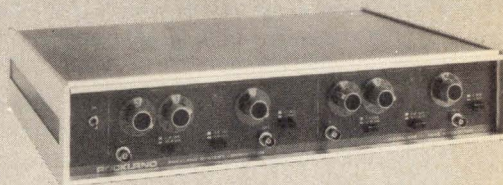

HOW & WHY optimized filters can enhance the performance of your analog and digital systems is explained in great detail in this new 24-page Handbook. Get it — *free* by using the inquiry number or write:

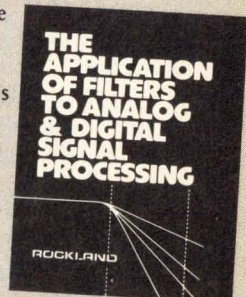

Rockland Systems Corporation
230 W. Nyack Road
W. Nyack, N.Y. 10994
TEL: (914) 623-6666
TWX: 710-575-2631

ADVANCED SIGNAL TECHNOLOGY
ROCKLAND
SYNTHESIS • PROCESSING • ANALYSIS

Our Second Decade of Leadership

Circle 162 on reader service card

Introducing the Son of "Microprocessors"

Second and third generation microprocessor technology is here, and covered in this new 200 page book "Applying Microprocessors", which picks up where its best-selling predecessor, "Microprocessors", left off. Includes 26 detailed applications from data networks to video games. Indispensable. A *must* for every electronics engineer.



Since the publication of "Microprocessors" only one year ago, enough has happened in the microprocessor revolution to fill a book. That book has just been published.

"Applying microprocessors" is expected to surpass the first book's record sales—over 20,000 copies, now in the fourth printing. The new book completes the engineer's transition from the old methods of electronic design to the new world of microprocessor engineering. The book contains the up-to-date and ready-to-use information that every designer needs to know about the new technology:

Part 1: The hardware. Microprocessors and peripheral devices. Overview of what's available to designers. Descriptions of the latest generation from on-chip devices with erasable memory to 16-bit minicomputer-like devices.

Part 2: Programming and prototype design. Surveys of available software and systems (including in-circuit emulation techniques). Computer-programming approach

to design contrasted with hardware-oriented approach.

Part 3: Actual applications. How the microprocessor is fulfilling the most optimistic hopes for its potential. Detailed descriptions of the ways today's devices already control all types of systems.

The new book focuses on actual applications, with specific how-to-do-it information on 26 applications of the new technology, including . . .

- data networks
- engine temperature monitors
- radar coordinate converters
- teleprinters
- telephone systems
- oscilloscopes
- blood analyzers
- cash registers
- video games
- weighing systems
- analog data processing
- data acquisition systems

No-risk trial offer

To prove the importance of this book to every engineer, the publishers are making a ten-day trial offer. You must be completely satisfied that the book fulfills its promise or your money will be refunded.

Electronics Book Series

P.O. Box 669 Hightstown, N.J. 08520

Send me _____ copies of "Applying Microprocessors" at \$9.95 per copy.

I must be fully satisfied or you will refund full payment if the book is returned after 10 days trial examination.

Payment enclosed Bill firm Bill me

Credit Cards Charge My Book To

American Express Master Charge Acct. No. _____
 Diners Club BankAmericard No. _____
 Date Card Expires _____ Interbank No. _____

1st No's. above name on Mastercharge only.

Name _____ Title _____
 Company _____
 Street _____
 City _____ State _____ Zip _____
 Signature _____



NEW PRODUCTS!*

HAND ACTIVATED MAGNETIC CARD TRANSPORT

- * ULTRA LOW COST \$70.00 FOR SAMPLES, QUANTITY LOT \$40.00 OR LESS (1 CH. TYPE) F.O.B. JAPAN
- * HIGH READOUT RELIABILITY!
- * MINI COMPACT DESIGN
- * AVAILABLE 2 CH. TYPE ETC.



MCR-111-2R 2CH. READ

- * ABA, IATA, MINTS, ISO, Standards Specification
- * Single Power Supply DC + 5 V.
- * Readable Wide Range Card Speed Operation
- * Applications
Banking, POS, ID and Security Terminal, Parking System, Gas Station Terminal, Program Loader, Inventory Control, etc.

S.R.D. CORPORATION



2-12-1, KAGA, ITABASHI-KU, TOKYO, 173 JAPAN

CABLE ADDRESS: SRDCORPORATION TOKYO
TEL: (03) 964-1151
TELEX: 0272-3546 SRD CO J

Circle 205 on reader service card

RF & MICROWAVE SOURCES INFRA-RED, LF, UHF and VHF

RADAR SYSTEMS: 150 MHZ to 35 GHZ

AUTOTRACK ANTENNA MOUNTS: Nike Hercules, Nike Ajax, SCR 584. Capacity 50 lbs. to 10,000 lbs. Light Airborne to Sage Systems

RADAR INDICATORS: PPI-RHI-A/B/C/Scopes

PULSE MODULATORS: 25KW to 10 Megawatts

HIGH VOLTAGE POWER SUPPLIES: Up to 20KV 2A

MICROWAVE TUBES: TWT, Klystron, BWO, Carcinotron, Magnetron Every Frequency

MICROWAVE COMPONENTS SONAR SYSTEMS

SEND FOR FREE 24 PAGE CATALOG ON YOUR LETTERHEAD

RADIO RESEARCH INSTRUMENT CO. INC.

2 LAKE AVENUE EXTENSION, DANBURY, CT. 06610 (203) 792-6666

Circle 206 on reader service card

New books

Digital-Integrated-Circuit, Operational-Amplifier, and Optoelectronic Circuit Design, Bryan Norris, ed., McGraw-Hill, 206 pp., \$16.50.

MOS and Special-Purpose Bipolar Integrated Circuits and R-F Power Transistor Circuit Design, Bryan Norris, ed., McGraw-Hill, 228 pp., \$16.50.

Management Handbook for Plant Engineers, Bernard T. Lewis, ed., McGraw-Hill, 719 pp., \$29.95.

Exploring Laser Light, T. Kallard, Optosonic Press (New York), 298 pp., \$11.50 (paper).

The 555 Timer Applications Sourcebook with Experiments, Howard M. Berlin, E & L Instruments (Derby, Conn.), 155 pp., \$6.95.

Superionic Conductors, G. D. Mahan and W. L. Roth, eds., Plenum Press, 438 pp., \$39.50.

EMP Radiation and Protective Techniques, L. W. Ricketts, J. E. Bridges, and J. Miletta, Wiley, 380 pp., \$27.50.

Digital Computer Fundamentals, Jefferson C. Boyce, Prentice-Hall, 420 pp., \$15.95.

Superconducting Electron-Optic Devices, I. Dietrich, Plenum Press, 140 pp., \$19.50.

The General Theory of Alternating Current Machines, B. Adkins and R. G. Harley, Halsted Press, 279 pp., \$22.50.

Preparation and Properties of Solid-State Materials, Vol. 2: Chemical Vapor Transport, Secondary Nucleation, and Mass Transfer In Crystal Growth, William R. Wilcox, ed., Marcel Dekker Inc. (New York), 192 pp., \$22.50.

Communication Satellite Developments: Systems and Technology, Gilbert E. LaVeau and William G. Schmidt, eds., MIT Press, 334 pp., (Vol. 1) and 419 pp. (Vol. 2), \$55.

ANOTHER WINNER

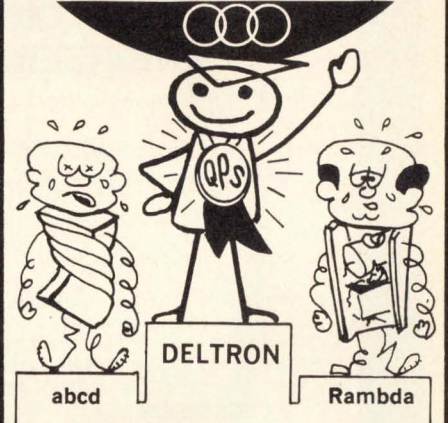

QPS series Power Supplies \$21⁵⁰

One year warranty. From stock. U.L. recognition. Barrier block interface.

Socketed I.C. regulator. Crowbar accessory.

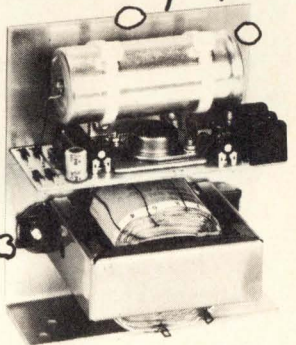

MODEL	QPS-1	QPS-2	QPS-3
RATINGS Volts/Amps	5/3 or 6/2.5	12/1.5 15/1.2	24/1
QTY.	1	100	250
PRICE	\$24.00	\$22.50	\$21.50

Deltron inc.

Wissahickon Avenue
North Wales, PA 19454

Tel: 215/699-9261 Twx: 510/661-8061

AC-10

Circle 165 on reader service card 165

Classified section FOR ENGINEERING/TECHNICAL EMPLOYMENT OPPORTUNITIES

CLASSIFIED SALES REPRESENTATIVES

Atlanta ... Joe Lane ... 404/892-2868
 Boston ... Holt Buchanan ... 617/262-1160
 Chicago ... Bill Higgins ... 312/751-3733

Cleveland ... Mac Huestis ... 216/781-7000
 Dallas ... Mike Taylor ... 214/742-1747
 Denver ... Shirley Klotz ... 303/837-1010
 Detroit ... Mac Huestis ... 313/873-7410

Houston ... Mike Taylor ... 713/659-8381
 Los Angeles ... Stan Kassir ... 213/487-1160
 New York ... Dave Hawksby ... 212/997-3594
 Philadelphia ... Dan Ferro ... 215/568-6161

Pittsburgh ... Dan Ferro ... 412/391-1314
 San Francisco ... M.E. Kenny ... 415/362-4600
 Stamford ... Holt Buchanan ... 203/359-2860
 XEROX 100 TELECOPIER ... 212/997-6800

SENIOR SEMICONDUCTOR ENGINEERS

Settle down in Minneapolis, for the same reason we did...

THE GOOD LIFE

Consistently ranked in the top 3 urban areas in terms of QUALITY OF LIFE, Minneapolis offers all the advantages of a major Metropolitan life style in an environment conducive to country living... where you can trade traffic, crime, and pollution, for lakes, chipmunks and scenery.

Honeywell's Solid State Electronics Center, a multi-location Corporate facility providing a full range of silicon integrated circuit technologies for the Corporation, has an immediate requirement to fill the following senior engineering positions, at our Minneapolis research and advanced development facility.

**CMOS DESIGN
 CCD DESIGN
 BIPOLAR (CML) DESIGN
 BIPOLAR PROCESSING
 E-BEAM PROCESSING
 PHOTORESIST PROCESSING
 BIPOLAR PRODUCT ENGINEERING
 CMOS PRODUCT ENGINEERING**

Qualifications include 3 or more years applicable engineering experience within semi-conductor industry, and appropriate education, and the ability to lead and direct major semiconductor development programs.

If you desire continued career growth and seek an opportunity to utilize your experience within a multi-technology environment dedicated to the development of several unique IC systems applications, please call Gary Clark. Collect at (612) 542-7248. If unable to call, please forward your resume in confidence.

Gary Clark

HONEYWELL, INC.
 12001 State Highway 55
 Plymouth, Minnesota 55441

An Equal Opportunity Employer

COMPUTER HARDWARE ENGINEER

The Computer Science Department at the University of Rochester has a staff position available for a computer hardware engineer. The job involves both the design and construction of interfaces to state of the art peripherals and the maintenance of existing facilities.

This position presents an unusual opportunity for the right person to acquire valuable experience in an exciting new academic department and to grow with a rapidly expanding computer science research facility. Salary: to 15K.

Contact Paul D. Rovner, Computer Science Dept.
 University of Rochester, Rochester,
 N.Y. 14627
 Equal Opportunity Employer M/F

Well-established exporter in metropolitan New York area offers challenging career opportunities:

BUYER

Sharp-eyed, price competitive, experienced OEM components Buyer. Strong semiconductor experience useful. You will provide support for 10 sales people.

EXPORT SALES

Experience in export sales necessary for this management opportunity. Required are: one or more languages, in addition to fluent English; market research orientation, with ability to seek out and evaluate export markets; familiarity with electronic industry.

Salaries open, profit incentives and fringe benefits. Send resume, indicating job preference and salary history, in confidence, to:

BOX E 532
810 7th Ave., New York, N.Y. 10019

An Equal Opportunity Employer M/F

NOW IS THE TIME ... TO HIRE A STUDENT THIS SUMMER.

First, it's later than you think, with schools closing on different semester schedules, and students torn between lining-up "sure" jobs now or gambling that something in their chosen field will come along later.

Second, and most important, it's in our industry's best interest to encourage and hold its life-blood by providing practical experience in their future profession.

And, since there'll always be more applicants than openings, you'll be able to select the cream of the crop, then evaluate them with an eye towards hiring, when

as coveted graduates, the job market might well be in their favor.

Because we believe this program is of mutual benefit to both employer and employee alike, we again offer our services as a clearing-house.

Just fill out and return the coupon below, and we'll include your organization in a free listing to be sent to Placement Directors and Department Heads at leading colleges and universities across the nation. They'll post it, and the students will contact you directly.

Free summer help listing

MAIL TO: ELECTRONICS/POST OFFICE BOX 900/NEW YORK/NY 10020

NAME/TITLE (of individual to be contacted)

ADDRESS: (Mailing address of your personnel office)

ORGANIZATION: (Firm, Company, Government Agency or Institution)

TYPE AND NUMBER OF STUDENTS SOUGHT: Electronics Avionics

Technician

Other: (Draftsman, etc.)



2/3/77

Note: Last date coupons can be accepted for this year's student mailings is 4/15/77.

ENGINEERS

Computer Peripherals' pace-setting growth, coupled with a market demand for new, advanced-technology products has spurred a major expansion program. We have immediate openings for:

MICROPROCESS ENGINEER

Candidate will have responsibility for hardware/software design and implementation of Microprocessor techniques to peripheral computer controller devices. Applicants for this position must demonstrate experience in:

- * Design and implementation of microprocessor controllers
- * TTL Logic Designs on peripheral equipment
- * Intel 8080 Microprocessor family or equivalent

The above position requires a BS with a MS preferred.

ELECTRICAL PROJECT ENGINEER

Outstanding growth opportunities exist in creative line printer development group for imaginative & creative project leader. Experience should include vibration, stress, structural, dynamic & thermal analysis of electro-mechanical equipment. Responsibility will also include product definition & generation of product specification. BSME required. MSEE preferred with 5 years experience on business equipment or related field. Supervisory experience with engineers & technicians essential.

MECHANICAL PROJECT ENGINEER

Experience will include knowledge of microprocessor technology, power supplies, power drive circuitry. Experience directing efforts of other engineers plus technicians is essential. Minimum qualifications are BSEE & 5 years experience in business equipment or related field. Experience should also include budgeting, scheduling of tasks & writing of proposals & specifications. We offer competitive salaries & benefits & outstanding growth potential. Please send resume & salary requirements to: Mr. Bob Brown

COMPUTER PERIPHERALS, INC.

1480 N. Rochester Road Box E2
Rochester, Michigan 48063
1-313-651-8810

An Affirmative Action Employer M/F

Job-seekers... be the first to know with McGraw-Hill's Advance Job Listings

By having our weekly ADVANCE JOB LISTINGS sent to your home every Monday you can be the first to know about openings both in and out of your field. AJL will enable you to contact anxious recruitment managers BEFORE their ads appear in upcoming issues of 21 McGraw-Hill publications. To receive a free sample copy, plus information about our low subscription rates, fill out and return the coupon below.

ADVANCE JOB LISTINGS / P.O. BOX 900 / NY 10020

PLEASE SEND A SAMPLE COPY
OF ADVANCE JOB LISTINGS TO

NAME

ADDRESS

CITY

STATE/ZIP

—NOW—

Major new contracts provide outstanding new career opportunities with one of the nation's largest developers of tactical missiles and gun systems. The Pomona Division of General Dynamics is located 27 freeway miles from the heart of Los Angeles, and just minutes from mountain resorts.

RADAR TRANSMITTER ENGINEERS

Electronic design engineers for work with high power and low noise transmitters are needed. Experience should include one or more of the following areas: high voltage power supplies, high PRF grid modulators, high power amplifiers, high power static inverters, and transmitter protective circuits. Applicants should also be familiar with transmitter mechanical packaging problems. Positions are open for both lead engineers and electronic designers.

RADAR / GUIDANCE SYSTEM ANALYSTS

Engineers with experience in radar fire control and guidance receiver functional design analysis. A Masters degree and a background in detection theory, estimation theory, clutter analysis and ECOM analysis are highly desirable. Familiarity with math modeling techniques for advanced radar receiver block diagrams is necessary. Positions are open at several experience levels.

RADAR RECEIVER / SIGNAL PROCESSOR ENGINEERS

Electronic design engineers with experience in the design and development of receivers and signal processors. Skills with either or both analog and digital processing are desired. Analog designers should have experience with low noise IF strips, AGC, AFC and APC loops. Digital designers should have experience with techniques such as FFT's, digital filters and/or microprocessors. Lead engineer and electronic designer positions are available.

NUMEROUS OTHER OPENINGS EXIST FOR DEGREED EE's, ME's and IE's

Excellent benefits program, including life and medical insurance, dental and prescription drug plan, savings, stock investment and retirement plans.

Send complete resume including salary history and requirements, in confidence to:

Mail Zone 4-15 EM

GENERAL DYNAMICS

Pomona Division

P.O. Box 2507
Pomona, CA 91766

An Equal Opportunity Employer M/F
U.S. Citizenship Required.

Don't Get Stuck In A Dull Position

Are you staying on at your present job for security? Think again. Your job is secure only when you're in demand. And you're in demand only when you're thinking beyond the expedient into the state-of-the-art. Our client, a systems and equipment manufacturer of great status, vitality and growth,

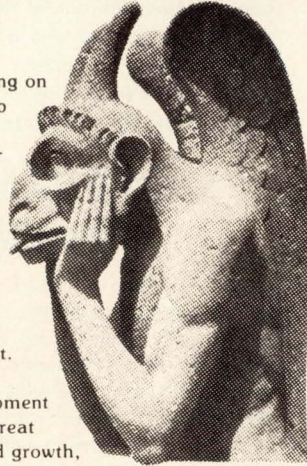

still continues to push state-of-the-art technology to the limit. Here is true security. Long-range projects, a supportive creative climate, efficient management and the kind of salary and advancement potential you deserve. Currently we have an urgent need for talent in the field of complex hardware/software systems.

DIGITAL DESIGN ENGINEERS You will need a BSEE or technical degree in a related area plus 3-7 years' experience in General Purpose Logic Design using high speed integrated circuit logic devices, and familiarity with state-of-the-art digital devices and computer aided design techniques. You should also have experience in Digital Circuit Design, including A/D and D/A Converters and Worst Case Design.

MICROWAVE DESIGN ENGINEERS You will be responsible for conceptual definition, design and development of microwave circuits and components necessary in the Design of Antennas including Phased-Arrays. Knowledge of advanced techniques in computer applications for analysis and control is essential.

SIGNAL PROCESSING DESIGN ENGINEERS This position requires a BSEE or equivalent plus 8-15 years' diversified experience in Digital Logic Design with emphasis on Signal Processing techniques. Your background should include leadership responsibility in the development of complex equipment design, and a thorough knowledge of Digital Hardware. You should have recent experience in one or more of the following disciplines: Radar Principles, Timing Coding/Decoding, Formatting, Data Transfer and Control Logic, including Worst Case Analysis.

If you have the credentials and the desire for change, you can take your position with the winners at the top. Stay ahead of it. Send your resume in strictest confidence to LRK Associates, 6845 Elm Street (EL-02), McLean, Virginia 22101.

We represent an equal opportunity employer.

U.S. Citizenship required.

LRK
ASSOCIATES

POSITION VACANT

Radio Electrical Engineer—Our client company, a New England based manufacturer of industrial machinery is seeking a well-rounded Electrical Engineer with experience in the following areas: vacuum tube design for broadcast frequency (medium to high); power supply circuit design; high frequency generators in power ranges to 100KW; power oscillating circuit experience; knowledge of transformers (design and specifications); background in industrial use of high frequency applications is essential. The qualified candidate will possess a BSEE and 5-7 years experience in the stipulated areas. Compensation for the position will be commensurate with the level of experience presented. Interested candidates are asked to forward a detailed resume including salary history to: Michael Ingoldsbey, Executive & Technical Recruiting, 230 Gardner Street, Hingham, Mass. 02043. 749-4080.

POSITIONS VACANT

Electronic Specialist to maintain, repair and operate magnetic resonance instrumentation. Requirements: strong electronic background with theoretical and practical knowledge of transmitting and receiving circuitry, good knowledge of computer theory and operations. Experience in NMR operations and a chemistry-oriented educational background desirable. Send resume with salary history and references to Dr. John Funkhouser, Chemistry Department, Michigan State University, East Lansing, MI 48824. An Equal Opportunity/Affirmative Action Employer.

Electronics Engineers—All Disciplines, Microwave, Analog, Digital, Circuitry, Instrumentation and Controls, openings nationwide for design, applications and sales. \$14-40K. Fee Paid. Write, in confidence, to Mr. C. Robin, P.E., Dunhill Tech Search, 182 Forbes Road, Braintree, MA 02184, 617-848-6320.

POSITIONS VACANT

Electronics Professor. Electronic theory and application teaching position. MS required. Industrial experience desired. Write Dr. Wendell L. Swanson, Chairman, Dept. of Ind. Tech., Western Illinois University, Macomb, Ill. 61455. An Equal Opportunity and Affirmative Action Employer.

EMPLOYMENT SERVICE

Job Hunters Guide & Directory of 600 Firms. Details on job sources, resumes, taxes, etc. \$6.00 (US) + \$5.00 P&H. Foreign—add \$2.00. Friar Books, Dept. EL, 8956 E. Ardenale, San Gabriel, CA 91775.

POSITIONS WANTED

Engineering Technician with 10 years hands-on experience in analog, digital, rf, prototype design or assembly and troubleshooting. PW-4088, Electronics.

Non-Impact Printer Specialists

Join in an exciting new thrust into advanced technology!

Computer peripherals, the nation's leading band-printer manufacturer, is engaged in advanced development programs which are extending the state-of-the-art in non-impact printers. Our vigorous growth has created immediate opportunities in our Ink Jet and Electrophotographic programs for Program Managers, Project Engineers, and design and development specialists in a variety of disciplines. An advanced degree in engineering or physics or a Bachelor's degree with equivalent advanced experience is required, plus the creative ability to develop new directions in non-impact printer technology. Talk with us about growth, and unparalleled creative latitude. Your resume and salary requirement will be reviewed in confidence. Please write Mr. Bob Brown,

Computer Peripherals, Incorporated

1480 N. Rochester Rd. E-2
Rochester, Michigan 48063
1-313-651-8810

Affirmative Action Employer M/F



ELECTRICAL & ELECTRONIC DESIGN ENGINEERS

As Midwest's exclusive recruiter for Electronic and Electrical Engineers, our client companies have continual needs for growth oriented engineers.

Client Companies Pay All Fees

- BSEE, Integrated Circuit Design, CMOS \$18-20,000
 - BSEE, Induction AC Motor Design, 1500 HP+ \$22,000
 - BSEE, Sr. Design & Development of DC Devices \$18-21,000
 - BSEE, Universal Motor Design \$20,000
 - BSEE, Director of Engineer, AC Motors \$35-40,000
 - BSEE, DC Servo Drive Design \$18-22,000
- Call or send resume to LEN TERESINSKI, ELECTRICAL SPECIALIST in confidence. Office (414) 437-4353. Home (414) 494-4674.

MANAGEMENT RECRUITERS

Suite 302, 115 S. Jefferson St.
Green Bay, Wisconsin 54301
Licensed Employment Agent

We have been placing graduate ENGINEERS

in FEE-PAID positions THROUGHOUT THE U.S. since '59. Over 1,000 client companies. We are graduate engineers working full-time for you. Send resume & salary history today or request confidential application.
ATOMIC PERSONNEL, INC.
Suite L, 1518 Walnut St., Phila., Pa. 19102
An Employment Agency For All Technical Fields

POSITION WANTED

Electronic Technical/Engineering Aide—8 years experience radars and CPU's. 4 years weapons system design. 12-15K. Interested in relocation. PW-3760, Electronics.

Electronics/February 3, 1977

Senior Specialist Electronic Technician, be in charge of your career in Saudi Arabia.

Aramco needs a very good Senior Specialist Electronic Technician in Saudi Arabia.

Opportunity.

The majority of your time will be spent supervising a crew of 2 to 6 technicians in performing the operation, construction, maintenance, and repair work on all the electronic equipment in our communications network. You'll make essential electrical measurements to analyze and locate equipment faults, and the necessary repairs. You'll also supervise routine maintenance.

Qualifications.

A high school education plus 3 years technical school training in specialized communications equipment, 10 years work experience in the maintenance and repair of communications and electronic equipment (3 of which must have been on Aramco-type systems), plus experience in giving on-the-job training, and knowledge of human relations techniques.

Good company.

Aramco is one of the biggest oil companies, and has been operating since 1933. So we know our way around the petroleum industry.

Good money, plenty of travel time.

Working with Aramco in Saudi Arabia has many pluses. You receive top salary. An attractive savings plan. And a generous tax-free expatriate premium.

You also get a liberal paid vacation after only one year, so you can travel all over the world. Plus paid, round trip vacation travel to the U.S. once a year.

In addition, Aramco offers a liberal medical and retirement plan. Excellent benefit program and recreational facilities.

Interested?

If so, and you're qualified, write for an application. We'll get back in touch with you as soon as possible.

For an application, write Dept. EM0210A

ARAMCO SERVICES COMPANY

1100 Milam Building/Houston, Texas 77002

ENGINEERS \$16-30K

UNADVERTISED POSITIONS NATIONWIDE

- Analog. Digital. Microprocessors. Hardware/Software
- Computers. Peripherals. Instruments. Processes.
- Guidance. Control. Radar. Intelligence. EW.
- Communications. R.F. Microwave. Satellites

+Systems—Circuits— Components+

Degreed Engineers with 2 or more years experience.

Send your resume, with

present salary to:

P'n B Consultants, Inc.

Box 261, Wayne, Pa. 19087

OPERATED BY AN ENGINEER WHO TALKS YOUR LANGUAGE SPECIALIZING IN THE ELECTRONICS INDUSTRY

COMPUTER DESIGN ENGINEER

Small group specializing in advanced highspeed TTL AND ECL hardware needs a creative logic designer, who enjoys difficult problems to participate in the development of complex processors. Substantial digital design experience is required.

SYSTEMS CONCEPTS, INC.

520 Third St.
San Francisco, CA 94107

An Equal Opportunity Employer

PROJECT ENGRS.

Our client, a well established R & D firm in the greater Boston area, offers challenge and advancement to two design engrs. capable of leading the design/development of state of the art instrument and control hardware. Requires BSEE, 5 yrs. exp., and a solid background in digital OR analog circuit/system design techniques. Exp. with microprocessors a plus. Sal. to 25K. Contact Dave Adams, New England Recruiters, 6 Lakeside Office Park, Wakefield, MA 01880.

Fee paid consultants

Computer

SENIOR ELECTRONIC ENGINEER

Sycor, Inc., a dynamic young company, a leading manufacturer of intelligent terminals and one of the fastest growing companies in the computer industry, is seeking an experienced Senior Electronic Engineer. You'll need a minimum of 5 years' background in mini/microcomputer design with strong experience in architecture, design, development and debugging of micro/mini's; plus design memory architecture in bubble memory. Bipolar MOS technology knowledge with 4 bit slice experience is a plus.

We are looking for a computer technologist who is interested in getting things done. A software background would be a valuable addition. BSEE is required, MS preferred.

Please send your resume with salary history to:

Copi R. Jindal, PhD.

Manager, Professional Employment
Sycor, Inc., 100 Phoenix Drive
Ann Arbor, Michigan 48104
(313) 995-1156

As an Equal Opportunity and Affirmative Action Employer
Sycor, Inc., Urges Females and Members of
Minority Groups to Apply

Sycor, Inc.

An Intelligent Idea

POSITIONS WANTED

Experienced Product Innovator and Engineering Administrator—Fifteen patents, several successful products and various publications. Admin. experience includes OD, product planning, resource allocation, etc. Searching for rapid growth or turn-around situation. Objective is to make meaningful contribution to significant technical programs. Ideally to participate in "State of the Art" advances in controls, instrumentation, or EDP technologies. PW-4051, Electronics.

Finally.

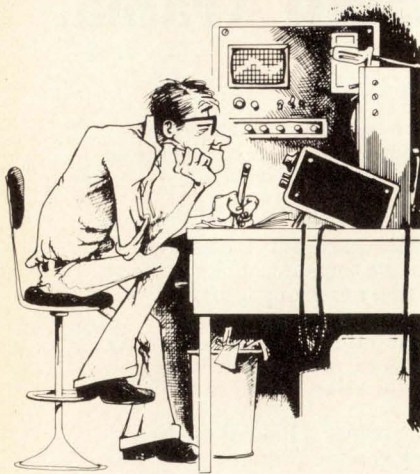

A low-cost, predictable, dual-channel filter.

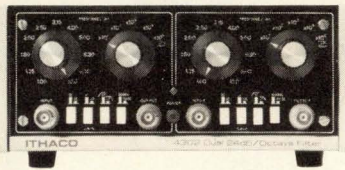

Each of the two 24dB/octave filters can be used as high pass or low pass with selectable gain of 1 or 10. Connect them in series for bandpass, 48dB/octave high pass, 48dB/octave low pass, with selective gain of 1, 10 or 100. Butterworth and Bessel modes. Switch selectable frequency settings from 10Hz to 1MHz, .005% distortion at 20 volts output. 100dB outband rejection. 25 μ volts noise.

Send for our data sheet.

It'll tell you all you need to know about our newest filter. And when you need a filter that does just what you expect, you'll know where to find it. The predictable filter.™ \$655. Ithaco, Box 818, Ithaca, New York 14850. Call (607) 272-7640.

ITHACO

© Ithaco, Inc.

Electronics advertisers

February 3, 1977

Adret Electronique	131	Deltron	165
Advanced Micro Devices	10-11	■ Dialight Corporation	151
Alco Electronics Products Inc.	149	Digital Equipment Corporation (OEM)	128
Allen Bradley Company	34	DIT-MCO	31
American Optical Scientific Instrument Division	3rd cover	Electrol	159
■ AMP Incorporated	90	Electronic Navigation Industries	138
Amperex Electronics Corporation	83	■ Ferranti Packard	6
Amphenol Connectors Division Bunker Ramo Corporation	76	Figaro Engineering Inc.	171
Analog Devices Inc.	2	Fluke Manufacturing Co., John	13, 15, 161
APM Hexseal	144	‡ Fujitsu Limited	56, 126-127
* Beckman Instruments Ltd.	55 7E	General Automation	88-89
‡ Beckman Instruments Inc. Information Displays Operations	60-61	General Instrument Corporation, Microelectronics Division	38-39
‡ B & K Precision Division Dynascan Corporation	124-125	Grayhill Inc.	84
■ Bourns Inc.	4th cover	■ Hewlett-Packard	2nd cover, 17-24
* Burr Brown Research Inc.	125	■ Hughes Aircraft Company	52-53
Bussman Mfg. Division of McGraw Edison Co.	49	Hydelco	145
Cermaseal	173	Lasas	40, 41
■ Cherry Electrical Products Inc.	1	Intel-Microcomputer Components	32-33
Coil-Ler Mfg Inc.	155	* Italtel/SIT	5E, 9E
Computer Automation	68-69	■ Ithaco, Inc.	170
Continental Rentals	8	■ Johanson Manufacturing Corporation	30
Control Data Corp	51	Kedman Company	171
Corning Glass Works Fotoform/Fotocerem Div.	134-135	Keithley Instruments	74-75
CPS-Converter Products	85	Kennedy Company	146
■ Custom Electronics Inc.	130	Krohn Hite Corporation	5
Dana Laboratories	160	Kulka Electric Corp, Div. North Amer. Philips	171
Datatron/MTL	137	Macrodyne	123
Deltec	141	Magnetics Components Group, Control Data Corp.	140
		‡ Marconi Instruments	146

* ■ Marconi Instruments Ltd.	64	* S.E. Labs. (EMI) Ltd.	62
MCL Inc.	162	* Sfernice	135
Miller Stephenson Chemical Inc.	37	Sheldon-Sodeco Div. Landis & Gyr, Inc.	64
* Molex (International) Incorporated	174	Signetics Corporation Division of U.S. Philips	140, 141, 143, 145, 147 149 150, 151, 152-153
Mostek Corp.	28-29	Spectrol Electronics Corp.	148
‡ NEC America, Inc., Electron Devices Div.	154	Sprague Electric Company	59
‡ Nec Microcomputer Inc.	55	S.R.D. Corp.	165
The J.M. Ney Company	16	Systron Donner Concord Instrument	159
Newport Labs.	158	Tecnetics	156
Optron, Inc.	14	■ Tektronix Inc.	72-73, 47
* Oscilloquartz	83	Texas Instruments Incorporated Components Div.	70-71
Philips ELA	132	* Trio Kenwood Corp.	128
* Philips Test & Measuring Instruments	60-61	Ultra-Violet Products, Inc.	147
■ Powermate	172	United Systems Corp. a Sub of Monsanto Co.	42
Precision Monolithic Inc.	9	Velonix	157
Princeton Electronic Products	54	V/O Technabexport	136
Process Computer Systems, Inc.	27	‡ Wabash Electronics	62
Projects Unlimited Inc.	85	Weckesser Company	143
* Racal Thermionic Ltd.	142	S.S. White	150
RCA Solid State Division	7	Zero Corporation	139
Reticon Corporation	87		
Robinson Nugent Inc.	142		
Rockland Systems	163		
* Rohde & Schwarz	1E		
Rolm Corporation	81		
Sangamo Data Recorder	120		
Scanbe Mfg. Corp.	67		
Scientific Atlanta Optima Division	157		
* SDSA	11E		

Classified and employment advertising
F. J. Eberle, Manager 212-997-2557

Aramco Services Co.168	169
Computer Peripherals Inc.	167
General Dynamics	167
Honeywell	166
LRK	168
Management Recruiters	168
New England Recruiters	169
P n' B Consultants	169
Rochester, Univ of	166
Sycor Inc.	169
Systems Concepts	169

■ For more information of complete product line see advertisement in the latest Electronics Buyers Guide
* Advertisers in Electronics International
‡ Advertisers in Electronics domestic edition

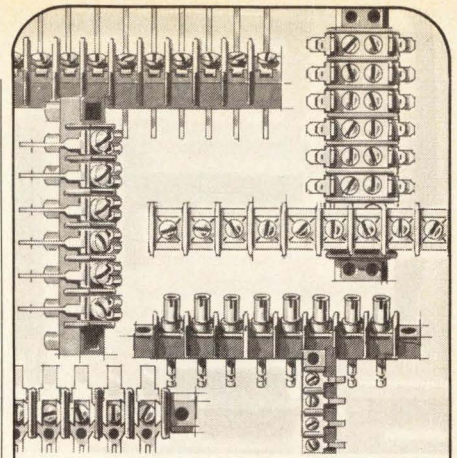

MORE Surface Terminations

You can pick the exact terminations you need. Screw, wire clamps, wire wrap, lugs, Kliptites™, and even a guillotine screw are all shown in our new catalog. With this kind of choice, there is no need to compromise.

Kulka

A NORTH AMERICAN PHILIPS COMPANY

520 S. Fulton Ave., Mt. Vernon, NY 10551

Circle 208 on reader service card

Use Quick-Wedge to install a bus, connect a motor, mount a p.c. board, cinch up a connector

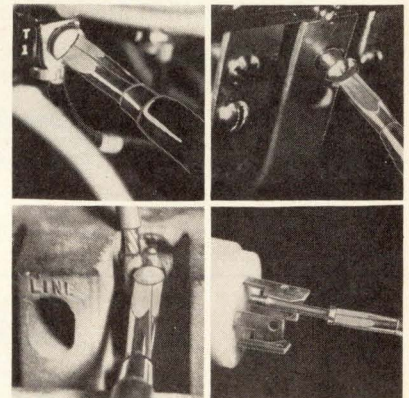

They do all that ordinary screwdrivers do, PLUS they hold and start the screw



QUICK-WEDGE 17 sizes

Screw-holding screwdrivers

Unconditionally guaranteed.

BUY A SET TODAY

See your dealer or write to:

Kedman Company, P.O. Box 25667,
Salt Lake City, Utah 84125

New S-D Communication Counters

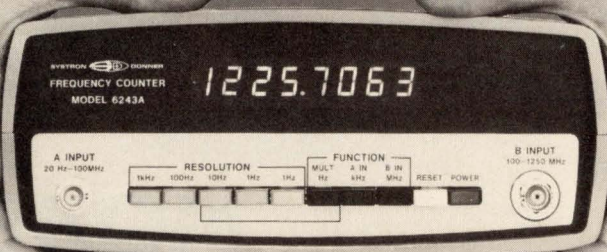

Automatically measure up to 4,500 MHz!

Four new S-D Communications Counters offer the latest technical advances in high speed, precision frequency measurement. They are small and light, but they pack enormous capability.

- **Ranges:** 100 MHz, 512 MHz, 1250 MHz, and 4500 MHz.
- **Sensitivity:** 10mV RMS (Models 6241A, 6242A, 6243A). Model 6244A: 10mV RMS to 500 MHz, -13 dBm above 500 MHz.
- **Overload protection:** Withstands high input signal levels without damage.
- **Display:** 8 LED digits, 0.1 Hz resolution.
- **Tone measurement (opt.):** Example: measure 1020.01 Hz automatically in 1 sec.
- **Meet the whole family:**

100 MHz Model 6241A—\$ 595
512 MHz Model 6242A—\$ 795
1250 MHz Model 6243A—\$ 995
4500 MHz Model 6244A—\$2150

For sales assistance, contact Scientific Devices or Systron-Donner at 10 Systron Drive, Concord, California 94518. Phone (415) 676-5000.

SYSTRON  **DONNER**

Circle 172 on reader service card

CAREER OPPORTUNITIES

Usually the best opportunity to grow in your field lies within your present company. You have made an investment in them. They have an investment in you.

But occasionally the best opportunity lies somewhere else. No one can decide but you.

Companies looking for good people run their recruitment ads in our Classified Section in the back of this magazine. Perhaps you'll find an opportunity there that's worth following up.

Advertising Sales Staff

Advertising sales manager: Paul W. Reiss
1221 Avenue of the Americas, New York, N.Y. 10020
[212] 997-9372

Atlanta, Ga. 30309: Glen N. Dougherty
100 Colony Square, 1175 Peachtree St., N.E.
[404] 892-2868

Boston, Mass. 02116: Frank Mitchell
607 Boylston St.
[617] 262-1160

Chicago, Ill. 60611
645 North Michigan Avenue
Robert W. Bartlett (312) 751-3739
Robert M. Denmead (312) 751-3738

Cleveland, Ohio 44113: William J. Boyle
[716] 586-5040

Dallas, Texas 75201
2001 Bryant Tower, Suite 1070
[214] 742-1747

Denver, Colo. 80203: Harry B. Doyle, Jr.
123 Speer Blvd. #400
[303] 837-1010

Detroit, Michigan 48202: Robert W. Bartlett
1400 Fisher Bldg.
[313] 873-7410

Houston, Texas 77002
601 Jefferson Street, Dresser Tower
[713] CA 4-8381

Los Angeles, Calif. 90010: Robert J. Rielly
Bradley K. Jones, 3200 Wilshire Blvd., South Tower
[213] 487-1160

New York, N.Y. 10020
1221 Avenue of the Americas
Michael J. Stoller
[212] 997-3616

Philadelphia, Pa. 19102
Three Parkway
[212] 997-3617

Pittsburgh, Pa. 15222
4 Gateway Center
[212] 997-3617

Rochester, N.Y. 14534: William J. Boyle
1175 Pittsford-Victor Rd., Pittsford, N.Y.
[716] 586-5040

San Francisco, Calif. 94111: Don Farris
Robert J. Rielly, 425 Battery Street,
[415] 362-4600

Paris: Alain Offergeld
17 Rue-Georges Bizet, 75116 Paris, France
Tel: 720-73-01

Geneva: Alain Offergeld
1 rue du Temple, Geneva, Switzerland
Tel: 32-35-63

United Kingdom & Scandinavia: Robert Ghey
34 Dover Street, London W1
Tel: 01-493-1451

Scandinavia: Andrew Karnig and Assoc.
Kungsholmsgatan 10
112 27 Stockholm, Sweden
Tel: 08 51 68 70 Telex: 179 51

Milan: Luigi Rancati
1 via Baracchini, Italy
Phone 86-90-656

Brussels: Alain Offergeld
23 Chaussee de Wavre
Brussels 1040, Belgium
Tel: 13-73-95

Frankfurt / Main: Fritz Krusebecker
Liebigstrasse 27c, Germany
Phone 72 01 81

Tokyo: Tatsumi Katagiri, McGraw-Hill
Publications Overseas Corporation,
Kasumigaseki Building 2-5, 3-chome,
Kasumigaseki, Chiyoda-Ku, Tokyo, Japan
[581] 9811

Australasia: Warren E. Ball
IPO Box 5106, Tokyo, Japan

Business Department

Thomas M. Egan,
Production Manager [212] 997-3140

Gayla Black
Production Manager [212] 997-2044

Carol Gallagher
Production Manager International
[212] 997-2045

Dorothy Carter
Production Manager Domestic
[212] 997-2908

Frances Vallone
Reader Service Manager
[212] 997-6057

Electronics Buyers' Guide

H.T. Howland, General Manager
[212] 997-6642

Regina Hera, Directory Manager
[212] 997-2544

Gayla Black, Production Manager
[212] 997-2044

Classified and Employment Advertising

Frank Eberle, Manager
[212] 997-2557

PORCELAIN BUSHINGS

by CERAMASEAL

- SOLDERABLE OR WELDABLE to your tanks or covers
- ALL-STAINLESS, NON-MAGNETIC HARDWARE
- MEET MIL-C-25 AND MIL-T-27
- MECHANICALLY RUGGED
- HIGH-TEMPERATURE, VACUUM-TIGHT BONDS

High melting point of porcelain-metal bonds (above 320 C) eliminates bond softening during installation and provides trouble-free operation.

Send for our illustrated Bulletin 362 P, covering standard units in stock to 115 kv (rms).

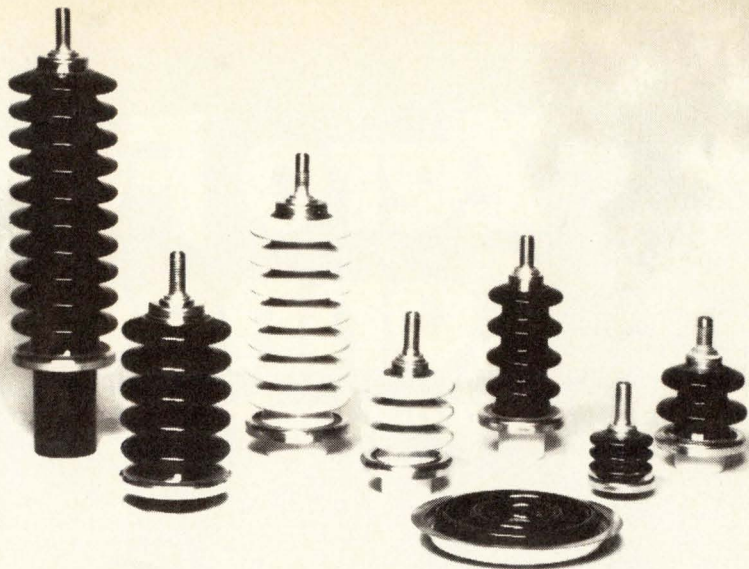

Consult Ceramaseal regarding availability of sky grey (ASA 70) or chocolate brown insulators.

SEE US AT AUS SHOW — BOOTH 54

Ceramaseal, Inc.

A SUBSIDIARY OF **INTERPACE** CORPORATION

NEW LEBANON CENTER, NEW YORK 12126 • 518-794-7800 • TELEX 145442

Circle 173 on reader service card

Gas Sensing Semiconductor

FIGARO TGS GAS SENSOR

quickly senses even small amount of gas.

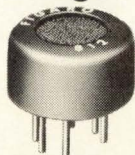
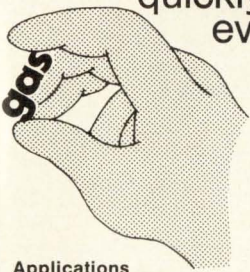

Applications

1. Natural Gas-Leak Alarm
2. Propane Gas-Leak Alarm
3. Carbon Monoxide Detector
4. Automatic Fan Control
5. Fire Alarm (Detecting combustible gases contained in smoke)
6. Alcohol Detector (Detector for drunken driver)
7. Air Pollution Monitor

Please contact any of the addresses below directly for catalogs and price/delivery information.

FIGARO ENGINEERING INC.

● Head Office: 3-7-3 Higashitoyonaka, Toyonaka City, Osaka, 560, JAPAN TELEX: 05286155 FIGARO J CABLE: FIGARO TOYONAKA TEL: (06) 849-2156

● North America: 3303 Harbor Boulevard, Suite D-8, Costa Mesa, California 92626, U.S.A. TELEX: 678396 CABLE: FIGARENGIN COSTAMESA TEL: (714) 751-4103

The Answer Book. It makes your job easier. \$25.

“What companies make the products I need? How do I contact them locally? How do I get their current catalogs fast?”

Ask The Answer Book. Over 4000 products, 6000 manufacturers with their local contacts, directory of trade names and catalogs, inquiry “bingo” card for 5-second ordering of current catalogs.

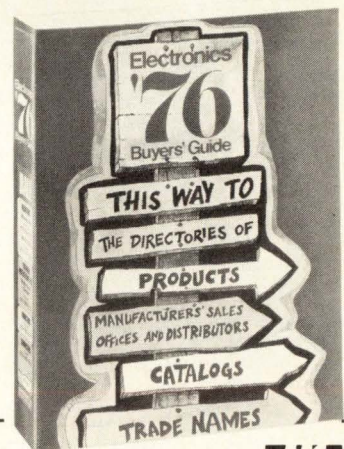

Electronics Buyers' Guide

1221 Avenue of the Americas, N.Y., N.Y. 10020

Yes, send me a copy of The Answer Book.

I've enclosed \$25 (USA and Canada only,

elsewhere send \$35). Full money back guarantee if returned within 10 days.

Name _____

Company _____

Street _____

City _____

State _____

Zip _____



Circle 207 on reader service card

173

Zero Force Connection

introducing the MOLEX Zifcon™



Introducing the Molex ZIFCON/zero force connector ... a new concept in cable to cable connector applications.

The design and operation of this zero insertion force connector is simple, economical and reliable. When the plug is mated with the receptacle, there is a gap between the terminals and no contact is made. As the actuating cams are closed, contact is made between the terminals and the two housings are positively locked together.

ZIFCON is especially desirable in requirements where space is limited and the serviceman must disconnect the connector in order to service the device. The connector can be mated or unmated with one hand.

ZIFCON features a high mechanical mating cycle life and a reliable positive lock between plug and receptacle. The 94V-O polyester housings are polarized. The connector comes in 16, 24 and 36 circuit sizes. This product line meets U.L. and C.S.A. specifications and conforms to V.D.E. spacing requirements.

This new concept is the result of a value engineered product design that realizes economics without sacrificing reliability. For more information, please contact *Molex Incorporated, 2222 Wellington Court, Lisle, Illinois 60532* or call (312) 969-4550.

 **molex**® ... Affordable Technology

Circle 174 on readerservice card