

SEPTEMBER 16, 1976

**ENGINEERING MANPOWER FORECASTS: ARE THEY BASED ON REALITY?/75**

On-chip heater stabilizes integrated zener reference/ 106

Applying system design rules to fiber-optic communications/ 113

FOUR DOLLARS A McGRAW-HILL PUBLICATION

# Electronics®

STATE TECHNICAL INST  
FREEMAN LIBRARY 017823  
5903 MACON COVE  
MEMPHIS TN

38134

LIBRARY  
STATE TECHNICAL INSTITUTE  
AT MEMPHIS

**MASTER-SLAVE PROCESSORS  
LIBERATE DESIGNERS**

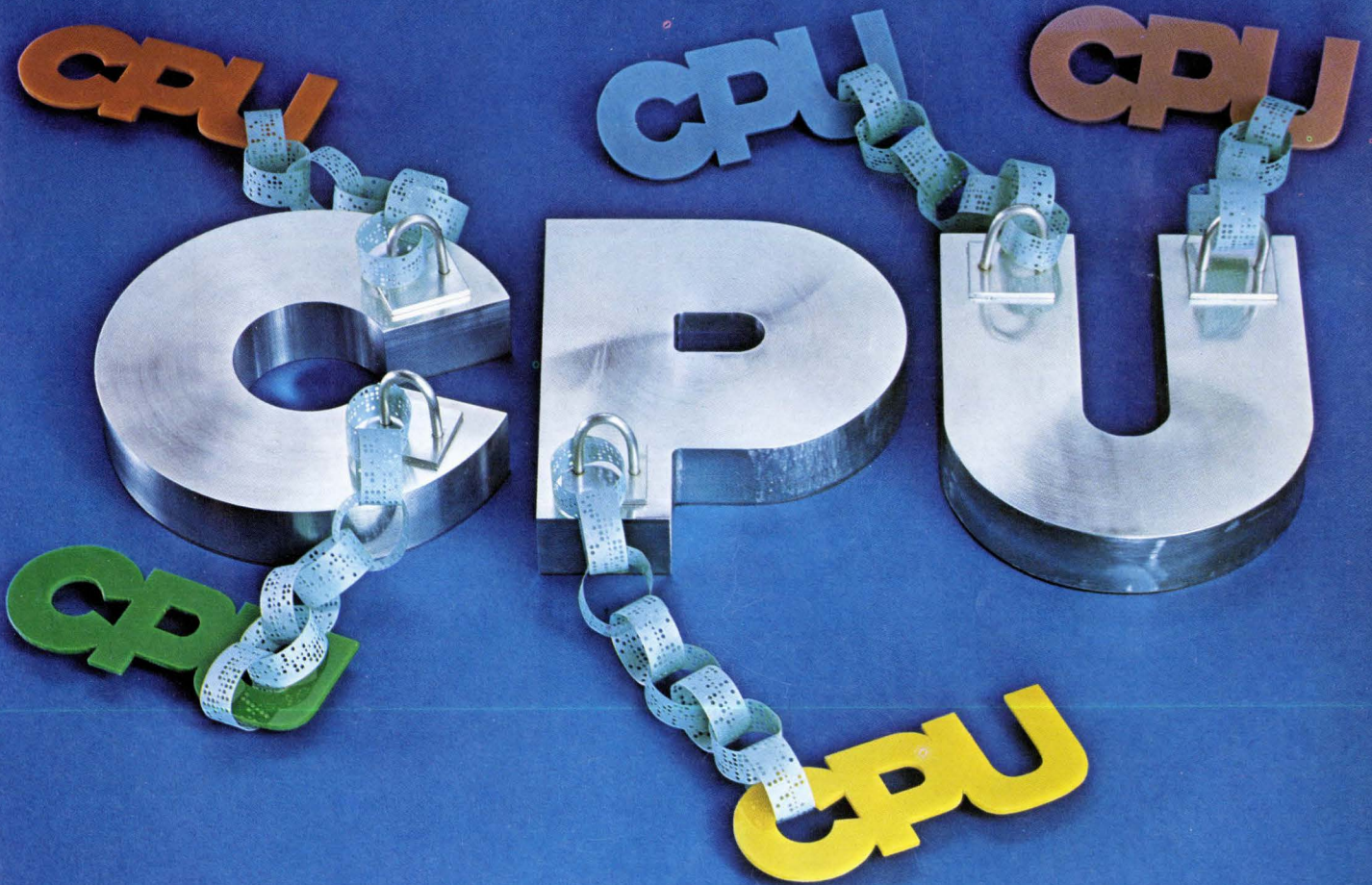



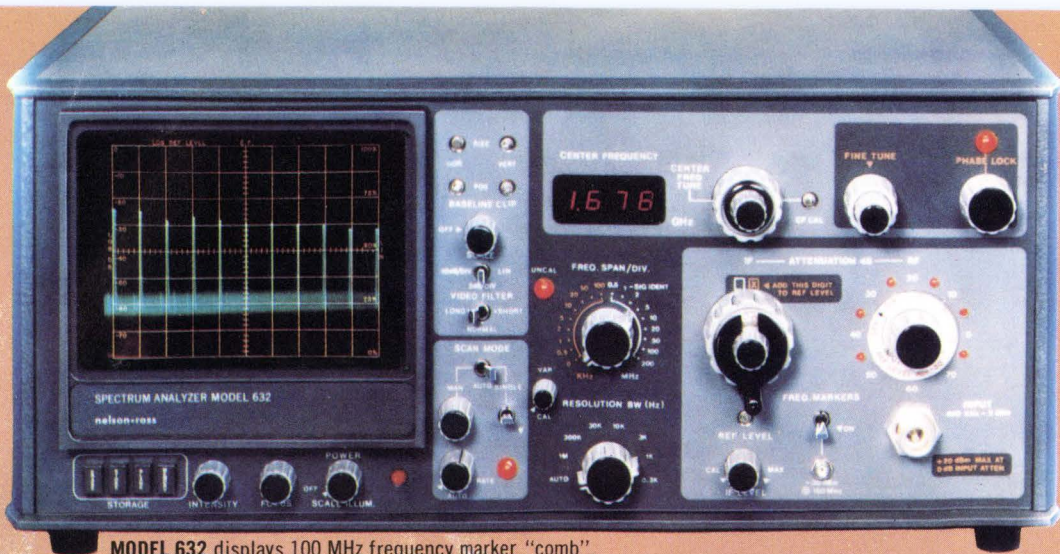

MODEL 632 displays 100 MHz frequency marker "comb".

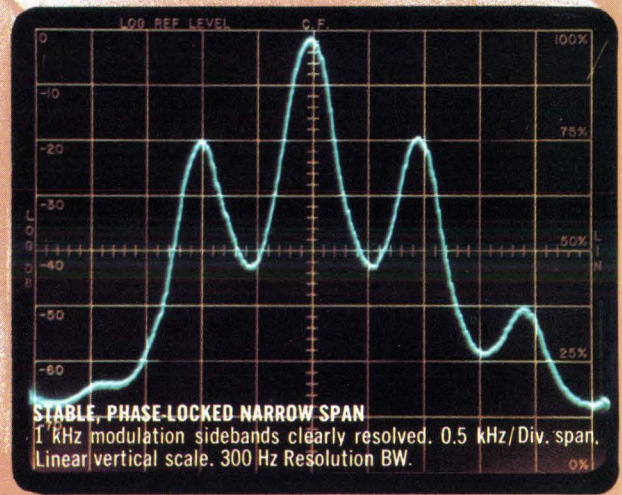
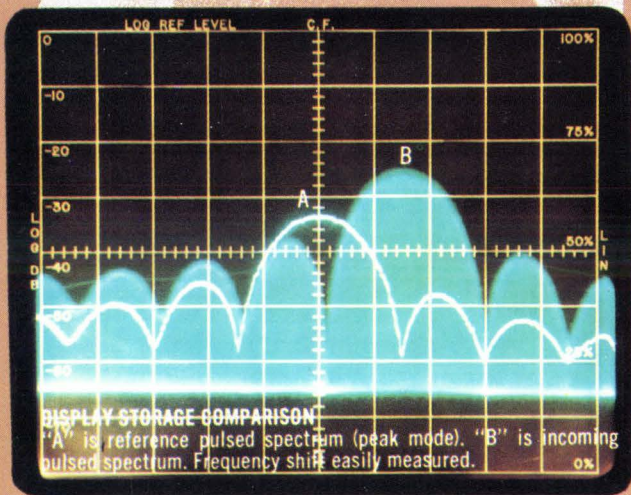

## Look Closely at this New Series of RF-Microwave Spectrum Analyzers.

The New NR 600 Series: 500kHz to 40 GHz. All the important features you need. Compact size. Low cost. Directly calibrated, wide-dynamic-range, spectrum displays up to 40 GHz.

Select among five versatile easy-to-use models.

### Check these features —

- 4 Digit LED Frequency Readout.
- Absolute level calibrations up to 18 GHz.
- Calibrated frequency spans up to 2 GHz; up to 8 GHz full spans with Models 640 & 641.
- Jitter-free phase-locked narrow spans with 300 Hz Resolution.
- High useful sensitivity to  $-115$  dbm, (632). To  $-108$  dbm for other Models. Conservatively rated at  $S + N = 2N$  and 1 kHz Resolution BW.
- Internal tracking preselector to 18 GHz. Models 640 & 641.
- 70 db log scale (10 db/div) plus 2 db/div and linear level scales.
- Bright, calibrated 8 x 10 cm display. Parallax-free internal graticule CRT plus scale illumination. Standard camera mount.
- Display Storage (Optional). Internal memory provides long term display storage and recall. (Stored displays can be compared to incoming signals.)
- Interface for Tracking Generator (Optional)
- Reliable modular solid state design.
- Compact construction —  
 Models 630, 631, & 632 are 7" high;  
 Models 640 & 641 (with Internal Preselector) are 8 $\frac{3}{4}$ " high.

New N-R 600 Series		USA Domestic Prices
Models		
632	<500 KHz to 2GHz	\$ 5,975
630	10 MHz to 40 GHz 7 Bands	\$ 7,750
640	630 plus Internal Preselector	\$10,150
631	10 MHz to 40 GHz 6 Bands	\$ 7,150
641	631 plus Internal Preselector	\$ 9,500

Circle 900 on reader service card

Get a **Closer Look** by checking the Reader Service Card — or — for immediate response, call, TWX or write to:

**polarad** nelson • ross DIVISION

5 Delaware Drive / Lake Success, New York 11040 / 516-328-1100 TWX 510-223-0414





# Designing broad band transformers?

Here  
comes  
help

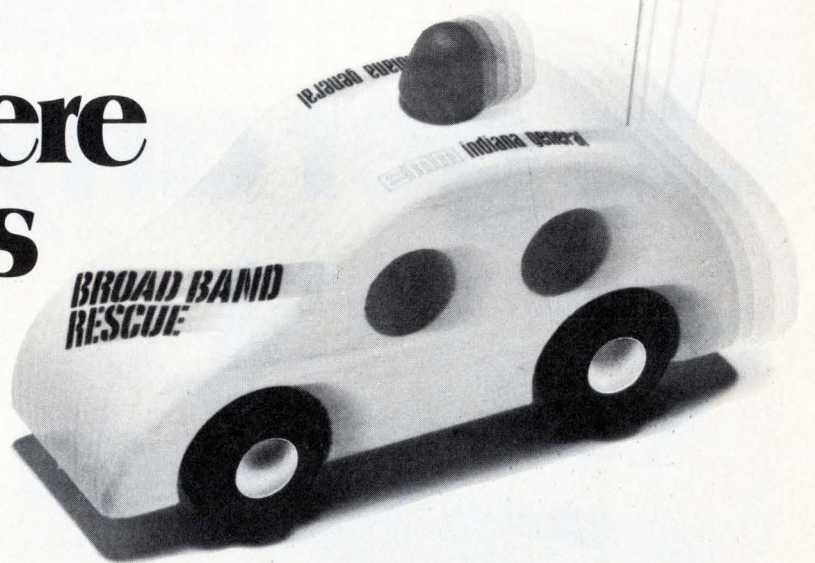

**DESIGN DIRECTION** — Tell us your application for broad band components. We'll send you complete design information on the only ferrites manufactured, tested and guaranteed for bandwidth performance. Your design will be easier and more precise with graphs of  $R_p$  and  $X_p$  vs. frequency and design examples that work.

**COMPONENT SELECTION** — Give us your circuit parameters and we will select a Broad Band-Rated<sup>®</sup> component with 16,000 perm to replace expensive metal laminations. Or give us your bandwidth requirements from 100 Hz to beyond 250 MHz and we'll choose from our complete range of toroids and mated parts in recommending a specific solution.

Call **APPLICATIONS ENGINEERING**, (201) 826-5100 or write: Indiana General, Keasbey, New Jersey 08832.

RESCUE VEHICLE — CREATIVE PLAYTHINGS

**ENM** indiana general  
a division of Electronic Memories & Magnetics Corp.  
Keasbey, N.J. 08832 • (201) 826-5100



# "You can't buy a 132-column printer for any less.

# Or, get any more."

Bob Howard, President, Centronics



But the low initial  
price for the Centronics 700 Series  
132-column printer isn't the whole story.

It's the lower cost of ownership based on the 700's  
inherent reliability and simplified construction.

The 700's unique modular construction using four different modules — printing, electronics, forms handling and keyboard — and less moving parts mean easier maintenance, lower cost and a smaller spares inventory.

Write for the full details of this tremendous offer . . . and information on the rest of the printers and teleprinters in the new Centronics 700 Series.

**Centronics means more than low price.**

And more than hardware. It's the widest range of models, features, options  
• Financially strong • Proven delivery response • Over 70,000 printers installed • 109 world-wide sales/service locations • Stringent quality control • Advanced R&D and manufacturing • Long-term spare parts availability • Customizing for specific needs.

## **CENTRONICS® IS PRINTERS**

Centronics Data Computer Corp., Hudson, N.H. 03051, Tel. (603) 883-0111, Twx. 710-228-6505, Tlx. 94-3404; Eastern Region: (617) 272-8545 (MA); Central Region: (513) 294-0070, Twx. 810-459-1784 (OH); Western Region: (714) 979-6650, Twx. 910-595-1925 (CA) Centronics Data Computer (Canada) Ltd., Ontario, Tel. (603) 883-0111, Twx. 710-228-6505; Centronics Data Computer (UK) Ltd., Cheam, Surrey, England, Tel. 643 0821-4, Tlx. 851 945756; Centronics Data Computer, GmbH, 6 Frankfurt/Main., West Germany, Tel. 663321/22, Tlx. 841 413224; Centronics of Puerto Rico, Dorado, Puerto Rico, Tel. (809) 796-1881, Tlx. 3859349



## 39 Electronics Review

MEDICAL: Matrix of voltages on skin enable blind to 'see', 39  
MEMORY: General Instrument introduces 8,192-bit Earom . . . , 40  
. . . as Nippon Electric readies its design, 41  
Mostek 16,384-bit ROM has 350-nanosecond access time, 42  
INDUSTRIAL: Computer numerical control looking good again, 44  
Microprocessors show up in numerical controllers, 44  
NEWS BRIEFS: 46  
COMPANIES: Intel plans broad LSI product push, 48  
PACKAGING & PRODUCTION: Lasers strip wire insulation, 50  
MICROPROCESSORS: Rockwell adds two-chip PPS-8, 52

## 63 Electronics International

GREAT BRITAIN: Geometry separates microwave channels in filter, 63  
AROUND THE WORLD: 63

## 75 Probing the News

YOU AND YOUR CAREER: Are manpower predictions accurate? 75  
COMPONENTS: Power FETs threaten bipolar transistors, 80  
INDUSTRIAL: Technology makes water fit for drinking, 86  
ELECTRONICS ABROAD: Bombay takes on electronic glow, 89

## 91 Technical Articles

COMPUTERS: Master-slave processors help develop systems, 91  
INSTRUMENTS: Microprocessor multiplies DMM's functions, 97  
DESIGNER'S CASEBOOK: D cells power nanosecond-pulse generator, 102  
Comparators and resistors form clockless a-d converter, 103  
Voltage doublers power microprocessor PROMs, 105  
COMPONENTS: On-chip heater helps stabilize reference zener, 106  
COMMUNICATIONS: Design rules for fiber optics are familiar, 113  
ENGINEER'S NOTEBOOK: DVM locates short circuits on pc boards, 118  
Induction pickup drives elapsed-time indicators, 119  
Frequency-counter design minimizes number of parts, 121

## 125 New Products

IN THE SPOTLIGHT: Thin-film networks take on discretes, 125  
Digital multimeters emphasize accuracy, 131  
Crydom enters low-cost solid-state-relay market, 134  
MICROPROCESSORS: Product-line gaps filled, 137  
SEMICONDUCTORS: Quad op amp has on-chip input FETs, 146  
COMPONENTS: Ferrites made more stable, 152  
PACKAGING & PRODUCTION: Furnace handles crystals to 5 in., 158  
COMMUNICATIONS: Synthesizer aims at CB market, 162

## Departments

Publisher's letter, 4  
Readers' comments, 6  
News update, 8  
Editorial, 10  
People, 12  
Meetings, 30  
Electronics newsletter, 35  
Washington newsletter, 59  
International newsletter, 65  
Engineer's newsletter, 122  
New literature, 165

## Highlights

### Cover: Dual processors divide design tasks, 91

A development system for the design of microprocessor-based prototypes aims at universality by assigning system-related tasks to a master central processing unit, while prototype-related jobs are handled by a replaceable slave unit that duplicates the prototype's processor.

Cover constructed by Robert Strimban.

### Manpower studies blasted, 75

Official manpower studies continue to show more jobs than there are engineers, and they're coming under increasing fire for not reflecting reality. Critics single out the Engineering Manpower Commission for failure to correct its figures.

### Heater on the chip steadies reference zener, 106

A new monolithic zener diode has a temperature-stabilizer network separate from the zener itself, so that avalanche is minimized and long-term stability assured.

### Familiar rules apply to fiber-optic designs, 113

Although the increased bandwidth possible with fiber-optic systems means different tradeoffs in determining optimum transmission formats, the link analysis is carried out in much the same way as for an electrical cable.

### And in the next issue . . .

A roundup of technological advances in the new season's television sets . . . an example of designing with a bipolar, bit-slice microprocessor . . . what component users should know about acceptance-testing procedures.



EDITOR-IN-CHIEF: Kemp Anderson

EXECUTIVE EDITOR: Samuel Weber

MANAGING EDITOR: Arthur Erikson,  
*International*

SENIOR EDITORS: Laurence Altman,  
Ray Connolly, Lawrence Curran,  
John Johnsrud, H. Thomas Maguire,  
Stephen E. Scrupski

ART DIRECTOR: Fred Sklenar

ASSOCIATE EDITORS: Howard Wolff,  
Gerald M. Walker, Alfred Rosenblatt

DEPARTMENT EDITORS  
*Aerospace/Military*: Ray Connolly  
*Circuit Design*: Don Blattner  
*Communications & Microwave*:  
Richard Gundlach  
*Components*: Lucinda Mattera  
*Computers*: Stephen E. Scrupski  
*Consumer*: Gerald M. Walker  
*Instrumentation*: Andy Santoni  
*New Products*: H. Thomas Maguire,  
Michael J. Riezenman  
*Packaging & Production*: Jerry Lyman  
*Solid State*: Laurence Altman

CHIEF COPY EDITOR: Margaret Eastman

COPY EDITORS: Everett C. Terry, Ben Mason

ART: Charles D. Ciatto, *Associate Director*  
Paula Piazza, *Assistant Director*

EDITORIAL SECRETARIES: Janet Noto,  
Penny Roberts, Marilyn B. Rosoff

FIELD EDITORS

*Boston*: Lawrence Curran (Mgr.), Pamela Leven  
*Los Angeles*: Larry Waller (Mgr.)  
*Midwest*: Larry Armstrong (Mgr.)  
*New York*: Bruce LeBoss (Mgr.)  
*San Francisco*: Bernard Cole (Mgr.)  
Judith Curtis  
*Washington*: Ray Connolly (Mgr.)  
*Frankfurt*: John Gosch  
*London*: William F. Arnold  
*Paris*: Arthur Erikson  
*Tokyo*: Charles Cohen

McGRAW-HILL WORLD NEWS

*Editor*: Michael Johnson  
*Brussels*: James Smith  
*Madrid*: Dom Curcio  
*Milan*: Andrew Heath  
*Moscow*: Peter Gall  
*Paris*: Joel Stratte-McClure  
*Stockholm*: Robert Skole  
*Tokyo*: Colin Gibson

PUBLISHER: Dan McMillan

DIRECTOR OF MARKETING: Pierre J. Braudé

MARKETING ADMINISTRATION MANAGER:  
Wallis Clarke

CIRCULATION MANAGER: Nancy L. Merritt

MARKETING SERVICES MANAGER:  
Tomlinson Howland

RESEARCH MANAGER: Margery D. Sholes

Those sophisticated handheld programable calculators obviously are having tremendous impact on the engineer's everyday working techniques. One sign of the times is this issue's Engineer's Newsletter, the popular vehicle for tips on offbeat sources of engineering information or ways of adapting devices to do things their designers never thought about. It is devoted entirely to techniques for storing and retrieving data in various registers of the SR-52 calculator. We are receiving an increasing amount of mail that is heavily weighted toward calculator tips and novel programs.

While we have published a number of calculator-related features over the years, the arrival on the scene of programable calculators has opened up some new possibilities. Already we have found ourselves with a backlog of intriguing and worthwhile calculator programs, as readers submit them for sharing with other engineers.

Therefore, we have decided to launch, starting next issue, a regular calculator forum. So, if you have worked up interesting programs or

have noteworthy operating tips, send them in so that they can be passed on to other calculator users.

Our lead-off Probing the News story this issue homes in on a fundamental question that engineering, as all professions, must face—the forces that determine the supply and demand for engineers. The one major yardstick of engineering manpower needs, the surveys conducted by the Engineering Manpower Commission, are under fire. Some critics have gone so far as to say that the EMC reports have encouraged schools to pump ever more graduates into an already oversupplied market.

The story is a complex one. You'll find the details, though, in the story that our New York bureau manager, Bruce LeBoss, has put together after extensive reporting and interviewing. And you'll find that on page 75.



### Data Communications editor wanted

Our sister publication, Data Communications, is expanding its editorial staff in anticipation going to a monthly frequency in January. There's an exciting opportunity to put practical data communications knowledge to use as Equipment and Services editor on Data Communications. While an EE degree is preferred, of prime importance is experience with the applications of data communications/data processing equipment. Good command of English required, but no editorial training necessary. If you're interested, send a résumé to Harry R. Karp, Editor-in-chief, Data Communications, 1221 Avenue of the Americas, New York, N.Y. 10020.

September 16, 1976 Volume 49, Number 19  
95,882 copies of this issue printed

Published every other Thursday by McGraw-Hill, Inc. Founder: James H. McGraw 1860-1948. Publication office 1221 Avenue of the Americas, N.Y., N.Y. 10020; second-class postage paid at New York, N.Y., and additional mailing offices.

Executive, editorial, circulation and advertising addresses: Electronics, McGraw-Hill Building, 1221 Avenue of the Americas, New York, N.Y. 10020. Telephone (212) 997-1221. Teletype 12-7960 TWX 710-581-4879. Cable address: MCGRAW HILL NEW YORK.

Subscriptions limited to professional persons with active responsibility in electronics technology. Publisher reserves the right to reject non-qualified requests. No subscriptions accepted without complete identification of subscriber name, title, or job function, company or organization, and product manufactured or services performed. Subscription rates: in the United States and possessions \$12.00 one year, \$30.00 three years; Canada and Mexico \$14.00 one year, \$32.00 three years; Europe \$35.00 one year, \$87.50 three years; Japan, Israel and Brazil \$60 per year; Australia and New Zealand \$80.00 per year, including air freight; all other countries \$40.00 per year. Limited quota of subscriptions available at higher than basic rate for persons outside of field served, as follows: U.S. and possessions and Canada \$25.00 per year; Europe \$40.00; Japan, Israel and Brazil \$85.00; all other countries \$50.00. Single copies: \$4.00. Please allow four to eight weeks for shipment.

Officers of McGraw-Hill Publications Company: Gordon L. Jones, President; Paul F. McPherson, Executive Vice President; Gene W. Simpson, Group Vice President; Senior Vice Presidents: Ralph Blackburn, Circulation; John B. Hoglund, Controller; Ralph R. Schulz, Editorial; David G. Jensen, Manufacturing; Vice Presidents: James E. Boddorf, Planning & Development; Edward E. Schirmer, Marketing Administration.

Officers of the Corporation: Harold W. McGraw, Jr., President, Chief Executive Officer, and Chairman of the Board; Robert N. Landes, Senior Vice President and Secretary; Ralph J. Webb, Treasurer.

Title registered in U.S. Patent Office; Copyright © 1976 by McGraw-Hill, Inc. All rights reserved. The contents of this publication may not be reproduced in whole or in part without the consent of copyright owner.

Subscribers: The publisher, upon written request to our New York office from any subscriber, agrees to refund that part of the subscription price applying to copies not yet mailed. Please send change-of-address notices or complaints to Fulfillment Manager; subscription orders to Circulation Manager, Electronics, at address below. Change-of-address notices should provide old as well as new address, including postal zip code number. If possible, attach address label from recent issue. Allow one month for change to become effective.

Postmaster: Please send form 3579 to Fulfillment Manager, Electronics, P.O. Box 430, Hightstown, N.J. 08520.



# The \$595 "Goof-Proof" Function Generator

The new Krohn-Hite 5200A linear sweep/generator protects itself from any voltages that you accidentally apply to its output. The 5200A is 2 generators in 1, providing sine, square and triangle waveforms and ramps over a 0.002 Hz to 3 MHz range plus an independent linear sawtooth over a 0.1 Hz to 100 KHz range. Nine modes including gate, trigger, bursts, frequency sweeps or pulses — Lots more good features and specs — For fast action, call The Wavemakers at (617), 580-1660, or any of the reps listed below.

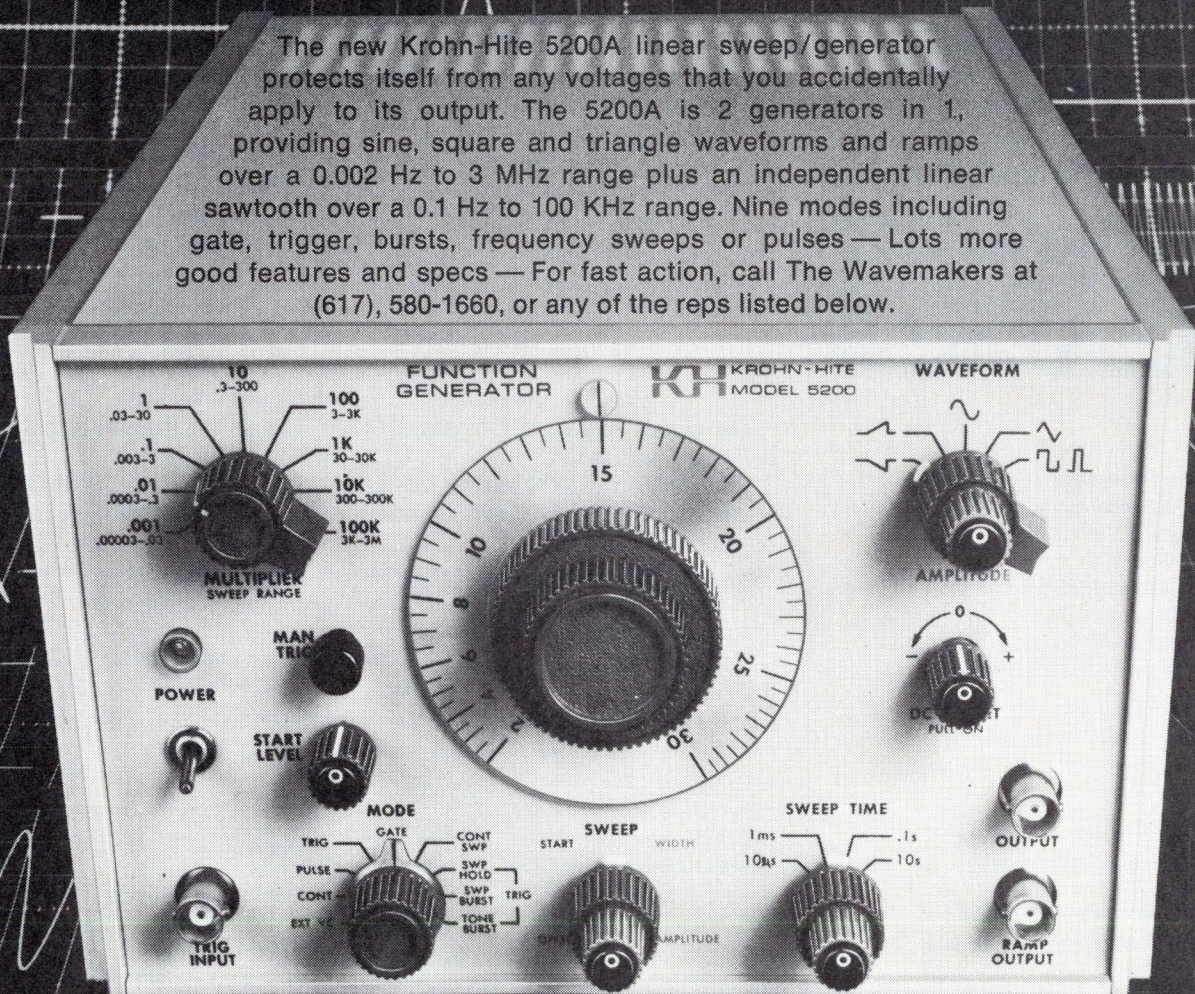

**KROHN-HITE CORPORATION**

Avon Industrial Park, Avon, Mass. 02322 • (617) 580-1660, TWX 710-345-0831

SALES OFFICES: ALA., Huntsville (205) 534-9771; ARIZ., Scottsdale (602) 957-9110; CAL., San Jose (408) 292-3220; INGLEWOOD (213) 674-6850; COL., Denver (303) 773-1218; CONN., Glastonbury (203) 633-0777; FLA., Orlando (305) 894-4401; GEO., Atlanta (404) 448-2365; HAWAII, Honolulu (808) 941-1574; ILL., Des Plaines (312) 298-3600; IND., Indianapolis (317) 244-2456; MD., Baltimore (301) 321-1411; MASS., Lexington (617) 861-8620; MINN., Minneapolis (612) 884-4336; MO., Kansas City (816) 454-5836; ST. LOUIS (314) 423-1234; N.C., Burlington (919) 227-3639; N.J., Cherry Hill (609) 482-0059; N.M., Albuquerque (505) 255-2330; N.Y., E. Syracuse (315) 437-6666; ROCHESTER (716) 328-2230; VESTAL (607) 785-9947; ELMONT (516) 488-2100; OHIO, Chesterland (216) 729-2222; DAYTON (513) 434-8993; OKLA., Tulsa (918) 299-2636; ORE., Portland (503) 297-2248; TEX., Addison (214) 661-0400; HOUSTON (910) 881-5532; VA., Falls Church (703) 573-8787; WASH., Bellevue (206) 454-3400; CANADA, Montreal, Quebec (514) 341-7630; Ottawa, Ontario (613) 235-5121; Toronto, Ontario (416) 445-9900; Vancouver, British Columbia (604) 253-5555; Halifax, Nova Scotia (902) 454-8321; St. John's, Newfoundland (709) 726-2422.

Circle 4 on reader service card



Now there's a  
universal computer-based  
in-circuit/functional  
test system with extensive  
digital test capability.



## FAULTFINDER<sup>®</sup> FF303

The new FF303 provides two separate in-circuit test approaches. Analog testing procedures use guarding techniques for straightforward component fault isolation. Pulse techniques are used for digital testing of all combinatorial and sequential logic independent of the surrounding circuitry. The FF303 can be configured with up to 928 analog test points and 1216 digital test points.

In-circuit test programming is done with a Faultfinder extension of BASIC which permits on-line editing and simplified, high-level language programming with user nomenclature.

The FF303 is a complete, flexible in-circuit test system for your production floor with low-cost software generation and unique capabilities for testing hybrid boards. We'd like to show you what it can do for you. Write or call for complete information.

Circle 6 on reader service card

**FF FAULTFINDERS Inc.**  
15 AVIS DRIVE, LATHAM, NY 12110 (518) 783-7786

Irvine, CA  
Sunnyvale,  
Park Ridge, IL  
Faultfinders GmbH, Eschborn, Germany

Cicero, IN  
Waltham, MA

## Readers' comments

### Will it work?

**To the Editor:** In the designer's casebook, "Adjustable pulse generator features alarm rate" [May 27, p. 106], the circuit shown will not operate as advertised.

With only a positive supply voltage, one cannot obtain a negative-going (with respect to common) pulse. Second, capacitor  $C_7$  in the retrigger cycle of the one-shot circuit  $IC_{1B}$ , would have too much leakage for this type of application. Some type of diode or transistor leakage isolation would be necessary. Third, the retrigger time with the listed values of resistor  $R_6$  and capacitor  $C_7$  is about 0.77 second nominal, not 2 s.

Max M. Wertheim  
Huntington, N.Y.

**To the Editor:** The designer of the adjustable pulse generator described in the May 27 issue tells us to provide a minimum pulse of 10 volts peak to peak (+5 v to -5 v) and then effectively removes the "bottom" half with the  $R_1$ - $D_1$  resistor-diode combination. It would be interesting to hear why.

E. A. Spencer  
University Hospital  
London, Ontario

■ **The author replies:** Mr. Wertheim's points are well taken:

1. Since only a positive supply voltage is used, only output pulses that are positive with respect to ground are available. The one indicated as negative should be shown as the inverted sense of the positive pulse, but its bounds are +5 v and ground.

2. The reverse voltage that appears across  $C_7$  is in the range of 0.7 to 0.8 v, and a 20-wV dc solid tantalum capacitor can be used, since this type can be expected to tolerate a reverse bias of at least 5% of rated voltage. An oversight omitted the type and voltage rating of the capacitor.

3. The only requirement for the retrigger time is that it be longer than the normal maximum period of the trigger source. For this circuit, the timing was arbitrarily set to be greater than 0.5 s and was erroneously indicated as 2 s.

Concerning the point raised by Mr. Spencer about the circuit's input signal,

I stated, "Any function generator can provide a suitable clock signal. If a bipolar generator is used, diode  $D_1$  eliminates negative pulses." The reason for the  $R_1$ - $D_1$  combination is to present to the 74123 input a signal whose voltage swing closely approximates that of transistor-transistor logic.

Most 74123 manufacturers have designed into the input a clamp diode, which could be used instead of the external diode. The series resistor is still required if the 74123 is driven from a bipolar-signal source that has low output impedance. The resistor protects the 74123 from high currents that could flow during negative inputs.

When a function generator that has provision for offsetting the output from ground is used, the resistor can be eliminated if the signal-source output is adjusted to approximate TTL voltage levels.

### Dividing by 7

**To the Editor:** The divide-by-7 example and pin listing are incorrect in "TTL decade counter divides pulse train by any integer" (July 8, p. 90). To correctly divide by 7 with a 7490, take the output from pin 11, connect pin 8 to pin 3, and delete the connections these replace.

The other divisors are correct as stated in the article.

James N. Brink  
Garland Construction Co.  
Fayetteville, N.C.

■ **The authors reply:** While you are wholly correct that pin 8 (not pin 9) must be connected to pin 3, we are at least only half wrong. Both pin 11 (as you suggest) and pin 12 (as we stated) will provide one pulse out for every seven input pulses. Therefore, either pin may be used as an output.

### Correction

All requests for IEEE Std. 488-1975 on the standard instrumentation interface bus [Aug. 5, p. 70] should go to the Institute of Electrical and Electronics Engineers, 345 E. 47th St., New York, N.Y. 10017. The United Kingdom's Institution of Electrical Engineers, which has received requests for copies, does not produce standards.



# TEKTRONIX now has 5 ways to look at logic.

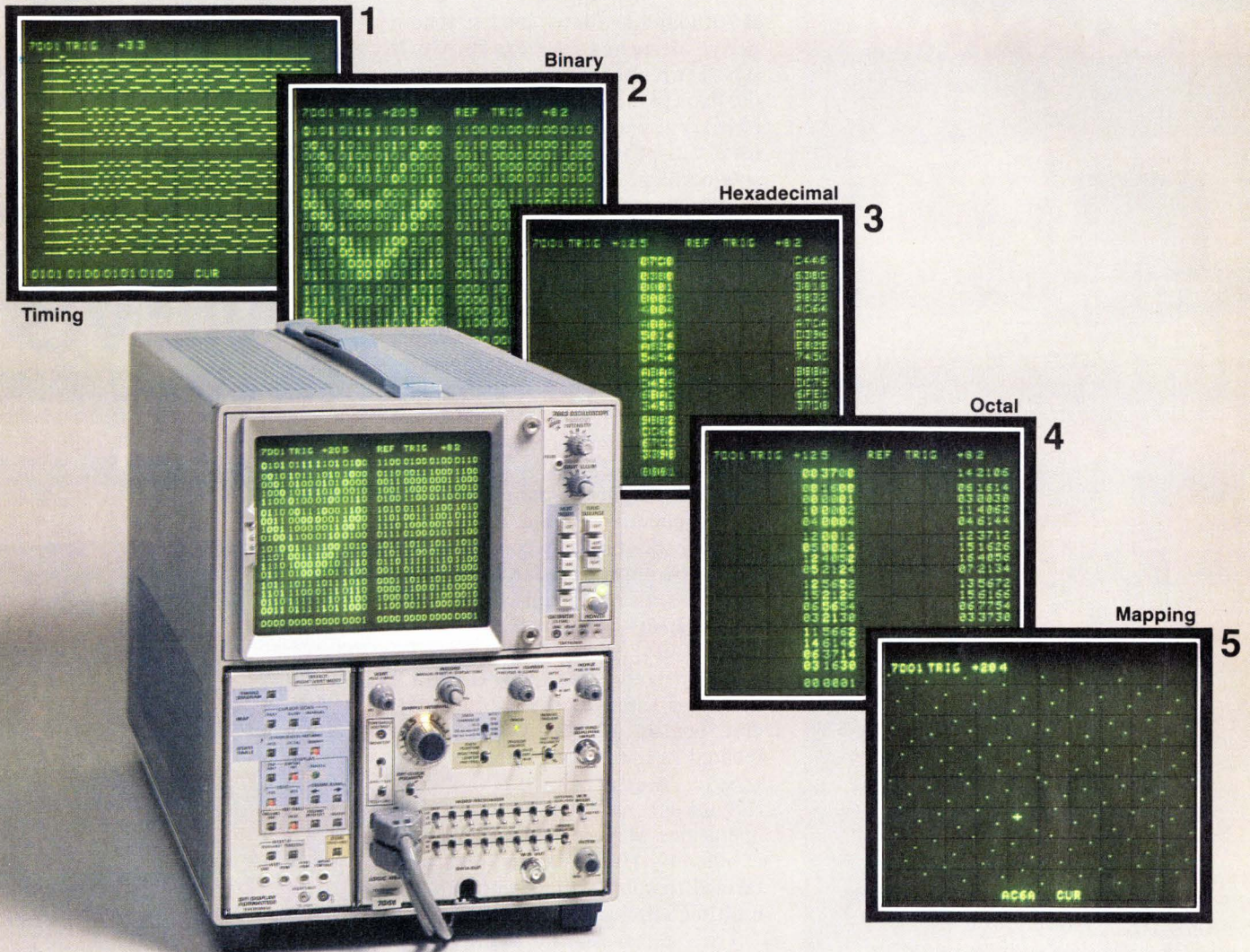

## The New DF1 Formatter

First, we gave you the timing display and binary readout with our 7D01 Logic Analyzer. Now, with the DF1 Display Formatter, which is dedicated to the 7D01, you have five display formats to operate from, all in a 7000-Series mainframe. Now you can convert a timing display into tables of words in Binary, Hexadecimal, Octal ... or a mapping configuration ... whatever your application requires.

A STATE TABLE mode of operation produces standard tables of up to 16 lines of 16-bit words. Using the 7D01's cursor, you can step through these tables word-by-word in Binary, Hex, or Octal. A 17th word is added to each table emerging from the 7D01's memory, to serve as a "key" and indicate you are indeed scrolling correctly through the long memory. The 7D01's fine cursor

control steps the display line-by-line, while the coarse control advances it table-by-table.

One of the most powerful analytical capabilities provided by the STATE TABLE mode is that you can display two tables—a reference table of "proved" data plus a "new" data table drawn from a system under test—on the same crt for side-by-side comparison. New data that is different from the reference data is automatically intensified ... you immediately know faulty data exists, and you know its location.

With the DF1 you can map, not just one, but three ways. The ability to map FAST, SLOW, or MANUAL lets you quickly recognize a word of interest, track it, isolate it, then pinpoint it for detailed analysis. The importance of mapping is derived from the speed with which you can isolate problems.

The logic analyzer package shown (7603 Option 1, 7D01, DF1) starts as low as \$5790. If you already own a 7000-

Series mainframe, add the 7D01-1 (7D01/DF1 combination) for only \$4390. Also consider that your money buys you these important 7D01 features: 1) Word recognition, 2) 16 channel operation, 3) 15-ns asynchronous timing resolution, 4) 4k formattable memory (4, 8 or 16 channels), and 5) High Z probes.

For more information or a demonstration of the DF1, contact a Tektronix Field Engineer near you. Or write Tektronix, Inc., P.O. Box 500, Beaverton, OR 97077.

United States sales prices are F.O.B. Beaverton, OR. For price and availability outside the United States, please contact the nearest Tektronix Field Office, Distributor, or Representative.



**TEKTRONIX®**  
committed to  
technical excellence



# Get the scope you need-Now!

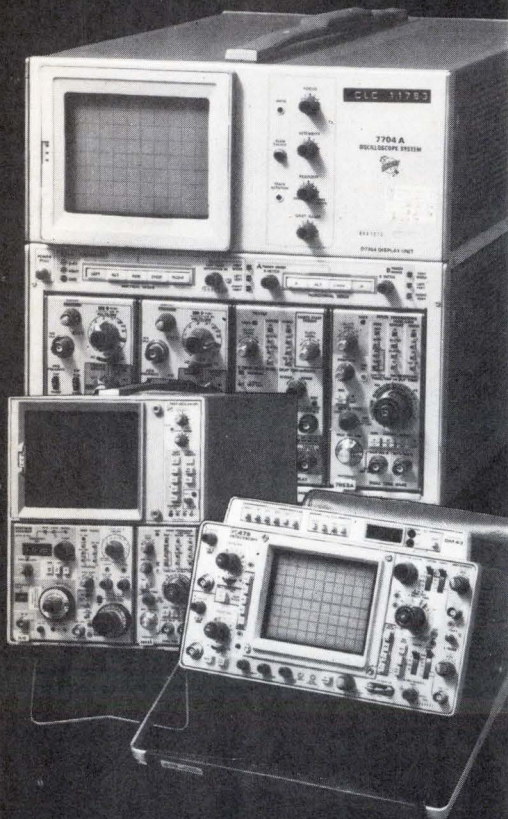

Our "Instrument Professionals" will tell you which scope will do the job best, at the lowest cost, make immediate delivery and guarantee performance.

Write or call for data on our other specialties: Instrument Leasing • Computer Peripherals • Equipment Sales • Instrument Service.

Circle 8 on reader service card

## Call Get our FREE Catalog

# Continental Rentals

Div. Continental Leasing Co., Inc.  
175 Middlesex Turnpike, Bedford,  
MA, 01730 (617) 275-0850

Metuchen, NJ (201) 549-8500;  
Gaithersburg, MD (301) 948-4310; TX  
(214) 357-1779; Elk Grove, IL (312)  
439-4700; Costa Mesa, CA (714)  
540-6566; Santa Clara, CA (408)  
735-8300; Los Angeles, CA (213) 477-7521

## News update

■ Although available for less than a year, Hughes Aircraft Co.'s AN/UYK-30 microcomputer evidently is gaining rapid acceptance by military users. It has been designed into 12 programs, for all three services, and decisions are expected on perhaps another dozen by year end, says Dale Manos, manager of computer applications for the Hughes Data System division.

Regarded as the first microcomputer to use commercially available large-scale-integrated microprocessor chips (Intel Corp.'s bipolar 3000 series), it reached the hardware stage last summer [*Electronics*, Sept. 4, 1975, p. 32] After subsequent tests, the Hughes computer found its first application in the Air Force's modular digital-scan converter, for which it translates radar signals into the fast-scan rate required by television displays [*Electronics*, Feb. 5, 1976, p. 29.]

**Militarized.** The AN/UYK-30, fitted on three 5.6-by-6.2-inch circuit boards, also is being implemented in the Navy's standard electronic modules (SEM). With throughput of 340,000 to 660,000 operations per second, the machine is billed by Hughes as the first militarized bipolar microcomputer for multiple applications.

The main reason for the fast start is that "it fills a vacuum, where there was no other machine before," to quote Robert D. Hawkins, microprocessor-design coordinator at the Navy Weapons Center, China Lake, Calif. It is already on one classified program and "being considered for six or seven additional programs at the weapons center alone," he says.

"The most important need it satisfies," he continues, "is in programs where current dedicated computers are either too expensive or too large. It's 1/25 the cost of the \$20,000-to-\$30,000 minicomputers, and requires 1/25 the volume."

Manos says the UYK-30 will cost about \$2,500 when in quantity production by next year. And Hughes is also hoping to sell the machine to commercial systems houses. □

# The Noise Loading Test Set

## MEV8

The MEV8 consists of the Noise Receiver ML415A and the Noise Generator MG431A. It is best to measure the performance of radio relay and cable systems for frequency division multiplex telephony under conditions closely approaching those of actual operation.



- Meets the latest CCIR and CCITT recommendations.
- Suitable for systems of 24 to 2700 channels or more (10kHz to 18MHz).
- Easy replacement of plug-in filters and accommodation up to 7 measuring frequencies simultaneously.
- Direct reading dial of noise level (absolute or relative) and noise ratio (NPR or S/N) with or without weighting.
- TRANSMISSION LEVEL dial and DIFFERENCE FROM TL dial facilitating measurements.
- Easy operation by remote control from the Noise Receiver to Noise Generator.
- Low intrinsic thermal noise minimized at -130 dBm.
- Inband and out-of-band measurements.

## Anritsu

**ANRITSU ELECTRIC CO., LTD.**  
MEASURING INSTRUMENTS DIVISION

12-20, Minamiazabu 4-chome, Minato-ku, Tokyo 106, JAPAN  
Telex: 0-242-2353  
U.S.A. TAU-TRON INC Tel: (617) 667-3874  
W. Germany KNOTT ELEKTRONIK GMBH Tel: (08178)4085  
Holland UNI OFFICE B.V. Tel: (010)-22.94.44  
Italy VIANELLO S.p.A. Tel: (02) 544041

Circle 181 on reader service card



# Coming through...

with people, ideas, products—  
whatever it takes to get the job done



Wire, cable and cord sets usually cost less to buy than install. And poor performance can cut into your product's profitability deeper than potential savings on an initial buy. Belden is ready with whatever it takes to get the job done right.

**BROAD LINE:** Belden comes through with thousands of standards that fit your toughest environmental and application needs. And if a standard won't work, we will custom design an answer to your need.

**ENGINEERING HELP:** When you have problems in stripping, terminating, installing, fabricating, safety engineering, ordering, quality control, or want information on the codes or design parameters, ask a Belden specialist. "Hot-line" assistance is as near as 317-966-6681. Call and see.

**UNIQUE PUT-UP CAPABILITY:** Ask about Belden's UNREEL® dispensing system. Pays out wire continuously without snarls, backlash, or tensioning devices. One company cut processing time by 30%\*.

And Belden is coming through with a lot more. A design kit that covers performance characteristics, costs, material capabilities. And we've increased production capability for shorter lead times, great delivery.

Quality wire, cable and cord—whatever it takes to protect your bottom line performance every day. Belden Corporation, Electronic Division, P.O. Box 1327, Richmond, IN 47374, 317-966-6661.

8-6-6 B

\*Information available upon request.

**BELDEN** 

Circle 9 on reader service card

**Coming through...**  
with new ideas for moving electrical energy

Copyright © 1976 by Belden Corporation



## The continuing controversy in manpower projections

The waste of a resource is always shameful, but it assumes tragic proportions when the resource is people. And in the case of engineers, where long, hard, and expensive training is involved, the waste and the thwarting of talent and opportunity may be rightfully termed scandalous.

For some time it has been apparent that the nation's engineering schools are turning out more EEs than industry, government, and academia can absorb. Incredibly, despite studies by engineering societies and warnings from a host of other informed groups, there is no evidence that steps are being taken to make sure that young people entering an engineering career path are presented with a realistic picture of their prospects for jobs after their training is completed.

Right now, educators and prospective students must rely chiefly for such information on the manpower prospect reports issued by the Engineering Manpower Commission. Unfortunately, these reports are now known to be highly speculative, based as they are on raw, unsubstantiated data furnished by a few hundred companies and organizations in the form of estimates of what their individual engineering manpower needs might be in future years.

While the Commission itself points out that the reports constitute projections rather than valid predictions, it's doubtful that these semantic differences are appreciated by thousands of prospective students who are lured into the engineering curriculum by the prospect of an ever-increasing demand

for such skills, only to find long lines at the unemployment office.

At this point, we can see no possible good in continuing manpower-demand research as it is conducted by the EMC. However, despite the growing criticism of the commission's role in exacerbating engineering career problems, the sad truth is that there is currently no alternative being planned. Some way must be found to improve the inputs and the analysis of the manpower requirement data in the future. The samples should be distributed between industry and academia in such a way as to avoid bias. An effort should be made to track the predictions (or projections, if you will) with the actual engineer population. And reports should be issued frequently and unambiguously.

The EMC's excuse that its budget can not be stretched that far should be viewed against the trouble that it is having in finding money to make new studies. Its supporting associations are not happy with the present approach to manpower surveying and are saying so with their purses. Yet a revised approach would probably go a long way toward loosening the purse strings again.

The deficiencies in the current manpower demand figures have been apparent for some time. Groups like the IEEE and NSPE have pointed them out. Yet no group appears to have initiated any meaningful steps toward attacking the problem. This has been a major contributor to career disruption and the consequent embitterment so characteristic of many engineers today.



# Microprocessing becomes a buyer's market.

If you're a MOS microprocessor customer, the last few years haven't been a whole lot of laughs.

One supplier had all the good stuff, made all the rules, told you what you could buy. And when. And for how much.

But something happened to change all that: Advanced Micro Devices.

We make the best microprocessor in the world, the Am9080A, and we make all the support circuits you need. They're yours now, off the shelf, at competitive prices. That's right. Competitive.

But we make more than microprocessor products. We make you a promise:

We'll sell you any part, in any quantity, bundled or unbundled. You're the customer.

So, if you suddenly find yourself having an easier time buying microprocessors, just remember why. And who.

If you're shy, and you're just not sure how to say thank you, an order would be really nice.

Write or phone Advanced Micro Devices, The Buyer's Market.

## Ours and Theirs.

(The 9080A & 8080A)

Specification	AMD	Intel
Minimum Instruction Cycle Time	1 microsecond	1.3 microseconds
Maximum Power Dissipation (at 1.3 microsec. 0-70°)	829 milliwatts	1307 milliwatts
Output Drive	3.2mA @ .4V	1.9mA @ .45V
Minimum Input High Voltage	3.0V	3.3V
MIL-STD-883	Standard	Special

## Ours and Ours.

(Am9080A System Circuits)

AMD Part Number	Description	Availability
<b>CPU</b>		
Am9080A/-2/-1/-4	Speeds to 250 nsec. 0 to 70°C	In Dist. Stock
Am9080A/-2	Speeds to 380 nsec. -55 to +125°C	In Dist. Stock
<b>Static Read/Write Random Access Memories</b>		
Am9101A/B/C/D	256 x 4, 22 Pin Speeds to 250 nsec.	In Dist. Stock
Am91L01A/B/C	256 x 4, 22 Pin Speeds to 300 nsec.	In Dist. Stock
Am9102A/B/C/D	1K x 1, 16 Pin Speeds to 250 nsec.	In Dist. Stock
Am91L02A/B/C	1K x 1, 16 Pin Speeds to 300 nsec.	In Dist. Stock
Am9111A/B/C/D	256 x 4, 18 Pin Speeds to 250 nsec.	In Dist. Stock
Am91L11A/B/C	256 x 4, 18 Pin Speeds to 300 nsec.	In Dist. Stock
Am9112A/B/C/D	256 x 4, 16 Pin Speeds to 250 nsec.	In Dist. Stock
Am91L12A/B/C	256 x 4, 16 Pin Speeds to 300 nsec.	In Dist. Stock
Am9130A/B/C/D/E	1024 x 4, 22 Pin Speeds to 200 nsec.	In Dist. Stock
Am9140A/B/C/D/E	4096 x 1, 22 Pin Speeds to 200 nsec.	In Dist. Stock
<b>Dynamic Read/Write Random Access Memories</b>		
Am9050C/D/E	4K x 1, 18 Pin Speeds to 200 nsec.	In Dist. Stock
Am9060C/D/E	4K x 1, 22 Pin Speeds to 200 nsec.	In Dist. Stock

AMD Part Number	Description	Availability
<b>Mask Programmable Read-Only Memories</b>		
Am9208B/C/D	1K x 8 Speeds to 250 nsec.	Factory Stock
Am9216B/C	2K x 8 Speeds to 300 nsec.	Factory Stock
<b>Erasable Read-Only Memories</b>		
Am1702A	256 x 8, 1.0 μsec.	In Dist. Stock
Am2708	1024 x 8, 450 nsec.	4th Q. 1976
<b>Processor System Support Circuits</b>		
Am8212	8-bit I/O Port	In Dist. Stock
Am8216	Non-Inverting Bus Transceiver	In Dist. Stock
Am8224	Clock Generator	In Dist. Stock
Am8226	Inverting Bus Transceiver	In Dist. Stock
Am8228	System Controller	In Dist. Stock
Am8257	Direct Memory Access Controller	2nd Q. 1977
Am8259	Priority Interrupt Controller	2nd Q. 1977
Am9551	Programmable Communications Interface	4th Q. 1976
Am9555	Programmable Peripheral Interface	In Dist. Stock
Am25LS138	1-of-8 Decoder	In Dist. Stock
Am25LS139	Dual 1-of-4 Driver	In Dist. Stock
*Am25LS240	8-bit Inverting Bus Driver	4th Q. 1976
*Am25LS241	8-bit Non-Inverting Bus Driver	4th Q. 1976
*Am25LS273	8-bit Common Clear Register	4th Q. 1976
*Am25LS374	8-bit 3-state Register	4th Q. 1976
*Am25LS377	8-bit Common Enable Register	4th Q. 1976

\*All combine high performance and low power in space saving 20-pin package

CPU: 9080A = 480 nsec. - 2 = 380 nsec. - 1 = 320 nsec. - 4 = 250 nsec.  
MEM: A = 500 nsec. B = 400 nsec. C = 300 nsec. D = 250 nsec. E = 200 nsec.

# Advanced MOS/LSI

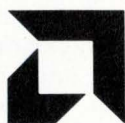

Advanced Micro Devices • 901 Thompson Place, Sunnyvale, California 94086 • Telephone (408) 732-2400 •  
Distributed nationally by Hamilton/Avnet, Cramer and Schweber Electronics.

Circle 263 on reader service card



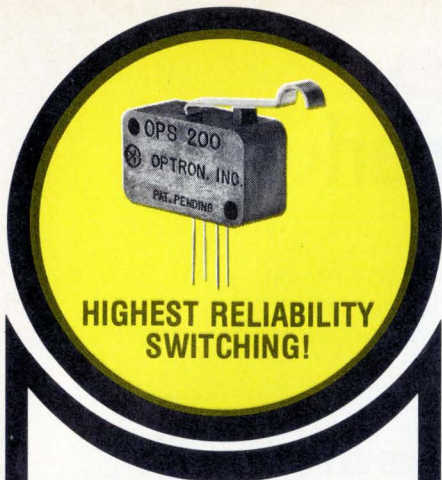

HIGHEST RELIABILITY SWITCHING!

## OPTICALLY COUPLED LIMIT SWITCHES

OPTRON OPS 200 SERIES SWITCHES MEET SPECS AFTER 100,000 HOURS OF OPERATION

Even after 100,000 hours of operation at rated currents, OPTRON's new high reliability OPS 200 series optical limit switches will still meet specifications.

New OPS 200 and OPS 200A limit switches combine the non-contact switching feature of popular optically coupled interrupter modules with the convenient mounting and actuating features of conventional mechanical switches to provide solid-state reliability in a mechanical switch package.

An optical shutter controlled by a snap-action mechanism interrupts the light path between a gallium arsenide infrared LED and a silicon photosensor. The condition of the photosensor, either illuminated or dark, determines the ON (closed) or OFF (open) state of the switch.

There is no contact bounce or contact contamination. Interfacing with high speed logic circuitry is possible without the buffering stage required with conventional switches. Both the OPS 200 and OPS 200A eliminate arcing and are unaffected by magnetic fields.

The OPS 200 has a high gain N-P-N phototransistor output. In the closed condition with a LED drive current of 30 mA, a minimum output of 1.6 mA at 0.4 volts assures TTL compatibility. In the OPS 200A, a photodiode sensor followed by a Schmitt trigger circuit with 140 mA output sink capability eliminates the need for amplifiers in most applications.

Both new limit switches are available from stock in either normally open or normally closed conditions.

*Detailed technical data on OPS 200 series limit switches and other OPTRON optoelectronic products... chips, discrete components, reflective transducers, isolators and interrupter assemblies... is available from your nearest OPTRON sales representative or the factory direct.*



**OPTRON, INC.**

1201 Tappan Circle  
Carrollton, Texas 75006, U.S.A.  
TWX-910-860-5958  
214/242-6571

## People

### Power constraints toughest for Goodlette's Mars landers

"As it sits today on Mars, the Viking lander is almost identical to the design we proposed to NASA in 1969," observes John Goodlette, chief engineer for the craft. However, meeting power constraints posed knotty problems, and coming up with the hardware "required every subsystem but the radio to advance the state of the art at least a modest step." Goodlette knows more about the pair of unmanned landers sent to Mars than anyone else. He has lived full time with them since 1969, when his company, Martin-Marietta's Aerospace division in Denver, became prime contractor for them. Actually, the 51-year-old Goodlette is a veteran of missile work dating back to the 1950s.

**Power shortage.** "The chief question was how to build the electronics in the 33 subsystem/components to operate under the power constraints," he recalls. The weak sunlight striking the Martian surface and fouling by dust ruled out using photovoltaic solar cells.

Instead, twin radio-isotope thermoelectric generators were chosen. They deliver nearly 80 watts, and the designers had to keep power needs under that ceiling. "The key proved to be power-state switching so that we only turn on something when we need it." To do this, engineers programed a general-purpose computer to track power needs up to 10 minutes ahead. "The computer even puts itself to sleep and wakes itself up. It saves a lot of power, since the sleep state uses about 4 w, against the all-up 37 w."

But to satisfy peak-power needs that can reach 270 w when all experiments are running, four rechargeable sealed-wet-cell nickel-cadmium batteries are used. Built by General Electric's Battery division, they store a little more than 1,000 watt-hours. Satisfying the 115°C sterilization requirement imposed on all Viking equipment had been impossible for batteries, says Goodlette. GE solved it with a proprietary



**Designer.** With computers that sleep, John Goodlette's landers now sit on Mars.

cell-separation material, which may have commercial potential.

Sterilization to prevent contaminating the Martian environment also caused the computer to be what Goodlette calls "our toughest single problem." The Honeywell Inc. Aerospace division built the computer, which is fully redundant, weighs 52 pounds, and contains 18,432 25-bit-words of plated-wire memory.

The design philosophy of "enforced redundancy" of all circuitry reflects circa-1969 technology, he observes. "For the most part, it's medium-scale integration, flat-packs, and hybrids, with only some LSI circuits. If Viking were built using today's LSI, "you'd really see something," he concludes.

### Arnaldo Coen wants Italy's SGS-Ates to grow smoothly

Recently appointed general manager of SGS-Ates Componenti Elettronici SpA, Italy's leading semiconductor manufacturer, Arnaldo Coen has one major aim for the state-controlled company—to iron out the exaggerated peaks and troughs in sales by diversifying products and markets. "The ups and downs in the past have been enormous," he says. "For example, I expect us this year to pull out of the recession with a 50% increase in sales [to \$72 million]. But if we persist in selling up to 70% of our output in the consumer sector, we'll be at the mercy of the next recession too."

SGS-Ates, headquartered in Agate, a few miles northeast of Milan, has made a name for itself in



# SGS-ATES power linears or it's lonely at the top

Our loneliness and our leadership go back a long, long time; they began with power linears.

In fact, right from the start we've done it all ourselves; paving the way for the others. So that now, when you talk about power linears you automatically talk about SGS-ATES. And in all senses - from experience to technological progress, from the fullness of range to production know-how.

In 1968 we put the first audio amplifier on the market - the 2 W TAA 611 - and since then we've gone on being first at every new step along the way. In 1970 we were the first to achieve 5 W with the TBA 641 and TBA 800; in 1972 the first circuit with thermal protection - the 7 W TDA 810S.

In 1973 the first amplifier to achieve 10 W with full protection - the TCA 940.

In 1974 the first real Hi-Fi, the TDA 2020 - 20 W with 1% distortion.

The development of these technologies has also made it possible to make the first complete sound-channel for TV; the first monolithic vertical deflection system; the first complementary Darlington integrated pair.

## And now?

The TDA 2002: the most robust and compact audio amplifier. The very best of our design experience has gone into producing the TDA 2002: in the chip and the package. It comes in Pentawatt® and it's highly protected against thermal overloads; against short-circuits; against supply overvoltages including spikes.

With a 14.4 V supply it gives 8 W on 2 Ω. It is ideal for car radios and saves 50% on external components and even more on space.

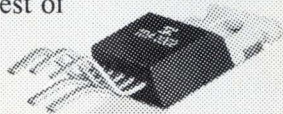

## And that's why



SGS-ATES SEMICONDUCTOR CORPORATION  
Newtonville, Mass., tel: 617-9691610

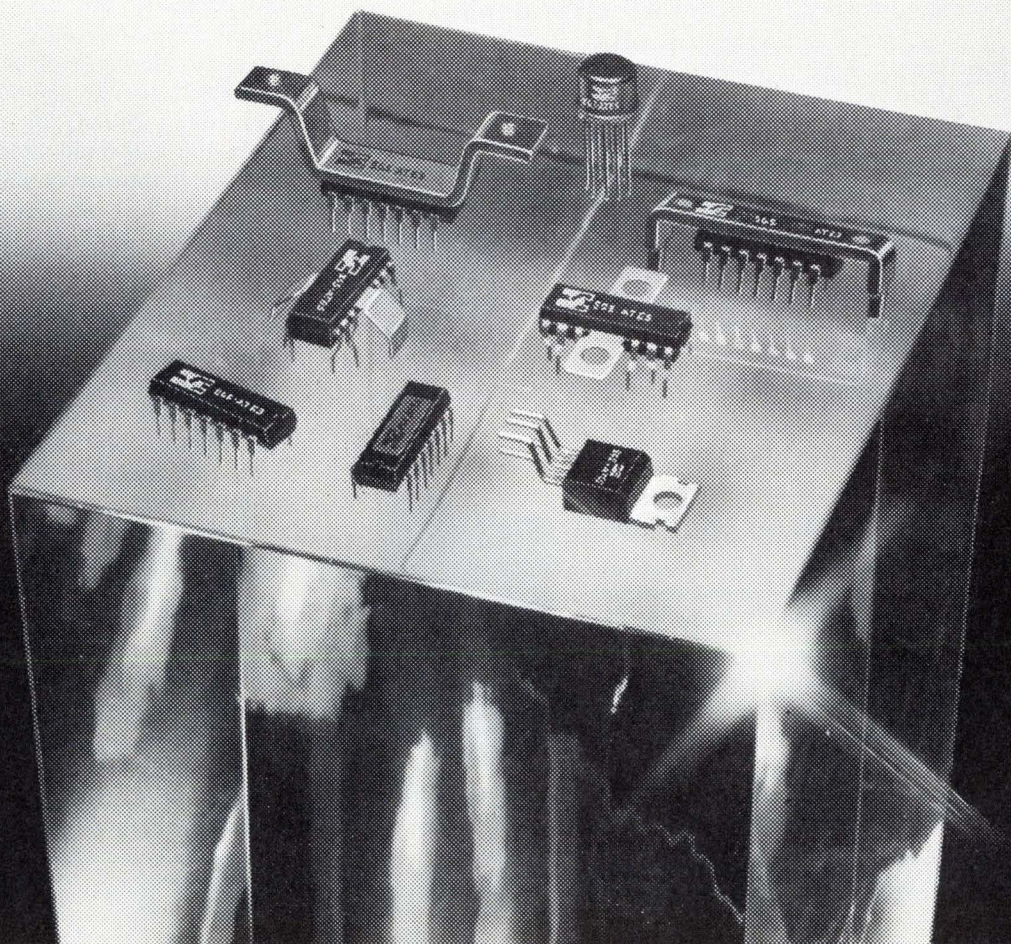





# L,R,C goes $\mu$ P

## Simple, fast, accurate

This all new microprocessor-controlled bridge is ideal for your manual or automatic component testing. Functions, ranges, test voltages and frequencies are easily selected on the 24-button front panel keyboard or can be programmed via the optional IEEE 488-1975 interface bus. Measurement speed is 100-200 ms for 1 kHz and 200-300 ms for 120 Hz.

For component sorting, optional plug-in PROM's enable you to set up to 10 programmable limits.

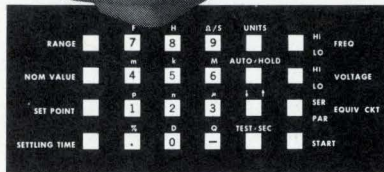

All for under \$5,000 U.S.A. (not including options).

- dual 4½-digit displays.
- 1 kHz and 120 Hz freq.
- wide ranges (C to 200,000  $\mu$ F).
- 0.1% basic accuracy.
- autoranging.
- selectable test voltages.
- 100-300 ms measurement speed.
- low cost options:
  - IEEE 488-1975 interface bus.
  - Single or multiple limits.

	Capacitance	Inductance	Resistance
1 kHz	200 pF to 20,000 $\mu$ F	20 $\mu$ H to 2000 H	200 m $\Omega$ to 20 M $\Omega$
120 Hz	2000 pF to 200,000 $\mu$ F	200 $\mu$ H to 20,000 H	

D range is 0.0001 to 1.9999. Q range is 0.5 to 10,000. Gp 200 S to 2000 nS.



Model 296  
Automatic L,R,C Digital Meter

Electro Scientific Industries  
13900 N.W. Science Park Dr.  
Portland, Oregon 97229  
Telephone: (503) 641-4141  
Telex: 36-0273



Circle 14 on reader service card

### Own your own holder to hold your own!

Hold your own copies of Electronics in specially designed slipcase holders. They'll keep your Electronics library neat and handy—a permanent information file, issue by issue.

Just complete the coupon and mail to Jesse Jones. He'll process your order upon receipt, postpaid.



**ELECTRONICS BOXER**  
Jesse Jones Box Corporation  
2250 E. Butler St., Philadelphia, Pa. 19137

Please send me:  boxes @ \$4.25 each;  3 boxes @ \$12.00;  6 boxes @ \$22.00.  
My check or money order is enclosed.

Name: \_\_\_\_\_  
Address: \_\_\_\_\_  
City: \_\_\_\_\_ State: \_\_\_\_\_ Zip: \_\_\_\_\_

## People



**Bottom liner.** SGS-Ates' Arnaldo Coen aims at profits for his state-owned company.

linear integrated circuits and power and metal-oxide-semiconductor transistors. But wishing, as he does, to hold consumer sales down to 50% of the total, Coen intends to broaden his product mix. One thing he plans is to produce microprocessor-based systems using a chip developed earlier by his company for a calculator. Applications he has in mind are in machine tools, industrial process control, and telecommunications.

**New products.** Whenever feasible, Coen wants to market finished products using components made by his company. His first product is a liquid-crystal-display watch, and he's considering a clock radio. SGS-Ates will also be selling technology abroad. In Brazil, for example, the company will build production lines for power transistors and for ICs.

The 51-year-old Coen is a transplant from another Italian state-controlled company, Sirti, a manufacturer of telecommunications gear. With Sirti since 1950, the elegant and direct-speaking Coen rose to become its commercial and technical director. The company is one of those rare commodities in Italian state-run industry—it has been a profit-maker.

It's to profits that Coen will be guiding SGS-Ates, and that means cutting production costs. At plants in Italy, Coen will switch some production to more efficient, three- and four-inch wafers. In addition, he plans to mechanize production lines and transfer high-volume output to plants in the far east.

Says Coen, who predicts doubled sales in three years, "A company cannot live for sales volume alone. It's got to look at the bottom line."





# MEASUREMENT COMPUTATION

innovations from Hewlett-Packard

# NEWS

SEPTEMBER 1976

## in this issue

Special edition:  
HEWLETT-PACKARD  
INTERFACE BUS

World's first  
rectangular lamp

Three new personal  
calculators



New 5½, 6½-digit DVM checks its dc and ohms circuits for accuracy and then makes corrections. One microprocessor controls the Auto-cal process; the other is for computation of the math functions and remote programming via the HP-IB.



## NEW HP microprocessor-controlled DVM makes 24 readings/sec in presence of noise

Hewlett-Packard's new Model 3455A DVM has high speed and good noise rejection for systems use and high resolution and computational capability for bench applications.

Dc measurements from 1 microvolt to kilovolt can be made at 24 readings per second with 5½ digits; 6½ digits are used for greater than 1 ppm resolution measurements at six readings/second. Greater than 60 dB normal mode noise rejection and greater than 160 dB common-mode noise rejection is obtained on all dc ranges. Best dc accuracy ±0.0023%.

True rms measurements are made up to 13 readings per second above 300 Hz. True rms is measured with best accuracy of 0.1% over a 30 Hz to 1 MHz bandwidth. Signal crest factors as high as 7:1 full scale can be measured.

Four or two-wire resistance measurements can be made from 1 milliohm to 15 megohms. Maximum current through the unknown is less than 1 milliamper.

Math functions built into the 3455A let the user offset, take ratios or scale readings so that readouts are in physical units. A % ERROR mode converts read-

ings into percent change compared to a predetermined reference.

Use of a plug-in precision reference enables the instrument to check itself against the reference. Under control of a microprocessor, it makes its own error corrections. This reference unit can be easily removed from the 3455A for periodic calibration. A self-test feature verifies operation of dc circuits. If a problem is found, it is easily diagnosed using the front panel display.

Standard on the 3455A is an HP-IB (Hewlett-Packard's implementation of IEEE 488-75) I/O for systems operation. Front panel indicators on the 3455A display range, function and HP-IB status during remote operation.

For more information, check I on the HP Reply Card.



# Automatic system speeds transceiver testing to 1000 MHz

Productivity is the watchword in receiver manufacturing. Radio maintenance shops are striving to improve throughput, test quality, and turn-around-time. R&D and incoming quality labs need to provide accurate, consistent, and comprehensive testing of today's sophisticated transceivers.

To help solve these requirements, Hewlett-Packard is introducing its 8950A Transceiver Test System. The combination of these mostly off-the-shelf instruments provide capability of testing AM and FM transceivers up to 1000 MHz and 100 watts. System control is via the HP 9825A calculator providing self-contained operation.

Amplitude modulation characteristics are measured from 1 to 95% depth and an accuracy of  $\pm 5\%$ . FM deviation is measured to 20 kHz with an accuracy of  $\pm 3\%$ . Audio measurements on the transmitter provide  $\pm 5\%$  accuracy on sensitivity, with audio response indicated to 25 kHz for AM and 20 kHz for FM. Audio distortion is measured to  $< 2\%$  at 400, 1000 or 3000 Hz using the THD (total harmonic distortion) technique. Squelch tone frequency is indicated to  $\pm 0.1$  Hz.

Receiver test capabilities include sensitivity tests at 12 dB SINAD for 1 kHz or

with 20 dB quieting and can also be made at squelch threshold. Audio power output is measured to  $\pm 0.5\%$  with a frequency response to 50 kHz; accuracy and audio distortion to  $\pm 1\%$  at 1 kHz tone.

Model 8950A achieves maximum throughput and testing speed with a special interface and signal switch adapter panel mounted at the operator shelf. Automatic testing can improve test times by 10 to 1 over manual tests. Throughput of course depends on the particular test sequence, but a Citizen Band transceiver test can be run in 3 minutes including a printed test report.

Hewlett-Packard furnishes software test modules as sub-routines, segmented by type of test; for example, transmitter power, transmitter frequency, etc. The user then writes simple programs to access the tests as appropriate and compare test data against programmed limits or print out a test card.

*For additional technical information, check Q on the HP Reply Card.*

New, easy-to-use storage controls make your measurements faster, less complicated

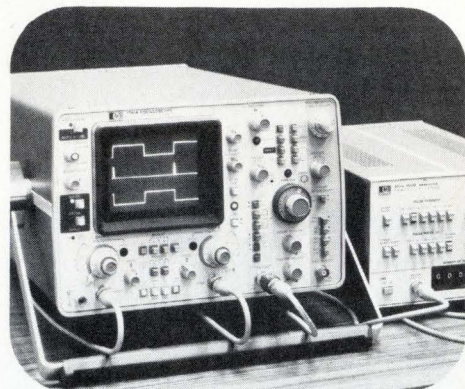

For viewing low-rep-rate/fast rise-time signals, the variable persistence mode of the 1741A storage oscilloscope allows you to adjust the trace for an optimum display.

A newly-designed storage/variable-persistence CRT, used for the first time in Hewlett-Packard's new 1741A oscilloscope, produces exceptionally clean traces, and excellent trace-to-background contrast ratio.

New automatic storage controls make it easier than ever before to capture low-rep-rate, single-shot waveforms common in today's digital circuits.

As a dual-channel, 100 MHz general purpose scope, it has a writing speed of at least 100 cm/ $\mu$ s which allows single shot capture of glitches 1 division high and less than 20 ns wide.

The variable persistence mode allows you to adjust the trace for an optimum display. The third-channel trigger view lets you observe an external trigger signal simultaneously with channel A and B traces.

A  $\times 5$  magnifier permits two channel measurements as low as 1 mV/div to 30 MHz, without cascading.

The 1741A is suited not only to the laboratory and the computer room, but also to the more rugged situations common with communications and process control equipment.

*For more information on this easy-to-use storage/variable persistence oscilloscope, check G on the HP Reply Card.*

HP-IB





Capture that unique digital event at the press of a button!

The handy HP 1230A Logic Trigger increases the usefulness of any scope in the data domain by providing a digitally-delayed jitter-free trigger just at that point in the data stream you require.

When digital delay is added to word recognition, it is possible to select a unique word because the trigger pulse can be released on any preset number of clock cycles after recognition. The scope will display the data stream from any desired point after the trigger word without multi-triggering. Subsequently, this point may be shifted either direction simply by pressing the Up or Down button—continuously for fast shift, or successively for step-by-step.

In addition to the 1230's clock and eight-bit word recognition (HI/LO/OFF) inputs, a gate input allows further qualification. Delay (between 1 and 9998 clock pulses) is indicated on a 4-digit LED display.

The 1230A can be operated in a synchronous or asynchronous manner for maximum measurement flexibility.

*For additional technical data, check O on the HP Reply Card.*

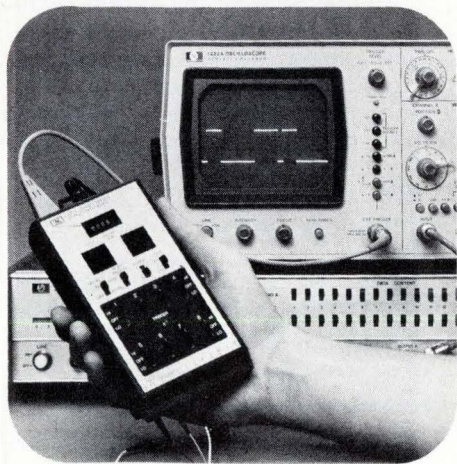

Compact 8-bit trigger probe generates a trigger output pulse from parallel digital pattern recognition with digital delay capability for oscilloscopes, logic analyzers, or other externally triggered test equipment.

## NEW automatic phase noise system simplifies difficult measurements



The 5390A Frequency Stability Analyzer specializes in phase spectral density measurements made very close to the carrier. Offset frequencies from below 0.01 Hz out to 10 kHz can be analyzed with extremely narrow bandwidths.

HP-IB

With tightening bit error rate requirements in satellite communications, shrinking bandwidths in ground communications links and greater resolution requirements in many radar systems, the ability to characterize precision frequency sources has been meeting increasing demands. In many cases specifications for close-in phase noise have been limited by the capabilities of existing test equipment rather than by the need for the information.

Although the 5390A frequency stability analyzer is a complimentary device to today's high performance spectrum and wave analyzers, it excels in the difficult close-in measurements (e.g. 100 Hz and below) where such devices become inadequate. Frequency offsets well below 1 Hz can now be analyzed with sub-millihertz bandwidths and excellent sensitivity.

Data is automatically collected by a high performance counter in the time domain. Under calculator control, the system operates as a frequency selective digital filter and converts the data to the frequency domain. Since the system measures zero crossings, elaborate amplitude calibration schemes are unnecessary. Data is automatically reduced and the single sideband phase noise-to-carrier ratio, normalized to a 1

Hz bandwidth, is presented in terms of dB below the carrier (dBc) in both tabular and graphical form using the 9871A printer/plotter.

The system will take measurements on carrier frequencies from 500 kHz to 18 GHz. Observations of phase noise may be made at offset frequencies from below 0.01 Hz out to 10 kHz with typical sensitivities of greater than -150 dBc at 1 Hz away from the carrier.

Measurements are usually made by comparing two similar sources slightly offset in frequency from each other. Measurements can also be made on non-offsettable sources by using an additional mixer/amplifier module.

Besides the difficult phase noise measurements, the 5390A also makes long term drift measurements and can monitor short term stability in the time domain using an improved version of the Allan Variance technique.

The basic system includes the 5390A analyzer, a 9825A calculator and 9871A printer/plotter, software for frequency stability and phase noise measurements, diagnostics, and a technical handbook.

*For a technical data sheet, check K on the HP Reply Card.*



## New HP-IB/21MX Minicomputer controls multiple instrument clusters, accesses data and develops new programs—all at the same time



### HP-IB

In the past, interfacing instrumentation systems for measurement and test applications has been complex and costly. Not any more. With the HP-IB/21MX Minicomputer, automatic test systems for production, laboratory research, and automatic data acquisition systems can be implemented more easily and simply. HP offers for the first time a minicomputer with a multi-programming operating system as a controller for instruments which conform to the IEEE-488 standard.

Take the simplicity of HP-IB\* interfacing. Add HP's 21MX Minicomputer and Real-Time Executive (RTE) software for the power and control. Choose from over 100 HP and non-HP IEEE-488 compatible instruments, calculators and peripherals to handle test and measurement. Within hours, flexible and powerful measurement and test systems can be up and running. OEM's can focus resources on customer interfacing.

**Controls multiple instrument clusters.** Because the Real-Time HP-IB Minicomputer supports multi-

programming, it can simultaneously control several HP-IB clusters of up to 14 instruments each. Test/measurement equipment can be organized into multiple physical or functional groups—each connected to the HP-IB/21MX Minicomputer by its own HP-IB Interface Bus.

New instrument clusters can be added or reconfigured without downtime or effect on existing clusters.

Systems can grow as needs grow. And, because of the new Real-Time HP-IB Minicomputer's speed as an HP-IB controller, throughput is increased in high volume or production testing.

**Consolidates data.** The Real-Time HP-IB Minicomputer's multi-priority program scheduling allows highest priority to run immediately and then later devote time to such operations as correlating and analyzing data, and producing timely management reports.

HP's new IMAGE/1000 data base management software adds a complete set of "software tools" for consolidating

files into a single data base. Once the data base is established, IMAGE/1000's English-like QUERY language allows users to interactively find any stored information by searching under multiple "key values" such as a part number, vendor code or failure type. IMAGE/1000 permits easy report generation with automatic sorting, summation, pagination and averaging.

### **Allows concurrent program development in multiple languages.**

While the Real-Time HP-IB/21MX Minicomputer is busy controlling instruments and consolidating data, it can also be used for program development.

For the first time, engineers can readily access instruments and devices via the IEEE-488 and with the popular scientific language FORTRAN IV. HP's Multi-User Real-Time BASIC, which can be learned in a few hours, and HP's assembly language are available. This multi-lingual approach brings the utilization of HP-IB to a wider cross section of users.

**Supports multiple terminals.** The Real-Time HP-IB Minicomputer also offers multi-terminal accessibility. Several people can use the system immediately and simultaneously—for program development, data entry or system control. As a result, testing and production data such as quality assurance information is available when needed for decisions.

**Augments data networks.** Finally, the Real-Time HP-IB/21MX Minicomputer extends the data gathering capabilities of today's computer networks. Off-the-shelf hardware/software data communications packages make it easy to connect the HP-IB/21MX Minicomputer to other HP 21MX computers or to link it upwards to a central computer.

*For a video tape demonstration of the HP-IB/21MX, check the  on Item A of the HP Reply Card.*

\*HP-IB is Hewlett-Packard's implementation of IEEE Standard 488 and identical ANSI Standard MC1.1—Digital Interface for Programmable Instrumentation.

*For more information on how these systems can help you gain management control over your automated testing, check A on the HP Reply Card.*



# Build your own automated test system easier and faster with the HP-IB

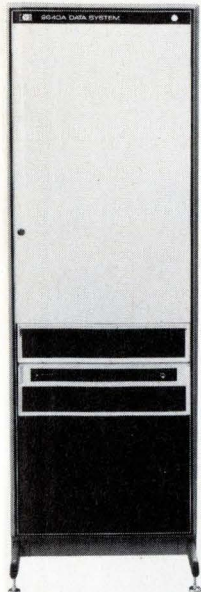

**Multiple Instrument Clusters**  
Each independent cluster of up to 14 instruments is connected to the 21MX Minicomputer via a separate HP-IB interface cable.

**Add New Clusters Easily**  
With on-line configuration capability, new independent instrument clusters can be added or changed without downtime or effect on existing clusters. Programming test procedures are simple BASIC "PRINT/READ" or FORTRAN "WRITE/READ" statements.

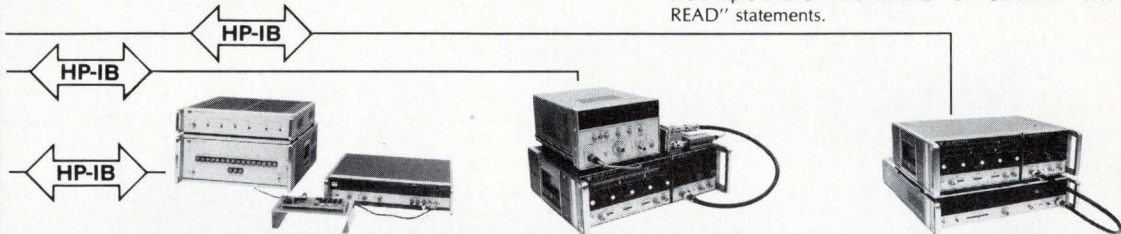

**Component Test Clusters**  
A monolithic DAC is tested with an HP multiprogrammer and digital voltmeter.

**Subassembly Test Cluster**  
At the same time, C-band microwave amplifiers can be tested with a sweep oscillator and an RF power meter.

**Instrument Test Cluster**  
And, at the same time, a sweep oscillator can be tested with a frequency counter.

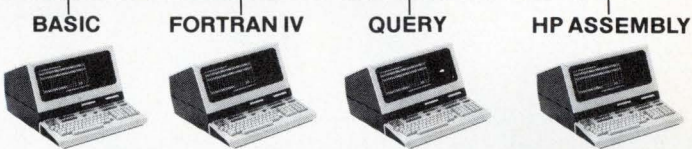

**New Real-Time HP-IB/21MX Minicomputer**  
The HP-IB/21MX Minicomputer which automates test/measurement procedures, and permits concurrent program development and data retrieval consists of a 21MX Minicomputer and cartridge disc memory, managed by HP's RTE-II or RTE-III Real-Time Executive software.  
*For more information on the Real-Time HP-IB/21MX Minicomputer, check A on the HP Reply Card.*

**Multiple Terminals for Concurrent Program Development or Data Base Access**  
The Real-Time HP-IB/21MX Minicomputer, with new IMAGE/1000, permits fast multi-lingual program development or data access by several users simultaneously.

**Computer Network Connections**

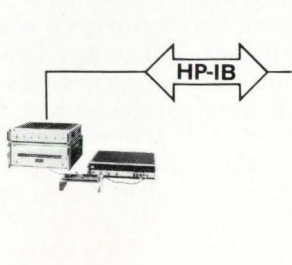

**Incoming Inspection Satellite**  
A remote HP-IB/21MX Minicomputer in the nearby Incoming Components Inspection Department consolidates test data via the network connection system.

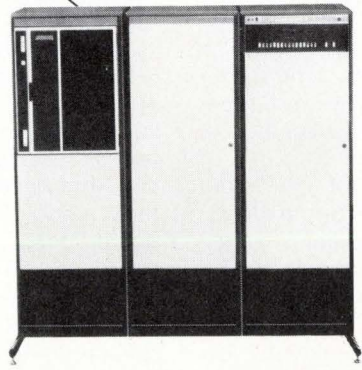

**Central EDP**  
HP supported hardware and software connect the HP-IB/21MX Minicomputer to other 21MX Minicomputers or IBM 360/370 in a distributed management information network.



## HP computers, calculators and the Interface Bus aid in the analysis of samples from Mars

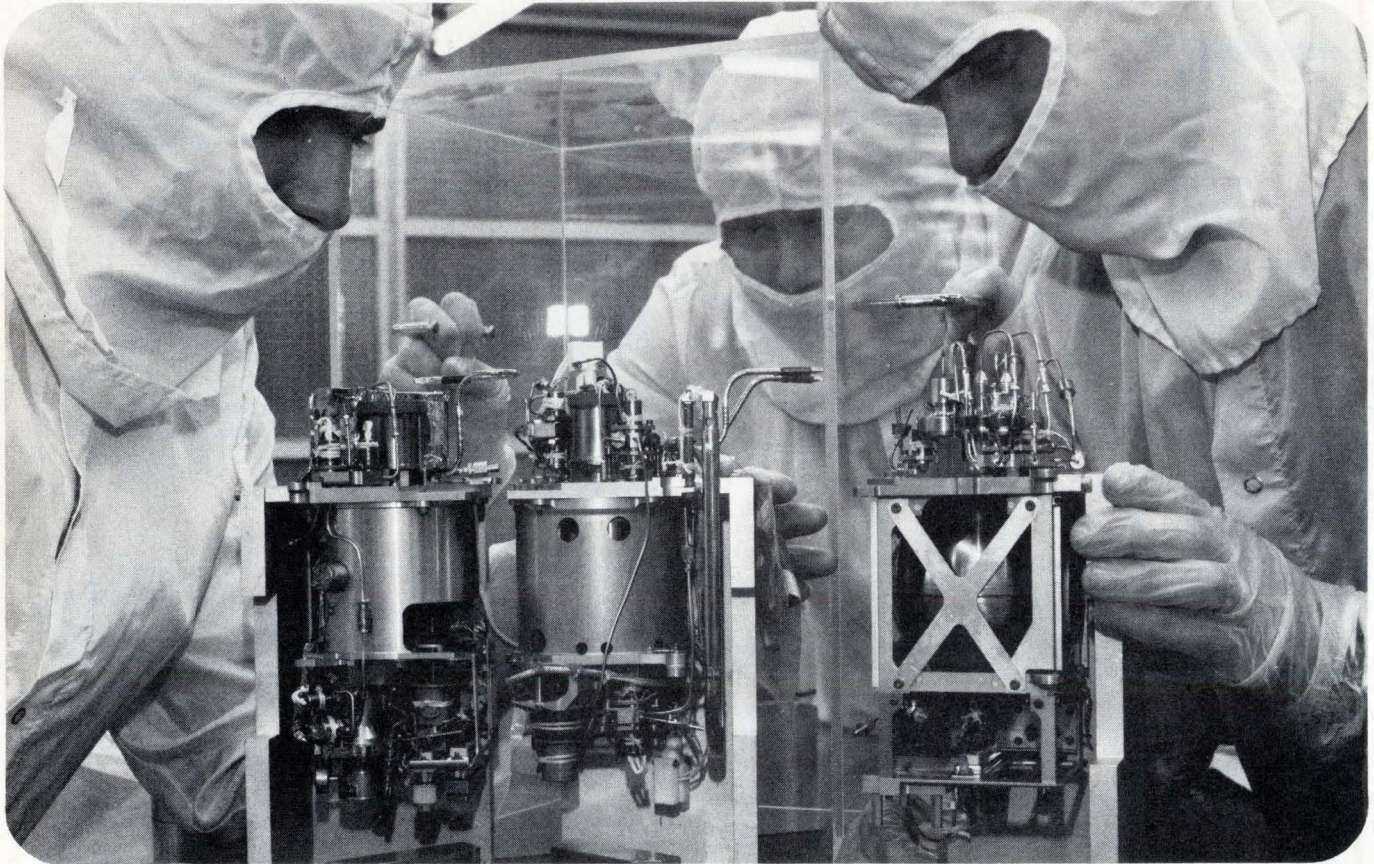

### HP-IB

TRW's advanced technology is being applied this summer when a computerized life detection instrument package probes for life on Mars. The HP Interface Bus has contributed significantly to the development of testing programs at TRW.

At the TRW Space Park facility in Redondo Beach, California, precise measurement and testing is a critical aspect of the company's activities. As a designer and manufacturer of scientific military and commercial spacecraft systems, the Defense and Space Systems Group relies on 25 HP 2100/21MX computer-based Scientific and Measurement Systems for engineering and manufacturing testing.

Don Broutt, manager of TRW's automatic test systems department, adopted the Hewlett-Packard Interface Bus (HP-IB) to link numerous test instruments to his HP computers and HP calculators.

"Many of our programs involve extremely limited production runs . . . some products, for example, are one of a kind. Before adopting the interface bus, our efforts to reestablish test stations for

each program was like reinventing the wheel. Now, when setting up a new test station with the HP-IB, we can easily add or reconfigure instruments in a computerized network with minimal set up time," explains Broutt.

With improved flexibility comes cost savings, according to Broutt. Prior to adopting the HP-IB, testing required specially engineered printed circuit board interfaces for each unique test device. If a device served as both a "listener" and "talker," it required two boards. Now, one board within a computer allows interfacing with up to 14 devices that meet the IEEE-488 standard. A single standard cable now replaces specially-engineered cables formerly required for each test instrument.

"In our pre-HP-IB testing, we wrote special driver software for each unique device. This consumed excessive

amounts of computer memory. Now our engineers simply use a subroutine for each device to access an HP-IB standard driver. Gone is time-consuming reference to handbooks for device translation. Once a subroutine is written, the device interface is transparent to our engineers," relates Broutt.

With the growing availability of test devices using IEEE-488 and the expanding use of the HP Interface Bus, TRW has reduced the cost of interface design. Manpower and resources formerly allocated to this function can now be applied to other priority projects.

*For more information on how HP computers in conjunction with the HP-IB can help you, check A on the HP Reply Card.*



## New HP display station: extensive stand-alone capability plus data communications flexibility

The HP 2645 display station is the latest and most powerful addition to Hewlett-Packard's growing family of general-purpose, interactive display terminals.

Keyboard use is simplified by eight user-defined soft keys, each of which can be set up to issue a string of up to 80 characters or several control sequences stored in the terminal. You can simply press a key to trigger file searches, issue operator or computer instructions, dynamically configure the terminal, or perform other specialized tasks.

The 2645 is compatible with a wide variety of computer systems. It can operate at selectable speeds of up to 9600 baud, and has the optional capability of asynchronous or synchronous (BISYNC) multipoint polling with up to 32 terminals on the same line. This makes possible the sharing of modems, data lines, and computer I/O channels with significant savings in data transmission costs. Built-in self test ensures proper operation within a network.

Up to four 128-character sets can be viewed concurrently on the high-resolution display.

Optional, highly reliable cartridge tape transports provide 220,000 bytes of mass data storage, allowing the 2645 to batch information and to perform many operations on a stand-alone basis that normally require connection to a computer.

For more information on these products, check J on the HP Reply Card.



Data handling capabilities of new terminal include protected fields, numeric/alpha field checking and off-screen storage up to 12 kilobytes.

## NEW Digital Test System enables production testing and test programming concurrently

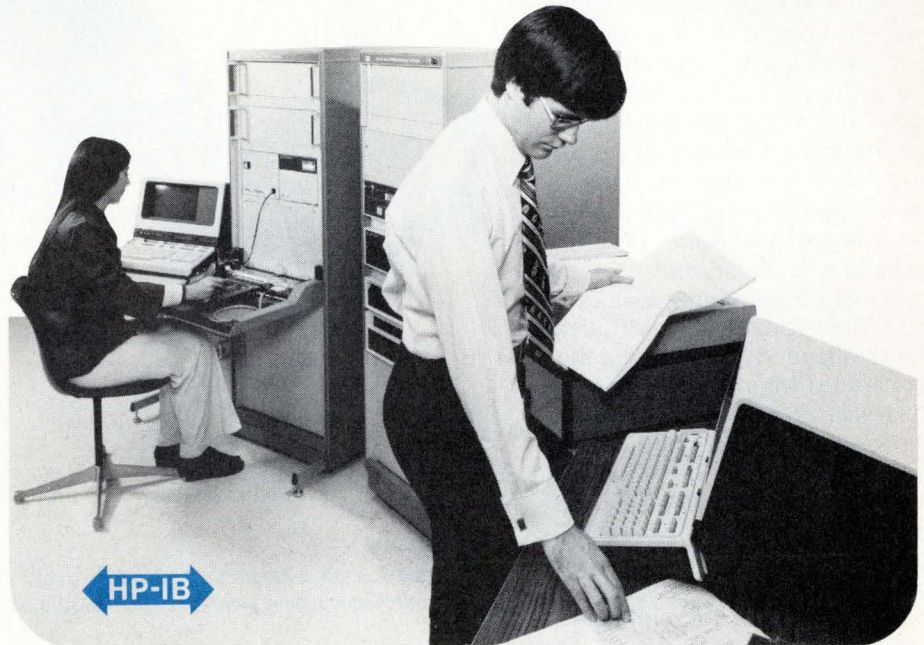

Because of their increasing complexity and density, testing of logic circuit boards today is a major element in manufacturing costs. The use of manual or semi-manual fault location techniques on loaded logic boards costs precious troubleshooting hours.

The new Hewlett-Packard Digital Test System, DTS-70, offers printed circuit logic board manufacturers versatile capabilities that will result in improved test quality and high throughput.

A system consists of three elements, an HP 9571A Test Station, a 21MX minicomputer-based controller, and the HP 91075B TESTAID-III Test Generation Software. The HP 9571A test station handles logic assemblies to 200 MSI-type IC's (10,000 gate equivalents).

Go/no-go testing on the DTS-70 is fast—typically a few seconds for moderately large boards. Fault isolation using the computer-assisted FASTRACE guided probe is accurate and quick, typically locating the fault in less than a minute. When the fault is located, the fault data is automatically displayed on the CRT terminal and printed on hard copy by an optional repair ticket printer. The test operator attaches the repair ticket to the PC board so the fault data is

available at the rework/service area.

An important feature of the DTS-70 is the ability to *concurrently* write and edit test programs at the test preparation station while production testing continues on the HP 9571A test station. Test programs are prepared using TESTAID-III, an advanced digital logic simulator. In addition to interactive program preparation on-line, TESTAID-III can have all controls preloaded into it for unattended or overnight operation, thus maximizing personnel and computer efficiency.

Designed to accurately test large numbers of complex logic assemblies, up to three HP 9571A test stations can be operated from one controller in the system. Add-on stations can usually be installed in less than two hours.

The system uses the Hewlett-Packard Interface Bus to provide control for analog functions: dc voltage measurements, frequency, time interval, power supply programming for units under test, and to control other system devices.

For more information, check D on the HP Reply Card.



## New 200 Watt extended range DC power supply

The new HP 6002A power supply can provide a full 200 Watts output over the range from 20 Volts to 50 Volts. Output voltage is continuously adjustable from 0 to 50V while the maximum current available is automatically controlled to maintain a 200 watt maximum power boundary.

Lab grade performance is provided for general purpose research, design, and production applications.

An optional programming feature (Option 001) is available for controlling the output voltage (or current) via the Hewlett-Packard Interface Bus—either by calculator or computer. Switches on the rear panel of the 6002A allow either local front panel control, HP-IB controlled voltage, or HP-IB controlled current. A programmable range allows a 5 $\times$  improvement in resolution when the 6002A is operated below 10 volts.

The power supply operating status is continuously shown by front panel indicator lights which reduce the need to interpret meter readings. Additional lights also identify overrange and overvoltage conditions. The overvoltage protector is a front-panel adjustable SCR type "crowbar". Ten-turn controls permit accurate adjustment of output voltage and current when the supply is operating under local control.

For more information, check N on the HP Reply Card.

With HP-IB option, the new 6002A power supply can be digitally controlled using your calculator, computer or other controller.



HP-IB

## Highest power yet for microwave sweepers



High power output sweepers are especially useful in such applications as local oscillator driving mixers or for stimulating antennas when making pattern measurements.

Close-up of 5.9 - 12.4 GHz GaAs MESFET Amplifier used in new Hewlett-Packard sweeper plug-ins to deliver 50 mW leveled RF output.

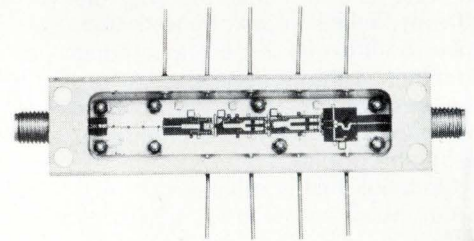

Two new RF plug-ins for the HP 8620C Sweep Oscillator capitalize on Gallium-Arsenide technology to deliver at least 50 mW of leveled power in the frequency ranges, 5.9 - 9.0 GHz and 8.0 - 12.4 GHz. These are highest power levels ever offered in solid-state sweepers—and higher than most backward wave oscillator (BWO) tube-type sweepers as well. Key to this achievement is a broadband power amplifier developed by Hewlett-Packard that typically delivers 100 mW output over a 5.9 - 12.4 GHz range with 10 dB nominal gain. The amplifier employs 1  $\mu$ m Gallium-Arsenide Schottky-Gate Field Effect Transistors (GaAs MESFET).

The extra power is achieved without sacrificing other RF performance characteristics (such as frequency accuracy, linearity, stability, and residual FM). Harmonics are at least 30 dB below full rated output, non-harmonic spuri-

ous >60 dBc, and optional internal leveling to  $\pm 1/2$  dB is offered.

Using high power sweepers, it is often possible to eliminate additional amplification when performing saturation tests or high loss measurements. Higher power also permits padding to isolate test devices from source and detector for better matching leading to more accurate measurements. The new plug-ins accept direct modulation from the HP 8755 Frequency Response Test set which allows a full 60 dB measurement dynamic range even with padding for best match.

Model 86242C covers 5.9 - 9.0 GHz and HP 86250C covers 8.0 to 12.4 GHz.

For additional data, check P on the HP Reply Card.



## The world's first rectangular solid-state lamp

Rectangular solid-state lamps in three colors (high efficiency red, yellow and green) are now available from Hewlett-Packard. This is the first solid-state lamp in this configuration to be offered to the market place. The configuration of this lamp makes it ideal for lighted mechanical switches, flush-mounted panel indicators, backlighting, bar type scale indicators, or minus indicators in digital displays.

The 5082-4570, 4670, and 4970 are encapsulated in an axial lead rectangular epoxy package. They utilize a tinted epoxy with a thin, uniform segregated diffused layer at the emitting surface to provide a high on/off contrast plus a uniform light emitting area.

Dimensions of the flat light emitting surface are 2.54 mm (0.10") by 7.49 mm (0.295"). The axial luminous intensity for the red lamp is 1.0 mcd typical; for the yellow and green, it is 1.2 mcd

## New rugged one micron GaAs FET chip

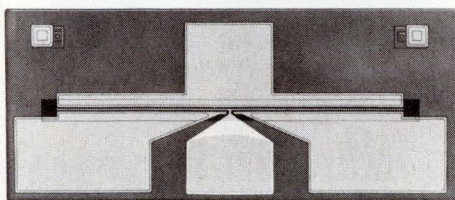

New chip available for applications in telecommunications, radar and EW amplifiers in the 1-12 GHz frequency range.

The HFET-1000 is a GaAs FET chip designed for low noise figure (3.6 dB typical); high gain (11.0 dB); and a high dynamic range of 14.5 dBm linear power output at 10 GHz.

The .065 x .028 mm chip is provided with a dielectric scratch protection layer over the active area. Gate width is 500 micrometers resulting in a typical linear output power greater than 25 mW.

For additional technical data, check E on the HP Reply Card.

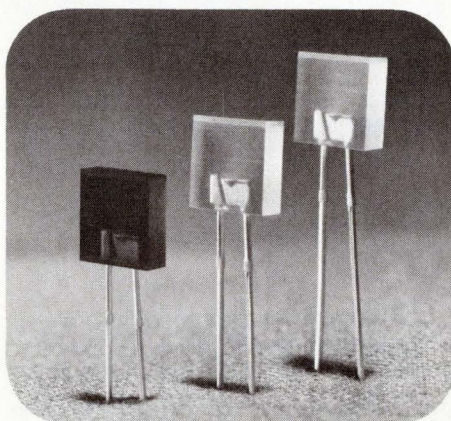

New rectangular LED lamps are ideal for flush mounted panel indicators.

typical. The typical operation forward current is 15 mA for the red and yellow; and 20 mA for the green.

For technical information, check L on the HP Reply Card.

## Fastest microwave switch—guaranteed 5 ns rise time

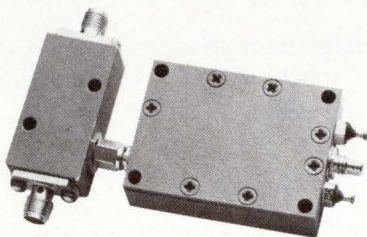

Output connector of new fully TTL compatible switch driver (right) mates with the SMC connector on the new HP fast PIN diode switch.

HP offers the new 33140/33640 series SPST switches for operation from 0.1 to 18 GHz. Rise time is 5 ns; fall time is 7 ns. Isolation up to 80 dB is available.

Designed especially to drive these 33140 series switches, the HP 33190A TTL compatible switch driver can be used to improve the switching time of any SPST diode switch.

For further information, check H on the HP Reply Card.

## 670 nm high intensity emitter simplifies optical alignment

Now available from Hewlett-Packard is a visible, near-IR, source using a GaAsP on GaP LED chip which has been optimized for maximum quantum efficiency at 670 nm. The emitter's beam is sufficiently narrow to minimize flux problems, yet broad enough to simplify optical alignment.

The HEMT-3300 is designed for consumer and industrial applications such as optical transducers and encoders, smoke detectors, assembly line monitors, small parts counters, paper tape readers and fiber optic drivers.

This device comes in a standard T-1 $\frac{3}{4}$  configuration with an undiffused, un-tinted plastic lens. The axial radial intensity is typically 500 mW/sr at 10 mA.

For further specifications, check M on the HP Reply Card.

IR emitter in a T-1 $\frac{3}{4}$  package optimized for 670 nm emission.

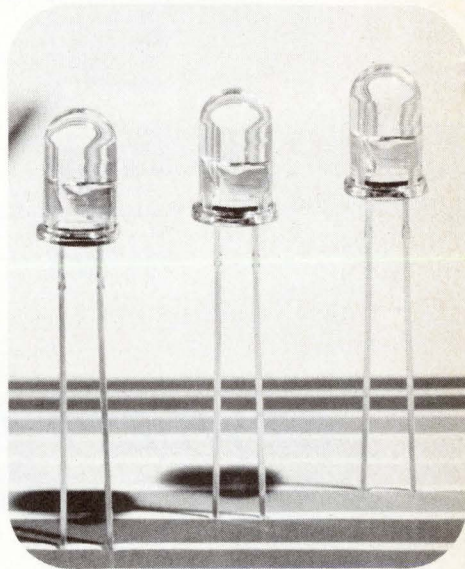



## Now, more memory—for less money

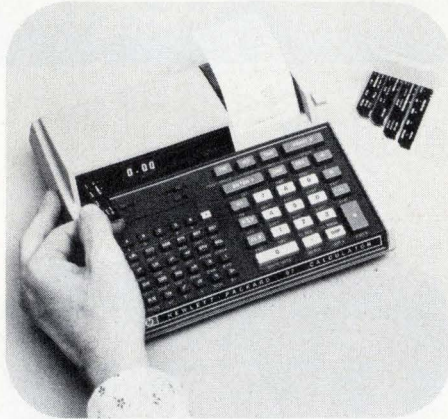
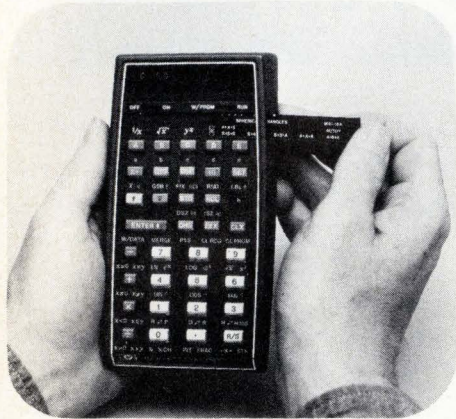

The HP-67 and HP-97 are the most powerful personal calculators Hewlett-Packard has ever built. The HP-67 (left) gives you shirt-pocket portability. The battery-powered HP-97 (right) gives you attaché case compactness plus a quiet built-in thermal printer.

Two new HP calculators, the HP-67 and the HP-97, have more than three times the program capacity of the first HP magnetic card-reading calculator—the HP-65—and at a lower cost. But there's more to evaluating programming capacity of a calculator than just merely comparing the 100 steps of the HP-65 to the 224 steps in both the HP-67 and the HP-97.

The factor of three times the *increase in capacity* is specified because *all* functions, whether one, two, or three keystrokes long, use only one step of program memory.

Now, for the first time, you can transfer information from either side of the magnetic card into the data registers, or record data from the registers to the magnetic card.

A significant operational improvement of the HP-67/97 is the "smart" card reader. In addition to data recording and reading, the card reader serves as a prompter for proper operation. It automatically checks and retains the display mode, angular mode setting and status of the four flags. It also detects whether information on the card consists of data for the storage registers or program steps. You will find it virtually impossible to improperly load programs or data from the cards.

There are many more powerful features including 10 user-definable functions, 10 conditional/decision functions and three types of addressing.

For more information on the HP-67 and HP-97, check B on the HP Reply Card.

## Calculator that remembers, even when turned off

The HP-25C is the first HP scientific programmable pocket calculator that retains stored programs and data even when it is turned off. The HP-25C with continuous memory is otherwise identical in performance to the HP-25A.

With the keystroke programmability of the HP-25A or HP-25C, you can solve automatically the repetitive problems faced by scientists and engineers.

Both have 49 steps of program memory with merged keycodes and 72 built-in scientific, engineering and mathematical functions and operations, including full editing capability, register arithmetic and several conversions.

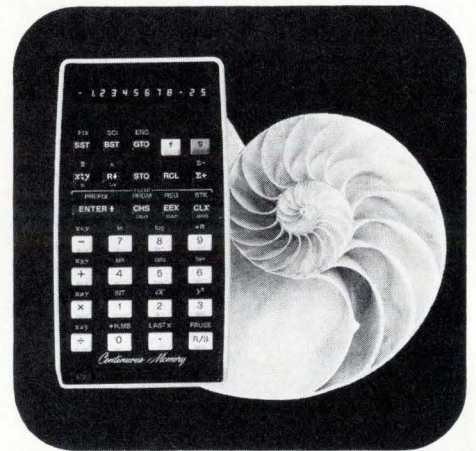

For further details on both calculators, check C on the HP Reply Card.

East-4 Choke Cherry Road, Rockville, MD 20850  
Ph. (301) 948-6370.

South-P.O. Box 10505, Atlanta, GA 30348  
Ph. (404) 434-4000.

Midwest-5500 Howard Street, Skokie, IL 60076,  
Ph. (312) 677-0400.

West-3939 Lankershim Blvd, North Hollywood, CA  
91604, Ph. (213) 877-1282.

Europe-7, rue du Bois-du-lan, P.O. Box, CH-1217, Meyrin-2,  
Geneva, Switzerland, Ph. (022) 41 54 00.

Canada-6877 Goreway Drive, Mississauga, Ontario,  
L4V 1M8, Ph. (416) 678-9430.

Japan-Yokogawa-Hewlett-Packard Ltd., Ohashi  
Bldg., 1-59-1 Yoyogi, Shibuya-ku,  
Tokyo 151, Ph. 03-370-2281/92.

**HEWLETT**  **PACKARD**

Sales and service from 172 offices in 65 countries.

**MEASUREMENT COMPUTATION NEWS**  
innovations from Hewlett-Packard

September/October 1976

New product information from  
**HEWLETT-PACKARD**

Editor: Iona M. Smith

Editorial Offices:  
1507 Page Mill Road  
Palo Alto, California, 94304 U.S.A.



# CAUTION: 50,000 VOLTS



## LET ERIE DESIGN and BUILD YOUR HIGH VOLTAGE POWER SUPPLIES and VOLTAGE MULTIPLIERS

When you talk about designing and packaging miniature, low current High Voltage Power Supplies and Voltage Multipliers, the name ERIE should come to mind first. Why? *No other manufacturer of these sophisticated devices has its own capacitor and rectifier technology in-house.* Only ERIE does it all. Our many years experience in producing State of the Art high voltage capacitors and high voltage silicon rectifiers — plus an unsurpassed technology in circuit designing, packaging and encapsulation, makes ERIE an ideal source for your high voltage component needs. From very low input voltages, ERIE can produce output voltages up to 50,000 volts. Application for these compact, high reliability devices includes night-vision image intensification systems. Apollo TV cameras. CRT displays. Avionics systems exposed to rugged environments. Industrial, commercial and military equipments . . . an almost infinite variety of applications. So bring ERIE in early. Let us design and build *your* High Voltage Power Supplies and Voltage Multipliers. We're equipped to handle large or small volume orders . . . in-house.

Write for our 32-page catalog . . .  
High Voltage Components and  
Devices . . . or for technical  
assistance, call  
613/392-2581

ERIE TECHNOLOGICAL PRODUCTS, INC.  
Erie, Pennsylvania 16512

**ERIE**

Circle 27 on reader service card



# In-circuit emulation product can do while

The dream of design engineers is to develop, debug, and integrate hardware and software in their actual product environment—from day one. Thereby dramatically shortening the development time—and development cost—of their microcomputer-based products.

The Intellec® microcomputer development system makes the dream a reality. Because the Intellec system has everything you need to design microprocessor based products using Intel® 8080, Series 3000 and future Intel microprocessors.

You reverse the traditional product development flow which postpones hardware/software integration until late in the development cycle. Move from concept through design, system integration and debugging to production in a fraction of the time normally required.

With ICE-80 and ICE-30 Intellec's in-circuit emulation modules, you exercise your complete hardware/software prototype under control of high level diagnostic software. ICE-80 plugs into the 8080 socket in your prototype system and runs it in real time. Under Intellec system control, you single-step your system program, using Intellec's memory and I/O as though they were part of the prototype system. Powerful debug functions are extended into your system and you can examine or modify your system memory or Intellec memory using symbolic references instead of machine addresses.

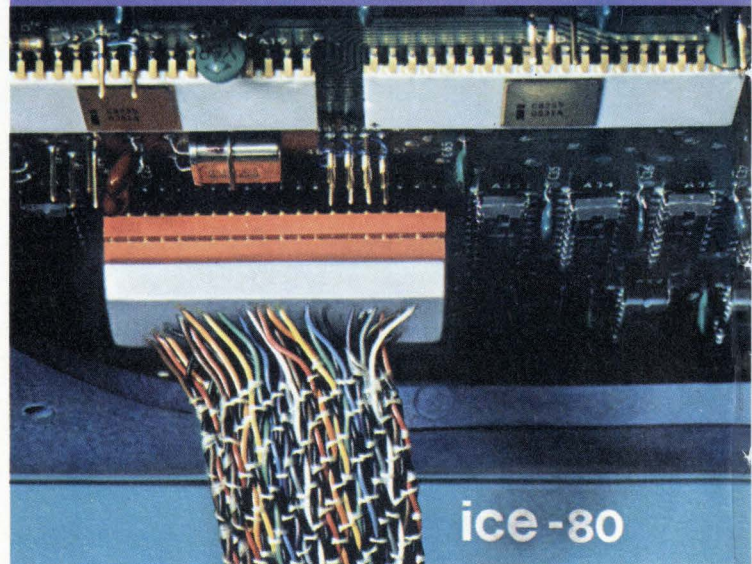
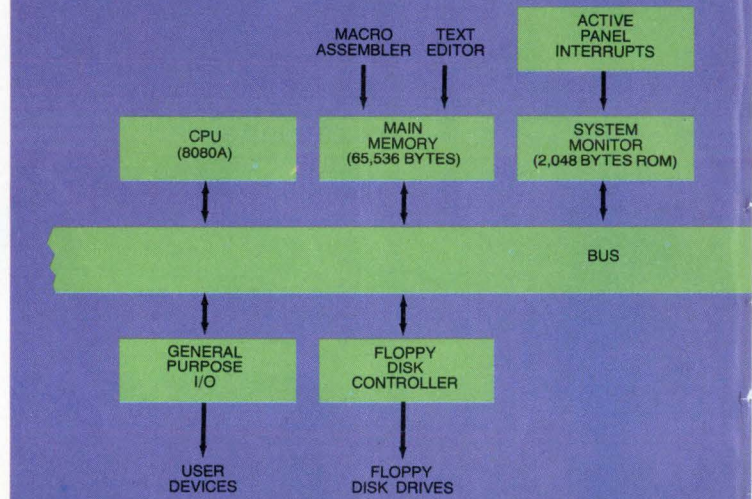
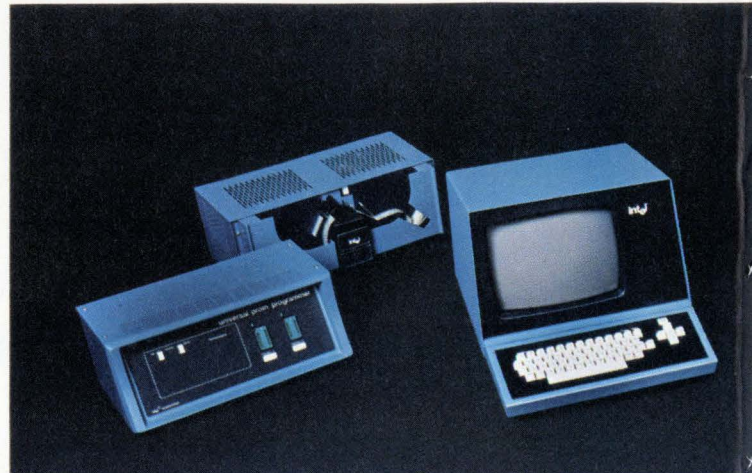



# lets you see what your it's still on the bench.

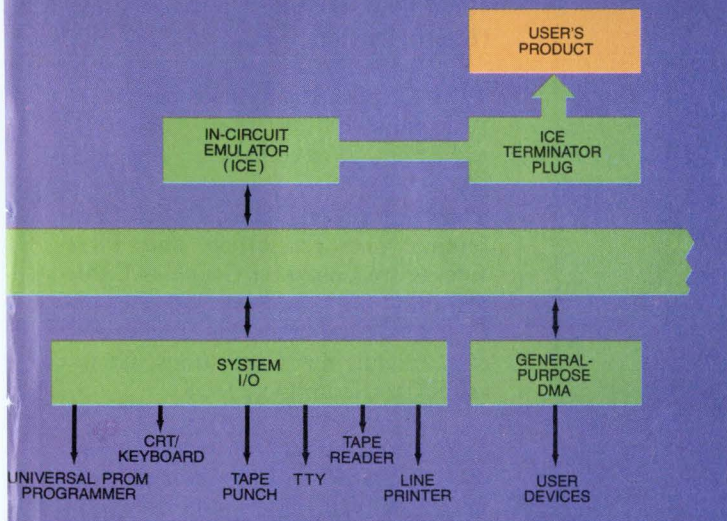
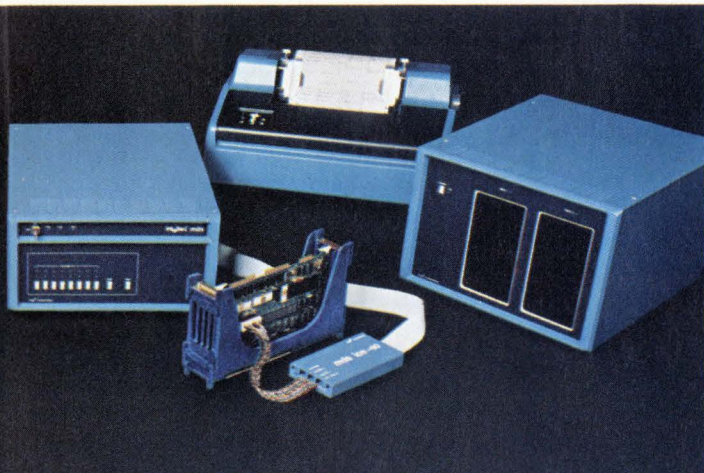

```
*GO FROM START UNTIL RSLT WRITTEN
EMULATION BEGUN

*DISPLAY CYCLES
STAT-ADR-DATA STAT-ADR-DATA STAT-ADR-DATA S
A2H-1326H-CDH 82H-1327H-E3H 82H-1328H-01H 0

*CHANGE DOUBLE REGISTER SP=13FFH
*BASE HEX
*EQUATE STOP=1333H
*GO FROM START UNTIL STOP EXECUTED THEN DUMP
EMULATION BEGUN
B=01H C=41H D=00H E=00H H=00H L=00H F=56H A=
```

The Intellec system includes its own 8080 processor, memory, and a full range of peripherals designed to ease your development task. These include diskette operating system, CRT/keyboard, line printer, universal PROM programmer, high speed papertape reader, the in-circuit emulation modules, (ICE-80 and ICE-30) and interfaces for teletypewriter and high speed tape punch.

Under Intellec software you assemble, edit, execute and debug programs quickly. The diskette-based operating system, ISIS, performs all your program and file management tasks automatically. A wide range of system commands gives you complete control of your prototype, including the ability to set multiple hardware and software break point conditions.

The Intellec system provides the convenience of a complete in-house development system, backed with the quality support, service, training, and documentation you expect from the company that is the leader in microprocessor systems development. And the Intellec system is available for immediate delivery.

If you've always wanted to see how your product works while it's still on the bench, experience an Intellec system for yourself. For a demonstration or for technical information use the reader service card or write: Intel Corporation, 3065 Bowers Avenue, Santa Clara, California 95051.



Microcomputers. First from the beginning.



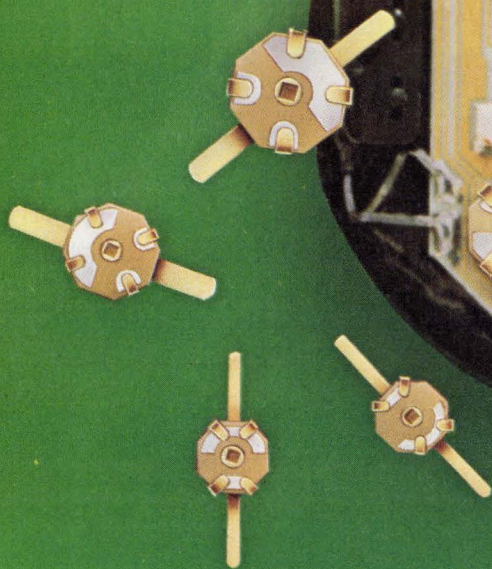

# Thin-Trim<sup>®</sup> capacitors

Tucked in the corner of this Pulsar Watch is a miniature capacitor which is used to trim the crystal. This Thin-Trim capacitor is one of our 9410 series, has an adjustable range of 7 to 45 pf, and is .200" x .200" x .050" thick.

The Thin-Trim concept provides a variable device to replace fixed tuning techniques and cut-and-try methods of adjustment. Thin-Trim capacitors are available in a variety of lead configurations making them easy to mount.

A smaller version of the 9410 is the 9402 series with a maximum capacitance value of 25 pf. These are perfect for applications in sub-miniature circuits such as ladies' electronic wrist watches and phased array MIC's.

Johanson Manufacturing Corporation  
Rockaway Valley Road  
Boonton, New Jersey 07005  
(201) 334-2676 TWX 710-987-8367

## Meetings

**Semicon/East '76**, Semiconductor Equipment and Materials Institute (Golden Gate Enterprises, Santa Clara, Calif.), Nassau Veterans' Memorial Coliseum, Uniondale, N.Y., Sept. 21 - 23.

**Broadcast Symposium**, IEEE, Washington Hilton Hotel, Washington, D.C., Sept. 22 - 24.

**EASCON—Electronic and Aerospace Systems Convention**, IEEE, Stouffer's Inn, Washington, D.C., Sept. 26 - 29.

**MICRO-9—Ninth Annual Workshop on Microprogramming**, IEEE and ACM, Delta Towers Hotel, New Orleans, Sept. 27 - 29.

**Quality Testing Show**, American Society for Nondestructive Testing (Columbus, Ohio), Shamrock Hilton Hotel, Houston, Tex., Sept. 28 - 30.

**1976 Ultrasonics Symposium**, IEEE, Annapolis Hilton Inn, Annapolis, Md., Sept. 29 - Oct. 1.

**Third European Electro-Optics Conference and Exhibition and First Interactive Computer Graphics Exhibition**, IEEE, Society of Photo-Optical Instrumentation Engineers, *et al.*, Palais des Expositions, Geneva, Switzerland, Oct. 5 - 8.

**Symposium of the National Conference of Standards Laboratories**, National Bureau of Standards, Gaithersburg, Md., Oct. 6 - 8.

**Military Electronics Defence Expo '76**, Industrial & Scientific Conference Management Inc. (Chicago, Ill.), Rhein-Main-Halle, Weisbaden, Germany, Oct. 6 - 8.

**International IEEE/AP Symposium and USNC/URSI Meeting**, IEEE *et al.*, University of Massachusetts, Amherst, Mass., Oct. 10 - 15.

**ISHM International '76**, International Society for Hybrid Microelectronics (Montgomery, Ala.), Hotel Vancouver, Vancouver, B.C., Canada, Oct. 11 - 13.





# The keyboard switch with a heart of gold

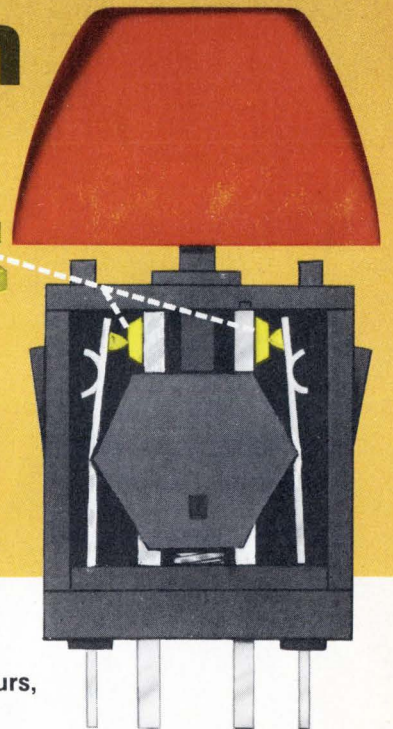

## ...keeps your product WORKING year after year...after year.

In your keyboard or ours,

Cherry key switches just don't fail. The knife-edge contact area is so small (9 millionths of a square inch) ... the contact pressure so great (about 5,000 psi) ... the gold alloy so pure and film-free ... that you are assured of positive contact every time. For 50 million operations and beyond. (Which is probably beyond the life expectancy of your product!)

Cherry "heart of gold" keyboard switches are available as part of a fully encoded Cherry Electronic Keyboard or individually, with or without two-shot molded keycaps. *We have keycaps* ... in more legends, sizes, type faces than you're likely to find anywhere else. Sculptured keycaps? We've got 'em. Smooth or matte finish? We've got *both*. Colors? Lighted? Specials? Sure! Some "off the shelf" ... all at prices that make it obvious why the *Cherry way* is the *economical way* to put a heart of gold in any keyboard.

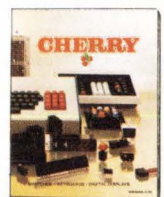

For free test sample switch and catalog, just TWX 910-235-1572 ... or PHONE 312-689-7700.

# CHERRY



CHERRY ELECTRICAL PRODUCTS CORP., 3608 Sunset Avenue, Waukegan, IL 60085

Cherry switches now available locally from distributors.

Circle 31 on reader service card



**You're looking at less  
than 5 percent of Omron's  
control components line.**

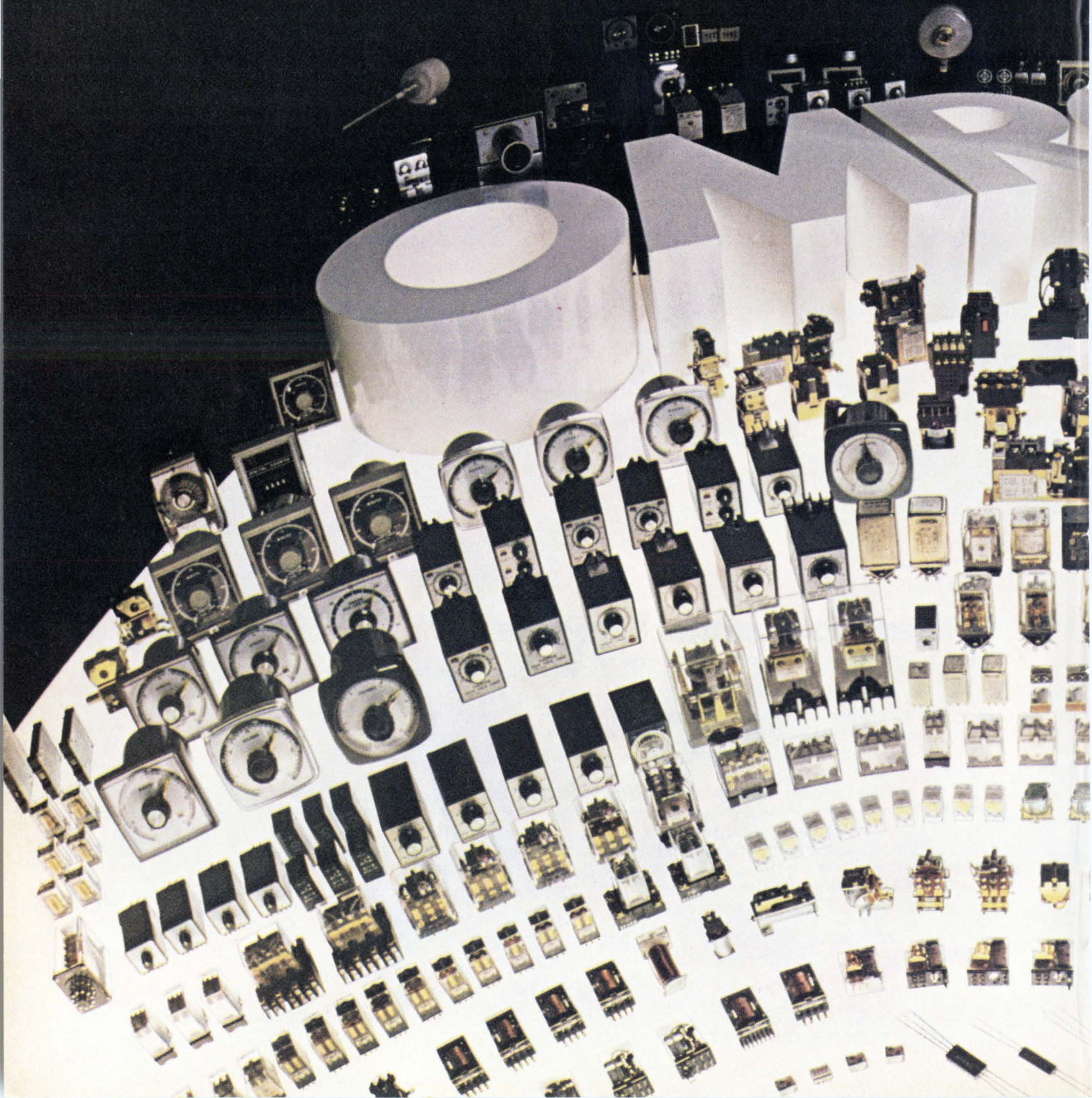



If you don't see the control component you need, maybe it's because we didn't have room for it in the photograph. Omron manufactures what is probably the largest selection of relays, switches, and timers in the world, and to show them all we'd need a 40-page ad.

What does this mean to you? It simply means that we may already have the "unique" component you need in stock. If we

do, you'll get it fast, thanks to our expanded distributor network. You'll also know you're getting a quality product: Omron has been a world leader in control components for 43 years, and our growth over the decades has been based on excellence in engineering, manufacturing, marketing, and—above all—in serving you, the Omron customer.

To find out what Omron can do for you, contact your nearest Omron distributor. Or give us a call at (312) 885-9500.



*a world leader  
in electronics  
since 1933*

Omron Corporation of America  
Corporate Headquarters  
Sears Tower, Chicago, Illinois

Sales and Service  
1051 State Parkway  
Schaumburg, Illinois 60172  
Phone: (312) 885-9500





# Get more for your money!

## Use This New 3/8" Square Cermet Trimmer From Allen-Bradley

Our new TYPE E trimmer is a high performer with a realistic price. It has some important advantages: • Immersion seal is tested in 85°C water (not 50° or 70°). • Temperature characteristic is 100 PPM/°C for stability. • Multifingered contact for excellent adjustability. • \$0.49 each—1000 piece price. For more information call your A-B distributor or write for Publication 5219.

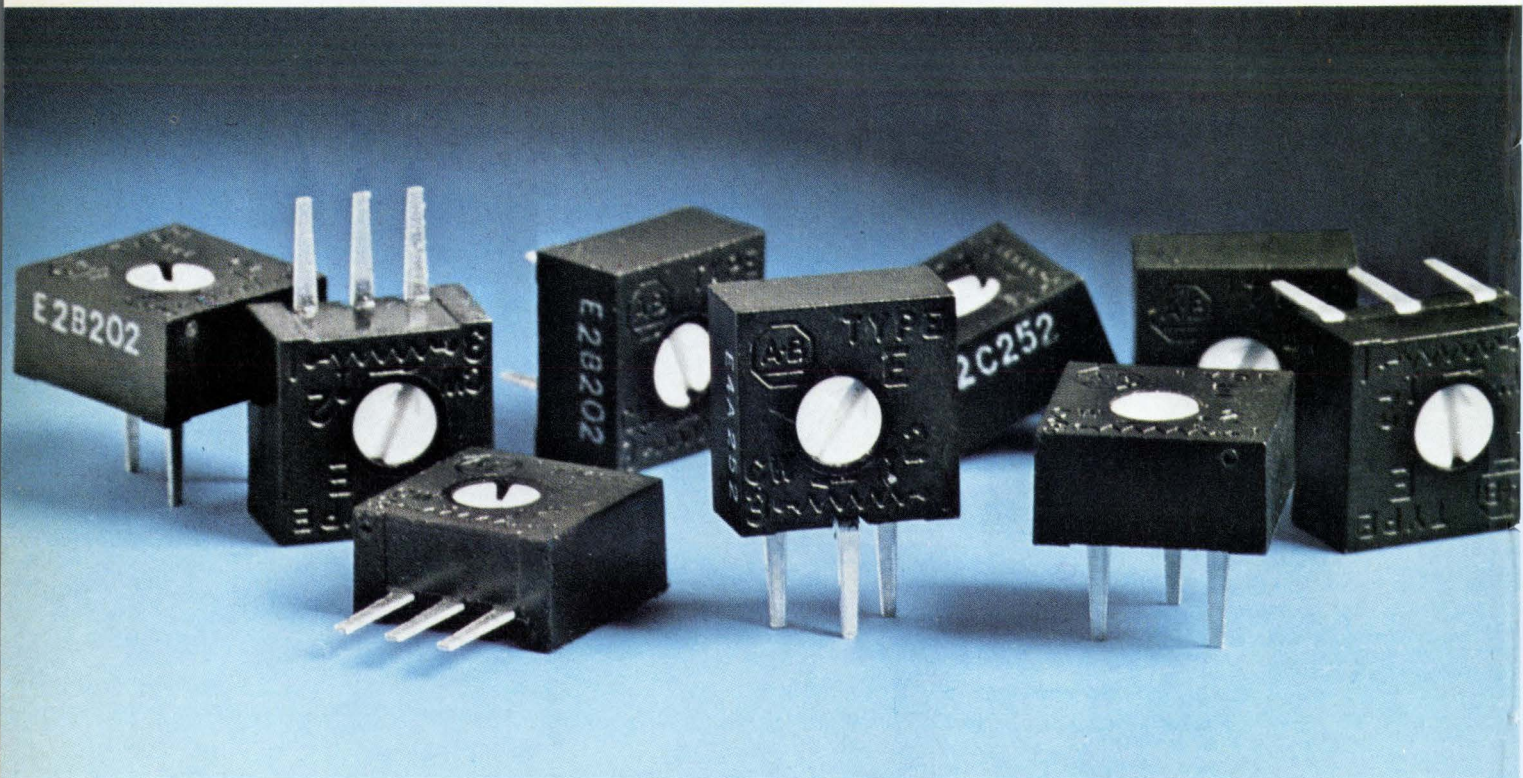
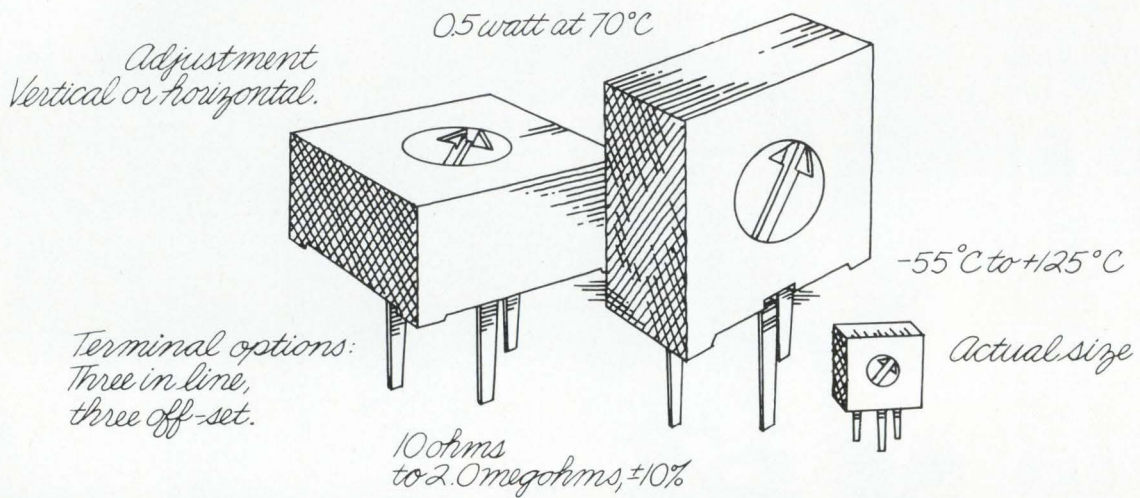

## Quality in the best tradition.



**ALLEN-BRADLEY**

Electronics Division  
Milwaukee, Wisconsin 53204



## **Philips to offer 3-model series of word-processors**

Electronics titan N.V. Philips Gloeilampenfabrieken is tossing its hat into the word-processing systems business in a challenge to IBM, Xerox, and others. Philips' entry is its WP 5000—three models that boast video display, automatic printing, and text revision and editing features. To be sold in the U.S. by Philips Business Systems Inc. in Woodbury, N.Y., under the Norelco WPS name, the three models **will have a video display unit, keyboard, high-speed printer, and pedestal unit housing data storage and processor electronics.** One version will have an IBM-compatible magnetic card reader for text storage, while the others will feature single or dual floppy-disk storage, with up to 128 pages of text capacity per disk. The WP 5000 systems will sell for approximately \$17,000, depending on options, with first U.S. deliveries set for later this year.

The standard printer is a 45-character-per-second or 540 word-per-minute two-axis daisy wheel, while the optional printer has 55-cps or 660-wpm capability. The video unit, which displays in green to minimize eye fatigue, shows 24 lines of enlarged characters and up to 125 characters per line. Automatic scrolling provides instant access to any part of the page.

## **Rms-to-dc converter on single chip ready for market . . .**

What is believed to be the first true rms-to-dc converter circuit in monolithic form is about to make its debut at Analog Devices' Semiconductor division in Wilmington, Mass. The C-MOS device [*Electronics*, Feb. 19, p. 110], housed in a 14-pin ceramic DIP, computes the root mean square of ac and dc signals with a maximum sine wave error of 2 millivolts and 0.2% at 20 kilohertz, with an input of 0 to 7 volts rms. **That error is still only 1% maximum at 100 kilohertz.**

Analog Devices engineers credit laser trimming at the wafer level as the big contributor to accuracy, and they expect makers of digital voltmeters and other instruments to be quick to adopt the circuit. It's designated the AD536, and its crest factor compensation technique allows measurements at crest factors up to seven with 1% error. (The crest factor is a measurement of the shape of a waveform; it equals the peak value divided by the true rms value of that input waveform.)

The version with tightest accuracy, the AD536K, will sell for less than \$20 in hundreds. A slightly less accurate version, the AD536J, will be less than \$10 in hundreds.

## **. . . and for use in Data Precision's digital multimeter**

The first major user of the AD536 will be Data Precision Corp., Wakefield, Mass., **in its model 248 battery-operated digital multimeter.** The 4 $\frac{1}{2}$ -digit true-rms-reading portable instrument offers a 100-millivolt full-scale range. It measures dc and ac current and voltage, plus resistance, in five ranges that each have 100% overranging. The \$345 price includes rechargeable batteries (six hours of operation), test leads, and a case.

## **Insurance group orders microNova microcomputers**

Although Data General Corp. isn't quite ready to list the customers for its microNova microcomputer family, it's known that an order for more than 100 of the boxed version of the machine has been received **from an association of independent insurance agents.** The microNova will be supplied in chip-set, single-board, and boxed configurations, [*Electronics*, March 4, p. 133], and the insurance agents will use the full machine in



intelligent terminals for local data capture and for communicating with a Data General Eclipse C-300 mainframe.

Further, a source at the Southboro, Mass., minicomputer manufacturer says there are "plenty" of chip sets on the shelf—enough, he says, to dispel any questions about manufacturability of the 225-by-244-mil chip.

## **Interdata working on microcomputer**

Maintaining its attack on the low end of the OEM computer market, Perkin Elmer Corp.'s Interdata subsidiary in Oceanport, N.J., is now **working "fast and furiously" on the development of a microprocessor-based product.** The group most recently introduced its bottom-of-the-line mini-computer system, the 5/16 single-board central processing unit. Although Interdata spokesman decline to specify details, it will be along the lines of Digital Equipment Corp.'s LSI-11 and Data General Corp.'s microNova microcomputer boards and will be introduced about a year from now.

## **HP shrinks gas chromatograph to benchtop size**

Hewlett-Packard Co.'s Scientific Instruments division will introduce this month **the first benchtop, calculator-controlled gas-chromatograph/mass-spectrometer system—the HP-5992A.** The price of \$47,500 is about half that of larger minicomputer-controlled systems of equivalent performance. The 5992A has automatic tuning, a true hyperbolic quadrupole mass filter, and a microprocessor-controlled gas chromatograph.

## **Xylogics shows LSI-11 add-on**

By adding a moving-head disk, a new system **greatly expands the storage capacity of microcomputer systems based on the LSI-11.** It will be available next month from the Xylogics OEM Components Group Inc., Burlington, Mass. Digital Equipment Corp.'s own LSI-11 based system, the 11V03, doesn't have disk storage.

Besides the LSI-11 CPU, the Xylogics system can include a 5-million-character disk drive that's expandable to 20 million characters; the disk controller; up to 28,000 words of semiconductor memory; optional line printer and other terminal controllers; power supply, and operator control. The single-quantity price of such a system is about \$15,000. Users who chose to buy the LSI-11 CPU and semiconductor memory from DEC can get the rest of the Xylogics system, called the Phoenix 145, for \$12,650.

## **Extra-low-frequency messages heard by missile subs**

Messages transmitted in the extremely-low-frequency range as part of the Navy's Project Seafarer have been received and decoded **on at least two occasions by submerged ballistic-missile-firing submarines** on shakedown cruises. The achievement marks the first operational success of GTE Sylvania's Seafarer propagation validation system receivers.

The Seafarer program, formerly called Project Sanguine, is the Navy's effort to use extra-lf communications so that submarines need not approach the surface to receive messages and so run the risk of possible detection. Successful tests have been made with submerged submarines, not with missile-firing vessels under operational conditions. The submarines receiving the first such messages were the USS Stonewall Jackson and the USS von Steuben, both operating in the Atlantic.



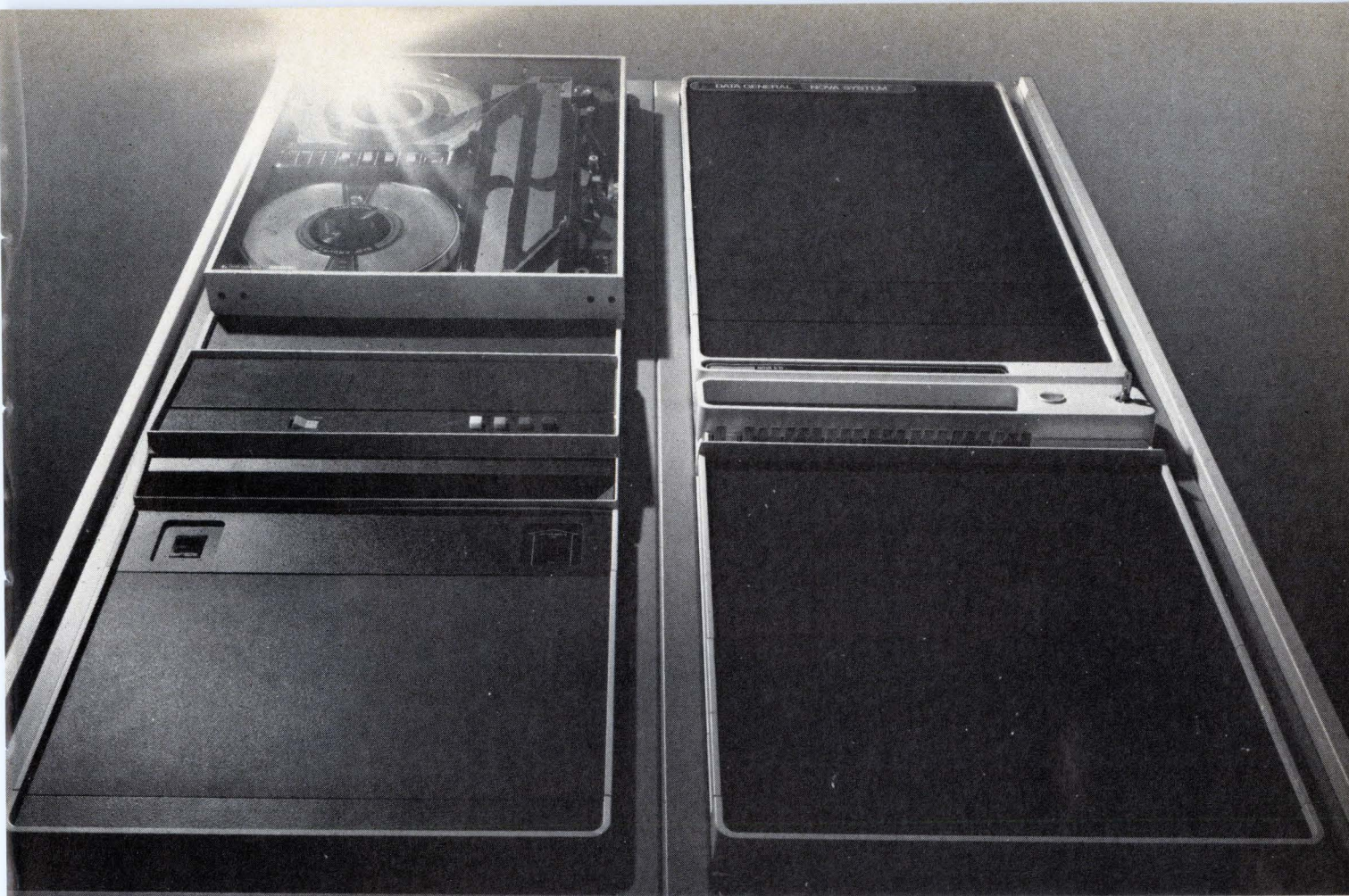

## Announcing a giant increase in the NOVA line.

Towering above is the new top of the NOVA® line.  
The NOVA 3/D.

It features a new Memory Management and Protection Unit that lets you do both on-line multitasking and batch operations. Concurrently. For instance, applications that need real-time multi-terminal software and on-going program development.

Plus, the NOVA 3/D features a new, economical, 32K-word MOS memory module. Which is something no other major minimaker has.

All of which makes the NOVA 3/D more NOVA computer, at a lower price, than you've ever seen before.

What's more, the NOVA 3/D also has all the things that have made NOVA the most popular name in minicomputers.

Things like extended NOVA line instructions. Reliable high-speed MOS and economical 16K-word core memory modules.

The single-board CPU design concept Data General pioneered. The same concept that led to our removable single-board power supply module.

Plus all the other things you've come to expect from a company like Data General.

Things like field-proven, real-time operating systems: our mapped Real-time Disc Operating System, diskette-based Disc Operating System, and our Real-Time Operating System. They're compatible with the entire NOVA line of computers.

Things like high-level FORTRAN IV and FORTRAN 5, as well as easy-to-work-with extended BASIC. Also fully NOVA-line compatible.

Things like the complete and completely-compatible line of Data General peripherals. All you could ever need to put together any system you could ever need. Including 10 to 90 megabyte discs, diskettes, and our new 30 and 60 cps terminal printers.

And when you do business with Data General, you get the kind of total systems support you can only get from a major computer manufacturer. Everything from sales and systems engineering to field service, training and special systems design.

Write for information on the new NOVA 3/D. Or call your local sales office.

And see what the NOVA line is up to now.

### NOVA 3/D

# Data General

Data General, Route 9, Southboro, Mass. 01772 (617) 485-9100. Data General (Canada) Ltd., Ontario.  
Data General Europe, 15 Rue Le Sueur, Paris 75116, France. Data General Australia, Melbourne (03) 82-1361

NOVA is a registered trademark of Data General Corp.

Circle 37 on reader service card



# How To Transmit Precision Data...

## Even where Isolation is a problem

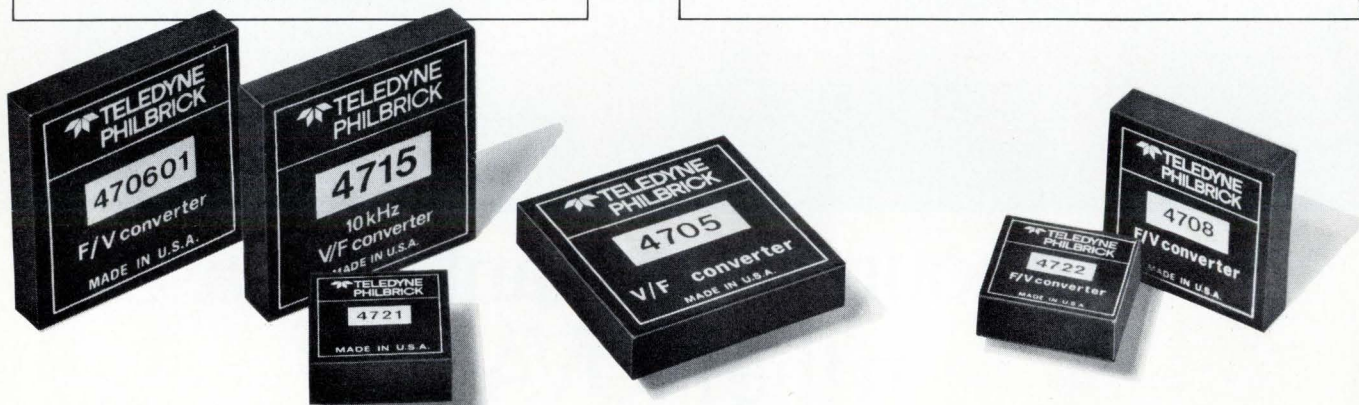
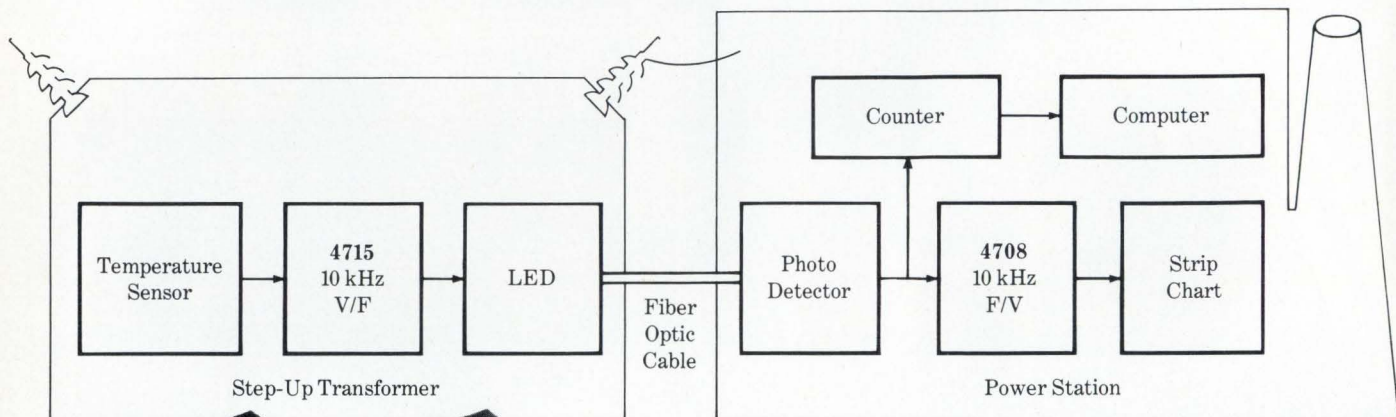

Use Teledyne Philbrick Voltage-to-Frequency and Frequency-to-Voltage Converters.

Whatever your analog data transmission application, mated pairs of TP V/F's and F/V's provide unique, cost-effective performance.

Difficult isolation problems are easily solved by connecting fiber optics, optical isolators, etc., between the V/F's and F/V's.

Just check our guaranteed V/F/V performance.

For Highest Precision, Low Frequency data, the 10 kHz 4715 series V/F's and 4708 series F/V's provide 0.005% nonlinearity, a Full Scale TC of 5 ppm/°C, and V/F operation from  $\pm 6$  V to  $\pm 18$  V power.

For Lowest Cost, use the 10 kHz 4721 V/F and 4722 F/V and still retain better than  $\frac{1}{4}$ % accuracy (without external trims).

For High Frequency data, the 1 MHz 4705 V/F and 4706 F/V (with simple offsetting)

transmit dc to 50 kHz data or sub-millisecond transients.

All V/F's accept a wide variety of voltage or current inputs while providing outputs compatible with all standard logic types. F/V's accept virtually any input wave shape or logic signal and provide any output voltage span between  $\pm 13$  Volts.

Teledyne Philbrick's leadership in V/F/V technology is available to you. A new series of V/F/V application notes can ease your design problems. Write for them today.

Teledyne Philbrick, Allied Drive, Dedham, MA 02026 — Telephone (617) 329-1600, TWX (710) 348-6726.

In Europe, Telephone 673.99.88, Telex 25881, or write 181 Chaussee de la Hulpe, 1170 Brussels.

**TELEDYNE PHILBRICK**



## Electrode matrix on skin enables blind to 'see'

Puerto Rican company has trained blind to distinguish objects with system that uses the back as retina

A system that gives "sight" to the blind is ready to be marketed, say its developers, who are under contract to the Municipal Health Department in San Juan, Puerto Rico, to establish a training facility that will teach people to use the device.

The Opticron IV, as it is called, creates images in the brain by energizing a matrix of electrodes pressed against the skin of the back, asserts Zaid Diaz, president of CID Corp. in Alto Viejo, P.R., which makes the system.

At present, though, only two people have been even partially trained to use the system. One of them, José Luis Cuezas, born blind, claims: "With the equipment, I'm able to perceive images and read. I can perceive practically everything one is able to see through a [black-and-white] TV set." He presently is reading raised, 1-inch-high letters and with more training expects to be able to read smaller letters such as newsprint.

**Walks to work.** A rehabilitation counselor at a center for the blind, Cuezas takes public transportation, then walks unaided to work. He has also walked through an obstacle course using the system. While he cannot determine color or as yet make out the details of others' faces, he is able to perceive things in motion and make out the shape and figures of objects around him, such

as furniture. "Hopefully," says Cuezas, "I'll eventually be able to see practically perfect."

Adds Ileana Villalobo, special projects director at the San Juan health department, "We believe the blind can definitely be helped." However, she cautions that work with a broad spectrum of people is needed to determine how generally useful the system is.

**Electrode matrix.** The system, which Diaz began thinking about 15 years ago, translates images into electric signals that energize a matrix of needle-like electrodes

pressed against the blind person's skin. The blind are then trained to interpret the electrode voltages in terms of visual images.

The system actually parallels that of normal sight, points out Augusto Font, a CID vice president. The skin on the patient's back substitutes for the retina of the eye, peripheral nerves for the optic nerve, and the parietal (side) region of the brain for the occipital (back) region of the brain where visual information received through the eye would normally be processed.

Visual images are picked up by a

### Other developments bring sight to blind

Electronic systems enabling the blind to "see" also are under development in the United States. Two such systems are being developed at the Smith Kettlewell Institute of Medical Arts in San Francisco and at the Biomedical Engineering Institute of the University of Utah in Salt Lake City.

The tactile conversion device at Smith Kettlewell uses four 16-by-16 arrays or 1,024 concentric coaxial electrodes on a rubber garment that fits over the abdomen. Images are sensed with a vidicon and digitized. Weighing about 5 pounds, the pulse-width modulated system furnishes a constant current at 0-60 volts.

A blind person with the vidicon attached to eye-glasses has a 90° field of view and 3" resolution, enough to locate and avoid obstacles and identify large objects, says co-developer S. Carter Collins.

In a variation of this mobile system, the abdomen is pressed against a vibrator/transducer attached to a worktable and receives signals from a vidicon attached to a microscope. Blind people with about one month's training on this equipment have performed microelectronics assembly tasks at levels equal to sighted operators, according to Collins.

At the University of Utah, data from a semiconductor camera is fed to a microprocessor held in a spectacle frame, then transmitted to an array of electrodes implanted in the brain to produce spots of light, or phosphenes, that re-create the image [*Electronics*, Jan. 24, 1974, p. 81]. Basic physiological data to determine the system's feasibility is still being gathered but, says program director Michael Mladejovsky, initial studies indicate a high degree of stability in the appearance of the visual sensations and in the current required to elicit the phosphenes.



simple pencil-sized lens worn on an eyeglass frame. They are transmitted over a fiber-optic cable to a vidicon tube housed on a chassis that also contains signal-processing circuitry and rechargeable batteries. The entire pack weighs 7 pounds and hangs from a 3-inch-wide belt worn around the waist.

**Vidicon sensor.** Black-and-white video signals from an off-the-shelf vidicon are fed to edge-enhancement digitizing circuitry. These, in turn, drive a matrix of 3,600 electrodes mounted on the inner surface of a lightweight fabric vest worn so the electrodes press against the blind person's back. The edge enhancement increases the contrast at the borders of solid objects and acts to limit the information transmitted to the brain. As he learns, however, a person can reduce the contrast from pure black and white to obtain between six and eight levels of gray scale.

The matrix of electrodes is on 18 printed-circuit boards, each with 200 electrodes in a 20-by-10 format. At the board edges are 60 more contacts that serve as ground returns. A Motorola transistor in a subminiature micro-T package is connected at each contact as an amplifier.

The voltage impressed on the skin is variable from 0 to 36 volts; normally it is set at about 6 v. Current through the contacts ranges from 20 microamperes to 20 milliamperes. Says Font, "We thought there would be a rejection process and that the voltage would have to be increased as the patients used the system. But the opposite happened, as if the brain liked the information it was getting and made the body more sensitive."

**Point minimum.** Of the 3,600 total points in the Opticron system, CID guarantees that 2,000 will operate. Says Font, "We've found the minimum number of points needed to evoke sight is 1,400. By comparison, the human eye has a resolution of 20,000 points." The points are scanned at rates between 5 and 20 frames per second.

Under a \$375,000 contract with

the city of San Juan, CID is opening a training center at the city's Municipal Health Offices, where three or four blind subjects can be trained at a time.

Says Diaz, "The training is a very complex psychological process. Normally, seeing is automatic, not conscious. We must condition the subject to do things automatically, too." According to Diaz, that requires that the subjects be taught each of the phenomena—including the presence or absence of light, motion, shape, parallax, and perspective—that make up sight.

A blind person takes about a month to become familiar with the machine. Within that month, about 60 hours are actually spent using the machine and the rest is psychological and other medical testing. When patients leave, says Font, "we've given them sight."

Including the training and Opti-

cron hardware, the price paid for each of the first 100 patients who will receive the system is \$30,000, though Font expects the price to drop dramatically as production volume and patient throughput increase. "Downstream, by the hundredth machine, we hope it will sell for \$10,000," says Font.

Other organizations are also developing seeing aids for the blind (see "Other developments bring sight to blind," p. 39). The Smith Kettlewell Institute of Medical Arts in San Francisco has a tactile device similar to the Opticron but which fits over the abdomen. It is still labeled experimental. And at the Institute of Biomedical Engineering at the University of Utah in Salt Lake City data from a charge-coupled-device camera is transmitted to electrodes implanted in the visual area of the brain [*Electronics*, Jan. 24, 1974, p. 81]. □

## Memory

### General Instrument's new 8,192-bit Earom relies on metal-nitride-oxide technology. . .

There are some big new electrically alterable read-only memories coming on the market. For one, General Instrument Corp. is this month sampling an 8,192-bit Earom. Another, Nippon Electric Co. in Japan, will begin offering samples of an 8-k device in November. The companies

are taking different approaches to building the devices that can be programmed over and over again and won't lose data when power is off.

General Instrument, as it did with earlier 1,024- and 4,096-bit devices, uses a metal-nitride-oxide semiconductor (MNOS) that relies on a sili-

### Conventional RAM has MNOS backup

Taking still another approach to nonvolatile memory, Toshiba has produced a 1,024-bit random-access memory each of whose cells includes two MNOS transistors. The idea is for the RAM, of a conventional p-channel static MOS design, to dump its contents into this built-in MNOS Earom only when it senses a falling power-supply voltage before a power failure. Unfortunately, it isn't possible to make the MNOS transistors so they'll withstand the number of read-write cycles required of a RAM during the years it must operate. But in this backup mode, they'll withstand 30 power failures a day for 10 years, Toshiba says. Previously, Toshiba had been selling a 64-word-by-4-bit memory of this kind [*Electronics*, Oct. 2, 1975, p. 44].

Being sold in Japan for the equivalent of \$13, the transistor-transistor-logic-compatible 1-k memory has a maximum read access time of 1,500 nanoseconds and a typical read access time of 800 ns. Maximum power drain is 600 milliwatts, and the typical drain is 400 mW. Next year Toshiba hopes to offer the same capacity with a maximum access time of 1,000 ns.



con-nitride layer in the gate of an MOS transistor to capture and store a charge indefinitely. This is the same approach followed by Nitron division of McDonnell Douglas Corp. which sells 1-k Earoms. Nippon Electric, on the other hand, relies on a polysilicon-MOS transistor with an insulated gate, into which the storage charge is injected. (see following story).

**In demand.** Electrically alterable memories that do not lose their data when power is off are in great demand in a wide range of television, calculator, and microprocessor-based applications. These include point-of-sales systems and telecommunications terminals in which a loss of power could mean loss of all current operating data.

Moreover, Earoms also allow a system's data to be continuously updated simply by applying voltages to the package pins. Until now, the only erasable 8-k ROM on the market was Intel's popular 2708, which is erased with ultraviolet light and therefore must be removed from the system for that operation.

Brian Cayton, marketing manager for GI's ROM products, says, "We're beginning to see interest in Earoms as replacements in small pseudo-nonvolatile memory systems now using [low-power] complementary-MOS random-access memories and battery backups."

"Our word-erasable Earoms can also be used in conjunction with high-speed RAMs as nonvolatile buffer memory in many microprocessor systems," Cayton continues. "This allows the relatively slow Earom to store that portion of data that must always be retained and lets the fast RAMs handle the bulk of the data storage. The combination offers the best of two worlds—high-speed data processing and nonvolatile safety.

GI's Earoms, including the new ER 2800 8-k part, have performance typical of today's MNOS technology: fairly slow read times of 2 microseconds at about 15 volts, which are standard p-channel MOS levels, and quite slow write and erase times, in the tens of milliseconds, at 28 v. The price is \$48 each for 1 to 24 pieces

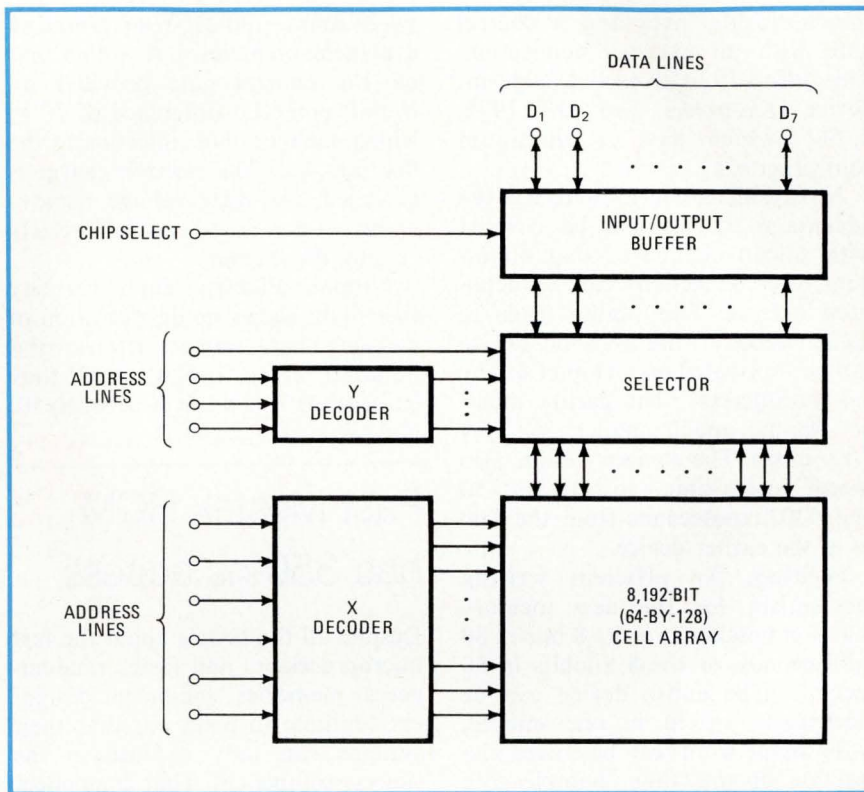

**Earom.** Block diagram of Nippon Electric's 8,192-bit electrically alterable ROM is typical of how these designs are organized with row and column addressing.

and \$27.50 each for 100 and more.

The slow Earom performance means that the new devices won't be made extensively for large ROM programs in fast microprocessor or computer systems. For such applications, they would need to operate several times faster. Nor will they impact the major RAM markets, where speeds of 200 to 300 nanoseconds and very low cost are needed. But faster Earoms are on the way. GI, for example, will soon begin distributing samples of a 4-k device that has a read time of 650 ns.

**Proprietary process.** GI's Earoms are built with a proprietary MNOS process that reduces the cell structure to a single transistor having either a split- or a tri-level gate for distinguishing between logic 1 and 0 levels. The small cell—0.1 mil<sup>2</sup>—makes possible an 8-k chip of about 22,000 mil<sup>2</sup>, or no larger than equivalent RAM chips. The method of forming the storage junction on each transistor includes use of silicon-dioxide/silicon-nitride gate insulation in a standard MOS process [*Elec-*

*tronics*, Jan. 8, p. 38].

The device's very thin (less than 50 angstroms) storage layer is essential for reliable operation. Moreover, since silicon nitride and silicon dioxide are extremely high-quality insulators, charge is trapped and stored for an extremely long period of time—GI's Earoms are guaranteed to hold their data for as long as 10 years. □

## ... as Nippon readies its design

A refinement upon an earlier design, another 8,192-bit electrically alterable read-only memory will go on sale from Nippon Electric Co. in November. It is compatible with 1,024-word-by-8-bit masked ROMs now sold by both Nippon Electric and Intel Corp, except for extra write and erase pins on the Earom.

Each memory in the new UPD458 Earom has a stack of two polysilicon gates—a floating gate buried in a



silicon-dioxide layer and a control gate with an external connection. This differs from an earlier 2,048-bit device [*Electronics*, Sept. 18, 1975, p. 56], which has an aluminum control gate.

A polysilicon control gate has the advantage that it can be covered with silicon dioxide so that aluminum interconnections can be deposited over it. This ability leads to higher density—the 8-kilobit device can be fabricated on a chip of 4.7 by 5.4 millimeters. (The earlier memory was not much smaller—4.62 by 3.12 mm.) The denser design also speeds access time—to between 450 and 600 nanoseconds from the 800 ns of the earlier device.

**Writing.** An efficient writing mechanism for the new memory makes it possible to write 8 bits in 80 milliseconds, or the 8 kilobits in 80 seconds. The entire device can be electrically erased in one minute, while single words can be erased in a fraction of this time. Samples are priced initially at \$100 each.

Like the earlier unit, the new memory differs from stacked-gate devices built by others in having a p<sup>+</sup> diffusion immediately adjacent to an n<sup>+</sup> drain, and in having a “step” built into the floating polysilicon gate. These differences, according to Nippon Electric, increase the efficiency of electron injection into the floating gate by reducing the voltages required. The higher the voltage, the greater the danger that tunneling of electrons from the floating gate to the control gate will reduce writing efficiency.

**Operation.** To write, 6 to 8 volts are applied to the substrate to prevent channel inversion. The small difference in drain-substrate voltage is sufficient to cause avalanche breakdown between the drain and the p<sup>+</sup> region. A 25-v bias on the control gate tends to aid hot electrons in reaching the buried gate. Actually, the effective control gate potential is the difference between the voltage of the gate and drain.

During erase, 35 v are applied to the source. A 5-v bias is applied to the substrate to prevent channel inversion. The 30-v difference be-

tween source and substrate causes an avalanche breakdown. A -40-v bias on the control gate provides an overall potential difference of 70 v, which enhances hole injection to the floating gate. The electron charge is canceled, and gate voltage rises to about +7 or +8 v, effectively erasing the memory.

Nippon Electric engineers say their data shows no deterioration of memory characteristics after several hundred erase cycles. And they extrapolate it to a life of between 10<sup>5</sup> and 10<sup>6</sup> power cycles. □

## Fast Mostek ROM has 350-ns access

Despite all the hoopla about the fast microprocessors and faster random-access memories, equipment designers continue to point out that their systems run only as fast as the slowest component. That component is the commonplace read-only memory, used in most microprocessor

systems for program storage.

Mostek Corp., however, has developed and started shipping a new, high-performance 16,384-bit ROM that does keep up. Access time of its MK 34000 is 350 nanoseconds maximum and, with three-state outputs and organization into 2,048 8-bit words, it's clearly aimed at the 8-bit microprocessor market. Furthermore, it can be plugged into the same sockets as Intel's electrically programmable, ultraviolet-erasable 8,192-bit ROM, the model 2708, which is widely used for prototyping microprocessor-based systems.

**RAM techniques.** “We've taken some of the techniques used in dynamic-RAM circuitry and put them into a static-ROM configuration,” says Derrell Coker, applications engineer for the Carrollton, Texas, MOS manufacturer. Although Coker is unwilling to talk specifics about some of those techniques, he reveals that Mostek made “subtle refinements in our standard n-channel, silicon-gate, ion-implanted, depletion-load process.” But the key to

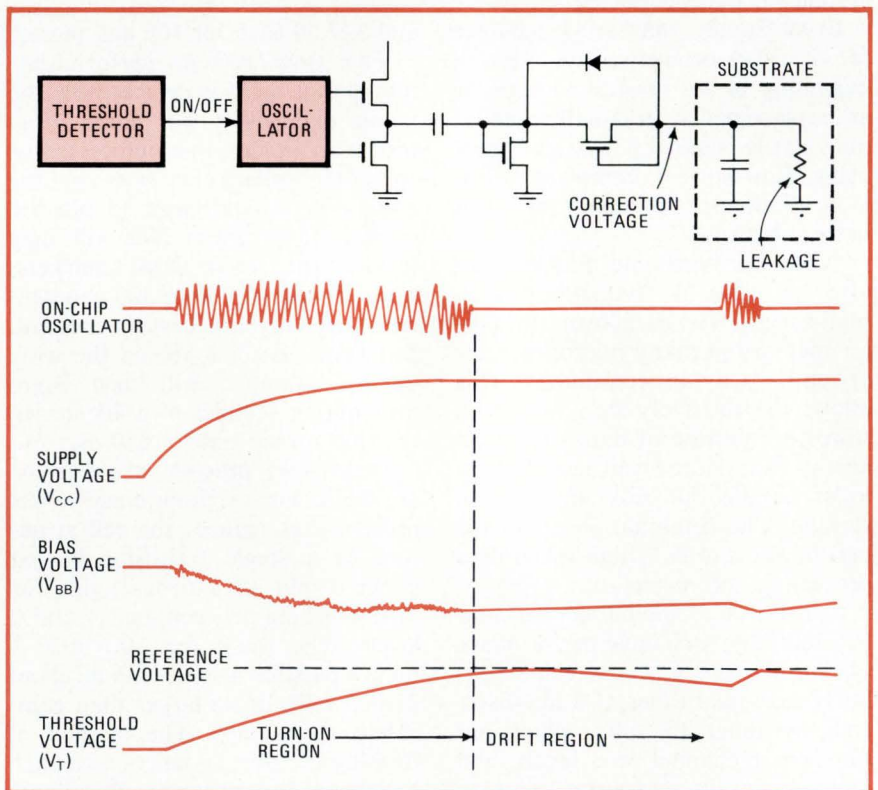

**Extra.** Mostek's on-chip oscillator “pump” corrects for variations in threshold voltage,  $V_T$ , of its new 16-k ROM. The oscillator is disabled whenever  $V_T$  equals the reference.





## TEKTRONIX TM 500

### A Configurable Line of Test Equipment for:

Production Test Stations  
Built-in Test Equipment  
Mobile Vans  
Aircraft  
Shipboard  
Consoles  
Monitoring Facilities

TM 500 Instruments offer you a powerful solution for your rackmounted test and measurement instrument needs. They require only 5¼" height, go 6 in a rack, number more than 35, and are still growing. But of greatest benefit to you, the plug-ins can be selected to perform as individual instruments or to work together as systems.

A rear interface board permits interconnection of inputs, outputs, and various parameters between the plug-ins. You could, for instance use a DMM to measure the trigger level of a counter/timer. **A multitude of rear connections is possible, all out of sight and without front-panel clutter.**

Plug-ins include: **DMM's, counters, signal sources and signal processors, power supplies, oscilloscopes,** and more.

Even blank plug-ins are included so **you can build-in custom circuits** not available from manufacturers. For example, you could install a multiposition switch on the front panel of a blank plug-in. With the switch and the TM 500 interfacing you could make a rapid series of voltage, current, or temperature checks.

The plug-in feature of TM 500 Instruments **lets you change your measurement system to meet your changing needs or minimize down time** to the seconds required to change a plug-in.

If you don't need a 6-compartment mainframe there's a 3-compartment mainframe that may be rackmounted. Additionally there's a 5-compartment "Traveler" mainframe and 1, 3, 4, and 6-compartment bench mainframes. All the mainframe/power modules may be hand carried, and there are SCOPE-MOBILE® Cart configurations as well.

For more information, contact your local Tektronix Field Engineer or write or phone: Tektronix, Inc., P.O. Box 500, Beaverton, Oregon 97077, (503) 644-0161 ext. 5542. In Europe: Tektronix Limited, P.O. Box 36, St. Peter Port, Guernsey, Channel Islands.



**TEKTRONIX®**

committed to  
technical excellence

For Technical Data circle 42 on Reader Service Card.  
For Demonstration circle 43 on Reader Service Card.



the chip's high performance is the substrate bias generator, shown in the diagram on page 42.

This substrate pump is actually a gated oscillator that converts the part's single +5-volt power supply to a negative voltage that remains inside the chip. It compensates for anything that might cause shifts in the device's threshold—such as changes in temperature, supply voltage, substrate leakage, even degradation caused by aging. "It allows us reliable, predictable operation of the ROM, even in extended temperature ranges," Coker says.

**When needed.** Since the substrate bias is used only when it's needed—as opposed to an off-chip supply that supplies a continuous  $-5\text{ V}$ —Mostek is able to specify the part much more tightly than usual. Maximum read time is 350 ns, and worst-case power dissipation is 330 milliwatts. The power supply can vary  $\pm 10\%$ —twice the normal range. Also, since the part operates from a single supply, it's suited for single-supply microprocessors, such as Zilog's Z-80 and Motorola's M6800.

Mostek designed the MK 34000 with a pinout that almost matches that of Intel's programable ROM 2708. So, by adding a couple of jumper wires to the printed-circuit board, system designers can upgrade existing PROM systems, as well as double their density. Taking advantage of the three power supplies of the Intel device, Mostek replaced the two unneeded supply pins with additional chip-select inputs. The 34000 can be enabled by logic 1, logic 0 or "don't care." Coker says, "It can accept any voltage condition at the input, and it's always enabled. That's what allows us to plug into an 8-k PROM socket."

The ROM's outputs will sink 3.3 milliamperes and source 220 microamperes—more than enough for two transistor-transistor-logic loads—and will drive 100 picofarads. That's double the drive capability of most ROMs on the market now, Coker points out, adding that "important in minimal-system configurations, the designer can drive a little larger system without output buffering." □

## Industrial

### Machine-tool CNC looking good again

Gritty, oily machine shops are hardly the ideal environment for computers, but more and more machine tool buyers are specifying computer numerical control, commonly called CNC, when they buy equipment. Now gathered in Chicago for the 900-plus-exhibitor International Machine Tool Show, tool builders and controls suppliers are confidently predicting that computers are going to make a big sweep of the numerical-control business.

Their arguments are persuasive: mini- and microcomputer-based controls bring program editing and storage to the machine tool, thus eliminating the paper tape programs of hard-wired numerical controllers. Software makes CNC programs easier to improve or change to handle different parts. And CNC's rapidly falling price now almost matches that of the hard-wired designs it supersedes, especially when used on the massive multipurpose machining centers that sell for between about \$100,000 and \$700,000.

**Old story.** It's a prediction, however, that's been made before. As early as 1970, more than two dozen exhibits at the biennial show had some kind of "computer-assisted," "computer-directed," or "built-in computer" numerical control. But the computer's penetration in the conservative machine-tool industry has been slow—estimates range from 10 to 15% of the 4,000 numerical-control units shipped than 5% of machine tools sport numerical control of any kind, says Robert J. Fredrickson, numerical-control marketing manager at Allen-Bradley's Systems division, Highland Heights, Ohio.

Nevertheless, Fredrickson—and others like him—feel that this show marks the turning point. "Every user who has investigated the situation has concluded that the only way to

go is CNC," he says. "It's a very dramatic and very decisive turn." Allen-Bradley has seen hardwired controllers drop from 60% of its sales two years ago to around 15% now, he says.

"CNC really has arrived," seconds Jerome M. Price, director of marketing for Bendix Industrial Controls division, Detroit. "Within the next two years, 80% of all new machine controls will be CNC." The two firms are neck and neck for third place in the controls market; both are expected to ship more than 400 controllers each this year. Average price to the end user of all controls is about \$30,000, Price says. Simple lathe controllers start around \$10,000 each and average about \$20,000; a CNC for a multi-axis machining center with indexing work table and automatic tool and work changers may top \$80,000.

**Life yet.** Not everyone agrees: "In our modest opinion, hardwired controls aren't going to drop dead overnight," says Robert W. Breihan, sales manager for General Electric Co.'s Numerical Control operation, Waynesboro, Va.—by far the world leader in numerical control. Despite the dominance of CNC on the floor of the show, he points to more than 50 machines there controlled by his firm's hardwired Mark Century 550 control, including some newly announced machining centers.

In the opinion of Cincinnati Milacron Inc., the leading machine-tool builder and second-largest control maker: "Hardwired numerical control will continue to be a factor for smaller machines, particularly those going into small plants that don't yet have the supportive services required for CNC." □

### Micros show up in numerical control

Even though computer numerical control has made only slight inroads in the machine-tool industry, a second CNC generation, based on microprocessors, is coming along.

In general, the industry is still a



# The new Airpax process monitor combines digital readout with analog setpoints.

## Only from Airpax

Choosing the type of instrument you need is as simple as a flick of the pen. The Airpax '78 Digital Process Monitor can be ordered as a Tachometer, an accumulator, a timer, or a ratio monitor.

## Large, bright display

Clearer, brighter, and half again as large as the LED's used in our other instruments. You choose the number of digits and decimal point locations.

## Fast analog setpoints

for the overspeed/underspeed protection of speed-sensitive machinery. Or, select precise digital setpoints. Or, a combination of analog and digital setpoints. The choice is yours.

## More versatile

than anything else on the market today. You choose the signal inputs, the number and type of setpoints, output, and power. Installation is as simple as slide-in-and-hook-up.

## Price?

Depends on the options you choose, but for a four digit tachometer with fixed gate time, plan on about \$335, OEM quantity one. Want all the guns? A five digit tachometer with adjustable gate time, two analog out-puts and two adjustable digital setpoints, about \$790.

Circle our number on the Reader Service Card and we'll send you the full story, along with a model map that makes it easy to choose the specs that make the '78 right for your application. Whatever you choose, we can ship it in three to four weeks.

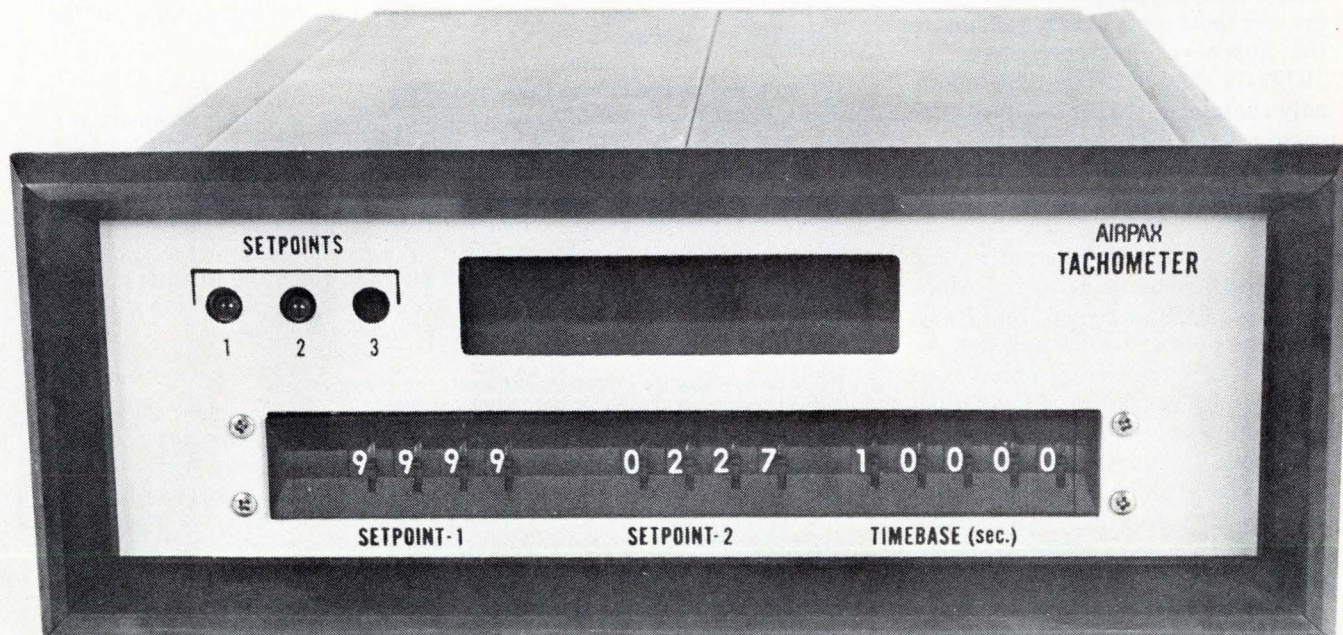

# AIRPAX

Controls Division 6801 W. Sunrise Boulevard, Fort Lauderdale, Florida 33313 (305) 587-1100



little wary of microprocessors [*Electronics*, Sept. 19, 1974, p. 31], but some of the larger control manufacturers are using the devices to augment their minicomputer-based units for such tasks as display-driving and data handling.

Kearney & Trecker Corp., Milwaukee, has added a Motorola M6800 to help out the Digital Equipment Corp. PDP-8A minicomputer used in its new Mark II computer numerical controller.

"It arranges the data from the tape reader or from the sealed disk unit used for program storage," says Kenneth B. Boyd, numerical-control product manager. "It also serves as the interface to a larger computer."

And Westinghouse Electric Corp.'s Computer and Instrumentation division, Orlando, Fla., is presenting a new W-2560 CNC system. While it now uses an Intel 8080 in the operator's panel only, the firm will be going into production by the first of the year with microprocessor controls for the computer portion of the system, says Carl Anderson, manager of numerical control.

**Bigger line.** Led by General Electric, which leapfrogged minicomputers, the industry is slowly yielding to the appeal of microprocessors. In 1974, GE showed a box that reportedly contained 24 IMP-16 microprocessors from National Semiconductor Corp., connected to a three-axis machining center made by Ex-Cell-O Corp.

This year, it's fleshing out its line with versions of that original Mark Century 1050 designed for 2-axis turning control, 3- or 4-axis and 4-, 5-, or 6-axis machining centers, and a 4-axis lathe control. In addition, the company is coming out with a lower-cost line, with fewer features, built from Toshiba 12-bit microprocessors and erasable programmable read-only memories. "We feel that the lowest-cost, most reliable CNC is going to be made with microprocessors," declares General Electric's Robert W. Breihan, numerical control sales manager.

Other companies in the controller field apparently agree:

■ Germany's Siemens AG and Ja-

## News briefs

### Data General adds to business data processing

A new system for distributed business data processing extends the push into that field by Data General Corp. The Southboro, Mass., minicomputer maker first went after business-data-processing applications with its Eclipse C/300 computer early last year. The latest entry is built around a new computer in the Eclipse line, the C/330, which extends memory capacity from the 300's 16,000 bytes of semiconductor storage on a single board and has a main-memory allocation and protection program that doubles main-memory capacity to 512,000 bytes.

Other parts of the package, called the IDEA System for interactive data entry and access, are the data-entry-access software, the RJE80 remote-job-terminal software package for emulating IBM 2780 and 3780 terminals, and a new 600-line-per-minute printer and data-channel controller. A typical four-terminal system will sell for \$120,500; 16 terminals for \$230,000.

### Automatic impedance meter costs less than \$1,000

A digital impedance meter being introduced at the Wescon show by GenRad Inc., Concord, Mass. breaks the \$1,000 price barrier for automatic measurement of resistance, inductance, and capacitance. The GR 1657 Digibridge uses microprocessor control to measure parameters in less than a third of a second. Hank Haddad, a marketing engineer in GenRad's Electronic Instrument division, notes that the \$995 price is substantially less than that of the company's model 1685, which offers measurement to accuracies of 0.1%. The 1657 provides 0.2% accuracy, full five-digit light-emitting-diode readout of resistance, inductance, and capacitance, plus complete four-digit display of dissipation and quality factors.

GenRad is also showing the latest generation of its CAPS software for digital logic testing, which will run on any of the company's model 1792 or its 1795 digital-circuit-board logic testers. CAPS stands for computer-aided programing system, and its eighth generation is intended to speed program generation for board testing. It includes a feature called Finds (fault-identifying nodal diagnostic software) that isolates faults down to the individual IC pin level.

### ITT to build navigation system evaluator

International Telephone & Telegraph Corp.'s Defense Communications division in Nutley, N.J., will design and build a test facility to evaluate electronic equipment for the Global Positioning System, the Department of Defense program that will use the Navstar satellites to provide a highly accurate navigation system in the 1980s. The evaluator, to be built under a \$2,147,785 contract from the Air Force Avionics Laboratory in Dayton, Ohio, will simulate signals emitted by the satellites and determine whether receiver equipment has interpreted the signals correctly with respect to range, range rate, three-dimensional position, velocity, and system time.

### RCA consolidates government systems businesses

RCA Corp. in New York, has grouped four of its government electronics divisions into a new Government Systems division based in Moorestown, N.J. Headed by vice president and general manager James Vollmer, the new division combines the former Astro-Electronics, Automated Systems, Missile and Surface Radar and Government Communications Systems divisions. It will do engineering, marketing, and advanced programs development.

Vollmer, former head of the Government Communications Systems division in Camden, N.J., will report to Irving Kessler who was appointed group vice president of RCA's Electronics and Diversified Businesses organization, a new post responsible for Vollmer's division and the Commercial Communications Systems division. Also appointed to a new group vice president's post is Julius Koppelman, former president of RCA Service Co. Koppelman, succeeded by Joseph Karoly, is responsible for the Distributor and Special Products and Picture Tube divisions, as well as RCA Service Co.



# If you have any of these tape transports...

**Honeywell**  
HEWLETT  PACKARD

**GENISCO**  
**SANGAMO**

**BELLEHOWELL**

**AMPLEX**

## Then it's easy to put time on your tape.



Model 8120 Time Code Generator

Systron-Donner's time code instrumentation is compatible with most, if not all, analog tape transports. Your transport manufacturer will probably recommend Systron-Donner—the leading manufacturer of quality time code instrumentation. Exactly what does S-D provide?

1. Time code generation and reading, IRIG formats, NASA formats, and others.
2. Automatic tape search using your transport to automatically locate selected tape segments during playback.
3. Computer-controlled tape search to permit automatic location and identification of selected tape segments for data reduction.



Model 8134 Time Code Reader/Tape Search and Control Unit

Because S-D offers a complete line of time code instrumentation, we can meet your specific requirements. Request our new brochure "Time Code Instrumentation". (Free)

For an authoritative and practical treatise on timing, S-D offers a newly revised timing handbook entitled "Precision Timekeeping and Tape Search". Price \$3.50

Contact your Scientific Devices office or Systron-Donner at 10 Systron Drive, Concord, CA 94518. For immediate details, call our timing products department (415) 676-5000. In Europe: Munich, W. Germany; Leamington Spa, U.K.; Paris (Le Port Marly) France. Australia: Melbourne.

**SYSTRON**  **DONNER**

Circle 47 on reader service card



## MONOLITHIC CRYSTAL FILTERS

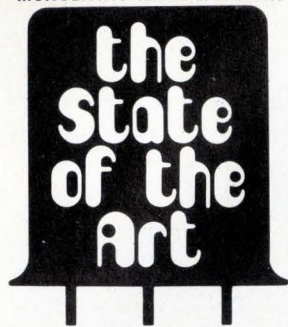

### SPEAKING TO THE DEAF

Our monolithics find their way into some fascinating and unusual applications. For instance — a narrow-band FM system which allows children with severely impaired hearing to participate in normal classroom activities. One of the requirements of the system was that both the students' receivers and the teacher's transmitter allow unhindered movement by the wearer. Another was freedom from interference, including interference from other systems in nearby classrooms. Cost was also an important factor. One of our standard 10.7 MHz tandem monolithic crystal filters in each receiver takes care of the interference. Its size is consistent with the needs of the wearer. Its cost is consistent with educational budgets.

### HAVE IT YOUR WAY

As regular readers of this column know by now, we offer the broadest line going of standard monolithic crystal filters. It may be worth mentioning that we're just as interested in helping you with a custom monolithic as we are in showing you new ways to use our regular models. We've done hundreds of production "specials" from 5 to 180 MHz. May we do one for you?

**What's your production application? Talk with us about it. We may be able to help. And if your interests include teaching the deaf, we'd be happy to put you in touch with the manufacturer of this equipment.**

**Piezo Technology Inc.**

2400 Diversified Way Orlando, Florida 32804  
305.425.1574

**The Standard in monolithic crystal filters.**

## Electronics review

pan's Fujitsu Fanuc Ltd., both leaders in their markets, have formed a U.S. joint venture called General Numerics Corp. in Elk Grove, Ill., to market a new CNC unit designed around an Intel microprocessor.

■ McDonnell Douglas Corp. is entering the machine-control business through its Monrovia, Calif., Actron division. It has brought what it refers to as its Actrion III controller to the machine-tool show that's fabricated with a three-chip 16-bit microprocessor set of its own design and manufacture [*Electronics*, Sept. 2, p. 25].

■ Autonumerics Inc., Hauppauge, N.Y. turned to Intel 8080s for its new Positool computer numerical control system.

■ General Automation Inc., Anaheim, Calif., is introducing a new CNC unit using its year-old 16/220 microcomputer.

■ Icon division of USM Corp., Cambridge, Mass., is showing two X-Y positioning tables and a three-axis milling machine, all microprocessor-based. □

## Companies

### Intel plans broad LSI-product push

"We're entering our most intense phase of microprocessor-product development," says William Davidow, vice president and general manager of Intel Corp.'s Microcomputer division. The Santa Clara, Calif., company, which leads all others in microprocessor sales with its popular 8080 family, plans during the next 18 months to introduce some 20 large-scale-integrated microprocessor, peripheral, and interface circuits. These devices are aimed at bolstering Intel's hold on the large market for general-purpose 8-bit microprocessor systems.

In particular, Intel wants to extend its reach down into the high-volume, low-end controller business that's developing rapidly, as well as upward into the performance-

oriented minicomputer and data-processing domains. With the cost of developing each LSI chip averaging about \$250,000, the company is giving notice to its competitors that the price for continuing as a supplier of microprocessors will be high.

**New CPUs.** Of the 20 chips, perhaps the most eagerly awaited are three high-performance central processing units for the 8080 family and two new minimum-chip families, the MCS-48 and MCS-41, for the low-end market. The 8080 entries are the 8085, a more powerful version of the 8080A that's twice as fast, another 8-bit CPU boasting a fivefold increase in performance, and finally, the company's first 16-bit CPU design, intended to provide a tenfold increase over today's 8080 performance for the minicomputer-oriented data-processing market.

The MCS-48 family includes two processor types, the 8048 and 8748, both of which contain CPU, read-only and random-access memories, and extensive input/output and instruction capabilities. They are intended for high-performance single-chip control applications, or they can be expanded with other MCS-48 family members in minimum-chip microcomputer designs. They also work directly with the large number of 8080 peripheral chips.

A unique feature of the 8748 device is its field-erasable 8,192-bit programmable ROM that can be altered with ultraviolet light in the field; the 8048 ROM is a masked version. The 8041 and 8741 are similar designs with less I/O capability, making them useful for controlling peripherals in large 8080-based microcomputer systems.

**Complex.** The most ambitious of these new 8080 peripherals being developed are the so-called 70 series, whose chips are two and three times more complex than the 8080 CPU itself. Coming in this series are the 8071 synchronous data-link controller, the 8073 floppy-disk controller, the 8075 cathode-ray-tube controller, and the 8079 keyboard-display chip. Also in development are special microprocessor memories with combinations of ROM with I/O, RAM with



# Does your memory blank out in a blackout?



There are some memories that lose their data when the power goes off. Like a RAM.

But not an EAROM. GI's EAROM is something new in the electronic world. It's non-volatile, so it doesn't blank out when the power goes off.

Another thing. An EAROM is *electrically* erasable and reprogrammable. Unlike a PROM or EPROM. Think what that means if you have an inventory of programmed PROMs or ROMs and you want to make program changes. You're locked in. But not with an EAROM. You can reprogram it—erase and rewrite—at-the-bench or in-system without an ultra-violet light. And it's word alterable.

Come to think of it, an EAROM can do more things than a RAM, ROM or PROM put together. You can

program it, erase it and reprogram it, electrically, in-or-out-of-the-system. And there's a whole family of EAROMs available right-off-the-shelf.

Only General Instrument makes a *full* line of EAROMs. It's one of the newest memory circuits. But we also make a large family of ROMs and RAMs. In fact, our business is creating and making microelectronic circuits—millions of them for all kinds of needs.

Whatever product you make, we have on hand or can dream up a circuit to make it do its job better, more reliably, at lower cost.

Write or call today and find out how EAROM or one of our other chips can help put you in the chips. General Instrument Microelectronics, 600 West John Street, Hicksville, New York 11802, (516) 733-3107.

**We help you compete.**

**GENERAL INSTRUMENT CORPORATION  
MICROELECTRONICS**





MORE POWER  
IN SMALL PACKAGES

# High Voltage Triacs

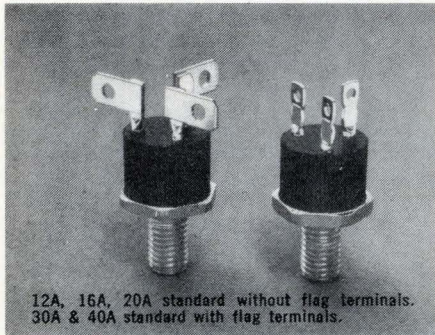

12A, 16A, 20A standard without flag terminals.  
30A & 40A standard with flag terminals.

- ▶ 50V to 1200V ( $V_{DROM}$ )
- ▶ INTERNAL ISOLATION
- ▶ WILL WITHSTAND 2500 VAC MIN. TERMINALS to STUD

The TK Series features exceptional economy and high reliability for commercial and industrial applications where stringent safety requirements are involved.

This series is available from 50V to 1200V ( $V_{DROM}$ ) with 12A, 16A, 20A, 30A and 40A<sup>(1)</sup> [ $I_{T(RMS)}$ ] ratings. With the unique internal isolation, all devices will withstand a minimum of 2500 VAC from terminals-to-stud for one minute at 80°C ( $T_c$ ).

The void-free glass passivated chips have shorted-emitter, center-gate geometry for high di/dt and dv/dt capability. Package construction is a 1/2" plastic can on a metal stud.

(1) 1000V ( $V_{DROM}$ ) max. at 40A [ $I_{T(RMS)}$ ].

For complete information, call  
E. Eugene Uecker, 817/265-7381.

"Advanced Switching  
Device Technology"

## THYROTEK CORPORATION

P. O. BOX 5407 • 611 109TH STREET  
817/265-7381 • ARLINGTON, TEX. 76011  
TWX: 910-890-5132

50 Circle 50 on reader service card

## Electronics review

I/O, and ROM with RAM.

Finally, in a parallel effort, Intel is developing new in-circuit emulation (ICE) boards for its Intellec microprocessor-development system (MDS). These include the new 85, 48, and 41 series, as well as assemblers for these products. Intel hopes to have plug-ins for the MDS that resemble the plug-ins used by oscilloscope manufacturers.

At this week's Wescon show in Los Angeles, Intel is showing two of its new development aids. One is ISIS II, a software package for its Intellec MDS that offers a modular approach to programing as well as allowing convenient use of a high-level language [*Electronics*, Sept. 2, p. 34]. The other is the Prompt system, a \$1,500 system for exercising the microprocessor, developing programs, and generating programable ROMs. □

## Packaging & Production

### Lasers strip wire insulation

Although the operation appears at first to be technological overkill, lasers are being used in the Space Shuttle program to strip away the insulation from copper wire reliably and repeatedly. The technique is so effective that aerospace firms like Lockheed Missiles and Space Co. and Boeing Co. may want to have units of their own, says William F. Iceland, a project engineer at the Space division of Rockwell International, Downey, Calif. It was there

that the laser systems for stripping single-conductor Kapton-insulated wire were developed.

In a paper delivered last month at a meeting of the Society of Photo-Optical Instrumentation Engineers in San Diego, R. M. Heisman and A. R. Keir of Rockwell joined Iceland in explaining that lasers are used because the melting point of Kapton is so high that conventional wire-stripping techniques are frustrated. Thermal stripping methods are too slow for production lines, and mechanical stripping requires the stripping tool to be frequently calibrated because of mechanical wear or abuse by the operator.

**Bench model.** Turning to lasers, Rockwell first developed a bench-model stripper powered by a continuous-wave carbon-dioxide laser operating at 10.6 micrometers that could produce 250 watts, but the output was limited to 15 w.

The wire is pushed into the front of the unit, whereupon an optical-mechanical system using electric servo motors rotates the pinpoint output from the laser around the wire to melt a strip around the circumference of the Kapton. The beam is then moved axially to melt a strip along the wire, and the unwanted insulation can be removed by hand. While Kapton is so highly absorptive of the laser light that it melts, the nickel coating of the copper wire is highly reflective. Moreover, the residual heat input is rapidly carried away by the copper itself, protecting the conductor. The stripper can handle wire with AWG sizes between No. 26 and No. 10.

At the request of NASA's Johnson

**Stripper.** Bench-top model of Lockheed's wire stripper moves laser around and along inserted wire, burning away a thin strip so that insulation can be pulled off.

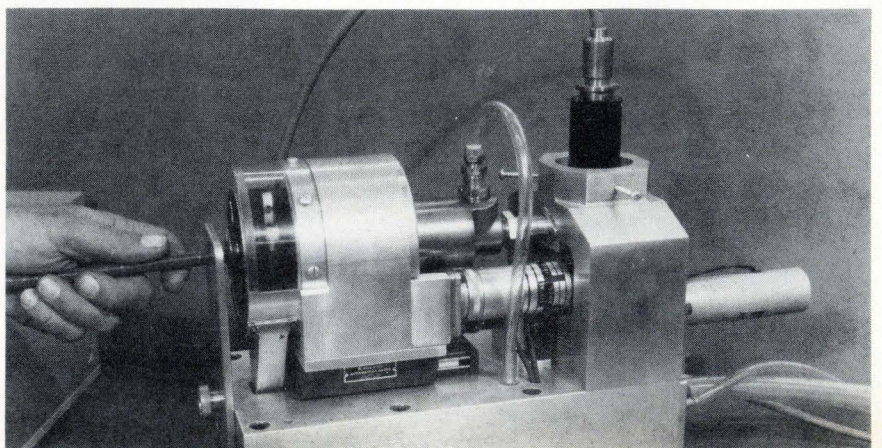



# We deliver more bipolar PROM than:

**Texas Instruments  
Intel  
Fairchild  
National  
and Motorola,  
all put together!**

That makes us No. 1 in bipolar PROM and then some. We got there by having the most reliable PROMs, the best selection, a complete line of mil. temp. devices, the fastest access times, the best delivery, and the best prices. Look at our product line. See if we shouldn't be your PROM supplier.

For more information call,  
TWX or write:

**United States**  
Monolithic Memories, Inc.  
1165 East Arques Avenue  
Sunnyvale, CA 94086  
Tel: (408) 739-3535  
TWX: 910-339-9229

**Europe**  
Monolithic Memories, GmbH  
8000 Munich 80  
Mauerkircherstr. 4  
West Germany  
Tel: (089) 982601, 02, 03, 04  
Telex: (841) 524385

**Far East**  
MMI Japan, K.K.  
2-2, Sendagaya 4-chome,  
Shibuya-ku,  
Tokyo 151, Japan  
Tel: (03) 403-9061  
Telex: J26364

## MONOLITHIC MEMORIES PROMS

MEMORY SIZE	ORGANIZATION	DEVICE	OUTPUTS	PINS	OPERATING RANGE	MAX* ACCESS TIME (ns)	100-999 PRICE
256	32 x 8	6330/1-1	OC/TS	16	com	50	\$ 2.55
		5330/1-1	OC/TS	16	mil	60	5.00
1024	256 x 4	10149	OE	16	com	30	17.50
1024	256 x 4	6300/1-1	OC/TS	16	com	55	3.25
		5300/1-1	OC/TS	16	mil	75	7.90
2048	256 x 8	**6308/9-1	OC/TS	20	com	65	15.95
		**5308/9-1	OC/TS	20	mil	85	33.50
2048	512 x 4	6305/6-1	OC/TS	16	com	60	7.00
		5305/6-1	OC/TS	16	mil	75	15.95
4096	512 x 8	**6348/9-1	OC/TS	20	com	65	15.95
		**5348/9-1	OC/TS	20	mil	85	33.50
4096	512 x 8	6340/1-1	OC/TS	24	com	90	15.95
		5340/1-1	OC/TS	24	mil	120	33.50
4096	1024 x 4	6350/1-1	OC/TS	18	com	60	15.95
		5350/1-1	OC/TS	18	mil	75	33.50
4096	1024 x 4	6352/3-1	OC/TS	18	com	60	15.95
		5352/3-1	OC/TS	18	mil	75	33.50
8192	1024 x 8	**6386/7-1	OC/TS	22	com	90	Consult Factory
		**5386/7-1	OC/TS	22	mil	125	Consult Factory
8192	1024 x 8	**6380/1-1	OC/TS	24	com	90	Consult Factory
		**5380/1-1	OC/TS	24	mil	125	Consult Factory

\*max access time is guaranteed over the complete voltage and temperature variation.  
\*\*available October 1976.

# Monolithic Memories



## The M-600 amp works harder at 2.5 ohms

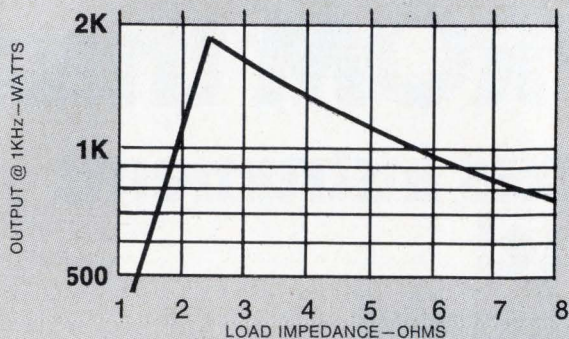

## So each watt costs less

You get more watts per dollar from the Crown M-600 power amp if your circuit design lets it look at a 2.5Ω load.

The M-600 provides power from DC to 20KHz with complete protection against shorts, open circuits, mismatch, RF burnout and thermal overload. The M-600 will even drive a purely reactive load without overheating. Designed for continuous operation at full rated power, at any rated frequency.

One M-600 will cost you \$1,795. A copy of the spec sheet is free. Write today.

We'd also like to hear from you if you have any special amplification problems in the DC-20KHz range. We've already solved some tough, unique problems. We'd like to consider yours.

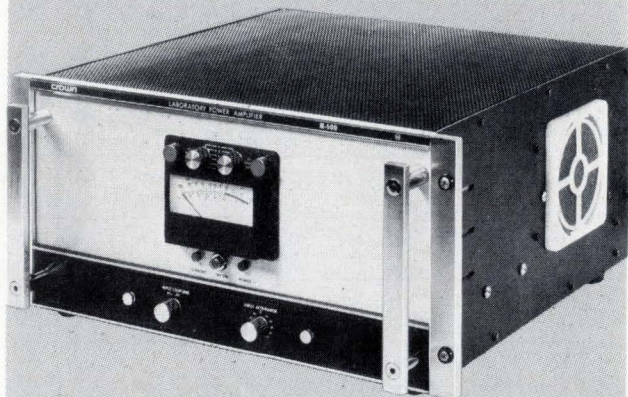

**CROWN INDUSTRIAL**

1718 W. Mishawaka Road, Elkhart, Indiana 46514

219/294-5571

## Electronics review

Space Center in Houston, Rockwell also built a portable laser stripper to accommodate the same wire sizes. This unit can be wheeled onto the production floor to strip insulation from cable harnesses right where they are being assembled, Iceland points out. With an output of 5 to 7 w, it is powered by a smaller neodymium-yttrium-aluminum-garnet laser operating at the shorter wavelength of 1.06 μm.

The laser beam is transmitted through a 12-foot fused-silica-fiber optical cable to a hand-held, 8-pound stripping mechanism supported by a counterbalanced arm. The laser assembly, together with power supply and cooling unit, is mounted on a cart.

**Maker needed.** A second hand-held stripper with a five-inch-long carbon-dioxide laser that will be inside the stripping head is under development. But, although others may want the laser strippers, they may have to wait for them. "The Space division is not interested in going into this type of business. It will be up to NASA to locate a willing manufacturer to build the device," says Iceland. □

## Microprocessors

### Rockwell adds two-chip PPS-8

Anticipating that the low end of the microprocessor market will be a high-volume segment, Rockwell International is bringing out a two-chip version of its five-chip PPS-8 system. It is the first device in Rockwell's PPS-8/2 family. Initially priced at less than \$30 in quantities of 1,000—roughly half the PPS-8's price—this microprocessor has 2,048 words of read-only memory.

"It's intended for the low end of the 8-bit market, for applications that need an 8-bit central processing unit, but not the 4-k-and-up memory that usually goes with it," explains Anthony A. Bell, head of microprocessor-product development for Rockwell's Microelectronic Device



# The Raytheon 2900 family gains five new members

**Whereas:** Raytheon is the established alternate source for the Am2901 and Am2909, (franchised distributors stocked), and,

**Whereas:** Raytheon brought you RAYASM, the powerful micro-assembler available on the NCSS computer network,

**Now Therefore:** Raytheon announces five additional 2900 family components, giving us a total of seven, To Wit:

**2901** A 4-bit Microprocessor Slice—the fastest, most powerful LSTTL microprocessor in the world. With its cycle-saving two-address architecture, the 2901's speed can't be touched.

**2905** A 4-bit Bus Transceiver— general purpose open collector bus interface device. Data to the 100 milliamper bus drivers is provided by a 4-bit register with a two-way multiplexer at its inputs. Data from the bus receiver may be held in the 4-bit receiver latch on its way to the three state receiver outputs.

**2906** A 4-bit Bus Transceiver with parity —is equivalent to the 2905 but with the addition of an on-chip parity generator/checker.

**2907** A 4-bit Bus Transceiver—similar to the 2906 with the two-way multiplexer at the input to the bus driver register elimi-

nated to allow the device to be packaged in the space saving 20-pin DIP.

**2909** A Microprogram Sequencer—that can branch anywhere in memory, perform sub-routines, then return with up to four levels of sub-routine nesting. The device is a cascadable 4-bit slice which allows addressing of up to 4K words of microprogram with three devices.

**2918** A General Purpose 4-bit Register—with two sets of outputs: TTL and three state. This useful combination can reduce your package count for those status, command, and instruction registers which must drive both your control logic and a data bus.

**93415** A 1024 × 1-bit Fully Decoded Random Access Memory—for your high-speed data and control stores.

Raytheon LSI is on the move. More 2900 family components soon to come include PROM's, sequencers, look-ahead carry generators, additional RAM's, and other goodies now in process.

For complete details, contact your local distributor or Raytheon Company, Semiconductor Division, Dept. 2900, 350 Ellis Street, Mountain View, CA 94042, (415) 968-9211.

# Am 2900 SOLD & SUPPORTED HERE



**SEMICONDUCTOR DIVISION**



# Line Isolated Standard

To eliminate ground loops, power line interruptions and aberrations, EDC's new Calibrator/Source offers:

- $\pm 0.1 \mu\text{V}$  to 10V output • Accuracy  $\pm 0.003\%$
- 10MA output current • Noise  $1\mu\text{V}$
- Internal battery-run 8 hrs., rechg. 4 hrs.
- Ext power - 115 Vac, 12 Vdc or 28 Vdc
- Absolute line isolation
- Model MV216A - \$1195.

Write or phone Bob Ross for details. 11 Hamlin St. Boston, MA 02127 (617) 268-9696



**ELECTRONIC DEVELOPMENT CORPORATION**



Circle 54 on reader service card

## The Low Priced AM-FM Signal Generator 1.5 MHz to 80 MHz.

Model 950A presents a direct 5 digit frequency display. Provides precise FM with calibrated deviation to  $\pm 30$  kHz and full AM capability with a direct reading calibrated meter. RF output is adjustable from  $0.1 \mu\text{V}$  to 3 volts, automatically leveled to within  $\pm 1/2$  dB. Frequency accuracy is 0.005%.

Write or call today for pricing, delivery and complete specifications.



**LogiMetrics**

121-03 Dupont Street, Plainview, New York, 11803, (516) 681-4700/TWX: 510-221-1833  
RF Signal Generators, Frequency Synthesizers, Traveling Wave Tube Amplifiers

## Electronics review

division, Anaheim, Calif. Applications include point-of-sale terminals, electronic typewriters, consumer games, and a wide range of instruments and controls.

**Similar CPUs.** The PPS-8 and the PPS-8/2 CPU chips are quite similar. Cramming the rest of the system—random-access and read-only memory, input/output ports, clock, and associated circuitry—from four chips onto one is more a result of careful design than any breakthrough in development, Bell says. "Furthermore, the two-chip design does not compromise architecture or upward expandability to achieve economy," he adds.

The basic CPU chip contains logic for systems operations, arithmetic and data manipulations, and for responding to three interrupt-request lines. On the second chip are 16 I/O ports, 2,048 words of ROM, 64 words of RAM, a 16-bit interval timer, an automatic serial I/O port, and a clock circuit. With a 3.57-megahertz crystal, the two chips functionally replace the five-device PPS-8.

"Using a 52-lead package to combine the ROM, RAM and I/O circuits is the key to achieving the high density and functional capability of the chip," Bell points out. The specific differences between the PPS-8/2 and the PPS-8 are a lower frequency of operation for the new unit—256 kilohertz, compared to 300 kHz, direct addressing of memory rather than moving it into an accumulator, and 2 versus 16 kilowords of ROM. Additionally, unlike the PPS-8, the new unit has a 16-bit interval timer for real-time counting of external events, Bell says.

**Competition.** The new Rockwell processor will compete primarily against two-chip 8-bit devices already offered in Mostek Corp.'s 6500 series and Fairchild's F-8 line. The PPS-8/2, which uses the same 109-instruction set as the PPS-8, can be expanded into more complex applications by using the LSI-circuit options available for the older microprocessor. Rockwell also plans to introduce a system, to be priced below \$25 in quantity, that will have 1 kilobit of ROM. □



# Now, Intel delivers memory for PDP-11/04 and PDP-11/34.

Intel is now shipping high speed, low cost memory for two of the hottest new minicomputers, DEC's PDP-11/04 and PDP-11/34.

That means you can get 30-day delivery and 30 to 50% savings by specifying Intel, the largest independent manufacturer of semiconductor memory.

We can give you add-in memory and add-on memory, both totally compatible with PDP-11 hardware and software. Our in-4711 is an add-in memory for the PDP-11 family and slides into an available memory slot, without modifications. For add-on memory capacity, simply attach the in-4011 memory system. You can add memory in 16K x 16 bit increments, up to 128K words.

Built with the proven Intel 2107B 4K RAM, the in-4711 memory is fully transparent to the CPU, with greater processing speed. For maximum throughput you can interleave two memories.

The in-4711's lower power consumption permits wider operating margins on the main

frame power supply and results in a cooler running, more reliable system.

If you've picked DEC to be your computer supplier, go with the best for memory, too. Intel delivers a complete line of add-in and add-on memory for the entire PDP-11 family.

That puts two good names together. Add a third — yours — with the coupon.

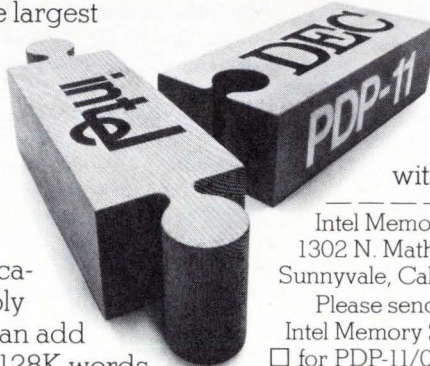

Intel Memory Systems  
1302 N. Mathilda Avenue  
Sunnyvale, California 94086

Please send me information on the following  
Intel Memory Systems:

for PDP-11/04, 11/34     for PDP-11/05, 11/35  
 for PDP-11/\_\_\_\_\_

Name/Title \_\_\_\_\_

Company \_\_\_\_\_ Mail Station \_\_\_\_\_

Address \_\_\_\_\_ Phone \_\_\_\_\_

City/State/Zip \_\_\_\_\_

**intel memory systems**  
A DIVISION OF INTEL CORPORATION



# MOTOROLA OMNIBUS



Rollin' along the routes to right design

## Kiss input polling routines goodbye



Bon Voyage and good riddance to input polling routines for your microprocessor systems. Send them packing first class at strictly coach fares with the new MC8507/MC6828 Priority Interrupt Controller.

What's that? Why two different numbers for one LSI device? No, not a split personality. We just want you to know this PIC is bipolar LSI (MC8507) designed to work in any processor system, but its first and foremost function (MC6828) is serving M6800 systems as if it were a member of that renowned NMOS family. Either number can be used for ordering.

Basically, the purpose of the PIC is to generate a modified address to ROM in response to prioritized inputs. Each interrupting device is assigned a unique ROM location with the starting address of the appropriate service routine. After the MPU responds to an interrupt, the PIC directs it to the proper memory location. The PIC also generates a Stretch signal, so the interrupt structure can be designed to accommodate the faster operations anticipated with improvements in processor speeds.

You'll just love it.

## SUPER-DUPER MOSFET QUIZ:

'Tis better to **1 enhance it**  
**2 deplete it**  
**3 tube it**



If you're into #3, this isn't for you (or maybe it is). But if you're after the best in MOSFETs for present and future VHF two-ways and TVs, receive this message:

Good 'ol Motorola now supplies the popular 'ol 3N201-03 family of N-channel, depletion mode dual gates plus the new DMOS enhancement mode MFE521.

The '201s, of course, offer typ common-source  $G_{fs}$  of 20 dB and typ NF of 1.8 dB. The '203, generally used for IF, has 25 dB  $G_{fs}$  typ.

And if you promise not to tell TI, the series duplicates theirs—for which you may be thankful—and is priced comparably—for which they won't be.

For your next generation of amplifiers/mixers, we present MFE521 in all its super-duper enhancement mode and ion-implanted splendor for just 60¢. It has 0.02 pF max reverse transfer capacitance and diode protected gates. At 200 MHz, common-source  $G_{fs}$  is 25 dB and NF 1.7 dB typ. Input and output capacitance, at 1 MHz, are 3.3 pF and 1.1 pF typ.

All are in hermetic TO-72's and can be had just by quizzing our super-duper salesmen. Don't ask about tubes—they know FETs, not filaments.

Advance and be **RECOGNIZED**, said UL, so we did.

And we are.

To prove it, we'll send you **the yellow card!**

For the unamazed among you, a UL-issued "yellow card" for an electrical component equals official UL recognition for that component.

And the recently introduced MDA3500 series 35 amp full wave bridges that caused such a stir among you awhile back are now recognized by UL (what else?!).

Reason for stir? Superior performance at equal cost.

Reason for card? So you can more easily get UL APPROVAL on your equipment by designing in components already checked out for flammability, electrical shock, thermal characteristics, chemical analysis, etc., etc.

To refresh, the MDA3500 series is a 35 amp bridge family priced at 25 amp levels. Besides furnishing 10 extra current-handling amperes, it offers 100 extra amps of surge current protection. And super-efficient, 70-watt  $P_D$ . And low AQL. And low  $\theta_{JC}$ . And fast turnaround.

And a price tag of just \$2.35, 25-99, for a 200-volter.

Customers are ordering it by the thousands and competition is mumbling under its breath.

And all we wanted was a little recognition.

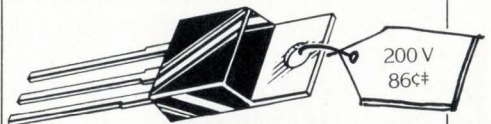

And now a new Triac, plastic, with 15 amp, 800 volt kick. Its glass passivation is just a sensation; its price tag sends studs up the crick.

That price tag runs about 30% less than for comparable studs—a bottom-line advantage that ought to make this very first of its TO-220 kind an irresistible choice for many commercial/industrial designs.

The 15 A(RMS) MAC15/15A is designed for full wave ac control in solid state relays, light dimmers, motor and heating controls and power supplies or

†10,000 PCS.





wherever full-wave thyristors are needed. Reliability? Coming right up in 150 A surge protection, all-diffused and glass-passivated junctions, gate cathode passivation, improved copper piece parts, void-free encapsulant, in-process and outgoing QC and reliability verification.

The small, rugged Thermowatt\* package offers low thermal resistance, high-heat dissipation and durability.

Gate triggering is guaranteed in two or four modes.

Use it everywhere you need to cost-reduce comparable metal parts.

Get it from a supplier who knows triacs, reason and rhyme, all the time. Motorola.

### The case of the pooped-out powertab



OR, GE whiz, man, your wattage is missing.

Don't take the rap for that nemesis of the honest engineer, that rascalion of purloined performance — Skimpy Power Dissipation. It can kill you with a feeble 1.67 watts of P<sub>D</sub>.

Turn to the only savior you have . . . Motorola's dynamic D40/41 Duowatt\* plug-in replacements with 2 watts of free-air power dissipation, and a better price.

Our powertab units eclipse theirs by 20% in power-handling and in the lowest  $\theta_{JC}$  in the industry: 62.5°C/W for lower-junction stress and a real edge in reliability and long life.

Plus, Duowatts offer second-generation epoxy molding with lower resistance to heat, higher resistance to moisture and greater strength.

Here's the run-down:

Series	Application	P <sub>D</sub> — Watts	
		GE	Motorola
D40C	NPN Darlington	1.67	2
D40D/41D	NPN/PNP 30-75 V Hi-gain Ampl.	1.67	2
D40E/41E	NPN/PNP 30-85 V Hi-gain Ampl.	1.67	2
D40K/41K	NPN/PNP Darlington	1.67	2
D40N	NPN HV Ampl.	1.67	2
D40P	NPN HV/Hi-gain Ampl.	1.67	2

Motorola Duowatts solve the power problem. Elementary, Watson, elementary.

### How does a tuning diode army march in one set of tracks?

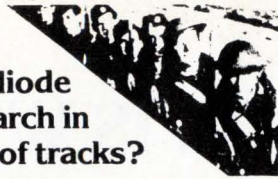

Abruptly, of course.

The new MV210 is an abrupt junction varactor diode inherently capable of tracking and matching the capacitance of the one in front of it, and behind it, over the entire voltage range.

In the past, painstaking, expensive testing and matching was required when using more than one varactor diode in a tuning system, plus costly tuning circuit adjustment once you got it all together.

The '210 plastic TO-92 solves all that by requiring just one voltage level check. All the diodes that match each other at that level, will match at any other chosen voltage level in the spectrum.

It's also got 100 min Q at 100 MHz, controlled, uniform ratio of C<sub>1</sub>C<sub>25</sub>=3.4 min 3.7 max and a low 90¢ price.

Use the '210 in FM, TV, CB-VCO synthesizer control and general frequency control to count a better cadence and cut design and testing involvement.

Forward, march.

### Nail down voltage transients with unique crowbar IC

If nasty little gremlins run around in your circuit playing havoc with voltage limits, and your nerves, pin 'em to the wall with the MC3423.

This one-of-a-kind linear unit protects sensitives from transients or regulator failure. It senses overvoltage immediately and quickly crowbars, or short circuits, the supply forcing it into current limiting or opening the fuse or CB.

It's used with an external SCR, such as the new TO-220 25A 2N6504 capable of surge protection to 300A. Protection voltage threshold is adjustable and the circuit can be programmed for minimum duration of overvoltage condition before tripping. This feature prevents false tripping in noisy environments which would normally not harm the load.

It also offers additional output for use as OVP indication as an open-collector transistor when the OVP is activated. Just a buck-and-a-half, friends.

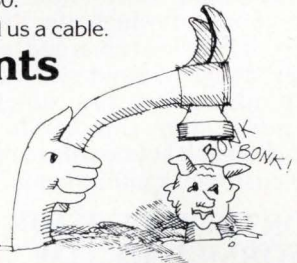

(Coupon Missing?) Send inquiries to Dept. LDC, Motorola Semiconductors, Box 20912, Phoenix, AZ 85036

### ALL ABOARD!

For complete itinerary, fill out and send to: Motorola Semiconductors, Box 20912, Phoenix, AZ 85036

Please have salesman call. Phone: \_\_\_\_\_

Name \_\_\_\_\_ Title \_\_\_\_\_

Company \_\_\_\_\_ Address \_\_\_\_\_

City \_\_\_\_\_ State \_\_\_\_\_ Zip \_\_\_\_\_

- MHW594/580 CATV Modules
- 3N201/MFE521 MOSFETS
- MDA3500 Bridges
- MAC15/15A Triacs
- MC8507/6828 PIC
- D40/41 Duowatts
- MV210 Tuning Diode
- MC3423 OVP Linear IC

All prices 100-999, unless noted. \*Trademark Motorola Inc.



# CORTRON IS WRITING THE SOLID STATE KEYBOARD SUCCESS STORY

A new name in keyboards, CORTRON actually has a history dating back to 1968, when Illinois Tool Works Inc. made news with the introduction of its first solid state keyboard through its Licon Division. ITW has emerged as a major producer of solid state keyboard products and has supplied thousands upon thousands of custom-designed keyboards to meet specific customer requirements.

## CORTRON DIVISION FORMED BY ITW

With a strong market demand and a promising future for keyboard products, ITW formed a new division, CORTRON, to handle full responsibilities for electronic keyboards and key switches. Following a proven ITW strategy, CORTRON concentrates a special division team of experienced Licon design, manufacturing and marketing people on this new major business opportunity.

## KEYBOARD MARKET DIVERSIFIED

Typical applications for CORTRON™ Keyboards include data and word processing, computerized accounting, production and inventory control systems, retail point-of-sale and remote banking terminals, airline reservation and seat assignment stations, typesetting and text editing systems. And new applications are continually surfacing.

## PROVEN PRODUCT RELIABILITY

The CORTRON Division offers proven keyboard products with an

established reputation for excellence and reliability. The

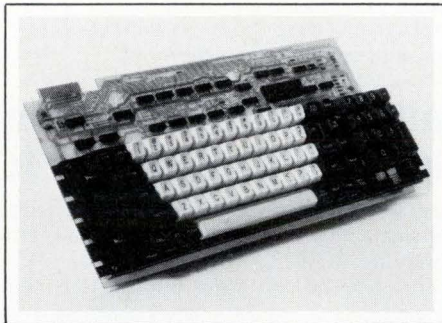

CORTRON Series 555 Solid State Keyboard is a sophisticated electronic device. Its high reliability protects against costly service calls and the hardship of downtime. The low profile alpha numeric keyboard has the human engineered "feel" required by your marketplace. This promotes speed, accuracy and greater operator productivity.

## CORTRON KEY SWITCH MAKES THE DIFFERENCE

The CORTRON Contactless Key Switch is the heart of the solid state keyboard. The CORTRON

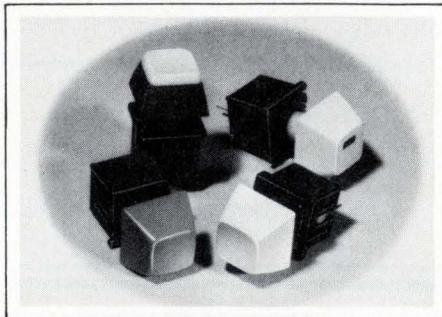

Key Switch is respected throughout the industry for its ultra reliable 100 million cycle life rating. Utilizing a ferrite core switching technology, the key switch is mechanically simple with only four basic parts.

## CORTRON RESPONDS TO CUSTOMER NEEDS

Since keyboard products are CORTRON's only business, the ITW Division is highly responsive to individual customer needs and requirements. CORTRON offers expert application engineering assistance, and has the high volume keyboard production capability so essential to large customer demands. Further, the division is backed by the resources of ITW, a worldwide corporation. Whether you want to buy keyboards or build them, CORTRON can supply the key elements necessary to success. For complete details, contact CORTRON, A Division of Illinois Tool Works Inc., 6601 West Irving Park Road, Chicago, Illinois 60634. Phone: (312) 282-4040. TWX: 910-221-0275.

CORTRON is writing the solid state keyboard success story.

TO BE CONTINUED...



**CORTRON**  
A DIVISION OF ILLINOIS TOOL WORKS INC.

**THE KEYBOARD  
PROFESSIONALS**



## Washington newsletter

### MCI sees failure if Execunet service is terminated . . .

MCI Telecommunications Corp. could be the next specialized common carrier to follow Data Transmission Co. down the bankruptcy road, according to its president, if the Federal Communications Commission convinces the U.S. Court of Appeals for the District of Columbia to **reconsider its stay of an FCC order to MCI to stop offering its Execunet service.** That order last year declared Execunet to be essentially a public long-distance telephone service—rather than a private-line service to which specialized carriers are limited—and therefore illegal, but the appeals court demurred.

“Removal of the stay would at this point in time put MCI out of business,” says William McGowan, president of the company, which has expanded its Execunet monthly revenues to over \$2 million from \$25,000 in July 1975 when the FCC first ruled the offering to be unlawful. A court ruling on the stay is expected before the end of the month.

### . . . court gets differing views from FCC, Justice

The FCC, in a three-to-one decision, asked the appeals court either to lift the stay, or, alternatively, if the court finds termination of the service would seriously damage MCI, to modify the order to prevent further expansion of Execunet until litigation is completed. But the Justice Department opposes either vacating or modifying the stay unless the court concludes that MCI's appeal “has little or no chance of prevailing upon its merits.” McGowan told the FCC that **Execunet was expected to account for 43.3% of MCI's August cash receipts of \$4,995,000.** But, the FCC noted, “MCI created this situation itself” by expanding Execunet “at a time when MCI knew well that the service was of dubious legality.”

### First hearings set by House panel on 'Bell bill'

The first congressional hearings on the controversial consumer-communications reform bill—and probably the only ones before Congress adjourns—are set to run for three days beginning Sept. 28 before the House Interstate and Foreign Commerce subcommittee on communications. Sponsored by the nation's telephone companies, **the legislation has gained the support of its 171st House member,** Arizona Democrat Morris K. Udall, as well as the Communications Workers of America, long regarded as a supporter of the views of American Telephone & Telegraph Co. CWA president Glenn E. Watts told members that telephone workers' interests “will be best served by passage of the act, or one similar to it, because that would restate the policy of the United States for telecommunications as calling for end-to-end service and rate leveling,” or averaging to the advantage of consumers. “Fracturing the industry,” Watts said, would not “be good for the worker.”

New statements opposing the “Bell bill,” as it is popularly known, came from the North American Telephone Association, made up of independent equipment suppliers, and the Computer and Business Equipment Manufacturers Association's chairman, E. Lawrence Tabat, who is also president of Dictaphone Corp. NATA said the bill would grant AT&T a monopoly and exempt it “from many forms of rate regulation and antitrust action.” CBEMA's Tabat wrote key legislators that passage would mean that “American technological leadership would soon wither under the stifling pall of monopoly, and with it would dwindle the jobs of the future.”



## **Gas plasma, LEDs chosen to compete for Army display**

The Army has chosen plasma and light-emitting diode technologies to compete in the development phase of a large-scale interactive computer presentation panel for its Artads program—the Army tactical data system [*Electronics*, June 10, p. 25]. Control Data Corp. **has received a \$2.3 million award** to supply two plasma displays, one to the Artads project at the Army electronics command, Fort Monmouth, N.J., and one for the West German ministry of defense, which is participating in the project. At the same time, **Litton Industries Inc., has received a competitive development contract** to deliver a two-color LED display.

The displays will superimpose computer-generated alphanumeric and symbols on backlighted Army maps to provide commanders in forward battle zones with constant updates on fluid battlefield situations. CDC says its neon plasma transparent display panel will measure 1 meter feet high and 1.22 wide (3.28 by 4 feet), making it the largest yet built. Map resolution will be 10 lines per centimeter, or 25.4 lines per inch. An Artads production contract is expected to follow evaluation of the competing displays, although a timetable for the awards is not yet fixed.

## **FDA proposes rules for new devices; problems seen**

Medical electronic device makers have until Nov. 2 to comment on new proposed regulations by the Food and Drug Administration covering registration of organizations with the agency, and how to go about informing the agency 90 days in advance of plans to introduce a new device. Proposed registration by means of a one-page FDA form held no surprises for industry, but some firms question regulation 510(k) that would effectively **restart the 90-day waiting period before a new product may be distributed** if the FDA finds a device is not substantially the same as one already on the market or decides that the premarket notification contains insufficient data.

Some industry officials in Washington want the 90-day period to continue running pending submission of additional data. Makers are also distressed that premarket notice could aid competitors in learning of new equipment. The FDA says that in the 90-day period ended in August, it has approved 230 of the 480 premarket notifications it has received for all classes of devices. The eight pages of proposed regulations are scheduled to go into effect by the end of the year. They appeared in the Federal Register (vol. 43, no. 173) on Sept. 3.

## **Marad sees ship automation rising to offset inflation**

The merchant marine's characteristic conservatism and reluctance to change is being beaten back by hard-nosed economic considerations—the soaring cost of ship operations and fuel—with the result that **automation of ship operations is accelerating**. Market potential for ship automation is huge, according to Marvin Pitkin of the Commerce Department's Maritime Administration (Marad). "Of the 25,000 to 30,000 large ships in the world's fleets today," Pitkin estimates that "only about 500 have any degree of automation."

Automating operations of a major merchantman can run from \$35,000 to as much as \$150,000, he figures. Pitkin's estimate came at the conclusion of the Second International Symposium on Ship Operation Automation in Washington early this month.





# Select from this family of aluminum electrolytic capacitors designed for output filtering in switching power supplies



### TYPE 672D

- Suitable for parallel stacking
- Plug-in PWB mounting
- Low to medium ripple current capability



### TYPE 604D

- True 4-terminal isolation
- Low profile PWB mounting
- Medium ripple current capability



### TYPE 622D

- Best ESR in std. construction
- 1st with symmetrical ESR and capacitance tol.
- High ripple current capability



### TYPE 432D

- Lowest available ESR and impedance
- Bus-bar mounting
- Maximum ripple current capability

Construction	Rolled-Section		Rolled-Section		Rolled-Section		Stacked-foil	
Terminal Configuration	2 terminals, wire pins		4 terminals, wire leads		2 terminals, low or high female threaded		2 terminals, strip-line, female threaded	
Case Size Range (D. x L.)	.326" x .505" to 1.000" x 1.625"		.750" x 1.625" to 1.000" x 3.625"		1.375" x 2.125" to 1.375" x 5.625"		1.375" x 2.125" to 3.000" x 5.625"	
Operating Temperature Range	-55°C to +105°C		-55°C to +105°C		-55°C to +85°C		-40°C to +85°C	
WVDC Range	6.3 to 100		5 to 200		5 to 55		6 to 50	
Capacitance (Range (μF))	4.7 to 6800		50 to 16,000		2,800 to 67,000		470 to 100,000	
Capacitance Tolerance	-10, +100%		thru 50 V: -10, +75% over 50 V: -10, +50%		±20%		-0, +100%	
Max. Inductance (@ 1 MHz & within .125" of capacitor)	20 nH		2 nH		20 nH		2 nH	
Max. ESR (@ 25°C and 120 Hz)	.11 ohm		.022 ohm		.004 ohm		.0015 ohm	
RMS Ripple Current (@ 85°C)	1200 μF @ 6.3 WVDC	2.61 A @ 100 kHz	16,000 μF @ 5 WVDC	7.00 A @ 10 kHz	67,000 μF @ 5 WVDC	19.5 A @ 20 kHz	100,000 μF @ 6 WVDC	54.6 A @ 1 kHz
Max. Impedance (@ 25°C)	.06 Ω @ 100 kHz		.017 Ω @ 10 kHz		.010 Ω @ 10-40 kHz		.001 Ω @ 10 kHz	
Engineering Bulletin	3452		3458A		3459		3443A	
	Check 199 on Reader Service Card		Check 200 on Reader Service Card		Check 201 on Reader Service Card		Check 202 on Reader Service Card	

For complete technical data, write for Engineering Bulletin(s) (see table for bulletin numbers) on the capacitor(s) in which you are interested to: Technical Literature Service, Sprague Electric Company, 35 Marshall St., North Adams, Mass. 01247.

**THE BROAD-LINE PRODUCER OF ELECTRONIC PARTS**





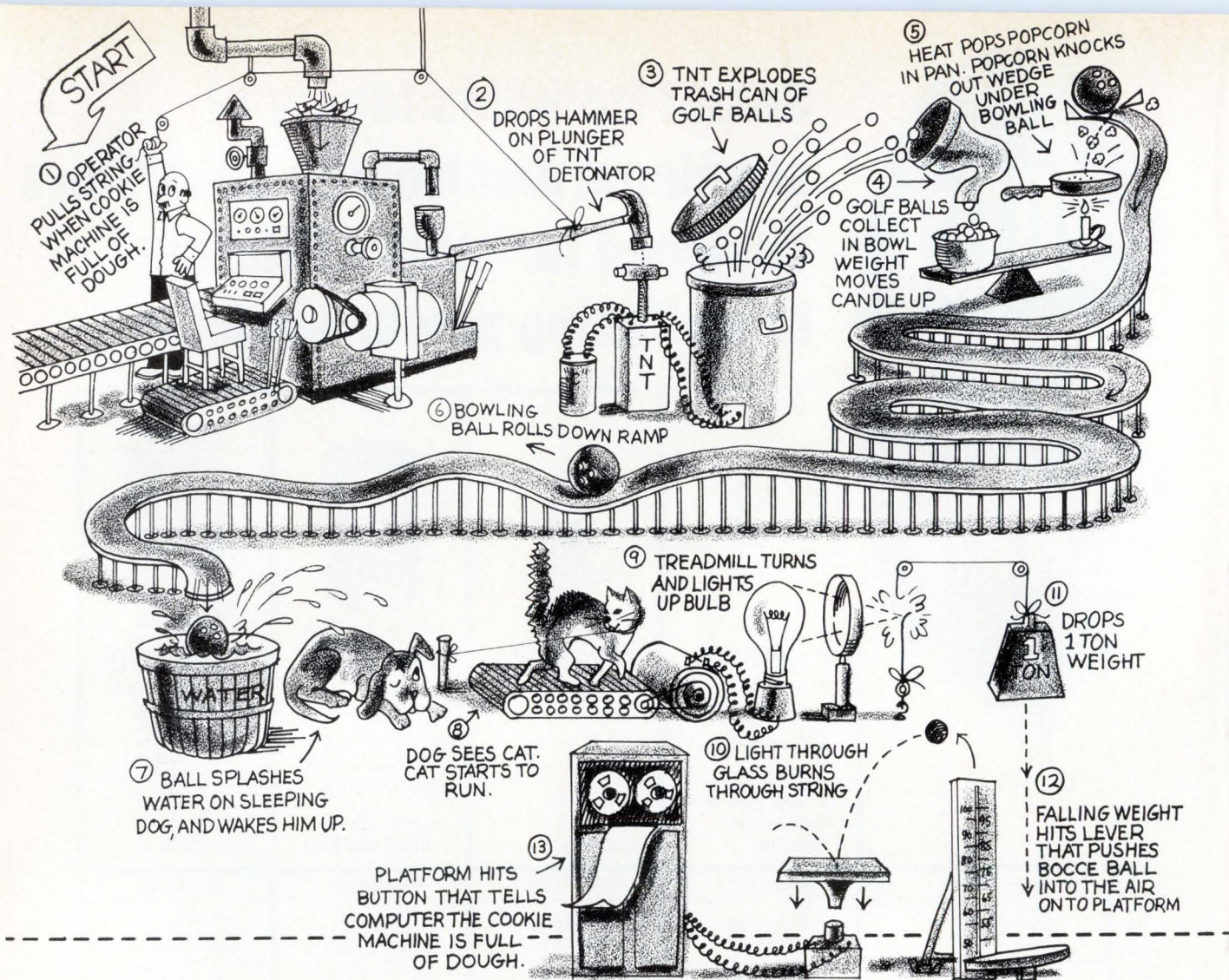

## How to avoid the interfacing nightmare.

If you've got a computer, the easiest way to avoid the kind of nightmare interfacing can become with *anybody's* machine is to simply come to us — the world's largest supplier of interface modules.

Besides being number one in sheer volume, we're also number one in technology. With a new line of microcomputer products for the LSI-11: A DMA module, an expansion backplane that doubles card capacity, and a foundation module for custom interfacing. Plus a new

line of high density wire wrap cards for our larger machines. All part of our substantial library of off-the-shelf solid state modules and compatible hardware featuring the best cost-performance ratio in the business.

The Logic Products Group can also help you establish new designs, give all kinds of applications assistance, even develop custom designs from scratch.

Why not send for our new Logic Handbook describing all our products. It'll give you a pretty good

idea of how we can take on the interfacing nightmare.

And turn it into one sweet dream.

For your free Logic Handbook, call 800-225-9480 (Mass. 617-481-7400 ext. 6608). Or write: Components Group, Digital Equipment Corp., One Iron Way, Marlborough, Ma 01752. Canada: Digital Equipment of Canada, Ltd. Europe: 81 Route de l'Aire, 1211 Geneva 26, Tel. 42 70 50.

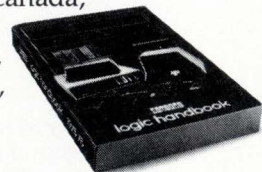

**digital**  
**COMPONENTS**  
**GROUP**



## Geometry separates microwave channels in branching filter

To make a microwave branching filter, designers traditionally use a series of circulators and narrowband filters to divide the wideband signal into narrowband channels. Not only is this kind of filter difficult to design, but when a large number of channels is involved, it becomes very complicated.

Now, two University College of London designers have developed a novel field-focusing filter that branches frequencies by focusing them instead of filtering them. The concept, borrowed from principles used in frequency-scanning antennas, employs a curved waveguide with slots or radiators along its inner side to focus the individual channels. The development is being explained in a paper by D.E.N. Davies and A.Y. Niazi of the college's department of electrical engineering at this month's Microwave 76 conference in Rome.

The department has constructed two experimental stripline five-channel filters, one covering 2.6 to 3.8 gigahertz and the other, 8 to 10.2 GHz, with insertion losses of 5.5 and 9 decibels, respectively. These high insertion losses are caused mainly by the experimental method of construction, Davies says. An even smaller version on an alumina substrate is the next step in the project, which is supported by the Science Research Council and Microwave Associates Ltd., Dunstable.

Because of its performance, the design looks as if it would perform well as a front-end filter in multi-band microwave communications above 3 GHz and in passive electronic listening systems, Davies surmises.

**Operation.** A wideband microwave signal is fed into the curved waveguide, the separate narrowband signals are radiated from the various slots, and the different frequencies are then focused at different points along the diameter, or focal plane, of

the waveguide. The filter functions like a curved antenna feeding into receiving horns. Because a receiving horn at each output accepts only a particular frequency, the outputs of the array of horns function like the output ports of a branching filter.

One advantage is that the field-focusing filter is a simple way to get a large number of filtered output channels, Davies states. Another is that, unlike conventional branching filters where lossy material can dissipate the signal, "here, the frequency response is determined purely by the geometry," he says, referring to the

interior slots and focusing notches. And, since the filter is naturally matched at all frequencies, it doesn't need stopband filters like others.

Disadvantages are that the insertion loss tends to be higher than it is in conventional filters; the suppression of unwanted frequencies outside the pathband isn't as good as with conventional filters, and, in waveguide form, the field-focusing filter would be too large for use with frequencies below the X band, he says. That is because the diameter must be five times the wavelength of the wideband signal. □

### Around the world

#### Lumped elements used in L-band hybrids

For gigahertz frequencies, hybrid circuits with lumped elements are smaller, lighter, have a large bandwidth, and are potentially cheaper than distributed-element circuits. The trouble is, with traditional technologies, it's practically impossible to fabricate lumped circuits suitable for frequencies higher than 3 or 4 gigahertz. However, Lignes Télégraphiques et Téléphoniques has come up with a way to make RLC lumped circuits for much higher frequencies. The ITT subsidiary has gone into pilot production with an L-band oscillator covering 0.6 to 1.66 GHz, and 10-GHz versions on the market in about a year. ITT packages its circuits in TO-8 cans making them one fifth the volume of a conventional distributed-element circuit.

One essential for the LTT's bound upward in frequency is the way the substrate is treated. LTT starts with a slice of optically flat fused quartz some 300 micrometers thick and handles it like silicon, etching about 15 to 20  $\mu\text{m}$  off the surface. Then comes a layer of chrome several hundred angstroms thick, which makes way for evaporation of another layer of silver between 5 and 10  $\mu\text{m}$  thick. Inductances and interconnections are photoetched into the silver. LTT has developed beam-lead capacitances with silicon nitride as the dielectric. Capacitance values range from 0.5 to 10 picofarads. Series resistance of less than 1 ohm at frequencies to 18 GHz.

#### Photo SCRs switch 200 A at 2.5 kV in lab

Some day, photo silicon controlled rectifiers are likely to provide voltage ratings as high as those of nonoptical gate-fired types. In an intensive development program, AEG-Telefunken in West Germany is shooting for high-power devices that can handle several thousand volts and more than 100 amperes. Interim results indicate that photo SCRs could one day replace bulky magnetic-pulse transformers. More important, perhaps, noise pulses that can cause false triggering of conventional SCRs won't interfere with the photo-optical type because coupling capacitances are negligible.

AEG-Telefunken is working in the laboratory with 1.2- and 2.5-kV photo SCRs that have a forward mean current of 200 A, far above those achieved thus far by other photo SCRs. Currently available units check in with values of less than 500 V and well below 10 A.



# Here's why REI can rent you what you want when you want it.



Our inventory. It's the biggest in the industry, with over 8,000 items of electronic test equipment in stock and ready to go. And it's getting better all the time, because we add more state-of-the-art equipment every month. This means we can deliver one special instrument... or a dozen... within hours of the time you place your order.

Now, more than ever, renting makes sense... to stretch your equipment budget, to fill temporary needs, and to avoid the long delivery lead times associated with purchasing. And renting from REI makes even more sense... because we're better equipped to fill your needs than any other rental company.

REI is backed by the tremendous resources of the PepsiCo organization, which gives us the financial strength to keep on hand whatever test equipment you may need. And renting from us helps *your* financial strength,

too. Since you pay only for the time you have your instruments, you'll never have to spend your money on idle equipment.

Send for our catalog today for a description of our rental, rental/purchase and leasing plans, and for our low rental prices. Or call the instant inventory center nearest you for immediate assistance.

Rental Electronics, Inc.,  
99 Hartwell Avenue, Lexington, Mass. 02173.  
Please send me your free instrument rental catalog:

Name \_\_\_\_\_ Title \_\_\_\_\_

Company \_\_\_\_\_

Address \_\_\_\_\_

City \_\_\_\_\_ State \_\_\_\_\_ Zip \_\_\_\_\_

Tel. Number \_\_\_\_\_

## Rental Electronics, Inc.

A PEPSICO LEASING COMPANY

Burlington, MA (617) 273-2770 • Gaithersburg, MD (301) 948-0620 • Oakland, NJ (201) 337-3757 • Ft. Lauderdale, FL (305) 771-3500  
Des Plaines, IL (312) 827-6670 • Dallas, TX (214) 661-8082 • Mountain View, CA (415) 968-8845 • Anaheim, CA (714) 879-0561  
Rexdale, Ontario (PLC Leasing Ltd.) (416) 677-7513

Circle 64 on reader service card

SEE US AT WESCON/76 IN L.A., SEPTEMBER 14-17, BOOTH #493



### **Hitachi develops 256-kb, 9-mm-square bubble memory**

Researchers at the Central Research Laboratory of Hitachi Ltd. have developed a bubble memory chip 9 millimeters square with capacity of 256 kilobits. The achievement is part of the Japanese government's project for a pattern-information-processing system. **Each memory cell is only 16 micrometers square.** The excitation frequency is 100 to 300 kilohertz, and the average access time is 3 to 10 milliseconds.

Bubbles in this memory, only 4  $\mu\text{m}$  in diameter, are propagated through a single crystal epitaxial layer of yttrium iron garnet. Permalloy patterns that guide bubbles have line widths of only 2  $\mu\text{m}$ , which probably represents the limit of optical photolithography, and larger-scale integration will have to be accomplished by electron-beam lithography.

### **UN agency plans satcom network to serve the seas**

A \$20 million worldwide maritime satellite-communications system for the 1980s has been agreed to by the Inter-Governmental Maritime Consultative Organization, the United Nations maritime agency. Competitive bids could be sought within three years. Initial plans call for a three-satellite system covering the Atlantic, Pacific, and Indian Oceans to provide high-speed data, automated telephone, and radio-teleprinter links between earth stations and shipboard terminals. Further details will be decided when the London-based governing body, Inmarsat, meets in January. **It is understood that shipowners will have to provide their own terminals, and this could produce a healthy market.** Until the new network gets going, Inmarsat may lease space on Marisat, Marots, or Intelsat.

### **Philips to launch counter/timer line into U. S. market**

Philips, which has become a major supplier of oscilloscopes in the United States, has geared up for a massive push into the fast-growing \$55 million American counter/timer market. The Netherlands company, which four years ago started from square one with oscilloscopes, is trying again with almost a dozen new counters at the mid-September Wescon show in Los Angeles, plus a couple of new oscilloscopes for good measure.

Philips officials are keeping tight wraps on details of the new counter/timers before their Wescon introduction, but **European market watchers are sure that Philips is sticking to the "factory-modular" approach it developed for the earlier counter/timer lines** it's been marketing outside the U.S. This strategy enables a wide range of instruments built around a fairly small number of modules—oscillators, time bases, front ends, and the like—to be aimed at a single market segment, possibly telecommunications. Look for a couple of fully automatic instruments, with an on-off switch as the only control, to turn up in the new line.

### **Germanium-doped optical fibers set performance record**

Researchers at the Philips laboratories in Aachen, West Germany, have developed germanium-doped optical fibers exhibiting a bandwidth of about 1.5 gigahertz and an attenuation of 1.4 decibels per kilometer. Philips claims the combination is the best achieved so far by germanium-doped fibers. The new technique is based on electrically excited reagents used in the chemical vapor-deposition process. The fiber profile can be adjusted with a high degree of accuracy, and that, in turn, leads to the excellent values for bandwidth and attenuation.



### **Luxembourg firm to compete in U.S. with magnetic VDR**

When MCA/Philips and RCA begin marketing their video-disk systems in the United States next year, they will be facing competition from at least one European producer. Luxembourg-based Magnetic Disc Recording, which will show its magnetic stereophonic video-disk recorder for the first time at the Vidcom exhibition in Cannes, France, from Sept. 23 to 28, plans to enter the U.S. market next year. **MDR claims its system is the only one that provides both video-in and video-out with a magnetic disk.**

### **Victor Co of Japan uses 1/2-in. cassette to challenge VTRs**

The Sony U-Matic and Matsushita video-tape recorders are getting a stiff challenge from a two-head helican-scan half-inch tape system introduced by Victor Co. of Japan. Sales of the \$892 VTR will begin next month. **Although it uses cassettes only about half the size of the one-hour 3/4-inch cassette for the Sony machine, they can play for two hours.** Dimensions are 104 by 188 by 25 millimeters. Tape speed has been reduced to 33.35 millimeters per second.

To keep prices low, the tape is made of ferrite containing cobalt. Prices of the loaded Victor cassettes are \$20.90 for the two-hour version, \$13.95 for the one-hour one, and \$9.75 for a half-hour type. The efficient tape format and new noise-reduction circuit enable the recorder to play back video signals with a signal-to-noise ratio of 42 decibels and 240-line horizontal resolution, despite the low tape speed.

### **Signal generator from British firm simplifies tuning**

A signal generator that has totally synthesized performance with analog tuning from 5 to 520 megahertz is being offered by Britain's Racal Instruments Ltd. for half the price of competing devices. **The key to the \$3,600 model 9081 is a spin tuning wheel that eliminates a series of decade switches usually needed to tune over five bands.**

The 29-pound unit is built around a version of Ferranti's complex bipolar large-scale-integrated circuit at the heart of Racal's successful 99 series of instruments. The 9081's channelized operation with front panel enables any radio-equipment engineer to immediately get any frequency he wants and choose a step size equaling any standard channel spacing between 50 and 60 kilohertz. It also offers a-m, fm, phase modulation, and automatic leveling of output, as well as a built-in frequency meter.

### **Photoresists boost resolution on ICs**

Two new types of high-sensitivity positive resists for electron-beam lithography of integrated circuits have been jointly developed by Matsushita Research Institute Inc. and Fuji Chemicals Industrial Co. Their resolution exceeds 0.5 micrometer. Sales of these two resists, Fuji Micro Resist E100 and E101, will start at year-end. Initially, demand is expected to be mostly for making fine-pattern masks for photo-lithography, but eventually, these resists will be used directly on semiconductors for even finer patterns needed for very-large scale integration.

The sensitivity of the new positive resists, developed by removing the coating exposed to an electron-beam source, far exceeds that of coatings announced earlier by IBM corp. and Bell Laboratories. **This sensitivity enables an electron source to expose a pattern one or two orders of magnitude faster.** Sensitivity of FMR-E-100 is  $4 \times 10^{-7}$  coulombs per square centimeter at an acceleration voltage of 10 kilovolts, and sensitivity of FMR-E101 is  $2 \times 10^{-7}$  C/cm<sup>2</sup>.



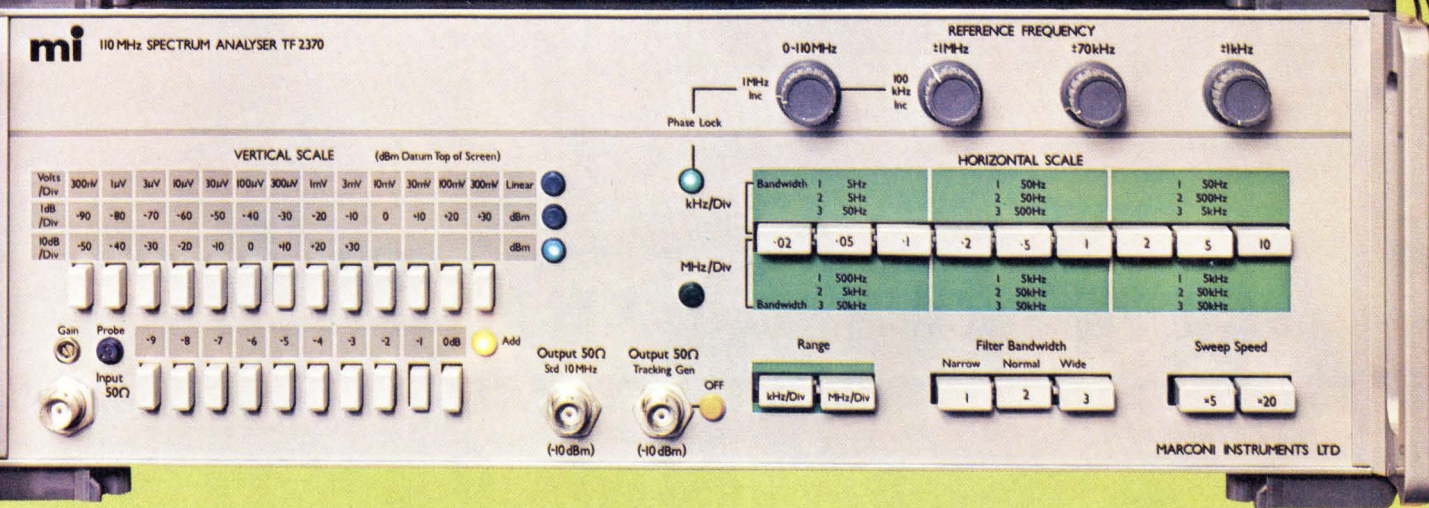
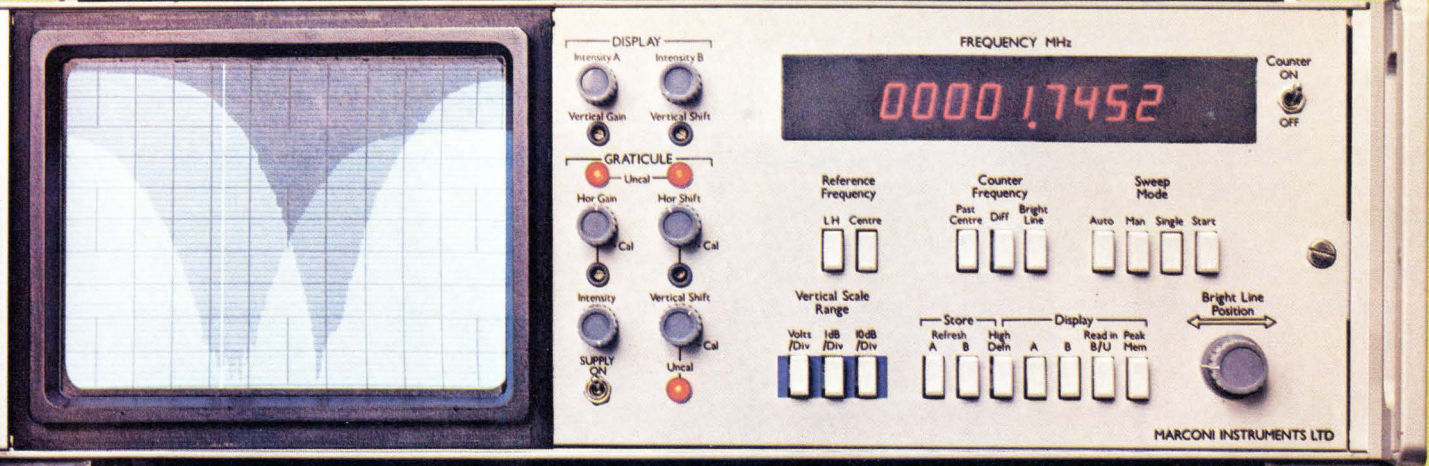

# you've never seen a faster, more accurate way of measuring frequency response from 30 Hz to 110 MHz

Save your skilled engineers for more important work with **mi** Model 2370 Spectrum Analyzer. Simplify complicated measurements such as *response, level, gain, signal purity, modulation* and many more. Forget everything you have heard about spectrum analyzers. **mi** Model 2370 is unique. It employs advanced technology to make it as easy to operate as a multimeter. The facts speak for themselves.

- Flicker-free high brightness TV display (No more storage tubes to replace)
- Electronic graticule can pin point position of waveform display for rapid analysis and measurement.
- Choice of vertical scales: linear, 10dB/div for 100dB display, and 1dB/div for 0.1dB resolving power.
- Counter **automatically** displays center frequency, identifies the frequency corresponding to the manually

adjusted 'bright line cursor', or the difference frequency between the two. All to an accuracy of 2Hz.

- Integral synchronous signal source for measuring *networks, filters, amplifiers*, etc.
- For comparative measurements, memory storage can retain one display indefinitely, for simultaneous display with waveform from items under test.
- **Automatic** adjustment of amplifier gain to *optimize* noise performance.
- **Automatic** selection of *optimum* sweep speed.
- With the 5Hz filter, signals 100Hz from a response at 0dB can be measured to better than -70dB.

Such speed and accuracy must be seen to be believed, call us for an enlightening demonstration.



Circle 67 on reader service card



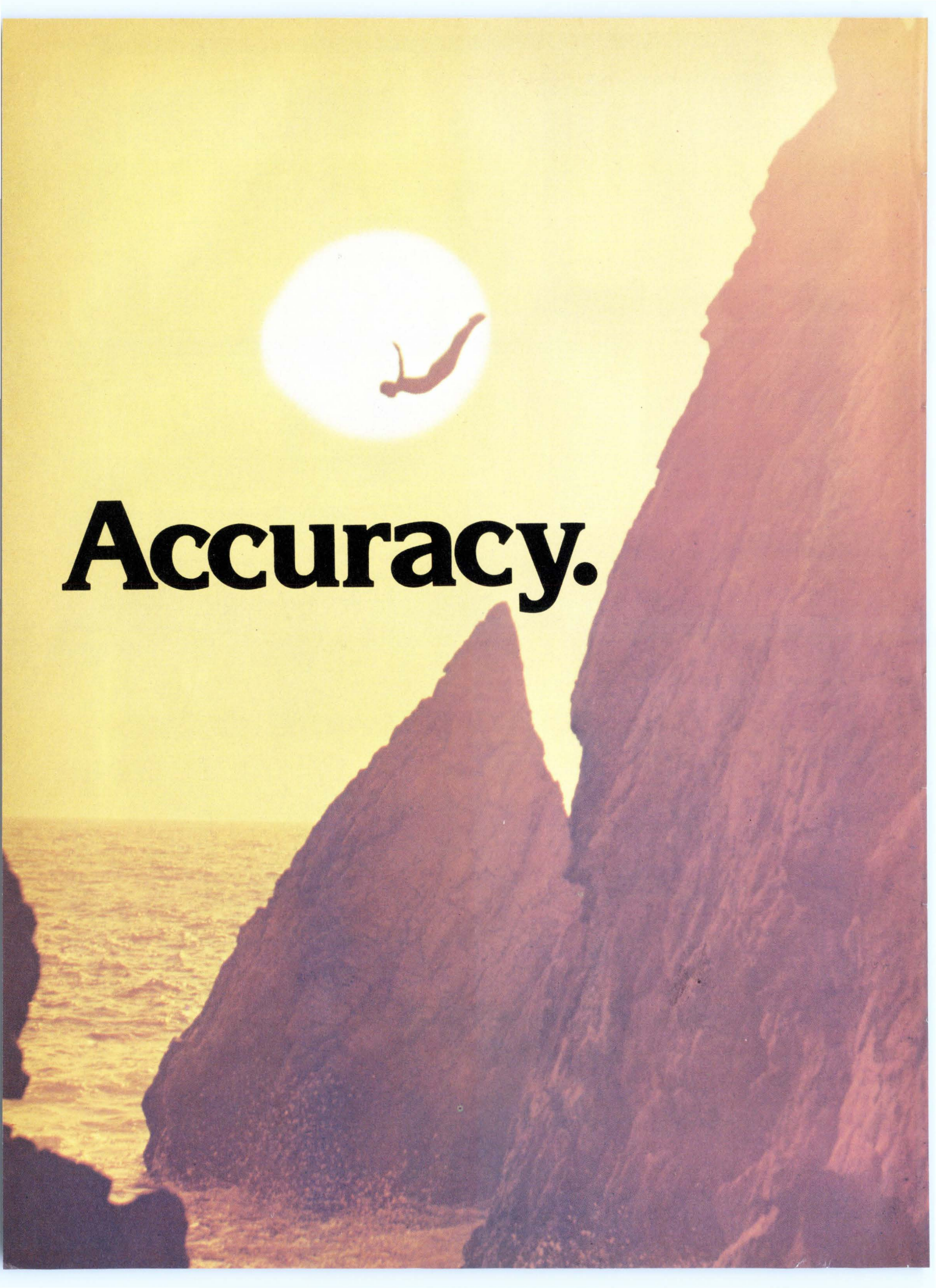

**Accuracy.**





**Model 175**  
 the world's most accurate 3½ digit miniature portable \$189.



**Model 3400**  
 the world's most accurate 4½ digit lab and systems multimeter \$795.



**Model 7500**  
 the world's most accurate high speed 5½ digit systems multimeter \$2995. base



**Model 245**  
 the world's most accurate 4½ digit portable \$295.

**When  
 you want  
 the world's  
 most accurate  
 multimeters...**

**you want  
 Data Precision  
 multimeters.**

For a demonstration or a copy of our comprehensive Digital Instrumentation catalog contact Data Precision Corporation, Audubon Road, Wakefield, Mass. 01880, USA Phone (617) 246-1600, Telex (0650) 949341

Price U.S.A.

**DATA PRECISION<sup>®</sup>**  
**...years ahead**

For additional information circle 68 on reader service card.  
 For demonstration circle 69 on reader service card.



# OAK does more than provide a complete

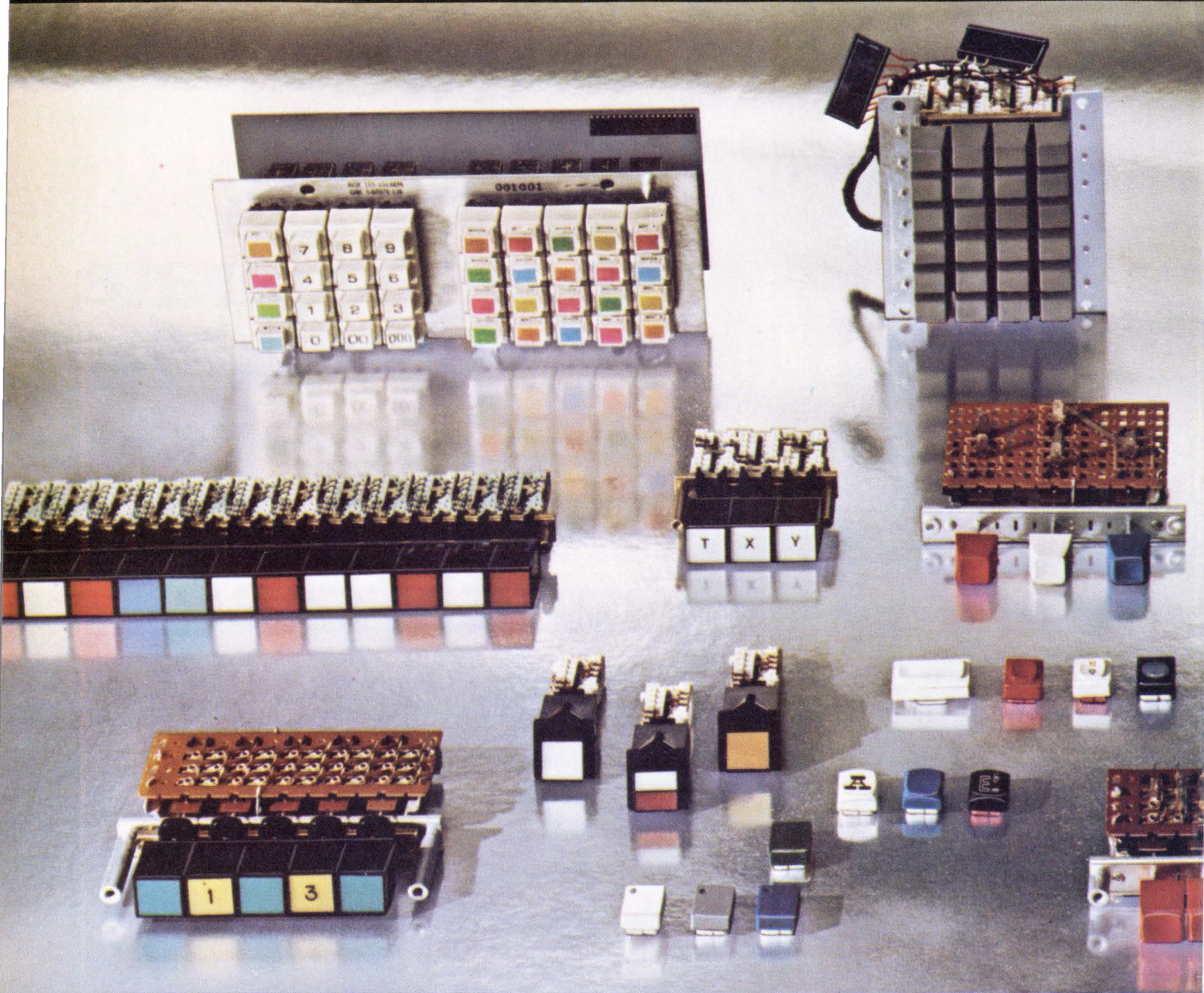

It isn't just the wide range of switches. It's what Oak will do with them—for you—that should make Oak your preferred supplier.

You can get switch assemblies mounted on a custom PC board or metal bracket, or completely wired with cables, harnesses and connectors, including stamped or machined parts ready for installation in your equipment. And it's all done in-house on Oak production equipment and assembly lines.

Of course, we can supply all of your simpler requirements as well, including an almost unlimited selection of switching configurations, cap legends, styles and colors for lighted or unlighted switches. Contact your Oak sales offices, distributors or call for price and delivery information.

1. Data input keyboard for financial systems. Series 400 switches with aluminum panel and PC board. Special removable caps permit rapid legend changes for reprogramming.
2. Banking terminal input device using Series 300 switches. Completely wired with harness and connectors.
3. Data input using Series 475 switches, flow soldered to customer's PC board.
4. Series 415 and 415 Light Emitting Diode Switches on PC board, with discrete components attached on back.
5. Program selector keyboard of Series 475 switches assembled with aluminum panel and printed circuit boards used for coin operated equipment.



# line of push-button and keyboard switches

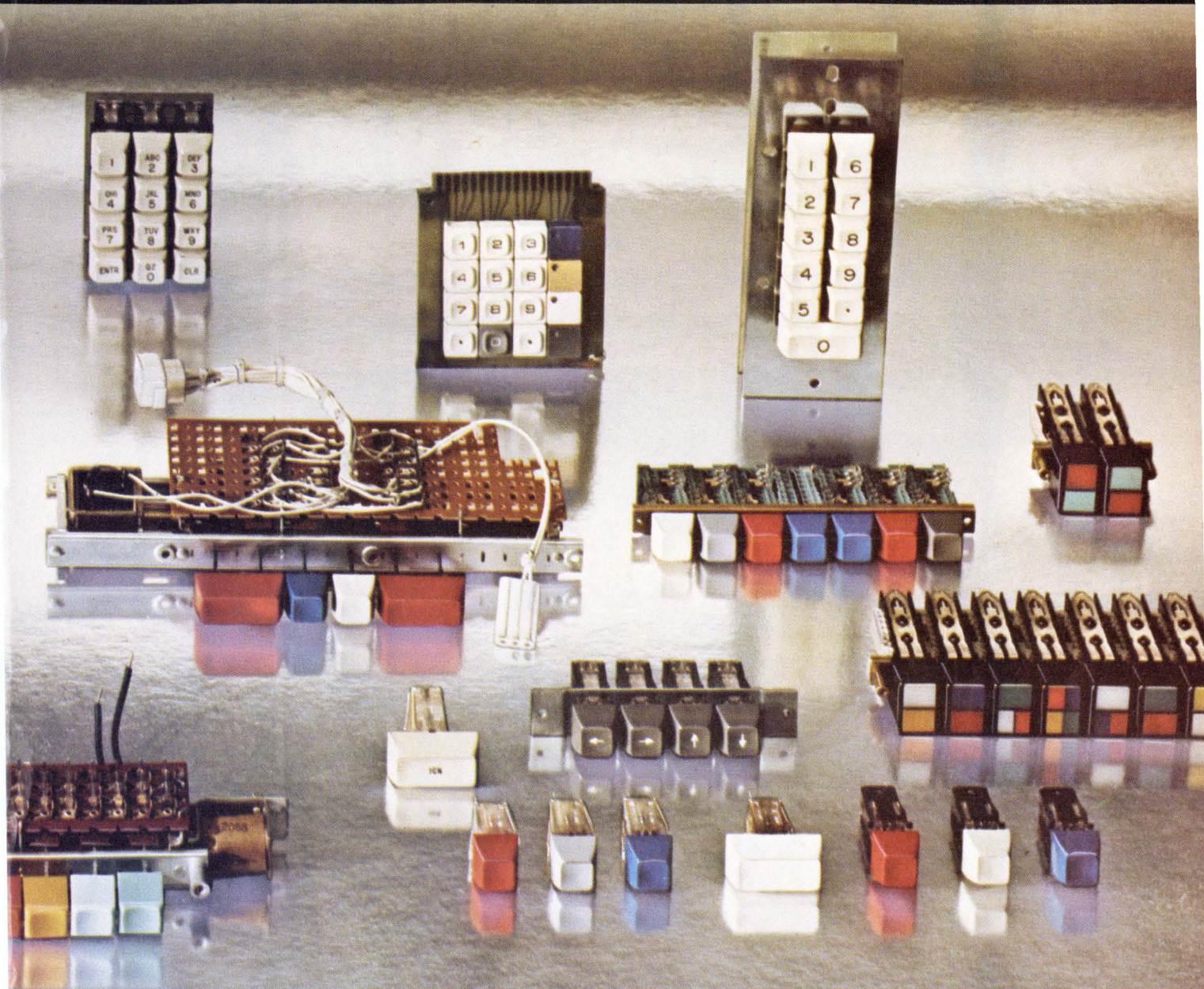

**6.** Series 300 switches, single and ganged, lighted and unlighted, can be supplied completely wired.

**7.** Series 130 switch, for rugged applications where more switching capability is required. Terminal board is integral part of switch assembly.

**8.** Microwave oven switch assembly with quick-disconnect terminals using Series 130.

**9.** Facsimile transmission assembly with special mounting bracket, wiring, cable and connector, and solenoid for clearing all Series 130 switches.

**10.** Unlighted Series 300 switches can be supplied in almost any conceivable switching combination of alternate, momentary, interlock and lockout.

**11.** Bank security code system uses 4-lamp, 4-display Series 300 switches. As many as 12 switches can be prewired, to customer specifications, in a single bank.

**12.** Very low profile, low cost Series 415 switches are available in five different button styles in a wide range of colors.

**13.** Series 415 switches with LEDs, on a separate circuit, vastly improve error-free operator performance of data input devices.

**14.** Microwave oven assembly with solenoid for latching release, partially wired to customer requirements.

**15.** Series 400 and 475 keyboard switches can be supplied assembled in Oak produced brackets, or individually, with or without snap-in mountings.

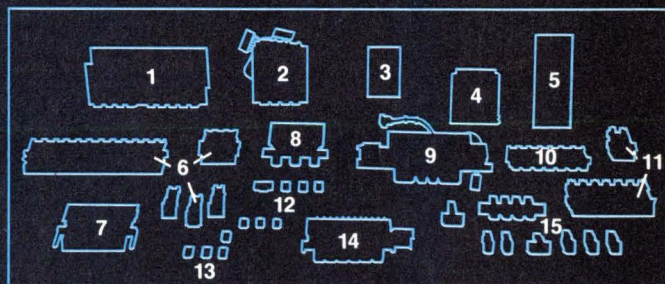

**OAK Industries Inc.**  
**SWITCH DIVISION** / CRYSTAL LAKE, ILLINOIS 60014  
 TELEPHONE: 815-459-5000 ■ TWX: 910-634-3353 ■ TELEX: 72-2447

Circle 71 on reader service card







# You get exactly the resistor you need for your application.

## No compromises. No "favorites." Just quality.

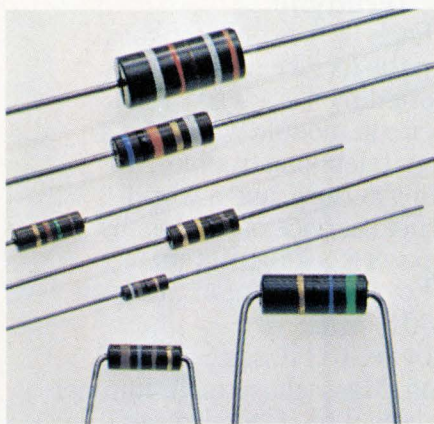

### Carbon comp.

Billions used in consumer, industrial, military applications. TRW/IRC carbon comp. capability ranges from standard commercial types through established reliability RCR's, to ultra-high range ( $10^{11}$  ohms). Where you're using carbon comp.'s in automated assembly, TRW/IRC packaging options can help cut the cost of interfacing with your machines. Card packs, lead tape reels, cut and formed leads... we'll be glad to explore the potential economies with you.

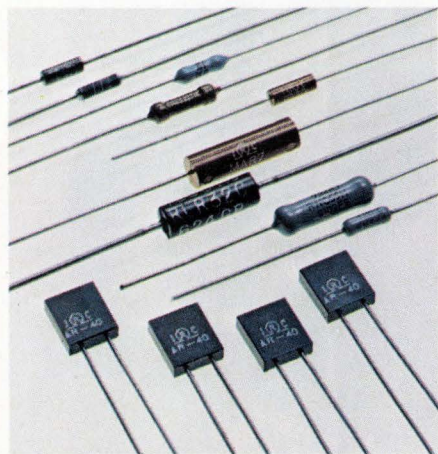

### Metal Film

TRW/IRC has brought the state of the art in thin-film to a performance level equaling high-stability wirewounds. Capabilities include resistors with tolerances to  $\pm 0.01\%$  and  $\pm 3$  PPM T.C. ... high-rel units... precision subminiatures... and, of course

the popular RN's. You can also look at alloy films offering high-temperature and high-voltage capability at low cost.

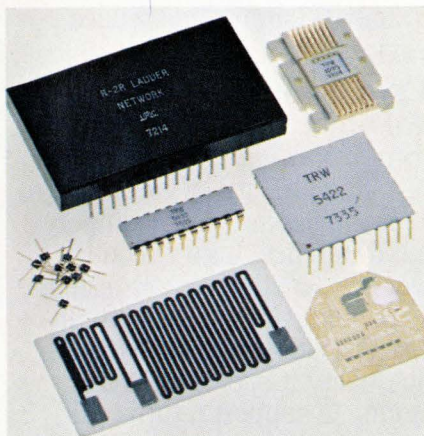

### Resistive Networks

Advanced resistor technology here. These IC compatible, precision tantalum-film circuits provide inherent low noise, excellent stability, and hermetic performance without hermetic cost. Tolerances from 5% to 0.05% available in custom designs. TRW/IRC also offers the industry's most complete line of discrete fixed resistors.

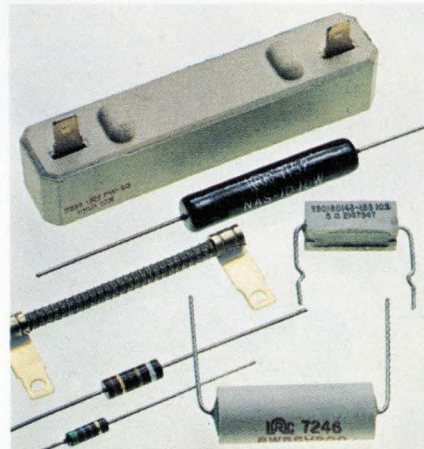

### Wirewound

The line starts with molded wirewound resistors—"space-savers" that bridge the cost-performance gap between composition resistors and precision wirewounds. It proceeds to standard, non-insulated types

for appliance/automotive use... to precision subminiatures offering high power density... to low cost fusible, flameproof units for consumer and industrial applications... to tubular and flat power wirewounds with ratings to 250 W.

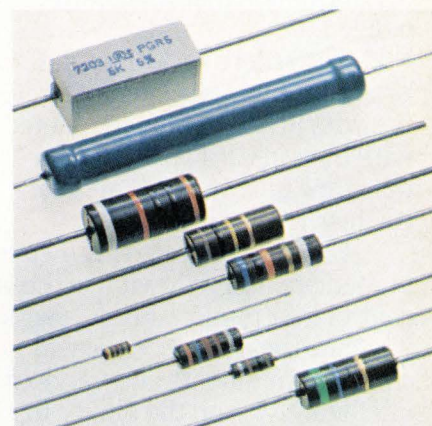

### Metal Glaze™

This is TRW/IRC's thick-film technology—for all types of low power resistor applications. Metal Glaze is widely accepted for its built-in power handling reliability, resistance range, and cost effectiveness. Numerous standard and special designs—precision, semi-precision, flameproof, high-rel, high-voltage.

### All types... all technologies... one source

To wrap it up, TRW/IRC offers you the most complete line of fixed resistors in the business, with many of the popular types available from one source—your local TRW/IRC distributor. Having a direct pipeline to each of our plants, he can give you fast delivery.

Contact your local TRW sales office for application assistance, custom designs, and special engineering help when you need it. TRW/IRC Resistors, an Electronic Components Division of TRW, Inc. Plants at Boone, N.C., Burlington, Iowa, and Philadelphia, Pa. Write TRW/IRC Resistors, 401 N. Broad St., Philadelphia, Pa. 19108. Or call (215) 923-8230.

**TRW IRC RESISTORS**  
ANOTHER PRODUCT OF A COMPANY CALLED TRW  
Circle 73 on reader service card



# TERADYNE'S J401: THE FULL CAPABILITY IC TEST SYSTEM EVERY ENGINEER CAN USE.

Until now, the complexities of test programming have kept all but a few specialists from using IC test systems. Everyone else had to queue up at the programmer's desk or do without the kind of information that was really needed.

Now there's a J401. A fully programmable test system for T<sup>2</sup>L ICs with up to 24 pins, complete with built-in CRT, printer, and mag tape unit, that any engineer can learn to use in minutes.

For IC producers this means immediate access to vital process control information. For IC users it means the data necessary to choose components and vendors intelligently. And the ability to extract from field returns the information needed to improve product quality and yield.

## **The performance and flexibility of a large, computer-operated test system.**

The J401 delivers the flexibility ordinarily associated only with larger, more expensive systems. It can datalog any forced or measured function and it can generate an x-y plot of any two parameters. The system also operates as a high throughput go/no-go tester for the production line or incoming inspection.

## **Product data fast.**

## **Higher product yield.**

For the semiconductor manufacturer, the easy-to-use J401 allows errors to be spotted before they can begin to multiply. QC engineers can use it to evaluate devices, determine test margins, and check device lots.

The electronic equipment manufacturer will find the J401 useful in monitoring vendor-to-vendor and lot-to-lot variations.

It enables him to spot device characteristics that could be contributing to problems. And QC personnel can use the system to analyze failures and reduce service costs.

## **A system for meeting the real objectives of incoming inspection.**

The J401 gives you fast go/no-go testing with an important difference. It gives control over the way devices are tested. By pushing a few keys you can change test conditions, bin out top-quality ICs, or have data-logging to support returns. All in seconds. This is incoming inspection as it should be.

## **It's a Teradyne.**

Each J401 is built for hard use on the factory floor. Each is supported by Teradyne's ten-year circuit module warranty, a 24-hour telephone trouble-shooting service, and a worldwide field service backed up by local parts stocking centers.

For complete information on the J401, write:  
Teradyne, 183 Essex Street,  
Boston, Massachusetts. In Europe:  
Teradyne, Ltd., Clive House,  
Weybridge, Surrey, England.

WE SELL PRODUCTIVITY.

# TERADYNE

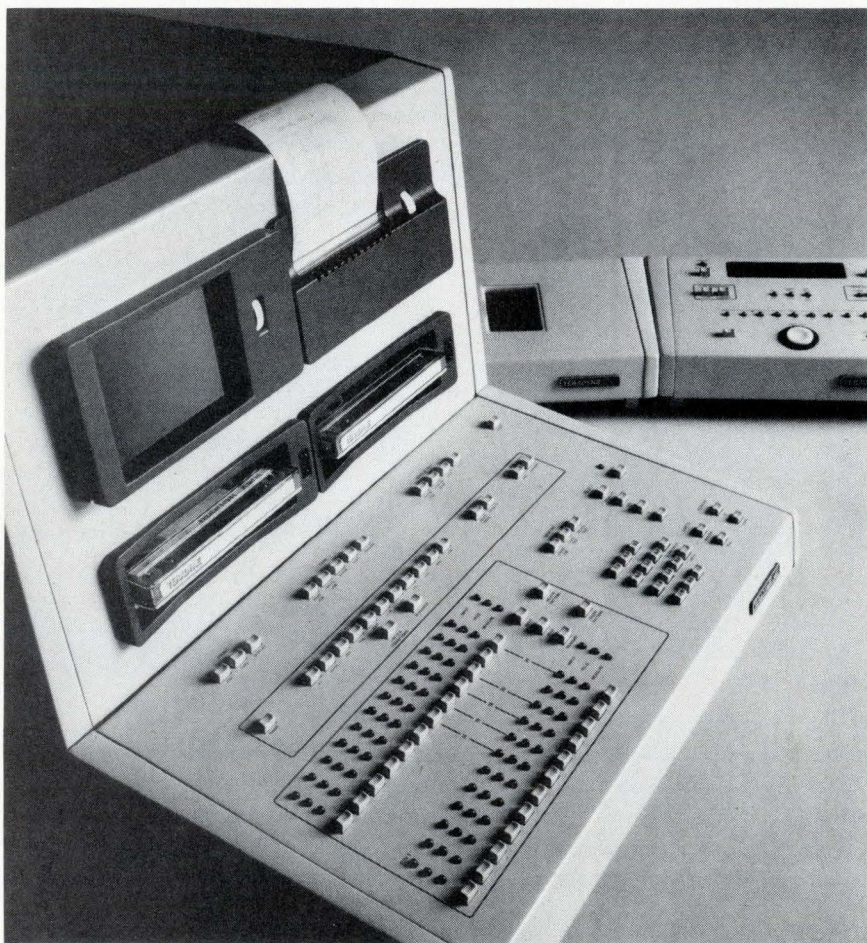

CHICAGO (312) 298-8610/DALLAS (214) 231-5384/NEW ENGLAND (617) 458-1256/NEW YORK (201) 334-9770  
SUNNYVALE (408) 732-8770/LONDON (0932) 51431/PARIS 073 16 98/ROME 59 47 62/MUNICH (089) 33 50 61/TOKYO (03) 406-4021



## Does EMC wear rose-colored glasses?

Critics say group's studies of engineering manpower demands actually encourage colleges to swell already oversupplied market

by Bruce LeBoss, New York bureau manager

Many methods are used to predict manpower demand, but it's questionable if any of the means of collecting and assessing data is scientific and accurate. As a result, those in engineering schools and in industry who use the data may be misleading students about engineering-career opportunities.

A growing chorus of critics is demanding changes in the way such studies are done, and their major complaint is about data emanating from the Engineering Manpower Commission. They have a strong case.

The EMC studies have been issued since the 1950s and each spring and fall from October 1973 through April 1975, and the next is due next year. They provide ammunition for high-school guidance counselors and college deans to steer students toward engineering schools. And the studies' methodology is less than painstaking. Instead of a more scientific approach, employers are merely asked about their anticipated needs (see "Enough methods to go around," p. 78). So, while engineers' jobless rolls grew, the studies continued to talk about shortages.

One of the ironies of the situation is that the EMC is the research arm of the Engineers Joint Council, an organization in New York, sup-

ported by 36 societies. The IEEE, one of the larger professional societies, is not a member of the council, although it has helped underwrite past EMC studies. It is the members of those societies who are hurt most by the oversupply of engineers, a situation that is created in part by work they are financing through their dues. Not only that, but the EMC's figures are among those used by the U.S. Bureau of Labor Statistics to compile its much used "Occupational Outlook Handbook."

**Shortcomings.** The major shortcomings of studies such as the EMC's were pinpointed by the IEEE itself three years ago [*Electronics*, Dec. 6, 1973, p. 75]. In its "Career Outlook in Engineering—I," the IEEE concluded: "The most serious deficiencies in the various series of national data are inconsistency in definitions, lack of essential detail, and lack of coverage. Taken together, these deficiencies reveal the absence of a co-

ordinated manpower policy, so that what exists is a collection of loosely related statistics of uneven quality and completeness."

Nothing has been done since then to improve matters. In fact, the author of that section of the IEEE report, Robert A. Rivers, is still sounding his alarm. Rivers, president of Aircom Inc. of Union, N.H., and a member of the EMC, charges that "most of EMC's verbiage is aimed at maintaining the educational input and output of engineers." Rivers says the trouble is that there was an average increase of 35,000 engineering jobs each year during the 1950s and 1960s. Since then, he says, employment has actually dropped an average of 10,000 annually, "but the educational system hasn't adjusted to meet reality." He adds that some 300,000 engineers have been abnormally eliminated or dislocated from engineering since 1969.

Rivers says there is an inherent bias in employer-derived surveys such as those conducted by the EMC. "People in industry are always bidding on and expecting more business than they actually get," he says. "Thus, when they are projecting engineering demand, they hedge their bets and overforecast."

**Attitude.** Part of the reason for the inertia on sharpening the EMC's data

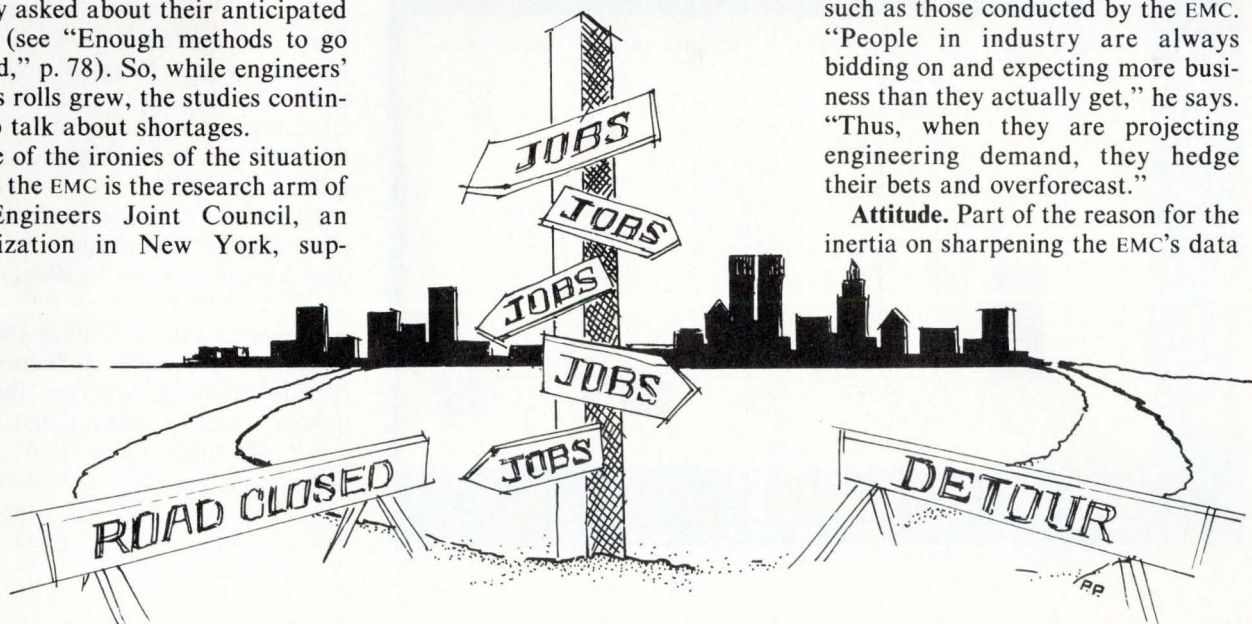



## Probing the news

stems from the attitude of the Engineers Joint Council. Says Carl Frey, executive director, "The EMC is part of the EJC, so we could hardly disapprove of what they're doing." He adds that the EMC's raw data "is simply a collection of projections made by those in industry we ask. John [D. Alden, EMC's executive secretary and director of manpower activities for the joint council] just collects these opinions. We don't believe that publishing them does any harm. The information is available to be interpreted by any intelligent engineer in the way he wants to interpret it." Frey adds that he doesn't believe any student actually bases his or her career decision on the EMC findings.

That view would seem to be naive if not downright wrong, according to a sampling of engineering schools. Says Nunzio Palladino, dean of engineering at Pennsylvania State University: "The findings of the Engineering Manpower Commission influence us greatly in our counseling. Oftentimes, parents and students are interested in whether or not there will be job opportunities in certain fields and what the future looks like, so we draw on the EMC figures. They also give us a basis in our planning, as they are a clue to

whether we can expect a big influx of students for certain fields, since the students are influenced by what they read about demand."

And at New York City's Cooper Union University, C.W. Tan, dean of engineering, says that the EMC data "is used mostly to modify our engineering education to meet future needs, as well as to modify our curriculum to meet the needs of engineers. We use it to determine what elective offerings we should have, what courses we should develop, and what's out there in industry in terms of manpower needs so that we could emphasize such in our curriculum and in our student counseling."

**The cost.** How much does an EMC study cost, and how does it proceed? The cost of gathering data, processing it, and getting it ready for publication is \$10,000 to \$15,000, says Alden. The unit currently has a request before the National Science Foundation for a grant of \$53,175 to cover two 1977 studies. But if the request is rejected, which seems likely, the EMC hopes to resume the survey in 1977, anyway, budget permitting.

The method employed by EMC, explains Alden, involves surveying large numbers of employers for the number of engineers currently employed, the number of active job openings, and anticipated hiring and

losses during a stated period in the future. For its last demand survey, the responses were received from 188 manufacturers, 178 non-manufacturers, 70 government agencies, and 150 educational institutions. In addition to published reports, the EMC's findings were disseminated via news releases and summaries sent to several hundred journalists and at major conferences where Alden spoke to numerous deans of engineering schools.

Among the approximately three dozen electronic-equipment manufacturers who responded to that April 1975 EMC survey were Bendix Corp., Emerson Electric Co., Fairchild Camera & Instrument Corp., General Dynamics Corp., and Motorola Inc. But industry seemingly attaches little importance to the surveys. A spokesman for one West Coast electronics firm says, "The survey doesn't provide us with any great information. We're more concerned with our own needs than the rest of the industry's."

**Planning.** Like Emerson's Rantec division in Los Angeles, where a spokesman says his firm "doesn't pay much attention to the EMC findings," Motorola in Chicago determines its engineering needs solely from within, based on forecasts from top management, augmented by marketing and engineering personnel. But an exception to the general attitude industry has toward the EMC findings is Monsanto Co. in St. Louis, which receives information about the supply of engineers from within the industry, its own research, and from the EMC surveys. A Monsanto spokesman says the EMC figures, which he gets indirectly from other groups, "influence the company in making plans for the future." And he believes them to be quite accurate.

Hans C. Cherney, a personnel administrator at International Business Machines Corp. in Poughkeepsie, N.Y., like Rivers an IEEE representative on the EMC, finds that the forecasts "are really influenced by outside interests, whether they be industry and/or educational interests." He also notes that, while demand is closely connected to economic forecasts, "right now, the EMC doesn't have a good clear

**Ups and downs.** This comparison of EMC demand figures and those of Robert Rivers is an example of how such studies might differ. EMC surveys employers.

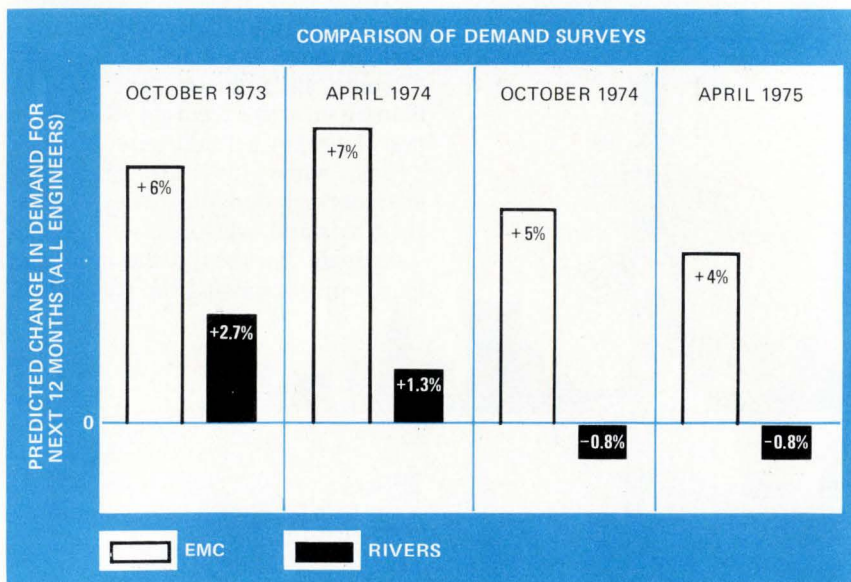



What's new in solid state...

# RCA breaks another SOS speed barrier with 90 ns 1K RAMs.

Now more than ever, RCA is making good on the speed/power promise of SOS. As the table shows, you now have much more design flexibility. Two organizations to choose from. Two levels of performance. All with very low operating power. Both of the 1024x1 devices are pin compatible with CMOS 6508 and bipolar 93415 types. And our 256x4 devices are pin compatible with CMOS 5101.

Moving fast, RCA has fully geared up to produce SOS. So we're ready now to bring you the dramatic system savings and wide usefulness made possible by our advanced SOS/CMOS technology.

For more information, contact your local RCA Solid State distributor. Or RCA.

Type	Organization	Access Time	Power Supply	Power @ 1 MHz
*MWS5001D	1024x1	150 ns typ.	5 V	4 mW
MWS5501D	1024x1	90 ns typ.	10 V	20 mW
MWS5040D	256x4	150 ns typ.	5 V	4 mW
MWS5540D	256x4	90 ns typ.	10 V	20 mW

\*Previously announced

Write: RCA Solid State, Box 3200, Somerville, N.J. 08876; Sunbury-on-Thames, Middlesex TW16 7HW, England; Ste. Anne de Bellevue H9X 3L3, Canada; Fuji Building, Tokyo, Japan.

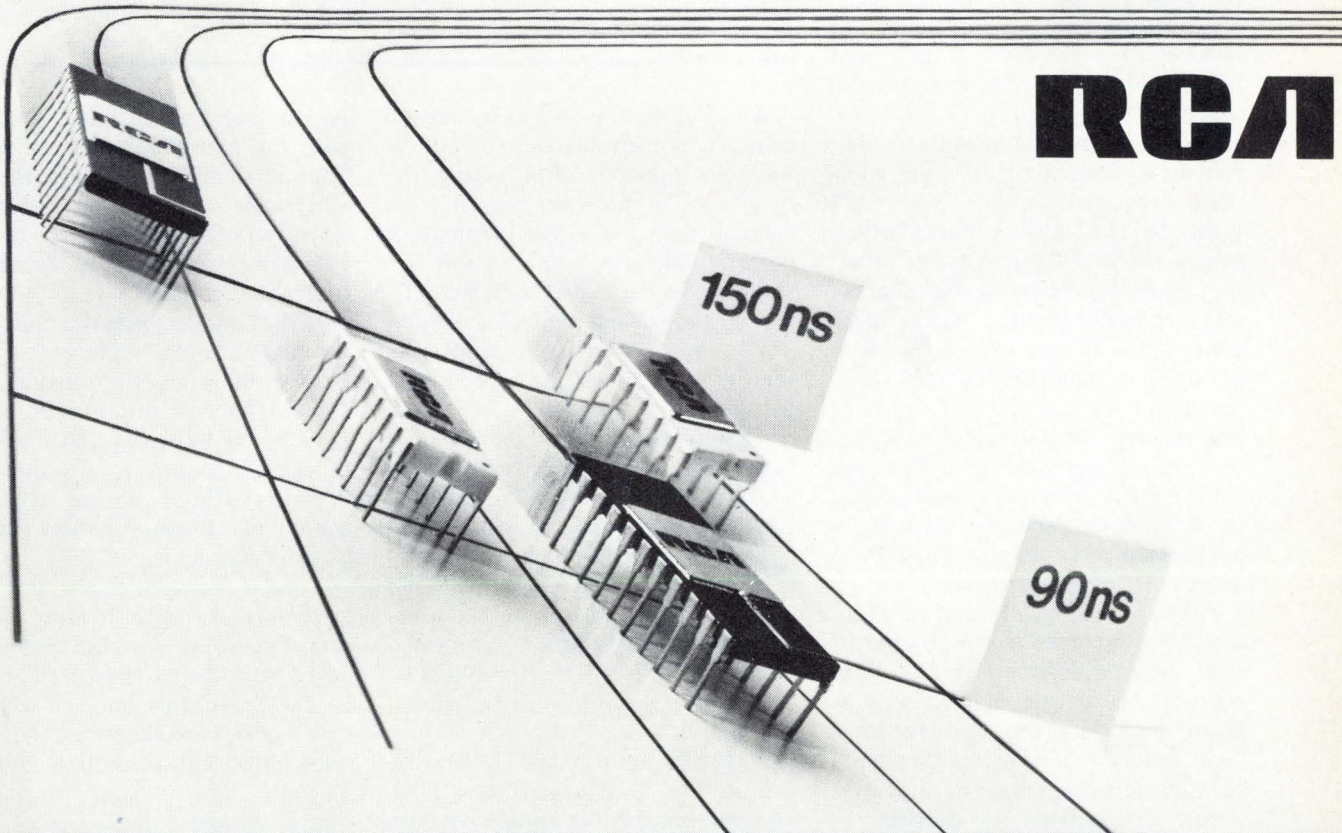

RCA. Fastest moving house in memory.



picture of where the economy is heading."

Whether intentional or not, he says, "there also is a falsifying of needs in the EMC findings, as a result of forecasts from energy-related industries." And Cherney would like to have demand broken down by disciplines.

Against this background, the National Society of Professional Engineers has entered the picture with two reports of its own. The first came last January, largely at the instigation of Milton Alpern, a consulting structural engineer in Massapequa, N.Y., in the form of a minority motion by the board of directors stating that "there is serious evidence to doubt the credibility of the [EMC's] repeated forecasts of engineering shortages in the past, and . . . any predictions of engineering demand are unwarranted and inappropriate for high-school guidance purposes." Then, a 20-page report, "Engineering Manpower . . . a Dilemma," was issued in June. But Alpern, who claims he was "knocked off the RSPE task force for pointing a finger at EMC and making too many waves," calls the new report a "very polite thing that says nothing and calls everybody a nice guy."

Not so, counters James P. Shivler, the new chairman of the NSPE manpower task force. "We don't want to get into a name-calling contest with the EMC on this situation at all. We certainly don't expect any response from EMC to the Alpern charges, which represented the viewpoint of a minority. In our white paper, we stay away from any hard predictions. We just point out that there is a dilemma, that there are soft spots in other projections, and we make some recommendations on approaches that might betaken to determine manpower needs."

Alpern believes that the EMC, which is supported in part by industrial memberships under the joint council's corporate affiliates' program, has a built-in business bias. "EMC reacts by having a large supply of engineers available to industry, should a need arise," he charges.

## Enough methods to go around

Electronics companies and educators deciding to use manpower need studies as guides in hiring or as curriculum checkpoints face one major problem: there is no one perfect system for predicting the demand for engineers. There are almost as many methods as there are so-called experts; any firm or college using such studies would do well to consider the possibility that others, equally respected, might point toward other conclusions.

An example of how industry uses the data is an American Telephone & Telegraph brochure to promote the entry of women into engineering. It says that engineering is "a field in which the demand exceeds the supply: 5,000 positions are left vacant each year." AT&T draws that conclusion from the "Occupational Outlook Handbook" published annually by the U.S. Bureau of Labor Statistics. Here's how BLS and others determine manpower needs:

- The BLS projects employment needs over a 10-year period on the basis of fundamental assumptions (Government spending, inflation, unemployment rates, and others) about the national economy. The data is then broken down by industry segments and furnished to "experts" in industry, professional societies, and trade associations for modification prior to publication.
- The Engineering Manpower Commission surveys large numbers of employers for the number of engineers currently employed, number of active job offerings, and anticipated hiring and losses during a stated period in the future.
- The College Placement Council of America has asked employers how many new graduates they expect to hire in various categories in relation to the forthcoming graduating class. But a new project to collect data will involve going to 200 employers in various engineering fields for their demand projections over a 3-year period.
- Deutsch, Shea & Evans Inc. uses recruiting advertisements as an indicator of current hiring activity.
- Robert Rivers, president of Aircom Inc., correlates the BLS engineering-employment figures to the DS&E index to devise a mathematical model to determine the 12-month predicted change in engineering demand. Taking a base of 1,121,000 (the number of engineers employed at the beginning of 1972, according to BLS), Rivers' multiplication factor is  $(75,200 \times \text{DS\&E index} - 90) / 100$ .

Meanwhile, the IEEE is looking to conduct its own demand survey. "It was our opinion, after seeing the results of earlier surveys, that we wanted to try some other methods of getting at the information we wanted," says Herbert Schulke, IEEE vice president and general manager. "We weren't satisfied that the reports put out truly represent a picture of the situation."

**Misdirection.** "The confusion is that [no demand study] really shows a true picture of what's happening," states David Reyes-Guerra, executive director of the Engineers' Council for Professional Development and chairman of an *ad hoc* committee on supply and demand that was formed by the EMC with the initial intent to investigate the NSPE/Alpern charges.

Reyes-Guerra takes a middle ground in the controversy. He believes that the EMC should not only

gather and publish data, as it does with the manpower-demand survey, "but it should also study the data and make some policy statements. This would get EMC into the business that they're accused of being in—forecasting data."

If the EMC gets into the policy end, the data would represent a good picture of what the future holds. "The danger of just publishing raw data, he continues, is that it's left up to the individual to do the interpreting without noting what the *caveats* are. It could be very misleading and inconclusive."

The *ad hoc* committee now plans an informal reply to the charges after "assessing various demand surveys," says Reyes-Guerra. The reply is due later this month. But the EMC's critics are skeptical; they don't anticipate a call for action. Sums up Rivers: "They're just waiting for things to quiet down." □



# FLUKE PROVES AN INEXPENSIVE, HANDHELD DMM CAN BE BUILT WITHOUT LEAVING EVERYTHING OUT.

Let's face it.

Before now, if you bought an inexpensive, handheld digital multimeter you didn't get much. In fact, you quickly discovered how they could build such a small DMM—they just left most everything out.

We knew that was no answer.

So we built the 8030A 3½-digit DMM. It's a small, portable, inexpensive, handheld DMM, but it performs like our benchtop units.

With one basic difference. The 8030A was designed, built and tested to a size and shape proven best for field service and laboratory technicians. There's a built-in hood that can be slipped forward to shade the readout in sunshine. It has rms capability. The best overload protection. Diode test. It weighs 2.5 pounds, and will take a beating without failing. Finally, we guaranteed accuracy specifications for one year.

And it only costs \$235\*.

Nothing left out. Everything the technician needs in the field or the lab. At the right size. And a fantastic price.

True rms.	Fluke
1-year accuracy specs.	Fluke
High voltage protection.	Fluke
Diode test.	Fluke

A full line of accessories offering rf voltage, high current ac, high voltage dc, and temperature measurement probes. Fluke

*There's only one place to go for all the performance you need in a handheld DMM.*

There are measurement functions in five selectable ranges for dc volts, ac volts (true rms), dc current, ac current (true rms), and resistance. DC voltage measurement is from 100  $\mu$ V to 1100V with basic accuracy of  $\pm 0.1\%$ , ac measurement is from 100  $\mu$ V to 750V rms with basic accuracy of  $\pm 0.5\%$ . DC and ac current is from 100 picoamps to 1.999 amps with basic dc accuracy of  $\pm 0.35\%$  and basic ac accuracy of  $\pm 1\%$ . Resistance measurement is from 100 milliohms to 2 megohms with a basic ac-

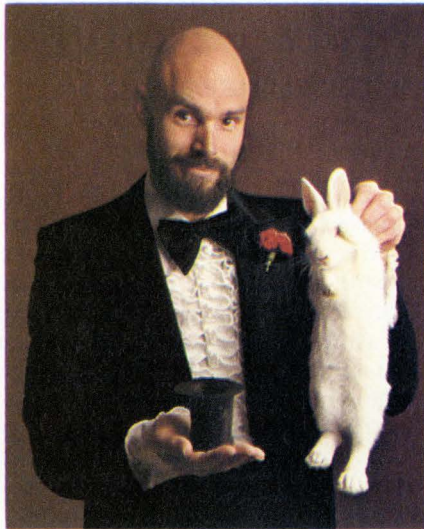

*"Fluke does the impossible again."*

curacy of  $\pm 0.4\%$ .

We added true rms response for ac measurements. This means that the specified accuracy is still attainable when the measured waveform is distorted.

The 8030A is designed for hard use. There is extensive overload protection. It has been tested with transients up to

6000V peak across the input terminals.

Options include two battery operations. For constant portable use, a rechargeable NiCad for 8 hours operation free of line power, or for a less expensive approach, throw-away alkaline cells. Other options are probes for measurement of rf voltages, high current ac, high voltage dc and temperature. Carrying cases and test leads are also available.

And because the 8030A gives you so much in performance, let us remind you once more of the price.

Only \$235.

For the first handheld DMM that's small in size, small in price, but huge in performance.

For data out today, dial our toll-free hotline, 800-426-0361.

John Fluke Mfg. Co., Inc., P.O. Box 43210, Mountlake Terrace, WA 98043

Fluke (Nederland) B.V., P.O. Box 5053, Tilburg, The Netherlands.

Phone: (013) 673-973 Telex: 52237

\*U.S. price only.

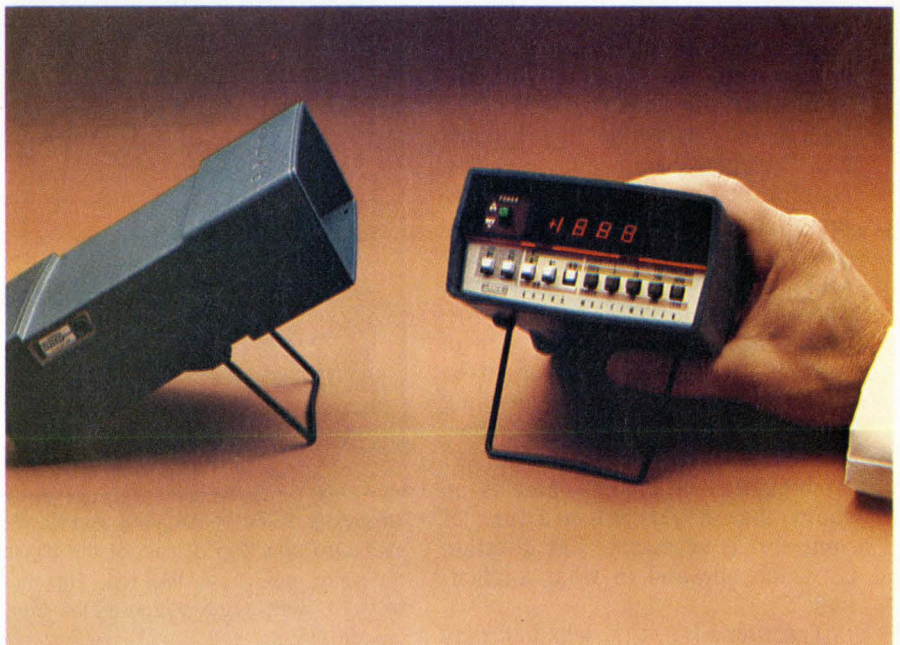

**A NEW ADVANCE. 8030A DMM. **



Components

# New FETs thunder into view

Vertical-structure junction and MOS parts expected to chop off large chunk of bipolar transistors' market share

by Bernard Cole, San Francisco bureau manager

Sales of field effect transistors—the MOS type, especially—are expected to rise dramatically during the next five years. The market is expected to increase from between \$36 million and \$40 million a year to, conservatively, \$70 million to \$100 million a year.

The main casualty of this expansion will be the ubiquitous bipolar transistors already being nudged out of certain high-frequency and switching applications by vertical-structure junction FETs and MOSFETs, which combine inherent advantages for these tasks with an enhanced current- and power-handling capability. Indeed, there are some indications that the stronghold of the bipolar transistor in traditional straightforward multiampere, multi-watt power-handling may not be all that impregnable.

**A horde.** Many U.S. and Japanese semiconductor companies—among them Siliconix Inc, National Semiconductor Corp., Signetics Inc., Intersil Inc., Motorola Semiconductor, Fairchild Semiconductor, RCA, Hitachi, Sony, Nippon Electric, Mitsubishi, and Yamaha—are probing vertical-structure FET techniques with keen interest. “Almost anyone who has been in the FET and power-transistor business for any length of time at all knows what has to be done to improve the power-handling capabilities of FETs,” says Michael Turner, marketing manager for FET products at National. “There is no doubt that a vertical structure of some sort is necessary. The question is: which one and in what applications?”

Traditionally, FETs, whether they are junction or MOS, have had

lateral structures that require the charge being handled to be transferred across the surface of the transistor. In junction FETs, the channel current is controlled by reverse-biasing the gate-to-channel junction so that a depletion region reduces the effective channel width. A MOS-FET can be either a depletion or

enhancement device, in which a conducting region is usually induced between the drain and source and controlled by a gate electrode between them. But, because standard FETs are basically surface-effect devices, their current density and resulting power-handling capability is severely limited.

“In a vertical-structure FET, current flows vertically,” says John Hulme, vice president of engineering at Siliconix, one of the first U.S. companies to introduce vertical-structure MOSFETs. “In MOSFETs, particularly, this multiplies the current density and enhances high-speed switching, as well as high-power performance.”

**Japanese efforts.** Sony, Nippon Electric Co., and Yamaha have pioneered the use of vertical structure JFETs in audio high-fidelity applications. In these structures, the drain substrate is connected to the bottom by an n<sup>+</sup> layer. The source is connected to the top via an n<sup>-</sup> layer, and the gate electrodes are connected via p<sup>+</sup> diffusions laid down in a grid or mesh-like manner. In this construction, current is applied vertically from source to drain, and voltage is applied between the gate regions and the drain, much in the manner of a vacuum tube. “Indeed, it is exactly this vacuum-tube-like operation that makes vertical JFETs so popular in audio applications,” says Turner, “replacing the tinny, brittle sound attained by bipolar transistors with the softer, more vacuum-tube-like characteristics.” At audio frequencies, Sony's devices typically are rated at 63 W and NEC's at 100 W.

Aiming at the same high-fidelity

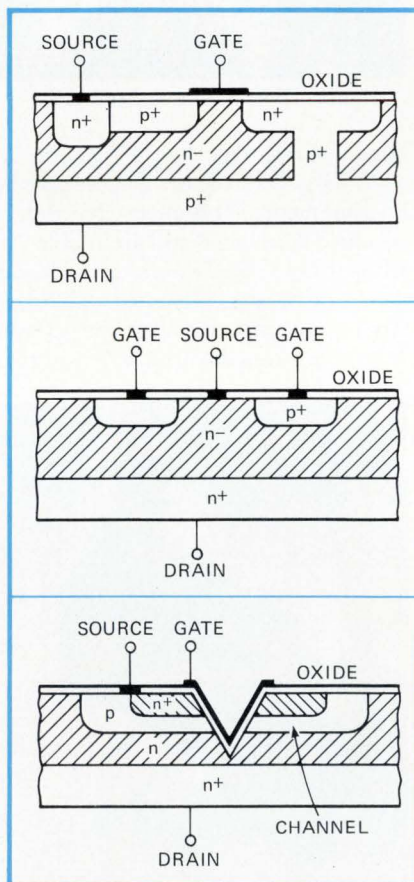

**Grooving.** Some of the many vertical FET structures attacking domain of the bipolar transistor are, from the top, Hitachi's MOSFET without the V-groove; the Sony, Nippon Electric, and Yamaha version; and the V-groove MOSFET from Siliconix.



A historical scene set on the deck of a ship. In the center is a large wooden cannon on a carriage. To the left, a soldier in a blue and white uniform stands with a long pole. To the right, another soldier is kneeling, and a third soldier stands with one arm raised. The deck is covered with a patterned rug featuring large yellow stars on a dark background. Numerous black cannonballs are scattered on the rug to the left of the cannon. The background shows the dark interior of the ship's hull.

**HUGHES**

HUGHES AIRCRAFT COMPANY  
CONNECTING DEVICES DIV.

Today we  
supply the spark  
for America's  
defense.

Connections were much simpler 200 years ago. Torch the fuse and the cannon fired.

Supplying the vital spark that makes a modern weapon system do its job is a lot more complicated.

That's where we come in. For many years, primes and OEMs for military and aerospace products have depended on us to provide the vital links in their electronic systems—flat cable, etched circuitry, connectors, and total interconnection systems.

Our high-rel connections have to be the best. They're used in systems like Phoenix, Maverick, Lance, Minuteman, AWACS, F-14, F-15, Space Shuttle, Viking, Sonobuoy, F-4, A-7, Condor, Standard Missile, F-18, AAH, Cruise Missile, F-8, Trident, Hobo, Sprint and many more.

To learn how we can serve your interconnection needs, contact Jack Maranto or Dave Cianciulli: Hughes Connecting Devices, 17150 Von Karman Ave., Irvine, CA 92714.

Or call (714) 549-5701.

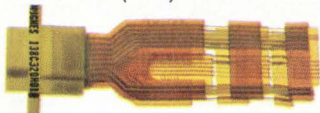

**Hughes  
Connecting Devices**

Circle 81 on reader service card



## Probing the news

audio market, Hitachi has developed vertical-MOSFET structures in which the drain region is connected to a highly doped p<sup>+</sup> substrate through an epitaxial n<sup>-</sup> layer by drain diffusion, while the channel and the source regions are still located on the top surface. The firm uses a polysilicon gate to achieve high packing density but at the sacrifice of high-frequency performance (cutoff frequency 1 to 1.5 megahertz). However, in the audio range, the low-frequency performance is awesome: 80 v breakdown and 20 A drain current, as well as a power-handling capability of 200 w.

Work by Mitsubishi has resulted in a JFET that may find its way into vhf and uhf transmitters, where the device's negative temperature characteristics prevent thermal runaway or other destructive effects, even under mismatched conditions. It is particularly aimed at fixed equipment operating on ac because, typically, the optimum supply voltage for present parts is 50 to 100 v.

The key to the JFET's excellent high-frequency performance is the surface n<sup>+</sup> source contact, and the silicon-dioxide isolation between the source contact and p-gate regions. The isolation regions make the fabrication process largely self-aligning. At the same time, they minimize capacitance between the gate and the source. Although the device's total channel width is 22.5 millimeters,

**Sony power.** Power FET from Sony measures 3 micrometers on a side.

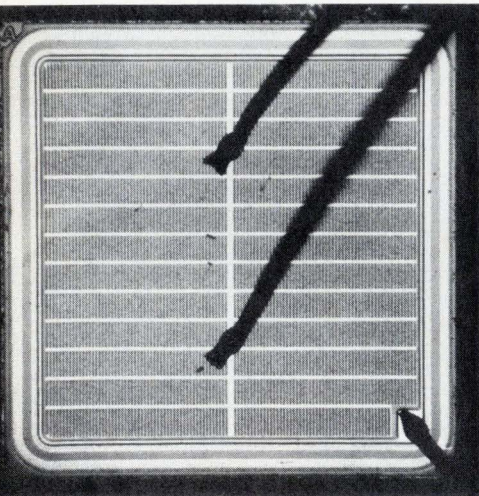

input capacitance is only about 22 picofarads. And high channel resistivity also helps keep input capacitance low.

**U.S. approach.** Most semiconductor companies in the U.S., led by Siliconix, have pursued the vertical MOSFET approach. "A MOSFET has several features which make it more attractive than a bipolar transistor as a power device," says Hulme. "It operates at near zero input current, is easier to bias, and is not susceptible to the traditional bipolar problems of secondary breakdown, thermal runaway, or current hogging, and it exhibits no minority-carrier-storage time." To achieve both high current handling and high-frequency performance, several U.S. companies are looking at a variation of the V-groove MOS technique developed for integrated circuits [*Electronics*, Sept. 18, 1975, p. 65].

In the Siliconix VMP series of vertical-structure power MOSFETs, the drain connection is from an n<sup>+</sup> substrate for maximum heat transfer. The etched V-groove effectively separates the n<sup>+</sup> source and the p-channel into diffused islands, rather than leaving them as common area as in ICs. A gate formed in the V-groove creates a dual n-channel enhancement-mode MOSFET with a single gate input, source electrode, and drain electrode. Right now, says Hulme, such a structure can handle 25 w and switch 2 A. Frequency response ranges from 40 to 180 MHz, not easily achievable with equivalent bipolar power transistors, he says. "And, within a year, power FETs with 10-A current-handling capability and breakdown voltages of up to 200 v will be available," he says.

And at the University of Toronto, in conjunction with an unidentified manufacturer, a depletion-mode V-groove vertical MOSFET under development can deliver 12 w at a frequency of about 80 MHz. "With such an array of techniques," says National's Turner, "there is just no question that bipolar power transistors will give way to vertical-structure power FETs in a number of crucial, high-volume, high-growth-potential areas." □



## Zilog products are available now. Contact:

**ALABAMA** HUNTSVILLE  
Technology Marketing Assoc. (205) 883-7893

**ARIZONA** MESA  
Nakoma (602) 834-6649

**CALIFORNIA** LOS ANGELES  
The Thorsen Company (213) 476-1241

**CALIFORNIA** MOUNTAIN VIEW  
The Thorsen Company (415) 964-9300

**CALIFORNIA** SAN DIEGO  
Littlefield & Smith Assoc. (714) 277-8044

**CALIFORNIA** SANTA BARBARA  
The Thorsen Company (805) 964-8751

**CALIFORNIA** TUSTIN  
The Thorsen Company (714) 544-5121

**COLORADO** BOULDER  
RG Enterprises, Inc. (303) 447-9211

**DELAWARE**  
Quay Corporation (201) 462-9606

**FLORIDA** ORLANDO  
Technology Marketing Assoc. (305) 857-3760

**FLORIDA** POMPANO BEACH  
Technology Marketing Assoc. (305) 942-0774

**ILLINOIS** CHICAGO  
Mar-Con Associates, Inc. (312) 675-6450

**INDIANA** INDIANAPOLIS  
S.A.I. Marketing Corp. (317) 844-7196

**MASSACHUSETTS** WALTHAM  
Impact Sales (617) 893-2850

**MICHIGAN** BRIGHTON  
S.A.I. Marketing Corp. (313) 227-1786

**MICHIGAN** GRAND RAPIDS  
S.A.I. Marketing Corp. (616) 942-2504

**MINNESOTA** MINNEAPOLIS  
Quantum Sales, Inc. (612) 831-8583

**MISSOURI** FLORISSANT  
S.A.I. Marketing Corp. (313) 837-5200

**NEW JERSEY** FREEHOLD  
Quay Corporation (201) 462-9606

**NEW YORK** NEW YORK CITY  
Quay Corporation (201) 462-9606

**NORTH CAROLINA** RALEIGH  
Dean, Bob, Inc. (919) 851-2065

**OHIO** BEACHWOOD  
S.A.I. Marketing Corp. (216) 292-2982

**OHIO** CINCINNATI  
S.A.I. Marketing Corp. (513) 761-5432

**OHIO** DAYTON  
S.A.I. Marketing Corp. (513) 277-8911

**PENNSYLVANIA** PHILADELPHIA  
Quay Corporation (201) 462-9606

**PENNSYLVANIA** PITTSBURGH  
S.A.I. Marketing Corp. (412) 782-5120

**TEXAS** DALLAS  
The Thorsen Company (214) 233-5744

**TEXAS** HOUSTON  
The Thorsen Company (713) 771-3504

**VIRGINIA** ALEXANDRIA  
Dyna Rep Company (703) 354-1222

**WASHINGTON** BELLEVUE  
SDR? Products & Sales (206) 747-9424

**CANADA**  
CALGARY, ALBERTA  
Westronic Engineering (403) 253-5685

OTTAWA, ONTARIO  
Datagraphics (613) 225-0411

TORONTO, ONTARIO  
Datagraphics (416) 622-6752

**DENMARK**  
SC Metric A/S 02/80 42 00

**FINLAND**  
FINN Metric OY 90/46 08 44

**FRANCE** BOULOGNE  
A2M 603-66-40

**GERMANY** MUNCHEN  
Kontron Elektronik GMBH 08165/771

**ITALY** MILAN  
Ezimar SPA

**NETHERLANDS** AMSTERDAM  
Tekelec Airtronic 020-92 87 66

**NORWAY**  
Metric A.S. 02/28 26 24

**SWEDEN** SOLNA  
Scandia Metric AB 08/82 04 00





# The Battle of the 80's continues:

The Z-80 is a third generation LSI component set including CPU and I/O Controllers with full software support and second sourcing available now.

A single chip, N-channel processor arms you with a super-set of 158 instructions that include all of the 8080A's 78 instructions with total software compatibility. The new instructions include 1, 4, 8 and 16-bit operations. That means less programming time, less program storage and less end costs. And you get memory-to-memory or memory-to-I/O

block transfers, nine types of rotates and shifts, bit manipulation, a legion of addressing modes and a standard instruction speed of 1.6 $\mu$ sec. The Z-80 CPU and peripheral circuits require only a single 5V power supply and a single phase clock. With these circuits you can interface directly to a wide range of both parallel and serial interface peripherals and even dynamic memories without other external logic. With all these features you'll require approximately 50% less memory space for program storage and you'll get up to 500% more throughput than the 8080A.

The Zilog Battalion includes a development system with: Z-80 CPU Card with 4K Bytes of ROM/RAM Monitor software • 16K Bytes of RAM memory, expandable to 60K Bytes • Real Time Debug Module and In-Circuit Emulation

With the introduction of Zilog's Z-80 microcomputer products the tide is turning in the battle for supremacy.

Features:	8080A	Z80-CPU	Features:	8080A	Z80-CPU
Power Supplies	+5, -5, +12	+5	Addressing Modes	7	11
Clock	2 $\phi$ , +12 Volt	1 $\phi$ , 5 Volt	Working Registers	8	17
Standard Clock Speed	500 ns	DC to 400 ns	Static Operation	No	Yes
Interface	Requires 8222, 8228 & 8224	Requires no other logic and includes dynamic RAM Refresh	Non-maskable Interrupt	No	Yes
			Full TTL Compatibility	No	Yes
Interrupt	1 mode	3 modes; up to 6X faster	Throughput	Up to 5 times greater than the 8080A	
Instructions	78	158*	Program Memory	Generally 50% less than the 8080A	
OP Codes	244	696	*Including all of the 8080A's instructions.		

Module • Dual Floppy Disc System • Software Package including Z-80 Assembler, Editor, Disc Operating System, File Maintenance and Debug.

We'll support this with resident microcomputer software, time sharing programs, software libraries and high-level languages such as PL/Z.

A reserve of reinforcements is ready. The Zilog Z-80 brings to the battlefield new levels of performance and ease of programming not available in second generation systems.

And while all the others busy themselves with overtaking the Z-80, we're busy on the next generation—continuing to demonstrate our pledge to stay a generation ahead.

The Z-80's troops are the specialists who were directly responsible for the development of the most successful first and second generation microprocessors. Nowhere in the field is there a corps of seasoned veterans with such a distinguished record of victory.

Think of your next microcomputer as a weapon against horrendous inefficiencies, outrageous costs and antiquated speeds.



**Zilog** MICROCOMPUTERS

170 State Street, Los Altos, California 94022  
(415) 941-5055/TWX 910-370-7955

AN AFFILIATE OF **EXXON** ENTERPRISES INC.

Circle 83 on reader service card

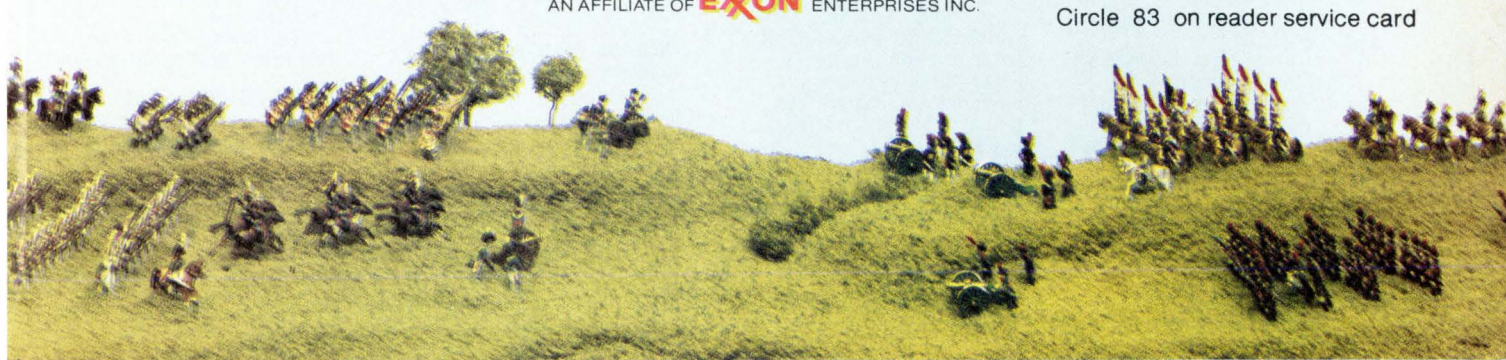





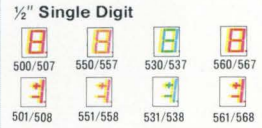
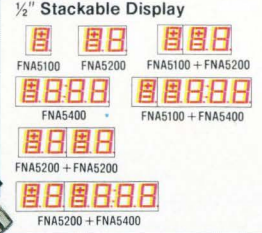

You name it  
and we can put it  
where you want it.

# DIGITAL TIMEKEEPING

## FAIRCHILD SOLID STATE DIGITAL DISPLAYS

DEVICE	FEATURES	APPLICATIONS
<b>3/8" Single Digit</b>  357/367    358/368	*Available now in standard or high brightness versions. *Industry's best digit size-to-package size ratios. *Ideal for applications requiring high packing density.	Ideal in applications requiring large digit size and small package such as Auto Clocks, CB radios, hand-held instruments.
<b>1/2" Single Digit</b>  500/507    550/557    530/537    560/567 501/508    551/558    531/538    561/568	*Available now in standard or high brightness versions. *Common Anode or Common Cathode. *Fits standard 0.6" pin row socket.	For applications requiring visibility to twenty feet such as cash registers, desk clocks, bench and panel instrumentation.
<b>1/2" Stackable Display</b>  FNA5100    FNA5200    FNA5100 + FNA5200 FNA5400    FNA5100 + FNA5400 FNA5200 + FNA5200 FNA5200 + FNA5400	*High contrast ratio. *See only what you turn on. *Low cost. *Compact.	Ideal for high volume, cost sensitive consumer products.
<b>3/16" Big Digit</b>  800/807    847/850	*Biggest single digit available. *One die per segment for easy multiplexing. *Left- or right-hand decimal point.	Designed for use in wall and desk clocks, P.O.S. terminals, games, industrial controls.
<b>3/16" Clock Display</b>  FCS8000    FCS8001 FCS8024    FCS8025	*High on-off contrast ratio. *Low power (typ. 8mA per segment). *Common cathode for easy driving.	Wall or desk clocks, clock radios, interval timers.
<b>3/16" Clock Module</b>  FCS8100A FCS8100D	*Complete circuit integration. *Just add standard transformer and switches. *Compact *Buffered output for alarm or radio drive. *Power failure protection.	Clocks, clock radios, alarm clocks, industrial timing and control.

## Fairchild's time has come. With better technology,

Fairchild is committed to satisfying your digital timekeeping needs: short and long term, simple or complex. On time.

Electronic timers, displays — whatever your needs — Fairchild almost certainly has more digital timekeeping answers for you than any other company in the world.

### More timekeeping functions.

Take our *Exetron* timing circuits, for example.

Nobody, but nobody offers so many MOS devices — all different.

Or take our CMOS timing circuits for low-power applications. You'll find Fairchild CMOS devices offer more functions and require less power than any other devices made.

And just to make sure you get your timekeeping devices on time, Fairchild timing circuits are produced on the

world's largest dedicated fabrication line. Including the first 4-inch wafer facility in the industry.

### Displays. We have more ways to make you look good.

What good is a terrific timing circuit without a terrific display?

So at our Opto-electronics center, we make the largest line of timekeeping displays available today.

Not just one or two for-

mat, but five — in three sizes: 3/8", 1/2" and 3/16". And these have now become the industry standards.

Not just one color, but three. Red, green and orange.

### The FCS8100 module. Another great way to save yourself time.

If you're in a hurry, relax. Our compact 12-hour clock radio module is ready to go. It operates from 12VAC



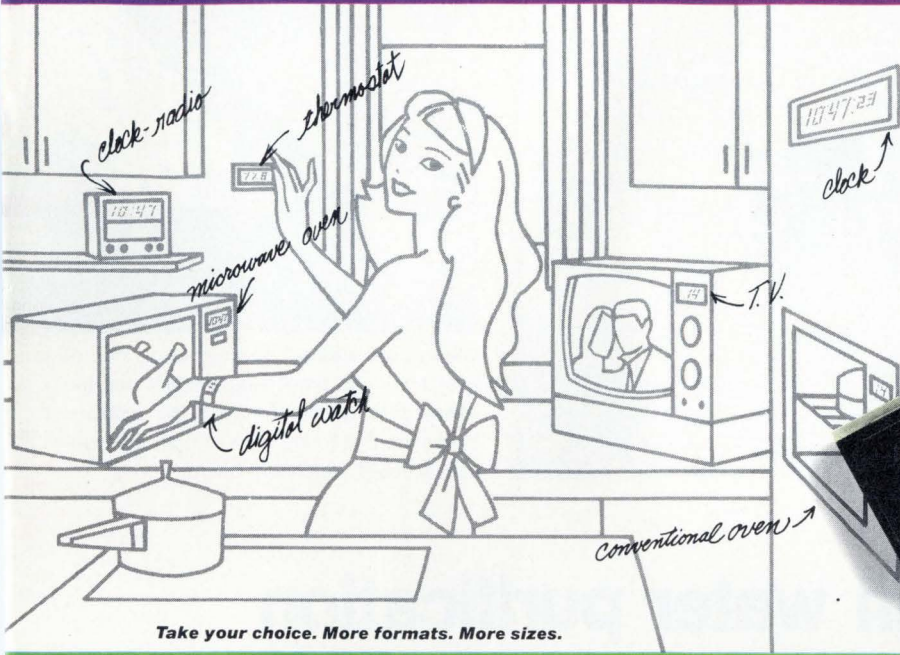

Take your choice. More formats. More sizes.

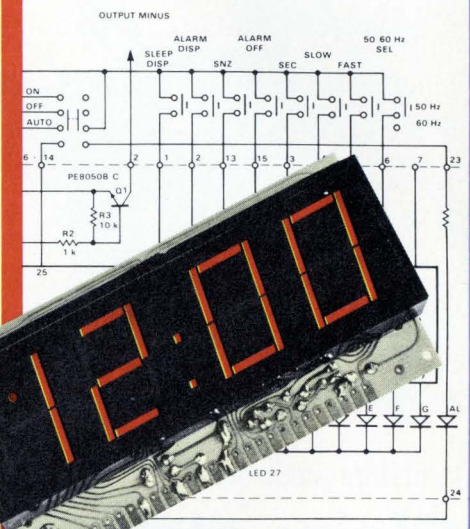

Get it ready-to-go, and save time.

Display it your way, red, green, or orange.



FAIRCHILD SOLID STATE TIMEKEEPING CIRCUITS

	# of DIGITS	DIGIT DRIVE	LED	LCD	CALENDAR	BACKUP OSC	ALARM	TIMER	24 HOUR	RADIO CKT	VOLTAGE	TECHNOLOGY	SPECIAL FEATURES
FCM7001	6	MUX	YES	YES	YES	YES	YES	9:59	YES	YES	10-17	PMOS	doze
FCM7002	6	MUX	N/A	N/A	YES	YES	YES	9:59	YES	YES	10-17	PMOS	bcd outputs
FCM7003	6	MUX	YES	YES	YES	YES	YES	9:59	YES	YES	10-17	PMOS	direct drive for gas discharge
FCM7004	6	MUX	YES	YES	YES	YES	YES	9:59	YES	YES	10-17	PMOS	European calendar format
FCM7010	4	DIR.	YES	YES	YES	YES	YES	2:50	YES	YES	7-17	PMOS	12mA direct drive, pulsing colon
FCM7015	4	DIR.	YES	YES	YES	YES	YES	2:50	YES	YES	7-17	PMOS	12mA direct drive, static colon
FCM3817A	4*	DIR.	YES	YES	NO	NO	YES	:59	YES	YES	8-22	PMOS	*seconds on command, 8mA drive
FCM3817D	4*	DIR.	YES	YES	NO	NO	YES	:59	YES	YES	8-22	PMOS	*seconds on command, 8mA drive
FMC7030	4*	DIR.	YES	YES	NO	NO	YES	:59	YES	YES	8-18	PMOS	*seconds on command, 15mA drive
FWA6003	4*	DIR.	NO	YES	YES	YES	NO	NO	NO	NO	1.5	CMOS	*seconds on command
FWA6105	4*	DIR.	NO	YES	YES	YES	NO	NO	NO	NO	1.5	CMOS	*seconds, on board voltage quadrupler
FWA6004	4*	MUX	YES	NO	YES	YES	NO	NO	NO	NO	3.0	CMOS	*seconds, ideal car clock

# more choice, greater flexibility.

power. And comes complete with MOS circuit. A display with AM, PM, Alarm Set indicators and time colon. Power supply and output drive circuitry for alarm or radio function. Plus programmable options like 50 or 60 Hz operation, nine-minute "doze" alarm and seconds display. Just add the switches you require. And you've got it made.

**Bring us your application and we'll give you more than the time of day.**

Fairchild is committed to leadership in solid-state timekeeping. So bring us your application and chances are, we can show you a better way to handle it. With better choice, better technology — and better custom flexibility than you'll find anywhere else today.

For complete information, contact your Fairchild Sales Office, Distributor or Representative right away. Fairchild Camera & Instrument Corp., Consumer Products Group, 464 Ellis Street, Mountain View, CA 94042. Telephone (415) 493-3100. Ext. 2274. TWX: 910-379-6435. Fairchild. The leader in digital timekeeping.





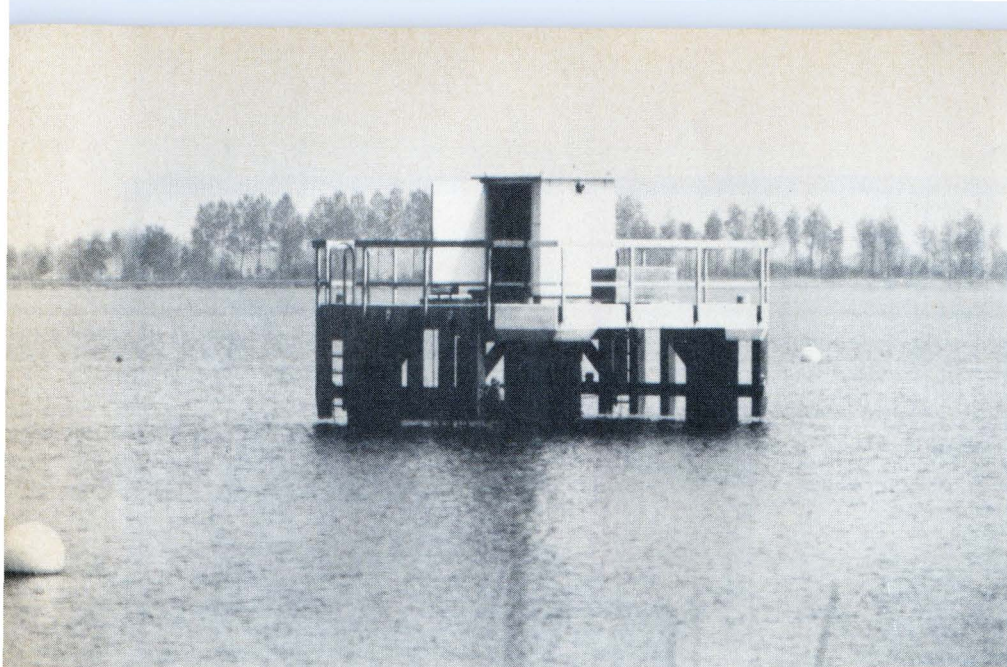

**Clear, cool water.** Shown at left is one of two automatic monitoring stations for the Amsterdam system. Above is the system's central control room, while at right a technician watches the control board.

Industrial electronics

## Claim staked in water purification

Phillips accelerates business drive with pollution-detection and purification system installed in Amsterdam

by John Gosch, Frankfurt bureau manager

The attention of water-supply experts and electronic-systems designers is focused on the Dutch city of Amsterdam. There, in the Netherlands' largest metropolis, municipal authorities this month activated a \$50 million water-purification and supply system that's among the most modern in the world. Helping keep the water fit for drinking is electronics hardware valued at nearly \$3 million.

With the entire system supplied by Philips Gloeilampenfabrieken, the giant Dutch company has its eye on future systems sales. Alfred B. Bok, marketing manager in the company's Environmental Pollution department, figures that in a ground-water purification plant such as Amsterdam's, analytical and electronic equipment accounts for 2% to 3% of total plant costs. That figure mounts to roughly 5% in a facility built for purifying river water. But as rivers become more and more contaminated in the future, the share may go up to 8% to 10%, Bok figures.

Independent industry studies peg this year's world market for surface-water monitoring and analysis devices at \$40 million to \$60 million, and it is predicted to grow at 20% to 25% a year. About six times larger—possibly \$240 million to \$360 million—is the world's present market for hardware to monitor and analyze industrial waste water.

**Position.** Philips figures it's in a good position astride both of these markets. The prime reason it was picked by Amsterdam is that it could supply all the necessary hardware. But equally important is Philips' expertise in pollution-monitoring. It has installed 25 computerized air-pollution-monitoring networks, or roughly 60% of the total number of networks operating throughout the world, says Bok. What's more, the Dutch firm has more than 70 noncomputerized air-monitoring systems either in operation or on order.

As for water-pollution monitoring, Philips has sold three networks and about 45 automatic multiparameter

monitoring stations. By far the most advanced system is the one in Amsterdam. "The experience we have gained with it puts us in a good position to also capture a sizable share of the market for drinking-water-monitoring equipment and instrumentation," Bok says.

In Amsterdam, the kingpin electronics items are Philips minicomputers that control and supervise all phases of the water-purification and supply operations. They sample hundreds of measuring points, compare measured values against preset limits on water-quality standards, and determine when alarm conditions exist. Further, the computers optimize pumping of water, control cleaning of filters, and advise plant personnel on operation decision.

**Sophisticated.** "As regards its level of automation, the Amsterdam system is among the most sophisticated ever built," says Bok. Equally advanced is some of the water-analysis equipment, Bok points out. Automatic remotely controlled instruments continuously monitor all



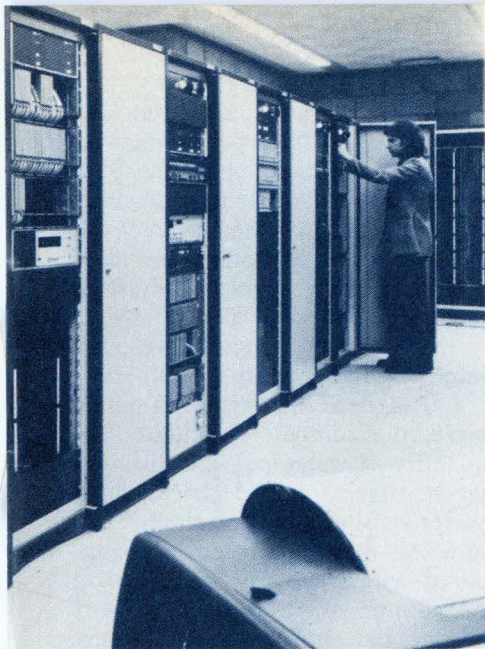

# A NEW GENERATION OF IMAGE SENSORS

## SIMPLICITY OF USE -

Requiring less than a dollars worth of circuitry to drive—and barely more than that for video processing—is just one of the key features of our new “G” series image sensors. Compare the non-critical single TTL clock needed for the “G” device to the complex multi-phase clocks prescribed by others.

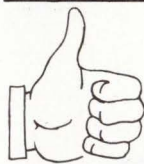
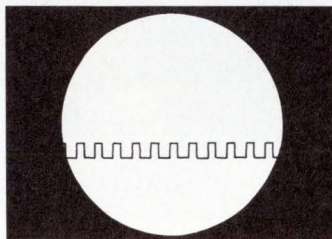

You need only this for Reticon

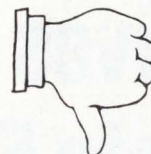
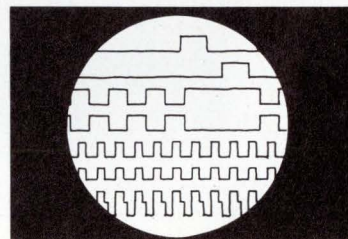

You need all these for others

vital water parameters at different depths in a reservoir. Their outputs are then used to set the depth of intake pipes so that only the highest-quality water is pumped from the reservoir through the system.

Amsterdam's heavy reliance on automation and instrumentation is due to an accident of geography. Though surrounded by water, much of the city's supply (18 billion gallons) of surface water comes to it from the nearby Rhine, a river sometimes referred to as the cesspool of Europe because of its pollution.

Amsterdam uses two water-treatment plants. One is a prepurification plant where raw water, collected in a 5 million-cubic-meter reservoir, undergoes its first cleaning process. After extensive filtration, the water is piped to the second plant for final purification and is then fed into Amsterdam's water-supply network.

As Fred Koot, the Philips manager for drinking-water and sewage-purification equipment, explains it, each plant has two of the company's model P855 minicomputers. In a

## HALF THE PRICE -

Or even less will bring you 256, 512, 768, or 1024 sensor elements on 25 $\mu$  centers or up to 1728 elements on 15 $\mu$  centers in our “H” series.

## SUPERIOR PERFORMANCE -

Low dark current allowing low light level operation, on-chip noise cancellation, and smooth spectral response from visible through infrared makes this new generation the unquestionable choice.

## APPLICATIONS -

Page readers, facsimile, OCR, point of sale readers, non-contact measurements and inspection and many others.

# RETICON®

910 Benicia Avenue, Sunnyvale, California 94086  
PHONE: (408) 738-4266 TWX: 910-339-9343





## Plenco gives the new Presto® Fry Baby™ a spanking new bottom

French frying potatoes, chicken and shrimp was never simpler than with this new, compact, electric deep fryer that's "great for a serving or two in a jiffy or two."

At the bottom of it, in a manner of speaking, our Plenco 466 Black phenolic compound. Used in molding the base of the Presto Fry Baby deep fryer manufactured by National Presto Industries, Inc., Eau Claire, WI.

"High heat resistance," reports National Presto, "ease in molding, strength, and good appearance were characteristics that had to be considered in choosing a compound for molding the base."

"Lab design testing," the manufacturer continues, "was done on a number of plastics on molding techniques and requirements. Plenco 466 was chosen as the most desirable and facilitated obtaining UL approval."

Give Plenco a call when the heat is on. Whatever you've got frying.

**PLENCO**  
THERMOSET PLASTICS

PLASTICS ENGINEERING COMPANY  
Sheboygan, WI 53081

Through Plenco research... a wide range of ready-made or custom-formulated phenolic, melamine-phenolic and alkyd thermoset molding compounds, and industrial resins.

typical application, a computer may sample up to 800 different measuring points. Of these inputs, most are simple digital statements indicating, for example, whether a valve is closed or open. But others are more complex analog valves that must be monitored for such parameters as water throughput, pressure, velocity, level, chlorine content, and others.

**Calculations.** During the sampling cycle, the computer calculates the quantity of water pumped during a given time, total electrical load, power consumption, and similar factors. All measured values are compared with those of the preceding cycle and with preset limits. Any changes like excessive water pressure or too high a concentration of a certain pollutant are acoustically indicated and/or displayed on cathode-ray tubes.

Another computer function is advising plant personnel on which of a number of different-capacity pumps should be selected to use the least power to transfer a given quantity of water in a given period. To determine selection of pumps on a day-to-day basis, the computer is told how much water the city may need during each succeeding 24 hours.

One process that Koot says probably has been put under computer control for the first time in a water-purification facility is cleaning the huge sand-type filters. When a filter's resistance to water flow has reached a certain limit, as determined by automatic differential-pressure measurements, compressed air at 1 atmosphere and clean water are forced against the direction of normal flow to flush the accumulated impurities and sediment.

Perhaps the most sophisticated monitoring equipment, Koot says, is installed in the automatic water-monitoring stations. One that is located a few feet above the reservoir's surface continuously determines water parameters at depths of 6, 18, and 36 feet. The measured parameters can include chlorine concentration, oxygen-reduction potential, pH, dissolved oxygen, conductivity, turbidity, and temperature. The results are used to automatically set the intake pipes to the proper depth to get the best quality of water. □



Electronics abroad

## Bombay takes on electronic glow

State Department report touts duty-free export zone as the Taiwan of the future; 51 firms establish links

by Ray Connolly, Washington bureau manager

"Keep your eye on Bombay. It's beginning to look like tomorrow's Taiwan." That judgment by one international industry analyst at the U.S. State Department is supported by 51 of the world's electronics manufacturers, including 17 with American ties. All have been lured by India to set up manufacturing operations in Bombay's Seepz—the Santa Cruz electronic export zone that occupies 100 acres in the country's second largest city. And American electronics manufacturers—led by digital-watch makers in search of low-cost offshore assembly sites—now dominate in Bombay. Moreover, they are followed closely by producers of such passive components as capacitors, rectifiers, and resistors.

For example, deals for the production of integrated circuits and their assembly into electronic-watch modules have already been made by California's Intersil Inc. and Microsemiconductor Corp. with Indosil Ltd. and Semcon Electronics Pvt. Ltd., respectively, according to an unreleased State Department report. Within a year, Chromar Inc. will begin taking delivery of Century Rayon's Seepz production of C-MOS LSI arrays as well as watch modules. And West Germany's Aviatronik is collaborating with Crystalonic Pvt. Ltd., which also has plans for electronic calculators and clocks.

**Twist.** "The Seepz operation looks like it could become Taiwan with a twist, in that India expects to have a high input of engineering skills," states the U.S. evaluation. Unlike Taiwan or Korea, "there will be very few assembly units operating on a low-technology, labor-intensive ba-

sis." Initial Seepz data supports this view, indicating that the average value added to exports is approximately 60%. Value-added content of products envisaged in the zone "will range from 30% to 70% of F.O.B. export prices," according to Seepz's development commissioner.

Development of the free-trade zone has been slow [*Electronics*, Oct. 25, 1973, p. 55]—there is still space for another 100 manufacturing operations—but officials attribute "the birth pangs" to the 1974-75 slump in international electronics markets. Bombay now reads the overseas market for components as steady and expects to reach its \$6 million export goal for fiscal 1977, which ends next March. Though the figure is small by world standards, it will represent a hundred-fold increase in the two years since Seepz reached the mid-point of its construction phase. For the first fiscal quarter ended in June, exports were valued at \$1.2 million. Over the next two fiscal years, Seepz is projecting export expansion to \$29 million and \$60 million respectively.

**Incentives.** Principal operational incentives available to manufacturers investing in Seepz include: low-cost leases of factory space or sites, exemption from customs and countervailing duties of all equipment and materials, tax exemptions on goods produced in the zone, and special discounts on Indian goods purchased for use in the zone—discounts offset by government subsidies to the seller. In addition, the State Department says India's traditional "bureaucratic delays have been virtually eliminated since regulatory powers" were transferred to

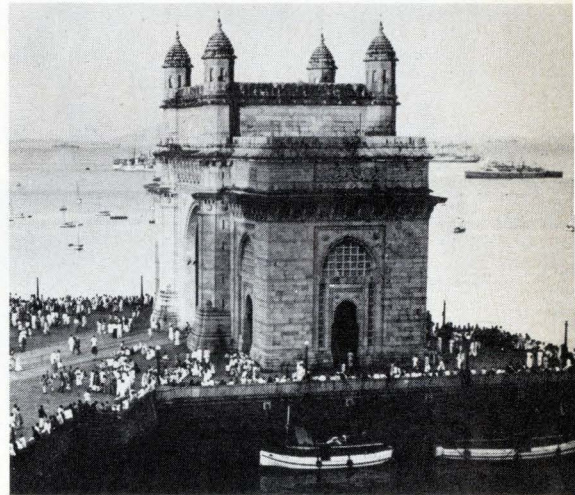

**This way.** The Gateway to India in Bombay, whose duty-free zone attracts electronics.

the Seepz commissioner.

An Intersil spokesman says his company, which assembles bonds, and seals components at Seepz, went there mostly because of the freedom from duties and the absence of government red tape.

Other firms already in production for U.S. affiliates include: Clarostat (India) Pvt. Ltd., making wirewound resistors; Indicos Computer Services Pvt. Ltd., which turns out data products for Intec Inc. of Texas; Semiconductors Ltd., producing semiconductors and relays for California's International Rectifier Corp.; Mahajan Hybrids, turning out thin-film hybrid microcircuits for Halex Inc. of California; International Power Semiconductors Pvt. Ltd., producers of transistors and rectifiers for Power Physics Corp., and Premier Mills Ltd., whose wire-wrapped circuit boards are being marketed by Macrodyne Industries Inc. of Los Angeles. □



Here are three electromagnetic X-Y display scopes that have a lot in common: each has a big 12-inch diagonal CRT, is economically priced, and is ideal for applications requiring continuous monitoring of response signals with bandwidths up to 15 kHz.

The one in front is specifically for use in OEM systems. With the Model 1951, you can have controls mounted on the rear panel, or they can be pre-set on an easily accessible PC board. And the unit's power supply can be removed and installed

elsewhere in your system. The 1951 is particularly well suited to medical electronic systems.

The scope on the left is our Model 1901C which can be used with our (or anybody's) RF or microwave sweepers. The unit has a sensitivity of 1 mV per division which is ideal for low-level detection requirements. Features such as Z axis intensity modulation, Y marker adders and a blanking protection circuit contribute to the unit's versatility.

Finally, the scope at right is our

Model 1910. It's basically the same as the 1901C except that it provides dual trace capability.

So just decide which of these low-priced scopes has the most in common with your operation. We'll be happy to ship as many as you want. WAVETEK INDIANA, P.O. Box 190, Beech Grove, Indiana 46107, Telephone (317) 783-3221, TWX 810-341-3226.

**WAVETEK®**

# Scope City!

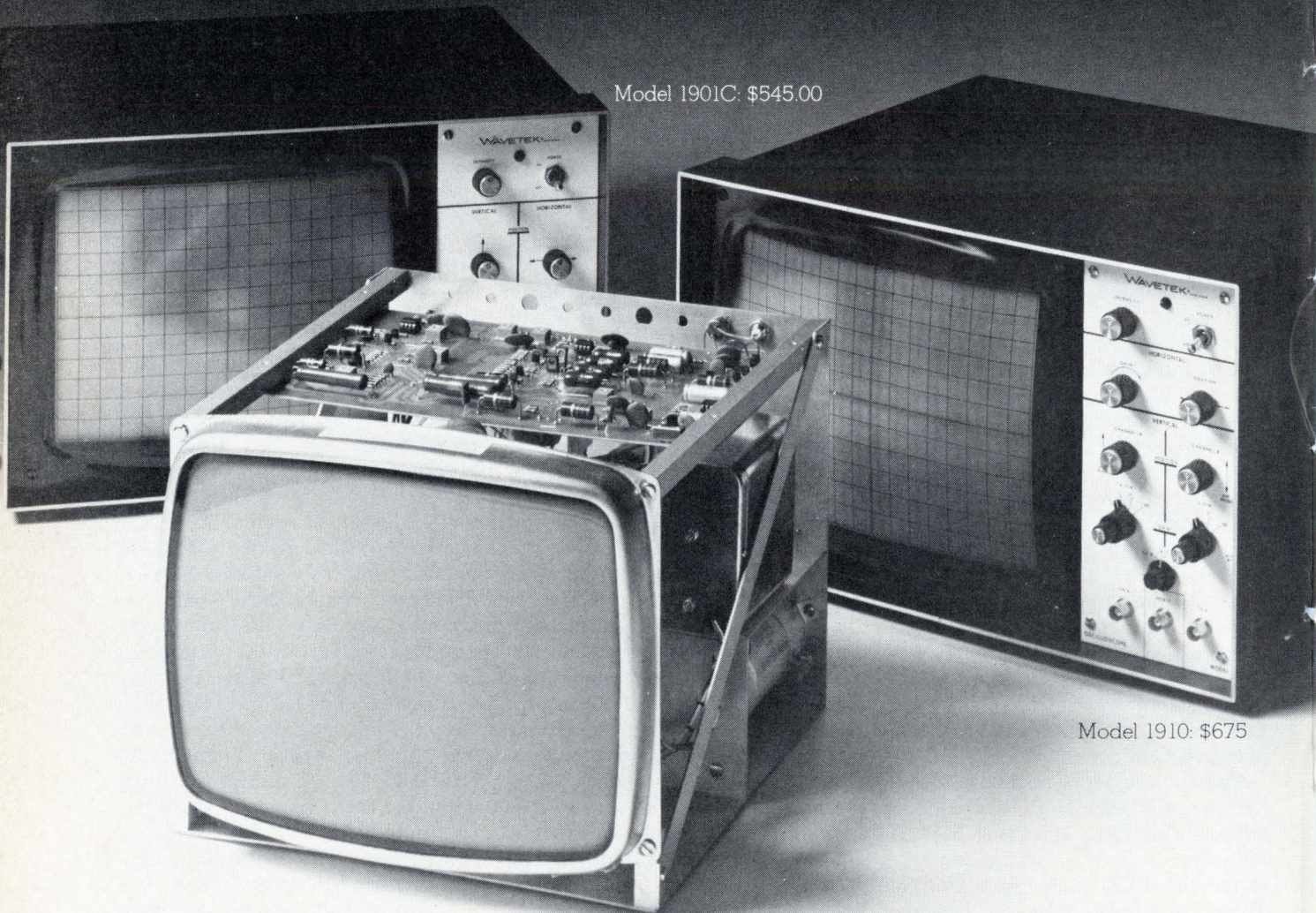

Model 1901C: \$545.00

Model 1910: \$675

Model 1951: \$450 (in small quantities)



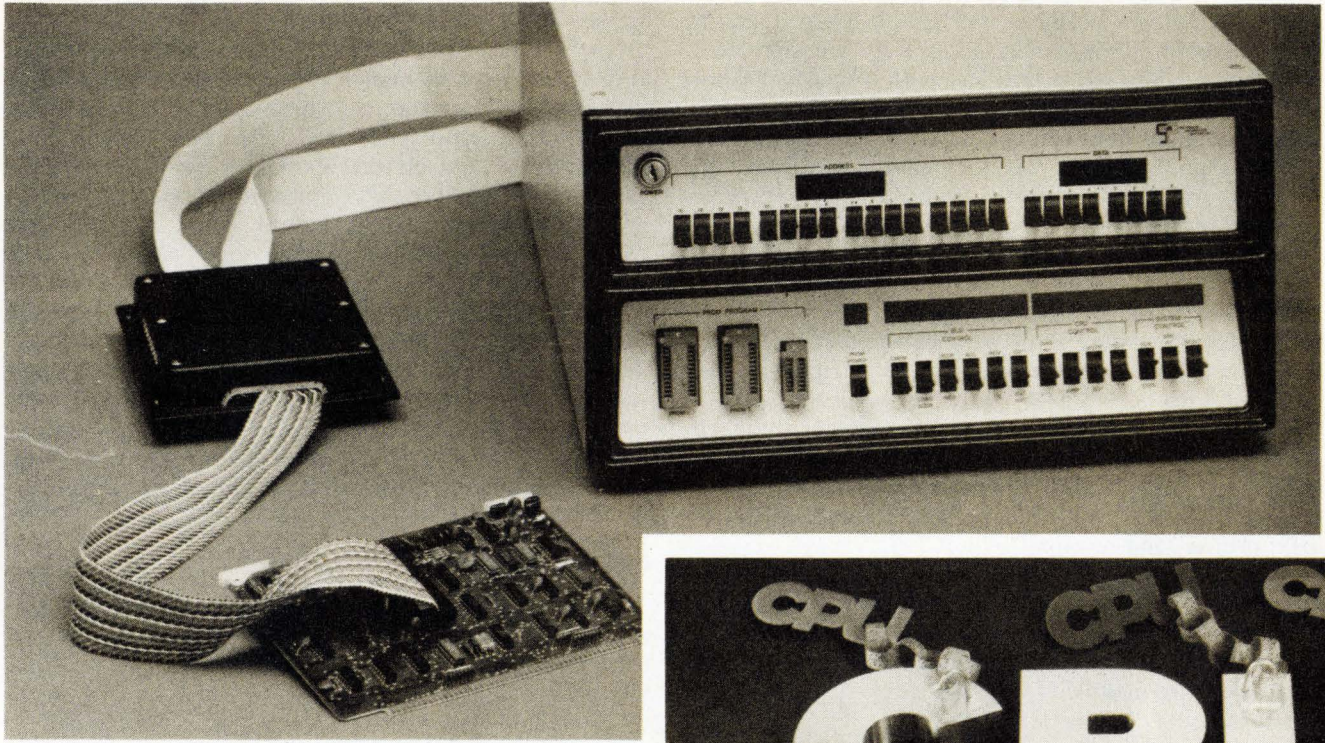

Adaptability to various microprocessors comes from separating prototype- and system-related tasks; in-circuit emulation and new high-level language are bonuses



# 'Universal' development system is aim of master-slave processors

by Robert D. Catterton and Gerald S. Casilli, *Millennium Information Systems Inc., Santa Clara, Calif.*

□ In the ever-changing world of the microprocessor, one element is fixed: heavy investments in personnel training, software, and development aids can lock designers into a particular processor for their systems. Each recently introduced hardware and software development system, for example, is based on a particular family of devices and isn't easily adaptable to other families. What is needed to free the designer from design compromises that reduce performance or cost effectiveness is a "universal" development system that can accommodate many different microprocessors.

A new system, called the Universal-One, achieves universality by a division into two functional areas. Those tasks that are related to the development system are assigned to a master central processing unit, and those that are prototype-related are assigned to a second,

or slave, CPU. As many as four different slaves may be installed simultaneously and individually used through operator commands. This multiple architecture enables the hardware to support new microprocessors with the addition of a pc card containing the new slave CPU.

Since the master processor need not be changed to accommodate new slave units, all of the operating system software remains the same. Presently, the system supports the 8080A and the 2650 central processors as slaves, with in-circuit emulation capability. It's easy to add other 8-bit processors to the system, and 16-bit devices may be added with only relatively little reconfiguration.

Although universality is the basic objective, there are four other major requirements that today's development systems should satisfy. Use of a disk-based storage



system will achieve high throughput for maximum software-development productivity. A disk-based operating system should be specifically tailored for microprocessor development. The user's interface with the system should be simple and remain unchanged regardless of the processor under development. The test and debug capabilities should support development of hardware and software and their integration into an operating prototype system.

### Functions

The master CPU is responsible for all of those system services that are not prototype-dependent, such as:

- File management—the storage and retrieval of data and programs.
- Text editor—maintains text files contained on the disk.
- System input/output—the normal I/O activities between the standard system peripherals, such as flexible disk, printer, and terminal.
- System utilities, including programming of read-only memories for the final version of the prototype.
- Debug functions—the master executes the debug software and controls the slave through a separate debugging hardware module.

The slave CPU's functions include:

- Program assembly—each slave may be used as a resident assembler of prototype programs.
- Prototype-program execution—the prototype program is loaded into the slave memory and executed by the slave.
- Prototype I/O—any special input/output required in the prototype is performed by the slave.

- In-circuit emulation—a cable extends from the slave to the CPU socket in the prototype.

The system architecture (Fig. 1) includes a bus structure to tie the components together and to permit the exchange of data and control signals. The basic bus design was governed primarily by the dual-memory and the multiple-CPU architectures. Other design considerations for the bus were that the memory portion had to be able to handle 8- and 16-bit data words, and that the overall structure had to accommodate future higher-speed microprocessors.

The system services the peripheral I/O devices and debug logic with interrupts rather than with polling. With an interrupt-driven system, the peripherals can get service when they need it, without waiting for their turn in the polling sequence. It also allows an efficient software structure that is relieved of the overhead inherent to polling. In this way, maximum throughput is achieved.

### Memory structure

The random-access memory of the system is organized as 65,536 bytes of common memory and a 16,384-byte master memory. The logic on the master CPU module allows appending any one of four 16-kilobyte segments of common memory (Fig. 2) to the master memory space. This allows master-slave communication for transfer of data during I/O service requests and gives the master access to program-trace information developed by the debug logic discussed later.

Master-memory protection is accomplished by a special bus-control signal, which is sensed on the memory cards. Only the master CPU contains the

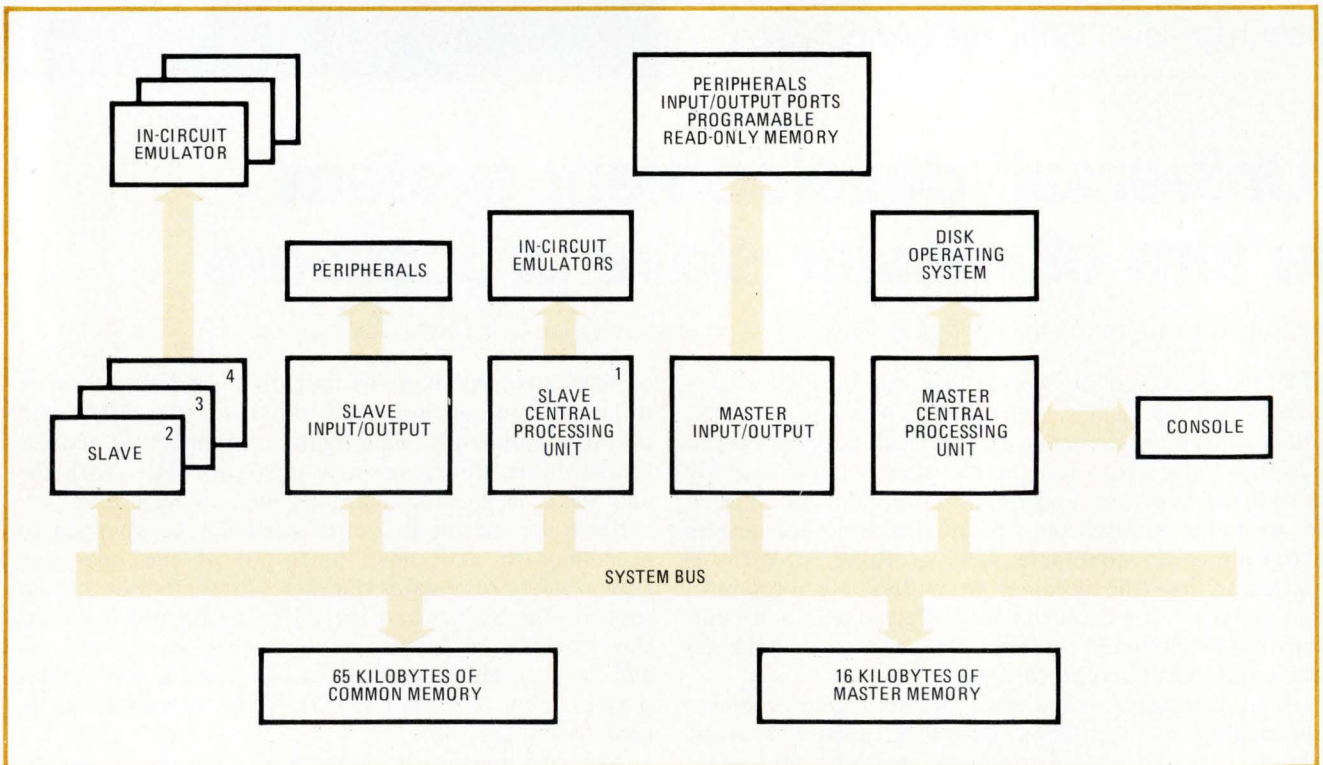

**1. Two CPUs.** The Universal-One system uses two central processing units—master and slave. In-circuit emulation is performed through the slave CPU, which duplicates the type of microprocessor used in the prototype. The master CPU handles system-related functions.



## A new compiler

To go along with the development system, Millennium has developed  $\mu$ Basic, a high-level language compiler designed for microprocessor applications. Although it was tailored to meet the needs of engineers, it also provides a useful tool for the professional programmer.

The new compiler offers the advantages of a high-level language—greater programming productivity, easier program maintenance, and portability from one microprocessor to another. In the Millennium development system, it also provides a “universal” programming capability, since the same  $\mu$ Basic statements can produce object programs for the different microprocessors.

As shown in the figure,  $\mu$ Basic statements are first brought into the “statement-analyzer” software package, where they are converted for input to the code emitter. Then, depending on the microprocessor and resident assembler being used, the code emitter generates the assembly-language statements, which are subsequently passed through the assembler to produce object code for the selected microprocessor. This two-step compilation process gives the programmer more flexibility when working out the program for the prototype.

A major criticism of high-level languages in microprocessor applications is that more memory is used than with assembly languages, and execution is slower. However,  $\mu$ Basic allows the programmer to intermix assembly language. In situations where a programmer thinks it necessary, this intermixed assembly language may use the same labels and variables as does the  $\mu$ Basic program.

A debug-optimize report produced by the compiler helps avoid software error conditions that the two-step compilation process might cause. The report shows the  $\mu$ Basic statement followed by the assembly-language listing that was generated to perform the original statement.

Typically, a programmer would first code and debug the program without regard to memory or performance constraints. Then, when the program is functioning correctly, the debug-optimization report can be used to show those areas that may require assembly coding to optimize memory usage. Since memory comes in fixed increments, the most important optimization is usually done when the program size exceeds that specified increment. If the program generated by  $\mu$ Basic does not exceed the memory increment available, then assembly-language optimization may not be needed.

Performance optimization also can be in assembly language. Usually, some small portion of the code is used most of the time—for example, 10 to 15% of the code might be used 80 to 90% of the time. Consequently, a concentration on those heavily used portions will produce the greatest increase in performance.

In its data and statement types,  $\mu$ Basic is generally equivalent to PL/M. The length of the data element may

be either 8 or 16 bits, and both 8 and 16-bit elements are supported at the same time.

Examples of statement types are:

- LET—the assignment statement.
- FOR . . . NEXT—used for loop construction.
- IF—the test statement.
- GOTO, GOSUB, RETURN—control transfer statement.
- ON—for a computed GOTO or GOSUB.

The  $\mu$ Basic compiler features an ability to specify memory locations for arrays. This is quite important in connecting a peripheral device to the system. Many peripheral devices operate out of a dedicated-space memory. To conveniently interface a program written in a higher-level language to that device, the programmer must be able to position the array in the same location in memory that the device is using. This is also very important in microprocessor systems where there is a RAM/ROM trade-off. The programmer can control the origin of the portions of the program to be put in ROM and RAM.

In comparing  $\mu$ Basic with PL/M (the most widely used high-level language), it can be seen that the latter is a “richer” language. A professional programmer is comfortable using PL/M and can take advantage of its greater complexity. However, the logic designer or other nonprofessional programmer probably will have to expend some effort to learn enough about PL/M to be able to write programs using it. In contrast,  $\mu$ Basic is easy to learn and use, while being quite effective.

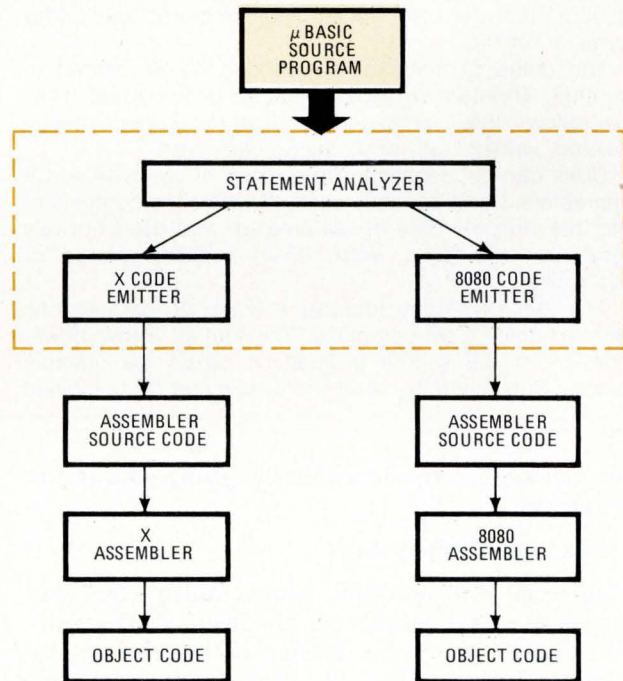

circuitry to activate this control line. Thus, the slave processor cannot gain access to the master memory and destroy its contents or (through damage to the file manager or part of its data structure) the files themselves, out on the disk.

The slave can address the common memory as a 65-kilobyte or as a 32,768-word, 16-bit memory. This allows

the 8-bit master to address a 16-bit slave memory as sequential bytes.

There are also commands that permit the operator to display and alter common memory. He may inspect and change the contents of the memory, and he may display and alter the contents of the registers. He may interact with his program and change variables—change register



## Using the software

The Millennium development system has many software features related to its use of a floppy disk for mass storage and the UDOS operating system for the disks. The system can have up to four floppy-disk drives all in use at the same time. A file name in use on one disk can be the same as one on another. The user can specify the file he wants by appending the floppy-disk drive number to the file name; i.e., TESTPROG/1 or TESTPROG/2.

Through use of the VERIFY command, a user can check the floppy disks to determine if any of the tracks are bad. The bad tracks are recorded in the disk's directory and thereafter are not allocated to a file.

The user need not create a file or otherwise establish it before writing data on it. When he issues a UDOS command with a file name as an output device, the file will automatically be created, and the name will be placed in the directory for the floppy disk.

The user need not allocate space for a file before using it, for disk space is dynamically allocated by UDOS as it is needed. When the file is closed, the space allocated is recorded in the directory. When the file is deleted, the space allocated is freed up and made available for allocation to other files.

A file name may contain as many as eight alphanumeric characters and special characters. This allows the user to use names that are more indicative of the file content; i.e., PROGLIST rather than PRGLST, or, worse yet, PGLS. A disk file may contain anywhere from 1 to 311,296 data bytes. The user need not concern himself with extraneous data or otherwise keep track of the number of "real" data bytes in his file.

The entire contents of a disk can be duplicated in another. This feature allows back-up of important disks and allows the user to recover if a file is inadvertently deleted, written over, or otherwise destroyed.

Disks can be identified with a string of up to 44 ASCII characters. Users can thus briefly describe the contents of the disk and the date it was created, and need not rely totally on the label, which could become marred or destroyed.

The user can string together a group of files into one with a single UDOS command. This feature allows development of the source program in small, manageable pieces. Subsequently, all of the pieces can be combined

and placed on a single file, which can be assembled. If an error shows up in the assembly, only that piece of the source program which contains the error need be edited. All of the pieces can then be combined again and the assembly repeated.

All I/O operations can be assigned to channels by software. The user can assign any device attached to the system to any one of up to eight I/O channels and need not concern himself with the characteristics of the device. This feature allows the user to prepare programs whose input and output sources can be determined at run time. Channels can be assigned for a program externally through the console or internally by the program itself.

A sequence of UDOS commands can be executed one at a time from a command file. The user can thus invoke any number of commands simply by issuing the name of the command file. The individual command can be filled with parameters that are given at the time the command file is invoked. Thus frequently used command sequences can be invoked simply. Command files can also be chained—the last UDOS command in a file can be the name of another file, allowing a series of jobs to be run in a batch mode, perhaps overnight, unattended.

The text editor is line-oriented and has a command repertoire similar to those available on large time-sharing systems. The user can create a file of assembly-language statements or a data file by entering lines of text through the system console. Subsequently, he can insert lines anywhere in the file, delete lines, replace them, or modify part of the text on a line.

During a text-editing session, the user can get lines of text from any file and merge them into the file being edited or put lines of text from the file being edited to any other file. This feature provides the capability of manipulating lines of text from several files and merging them into one file quickly and easily. With the text editor, the user can combine several text-editing commands into one complex command and then cause it to be executed several times.

The user can set tabs dynamically and designate any console key as the tab character at any time during a text editing session. He can also issue UDOS commands and cause other system functions to be initiated during a text-editing session.

contents or change the data elements being used in the debug process.

### The disk operating system

A universal disk operating system called UDOS was developed for the multiple-CPU architecture. This software is executed by the master in its own totally protected master memory. The UDOS feature is floppy-disk-oriented, taking into account the characteristics and peculiarities of such disks. Many file-management functions usually performed by the user are performed automatically. The user need only direct that certain data be stored on a file or taken from a file.

The operating system allows the user to develop microcomputer programs with a high-level language (see "A new compiler"), a symbolic assembler, or both. The user can prepare a program with a text editor, correct

and modify it quickly and easily, assemble it, load the resulting object code into common memory (or into the prototype memory), and cause it to be executed under debug control.

During execution, the program steps can be traced, breakpoints can be set, and memory can be inspected and altered as required. Subsequently, the program can be corrected or modified at the source level, using the text editor, then reassembled, loaded, and executed again for the next round of debugging. (see "Using the software").

### In-circuit emulation

Each slave contains circuitry to support in-circuit emulation. When the prototype becomes ready for test, all of the development-system resources become available to it once the emulator cable is plugged into the



microprocessor socket of the prototype. The operator can then use the system's debugging software to debug the prototype hardware and software and then to integrate them.

The system supports two operating modes for emulation. In one, the user can substitute the memory of the development system for that of the prototype. In the other mode, when the prototype's memory becomes available and its I/O functions have been thoroughly tested, the operator can execute programs from the prototype memory while maintaining full control through the development system.

When operating with the prototype memory, most of the system debugging features are still available. The user can use the address breakpoint and do a full trace. If this mode requires the programmable ROM of the final prototype, the master can directly program the assembled instruction into the PROM chips. If the object resides on paper tape, it can be loaded into the system and transferred to the PROMS.

The user can switch emulation modes at any time by a console command, with no hardware changes. The cable may be left attached to the slave even when the emulation feature is not in use.

The development system's memory is comparable to the memory speed of most prototype systems, and thus it nearly simulates real-time operation when programs are executed from the system. When programs are executed from the prototype memory, the slave can operate at the the prototype's clock and memory speeds. Timing differences resulting from the use of the umbilical cord are minimal.

### Master-slave interaction

When input/output from a master-controlled peripheral is required by a slave program, the slave CPU executes a service-request instruction, which causes the slave to pause temporarily while the master obtains the necessary data for the slave program. When the I/O requirements are completed, the master releases the slave so that it may continue the process of program execution.

The debug logic is on a separate module and includes breakpoint registers, address-computation circuitry, two program-counter registers, and single-step and interrupt logic. The functions controlled by this logic are independent of the slave microprocessor and thus support the universal aspects of the system design for application to a variety of target processors.

Part of the master-slave interaction includes control of breakpoint and trace operations. The master loads the breakpoint addresses under command from the user. When the memory address and operation from the slave match the breakpoint value, the program running under the slave pauses, and control is passed to the master. The debug module stores the slave's instruction-fetch address to enable the software to examine the prototype program and to interpret operating codes for the trace printout. Synchronization signals are provided to aid the user in triggering events necessary to debugging of prototype hardware.

The two memory-address breakpoint registers may be

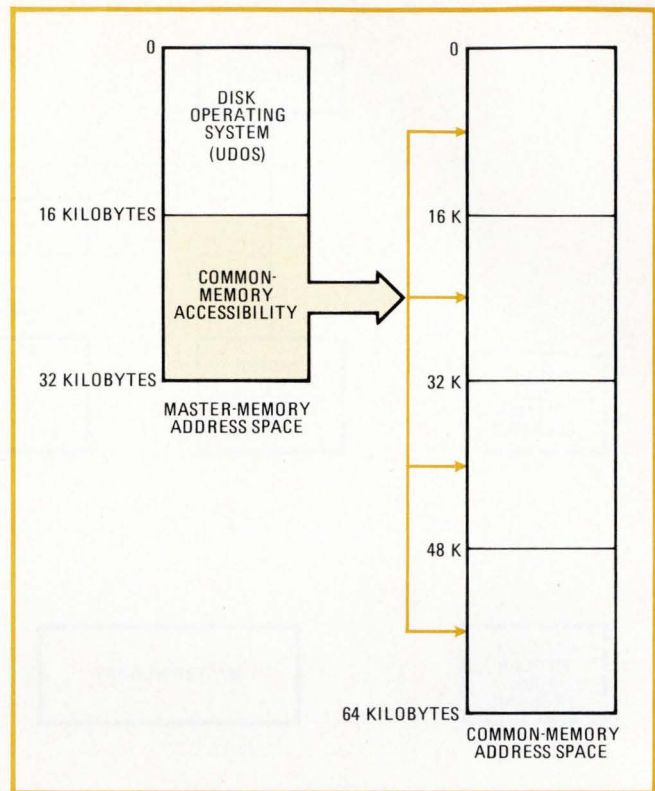

**2. Memory addressing.** The master CPU can address 32 kilobytes of memory. Of this total, 16 kilobytes are used by the disk-operating system, UDOS, while the other half can consist of any of four 16-kilobyte blocks in the common-memory addressing space.

set to break on any of a variety of memory-access conditions. Another capability is a dynamic trace of the user program. On an instruction-by-instruction basis, the user can trace the activity of the program being executed, with a display of the location of the instruction, its mnemonic, the register contents, and the state of the machine (such as the condition of the carry flip-flop).

Dynamic trace may be performed on every instruction, on instructions between two memory limits, or on only the jump instructions. The jump-instruction trace reduces print-out time and runs through the program faster. If the user isolates a problem area, he may go back to the full-trace mode and examine every one of the instructions.

### I/O and interrupts

The functions associated with the master and slave CPUs dictate the need for separate master/slave input/output and interrupt structures. The master has a 256-port I/O address space and a 32-level interrupt structure. Sixteen interrupts are devoted to debug functions and service requests. The other 16 are related to the system I/O.

The master card contains the I/O ports to support such standard peripheral devices as the dual-drive floppy disk, a line printer, and a cathode-ray tube or teletypewriter console. With the addition of a standard general-purpose I/O card, the system-related functions are easily expanded to support other peripherals, such as high-



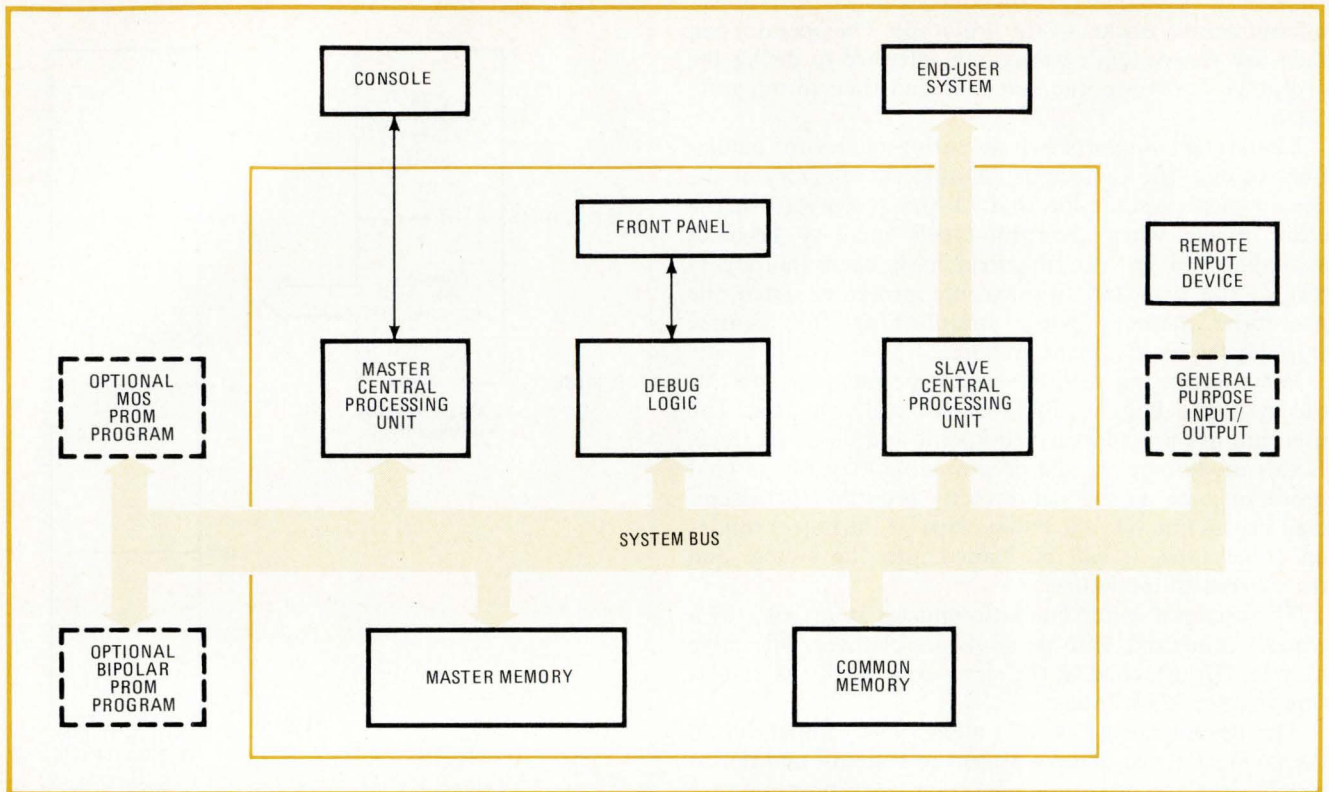

**3. Smaller system.** For applications in which users have already invested in software development aids, the Universal-One can be pared down to provide only emulation and PROM programming. Memory is much smaller, while the blocks shown in dashed lines are optional.

speed paper-tape or card readers.

The slave has a 256-port I/O address space and an eight-level priority-interrupt structure. It cannot directly address the system I/O. However, through the use of service requests to the master, it has full access to the system peripherals.

The user also has the option of using a general-purpose I/O card as interface between the slave and its special devices, such as the prototype's keyboard or printer. In such a case, the slave will perform its own I/O functions on those devices. The general-purpose card provides a full EIA-RS-232-compatible port and four 8-bit input/output ports.

### Expandable PROM programming

Capability for programming erasable metal-oxide-semiconductor and bipolar-fusible PROMs for the final version of the prototype is integral to the development system. Two card slots in the motherboard and three front-panel sockets are provided with the standard system. Personality cards are available for programming the 1702A MOS PROM and the 82S115 4- and 8-bit bipolar family. New programming cards are easily substituted for other families of PROMs.

As well as eliminating the need for a separate PROM programmer, this feature is more cost-effective, since dual I/O circuitry is unnecessary and operation is controlled by the master CPU rather than by a separate processor. The programming cards are interrupt-driven, freeing the master for other tasks during the programming of each byte.

Even though a PROM verifies correctly, it may lose

charge or "grow back" a fusible link if not programmed properly. Therefore, the cards have many protection and error-checking features such as over-voltage protection, current limiting to prevent overstressing, and power-failure protection against partial programming of the devices.

### The universal emulator

Many companies already have some method of accomplishing the pure software-development function of assembling and editing programs, but they lack means of performing emulation or PROM programming for use in the prototype system. Other companies have a complete microprocessor development system, but they are involved in multi-project situations with one particular project fully occupying their development system. In either situation, companies may find a second version of the Millennium development system useful. With an expanded front panel and a paring-down of the system memory to 12 kilobytes, it becomes a universal emulator and PROM programmer (Fig. 3).

All of the software debug functions for both emulation modes previously discussed will be retained. The basic functions, such as patch, dump, examine, breakpoint, and others will be resident in the PROM. Only the trace program, which will change for each target slave, will be loaded into master memory from the console device. User programs may be entered into common memory either from the console device or remotely from a host computer via an EIA-RS-232 serial interface. Also, PROMs may be used to hold user programs that will be executed in the prototype. □



# Microprocessor multiplies a digital multimeter's functions

8080-based controller creates 'virtual' modules by manipulating data from actual plug-in modules

by Robert I. Hatch, *John Fluke Manufacturing Co. Inc., Mountlake Terrace, Wash.*

□ A microprocessor can do more for a test and measurement system than merely tidy up its front-panel controls—by manipulating the conditioning, converting, and digitizing circuitry, it can vastly increase the system's versatility. In the case of the Fluke 8500A, a modular instrument system that is programed to perform the functions of a multimeter, a controller module based on an 8080-type microprocessor adds to the system's functions, besides adding to its conversion speed [*Electronics*, Sept. 2, p. 81].

Suppose a user needs to test SCR switching circuits for their maximum output voltages, which if too high will make them too noisy. With the addition of an optional plug-in remote interface, the basic 8500A gains the ability to store the highest dc voltage value it measures and to display this number on command. And since the 8500A's analog-to-digital converter can take more than 500 readings a second, probably even short-lived transients will be caught.

Perhaps the user instead wants to measure the small

resistance of switch or relay contacts. Normally, four-terminal resistance measurements would be necessary to negate the effects of the instrument's lead resistances. But the basic 8500A, plus a resistance-measurement module, automatically subtracts this lead resistance from each measurement if the user merely shorts together the leads of the 8500A probe and then uses the measured value as an offset to be subtracted from further readings.

In yet another context, the need may be for an ac-dc voltage-transfer standard—and the 8500A will behave very much like one of these when its true-rms option is installed. Since the true-rms measuring circuit is direct-coupled, dc and ac voltages are measured through the same signal path. As a result, the value displayed for the output of a dc standard cell should equal that of an ac signal with the same heating or rms value. Also, because the instrument can be calibrated against this standard through the same circuitry, the measurement of an ac voltage made by comparison with the standard can be

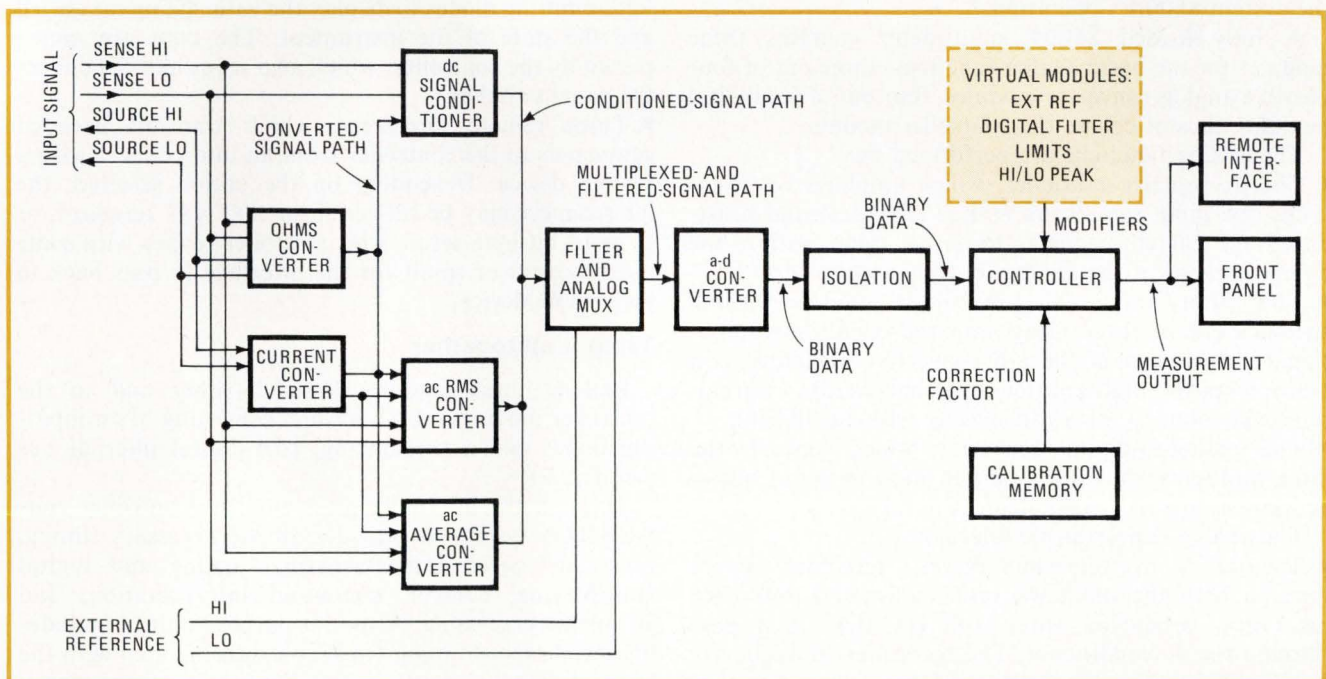

**1. Modularity.** Each module within the 8500A digital voltmeter performs a specific function. The combination of module functions with the intelligence provided by the microprocessor-based controller produces virtual functions that do not correspond to particular modules.



more accurate, by an order of magnitude, than one made solely with the instrument's ac converter.

Partly responsible for this versatility is the complete functional modularity of the 8500A multimeter. Each module—even the controller module, which is programmed to make the system behave as a digital multimeter—is fully defined by its function. Consequently, each module can simply plug into the system's unifying data buses. These buses are mounted on the motherboard that forms the floor of the 8500A's essentially passive container.

Adding to the versatility is the fact that the 8500A delivers more functions than it has modules. It does so because the controller has charge of all other modules and can combine its arithmetic-processing capabilities with their functions and subfunctions. In other words, the manipulation of well-bounded functions by centralized, intelligent control gives rise to what may be called virtual modules: modules that do not physically exist yet appear to do so.

For example, in testing circuits for their maximum voltage, the 8500A acts as a peak detector—yet it contains no hardware dedicated to this function. The same is true for external reference, limits, and digital filter, also virtual modules within the 8500A.

### Shrinking processor costs

The microprocessor-based controller that adds this capability to the 8500A does nothing a minicomputer could not have done before—if instrument users had been willing to pay for minicomputer-based systems. But it does more than, say, logic driven by microprogramed read-only memory. Such a logic module could have supplied the same centralized control of other functions and is more than cost-competitive, but it cannot supply the data reduction and arithmetic processing essential to the system 8500A's operation.

A fully loaded 8500A multimeter contains three modules for the basic analog functions, three out of four possible analog-converter modules, four out of six digital modules, plus of course the controller module.

The analog functions are performed by:

- The dc signal conditioner, which amplifies or attenuates raw input signals, as well as any converted resistance and current signals, to bring them within the dynamic range of the analog-to-digital converter.
- The filter and analog-multiplex module, which switches one of three filters into the conditioned-input signal path ahead of the a-d converter. In addition, it multiplexes the high and low terminals of the external-reference input to the a-d converter without filtering.
- The analog-to-digital converter, which converts the filter/multiplexer module's output into a series of bits—actually a binary 2's complement number.

The analog-converter modules consist of:

- The ohms converter, which drives a reference current through both the unknown resistance and a reference resistance, producing three voltages that then pass through the dc conditioner. The controller subsequently calculates the unknown resistance from an equation that infers the value from the three digitized voltages.
- The current converter, which turns a direct- or

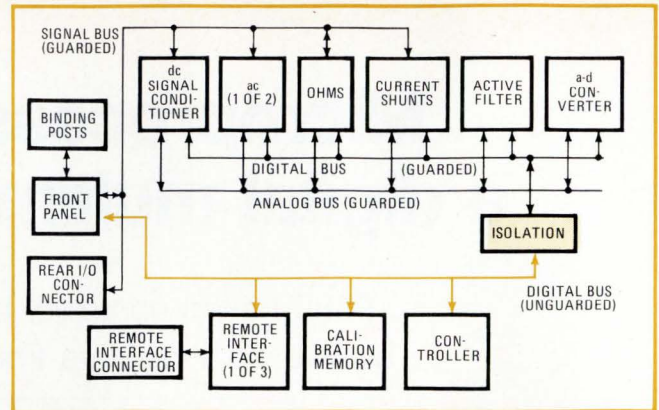

**2. Internal bus.** Modules within a measuring instrument can be interconnected by a set of bus lines that carry power, signals and internal analog and digital data. The digital bus can be split into guarded and unguarded segments by an isolator module.

alternating-current input signal into a voltage for further processing either by the dc signal conditioner or by whichever ac converter is used.

■ An ac rms and an ac average responding converter, either of which when installed turns an ac voltage from the current converter or the input bus into a conditioned dc voltage (which therefore does not need to go through the dc conditioner).

The six digital modules consist of:

- The isolation module, which separates the digital module's reference from the precision functions of the analog modules. This prevents the transfer of noise between analog and digital circuits.
- The calibration memory, a nonvolatile memory of correction factors for each instrument function and range.
- The front panel, which uses digit and annunciation light-emitting diodes to display the value being measured and the state of the instrument. The LEDs are multiplexed by the controller, which also scans and debounces the panel switches.
- Three remote interfaces, which transmit encoded commands to the controller from an interconnect with a remote device. Depending on the option selected, the interconnect may be bit-serial, or IEEE-488 standard, or 8- or 16-bit-byte-serial. The controller replies with some measurement or result for the interface to pass back to the remote device.

### Tying it all together

Linking these modules to each other and to the controller module is a bus system consisting of an input-signal bus and a part-analog, part-digital internal bus (see Fig. 2).

Through the internal digital bus, the controller runs the 8500A system. It provides all the necessary timing, code conversion, data formatting, analog and digital multiplexing, control, command interpretation, and arithmetic processing. A special-purpose unit, it includes line synchronous timing (to keep control in step with the line frequency) and sets certain limits to memory expansion and the use of the microprocessor's instruction set.

It's the controller, too, that creates the 8500A's virtual



modules. There is no tangible circuitry behind:

- The external reference (true ratio), which translates the measured value displayed into a function of the external reference. To be more specific, the external reference is switched into the measurement flow at the filter module, digitized, and passed through a digital filter to remove noise. The result is then divided into the input signal's digitized value to yield the true ratio of the input signal to the external reference.
- The digital filter, which in the 8500A takes the form of digital averaging in the processor. For this function, samples of the input signal are taken at a rate equal to an even multiple of the line frequency, and a number of these samples is averaged. The result is a rolloff, at 20 decibels per decade, from a pole at a frequency determined by the number of samples averaged and the sample rate. (Cusps appear at multiples and submultiples of the line frequency; the larger the number of samples, the lower the frequency of the pole will be, and the larger the number of cusps.)
- Limits, a function that is selectable only from remote controllers, not front-panel switches. Upper and lower limits may be set, and then a function called that will report the relation of the input signal to the set limits (equals, greater than, less than). The limits function is made possible by the arithmetic capabilities of the 8080 microprocessor.
- High/low-peak detection, also selectable only from remote controllers. The 8500A's internal controller

keeps track of the highest and lowest values of the input signal for as long as it is performing this function. It compares each new measurement with the previously set limits, which it updates whenever a new measurement exceeds them.

### Inside the controller

To understand how the controller module uses the digital internal bus to run the 8500A system, some idea of its structure and contents is necessary. Physically, it is a few chips mounted on a three-layer printed-circuit board. A card-edge connector plugs it into the motherboard, to let it pick up power and the internal bus.

Besides the 8080 processor chip, the controller board contains 8,192 8-bit words of program memory. This takes the form of four 2,048-bit n-channel read-only memory chips that are mask-programable at the factory. In addition, the board contains at least 512 8-bit words of scratch pad in the form of four 256-by-4-bit n-channel random-access-memory chips. Two more of these RAM chips may be inserted in the board, to give a total of 768 by 8 bits of scratch pad.

The input/output port links the controller to the 8500A system's 18-line digital internal bus.

The interrupt logic and interface help build a six-level priority-interrupt structure into the controller. The four external interrupts have priorities 2 through 5; they are single wired-OR requests that, on receiving the controller's interrupt acknowledge, report dedicated data-line identities on bus I/O data lines ID<sub>1</sub> through ID<sub>4</sub>. The other two interrupts are internal: a 480-hertz line-synchronous mark with priority 6, and a 10-microsecond I/O handshake, used to detect missing I/O ports, with priority 1.

The 8080 central processing unit runs at a 1.7-megahertz clock rate, to accommodate slow memories without requiring a wait state during instruction fetches and memory references. Although the overall operating speed is about 15% less than with a 2-MHz clock, it would be about 30% less if the wait states were necessary. The wait states would also entail the use of much more complex logic to control the CPU's ready line.

The CPU is reset to program-location zero either at power up or after the 60-Hz reference has stopped for more than one line cycle. (Note this swift response to a power outage.) From the zero location, the CPU runs under program control for as long as the ready line is held active and neither a bus transfer nor an interrupt occurs. During a bus transfer to or from some module, the flip-flop controlling the ready line is set inactive, causing the CPU to wait until either an acknowledge is received from the module addressed or a 10-microsecond interval has elapsed. During an internal interrupt, the ready line is also held inactive, this time for the duration of one machine state (588 nanoseconds). During an external interrupt, the CPU waits until it receives an acknowledge signal.

The address structure of the controller treats the I/O ports and indeed all of the function modules as memory locations instead of through discrete control lines to each module (Fig. 3). In other words, the controller addresses the other modules in the same way as it addresses spaces

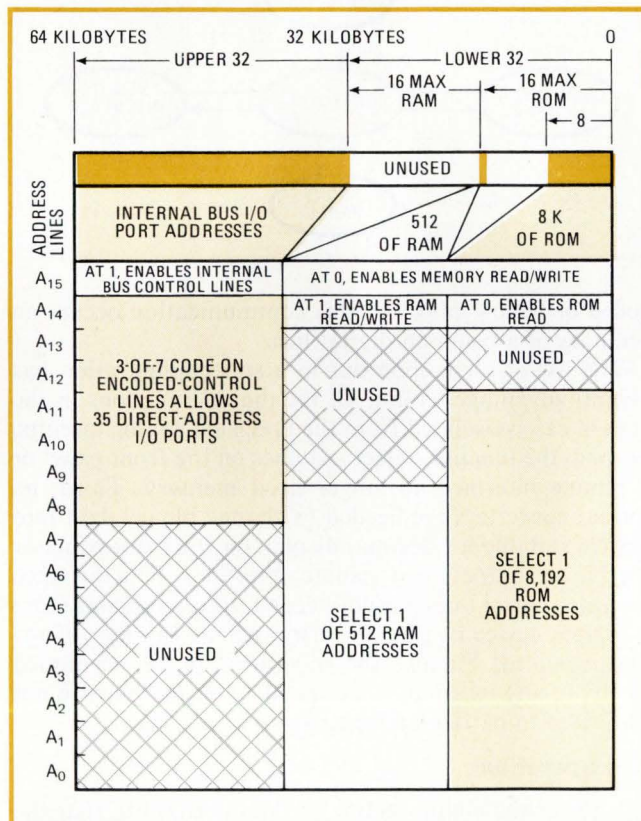

**3. Memory map.** The controller's 16 address lines can handle 64 kilobytes of memory. But line A<sub>15</sub> instead routes some control signals to memory locations and the others over the internal bus's digital lines to system modules. A 3-of-7 code selects the right module.



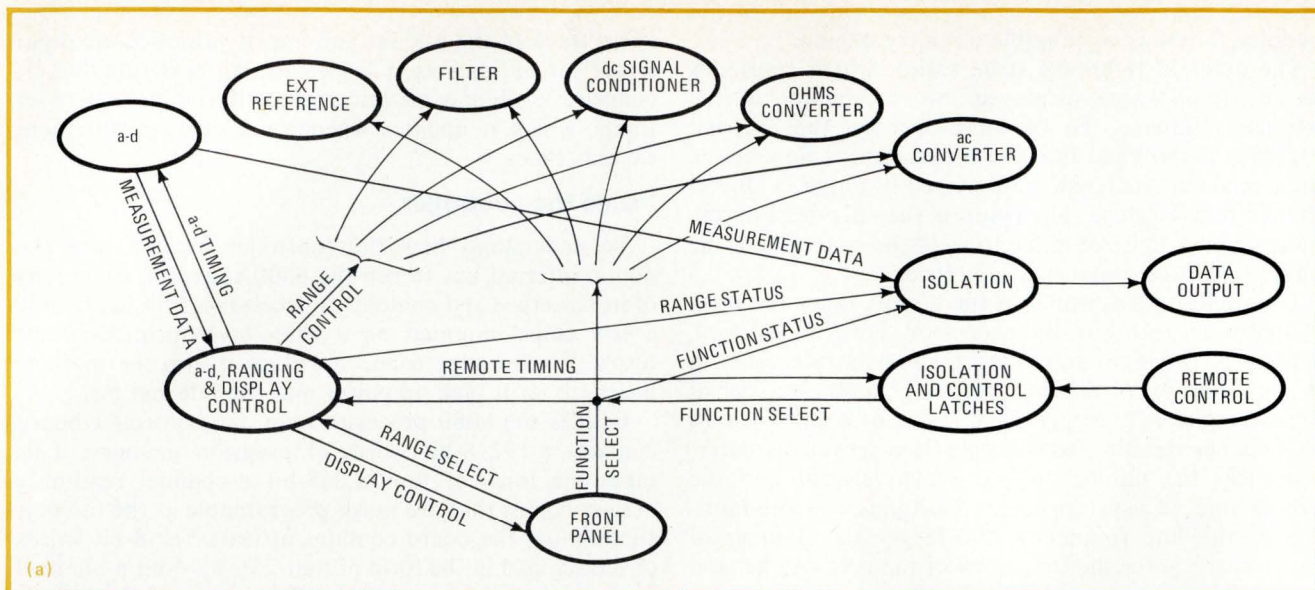

**4. Interplay.** In conventional instruments, data and control signals are interchanged by circuits over discrete lines (a). The microprocessor-based controller simplifies the structure by sitting at the center of a star; data never passes directly between outlying modules, but is always routed through the central controller (b).

in its memory, and it also treats input from them like data it has recalled from memory. Over its 16 address lines, the CPU could address a maximum of  $2^{16}$  or 65,536 locations in memory. Instead, it allots half of these to its transactions with other modules and keeps half for addressing its own memory. The design allows for a maximum of 16 kilobytes of RAM and 16 kilobytes of ROM when the appropriate memory-expansion boards are plugged into the instrument.

### Centralized control

Digital communication within the 8500A multimeter system is organized in a star configuration, with the controller at the center. The traditional approach is quite different (Fig. 4a). The front-panel push buttons used to select functions in other multimeters generally remain depressed (selected) until pushed again. From these push buttons, discrete control lines go to the active circuitry of the functions. Since there is no common control and data bus, the remote interface has typically been divided into a data output unit and a remote control unit. The former takes data directly from the a-d converter, while the latter latches discrete command lines and drives the discrete control lines to the functions. Isolation occurs at the remote interface as part of the data output and remote control.

In the 8500A system, however, all communications must pass through the controller—no data or control signal can go directly between any two other modules (Fig. 4b). Remote or front-panel commands are handled as inputs to the controller, and control data is treated as outputs to functions at module locations. Digital measurement data is treated as inputs to the controller from the a-d converter, and is then formatted, corrected, and finally sent as outputs to either the front panel, in seven-segment code, or the remote interface, as ASCII-

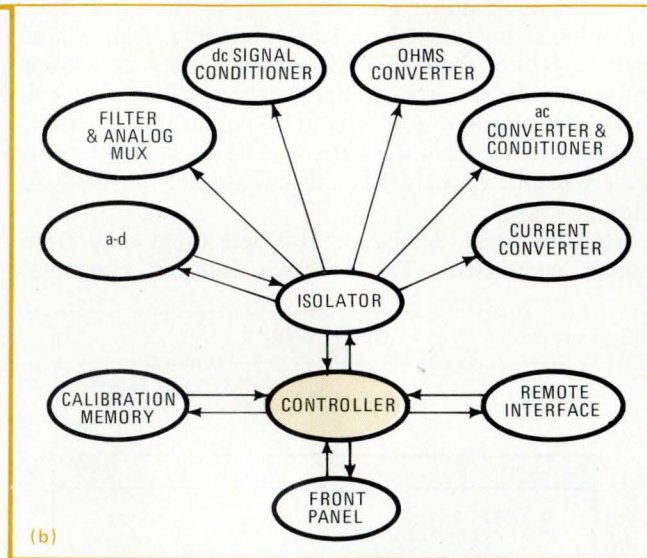

coded or binary data. All this communication occurs on the lines of a common digital bus.

The use of a common bus in a star configuration has several advantages. First, all the digital functions in the system can be isolated from the precision analog circuits. Second, the function-select switches on the front panel or a remote interface no longer need memory. Third, no format converters are needed to change binary data into a form suitable for decimal display on the front panel or for binary output to a remote interface. Fourth, since discrete control lines are not needed, the commands from a remote device can be encoded and the number of I/O lines reduced. Finally, the modules can be positioned freely, in any location, since the slots on the bus are not dedicated to particular functions.

### Bus operation

It's over the digital section of the internal bus that the controller communicates asynchronously, in 8-bit bytes, with the other modules. Transfers of data bytes are made on the bus's eight data lines (ID) and managed by its seven coded control or address lines (IC), in conjunction



with the acknowledge line (ACK), which is a wired-OR function of all modules present on the bus.

The direction and source or destination of data are controlled by the particular bit pattern present on the IC lines. A 3-of-7 code provides a self-deskewing address code with 35 direct 3-bit addresses (it returns to zero when the lines are inactive). A valid address code on the IC lines elicits an acknowledge signal from the module involved. The controller responds to it by terminating the transfer in progress. When the IC lines go inactive, so does the ACK line.

Interrupts from other modules reach the controller through the interrupt-request line (INT) and are acknowledged on the interrupt-acknowledge line (INA). The four priority levels of these external interrupts are specified by four of the data lines (ID).

An interrupt request to the controller will result in an interrupt acknowledge if the control program has interrupts enabled. When the interrupt-acknowledge line becomes active, each module that can interrupt drives its dedicated data lines, ID<sub>1</sub> through ID<sub>4</sub>, active if it has an interrupt request, or inactive if not. This limits modules identifiable by a vectored interrupt to four.

### Timing interrupts

The timing for transferring the vector data to the controller is handled by a handshake between the INA and ACK lines. When the INA line is active, information is sent to the controller over both the ID and the ACK lines by interrupt-capable modules. But as soon as the controller acknowledges receipt of this information, the interrupt-acknowledge signal is terminated, removing both data and the acknowledge signal from the bus.

The 35 direct 3-bit addresses correspond to modules or registers. All the acknowledges within a module are logically OR-ed together before driving the wired-ORed ACK line. Input addresses, specified by control line IC<sub>6</sub>, account for 15 of the addresses. Output addresses account for the remaining 20. Guard crossings are controlled by IC<sub>5</sub>.

Each of these direct addresses may be expanded to 18 indirect register addresses by a 2-of-7 code. This code becomes valid only after a direct address has been remembered, and there must be no overlap of the direct over the indirect codes. The acknowledges of all indirect addresses are logically OR-ed with the direct-address acknowledges within a particular module and are then driven onto the ACK line.

For example, the indirect mode of register addressing is used on the front-panel module (Fig. 5). The first register holds the seven-segment and decimal-point data for the digit to be strobed. The second holds data that selects one out of a bank of three annunciator LEDs. The third selects one out of seven digits and, simultaneously, one out of five banks of annunciators to be strobed; it also selects one out of seven banks of switches (six switches per bank) to be activated in the switch array. The last indirect address drives the data from the selected switch bank back to the controller.

Repeating the above four transfers seven times completely updates the front-panel display and reads all the switches. Complete updating of the display must

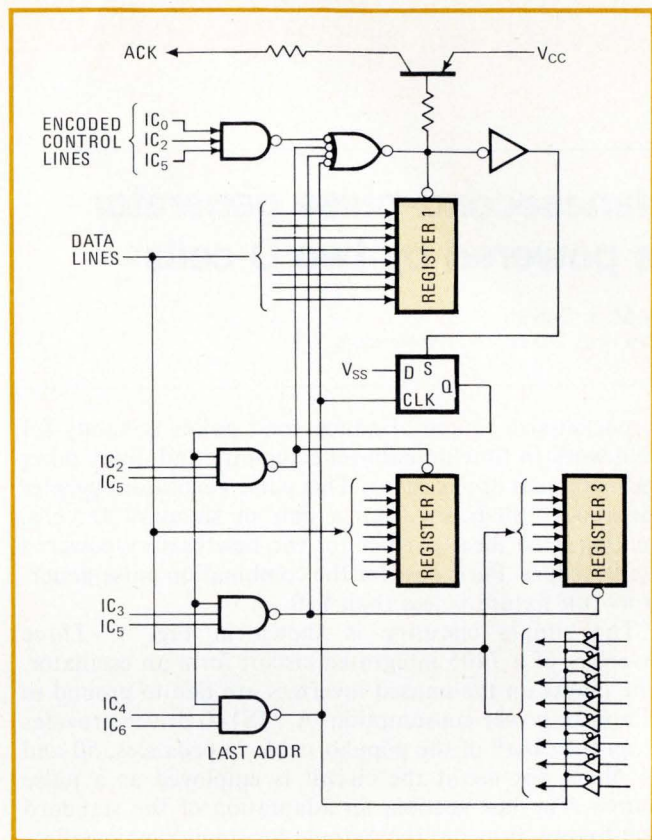

**5. Indirect.** Within the front-panel module, information on the data and control lines is decoded, then stored in three 8-bit registers. These operate lamps and 7-segment readouts, besides scanning momentary switches to determine operator commands.

occur at a frequency greater than the maximum strobe rate the human eye can detect—about 50 times a second. Changing displays at lower frequencies would become visible as flicker.

With this arrangement, all the control logic required for a multiplexed display is moved to the controller and exists physically in the 8080 and ROM. The same is true of debounce logic. When the controller program detects an active switch, it delays to allow for debounce.

The intelligence of the controller is also instrumental in selecting the mode of communication with remote devices. With the controller sitting central to all data transfers, it is a logical step to go from encoded commands sent from remote devices, to a higher level: a string of command words or a program language using alphanumeric characters related to the function selected (V for volts, I for current, or Z for ohms, for example).

The code selected for this character set was the ASCII 7-bit code. To command the 8500A to perform a function and send a reading requires a string of ASCII characters, defining the details of the function, followed by a trigger character. The result of such a command string will be either a string of ASCII numeric characters representing the measurement or a string of binary bytes (not ASCII), depending on the mode selected by the command string. This form of communication is far above the limited abilities characteristic of nonintelligent instruments. □



## Nanosecond-pulse generator is powered by two D cells

by M. J. Salvati  
Sony Corp. of America, Long Island City, N.Y.

A pocket-size source of nanosecond pulses is handy for field work in time-domain reflectometry and many other measurement applications. This pulse generator operates for about 180 hours from a pair of standard D cells, making it an ideal partner for the new battery-powered oscilloscopes. Parts cost for the combination pulse-generator/TDR fixture is less than \$10.

The simple circuitry is shown in Fig. 1. Three inverters of a 7405 integrated circuit form an oscillator. The inputs on the unused inverters are tied to ground to minimize power consumption. A 74S140 driver provides outputs at both of the popular cable impedances, 50 and 75 ohms, for use if the circuit is employed as a pulse source. The last section, an adaptation of the standard TDR fixture, provides the outputs for time-domain-reflectometry applications.

The FREQ switch selects pulse repetition rates of 2.8 megahertz or 150 kilohertz. With a duty cycle of about 60%, the pulse widths are 200 nanoseconds and 3.5 microseconds, respectively. The 3.5- $\mu$ s pulse width permits cable lengths of over 1,000 feet to be checked. The 2.8-MHz repetition rate produces a bright scope trace for tests on short cables or network impedances [*Electronics*, Oct. 9, 1972, p. 119]. The rise time at either

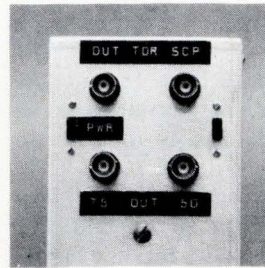

**2. A box of pulses.** Complete pulse generator, including batteries and fixture for time-domain reflectometry, is housed in a standard 3-by-2-by-5 1/4-inch aluminum box. Unit runs for 180 hours on two dry cells. Shown unlabeled at the right is the two-position frequency switch.

repetition rate is a little over 4 ns, a speed achieved by operating the TTL ICs below their rated voltage. The output amplitude into 50- or 75-ohm loads is about 0.8 volt. If three D cells instead of two are used to power the generator, the output amplitude is about 2 v, but the rise time is increased to about 5 ns.

Construction is on a small piece of Veroboard. Since TTL ICs are specified for propagation delay rather than rise time, the circuit should be breadboarded first with a socket to facilitate selection of a 74S140 with a fast rise time. The entire assembly can be housed in a 5 1/4-by-3-by-2-inch aluminum case (Fig. 2).

This device has other applications. The useful harmonics (3 millivolts minimum) of the 2.8-MHz pulses extend past 140 MHz, so the generator can be used in conjunction with a field-strength meter or spectrum analyzer for loss and isolation measurements in cable-television systems and components. To facilitate identifying individual harmonics, it is advantageous to replace the 30-picofarad capacitor with a 7-45-pF ceramic trimmer and adjust the frequency to 2.5 MHz. This adjustability also permits use of the unit as a low-precision comb marker generator. □

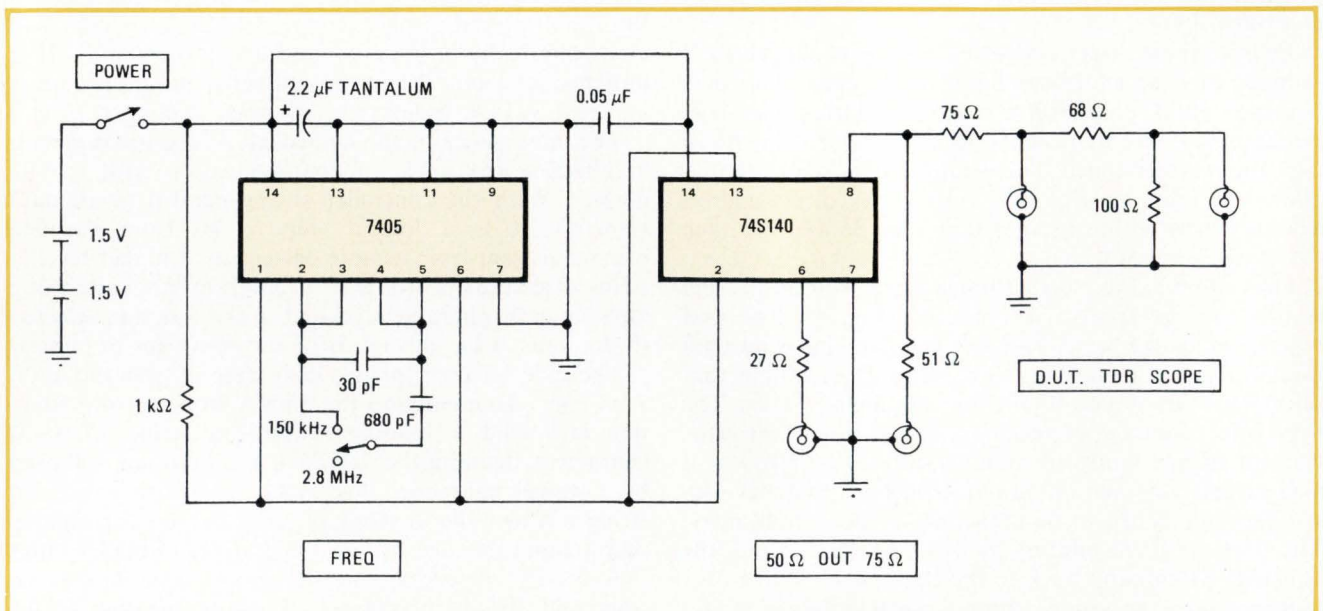

**1. Field man's friend.** Compact nanosecond-pulse generator powered by two dry cells delivers 0.8-volt pulses to either 50-ohm or 75-ohm output jacks; three batteries give 2 V, at some cost in rise time. Connections provide for use in time-domain reflectometry.



# Comparators and resistors form clockless a-d converter

by Adrian H. Kitai  
Hamilton, Ont., Canada

A successive-approximation analog-to-digital converter can be built out of comparators and resistors only. Conversion speed is determined by the settling time of the comparators, and no clock is needed.

The concept is illustrated in Fig. 1, which shows the  $n^{\text{th}}$  stage of a converter. The analog input voltage is compared with a voltage, the value of which is determined by the outputs of all previous stages, as well as by  $V_{\text{ref}}$ . A resistor is connected to weight each of the previous comparator outputs, and an additional resistor is connected to  $V_{\text{ref}}$ , which must be midway between the HI and LO levels of the comparator's output voltage. The  $n^{\text{th}}$  comparator needs  $n$  resistors, except for the first stage which needs none.

Since, however, the open-collector outputs of the comparators do not deliver voltages of sufficient precision, they are in practice followed by inverters that clamp the voltages. To compensate for this inversion of the comparator output, the input connections to the comparators are the reverse of those shown in Fig. 1; i.e., the analog input signal is connected to the inverting inputs instead of to the noninverting inputs.

Figure 2 shows a practical 4-bit circuit that uses only two inexpensive integrated circuits. This circuit is useful for applications such as driving a display of 16 light-emitting diodes. Comparator  $C_1$  has its positive input tied to  $V_{\text{ref}}$ . When an analog input lying between ground and  $2V_{\text{ref}}$  (near +4 volts) is applied to the negative

input, the output of inverter  $I_1$  is the first bit. This output is used to establish the switching level for  $C_2$ , which is either  $\frac{1}{2} V_{\text{ref}}$  or  $\frac{3}{2} V_{\text{ref}}$  depending on whether  $I_1$ 's output is LO or HI. In the same way, the remaining comparators provide bits 3 and 4.

To understand the circuit's operation, assume, for simplicity, that the LO and HI output levels of the transistor-transistor-logic inverters are 0 V and +4 V respectively. Then each of the 16 quantized intervals is 0.25 V wide. Also  $V_{\text{ref}}$  is set at +2 V. If, for example, 3.4 V (a value within interval 13) is applied to the analog

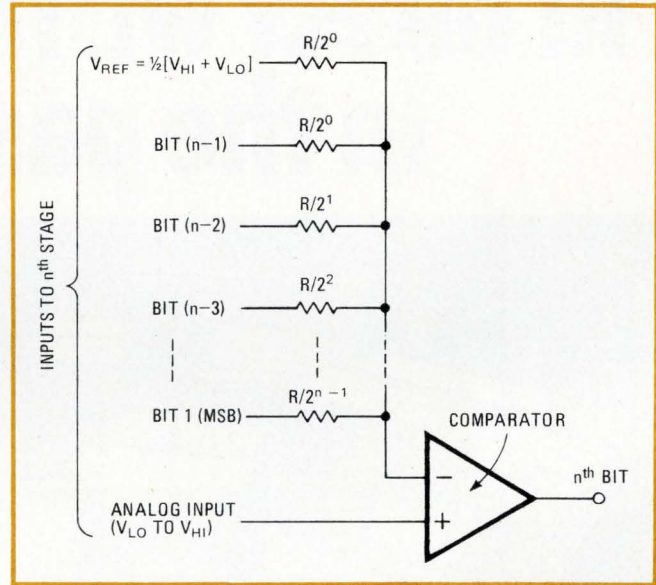

**1.  $N^{\text{th}}$  stage.** In  $n^{\text{th}}$  stage of successive-approximation a-d converter, an analog input voltage that lies between  $V_{\text{LO}}$  and  $V_{\text{HI}}$  is compared with a voltage determined by an average of the reference voltage and weighted values of the more significant bits. Reference voltage  $V_{\text{ref}}$  is fixed at the midpoint of the analog input range.

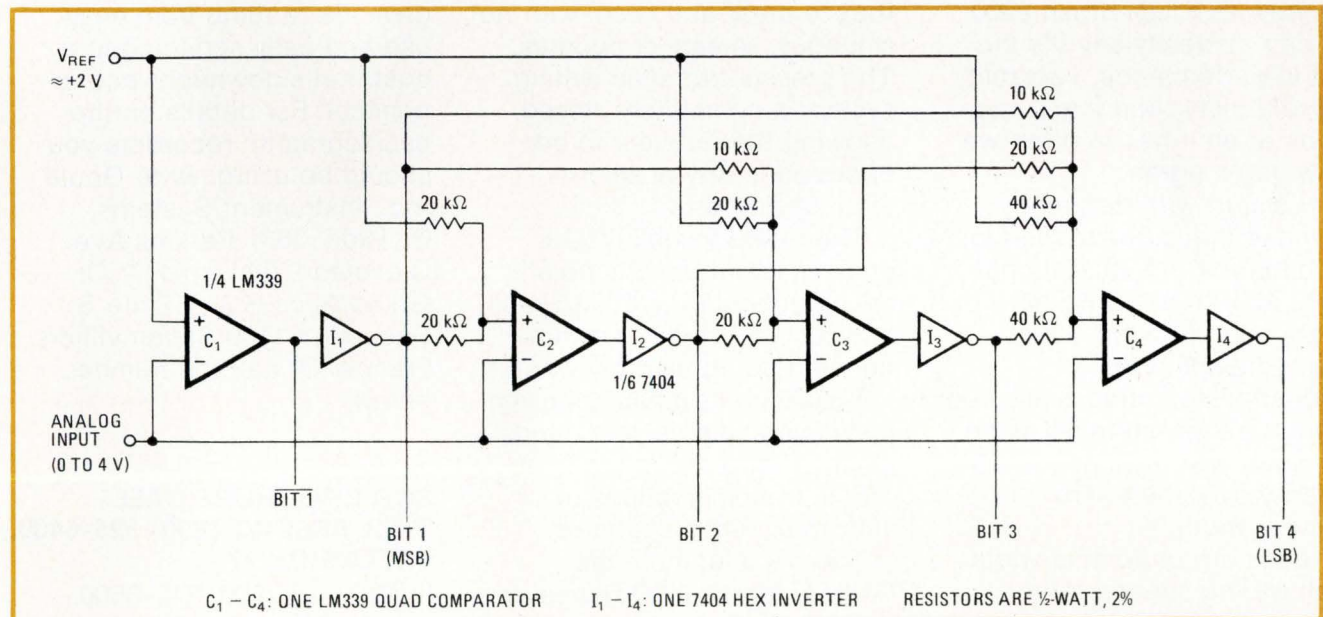

**2. No clock.** Comparator  $C_1$  compares the analog input voltage with  $V_{\text{ref}}$ . This defines bit 1 and is averaged with  $V_{\text{ref}}$  to set the switching level for  $C_2$ . Bit 2 is averaged with both  $V_{\text{ref}}$  and a weighted value of bit 1, to set the switching level for  $C_3$ . Bit 4 is obtained similarly. Each output can drive one TTL load. LM339 comparators can sense input voltages down to ground potential, so only a +5-volt supply is needed.



# The GOULD/Brush 2000 Series.

## The most significant advance in direct writing recorders in the past decade.

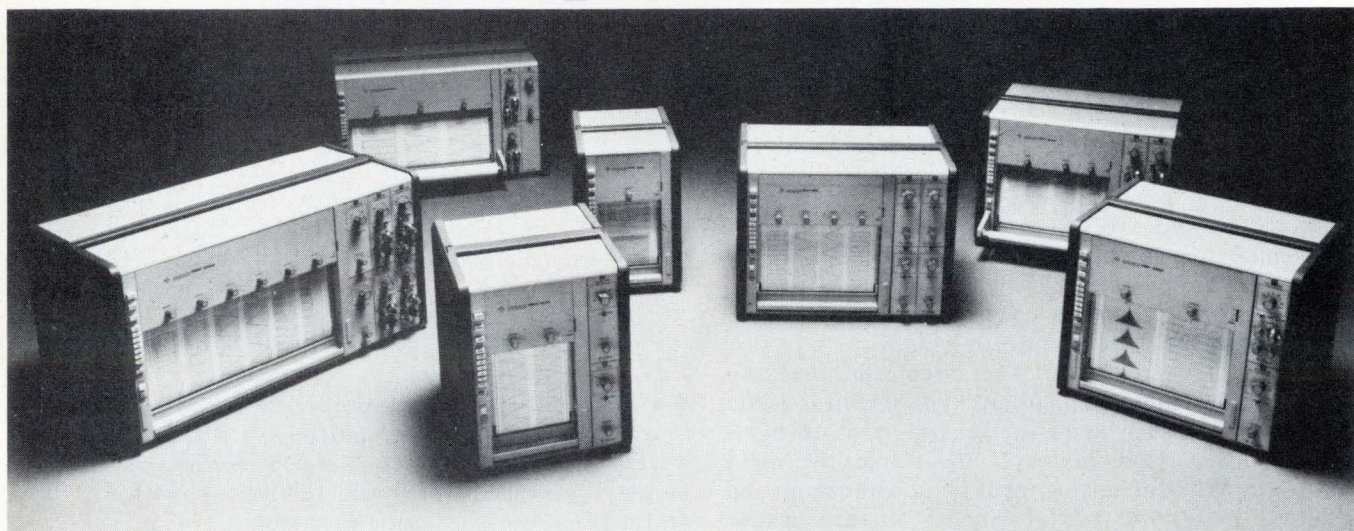

The new GOULD/Brush 2000. We can modestly say it's the best in performance, versatility and reliability. And if you take a look at all it has to offer, we know you'll agree.

Let's start with frequency response that's unexcelled in performance. An exceptional 30 Hz at 100mm, 50 Hz at 50mm, and up to 125 Hz at reduced amplitude.

Superior resolution is assured through a high-stiffness servo penmotor that enforces 99.65% linearity over the entire channel width.

Traces are uniform in width at all writing speeds. And

they're clear and crisp, with no smudges, smears or puddles. The pressurized fluid writing system is completely closed, allowing the recorder to be operated in any position—even upside down.

Then take flexibility. Our plug-in signal conditioners fit every model in the 2000 Series, and record virtually any function you could possibly want.

Thanks to its modular design, it's as versatile as your needs. Channel choices range from 1 to 8. In combinations of 100mm or 50mm channels.

There's a lot more the GOULD/Brush 2000 Series can

give you ranging from easy use and easy servicing to a cost that's downright economical. For details on the oscillographic recorders you should be using, write Gould Inc., Instrument Systems Division, 3631 Perkins Ave., Cleveland, Ohio 44114. Or Gould Allco S.A., 57 rue St. Sauveur, 91160 Ballainvilliers, France. Or call the number below.

**FOR BROCHURE CALL  
TOLL FREE AT (800) 325-6400.  
EXTENSION 77.**

In Missouri: (800) 342-6600.

Wescon/76 Booth 556

 **GOULD**  
The product development company







# On-chip heater helps to stabilize monolithic reference zener

Buried-diode structure minimizes avalanche noise and provides long-term stability

by Robert C. Dobkin,

National Semiconductor Corp., Santa Clara, Calif.

□ Zener diodes can often frustrate the engineer who must design a voltage reference for a power supply, an instrument, or a data converter. When the equipment must operate in an unstable environment, conventional reference diodes require extensive compensation measures. Also, in any kind of environment, they need a well-regulated bias current. But a new monolithic circuit, the LM199, can operate over a wide range of currents without special environmental controls. What's more, it costs only about one fourth as much as existing high-quality zeners.

The key to the IC's superior showing is two electrically independent circuits—one is the zener itself, and the other is a temperature-stabilizer network. This network serves as an integral heater, keeping the entire chip at a constant temperature. And the zener device is a buried structure so that avalanche breakdown takes place in the bulk silicon, instead of at the surface, as it does for most zeners. This subsurface breakdown reduces noise and improves long-term stability.

## IC zener vs discretes

Because conventional reference zeners have a finite dynamic impedance ranging from 10 to 100 ohms, any variation in their bias current causes their output voltage to change (see "Reviewing zener imperfections," p. 107). The temperature coefficient of zener voltage usually ranges from 5 to 100 parts per million per degree celsius, and it also varies with the zener current.

As a result, temperature stabilities of 1 ppm/°C are difficult to achieve, even if the zener is a reference type that includes an on-chip drift-balancing junction diode for temperature compensation. To provide this degree of accuracy, ordinary reference zeners require bias currents that are regulated to within tens of nanoamperes, and sometimes they must even be operated within a thermostatically controlled environment or a constant-temperature bath.

However, the LM199 provides 1-ppm/°C performance over a broad range of temperatures without any special thermal regulation. Also, its dynamic impedance is only approximately 0.5 ohm, and it can operate over a span of 0.5 to 10 milliamperes without affecting temperature coefficient or zener voltage, which is about 6.9 v.

The unit's low dynamic impedance and wide-range operating current mean that the biasing circuitry for the LM199 can be very simple. As a matter of fact, since its temperature coefficient is independent of its operating current, the LM199 usually requires only a single external bias resistor.

Although ordinary zener diodes can be used to develop a stable reference voltage, their output can change by many millivolts when there is a temperature gradient across the package. A temperature difference of only 1°C may cause a 2-mv shift in the reference voltage. In contrast, the LM199 is free of voltage shifts caused by temperature gradients because its on-chip temperature stabilizer maintains a constant die temperature.

Besides eliminating drift, the temperature stabilizer allows the device to warm up in much less time than conventional diodes need. Furthermore, the LM199 is insensitive to mechanical stress on its leads—another

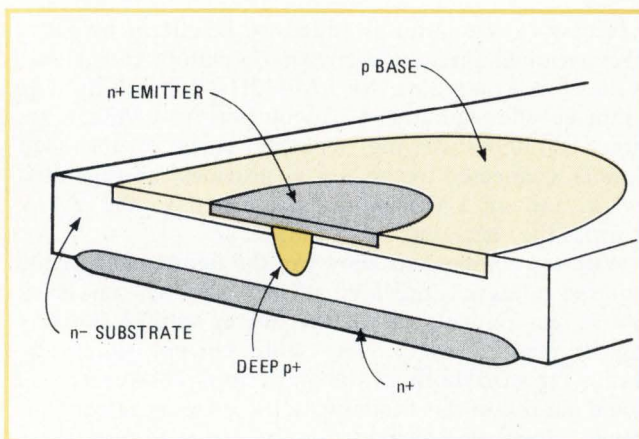

**1. Buried zener.** Subsurface breakdown of new IC zener, the LM199, is less noisy and more stable than surface breakdown of ordinary zeners. Avalanching occurs in the bulk silicon, between subsurface p+ diffusion and n+ emitter, not p-base and n+ surface regions.



## Reviewing zener imperfections

Like any other component, the zener diode is not an ideal device. Its output voltage varies with changes in bias current, load impedance, and temperature.

As shown in (a), the zener's transfer characteristic is somewhat less than perfect, exhibiting a finite slope in the reverse-bias breakdown region where the zener is operated. This finite slope means that the device's dynamic impedance is not zero, as it would be if the slope were infinite.

This very real intrinsic impedance affects zener voltage in two ways. When the reverse bias current through the diode changes, so does the zener voltage. Also, the zener cannot function as a perfect voltage source—that is, the zener's voltage output depends on the impedance of the load the diode is driving. The intrinsic zener impedance and the load impedance form a voltage divider that attenuates the zener's output.

The zener has yet another major imperfection. The voltage at which the zener avalanches is sensitive to temperature. And since current flow causes a semiconductor junction to heat up, zener voltage drifts as the device warms up. Also, the temperature coefficient of zener voltage depends on the reverse current through the diode.

Because of these inherent drawbacks, only a special class of zeners can be used as reference-voltage sources. Popularly called reference diodes, these devices are actually a zener diode and a junction diode, connected as shown in (b). With this arrangement, the junction diode provides temperature compensation for the zener diode because the temperature drifts of the two devices are equal, but in opposite directions. The reverse-biased zener

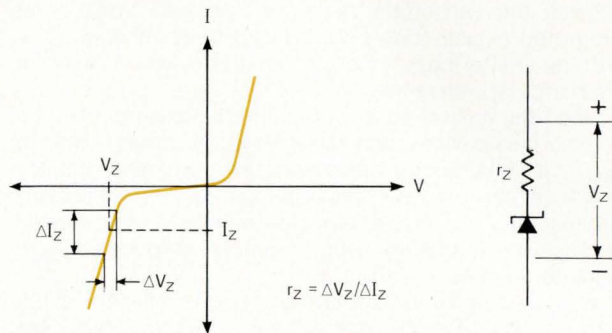

(a) ZENER CHARACTERISTIC



(b) CONVENTIONAL REFERENCE DIODE

has a positive temperature coefficient, while the forward-biased junction diode has a negative one.

On the whole, zener diodes provide a simple means of obtaining a regulated voltage inexpensively. They are available in ratings from about 2 volts to around 600 v, with varying degrees of regulation. With appropriate biasing, conventional reference diodes can provide temperature coefficients as good as 0.0005%/°C.

source of error with ordinary glass diodes. Additionally, the new zener exhibits virtually no hysteresis in reference voltage when cycled over a wide temperature range. Temperature-cycling the device between 25°C and 150°C causes less than a 50-microvolt change in reference voltage. Under the same conditions, regular reference diodes may exhibit shifts of 1 to 5 mv.

### Surface vs subsurface

In conventional reference diodes (see "Differentiating between IC references," p. 108), the emitter-base junction of an npn transistor serves as the zener diode. Unfortunately, this junction avalanches at the surface of the silicon, producing a breakdown that is noisy and cannot provide a long-term stability much better than about 0.3%. What's more, a surface zener is especially sensitive to contamination in the oxide or charge on the surface of the oxide, which can cause short-term instability or turn-on drift.

In contrast, in the LM199, avalanche breakdown occurs below the surface of the silicon in the bulk region so that the zener voltage is stable with time, and breakdown noise is kept very low. This subsurface, or buried, zener can be fabricated with well-controlled diffusions in a planar structure, making it extremely reproducible—to within an initial tolerance of 2% for breakdown voltage.

Figure 1 shows the structure of the subsurface zener. The initial diffusion creates a small, but deep, p<sup>+</sup> region in the bulk portion of the silicon. A standard p-type base follows the p<sup>+</sup> diffusion, which is then completely covered by an n<sup>+</sup> emitter. Such a device structure breaks down where the dopant concentration is greatest—between the p<sup>+</sup> and n<sup>+</sup> regions. Since the p<sup>+</sup> area is entirely blanketed by the n<sup>+</sup> diffusion, the breakdown, which occurs at approximately 6.3 v, is below the surface of the silicon substrate.

One connection for the diode is to the n<sup>+</sup> region, and the other is to the p-base diffusion. Current flows laterally through the base to the p<sup>+</sup> diffusion or cathode of the zener. Surface breakdown does not occur because the breakdown voltage between the p base and n<sup>+</sup> emitter is greater than the breakdown voltage of the buried device.

The LM199's two electrically independent circuits—a temperature stabilizer and a floating active zener—are shown in the simplified schematic of Fig. 2a. The only electrical connection between these two circuits is the isolation diode that is inherent in any junction-isolated IC. The zener portion of the chip may be used either with or without the temperature stabilizer power up. There are only two operating restrictions for the device: the inherent isolation diode must never become forward-biased, and the zener must not be biased above the 40-v



## Differentiating between IC references

Besides the subsurface zener, a reference voltage for integrated circuits may be produced three other ways—with the emitter-base zener, the emitter-isolation zener, or the band-gap reference.

Since the emitter-base and emitter-isolation diodes are both surface devices, they suffer from the same shortcomings—too much noise and inadequate long-term stability to serve as precision voltage references. However, because they are easy to fabricate with good reproducibility, they are frequently used in general-purpose voltage-regulator circuits.

In each device, a standard  $n^+$  emitter diffusion is the cathode. But, for the emitter-base zener (a), the base diffusion is the anode, while the isolation diffusion is the anode for the emitter-isolation zener (b). Breakdown voltage is approximately 6.7 V for the emitter-base diode and about 5.6 V for the emitter-isolation diode. The temperature coefficients are about 2 millivolts/°C and 1 mV/°C, respectively.

In the band-gap reference (c), transistors and resistors produce a reference voltage that is proportional to the energy-band gap of silicon, giving an effective reference of 1.205 V. Although the band-gap reference has low noise and good stability over time compared to surface references, it requires considerable die area, and temperature coefficients of less than 20 parts per million per degree celsius are difficult to achieve.

A pair of matched transistors,  $Q_1$  and  $Q_2$ , operate at different current densities, creating a difference between their emitter-base voltages. This difference voltage, which has a positive temperature coefficient, is added to the emitter-base voltage of transistor  $Q_3$ , which has a negative temperature coefficient, thereby producing a reference voltage with zero temperature coefficient.

Transistors  $Q_1$  and  $Q_2$  operate at a 10:1 difference in current, generating a difference voltage of 60 mV across resistor  $R_1$ . The current through  $R_1$  also flows in resistor  $R_2$ , producing a 0.6-V drop having a positive temperature coefficient. The voltage across  $R_2$  is summed with the emitter-base voltage of  $Q_3$ , creating a 1.2-V reference voltage.

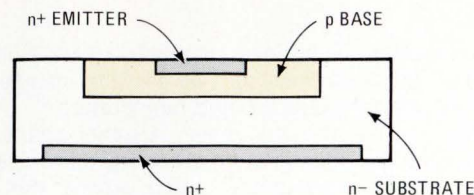

(a) EMITTER-BASE ZENER

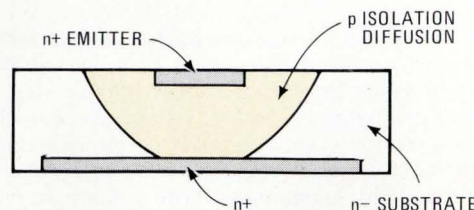

(b) EMITTER-ISOLATION ZENER

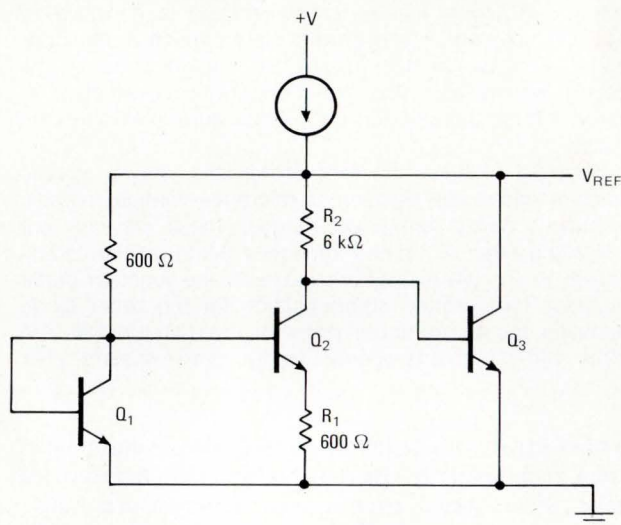

(c) BAND-GAP REFERENCE

reverse breakdown of the isolation diode.

The temperature stabilizer (Fig. 2b) acts as a heater, maintaining the temperature of the die at a constant 90°C. This circuit is composed of nine transistors, two zener diodes, and a resistor divider.

### How the heater works

The right-hand portion of the circuit is designed to assure startup. When power is applied, field-effect transistor  $Q_1$  provides current to zener  $D_1$  and transistor  $Q_2$ . Current through  $Q_2$  turns the loop formed by diode  $D_2$ , resistors  $R_1$  and  $R_2$ , and transistors  $Q_3$ ,  $Q_4$  and  $Q_5$ . About 5 V is applied to the top of  $R_1$  from the base of  $Q_5$ , causing 400 microamperes to flow through  $R_1$  and  $R_2$ . Since  $Q_5$  has a controlled gain of 0.3, its total emitter current is about 500  $\mu\text{A}$ . This current flows through the emitter of  $Q_4$  and drives another controlled-gain pnp transistor,  $Q_3$ . The gain of  $Q_3$  is about 0.4, so zener  $D_2$  is driven with about 200  $\mu\text{A}$ . Once current flows through transistor  $Q_3$ , transistor  $Q_2$  becomes reverse-biased, and

the loop through the circuit is then self-sustaining.

The resistor divider applies 400 mV to the base of transistor  $Q_6$ , while  $Q_5$  supplies 120  $\mu\text{A}$  to this device's collector. At temperatures below the 90°C stabilization point, the 400-mV voltage is insufficient to cause  $Q_6$  to conduct. As a result, all the collector current from  $Q_5$  serves as the base drive for the Darlington transistor pair formed by  $Q_7$  and  $Q_8$ . Connected across the supply, the Darlington initially draws 140 mA, which is set by the current-limiting transistor,  $Q_9$ .

As the chip heats up, the turn-on voltage for  $Q_6$  decreases, permitting it to conduct. At about 90°C, the current through  $Q_6$  increases appreciably, and less drive is applied to  $Q_7$  and  $Q_8$ . Power dissipation for the Darlington decreases to the level necessary to hold the chip at the stabilization temperature. In fact, chip temperature changes less than 2°C for a 100°C swing.

The operation of the zener section (Fig. 2c) of the chip is relatively straightforward. The buried zener,  $D_1$ , breaks down, biasing the base of transistor  $Q_1$ , which



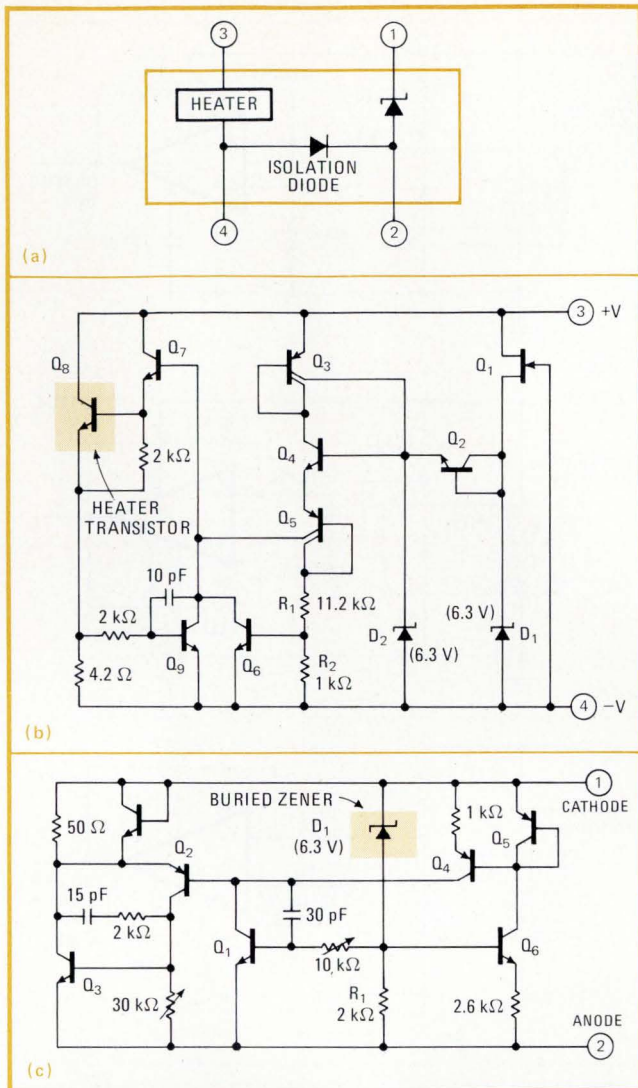

**2. On the chip.** Actually a linear IC, the LM199 (a) is made up of a zener circuit and a heater network, electrically connected by an isolation diode. The heater (b) acts as a temperature stabilizer for the zener (c), maintaining entire die at constant temperature.

drives two buffer transistors,  $Q_2$  and  $Q_3$ . All externally caused current changes through the circuit are fully absorbed by these buffer transistors, rather than the buried zener. The current through  $D_1$  is held constant at  $250 \mu\text{A}$  by resistor  $R_1$  across the emitter-base junction of  $Q_1$ , while  $Q_1$ 's emitter-base voltage nominally temperature-compensates  $D_1$ 's reference voltage. Transistors  $Q_4$ ,  $Q_5$ , and  $Q_6$  simply set the operating current of  $Q_1$ , and the two junction capacitors provide frequency compensation.

### Parameters measure up

A polysulfone thermal shield is supplied with the LM199 to minimize power dissipation and improve temperature regulation. Its thermal shield, as well as its small high-thermal-resistance TO-46 package, allows the device to operate at low power levels without the problems normally associated with special IC packages that have built-in thermal isolation. For temperature stabilization, the unit requires only 300 milliwatts at

### IC-ZENER SPECIFICATION SUMMARY

Parameter	Typical value
Reverse breakdown voltage	6.95 V
Operating current	0.5 – 10 mA
Temperature coefficient	0.3 ppm/ $^{\circ}\text{C}$
Dynamic impedance	0.5 $\Omega$
Rms noise (10 Hz – 10 kHz)	7 $\mu\text{V}$
Long-term stability	$\leq 20$ ppm
Temperature-stabilizer operating voltage	9 – 40 V
Temperature-stabilizer power dissipation (25 $^{\circ}\text{C}$ )	300 mW
Warm-up time (25 $^{\circ}\text{C}$ )	3 seconds

25 $^{\circ}\text{C}$  or 660 mW at a temperature of  $-55^{\circ}\text{C}$ .

Because the LM199 is a temperature-stabilized device, voltage drift with changing temperature is essentially eliminated. In fact, temperature drift is typically only 0.3 ppm/ $^{\circ}\text{C}$ , as noted in the table. Stabilizing the temperature at 90 $^{\circ}\text{C}$ , rather than 125 $^{\circ}\text{C}$ , significantly reduces power dissipation, yet provides low drift over a major portion of the operating temperature range. Above 90 $^{\circ}\text{C}$  ambient, the unit's temperature coefficient is only 15 ppm/ $^{\circ}\text{C}$ .

A low-drift reference is virtually useless if it does not offer equivalent noise performance and long-term stability. With the buried zener, both wideband and low-frequency noise are exceptionally low. Over a frequency range of 10 hertz to 10 kilohertz, noise voltage is merely 7  $\mu\text{V}$  root mean square. Similarly, for a 10-minute period, peak-to-peak noise over a 0.01-to-1-Hz bandwidth is only about 1.5  $\mu\text{V}$ .

Long-term stability is usually one of the most difficult zener parameters to determine. To measure this parameter, conventional reference diodes are usually submerged in a bath that is temperature-controlled to within  $\pm 0.05^{\circ}\text{C}$ , and their nominal 7.5-mA operating current must be regulated to within  $\pm 0.05 \mu\text{A}$ . Additionally, connections to the package leads must be free from mechanical stress, and the test must not be interrupted during the measurement interval.

In contrast, the long-term stability of the LM199 can be measured in still air at a temperature of 25 $^{\circ}\text{C}$  to 28 $^{\circ}\text{C}$  and at a zener current of 1 mA  $\pm 0.5\%$ . These conditions are more typical of actual operating situations in instruments. Even after 1,000 hours, the reference voltage of the LM199 shifts by as little as 5 to 20 ppm. What's more, because the device's planar structure does not exhibit hysteresis with temperature cycling, long-term stability is in no way impaired if the unit is switched on and off.

The temperature stabilizer heats the small thermal mass of the LM199 to 90 $^{\circ}\text{C}$  very quickly. At 25 $^{\circ}\text{C}$ , warm-up time is around 3 seconds, and about 10 s when starting from  $-55^{\circ}\text{C}$ . This short warmup period is significantly faster than the several minutes needed by ordinary diodes to reach equilibrium.

Although the LM199 is easier to use than conventional zeners, its temperature stability is so good—even



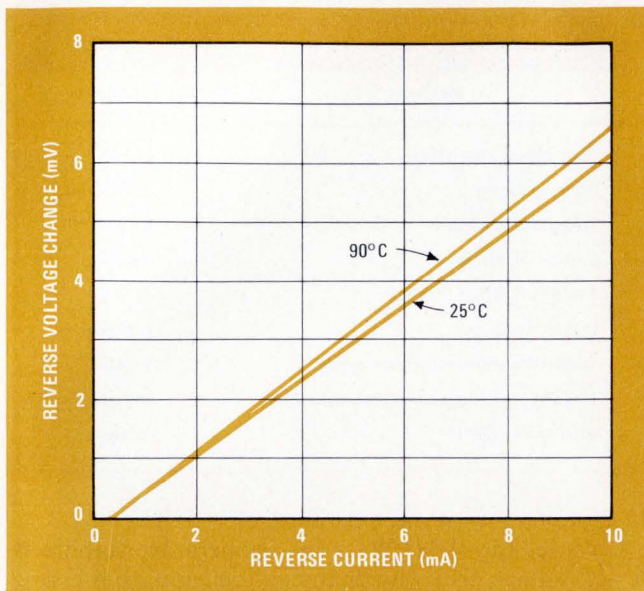

**3. Wide current range.** Reference voltage of the LM199 IC zener is nominally about 6.9 V. Incredibly, this voltage changes by merely 6 to 7 mV, even if operating current varies from 0.5 to 10 mA. Because of this current range, the device can replace most other zeners.

superior to precision resistors—that external circuitry must be prevented from limiting its performance. However, in essence, operation only requires energizing the temperature stabilizer from a power supply of 9 to 40 V and biasing the zener at 0.5 to 10 mA.

### Biasing the device

The only substantial operating restriction concerns the bias applied to LM199's isolation diode. Since this isolation diode must not be forward-biased, the voltage at either terminal of the zener must be equal to or greater than the negative supply voltage applied to the temperature stabilizer. As a result, a dc return is needed between the zener and the heater circuitry to ensure that the voltage of the isolation diode is not exceeded.

The active circuitry in the reference section of the LM199 reduces the dynamic impedance of the buried zener to about 0.5 ohm, making the device especially easy to bias, since current regulation becomes far less critical than it is for other zeners. For example, a conventional reference diode, such as the type 1N829, operates at 7.5 mA and has a dynamic impedance of 15 ohms. With this device, a 1% change in current—a mere 75  $\mu$ A—changes the reference voltage by 1.1 mV. In contrast, the LM199 can operate over a range of currents with no change in its dynamic impedance, so that a 1% variation in, say, a 1-mA current causes the reference voltage to change by only 5  $\mu$ V. Figure 3 shows how little the LM199's zener voltage shifts over its full range of bias current.

Because of its wide operating-current range, the LM199 can directly replace most other zeners without any circuit modifications, except for the temperature-stabilizer connections. Additionally, since its dynamic impedance remains constant, despite variations in operating current, the LM199 provides voltage regulation that is 10 to 100 times better than other reference

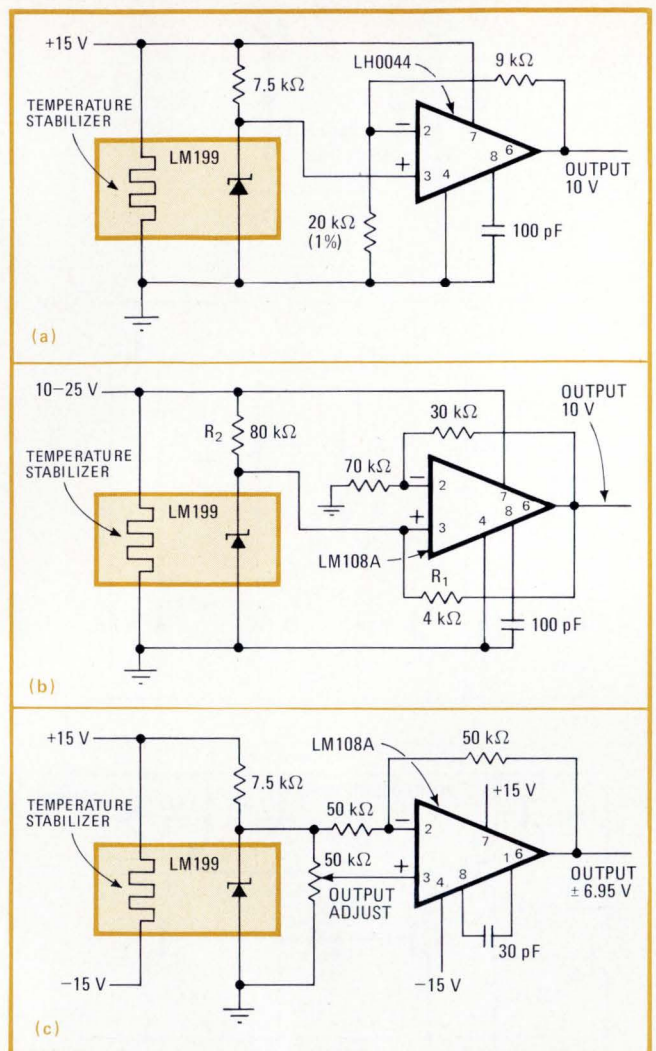

**4. Easy to use.** Because it can operate over a wide current range, the LM199 is simple to bias. Here, the device serves as the source voltage for a buffered 10-V reference (a), a wide-input-range reference (b), and an adjustable dual-output reference (c).

zeners. For optimum regulation, however, lower operating currents are preferable, since the ratio of source resistance to zener impedance is higher for low currents, and the attenuation of input changes is greater. Furthermore, at low currents, the voltage drop in the wiring is minimized.

### Mounting and layout considerations

Thermal considerations are also important for optimum performance. Although its thermal shield minimizes heat losses from normal convection currents, the LM199 should not be exposed to a direct air flow like that from a cooling fan. Such an air flow can cause as much as a 100% increase in power dissipation, degrading thermal regulation and increasing drift.

Even the layout of the printed-circuit board bearing the zener should be taken into account. Specifically, four-wire Kelvin connections should be made to the LM199 to eliminate adverse ohmic effects in pc-board conductors. Although the voltage drops caused by conductor resistances are small, the temperature coeffi-



cient of the voltage developed along a copper conductor can add significantly to zener drift. For instance, a conductor having a 1-ohm resistance with 2 mA of current floating through it produces a 2-mV drop. Since the temperature coefficient of copper is 0.004%/°C, this 2-mV drop will change by 8  $\mu\text{V}/^\circ\text{C}$ , creating an additional drift error of 1 ppm/°C for the zener.

Furthermore, the current for the temperature-stabilizer circuitry should not be allowed to flow through the conductors carrying the reference voltage or its ground return. Over a temperature range of  $-55^\circ\text{C}$  to  $+125^\circ\text{C}$ , the heater current will vary from about 1 mA to more than 40 mA. Such large currents flowing through reference leads or through the reference ground can cause errors much greater than the drift of the LM199.

Other errors can be caused by thermocouple effects. The Kovar leads from the LM199's package form a thermocouple with the copper pc-board conductors. Since the package of the LM199 is heated, there is a flow of heat along the package leads. If the leads terminate into unequal sizes of copper on the pc board, more heat will be absorbed by the larger conductors, and a temperature difference will develop. A temperature difference of only 1°C between the two leads of the reference diode generates a voltage of about 30  $\mu\text{V}$ . When the copper conductors to the zener are equal in size, errors caused by thermocouple effects are usually held to less than about 15  $\mu\text{V}$ .

The LM199 should be mounted flush on a pc board, with a minimum of space between its thermal shield and the board. This minimizes the air flow across the Kovar package leads at the board surface—a condition that can

also cause unwanted thermocouple voltages. Air currents across the leads usually appear as ultra-low-frequency noise having an amplitude of about 10 to 20  $\mu\text{V}$  pk-pk.

### Applying the zener

To obtain a calibrated voltage source, the output of any reference zener must be scaled and buffered. Figure 4a shows how to connect the LM199 to realize a simple buffered reference having a 10-v output for applications like digital-to-analog data conversion.

In this circuit, the cathode of the zener is wired to the noninverting terminal of a low-drift operational amplifier. A single 15-v supply powers both the LM199's temperature stabilizer and the op amp. For this supply, a regulation of about 1% is adequate, contributing less than 10  $\mu\text{V}$  of error to the circuit's output. Feedback resistors around the op amp scale the output to 10 v. (An RC network can be inserted in series with the op-amp input to roll off high-frequency noise.)

Although the absolute values of the resistors are not extremely important, the tracking of their temperature coefficients is vital. The nominal 1-ppm/°C drift of the LM199 is easily exceeded by the temperature coefficient of most resistors, and tracking to better than 1 ppm is not easy to obtain.

Wirewound resistors can be matched fairly well, if they have a low temperature coefficient of resistance and exhibit low thermoelectric effects. Metal-film types are also good. Most potentiometers do not track fixed resistors, so it's advisable to minimize the voltage-adjustment range, thereby limiting the effect of potentiometer tracking on the temperature coefficient of the output

## Outlook is bright for buried zeners

Because of their excellent long-term stability, buried zeners are making a strong challenge for the jobs traditionally done by conventional references. In addition to replacing discrete reference diodes, buried zeners will be improving the performance of integrated-circuit voltage regulators, hybrid and monolithic data converters, and perhaps even operational amplifiers.

Now, National Semiconductor Corp. has the most visible effort in buried zeners. The company already uses them in its temperature transducers and hybrid data converters, besides offering buried-zener references, with or without an integral temperature stabilizer. What's more, some of its IC voltage regulators will soon be retrofitted with buried zeners, and future operational amplifiers may include them to stabilize internal operating currents.

Another major semiconductor house, Motorola Semiconductor Products, Phoenix, Ariz., is also exerting considerable effort to prepare buried zeners for market. Unlike National, which uses a double-base diffusion, Motorola fabricates its subsurface zeners by means of ion implantation. This technique, says Jack Saltich, manager of new-process development for linear ICs, permits a wide range of zener voltages to be obtained. The dopant concentration can be varied easily, yet it can be closely controlled, he points out.

The company has successfully built 5-volt zeners for logic-level translators and 6.5-V devices for some of its voltage regulators. In the near future, Motorola is likely to offer a line of buried-zener references to complement its

family of digital-to-analog converters. "We have developed our process, and now we're gaining expertise with the device," says Saltich. With the right value of zener voltage, avalanching and tunneling effects can be balanced out to yield zero temperature coefficients, he notes.

Another manufacturer, the Semiconductor division of Analog Devices Inc., Wilmington, Mass., next month will announce a 10-bit d-a converter that includes a buried-zener reference. The company also plans to include subsurface zeners in a number of future products, including both low- and high-accuracy data converters, as well as such computational circuits as multipliers. Just a few months ago, the firm retrofitted a line of its monolithic four-quadrant analog multipliers/dividers with buried reference zeners.

In its process, Analog Devices fabricates subsurface zeners with a series-connected temperature-compensating element, which consists of a junction diode and a resistor network. This arrangement, explains David Kress, product-marketing specialist, permits the contribution of the junction diode to be controlled by laser-trimming the resistor network. "First we determine the temperature coefficient of the zener, and then we see what we need [to compensate for it]," says Kress.

Judging from the current activity, buried zeners should be a firmly established part of linear-IC processing within the coming year.

**Lucinda Mattera, Components Editor**



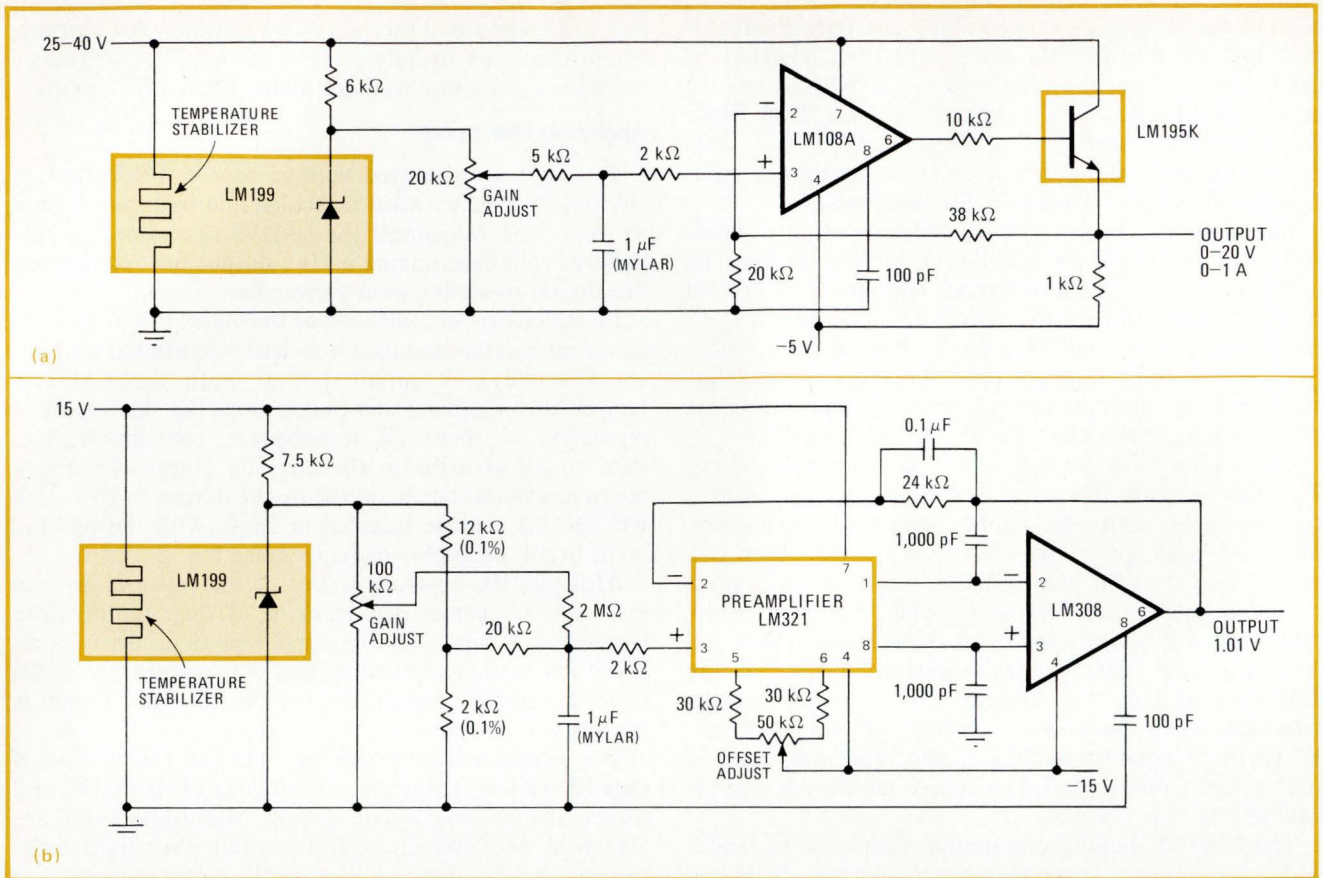

**5. Other applications.** Precision power supply (a) built with the LM199 delivers up to 20 V at 1 A. The output device for this circuit is an IC power transistor that includes its own overload protection. As wired in (b), the LM199 can replace a standard cell.

voltage. For this circuit, the worst-case overall temperature coefficient is 3 ppm/°C—about 1 ppm is attributable to the reference zener, 1 ppm to the resistors, and 1 ppm to the op amp.

To operate over a wider input-voltage range, as is generally needed when the supply voltage is only regulated within  $\pm 10\%$  or so, the LM199 can be powered from the output of an op-amp buffer, as shown in Fig. 4b. The op amp supplies a regulated voltage to the resistor ( $R_1$ ) that biases the reference zener, thus minimizing changes in the output caused by variations in the input. However, since variations in the temperature-stabilizer voltage produce some changes in the output, the best possible precision cannot be obtained with extremely wide-range operation. An additional resistor ( $R_2$ ) at the input assures that the circuit starts up properly when power is first applied.

A continuously variable reference source that can provide either a positive or negative output for applications requiring a precision bipolar supply is illustrated in Fig. 4c. The reference zener is biased directly from an unregulated  $\pm 15$ -v supply. The potentiometer permits the output voltage to be varied continuously between  $+V_Z$  and  $-V_Z$ , where  $V_Z$  is the zener voltage. For negative outputs, the op amp operates as an inverter) for positive outputs, it is noninverting. The op amp selected for the circuit should be a low-drift device. The best choice for the potentiometer is a precision wirewound 10-turn type.

The LM199 is also useful for building a precision power supply (Fig. 5a) capable of delivering up to 20 v at 1 A for those applications where the power supply must also serve as the voltage reference, as in powering impedance bridges. The output of the op amp is buffered by an IC power-transistor amplifier, which operates as an npn power transistor but requires only 5  $\mu$ A of base current. Full overload protection is inherent, including current-limiting and safe-area protection, in addition to thermal-limiting.

Standard-cell replacement in instruments and voltage calibrators is another application for the LM199 zener. The circuit of Fig. 5b provide an output of 1.01 v, which is very close to the 1.018-v value of standard cells. Both the precision preamplifier and the precision op amp used here have guaranteed drift specifications, permitting op-amp drift to be held to less than 1  $\mu$ V/°C. Also, the potentiometer is connected to the preamplifier so as to minimize the effects of its temperature coefficient. To calibrate the circuit, the offset of the op amp is nulled, and then the output voltage is adjusted.

Although not a new concept, the subsurface zener looks like the wave of the future for zener technology because of the performance improvements it offers, as well as the small die area it requires. In fact, the buried zener will probably be the preferred voltage reference for upcoming IC designs for both data converters and voltage regulators. It's even likely to replace surface zeners in popular existing IC voltage regulators. □



# Design process for fiber-optic systems follows familiar rules

Analysis of the performance of a communications link is accomplished much as for its electrical-cable counterpart, but there are different transmission-format tradeoffs

by C.K. Kao and J.E. Goell,  
ITT Electro-Optical Products Division, Roanoke, Va.

□ Fiber-optic communications systems will include components unfamiliar to most communications-system designers, but their design is based on principles that differ little from their conventional counterparts. Link analysis is carried out in much the same way as for an electrical cable. The chief distinction results from the increased bandwidth possible with fiber-optic systems, which compels design engineers to make different trade-offs in determining the optimum transmission formats.

As with conventional systems, the designer must consider various combinations of fiber-optic components and modulation techniques to achieve the desired level of performance. Determining the best system configuration boils down to a process of juggling interrelated performance parameters with the various mixes of components and transmission techniques. Initially, the design can be based on theoretical predictions of performance, but the final version must reflect the actual performance of specified components.

## The design approach

The designer invariably begins by establishing the desired signal quality needed at the receiver, and from that determines the signal-to-noise ratio required. Then he selects possible modulation formats that meet the required system margin.

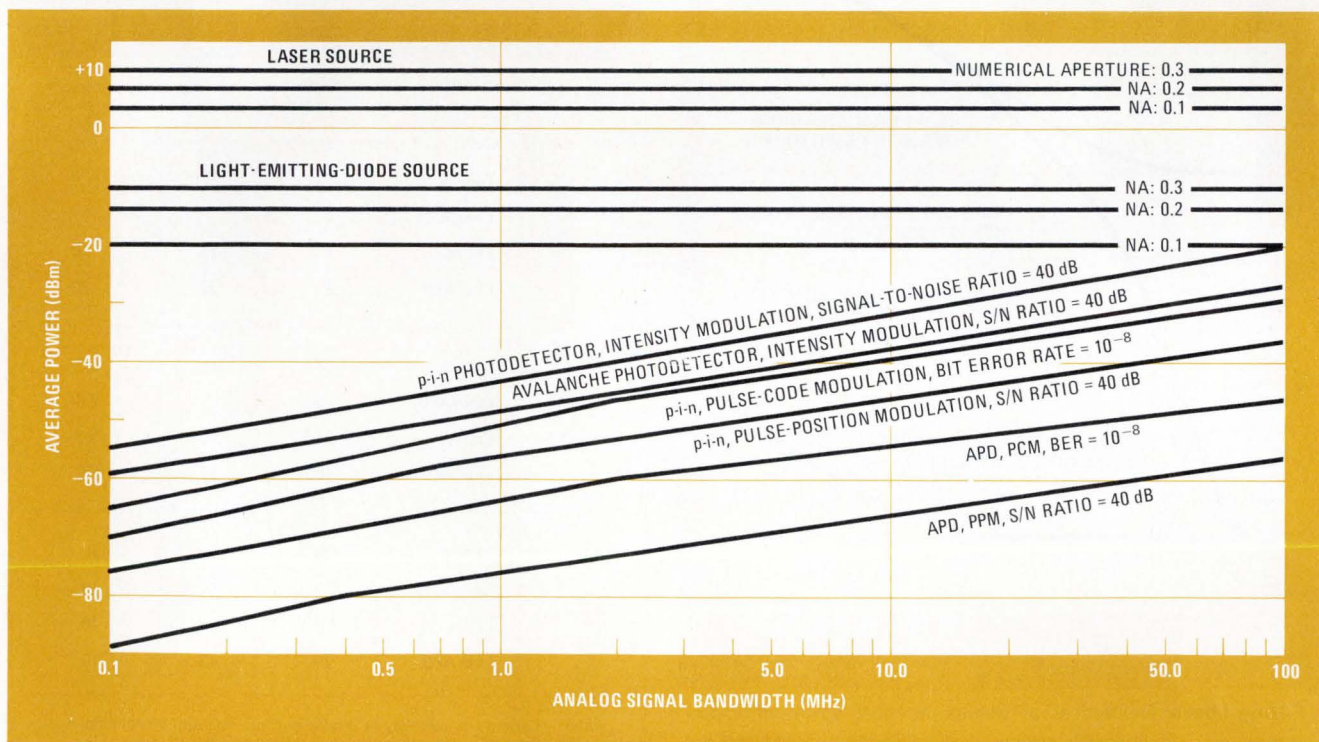

1. **Measuring margin.** Determining how much attenuation can exist between transmitter and receiver of a fiber-optic link without affecting signal quality depends on the source and photodetector selected and the modulation format used.



From this point, the designer must select from the myriad of component combinations. The most straightforward approach usually is to select an optical source and then determine the margin (allowable attenuation between transmitter and receiver) and allowable dispersion between transmitter and receiver for each selected modulation format. Then fiber types meeting the dispersion requirements can be selected and connector/fiber tradeoffs evaluated.

To determine the margin for each selected modulation format, the designer takes the difference in decibels of the signal power available at the transmitter and the signal power required at the receiver. Allowable fiber dispersion is approximately the square root of the difference between the square of the signal rise time required at the receiver and the square of the transmitter rise time.

Working through a specific example will illustrate the design sequence. A good choice is a fiber-optic link for a color-television signal, because almost all the important design considerations come into play in such a system.

A TV signal acceptable to most viewers should have a minimum signal-to-noise ratio of 40 decibels. The system parameters include: a signal bandwidth of 5 megahertz; a link length of 4 kilometers (0.5-km sections); a splicing loss of 0.2 dB per slice, and a coupling loss of 1 dB per pair.

Color TV signals can be transmitted in their analog form by intensity modulation or can be converted to

digital formats such as pulse-code and pulse-position modulation. These three formats as used with conventional cables can be negative or positive. To transmit negative signals over fiber-optic links, the signal is offset with a bias current equal to at least the peak negative level anticipated. This is the case with intensity modulation, which varies light output from the source in a linear relation to the modulating signal.

### The combinations

As with any system, the margin depends upon the modulation format selected and the combination of source and photodetector used to implement it. Injection lasers and light-emitting diodes are generally considered for the light source, while avalanche or p-i-n photodetectors can be used in the receivers.

It's possible to implement any of the three-modulation formats with either of the sources and either of the photodetectors. The quickest way to cut through the multitude of choices is to use the curves in Fig. 1. The top series of straight lines shows the available source power for state-of-the-art lasers and LEDs in dBm (decibels below a milliwatt) as a function of the numerical aperture of various optical-fiber cables. The numerical aperture of an optical fiber indicates the amount of light it can accept: the larger the number, the greater the amount of light accepted.

The lower family of curves shows the received power (also in dBm) necessary to achieve a 40-dB signal-to-noise ratio for intensity modulation or PPM or a  $10^{-8}$  bit error rate for PCM, as a function of the required TV signal bandwidth. These curves represent what is achievable with various combinations of photodetectors and

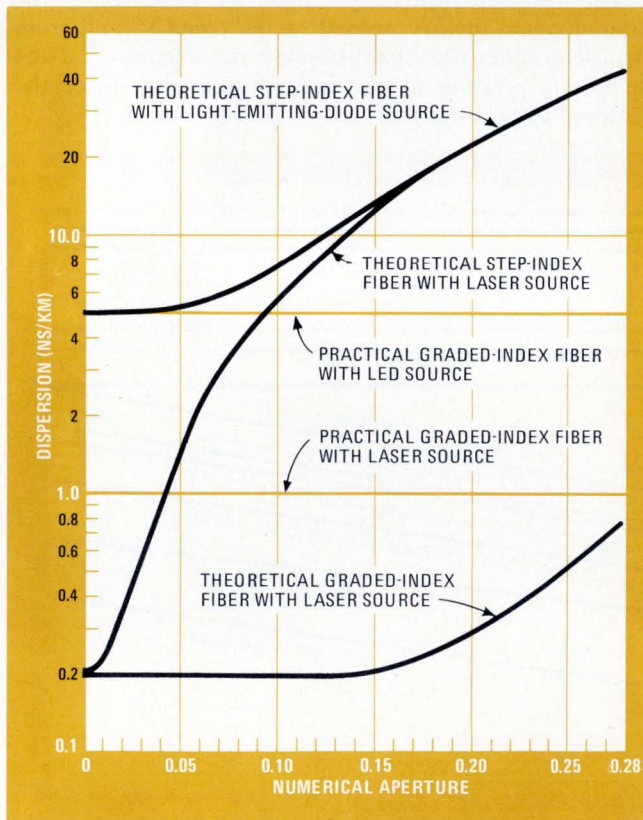

**2. Fitting fibers.** Theoretical, as well as practical, values of dispersion that can be expected in commercially available optical fibers are a function of the numerical aperture of the fiber and the type of source used to drive the fibers.

COMPARING FIBER OPTIC SYSTEMS				
Modulation format	Source/photodetector combination	Bandwidth expansion factor (m)	Margin (dB)	Total allowable dispersion (NS)
Intensity modulation	Laser/p-i-n	1		
	Laser/APD	1		
	LED/p-i-n	1	21	70
	LED/APD	1	27	70
Pulse-position modulation	Laser/p-i-n	37.5	56	5.3
	Laser/APD	100	77	2.0
	LED/p-i-n	37.5	35	5.3
	LED/APD	100	56	2.0
Pulse-code modulation	Laser/p-i-n	20	50	10
	Laser/APD	20	64	10
	LED/p-i-n	20	29	10
	LED/APD	20	43	10

Notes: Linearity of laser may be insufficient with intensity modulation. Bandwidth expansion factor may be reduced at the expense of available margin. Allowable dispersion margin decreases by 1/M.



modulation formats. The curves for the two digital formats take into account the bandwidth expansion necessary to maintain a 40-dB s/n ratio or a  $10^{-8}$  BER and assume a sampling rate of 2.5.

It should be noted that Fig. 1 applies only to links with where a 40-dB s/n ratio or  $10^{-8}$  BER is suitable. For other requirements, similar design curves must be constructed from data on device characteristics.

### Determining the margin

Using these curves, the design engineer can determine directly in decibels the difference between available source power and the required signal power at the receiver for each modulation format. This difference—the margin—provides a measure of allowable link attenuation, which includes fiber and connecting losses.

The greatest margin results from using a fiber having the largest numerical aperture, since this assures maximum power into the cable. With intensity modulation, a LED usually is used as a light source, because most available injection lasers lack sufficient linearity. However, either type of photodetector may be used in the receiver, depending on the margin required.

From Fig. 1, a LED driving an optical fiber with a numerical aperture of 0.2 (typical of available fibers) produces an average power of  $-14$  dBm. The minimum average power needed to maintain a 40-dB s/n ratio over a 5-MHz link at the photodetector when using intensity modulation is shown as  $-41$  dBm for an avalanche photodiode;  $-35$  dBm for a p-i-n photodiode. The difference between transmitter and receiver power levels gives a margin of 27 dB with an avalanche photodiode, 21 with a p-i-n photodiode.

Coupling and splicing losses must be considered to determine the allowable cable attenuation. These losses, which are common to all systems, here are 2 dB for input and output couplers and 1.4 dB for the splices needed to join the 0.5-km cable sections. The total loss of 3.4 dB reduces the margin to 23.6 dB for the combination of LED and avalanche photodiode and 17.6 for the combination of LED and p-i-n photodiode. So the maximum attenuation in the fiber cable selected cannot exceed 5.9 dB/km and 4.4 dB/km, respectively, for the entire 4-km length.

### Considering dispersion

Fiber dispersion, generally given as the half-height, full-width time response of the fiber to an impulse, can affect signal quality. With pulse-modulation formats, pulse widening can cause pulse overlapping in pulse-code modulation and reduce the output s/n ratio in pulse-position formats. For intensity-modulated signals, dispersion limits fiber bandwidth to about 35% of the reciprocal of the dispersion.

In the 5-MHz, 4-km TV link, no more than 70 nanoseconds is tolerable using intensity modulation. Fiber dispersion is plotted in Fig. 2 as a function of the numerical aperture for step-index and graded-index fibers [*Electronics*, Aug. 5, p. 89] when used with a laser of LED source.

Actually, mode mixing tends to improve the dispersion characteristics of both fiber types. It is due to the scattering of light energy at randomly distributed

imperfections in these fibers. Light energy in the various modes couples back and forth at the imperfections, reducing delay spread. In some cases this causes dispersion to increase as the square root of, rather than proportionally with, fiber length.

For the 4-km TV length, fiber dispersion must be less than 70 ns. From Fig. 2, it can be seen that any graded-index fiber can be used; a step-index fiber with numerical aperture below 0.18 can also be used, and possibly one with a higher numerical aperture can be used, if mode mixing is significant.

The results of using the curves of Figs. 1 and 2 to determine allowable margin and total dispersion for a system using a fiber with a numerical aperture of 0.2 are shown in the table. All possible combinations of source/photodetector/modulation format are listed.

### Trading bandwidth for margin

Most commercially available low-loss fiber cables have no difficulty meeting the PCM and PPM attenuation limits listed in the table. But with intensity modulation, it's a different story. Relatively few fibers are available with the attenuation of 5.9 dB/km that is the maximum acceptable for the TV system under discussion. And they are expensive: a cable with such a low attenuation and a dispersion of 70 ns over 4 km costs about \$2,500 per kilometer. The designer is now faced with trading cost and availability off against line length or else finding a way to increase the margin.

Using the pulse-code or pulse-position modulation formats is one way of increasing the margin over that of intensity modulation. However, there is a drawback. In order to handle the necessary digital coding, the band-

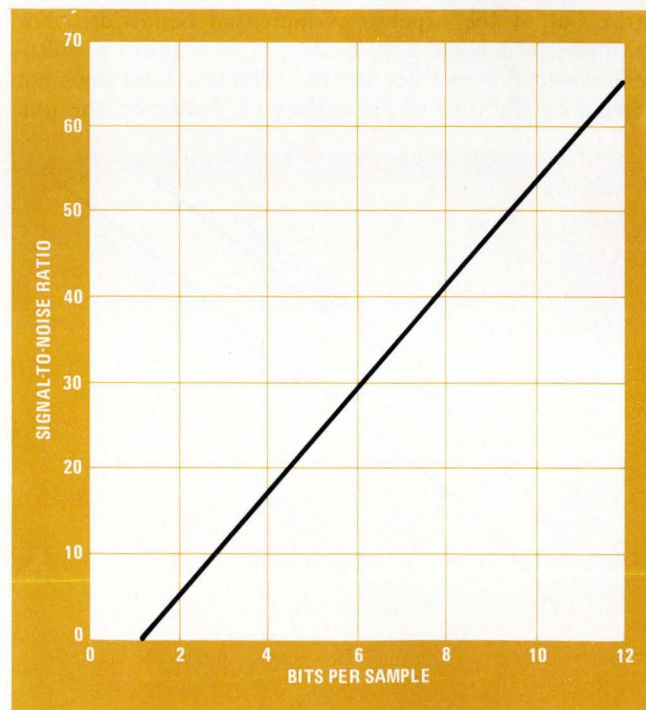

**3. Bits per sample.** For pulse-code-modulation formats, a bandwidth expansion over that required for analog transmission is needed to maintain the signal-to-noise ratio. The s/n ratio is a function of bits per sample, but is independent of photodiode type.



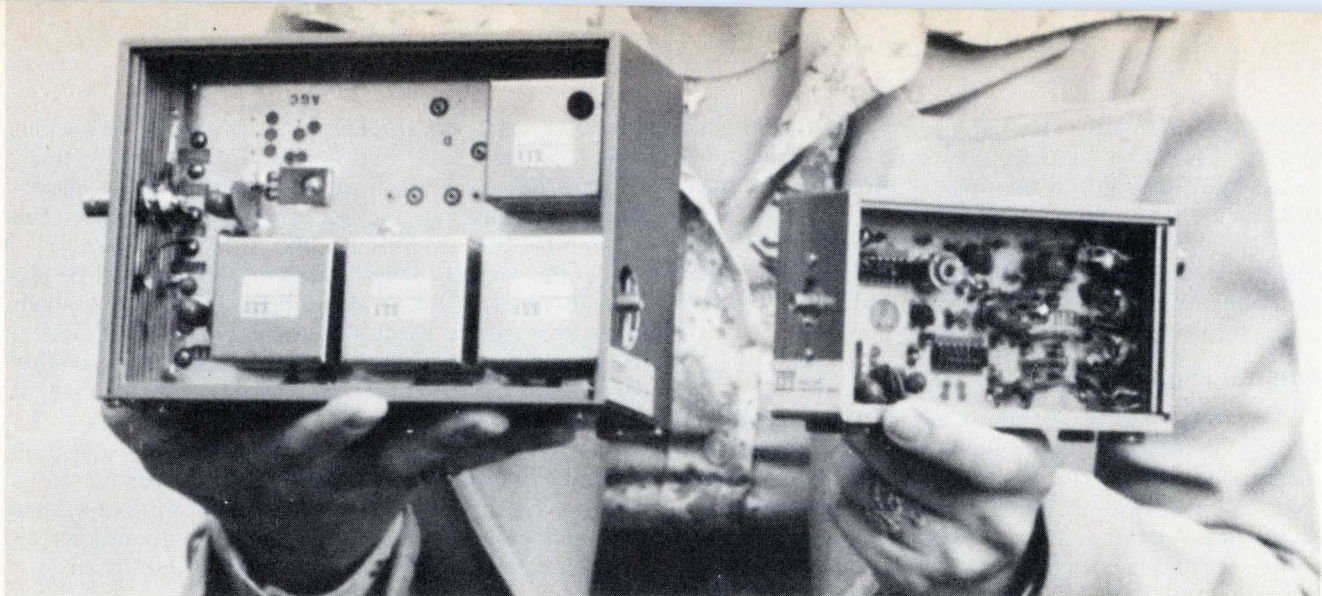

**Fiber optic data links.** Analog and digital fiber-optic transmission systems use high-brightness LEDs in the transmitter (left) and low-noise receivers with p-i-n photodiodes to maximize optical efficiency. The link is suitable for fiber-bundle or single-fiber-per-channel cables.

width must be increased substantially, and this adds significantly to the cost of the cable since now the dispersion requirements are much more stringent.

#### Multiply the bandwidth

The reciprocal of the analog bandwidth must be divided by a factor,  $m$ , to determine the allowable dispersion for PCM and PPM. The cable, transmitter, and receiver must be capable of handling the increased bandwidth, also.

In a PCM system,  $m$  is equal to the sampling rate multiplied by the bits per sample. An increase in the  $s/n$  ratio increases with the bits per sample, as plotted in Fig. 3. A higher bit rate per sample results in greater  $s/n$  ratio, but at the expense of increased bandwidth. For example, to achieve a 40-dB  $s/n$  ratio requires a pulse-code word of 8 bits per sample. The  $s/n$  ratio does not depend on the type of photodetector. However, the link

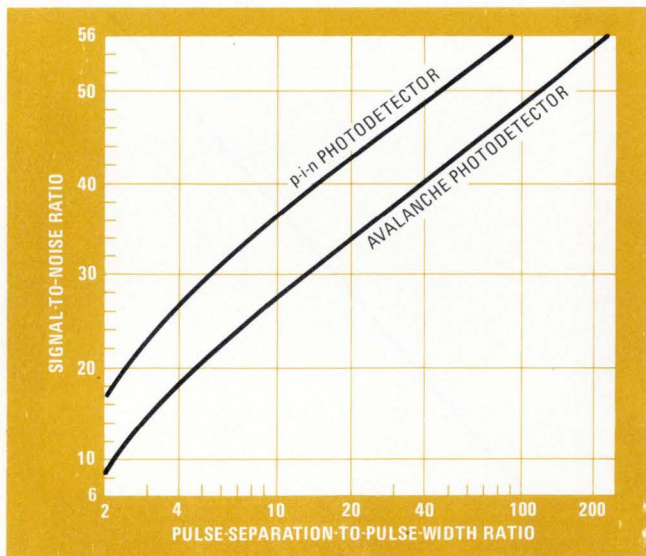

**4. Setting signal to noise.** Pulse-position modulation improves the signal-to-noise ratio of fiber-optic systems, but bandwidth must be increased over that required for analog transmission. P-i-n diodes require less bandwidth for the same  $s/n$  ratio.

attenuation is chosen so that the received optical power is high enough to maintain the desired BER of  $10^{-8}$  that assures that the received-signal quality is not degraded.

In a PPM system, the same tradeoff occurs between  $s/n$  ratio and increased bandwidth (Fig. 4). Here  $m$  is the product of the sampling rate times the pulse-separation-to-pulse-width ratio. With such systems, the  $s/n$  ratio does depend on the photodetector.

As shown in the table, a PCM link using a combination of laser and avalanche photodiode increased the margin to 64 dB. Deducting all coupling losses in the TV-system example reduces the margin to 60.6 dB. This allows use of a much higher-loss fiber—15 dB/km.

However the dispersion requirement has stiffened from 70 ns to 10 ns. The smallest  $m$  that will meet the TV-signal requirements is 20 (a sampling rate of 2.5 times 8 bits per sample). The dispersion required is the reciprocal of the signal bandwidth divided by  $m$ , and the result for the PCM-implemented TV link is 10 ns.

It can be determined from Fig. 2 that a maximum dispersion of 2.5 ns/km can be achieved with any graded-index fiber with a laser source or with a combination of laser and step-index fiber with a numerical aperture of less than 0.06. A LED source cannot be used with either fiber type.

A PPM format, though providing increased margin, requires an even larger  $m$  if signal quality is to be maintained. This severely limits the choice of fiber because of the extremely low dispersion required. For example, a combination of laser and avalanche photodiode yields a margin of 77 dB in the PPM format, but restricts the allowable dispersion to a total of 2.0 ns.

The designer's final choice must consider the tradeoffs in cost of both cable and components. Although the fiber needed for some PCM systems probably would cost less than the more demanding fibers for intensity modulation or PPM systems, the savings may be lost because of the increased cost of transmitter and receiver components. □

*For more information on the status of the technology of fiber optics and fiber-optic components today, see the special report in Electronics, Aug. 5, pp. 81-104.*





## Hughes hybrid microcircuitry saves the DC-10 enough weight to carry two pro linebackers.

How can anything that small add up to that much in weight savings?

Simple. A Hughes multiplex system uses time-sharing techniques to carry many signals over a single coaxial transmission line.

And that means eliminating hundreds of feet of copper wire going to some 250 passenger seat stations. Or over 500 pounds.

Multiplexing technology made it possible, sure. But Hughes hybrid microcircuitry made it practical.

Maybe you don't need to save the weight of two football players. But using hybrid circuits can cut the fat out of a lot of equipment. It can

sideline high assembly time and heavy production costs and substitute high reliability.

Let us tackle your problem. We'll analyze your present circuitry, then design the hybrid circuits, develop the prototype, manufacture the custom components, assemble, test and guarantee the total hybrid package.

Write for our illustrated brochure. To:

Hughes Microelectronic Products Division, 500 Superior Ave., Newport Beach, CA 92663. Or telephone: (714) 548-0671.





## DVM locates short circuit on wired circuit board

by Richard A. Rosner  
Perkin-Elmer Corp., Danbury, Conn.

A microvoltmeter or digital voltmeter can be a great time saver in finding a short circuit on a circuit board that is wired with a large number of integrated circuits and bypass capacitors. The situation arises when the engineer sets his bench power supply to the proper  $V_{CC}$  voltage, plugs in the board, and watches the voltmeter drop to zero while the ammeter reads full current at the current-limiter value—the  $V_{CC}$  supply is shorted to ground.

If visual inspection does not reveal the short and none

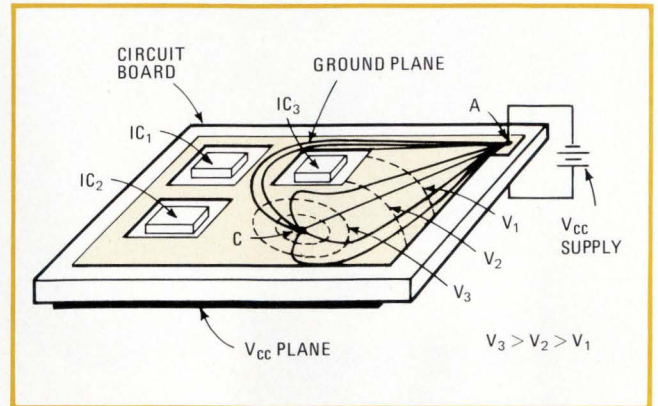

**1. Short subject.** A short circuit between the power and ground planes at point C causes currents to flow along the ground plane to point A. Since equipotentials have highest values near point C, a probe that measures voltages on the ground plane relative to point A indicates the location of the short.

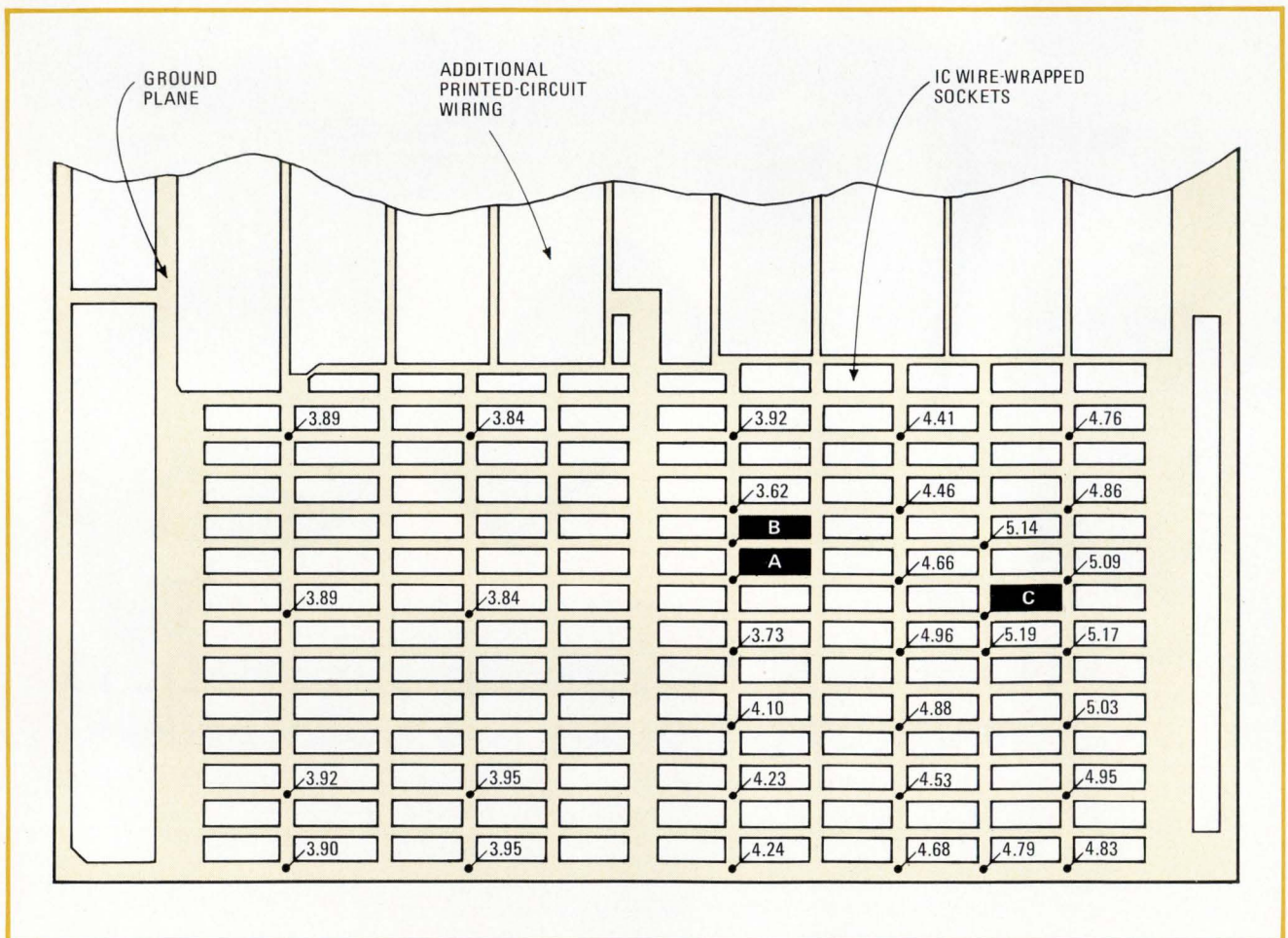

**2. Look here.** On this circuit card, signals are carried by 600 wrapped wires above the ground-plane side of the board. A short circuit from an IC pin to the ground plane at point C was located by measuring ground-plane voltages (shown in millivolts) relative to the negative supply connection at point A. The positive side of the supply is connected to the power plane below point B.



of the ICs feels hot to the touch, measurement of the potential between the power-supply ground connection and other points on the ground plane will indicate the location of the short-circuit point in a few minutes.

This technique is effective because a potential difference of several millivolts can exist from one end of the ground plane to the other as current flows through it. If current enters the ground plane at the location of the

short circuit and leaves at the power-supply return, as shown in Fig. 1, the voltage difference is greatest between these two points.

Figure 2 shows the voltages measured at several points on part of a shorted board. The short turned out to have been caused by a 0.5-millimeter ball of solder splatter that was held in place (and out of view) by a bundle of wires. □

## Induction pickup drives elapsed-time indicators

by Edmund Osterland  
Boonton Township, N.J.

Maintenance intervals for alternating-current machines like pumps, fans, and transformer-operated equipment can be monitored without hard-wiring to these units. By simple inductive pickup through the frame of a motor, for example, it is possible to operate such integrating modules as the Curtis Indachron, the Philips 49800 electrochemical elapsed-time indicator, or the Plessey E-cell device. These units function on microampere levels of current to record operating times of 100 to 10,000 hours, depending upon their specific dc input.

Figure 1 shows a pickup unit clamped (either mechanically or magnetically) to a motor frame. The location is not critical, but proper orientation can be aided by measuring the voltage at a test jack. Capacitor C in parallel with the pickup coil resonates the coil for maximum output voltage. The induced ac is rectified and applied through a current-limiting resistor to a zener diode. The zener diode regulates the rectified voltage input to the timing cell, and series resistor R determines the operating span.

A satisfactory pickup coil may be made from a small commercial choke such as the Stancor C-1003 by removing the strap mounting and the "I" portion, and sawing off one leg of the "E" laminations to provide a single-gap "U" configuration. This pickup delivers up to 10 volts ac when applied to the frames of 1/4-horsepower to 1-hp motors and adjusted for optimum coupling.

A resistor of 22 kilohms is shown in Fig. 1 followed by a zener diode (1N746) nominally rated at 3.3 v. However, in the low-current application described here, the regulated voltage drops below 2 v. In the event that

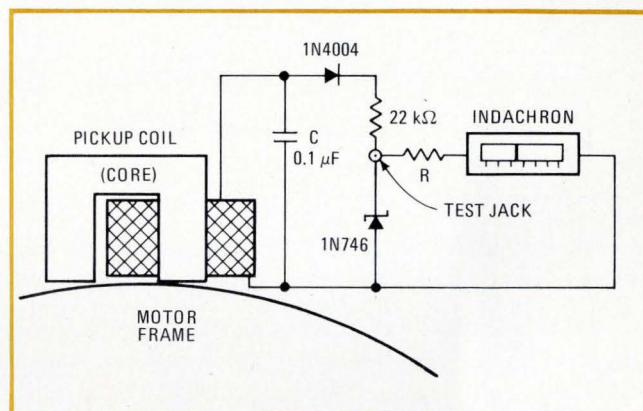

**1. Counts the hours.** Operating time of ac equipment is measured by wireless pickup, rectification, and integration of total dc charge transfer. Zener diode sets dc voltage, and resistor R sets current level through current-integrating module such as the Indachron shown. Capacitor resonates pickup coil for maximum induced voltage, which can be monitored at jack.

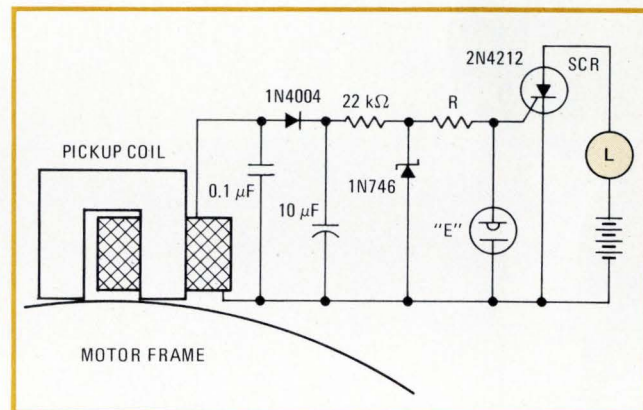

**2. Triggers a signal.** The rectified current from the pickup coil depletes the working electrode of a Plessey E-cell device. When the electrode is completely depleted the device changes from a low impedance to high impedance, triggering the SCR to activate a battery-powered warning.

RESISTANCE VALUES FOR INTERVALOMETER  
USING CP3 INDACHRON

TEST-POINT VOLTAGE	R (OHMS)	TIME SCALE (HOURS)
3.3	1.03 M	1,000
2.0	630 k	1,000
2.0	63 k	100
1.0	315 k	1,000

the source voltage is insufficient for regulation by the zener, the system may still be used in the unregulated state by appropriate choice of calibrating resistor R. The table at left represents typical parameters for a circuit that uses a CP3 Indachron. Intermediate hourly spans may be observed on the calibrated scale of the Indachron unit.

If a signal is desired at the end of a prescribed time interval, a Plessey E-cell device can be used. Instead of having a scale readout, the E-cell abruptly increases in



# Keep it clean

Keep your signal clean with our high dynamic range RF amplifiers. Both very large signals and very small ones. High third order intercepts protect large signals from intermodulation distortion while low noise figures help small signals maintain their identity.

For example, Model AM109 has a typical third order intercept of +48 dBm and a 5.5 dB noise figure. If low noise is your main concern, we have models in our select RF amplifier group designed specifically for that parameter; 1.5 dB is typical for Model AM117.

To find out how we can help your signal, call or write for complete technical data.

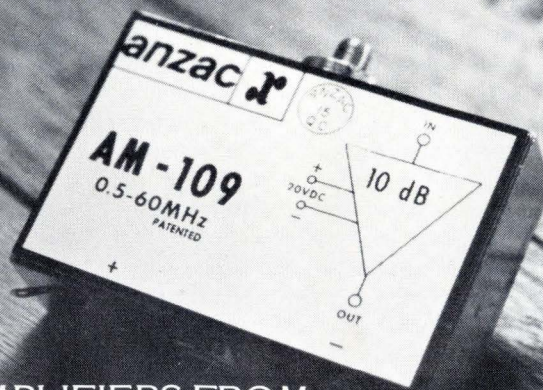

HIGH DYNAMIC RANGE AMPLIFIERS FROM

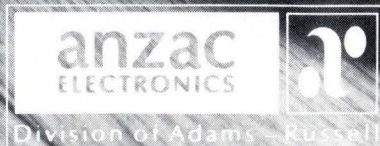

39 Green St., Waltham, MA 02154  
(617) 899-1900 TWX (710) 324-6484

Circle 20 on reader service card



resistance at the expiration of its time cycle. In the circuit of Fig. 2, the bias change on the silicon controlled rectifier triggers an indicating light or a sound source such as the Mallory Sonalert, powered by the battery.

In addition to simplicity of connection, the pickups

have the advantage of isolation in sealed systems such as, for example, cooling fluids in nuclear power plants or tightly sealed corrosive pumping systems. Also, it is possible to sample ON intervals of various machines without interrupting the power flow. □

## Frequency-counter design minimizes number of parts

by Lloyd F. Botway  
University of Missouri, Columbia, Mo.

A handful of commonly available complementary-MOS integrated circuits can be made into a simple digital frequency counter capable of 100-hertz accuracy at 5 megahertz. The circuit uses only  $(N + 1)$  IC packages for an  $N$ -digit display. It dispenses with display latches, extra logic for generating a count-reset pulse, and current-limiting resistors for the seven-segment light-emitting-diode display.

As the diagram shows, the frequency to be measured is applied to a series of cascaded CD4026 decade counter/decoders. The counters count incoming cycles for 10 milliseconds and then drive LEDs to display the count for another 10 ms. Thus the display is updated every 20 ms and appears to be continuously on.

The element that controls the alternate counting and displaying is a CD4047 astable multivibrator, which generates a square wave with 20-ms periodicity. When the multivibrator's output,  $Q$ , is low, the clock inputs of the counter/decoders are enabled, their displays are

disabled, but the counters count. When  $Q$  goes high, the clock inputs are disabled, and the count is displayed.

The counters are reset at the end of each 10-ms display interval by the positive pulse obtained by differentiating the rising  $\bar{Q}$  output from the CD4047. The negative pulses are clamped to ground by diode  $D$ .

With values of  $C_1$  and  $R_1$  chosen to give a counting interval of 10 ms, the least significant digit in the display indicates hundreds of hertz because 100 pulses per second  $\times$  10 ms gives one pulse. Thus, a display of 246 indicates a frequency of 24,600 Hz, or 24.6 kilohertz. The counter is calibrated by adjusting  $R_1$  for proper reading with an input signal of known frequency.

Supply voltage  $V_{DD}$  may have any value from 3 to 15 volts. The higher the supply voltage, the greater is the range of input voltages and the faster the counting—and the brighter but more current-consuming the display. The values of  $C_2$  and  $R_2$  should be chosen to give a reset-pulse duration of at least 250 nanoseconds. Diode  $D$  can be any general-purpose diode with a peak reverse voltage of at least  $2V_{DD}$ .

The same circuit can be used with a counting time of 100 ms to obtain frequency resolution to 10 Hz, but at such a long multivibrator periodicity, the display's 50% on/off duty cycle causes objectionable blinking. □

Engineer's notebook is a regular feature in Electronics. We invite readers to submit original design shortcuts, calculation aids, measurement and test techniques, and other ideas for saving engineering time or cost. We'll pay \$50 for each item published.

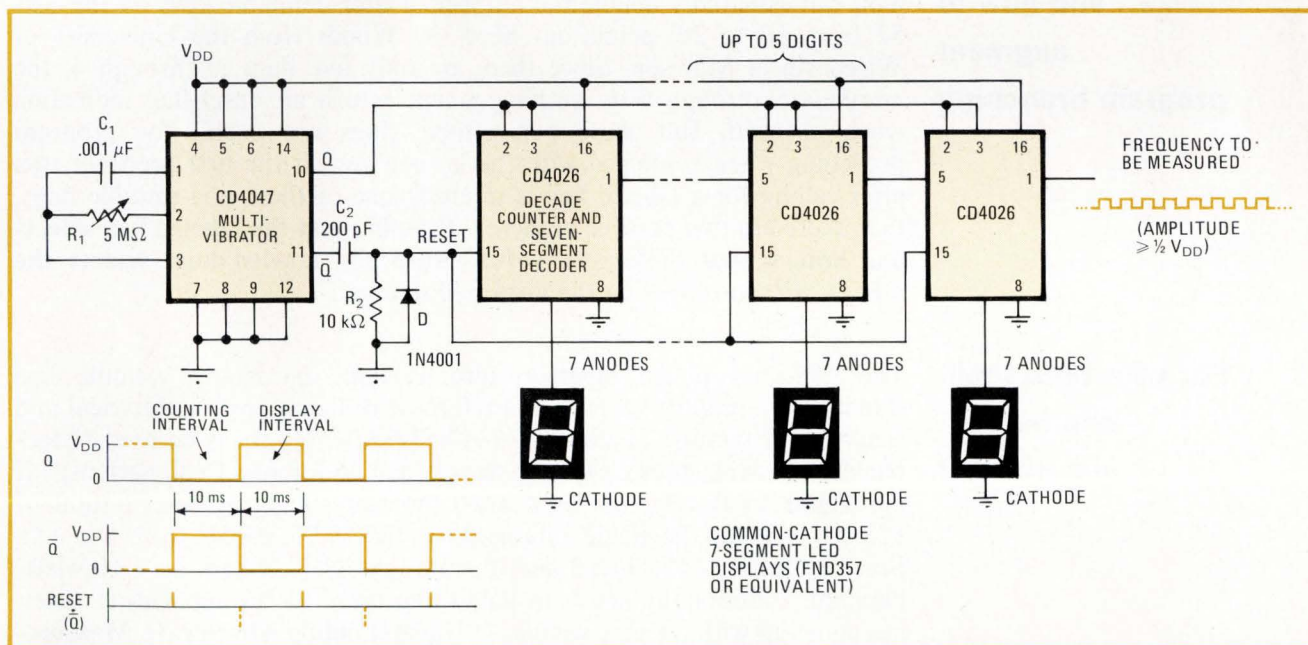

**Reads out frequency.** Frequency is measured in this circuit by counting the total number of incoming pulses in a 10-ms interval. That total is then displayed for the next 10 ms. This cycle, repeated every 20 ms, produces a flicker-free display. The multivibrator output determines the timing intervals and supplies reset signals to erase the counters every period. The C-MOS devices shown are RCA types or equivalents.



## The SR-52 calculator: how that extra memory works . . .

As pointed out recently on this page, Texas Instruments' SR-52 calculator has extra addressable data registers at locations 70 through 99 [*Electronics*, July 22, p. 124, and Aug. 19, p. 114]. These locations are, in fact, the program memory with eight program steps stored in each location, note J.K. Marshall and W.N. Waggener of Weston Instruments Inc., EMR Telemetry, Sarasota, Fla. This means that program steps 000 through 007 are stored in location 70, steps 008 through 015 in location 71, and so on—up through location 97, with locations 98 and 99 free for unrestricted storage. With care, they say, you can **trade program steps for additional data storage by starting programs at location 70 (program counter = 000) and working upwards, while working downwards from location 99 for additional data storage.** This technique has proved useful with some of the Wang programable calculators.

## . . . how to make the best of the program card . . .

Any data you store in registers 70 through 99 of the SR-52, you can also record on the calculator's magnetic program card. However, **since these hidden storage registers take up some program memory, you must trade off the number of recordable registers against the number of program steps,** cautions Tom Martin, Collins Radio Co., Dallas, Texas. He's found the following selections useful: take steps 000 to 069 and 100 to 160 for the program and registers 90 to 97 for data storage, or take steps 000 to 069 and 100 to 115 for the program and registers 85 to 97 for storage. With the first option, there are 129 program steps and eight recordable registers, in addition to the 20 normal nonrecordable registers. The second gives 84 program steps and 13 recordable registers. Either option requires a GO TO statement that skips the program from step 069 to step 100.

## . . . and how to augment program branching

You can essentially double the number of user-definable keys on the SR-52 from 10 to 20, points out Scott A. Woods from the University of Wisconsin in Madison. Since there are only five flags, 0 through 4, the numbers 5 through 9 do nothing except return an unset-flag indication when checked. But these non-settable flags are useful for program branching when combined with the inverse key. If the first program step after calling for a labeled key is to check one of these non-settable flags, then there are two possible branches. **Pressing just the labeled key selects one branch, but pressing INV first, then the labeled key, selects the other—without affecting the displayed number.**

## For your bookshelf, one bargain and one gift

The IEEE has pulled together, into a single hardcover volume, five standards on graphic symbols and reference designations for electrical and electronic diagrams. The book, 76-ANSI/IEEE Y32E, is entitled "**Electrical and Electronics Graphic Symbols and Reference Designations.**" If purchased separately, the IEEE says, the five standards cost a total of \$28.90, whereas the single volume sells for \$19.95. Order from the IEEE Service Center, 445 Hoes Lane, Piscataway, N.J. 08854. . . . Hewlett-Packard, traditionally active in publishing truly useful application notes, has come up with another winner—"Understanding Microwave Measurements," a discussion that centers on microwave frequency counters. The 10-page note, number 144, is available free from the company at 1501 Page Mill Rd., Palo Alto, Calif. 94304.

—Lucinda Mattera



# Big SID is here.

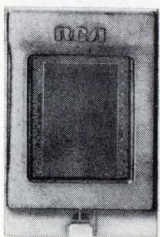
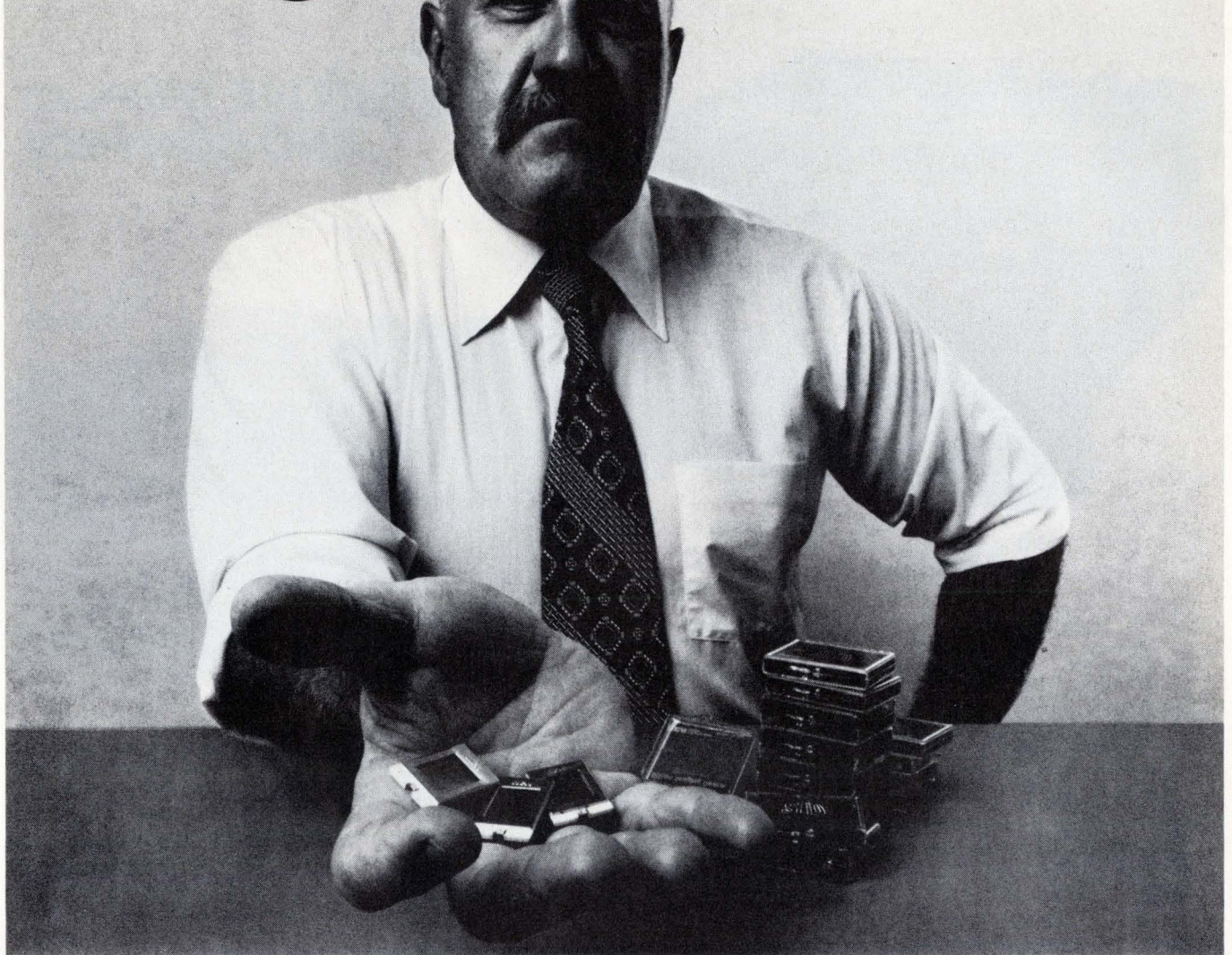

SID52501  
actual size.

**30-day delivery  
on RCA's new  
Silicon Imaging  
Device and CCD  
camera. Improved  
performance—lower price.**

RCA's pace-setting CCD imager is now in production... with 30-day delivery. And you can get the new Big SID for less than before—under \$1000. Yet performance is better than ever.

Horizontal resolution has been improved by using buried channel techniques. And we're subjecting units to more stringent blemish criteria. The RCA 512 x 320 array with

163,840 pixels provides remarkably clear, standard interlaced, 525-line TV pictures.

You can get Big SID with all its advantages in our TC1160 CCD camera—also with 30-day delivery, and a price of less than \$2000.

Big SID is here now, so why wait? For more information contact your RCA Representative or distributor. Or, RCA CCD Marketing, New Holland Ave., Lancaster, PA 17604. Tel: 717-397-7661.

TC1160



**RCA Charge-Coupled  
Devices**



# The Easy Reader

**FOR EFFECTIVE DISPLAY  
AND CONTROL**



model 4424  
0.55" display



model 4443  
1" display

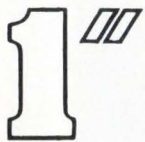

## LARGE BRIGHT DISPLAY

LFE series 4400 DPM's are more readable than conventional LED displays. They provide a unique one inch display and uniform high intensity digits. Also, gaps between digit segments have been eliminated.



## LOW PRICE, HIGH VALUE

Use of the latest conversion techniques allows series 4400 to have fewer components and single board construction. Technological breakthrough provides proven LFE quality and reliability at a new low cost.



## RPM, °F, volts, AC, amps, °C, DC, ————

LFE series 4400 DPM's can accept optional second printed circuit board to provide for most signal conditioning conversions. Complete boards available for linearized thermocouple, RTD, AC motor speed, power line, and other special inputs.

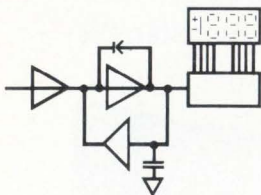

## ACCURATE DISPLAY, RELIABLE PERFORMANCE

FET high impedance input, multiplexed BCD output, high noise rejection, plug-in digits, auto polarity, flashing over-range, automatic zero, space saving design, and other features are standard. A lengthy burn-in and an exhaustive computer controlled checkout insure high reliability.

Nationwide network of modification/distribution centers provide local stocking, modification, and repair. Contact your local representative for applications assistance. For complete details on series 4400 DPM's write to LFE Corporation, Process Control Division, 1601 Trapelo Road, Waltham, MA, 02154, or telephone 617-890-2000.

**LFE**  
CORPORATION



# Thin-film networks take on discretes

Plastic DIPs of eight and 15 resistors are priced to displace metal-film units

by Larry Waller, Los Angeles bureau manager

**High cost has** been the main obstacle keeping thin-film resistor networks from widely displacing discrete metal-film resistors in semi-precision applications. As a rule, these passive networks are priced far above the \$1-and-under range required to compete with individual resistors of comparable performance.

Now bidding to break this price barrier, Beckman Instruments' Helipot division, is bringing out two low-cost thin-film networks—an eight-resistor model that sells for 65 cents each in the common 1,000–9,000 quantity and a 15-resistor unit that is priced at 81 cents each for the same size of order. Both of what Beckman calls its series 698 resistor networks are molded in a standard 16-pin, plastic, dual in-line package.

With this series, "Beckman is going after the semi-precision market now served by thin-film metal discrete resistors," vows Howard D. Frazier, product marketing manager for passive networks. He defines this segment of the resistor market to be one requiring tolerances of about 0.5% to 1%. Both the Beckman 698-1 (15 resistors) and 698-3 (eight resistors) have a 1% resistance tolerance rating at 25°C.

While the 698 networks presently "address this middle 30-32% part of the resistor market," Frazier says the company is working on units for the precision end, requiring 0.5% and better accuracies, and accounting for 8–10% of the total. The remaining 60% general-purpose segment, in the 2% accuracy range, uses thick-film networks. Beckman was the first to introduce standard-packaged thick-film units in 1967.

"Attaining the performance pa-

rameters was no problem," Frazier observes, "but getting that cost down took most of the effort over the year-long development." It resulted "from no one improvement by itself, but a combination of production techniques, an optimized design, and a cent or less saved here and there throughout assembly." Among these, a simplified packaging concept and shorter leads for bonding savings stand out. "There was no point in coming out with just another high-priced network," he says.

Among the inherent advantages that networks have over discrete resistors for designers is "tracking," or providing more similar resistance variations than discretes, which are

generally unmatched because of cost constraints. Frazier claims the 698 series tracking specification of  $\pm 5$  parts per million per degree celsius affords much greater circuit stability than unmatched discretes. A related feature is the resistance temperature coefficient of  $\pm 50$  ppm/°C over a temperature range of  $-55^{\circ}\text{C}$  to  $125^{\circ}\text{C}$ .

In power ratings, the 15-resistor model 698-1 has a 1.25-watt specification for the total package and 0.125 w for a single resistor. The eight-resistor model 698-3 also has a 1.25-w total package power rating, against 0.2 w for a single resistor. Those power-dissipation limits are specified for an ambient temperature

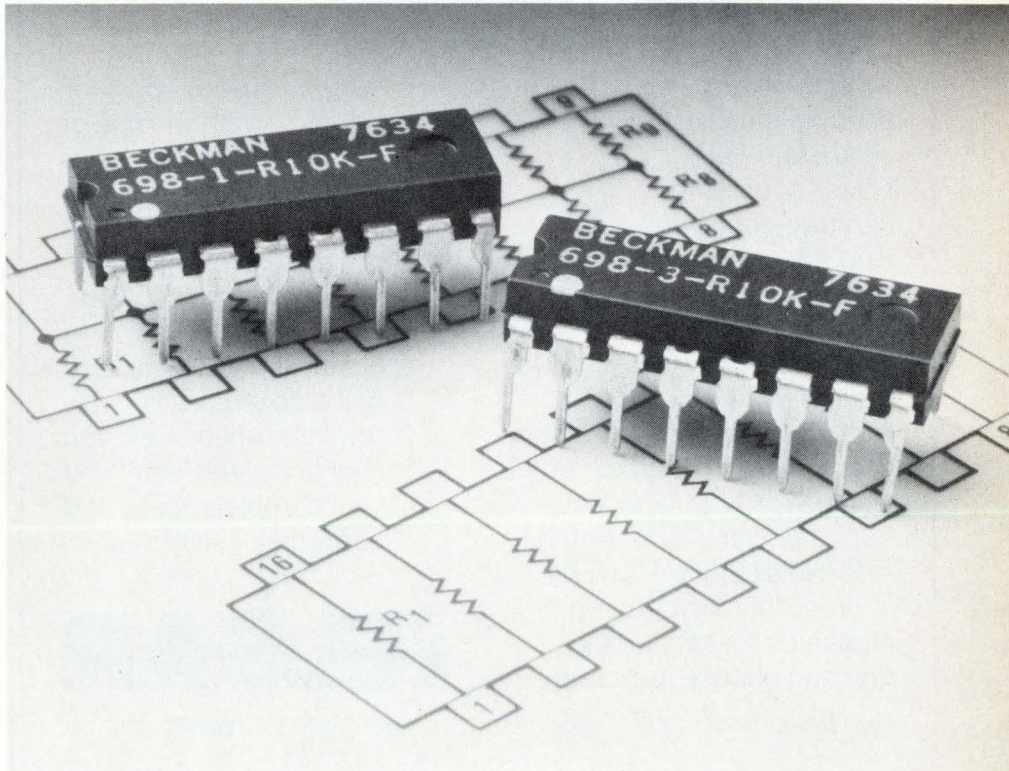



# Better just got smaller.

## The 501C AC power source.



We've been building the best solid-state AC power sources you can buy since 1965. And now we're building them smaller and lighter as well. Our new Model 501C measures 5 1/4" high by 19" wide by 16" deep, and weighs in at a mere 46 pounds. Input voltage is 117 or 234 VAC; output power is 500 VA max. And like all Elgar AC power sources, the 501C accepts plug-in oscillator modules. You can choose from more

than 50 plug-ins with variable or fixed frequencies ranging from 45 Hz to 10 KHz. Or you can use a programmable oscillator.

By now, you've probably thought of at least half a dozen uses for this new instrument. So if you write us, we'll send you complete specs and application information.

**ELGAR**

8225 MERCURY CT., SAN DIEGO, CA 92111, (714) 565-1155, TWX 910-335-1246

of 25° celsius (77°F) in still air.

Another benefit of the Beckman series, Frazier points out, is its ability to respond to a user's need for varying resistance values in a network. "Resistors can be coupled in series or parallel to obtain other values such as might be required in amplifier gain-setting applications," he states. A network configuration is easy to handle in manufacturing, lending itself to automatic insertion and hence to assembly savings. Of course, it is suitable for replacing discretes only where the design calls for physically close resistors; but in these cases, network compactness will also save board space.

Frazier notes that the 698 series uses an alumina base for the substrate material. Nickel-chromium, popularly called Nichrome, is employed for the resistor material, in three separate blends to obtain the resistance value ranges.

Beckman series 698 networks meet all the MIL-R-83401 requirements except for power, and Frazier says since this specification applies to thick film, a thin-film network would not need these high power ratings. A new military specification is now being prepared for thin-film networks, he notes.

Frazier says that "Beckman is really excited" about the new networks, which it expects to be an increasing factor in the market and will be expanded "consistent with demand." Beckman has an insight into the resistor market not only as a supplier, he notes, but as "one of the leading consumers of networks in the medical instrumentation division."

Among possible applications, he lists summing, differential and instrumentation amplifiers, two-phase sine-wave oscillators, filters, zener references, and ladders for digital-to-analog converters.

Prices for other quantities are: 698-1, \$3.75 for 1 to 9, \$2 for 10 to 49, and \$0.75 for 10,000 to 19,999; 698-3, \$3 for 1 to 9, \$1.60 for 10 to 49, and \$0.60 for 10,000 to 19,999. Delivery is off the shelf.

Beckman Instruments Inc., Helipot division, 2500 Harbor Blvd., Fullerton, Calif., 92634. Phone (714) 871-4848, ext. 1387 [338]



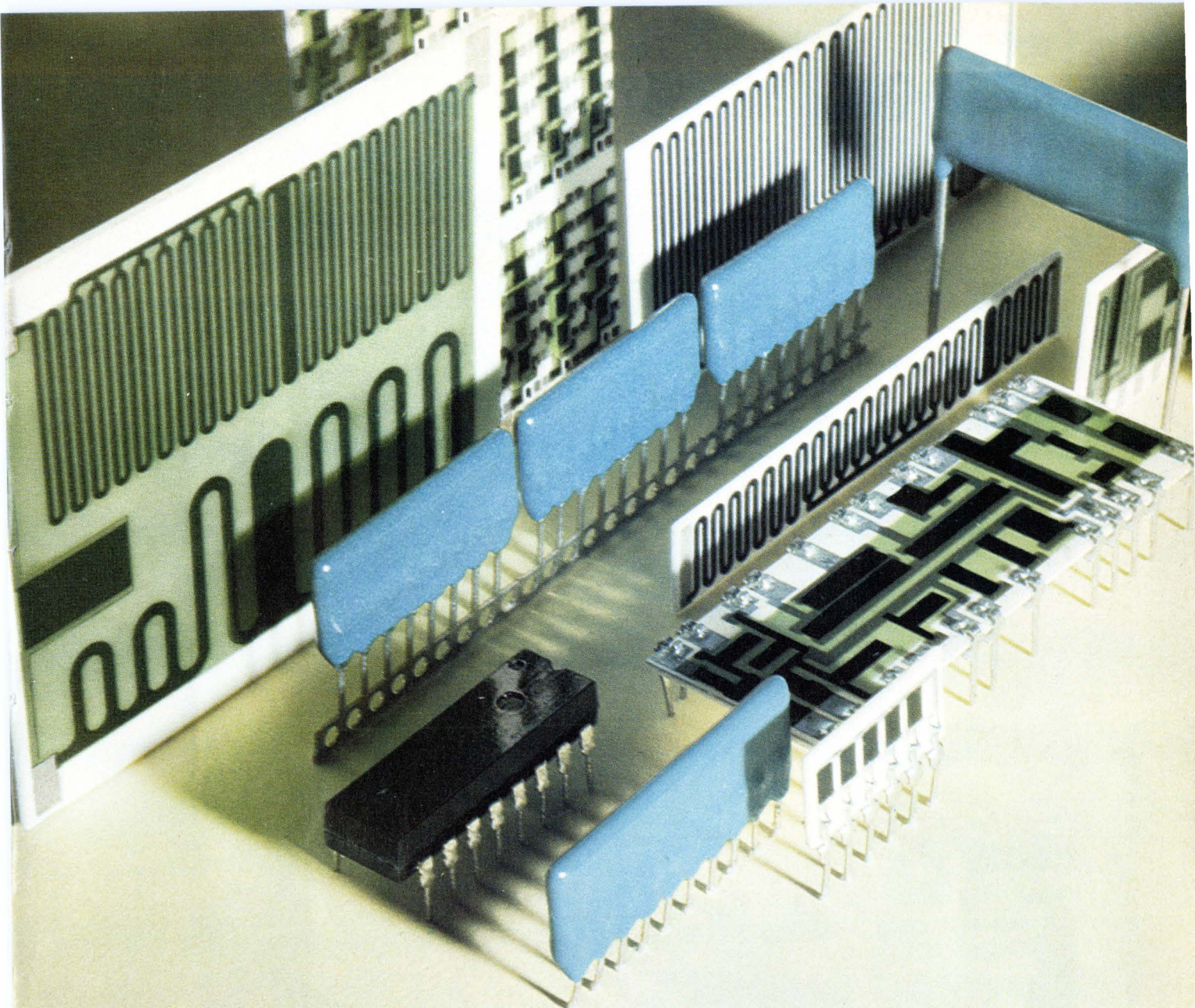

## Want to build reliability into your resistor networks? Take your choice of DuPont thick film materials systems.

If you want high performance from low-cost materials systems, you'll get it with BIROX 1600-Series Resistors. They offer TCR's of less than 100 ppm/°C across the full resistivity range. Between 0° and 70°C, TCR's are typically less than 50 ppm/°C.

And you get those TCR's with large or small resistor geometries using low-cost conductors like Palladium/Silver 9308 and Platinum/Silver 9770.

If you prefer to use non-silver conductors, the BIROX 1400-Series Resistors offer the same low TCR's with conductors like Platinum/Gold 9596.

\* Du Pont registered trademark for its thick film resistor compositions.

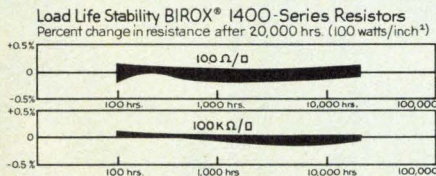

And these resistors have documented reliability, proven by 20,000 hours of load-life testing. At 100 watts/square inch, average changes for all resistivities were well under 0.5%.

You get consistently low TCR's and high stability from each lot of any BIROX resistor composition. Careful

attention to quality throughout manufacture—from raw materials to finished products—assures you of higher yields and lower costs.

Whether you manufacture resistor networks, hybrid microcircuits, or cermet trimmers and potentiometers, Du Pont has a cost-effective system of high-performance BIROX resistors and compatible conductors suited to your application.

Call, toll-free, 800-441-9475 or write: Du Pont Company, Electronic Materials Division, Room 25053, Wilmington, DE 19898.

### Electronic Materials Division



REG. U.S. PAT. & TM. OFF.  
**Electronics**

Circle 127 on reader service card



If you assemble panels - use the  
number one team - AMP Action Pins  
with **ECONOMATE** Components.

Reliability goes up.  
Costs go down.





Because the AMP Action Pin has a spring-section concept which eliminates broaching, rupturing, distortion, tearing, and damage to plated-thru walls.

That means fewer rejects.

The Action Pin concept not only provides .025" sq. I/O posts but comes in connector configurations such as contacts for card-edge applications, as well as SEM/NAFI blade-and-receptacle contacts. A unique feature of the connector housings is that they simply snap on after the contacts are inserted. This not only provides repairability but offers the opportunity of real estate savings.

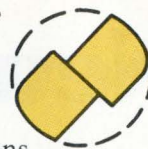

Whatever your needs, AMP ECONOMATE components featuring Action Pins have been fully tested to give you extreme reliability in the most critical environments.

You can cut costs even more with AMP high production equipment which can insert up to 10,000 Action Pins an hour.

In coming to AMP you can be assured we will support you on the production line, in quality control, in sampling for prototypes and by working with you to aid future designs. Professional engineers deserve support—at AMP our international reputation has been built on providing it.

For more information about AMP ECONOMATE components featuring AMP Action Pins, call (717) 564-0100. Or write AMP Incorporated, Harrisburg, PA 17105.

**AMP**  
INCORPORATED

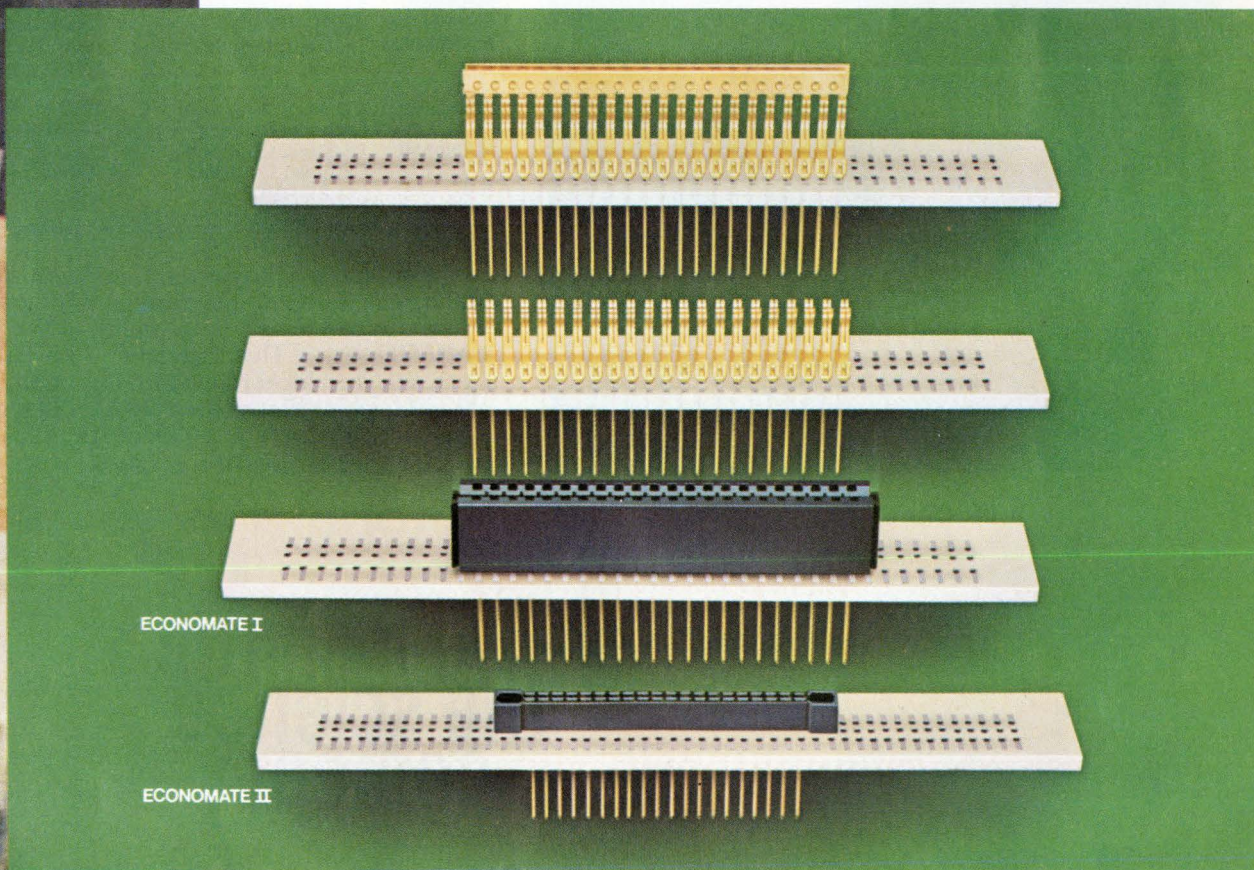



# New from Monsanto: Big 0.6" double digits! double digits!

Now you can double your designing pleasure.

Our new super-bright orange double-digit displays are available in both common cathode and common anode configurations. These 0.6" double digits (with overflow) incorporate our latest rounded-corner solid segment font to give you a display that's easy to read and easy to like.

The package is new, too. It has a colored face for optimum ON/OFF contrast. It's just under an inch in length, and packs densely to provide digits on .50" centers.

The light-emitting material is our new GaAsP:N on GaP, so you get all the benefits of this new high brightness technology—including direct MOS drive—plus all the inherent shock resistance and long life benefits of solid state. Not bad.

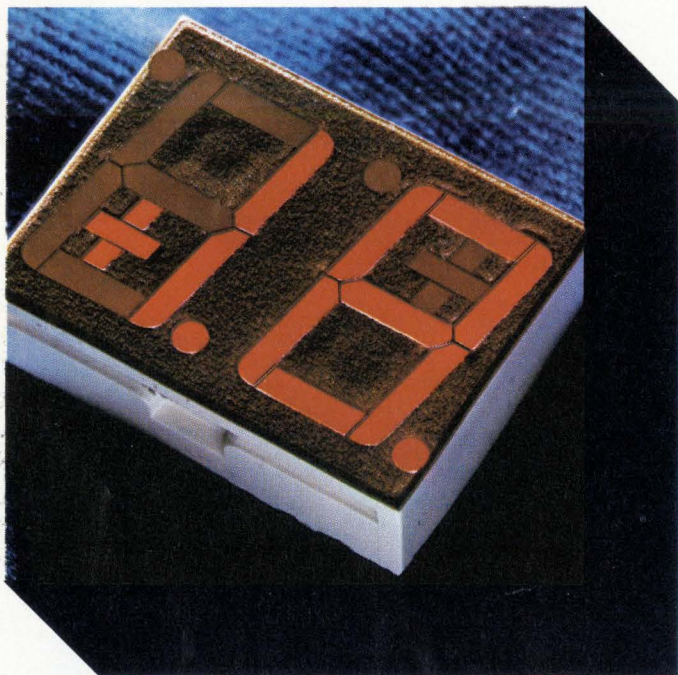

Model Number	Description	Luminous Intensity* per Segment ( $\mu\text{cd}$ )
MAN6610	2 Digit; Common Anode, RHDP	2000 @ 20mA 500 @ 5mA
MAN6630	1½ Digit; Common Anode, Overflow ( $\pm 1.8$ ), RHDP	2000 @ 20mA 500 @ 5mA
MAN6640	2 Digit, Common Cathode; RHDP	2000 @ 20mA 500 @ 5mA
MAN6650	1½ Digit, Common Cathode; Overflow ( $\pm 1.8$ ), RHDP	2000 @ 20mA 500 @ 5mA

\* Typical

So if it's bright you want, and your application calls for a 0.6-inch orange digit, call your Monsanto man in and have a look at the new MAN6600 series. They're terrific. For data sheet, see your local Monsanto distributor or write Monsanto Electronics, 3400 Hillview Avenue, Palo Alto, CA 94304. (415) 493-3300. Putting innovation to work.

**Monsanto:**  
the science  
company.



# DMMs emphasize accuracy

Autoranging 30,000-count multimeters are accurate within 0.01%; systems voltohmmeters have resolutions of 5½ and 6½ digits

by Andy Santoni, Instrumentation Editor

"Our market research indicates that large numbers of digital multimeter users want 0.01% accuracy, but are unwilling to pay the price of a 5½-digit multimeter to get it," says Alan Peabody, planning manager for multimeters at Keithley Instruments Inc. The company has therefore introduced two 4½-digit multimeters with accuracies within 0.01% and 30,000-count resolution—specifications that mean they can replace 5½-digit meters in many applications.

In addition to the DMMs, Keithley has two other new instruments on display at Wescon this week. The model 5900 volt-ohmmeter is a 5½-digit systems instrument priced at \$2,225, and the model 6900 voltohmmeter is a 6½-digit instrument priced at \$5,050.

The two 4½-digit meters share basic features. Either measures ac and dc voltage and current, as well as resistance, with manual or automatic range selection on all functions. The model 172, priced at \$499, has two current-measuring ranges—100 milliamperes and 1 ampere, full scale. The model 173, priced at \$625, has five current-measuring ranges from 300 microamperes to 1 A, full scale.

Scheduled recalibration cycle for the instruments is 180 days, minimizing maintenance costs. Over that period, accuracy is within 0.01% of reading plus 0.003% of range on most dc voltage ranges and within 0.1% of reading plus 0.05% of range or better on ac voltage ranges.

On current-measuring ranges, where automatic ranging often decreases accuracy, the two instruments still maintain accuracies to within 0.5% of reading plus 0.006%

of range from 50 hertz to 5 kilohertz on alternating current. The model 172 is accurate to within 0.25% of reading plus 0.007% of range, and the model 173 is accurate to within 0.1% of reading plus 0.007% of range on direct-current measurements.

The instruments' 30,000-count resolution makes it possible to measure 24- and 240-volt lines at full rated accuracy while maintaining high resolution.

The two systems voltmeters are similar to the units from Dana Laboratories Inc. that bear the same part numbers. The Keithley versions, which are manufactured for Keithley by the Irvine, Calif., firm, differ mainly in cosmetics. According to David Bartos, Keithley's marketing manager, his firm will concentrate its efforts to sell these instruments in markets such as scientific laboratories—traditionally strong areas for its sales—and Dana will continue

marketing the products itself.

The model 5900 is a 5½-digit (159,999-count) instrument with five dc voltage ranges from 0.1 to 1,000 v, full scale, four ac voltage ranges from 1 to 1,000 v, full scale, and eight resistance ranges from 10 ohms to 100 megohms, full scale.

The average-responding ac converter is an option priced at \$585; a true-rms converter is priced at \$480, and the four-wire resistance option is \$355. Any of the three options also requires a \$150 accessory card.

The model 6900 is a 6½-digit (1,600,000-count) instrument with five dc voltage ranges from 0.1 to 1,000 v full-scale. Resistance and ac voltage options are similar to those for the model 5900. Like the 4½-digit portable instruments, the two systems voltmeters are autoranging on all functions.

Keithley Instruments Inc., 28775 Aurora Road, Cleveland, Ohio 44139. Phone: (216) 248-0400. [339]

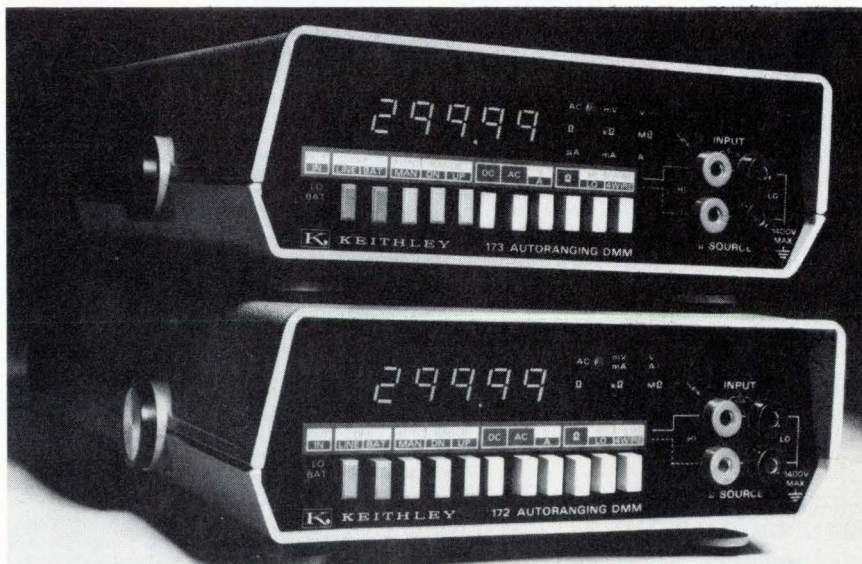



# “When the heat’s justify timesharing with paper.”

**Problem: Pressure. Temperature. Time. Until you define influential variables, your process is out of control.**

Trouble is, timeshare costs can also be an unknown quantity. And analyzing pounds of printout can bog you down for days. After all, the challenge in hundreds of programs and models lies in rapidly defining how each variable influences the end result. In finding the optimum operational range.

**Solution: Tektronix’ desktop Graphics system comes straight to the point.**

The 4051 speaks a graphically beefed-up BASIC ... supported by software packages like statistics, that lets you explore analyses of variance and linear and non-linear regression techniques with unequalled simplicity and interactivity. In integrated circuit production. Chemical analysis. Mathematical modeling. You name it.

**The 4051 puts you in command of up to 32K of problem-solving power**, with 300K bytes of built-in mag tape storage and optional on-line capability. You proceed directly from inputting data to outputting time plots, histograms, even three-dimensional renderings—without waiting for a processor or wading through printout.





# on, I can't and I can't wrestle



Tektronix' solutions-oriented software and library of graphics applications programs let you work at your own pace while you exploit the full interactivity of the 4051.



The 4051 Graphic Computing System is complemented by a complete line of plug-in peripherals like plotters, printers, hard copy and tape storage devices, memory extenders and data communications interfaces.

**Seeing is the simplest language of all.** Results you can see are results you can use ... immediately. You can explore more options, keep closer to the experiment. You can communicate graphic concepts more quickly, save them more compactly. It figures that Tektronix would be first to combine Graphics with desktop intelligence, since we've been the Graphics leaders for years.

**Take the heat off.** Personal 4051 Graphics starts at just \$6995.\* Your local Tektronix Sales Engineer can show you Graphics applications already underway in your field.

**Tektronix, Inc.**  
Information Display Group  
P.O. Box 500  
Beaverton, Oregon 97077  
**Tektronix Datatek NV**  
P.O. Box 159, Badhoevedorp  
The Netherlands

## Get the picture. Get total results.



Circle 133 on reader service card

\*U.S. Domestic Price Only



# Crydom enters low-cost SSR market

Leader in high-current solid-state relays introduces 2-ampere and 8-A units priced below \$5 in large quantities

by Larry Waller, Los Angeles bureau manager

Activity in low-cost solid-state relays is heating up. As demand swells for devices in the \$5 range, suppliers are pushing for early market position by bringing out new lines. The latest entries are from International Rectifier Corp.'s Crydom division—two new solid-state relays, a panel-mounted 8-ampere unit and a 2-A device packaged to occupy less than 0.4 cubic inch on printed-circuit boards. Both are to sell for around \$5 in quantity.

While not the first announcement of lower-cost solid-state relays [*Electronics*, Aug. 5, p. 120], the Crydom introduction holds particular significance because of the firm's market position—the division is said to supply about 50% of the 10-A-and-up solid-state relays. Under development for a year, the new Crydom products derive from an intensive market research program that led to some sharply defined conclusions. "The \$5-and-under figure keeps popping up," explains James P. Antrim, Crydom general manager, citing a thick stack of opinions from potential users. "We wanted to stretch down into the 10-A-and-under area, and our research has proved that the \$5 price itself will help develop this market." In fact, the new units "could in three years double our business," he adds.

With user research pinpointing objectives, Crydom concluded it could target nearly 90% of the low-cost market by coming up with just two new dc-input relays. "Since printed-circuit-board mounting is best and cheapest, we knew a miniature version would be important, but for free-standing uses, such as traffic controls, a heat-sink or panel-

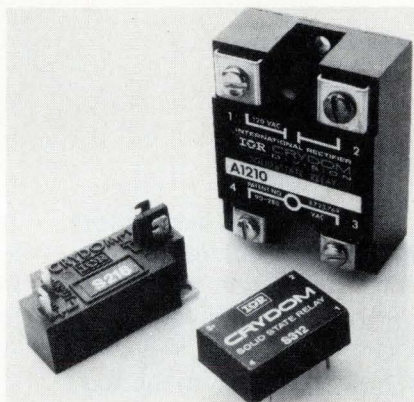

**Smaller.** Shown next to high-current standard package are new series 3 (2-ampere) and series 2 (8-A) solid-state relays.

mounted unit is required," says H. William Collins, who directed development of the new relays. He describes the 8-A series 2 and 2-A series 3 as complementary, with similar internal circuitry, and the basic difference as in the packaging. "An evening gown versus a bathing suit" is how he describes it. "The real distinction of the new relays comes from smaller packages and low cost, rather than in technical improvements."

In designing proprietary circuitry that is much simpler than that of higher-power relays, Crydom engineers have contributed to the series 3 many features that Collins and Antrim believe surpass anything else on the market, for the price.

In a flat-profile package  $\frac{3}{8}$  inch high, the series 3 achieves a full 2-A rating at 40 degrees celsius ambient without a heat sink. Also, the maximum surge current rating for 16.3 milliseconds (or one cycle) is 40 A rms, and for 1 second, 10 A rms. Both series are available in voltage

ratings of 120 and 240 volts ac, controlled directly by logic-level dc signals. Turn-on and turn-off is within one half cycle.

For the second product, Crydom, in building the 8-A series 2, "gave lots of attention to the external package." The dual-hole mounting for the less-than-1-cubic-inch unit provides a more reliable thermal contact than a single-hole version, claims Collins. Also, equivalent multipole operation can be obtained by stacking series 2 packages together. "Their high packing density and good terminal clearance enables harnessing them together to get the effect of multipole," he says.

Output characteristics of the series 2 include a surge current rating of 80 A rms for one 16.3-ms cycle, and 25 A rms for 1 second.

The design philosophy for the low-cost units was firm in trying to keep all possible advantages offered by the higher-priced Crydom solid-state package, Antrim and Collins maintain. "We decided not to bring out lower-priced relays at the expense of product quality by throwing out features," Antrim states. "After all, zero switching is a major reason why a customer buys solid state."

Additionally, the series 2 provides internal snubber circuits (RC networks) for limiting the rate of voltage across the triac.

Prices on the series 2 relay are \$12 for a single unit, \$5.90 in 1,000 quantities, and under \$5 for 10,000 and up. Series 3 sells for \$10 for one piece and \$4.90 for 1,000. Deliveries are from stock.

Crydom division, International Rectifier, 1521 Grand Ave., El Segundo, Calif. 90245. Phone (213) 322-4987 [340]



**It's savings time...**

## **Reduce Your Wiring Costs with TRW/Cinch Connectors Printed Circuit Back Panels**

Two-sided or multi-layer PC back panels, up to 24" square can be supplied, produced with the same expertise that has made TRW/Cinch Connectors aluminum back panels universally accepted.

You can save on connector costs too. Modularized edge connectors give you the exact number of positions and groupings that you need—without special charges. Terminals are 0.025" square on 0.100" x 0.200" or x 0.125" centers for 0.62" boards. 0.125" x 0.125" centers are also available for 0.047" boards.

You'll save on maintenance costs as well, because the unique Cinch preloaded contacts are individually replaceable without removing the insulators from the board. 100% continuity testing of the PC boards can be provided if desired.

For additional information on these and other TRW/Cinch Connectors back panel assembly services write: TRW/Cinch Connectors, an Electronic Components Division of TRW Inc., 1501 Morse Ave., Elk Grove Village, IL 60007 phone (312) 439-8800.

CC-7609

**TRW** *CINCH CONNECTORS*

ANOTHER PRODUCT OF A COMPANY CALLED TRW



# ALL ABOARD! WAFERTRAC IS NOW ON LINE.

**Total microprocessor control of wafer processing for the first time.**

**Higher yields, yet requiring less facility space.**

**Up time and reliability higher than ever before.**

**No more limit to 25-wafer group processing.**

It's already the talk of the industry. Wafertrac—the completely automatic transportation of wafers on patented air bearings through the total process without human intervention.

WAFERTRAC. The microprocessor-controlled system that allows you to arrange your own production line configuration with minimum facility space restrictions. Like a model railroad train, you route your wafers through whatever directional path you choose.

WAFERTRAC. The first practical application of the microprocessor to semiconductor fabrication, requiring only *one* person to attend your line for loading and unloading purposes.

WAFERTRAC. The multi-batch processing of up to 5" wafers under a Master Controller that can direct up to 256 peripheral modules and even "talk" to other controllers or central computers in remote sites.

WAFERTRAC. With a total software library to design your own BAKE, SCRUB, COAT and DEVELOP cycles *automatically*, plus CRT displays of any individual wafer's process parameters.



Don't be left at the station. Get on board WAFERTRAC now to keep your fab line going in the right direction.

WAFERTRAC. Not just the new generation. The whole future of wafer processing. See Wafertrac at Booth #335-346; SEMICON, May 25-27

**GCA/SUNNYVALE DIVISION ●●▲**

1050 Kifer Road, Sunnyvale, CA 94086 (408) 732-5330 TWX: 910-339-9211

Circle 136 on reader service card



---

## New products

---

Microprocessors

# Product-line gaps filled

---

Chips and boards challenge minis; analog interfaces, tutorial system arrive

---

As the microprocessor matures and chip families establish themselves, suppliers are becoming less inclined to introduce new families that overlap existing ones and instead are busy filling gaps in their product lines. Two examples of these second-level processor introductions are Texas Instruments' new 9980 8-bit microprocessor, a lower-performance addition to TI's powerful 9900 family, and National Semiconductor's new very powerful bipolar single-board version of its popular PACE microprocessor. Both devices are intended to extend the range of useful applications within the family—TI with the 9980 moving down from the 16-bit minicomputer level of its 9900 central processing unit and National with its Super-Pace moving up from the high-end control market of PACE into the mainstream of minicomputer design.

Indeed, the TMS 9980 is intended to serve that large group of applications that have formed around general-purpose 8-bit systems such as the 8080 and 6800—including those in industrial control, point-of-sale, and small data-processing equipment that could not take full advantage of the power of the 16-bit TMS 9900. The TMS 9980, however, is structured just right—its 8-bit data bus enables it to handle all byte-oriented microprocessor memories used in these applications, yet like the TMS 9900, its 16-bit central processing unit can execute the entire 9900 instruction set, including such tough ones as hardware multiply and divide.

Consequently, users familiar with the CPU and instruction set of the 9900 can move at once into 8-bit

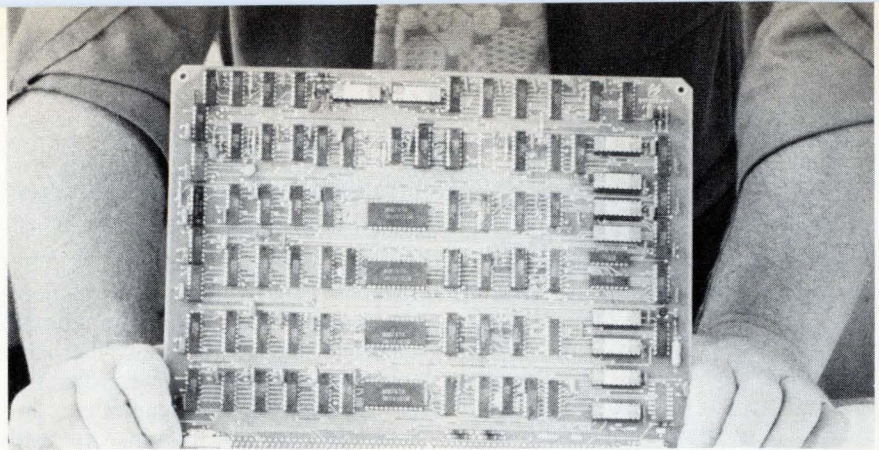

**Super-Pace.** National's Schottky-TTL 16-bit machine has a set of 75 instructions.

control applications and still preserve much of the computing power and flexibility inherent in the family. For example, the TMS 9980 has the same flexible input/output structure as the TMS 9900, offering features such as direct memory access, memory mapped I/O, and serial I/O (through an on-chip communications register unit) that are not generally available in other 8-bit families. The 9980 also provides six levels of interrupt, or enough to do some real-time data processing. The chip also contains the oscillator and clock generator, common features on other 8-bit chips but not included on the 9900 CPU.

Sample quantities of the TMS 9980 will be available in October.

In addition to the new 8-bit processor, TI is also filling out its 9900 family with four peripheral chips that are designed to work with both the 9900 and 9980 CPUs. They are the TMS 9901 programable systems interface, the TMS 9902 asynchronous communications controller, the TMS 9903 synchronous communications controller, and the TMS 9904 four-phase clock generator and driver. The last chip is already available in samples, the first and second will be available in the fourth quarter, while the third is scheduled for the first quarter of 1977.

**The one-board mini.** On the other hand, aiming upward into the mainstream of minicomputer design with its one-board CPU meant that National engineers had to go to a multi-package bipolar design. That was the only way to get the speed and instruction-handling flexibility needed for these general-purpose data processing jobs, which are

beyond the range of single-board MOS computers but below the most comfortable performance level of full minicomputers.

The new unit, called Super-Pace, is a Schottky bipolar transistor-transistor-logic enhancement of National's 16-bit p-channel MOS PACE microprocessor. National designers have expanded PACE's original set of 45 instructions to 75. The larger set, according to Dale Mrazek, manager of bipolar microprocessor design, combines some of the best instruction features of one-board units, like Digital Equipment Corp.'s LSI-11 and Data General Corp.'s microNova, and high-end multi-board minicomputers like Data General's Eclipse. Super-Pace executes 16-bit instructions similar to those of the LSI-11 and microNova, in half their time. It also executes more sophisticated instructions, such as normalize, double-precision add, double load, multiply and divide, in roughly the same times as an Eclipse.

In addition to the clock generator, the timing and control portion of the board contains eight 2,048-bit read-only memories for microprogram storage of the 75 instructions, seven to 10 decode ROM packages and five to seven tristate counters for microprogram address control. The other 40 to 50 chips perform the I/O control, address register, and I/O

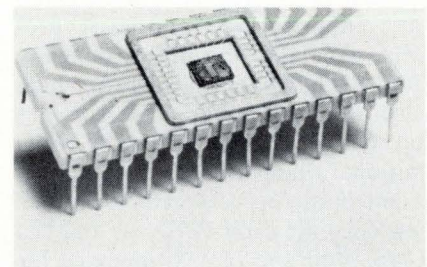

**Dedicated.** ITT's 7150 is a low-cost 4-bit unit for special-purpose applications.



## New products

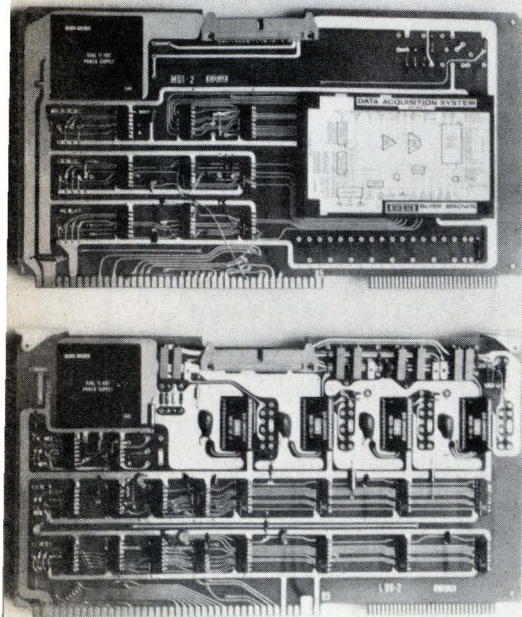

**Interface.** Burr-Brown's analog I/O boards connect microcomputers with the outside.

low-cost high-volume control jobs that need no external random-access memory for storing data. The part, which was developed in Europe and is now available here, comes in a 24-pin ceramic or 18-pin DIP and requires about eight weeks of lead time for special programs; many standard programs are obtainable off the shelf.

**Analog interface.** While microprocessor manufacturers are filling holes in established product lines, analog-circuit manufacturers are starting up completely new lines: analog subsystems that work directly with microprocessors. This is a sorely needed capability. Till now, designers of microprocessor-based data-acquisition systems have had to spend much time and money finding the correct interface logic and drive circuits needed to make analog components, such as converters, operational amplifiers, and signal conditioners, play with the computers.

The most interesting of these analog subsystems are Burr-Brown's single-board analog input and output channels that are available for the two most popular microprocessors—the 8080 and 6800 systems. For the 8080 there are two input boards, MP 8408 and MP 8416, and one output board, MP 8304, all of which also work with Intel's MDS 800 microcomputer-development system and SBC 80/10 8-bit single-board microcomputer. For the 6800, there are also two input boards, MP 7208 and MP 7216, and one output board, MP 7104, which work with Motorola's Exorcizer development system and other 6800 system designs.

Ease of use was the goal in designing these units, which are made up from Burr-Brown's standard converter and op amp product line, such as the SDM 850, 851 and 853 modular data-acquisition systems. They are packaged on pc boards that are electrically and mechanically compatible with the microcomputer specified. Moreover, the fact that each analog system is treated simply as memory I/O by the

data buffer functions.

National is also offering a six-slot card-cage prototyping system using the Super-Pace CPU card, a 16k-by-16 dynamic RAM card, an 8k-by-16 ultraviolet-erasable PROM card; I/O with two RS-232 ports, and a floppy-disk interface card.

According to Mrazek, the prototyping system is configured to operate with either a cathode-ray-tube terminal or teletypewriter as the I/O device for system debugging. An assembler and a PACE to Super-Pace cross-assembler will soon be added.

Price of the prototyping system without the floppy interface is about \$4,500. A complete dual floppy system with the interface will sell for about \$3,700.

**The dedicated micro.** On the opposite end of the performance scale is ITT's entry into the microprocessor market—a low-cost 4-bit chip that's earmarked for special-purpose industrial-control and home-appliance applications. The 7150 has enough ALU, input/output, and ROM program capability to implement many simple controller jobs for which general-purpose microprocessors are too powerful and expensive. Like National's new family of calculator-oriented microprocessors, Rockwell's new one-chip 4-bit PPS 4/1, and TI's TMS 1000, the 7150 is intended for

## Texas Instruments 4K RAM Distributors

**ALABAMA:** Huntsville, Hall-Mark Electronics, (205) 837-8700.  
**ARIZONA:** Phoenix, Cramer/Arizona, (602) 263-1112, Kierulff Electronics, (602) 273-7331, R. V. Weatherford Co., (602) 272-7144.  
**CALIFORNIA:** Anaheim, R. V. Weatherford Co., (714) 633-9633, El Segundo, TI Supply Company, (213) 973-2571, Glendale, R. V. Weatherford Co., (213) 849-3451, Goleta, Radio Product Sales, Inc., (805) 964-6823, Inglewood, Time Electronics, (213) 649-6900, Irvine, Cramer/Los Angeles, (714) 979-3000, (213) 771-8300, Los Angeles, Kierulff Electronics, (213) 685-5511, Radio Product Sales, Inc., (213) 748-1271, Mountain View, Time Electronics, (415) 965-8000, Palo Alto, Kierulff Electronics, (415) 968-6292, R. V. Weatherford Co., (415) 493-5373, Pomona, R. V. Weatherford Co., (714) 623-1261, San Diego, Cramer/San Diego, (714) 565-1881, Kierulff Electronics, (714) 278-2112, Radio Product Sales, Inc., (714) 292-5611, R. V. Weatherford Co., (714) 278-7400, Sunnyvale, Cramer/San Francisco, (408) 739-3011, TI Supply Co., (408) 732-5555, Woodland Hills, Semiconductor Concepts, (213) 884-4560.  
**COLORADO:** Denver, Cramer/Denver, (303) 758-2100, Kierulff Electronics, (303) 371-6500, Englewood, R. V. Weatherford Co., (303) 761-5432.  
**CONNECTICUT:** Hamden, Arrow Electronics, (203) 248-3801, North Haven, Cramer/Connecticut, (203) 239-5641, Orange, Milgray/Connecticut, (203) 795-0714.  
**FLORIDA:** Ft. Lauderdale, Arrow Electronics, (305) 776-7790, Hall-Mark Electronics, (305) 971-9280, Hollywood, Cramer/Hollywood, (305) 923-8181, Orlando, Cramer/Orlando, (305) 894-1511, Hall-Mark Electronics, (305) 855-4020, Winter Park, Milgray Electronics, (305) 647-5747.  
**GEORGIA:** Atlanta, Cramer/Atlanta, (404) 448-9050.  
**ILLINOIS:** Arlington Heights, TI Supply Company, (312) 593-7660, Chicago, Newark Electronics Corp., (312) 638-4411, Semiconductor Specialists, (312) 279-1000, Mt. Prospect, Cramer/Chicago, (312) 593-8230.  
**INDIANA:** Indianapolis, Graham Electronics, (317) 634-8202.  
**IOWA:** Cedar Rapids, Deeco Incorporated, (319) 365-7551.  
**MASSACHUSETTS:** Billerica, Kierulff Electronics, (617) 667-8331, Newton, Cramer/Newton, (617) 969-7700, Waltham, TI Supply Company, (617) 890-0510, Woburn, Arrow Electronics, (617) 933-8130.  
**MARYLAND:** Baltimore, Arrow Electronics, (202) 737-1700, Columbia, Technico Incorporated, (301) 461-2200, Gaithersburg, Cramer/Washington, (301) 948-0110, Kierulff Electronics, (301) 948-0250, Hyattsville, Milgray/Washington, (301) 864-1111.  
**MICHIGAN:** Detroit, Newark Electronics Corp., (313) 967-0600, Wyoming, Newark Electronics Corp., (616) 241-6681.  
**MINNESOTA:** Bloomington, Arrow Electronics, (612) 888-5522, Edina, Cramer/Minnesota, (612) 835-7811, Minneapolis, Semiconductor Specialists, (612) 854-8841.  
**MISSOURI:** Kansas City, LCOMP-Kansas City, Inc., (816) 221-2400, Semiconductor Specialists, (816) 452-3900, Hazelwood, Semiconductor Specialists, (314) 731-2400, St. Louis, LCOMP-St. Louis, Inc., (314) 647-5505.  
**NEW JERSEY:** Camden, General Radio Supply Co., (609) 964-8560, Cherry Hill, Cramer/Pennsylvania, (215) 923-5950, (609) 424-5993, Milgray/Delaware Valley, (609) 424-1300, (215) 228-2000, Clark, TI Supply Company, (201) 382-6400, Moonachie, Cramer/New Jersey, (201) 935-5600, Moorestown, Arrow Electronics, (609) 235-1900, Rutherford, Kierulff Electronics, (201) 935-2120, Saddlebrook, Arrow Electronics, (201) 797-5800.  
**NEW MEXICO:** Albuquerque, Cramer/New Mexico, (505) 265-5767, R. V. Weatherford Co., (505) 842-0863.  
**NEW YORK:** East Syracuse, Cramer/Syracuse, (315) 437-6671, Farmingdale, Arrow Electronics, (516) 694-6800, Fishkill, Arrow Electronics, (914) 896-7530, Freeport, Milgray Electronics, (516) 546-6000, (201) 432-4300, Hauppauge, Cramer/Long Island, (516) 231-5600, Semiconductor Concepts, (516) 273-1234, Rochester, Cramer/Rochester, (716) 275-0300, Rochester Radio Supply Co., (716) 454-7800.  
**NORTH CAROLINA:** Raleigh, Hall-Mark Electronics, (919) 832-4465, Winston-Salem, Cramer/Winston-Salem, (919) 725-8711.  
**OHIO:** Cleveland, Arrow Electronics, (216) 464-2000, Cramer/Cleveland, (216) 248-8400, Dayton, ESCO Electronics, (513) 226-1133, Kettering, Arrow Electronics, (513) 253-9176.  
**OKLAHOMA:** Tulsa, TI Supply Company, (918) 437-4555.  
**OREGON:** Portland, Almac/Stroom Electronics, (503) 292-3534.  
**TEXAS:** Dallas, TI Supply Company, (214) 238-6830, Houston, Harrison Equipment Co., (713) 652-4700, TI Supply Company, (713) 777-6011, R. V. Weatherford Co., (713) 688-7406.  
**UTAH:** Salt Lake City, Standard Supply Company, (801) 355-2971.  
**WASHINGTON:** Seattle, Almac/Stroom Electronics, (206) 763-2300, Kierulff Electronics, (206) 763-1550.  
**WISCONSIN:** New Berlin, Arrow Electronics, (414) 782-2801, Wauwatosa, Semiconductor Specialists, (414) 257-1330.  
**CANADA:** Calgary, Canadian Electronics LTD, (403) 287-1800, Downsview, CESCO Electronics LTD, (416) 661-0220, Cramer/Canada, (416) 661-9222, Edmonton, Canadian Electronics LTD, (403) 452-9393, Montreal, CESCO Electronics LTD, (514) 735-5511, Future Electronics, (514) 735-5775, Zentronics LTD, (514) 735-5361, Ottawa, CESCO Electronics LTD, (613) 729-5118, Future Electronics, (613) 232-7757, Zentronics LTD, (613) 238-6411, Quebec City, CESCO Electronics LTD, (418) 524-4641, Rexdale, Future Electronics, (416) 677-7820, Toronto, Zentronics LTD, (416) 789-5111, (416) 787-1271, Vancouver, Canadian Electronics LTD, (604) 324-7911, Future Electronics, (604) 261-1335, Winnipeg, Canadian Electronics LTD, (204) 947-1321.

TEXAS INSTRUMENTS  
INCORPORATED



# Is Your Memory Design Static?

Make Your Designs Dynamic.

Texas Instruments TTL Compatible 4K RAMs Make It Easy...

## HERE'S WHY DYNAMIC DESIGNERS USE TI 4K RAMs.

### ✓ 36% Less Operating Power

Compare 1K low-power static RAMs with TI's TMS 4051 4K dynamic RAM. The table refers to maximum—not typical—values to provide a realistic comparison.

### ✓ 40% Less Standby Power

Low standby power is inherent in the 4K dynamic RAM operation—while static RAMs require extra circuitry to reduce  $V_{cc}$  to a low level.

### ✓ Fully TTL Compatible

The TMS 4051 inputs and output (including clock) interface directly with TTL.

### ✓ Fast Access Time

TI's 4K dynamic RAMs are fast. The TMS 4051-1 (with TTL clock) has a maximum access time of 250 ns, the

Parameter	Four 1K Static RAMs (2102 AL-2)	One 4K Dynamic RAM (TMS 4051-1)
Power (max.) operating	1368 mW	882 mW
standby	168 mW	101 mW
Access (max.)	250 ns	250 ns
Board area ratio	3.6	1.0
Fully TTL compatible	yes	yes
100 Pc prices	\$20.00	\$12.26

Based on published data

same as the 2102AL-2.

### ✓ 80% Less Board Area

You get almost four times the memory density by switching to TI 18-pin 4K RAMs. The reason? TI's compact 18-pin 300-mil-wide package—available in either plastic or ceramic.

### ✓ Lower Cost

TI's 4K dynamic RAM offers significant system cost savings even when including the additional simple circuitry for refresh.

### ✓ Simple Refresh

It's easy! Just 4-8 TTL packages per memory system are typically needed. To see how easy refresh can be, send for our Application Note.

### ✓ Easy to Use

TI's 18-pin 4K RAMs feature simple 12-line non-multiplexed address and a single non-critical clock. Data input and output are multiplexed—ideal for use with microprocessor-based systems.

### ✓ Applications Help

For your copy of the 4K dynamic RAM Application Note covering simple refresh, contact: Texas Instruments, M/S 669-4K, P.O. Box 1443, Houston, Texas 77001.



TEXAS INSTRUMENTS  
INCORPORATED



# VICTOREEN WRAPS HIGH VOLTAGE PERFORMANCE IN SLIM-MOX PACKAGES.

Victoreen's SLIM-MOX is the small, flat substrate, high voltage resistor that saves you space with no sacrifice in performance.

That's because small size is only one of many SLIM-MOX features.

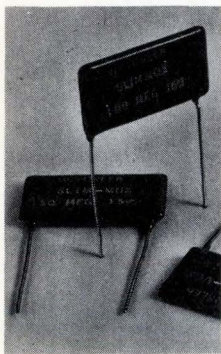

Designed into your high voltage circuits, SLIM-MOX will deliver better long term stability. You will appreciate its small temperature co-

efficients over a wide temperature range.

Switch to SLIM-MOX, the rugged and highly stable resistor now available in an expanded resistance range — 1 to 5,000 M. Tolerances to 1%.

Standard values are available from stock. And at any value, Victoreen quality is a built-in SLIM-MOX virtue. Find out for yourself by using SLIM-MOX wherever you need to save space in high voltage circuitry. Wherever stability and reliability are key performance characteristics.

**Victoreen Instrument Division,  
Sheller-Globe Corporation,**



**10101  
Woodland  
Avenue,  
Cleveland,  
Ohio 44104**



SHELLER-GLOBE CORPORATION

RESISTOR SPECIFICATIONS			
Model	SLIM-MOX 204	SLIM-MOX 208	SLIM-MOX 308
Resistance Range	1M- 5,000M	2M- 5,000M	5M- 5,000M
Critical Resistance	50M	56.25M	64.8M
Power Rating at 70° C	2W	4W	5W
Maximum* Operating Volts	10,000V	15,000V	18,000V
Available Tolerance	1% 5% 15%	1% 5% 15%	1% 5% 15%
Max. Surface Temp.	150°C	150°C	150°C

\*Applicable above critical resistance

MAXIMUM DIMENSIONS (inches)			
Model	204	208	308
A	1.08	2.08	2.08
B	.59	.59	.89
C	.145	.145	.145
D	.860	1.885	1.885

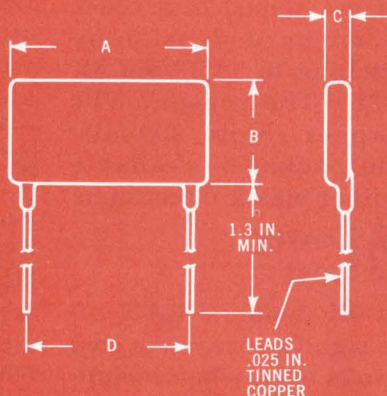

## New products

microcomputer greatly simplifies programming.

Input boards come in either an eight-channel differential-input version or a 16-channel single-ended-input version. They include an input multiplexer, instrumentation amplifier, sample-and-hold, and 12-bit a-d converter along with all the necessary timing, decoding and control logic. The model 546 dc-dc converter (+5 v to ±15 v) is also used so that only the microcomputer's +5-v dc power supply is required.

The analog-output systems provide four analog-output channels (using four of Burr-Brown's hybrid 12-bit DAC80 d-a converters). These boards also contain the 546 dc-dc converter for operation on +5-v dc power. The input of the d-a converters is double-buffered so that a complete 12-bit word can be strobed into a d-a converter's input register to minimize output glitches.

**Converters.** Other suppliers of analog devices are introducing converter products that are also directly compatible with standard microprocessors. Datal Systems Inc., Canton, Mass., for example, is supplying converter boards for 8080 computers; the a-d boards have 16 differential analog inputs or 32 single-ended inputs, while d-a boards have four channels plus a dc-to-dc converter or eight channels without it.

While Datal's boards, like Burr-Brown's, use the same pc-board form factor as Intel Corp.'s new SBC 80/10 and Inteltec systems (and so can be directly inserted), there is a significant difference between the ways in which a user addresses them. Burr-Brown treats the boards as memory locations; this simplifies programming, since the user need only designate an allocated memory address to issue a conversion command, but it also requires a memory address for each conversion. Datal addresses the analog board through the data bus and allows the user to give addresses for the beginning and end of the scan, so that the board can perform the transfers without further addressing.

**For the novice.** Intersil Inc. has started shipping a low-cost battery-



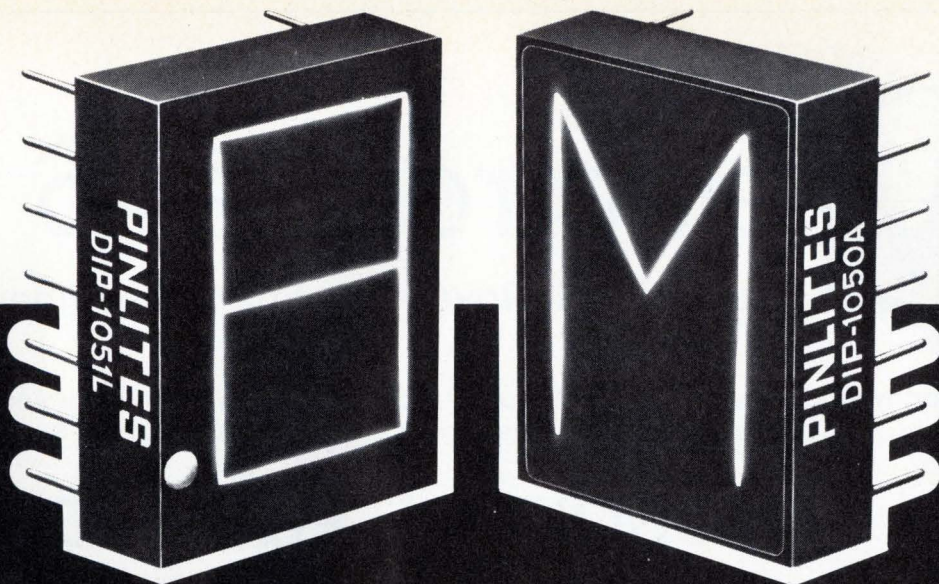

# Pinlites® Displays may be Over-Designed for you.

It's possible. Pinlites incandescent displays are the best in the world. While you may not need every feature we offer, that decision depends on your application. Here are the facts. Now you decide.

## Brightness

Directly-viewed incandescent design makes Pinlites displays ideal for high ambient light situations. Models are available to an incredible 9000 ft. lamberts. And with simple voltage reduction they can easily be dimmed for night use. High contrast ratio insures clear character definition in a 10,000 ft.-candle incident light condition.

## Viewing Angle

120°. Unusually wide because Pinlites are directly-viewed and do not require a magnifying lens.

## Life

Over 100,000 hours per segment.

## Corner Illumination

Pinlites' patented cross-over filament arrangement compensates for the heat sink effect of the filament post. This feature eliminates open corners characteristic of other display types.

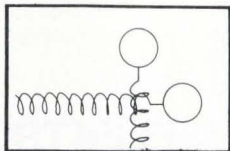

## Electrical Configuration

Pinlites operate on 1.5 to 5 volts and are directly compatible with standard TTL driving networks. They use as little as 8 milliamps per segment and are easily multiplexed. Available in various socket configurations, including 14 pin DIP and 24 pin DIP on the displays shown above. Character heights:  $\frac{3}{16}$ ",  $\frac{1}{4}$ ",  $\frac{5}{16}$ ",  $\frac{1}{2}$ ",  $\frac{5}{8}$ ".

## Filter Requirements

Pinlites produce a bright "white" light. You can filter to a wide range of colors and still maintain excellent readability.

## Applications

Pinlites are particularly desirable for applications requiring brightness and high reliability over a wide range of environmental conditions. Popular uses include aircraft cockpits, marine navigation, computer peripheral equipment, taxi meters and gas pump read-outs.

Call now. We'll have literature in the mail to you today.



**REFAC** electronics corporation

P.O. BOX 809 • WINSTED, CONN. 06098 • 203-379-2731



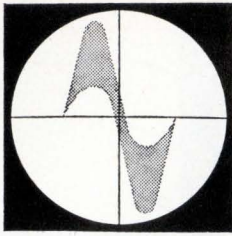

# electronica 76



Munich, 25 November to 1 December 1976

Noteworthy among the technical sessions accompanying this most important gathering of electronics engineers in the world is the International Symposium on

## MICROWAVE ENGINEERING

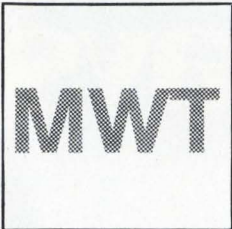

Scheduled to be held from 23 to 26 November in the conference room K 1 at the Munich Fair Grounds. This event is dealing with the state of the art and future trends. Pertinent documentation will be available. Lectures and discussions with simultaneous translation. There are no parallel sessions.

The 26 speakers from industry and research are leading experts in Europe and overseas.

Participants have also the possibility to select single days for specific information and discussion about

**Measurements** in the microwave range, 23 November  
**Components and devices** (active/passive), 24 November  
**Antennae** (including a field trip), 25 November  
**Microstrip technology**, 26 November

The participation fee amounting to DM 105,— per day includes access to the exhibition halls where, among others, some 130 companies\*) from the microwave field will present the latest components and allied devices.

\*) On 20 August 1976, the total number of exhibitors at electronica 76 exceeded 1000.

For further information about this International Symposium on Microwave Engineering please apply to the



## INTERNATIONALES ELEKTRONIK ZENTRUM

Münchener Messe- und Ausstellungsgesellschaft mbH, Messegelände,  
P.O.Box 12 10 09, D-8000 München 12, Phone: (089) 51 07-464



## New products

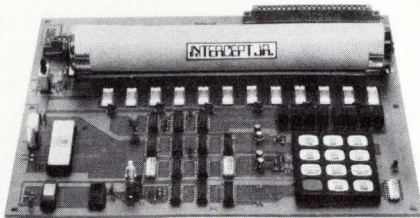

**Intercept Jr.** Intersil's system familiarizes users with its 12-bit C-MOS IM6100.

powered tutorial system, called Intercept Jr., for the evaluation of its IM6100 complementary-metal-oxide-semiconductor 12-bit microcomputer. The Intercept Jr. 6950 module, which recognizes the instruction set of Digital Equipment Corp.'s PDP-8, provides an all-C-MOS computer on a 10-by-11-inch double-sided printed-circuit board. A multiple-function calculator-type keyboard, in concert with a 1,024-by-12-bit C-MOS ROM (IM6312) monitor, provides control functions, while memory addresses and data are displayed in octal on two 4-digit light-emitting-diode displays.

The IM6100 C-MOS microprocessor interfaces via a three-state bus with 256 by 12 bits of C-MOS RAM. Four "D"-type cell batteries allow for nonvolatile RAM and battery operation.

External terminals will permit the user to provide a 5- or 10-v power source. The 10-v supply, in conjunction with changing the crystal to 8 megahertz, permits evaluation of the Intersil high-speed or "A" version of the 6100 components. A socket is provided for evaluation of a user-generated C-MOS ROM (the IM6312/12A). Three edge connectors are provided for expansion with optional boards.

Burr-Brown, P.O. Box 11400, Tucson, Ariz. 85734. [363]

Datel Systems Inc., 1020 Turnpike St., Canton, Mass. 02021. [364]

Intersil, Inc., 10900 North Tantau Ave., Cupertino, Calif. 95014 [365]

ITT Semiconductors, Commerce Way, Woburn, Mass. 01801 [366]

National Semiconductor Corp., 2900 Semiconductor Drive, Santa Clara, California 95051 [367]

Texas Instruments Inc., P.O. Box 5012, MS/84, Dallas, Texas 75222. Attn: "9900 Family" [368]

# Our newest air variable capacitor's biggest feature:



**It's small size.**

As you can plainly see, our new air variable capacitor is nearly as small as many sub-miniature ceramic trimmers. It also features the same mounting configuration which means you can use it in many of the same applications

But small size isn't the only reason for buying our new Micro T™ capacitor. Because it's air variable, it offers you

great stability. Q is typically 1000 at 100 MHz. TC is  $\pm 45$  PPM/°C. And it's available in maximum capacities of 3, 6.5, 12.7, and 19.0 pF in either vertical or horizontal tuning PC and stripline mounting versions. What's more, it gives you all this for a very small price.

E. F. Johnson Company/Dept. EL, Waseca, MN 56093

Please send me technical information on sub-miniature air variable capacitors.

Please send me samples. You can call me at \_\_\_\_\_

Name \_\_\_\_\_

Firm \_\_\_\_\_

Address \_\_\_\_\_

City \_\_\_\_\_ State \_\_\_\_\_

Zip \_\_\_\_\_

For fast service, contact your local Johnson Distributor.



**JOHNSON**  
®



# Some of these components will probably

SNAP-ACTION V3, 3M AND 5X SWITCHES PROVIDE HIGH RELIABILITY AND ARE CAPABLE OF HANDLING HIGH OR LOW ENERGY CIRCUITS; PROVIDE OUTSTANDING PERFORMANCE FOR SELECTION, TIMING AND DISPENSING FUNCTIONS IN VENDING MACHINES.

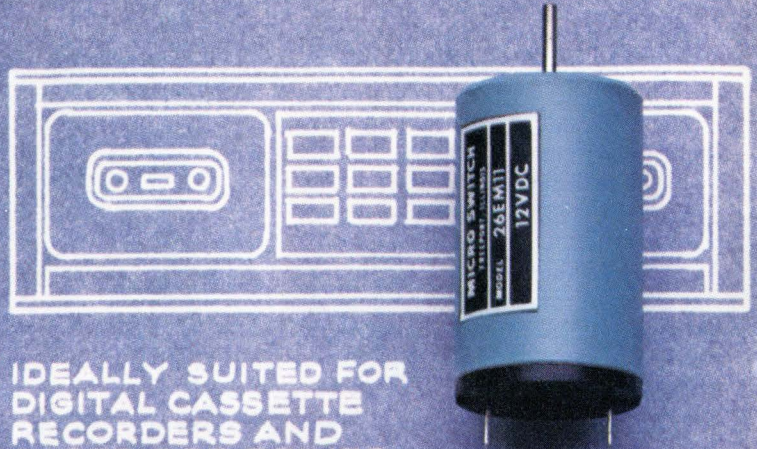

IDEALLY SUITED FOR DIGITAL CASSETTE RECORDERS AND CARTRIDGE DRIVES, THE 26 EM MOTOR USES A HOLLOW ROTOR TO PROVIDE THE LOWEST POSSIBLE ROTOR MASS, RESULTING IN VERY LOW INERTIA, DIRECTLY INTERCHANGEABLE WITH MOTORS MADE OUTSIDE USA.

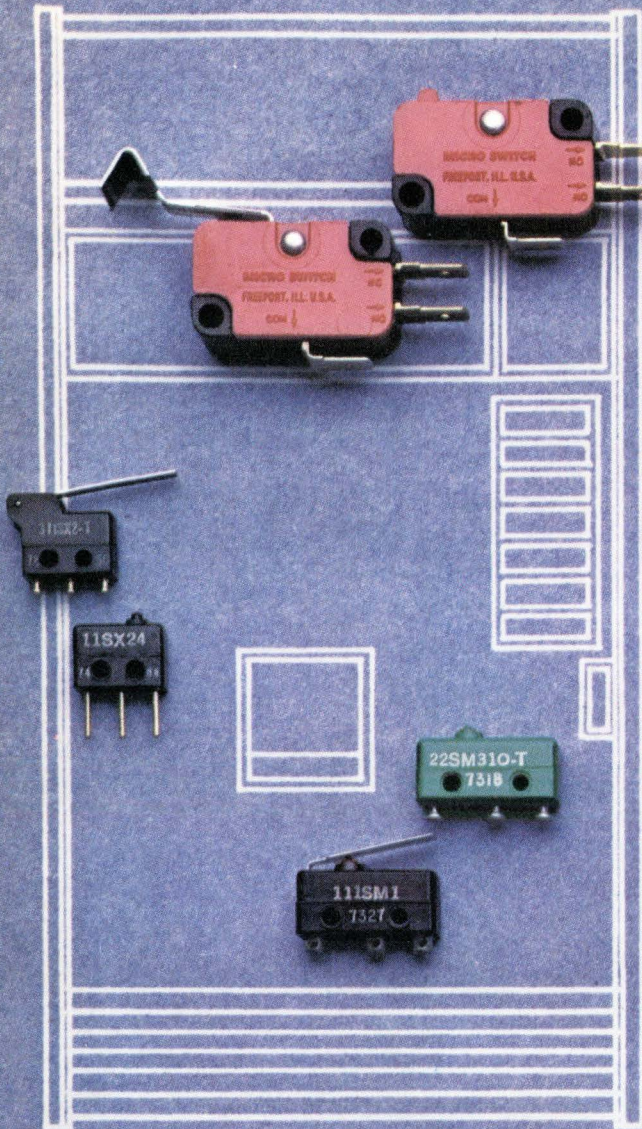

MINIATURE SERIES 8 SWITCHES PROVIDE THE ATTRACTIVE APPEARANCE, SMALL SIZE AND RELIABILITY NEEDED FOR HAND-HELD DIGITAL TIMERS. OFFER A WIDE VARIETY OF OPERATORS INCLUDING TOGGLES, PADDLES, PUSHBUTTONS, LIGHTED AND UN-LIGHTED ROCKERS.

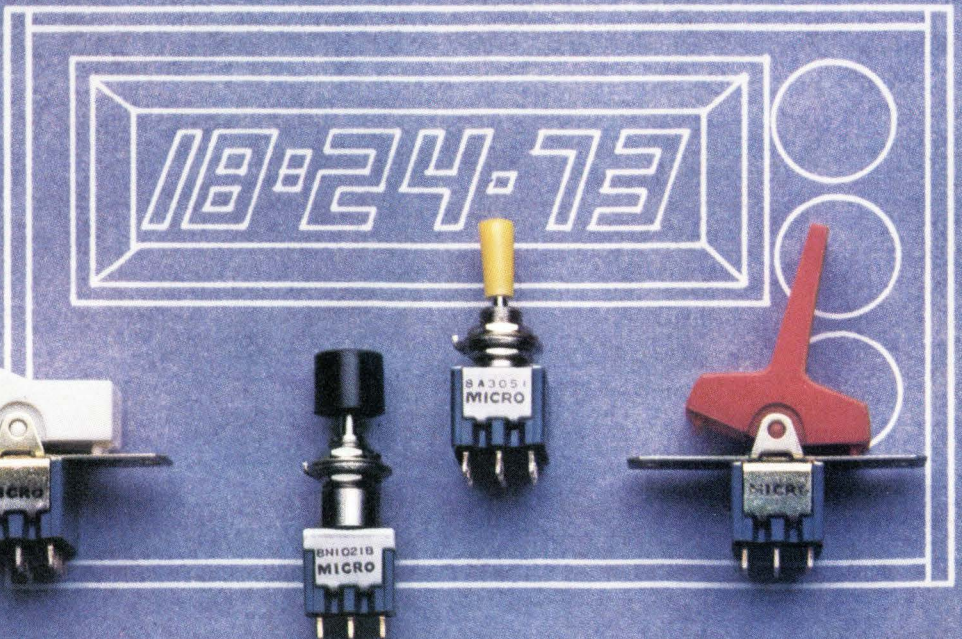



**never wear out. The others will just come close.**

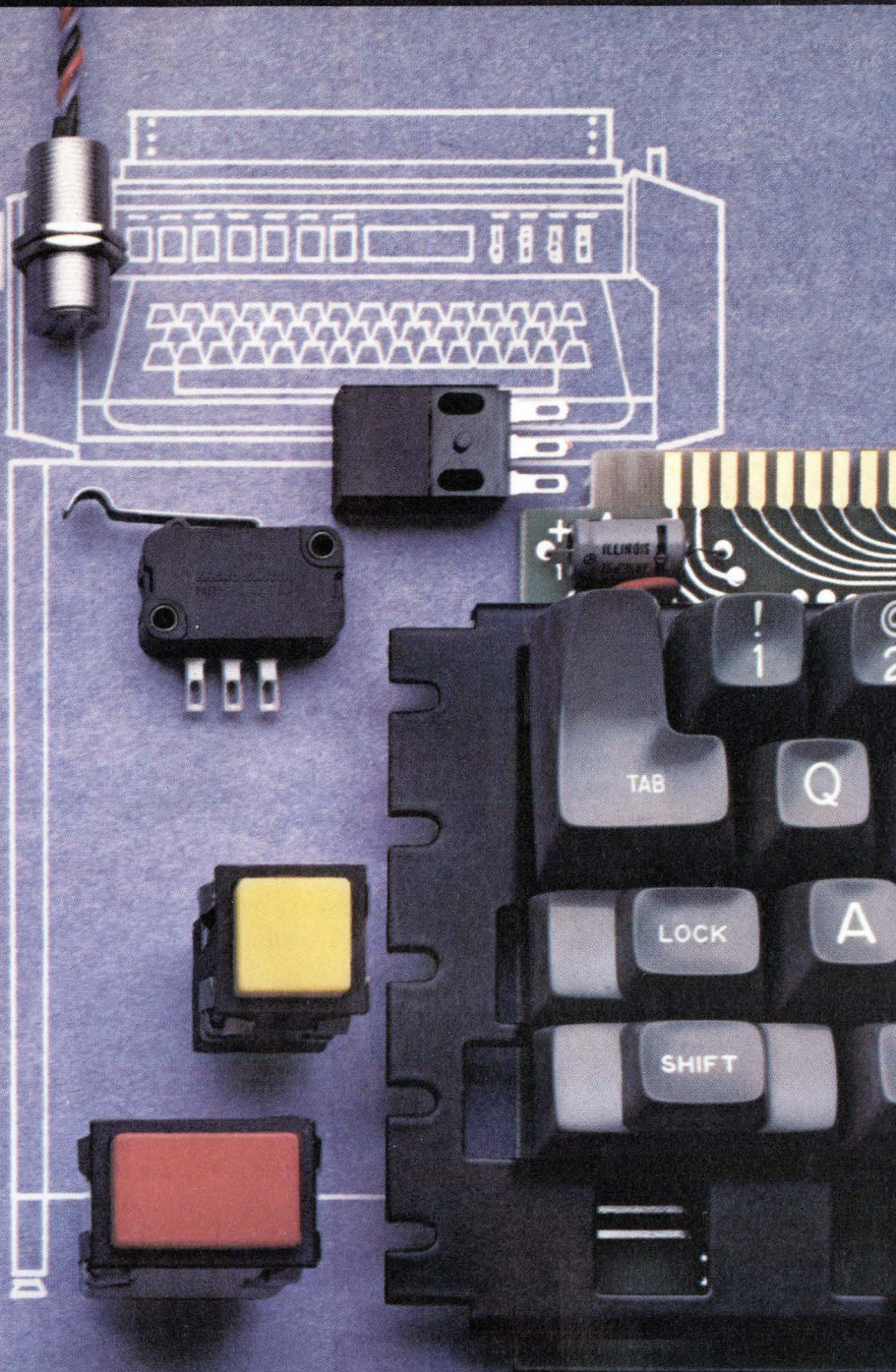

MICRO SWITCH COMPONENTS ARE IDEALLY SUITED FOR APPLICATIONS LIKE THIS PRINTER AND OTHER COMPUTER PERIPHERAL EQUIPMENT. FOR INSTANCE, THE SD KEYBOARD OFFERING HIGH RELIABILITY, LOW PROFILE AND LOW COST; THE AML LIGHTED PUSHBUTTONS, FEATURING QUALITY APPEARANCE AT A LOW COST, ELECTRICAL FLEXIBILITY, INCLUDING SOLID STATE VERSIONS; PLUS A COMPLETE LINE OF SOLID STATE POSITION SENSORS OFFERING ALMOST INFINITE LIFE AND COMPATIBILITY WITH COMPUTER LOGIC.

The solid state keyboard, AML lighted pushbuttons and solid state position sensors you see here will probably never wear out. Because they're all solid state.

Each is based on a Hall effect integrated circuit. A circuit that's been tested through billions of operations without failing. Even once. And proven by performance in a variety of applications. The other components you see here come close. Simply because of the way they're designed and put together.

Like the long-life versions of our snap-action V3, SM and SX precision switches. Available in a wide variety of sizes, electrical capabilities and ratings, terminals, actuators, contact forms and operating characteristics—they've been tested to a mechanical life of over 10,000,000 operations.

Or the Series 8 miniature manual switches. Designed with epoxy-sealed terminals on most versions for extra reliability. And offered with virtually any operator you might need. Plus terminals that include solder, quick-connect, printed circuit or wire-wrap.

The same standards of quality and product flexibility go into the 26EM DC motor. It's a miniature motor designed with low inertia operational characteristics. And just one of a line that ranges up to the 500VM, a motor capable of accelerating to 4000 RPM and stopping over 1000 times per second.

If you'd like more information on any of these components, contact your nearest MICRO SWITCH Branch Office or Authorized Distributor.

And find out how you can get a component that goes on forever. Or at least comes very, very close.

**MICRO SWITCH**

FREEPORT, ILLINOIS 61032

A DIVISION OF HONEYWELL

MICRO SWITCH products are available worldwide through Honeywell International.

Circle 250 for data,  
145 for salesman call



# NEW A/D CONVERTER combines:

- **ULTRA-HIGH-SPEED**  
[100 MHz per sec.]
- **VERY HIGH RESOLUTION**  
[6-bit binary or 2's complement output]
- **EXCEPTIONAL ACCURACY**  
[ $\pm 0.75\% \pm \frac{1}{2} \text{LSB}$ ]



New ADC1106-100 is a fully-assembled, tested and calibrated "system-ready" module.

Phoenix Data's new Model ADC1106-100—combining ultra-high-speed (100 MHz per sec.), very-high resolution (6-bit binary or 2's complement output), with exceptional accuracy ( $\pm 0.75\% \pm \frac{1}{2} \text{LSB}$ )—make it a favorite with equipment designers everywhere.

The ADC1106-100 is a totally self-contained unit for digitizing ultra-high-speed display and radar signals. The converters strobed, parallel conversion technique provides a unique sample-and-hold feature with exceptional repeatability, linearity, and monotonicity.

If it's stability, accuracy, speed, or all-around quality you need in Data Conversion, contact Ron Brunner, director of marketing, or your area representative.



## PHOENIX DATA, INC.

3384 W. OSBORN RD., PHOENIX, AZ 85017  
Ph. [602] 278-8528, TWX 910-951-1364

## New products

Semiconductors

### Quad op amp has on-chip FETs

Bi-fet process also used for versions of National op amps and Siliconix switches

Monolithic operational amplifiers are getting a face lift these days—with ion-implanted field-effect-transistor front ends. Texas Instruments has now started shipping distributor quantities of the first monolithic quad op amp fabricated with the production technique that mixes bipolar and p-channel, junction-field-effect transistors on the same chip. The device, the TL084, is built using the so-called Bi-fet process and is designed to compete in the same high-performance markets as National Semiconductor Corp.'s LF155 series single Bi-fet op amps. TI, however, has traded off some of the LF155's high speeds and extremely tight input specifications to achieve a lower price and power consumption; it plans to go after the massive general-purpose bipolar op-amp market as well.

The Dallas firm also has become the first alternate source to start

shipping National's LF155-series parts, in both seven-pin TO-79 metal cans, and plastic packages. The specifications match those offered by National [*Electronics*, Aug. 7, 1975, p. 143.] Price for TI's version of the commercial-temperature-range LF355, for example, is \$2.41 in metal or \$1.60 in plastic in lots of 100.

The quad TL084 gets its competitive edge from its density: "There's never been a high-performance quad op amp on the market before, except for expensive hybrids," says John Spencer, linear applications engineer at TI. The part is now available in ceramic or plastic 14-pin dual in-line packages; the plastic version, in quantities of 10, is tagged at \$4.35, and the firm plans to have single and dual op amps in the same series by year end.

Besides price, power consumption on the TL084 is low. Each operational amplifier requires 2.8 milliamperes maximum, a total package maximum of 11.2 mA. Supply voltage for the 084 is  $\pm 18$  volts, and the output will swing 24 v, peak to peak.

Each device's input specs are good enough for most of the precision applications that require high-performance op amps, Spencer says. The firm guarantees a maximum input bias current of 4 nanoamperes; input impedance is at least  $10^9$  ohms,

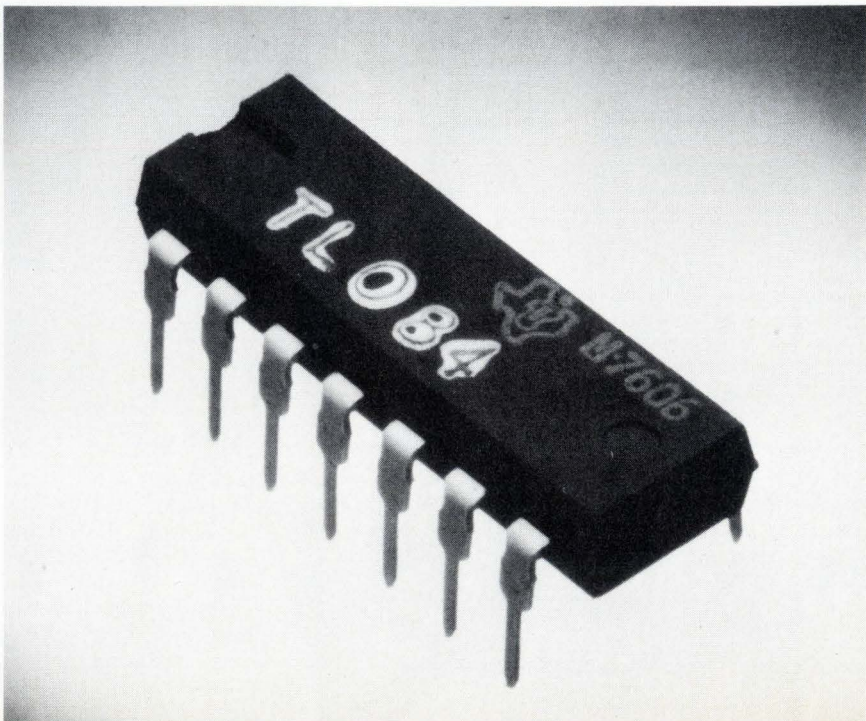



# Dialight Switches

A switch for all reasons.

**Reason 1:** Dialight offers three switch configurations to meet all your needs—*snap-action switches with silver contacts* for moderate-level applications, *snap-action switches with gold contacts* for intermediate-level applications, and *wiping-action switches with gold contacts* for low-level applications.

Each of these ranges is served by two switching actions—momentary (life: 600,000 operations) and alternate (life: 250,000 operations).

**Reason 2:** Dialight's snap-action and wiping-action switches come in a new modular design concept... a common switch body for either high or low current operation. All 554 series switches and matching indicators have the same rear-panel projection dimensions.

The snap-action switching mechanism guarantees a fast closing and opening rate. This insures that contact force and contact resistance

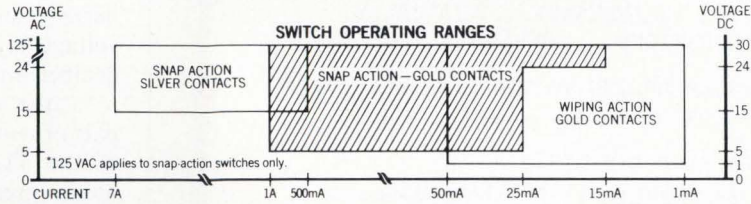

**Reason 3:** Dialight offers a wide variety of panel and snap-in bezel mounting switches with momentary and alternate action configurations in SPDT and DPDT

types. There are over 240 switch variations to choose from.

The 554 illuminated switch, designed for front of panel lamp replacement, gives you a choice of five different bezel sizes... 3/4" x 1", 5/8" x 3/4", 3/4" square, 5/8" square, and 1/2" square. The first four sizes are also available with barriers. You also get a choice of six cap colors... white, blue, amber, red, green, and light yellow... four different underlying filter colors... red, green, amber, and blue and a variety of engraved or hot-stamped legends... over 300 cap styles... over 100,000 combinations.

There is also a variety of terminal connections... solder blade, quick connect, and for PC board insertions.

**Reason 4:** Dialight's 554 series is designed as a low cost switch with computer-grade quality.

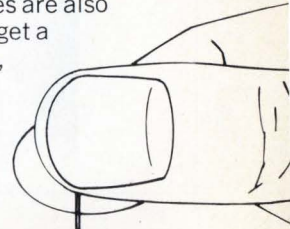
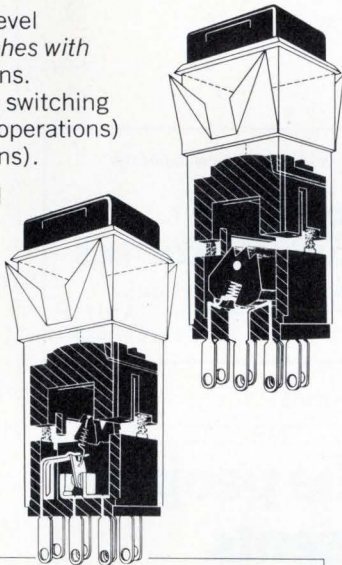

**\$1.65 EACH**  
P/N 554 - 1121  
(1K PRICING)  
**See Dialight**

PRODUCT SELECTOR GUIDE						
SWITCHING ACTIONS	Snap-Silver contacts		Snap-Gold contacts		Wiping-Gold contacts	
	SPDT	DPDT	SPDT	DPDT	SPDT	DPDT
MOMENTARY	○	○	○	○	○	○
ALTERNATE	○	○	○	○	○	○
OPTIONS						
	PUSH BUTTON CAP SIZES					
	1/2" Sq.	5/8" Sq.	5/8" x 3/4"	3/4" Sq.	3/4" x 1"	
BEZEL MOUNTING TO ACCOMMODATE	○	○	○	○	○	
BEZEL MOUNTING WITH BARRIERS TO ACCOMMODATE		○	○	○	○	
PANEL MOUNTING TO ACCOMMODATE	○	○	○	○	○	
MATCHING INDICATORS	○	○	○	○	○	

are independent of the switch's actuation speed.

In the wiping-action switch, the contacts are under constant pressure (A unique Dialight design). This insures long life with a minimum build-up of contact resistance.

*Both switch types are tease-proof.*

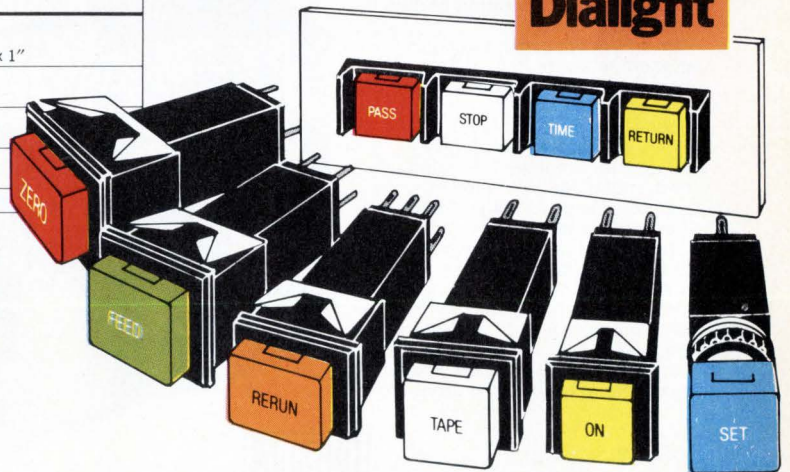

**DIALIGHT**

A North American Philips Company  
203 Harrison Place, Brooklyn, N.Y. 11237  
(212) 497-7600





# Scanbe-gram



RE: STANDARD PRICES FOR CUSTOM P.C. CARD FILES

SCANBE ORIGINATED P.C. PACKAGING SYSTEMS...THE OPTIMUM SOLUTION TO YOUR SPECIAL CARD MOUNTING PROBLEMS.

18 YEARS EXPERIENCE...WIDEST LINE OF CARD PACKAGING HARDWARE IN INDUSTRY...VIRTUALLY UNLIMITED CONFIGURATIONS...NO COSTLY TOOLING.

FROM INITIAL SYSTEM DESIGN TO FINAL PRODUCTION... PLUS ANY STAGE ALONG THE WAY. WE DO IT ALL.

CALL SCANBE CARD FILE EXPERTS. YOUR GUARANTEE IS RESULTS...NOT REGRETS.

SEND FOR SCANBE'S P.C. CARD PACKAGING CATALOG.

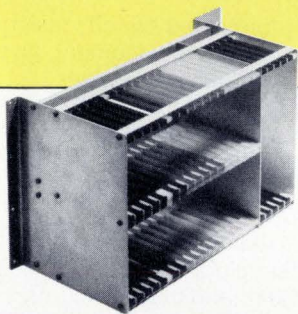

"Imitated... never duplicated."



Scanbe Manufacturing Corp.  
3445 Fletcher Ave., El Monte, CA 91731  
Tel: (213) 579-2300 • TWX: 910-587-3437

Circle 188 on reader service card

## 33% more power to the people. Power/Mate presents Econo/Mate II.

### The open frame power supply.

Now Power/Mate brings you 33% more power in the same package size with the second generation of our Econo/Mate series.

The size is the same, the basic components are the same for easy interchangeability. But that's where the similarity ends.

Econo/Mate II adds features like dual AC primary and a plug-in IC regulator for improved regulation.

And Econo/Mate II is tough. Computer design, quality control, and Power/Mate's experience helps insure 100,000 hr. MTBF even at this higher power output.

But for all its features, Econo/Mate II is still, most of all, economical.

We wouldn't call it Econo/Mate if it wasn't.

Econo/Mate II is in stock, ready for delivery. Send for our free brochure.

Prices start at \$19.95.

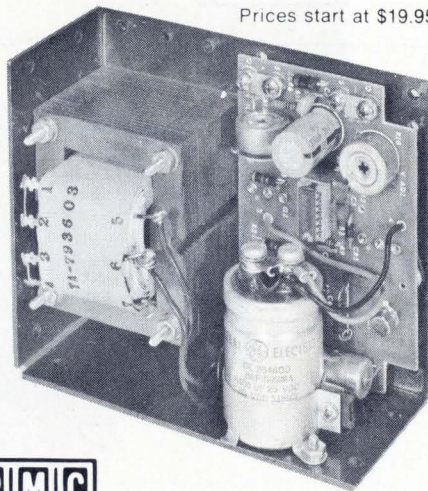

## POWER/MATE CORP.

World's largest manufacturer of quality power supplies.

514 South River Street/Hackensack, N.J. 07601/Phone (201) 343-6294 TWX 710-990-5023

148

Circle 148 on reader service card

## New products

input offset voltage is a maximum of 15 millivolts, and input offset current is 0.5 nA maximum. The offset voltage temperature coefficient is typically 10 microvolts/°C.

Amplifier slew rate is 9 V/μs, and unity-gain bandwidth is 3 megahertz. Common-mode and supply-voltage rejection ratios are both 70 decibels minimum.

TI uses ion implantation to put a pair of JFETs on the front end of each of the TL084 amplifier circuits to obtain greater channel uniformity—a necessity for stability as well as for matching the voltage offsets of the four devices on the chip—and to decrease chip size. The TL084 circuit has been designed with a total of about 15 active devices for each amplifier. In contrast, the LF155-series op amps use about 40 transistors and diodes.

The Bi-fet process is also used at TI to second-source Siliconix' DG-series analog switches. The firm is now sampling its monolithic versions of the Siliconix hybrids DG 182, 188, and 191; production is slated for the end of this month. Available in commercial temperature range, TI's TL182 analog switch costs \$2.03 in lots of 100.

Texas Instruments Inc., P.O. Box 5012, M/S 84, Dallas, Texas 75222. Phone John Spencer at (214) 238-3527 [411]

### Bi-fet 741 op amp has 200-pA input bias

Notwithstanding its workhorse status, the general-purpose 741 operational amplifier has its limitations. In particular, when there is a need for extremely low input bias or offset currents, it is usually necessary to trim or to choose a more expensive device.

To overcome this limitation, National Semiconductor Corp. is introducing a 741 with field-effect transistors as input followers on the same chip as the bipolar circuitry. In addition to the familiar operating characteristics of a 741—a slew rate of 0.5 volt per microsecond, a gain-bandwidth product of 1 megahertz, a



# "I'll tell you why this OEM picked PDP-8. It's good engineering and it's good business."



The man in the picture is Dr. David Kemper, biochemist and product manager in charge of development, production, installation and field support for an amazing analytical device called Rotochem IIa, from American Instrument Co.

The computer inside his product is a PDP-8A from Digital. Dr. Kemper is buying scores of them. Why?

"They're inexpensive in a market that's cost sensitive. They're incredibly reliable in a

market that's reliability oriented. And our customers can get service anywhere in the world. The PDP-8A gives us the performance we need at a price we can't beat. We can offer the capability to run 50 tests on each of 250 patients."

Sensitive but tough. High in performance, low in cost. "Good engineering. Good business." It's the same story you hear from OEMs around the world. And that's why PDP-8's the most

successful minicomputer ever.

Digital Equipment Corporation, Parker Street, Maynard, MA 01754. (617) 897-5111. European headquarters: 81 route de l'Aire, 1211 Geneva 26. Tel: 42 79 50. In Canada: Digital Equipment of Canada, Ltd.

**PDP-8  
The Most  
Successful  
Minicomputer  
Ever!**

**digital**  
**50,000 computers saving  
managers millions.**

Circle 149 on reader service card



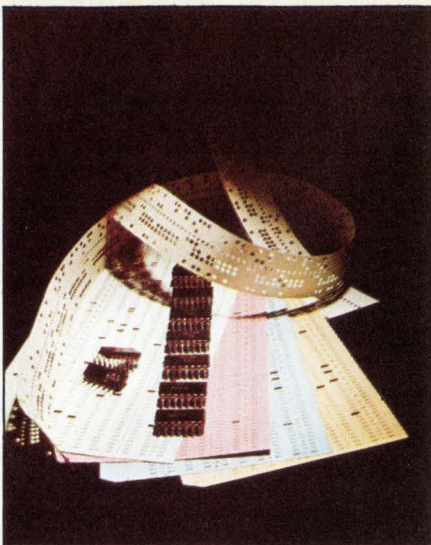

## »TTL-155«

Transistorized logic elements for error — free electronic brains

- 100 per cent quality control by every rating
- minimum power consumed · negligible weight
- minimum on-off time · wide range of temperatures
- extra-strong structure

Delay, ps:	
on	15
off	22
Max. voltage:	
supply, V	+ 5.5
input, V	+ 4.5
Max. output current, mA:	
high level	1
low level	16
Noise voltage, V	0.4
Static power per one element, mW	25
Dimensions, mm	19.5 x 6.5 x 3.8
Working temperature range, °C.	-10 to +70
Acceleration, g:	
at vibration within frequency range	
5 to 2000 Hz	10
5 to 5000 Hz	—
at repeated impacts	35
at linear acceleration	50
at single impacts	150

TTL-155 Integral microcircuits for computers & automatic control — the transistorized logic that is up to the world's highest standards.

supplied in any quantities by



**ELORG**

32/34 Smolenskaya-Sennaya  
Moscow 121200, USSR  
Telex 7586

## New products

common-mode rejection ratio ranging from 70 to 90 decibels, and a supply-voltage rejection ratio ranging from 77 to 96 dB—the LF13741 has the advantages of low input bias and offset currents. Also, the units sell for only 95 cents apiece.

At 25°C, input bias current for the LF13741 is 50 to 200 picoamperes, versus the 200 to 500 nanoamperes for standard 741s. Input offset current is similarly reduced—10 to 50 pA as compared with 30 to 200 nA for standard devices.

Systems designers can achieve very short design times with the LF13741, says David Whetstone, Bi-fet product marketing manager at National, because it lets them take full advantage of their knowledge of the ordinary 741. Applications in which the new device excels, says Whetstone, include amplifiers for high-impedance transducers, sample-and-hold systems, photocell circuits, and comparator circuits in which high speed is not essential.

National Semiconductor Corp., 2900 Semiconductor Drive, Santa Clara, California 95051 [412]

## TOPICS Semiconductors

**Mostek Corp., Carrollton, Texas**, has licensed the Fairchild Camera and Instrument Corp. mos/ccd Products division in Palo Alto, Calif., to second source its Mostek MK 4027 4,096-bit dynamic RAM. . . **Motorola Semiconductor Products Inc., Phoenix, Ariz.**, has cut prices from 20% to 50% on its Schottky-barrier rectifiers. . . **Alpha Industries Inc., Woburn, Mass.**, has increased the typical Q values of its DKV-6520 series and DKV-6530 series hyperabrupt tuning diodes to more than twice previous values. . . **National Semiconductor Corp., Santa Clara, Calif.**, is offering two industry-standard 16-line multiplexers in complementary-MOS circuitry. The c-mos version of the popular DM74150 is called the MM74C150, and the DM8219 is called the MM82C19 in its c-mos form.

## FREQUENCY?

MEASURE IT ANYWHERE  
To 60 MHz with the FM-7.

NLS proudly announces a NEW Frequency Meter.



With Rechargeable Batteries & Charger Unit **\$195**

Features Include:

- Portable, battery operated for measurement anywhere! • 10 Hz to 60 MHz input with LED 7-digit resolution. • High sensitivity; 30 mV - 50 Hz to 30 MHz (100 mV - 10 Hz to 60 MHz). • Input overload protection. • Small, only 1.9"H x 2.7"W x 4"D. • High stability internal time base. • For field application, servicing or production testing. See your local distributor!

Distributor inquiries invited.

Circle 247 on reader service card

## NEED A PRESET COUNTER? —

NLS adds to its counter line — the new, small Model PR-5 solid-state preset counter.

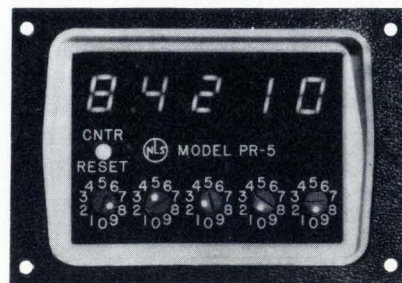

Unit Quantity—**\$149**

Features Include:

- Five-digit LED display of count plus 5-digit preset. • Counts at 500 kHz pulse & 300 Hz contact closure. • Small size: 2.25"H x 3.25"W x 4"D; fits in the palm of your hand. • Permits multiple presets. • Optional battery pack for standby operation. • Solid-state LSI circuitry with high noise immunity.

See your local distributor!

Distributor inquiries invited.



**Non-Linear Systems, Inc.**

Originator of the digital voltmeter.  
Box N, Del Mar, California 92014  
Telephone (714) 755-1134 TWX 910-322-1132

Circle 189 on reader service card



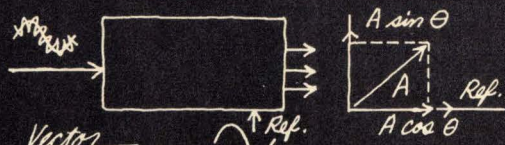

**Vector Voltmeter:**

Three outputs simultaneously available. Continuous 360° phase offset capability for phase nulling to .1°. 90° & 180° switches accurate to .1 degree.

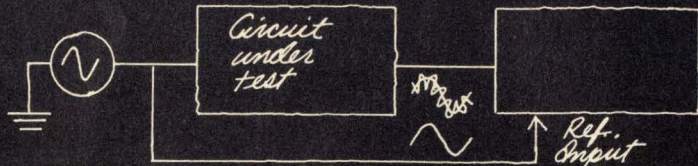

**Narrow Band AC Voltmeter:** Measure cross talk, power supply rejection, and other low level coupling phenomena. Automatically tracks signal frequency.

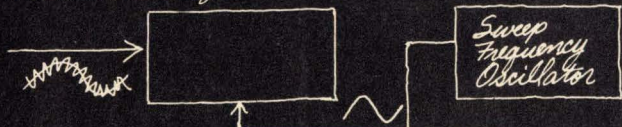

**Ultra Sensitive Spectrum Analyzer:** Tune manually with controls provided, or sweep by synchronizing to external swept oscillator.



**Tracking Filter (Measure frequency of noisy signal)**  
Signal tracking mode phase locks internal oscillator to noisy signal.

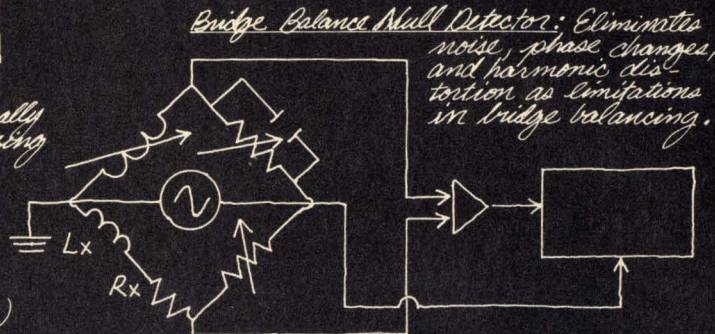

**Bridge Balance Null Detector:** Eliminates noise, phase changes, and harmonic distortion as limitations in bridge balancing.

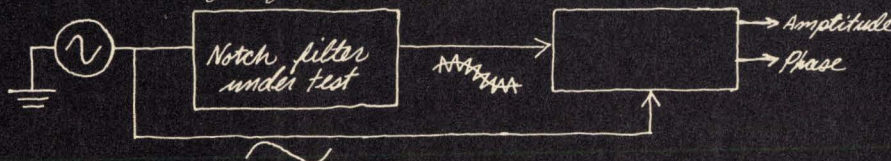

**Transfer Function Analyzer**  
Measure notch filter depth and phase characteristics.

# Measure noisy signals up to 200 kHz—like you've never measured them before.

A new test and measurement tool, the Dynatrac® 3 lock-in analyzer, measures amplitude, frequency, phase and narrow band noise at signal levels from picovolts to volts, frequencies from .1 Hz to 200 kHz, and selectable bandwidths from .001 Hz to 100 Hz. It easily detects signals that are 100 dB below an interfering signal—a dynamic range that is currently beyond the state of the art in digital technology.

Because of its ability to measure signals in the presence of noise, there are many applications in which Dynatrac 3 picks up where the performance of vector voltmeters, phase meters, lock-in amplifiers, wave analyzers, transfer function analyzers,



bridge balance null detectors, and noise meters leave off.

With its phase option, Dynatrac 3 measures the phase of signals completely obscured by noise with an accuracy of ±1° and resolution and stability of .1°.

Dynatrac 3 delivers trouble-free performance with RFI protection. And a floating guarded front end eliminates ground loops.

The sketches above illustrate just some of the many applications for this unique new test and measurement tool.

To get the complete Dynatrac 3 story (and to tell us about your signal measurement problems), contact Ithaco, Box 818-E, Ithaca, New York 14850. Or telephone (607) 272-7640 or TWX 510-255-9307.

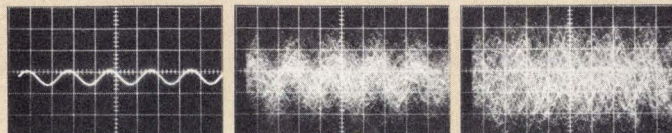



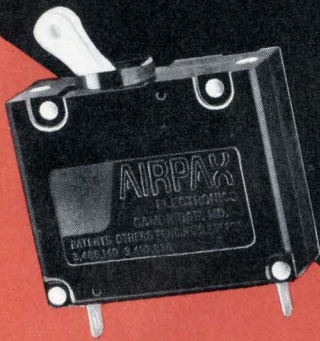

**Reset  
or  
Regret**



**... the  
choice  
is yours!**

In the event of an overload in the equipment you build, does your customer reset or regret? If you use Airpax electromechanical circuit protectors, your equipment is put back into service with a simple flip of the handle.

But if a fuse is used, does your customer know how to replace it? Can he spare the time? Or does he call you for service? Regrettably, expensive downtime occurs and, as far as he is concerned, you are to blame.

Sure, you can use fuses. But for more positive protection and reset capability—at little or no more cost than the combination of fuse, fuse holder, and power switch—specify:

**AIRPAX™**  
**Electromagnetic  
Circuit  
Protectors**



Send for Short Form  
Catalog 2013.

AIRPAX ELECTRONICS/CAMBRIDGE DIVISION  
Cambridge, Maryland 21613  
Circuit Breakers, Switches, Glass/Ceramic-to-Metal Seals  
Other Airpax Divisions:  
CONTROLS DIVISION, Fort Lauderdale, Fla.  
Instruments for Industry  
AMERICAN DATA, Huntsville, Alabama  
TV Products

## New products

Components

### Ferrites made more stable

Toroids provide high permeability, low tempco from  $-35^{\circ}\text{C}$  to  $75^{\circ}\text{C}$

Because of their temperature sensitivity, ferrite components have been largely excluded from such applications as ground-fault interrupters, where temperatures can vary over a fairly wide range. But a new family of high-permeability ferrite toroids from Indiana General promises to be a low-cost alternative to the nickel laminations currently employed for these applications.

The new BBR 7950 series are the first ferrite components to have their performance specified and guaranteed below  $0^{\circ}\text{C}$ , the company claims. The toroids provide a nominal

permeability of 7,000 from  $-35^{\circ}\text{C}$  to  $+75^{\circ}\text{C}$ , and their inductance at  $-35^{\circ}\text{C}$  is typically within 5% of the room-temperature value. What's more, over this extended temperature range, the parts maintain the low-loss properties expected of ferrite components, and coercive force is typically a low 0.01 oersted.

As shown by the performance curves, the BBR 7950 toroids provide high permeability at either low or high temperatures, as well as a lower temperature coefficient of inductance than other high-quality ferrites.

Because their electrical parameters are guaranteed, the new ferrites simplify circuit design and permit precise evaluation of circuit performance, notes Indiana General. For example, when they are used for current sensing in ground-fault interrupters, their high permeability reduces the number of turns needed for the sense winding, and their low temperature coefficient assures a consistent trip level from  $-35^{\circ}\text{C}$  to  $+75^{\circ}\text{C}$ , the firm says. The inductance

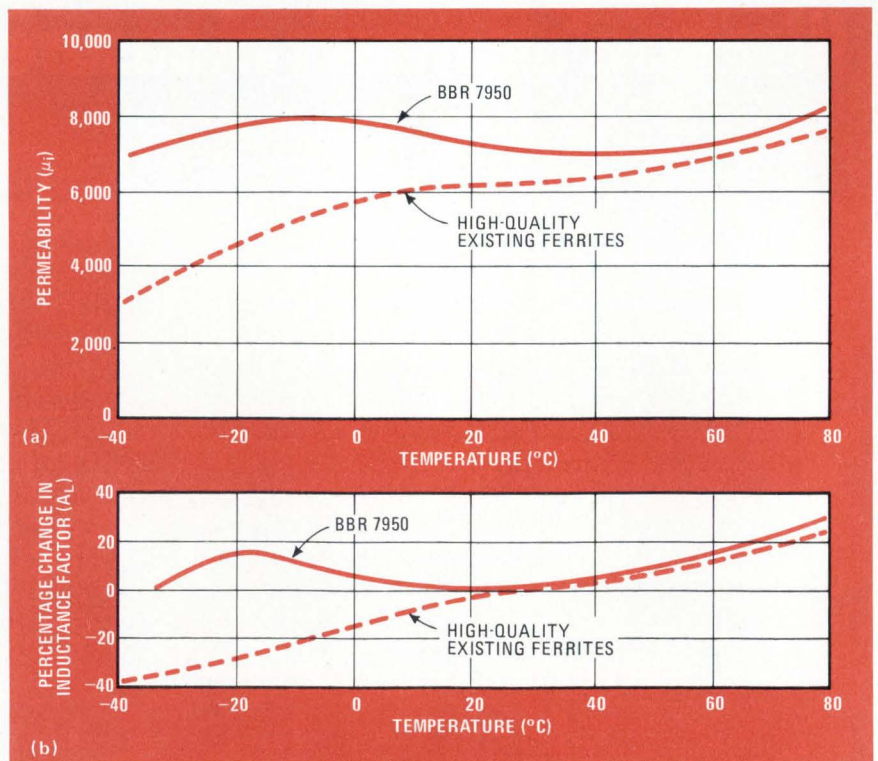

**Better temperature stability.** Permeability (a) of new BBR 7950 ferrites remains high, even at temperatures down to about  $-40^{\circ}\text{C}$ , and temperature coefficient of inductance (b) is always positive over the range from about  $-35^{\circ}\text{C}$  to past  $75^{\circ}\text{C}$ .





## The human eye is no match for a bent wire-wrap pin.

Even with an optical comparator, finding and correcting bent wire-wrap\* pins can be a very difficult job. Human eyes were simply not designed for this kind of work.

However, machines like the Gardner Denver 14FV require absolutely precise pin positioning if they're to live up to their promised rates.

To meet this increased demand for precision, we built a fully automatic, computer-controlled inspection system. A proprietary system that electronically verifies the location of every contact and automatically repositions those contacts not within the specified tolerance. A system that eliminates all human error. A system that enables us to give you perfect boards. Boards that won't slow down even

the fastest automatic wire-wrap machines.

If you wrap boards, this means less downtime due to imperfectly straightened pins. If you send boards out, it means faster wrapping at less cost.

Teradyne Components introduced the standard gang pin straightening machine and semi-automatic contact verifier. We set new standards for wire-wrap pin alignment when we did. Now

we're carrying precision one step further. And as a result, Teradyne Components can offer you the most precisely engineered boards in the world. Make us prove it.

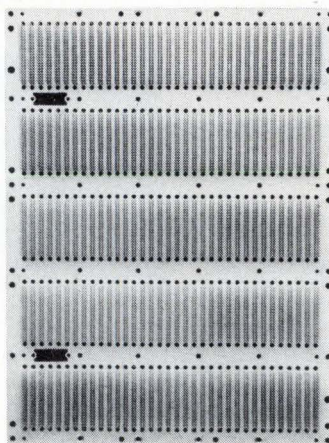

The Perfect Board

### TERADYNE

Teradyne Components, Inc.  
Wire-wrap interconnection systems.  
900 Lawrence Street, Lowell, MA 01852

\*TM Gardner Denver  
© 1976 Teradyne Components, Lowell, MA 01852 Pat. Pend.



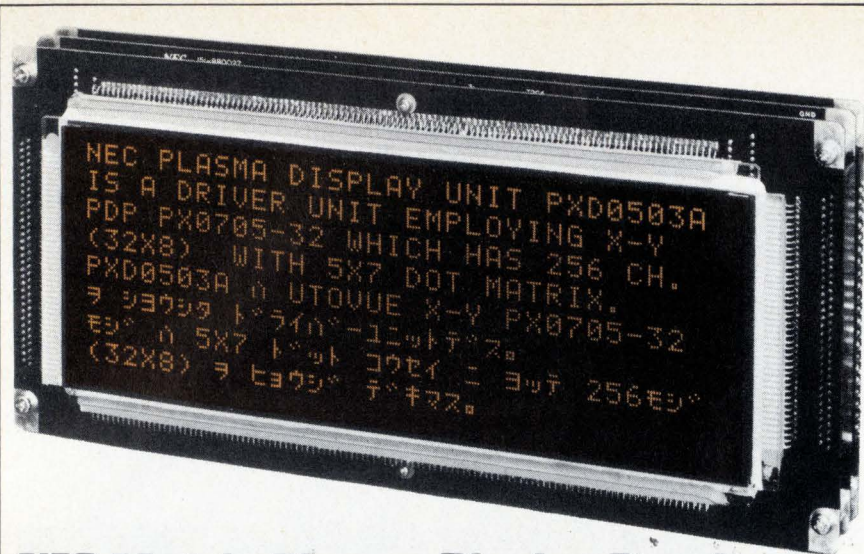

## NEC Matrix Plasma Display Panel — compact, complete with driver circuits. TTL compatible.

Type PXD0503A displays 256 characters (32 x 8 lines) in 5 x 7 dot matrix form. The 0.26-inch high characters are high contrast neon orange. No glare, distortion, flicker or fuzziness. NEC's unique transparent electrodes enhance inherent high readability. TTL level interface. Measures 5.5 x 12.6 x 2.1 inches including connectors. Ideal for terminal display applications.

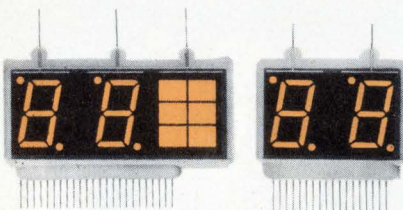

Type PO2504T-02 Type PH2524T-02

### AC-coupled Plasma Display Panels

- Inch-high or up to 4 inches.
- Static/dynamic drive.
- Usable up side down.
- Noble display appearance.

**U.S.A. Sole Agent: World Products, Inc.**  
7625 Bush Lake Road, P.O. Box 35263, Minneapolis, Minn. 55435  
Tel: (612) 835-2117 Telex: 29-0181 WORLD PROD EDNA

**Europe NEC Electronics (Europe) GmbH**  
4000 Düsseldorf, Immermannstrasse 22, F.R. Germany  
Tel: Düsseldorf 357088, 357089, 357080 Telex: NECD 8587419

**NEC**  
Nippon Electric Co., Ltd.  
P.O. Box 1, Takana, Tokyo, Japan

Circle 154 on reader service card

## The Answer Book. It makes your job easier. \$25.

Who makes what? Over 4000 products, 6000 manufacturers with their local contacts, directory of trade names and catalogs, inquiry "bingo" card for 5-second ordering of current catalogs.



**Electronics Buyers' Guide**  
1221 Ave. of the Americas  
New York, N.Y. 10020

Yes, send me a copy of The Answer Book. I've enclosed \$25 (USA and Canada only, elsewhere send \$35). Full money back guarantee if returned within 10 days.

Name \_\_\_\_\_  
Company \_\_\_\_\_  
Street \_\_\_\_\_  
City \_\_\_\_\_ State \_\_\_\_\_ Zip \_\_\_\_\_

## New products

of the BBR 7950 series is measured at 10 millivolts and at a frequency of 10 kilohertz.

Outside diameters of the toroids range from 0.375 to 0.535 inches. Each part is covered by a thin protective coating, which nominally measures 0.001 in. thick. This covering eliminates the plastic case required by conventional metal laminates, thereby reducing assembly costs.

Priced from 8 cents in OEM quantities, the BBR 7950 toroids are available for evaluation.

Indiana General Electronic Products, Crows Mill Rd., Keasbey, N.J. 08832 Phone: (201) 826-5100 [341]

## Easy-to-read LED displays use little power

Intended for use in portable digital instruments and desktop calculators, the HP 5082 series of light-emitting-diode displays has large (0.175-inch-high) numerals yet requires only 2 milliamperes per segment. There are four digits to the inch plus either a center decimal point (in the five-digit model 5082-7265 and the 15-digit -7275) or a right decimal point (in the five-digit 5082-7285 and the 15-digit -7295). Mounting is by edge connector or soldered wires. The 5082-7265 costs \$11.25, the -7275 \$31.95 in 200-999 quantities, or rather more than smaller displays.

Inquiries Manager, Hewlett-Packard Co., 1501 Page Mill Rd., Palo Alto, Calif. 94304 [347]

## Chip capacitor has both electrodes on one face

Having both broad electrodes on one face, a new type of ceramic chip capacitor makes assembly easier and more economical because it has no need of either the end terminations characteristic of multilayer versions or the wrap-around termination of conventional chip capacitors.

The Split-Chip devices, which will be on display at Wescon, are also



# Beyond the ordinary!

DigiTec printers are precision crafted instruments, offering reliability, workmanship and features that distinguish them from the ordinary. Ideal for laboratory, systems or OEM applications. Their sought-after features include: floating decimal, selective data blanking, systems interface, red and black print, data grouping and front panel paper loading and ribbon changing without exposure of electronic components.

Selected models include a crystal clock, an events counter, and 10 to 21 column recording capability.

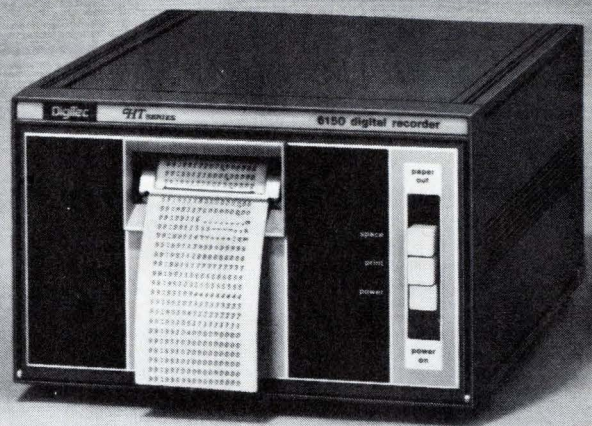

**DigiTec** UNITED SYSTEMS CORPORATION

918 Woodley Road, Dayton, Ohio 45403  
(513) 254-6251, TWX (810) 459-1728

*DigiTec: precision measurements to count on.*

*These instruments available under GSA contract GS-00S-27741.*

"Information only" Circle 155 readers service card

"Demonstration only" Circle 190 readers service card

## NOW DDU

A COMPLETELY INTERFACED

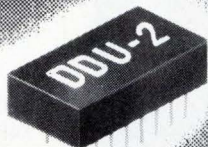

## LOGIC DELAY LINE

Data Delay Devices has developed a digital delay unit, series DDU, which eliminates the interfacing in T<sup>2</sup>L circuits.

With the following advantages:

- T<sup>2</sup>L input and outputs
- 1500NS total delay
- Fast rise — Time on all taps
- Up to 10 taps
- Each tap isolated and with 10T<sup>2</sup>L Fan-out capabilities
- Exact delay at each tap

Request spec. sheet DDU

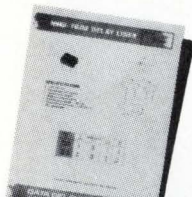

**DATA DELAY DEVICES**

253 CROOKS AVE., CLIFTON, N.J. 07011

Tel. (201) 772 1106

*Buy from the specialist*

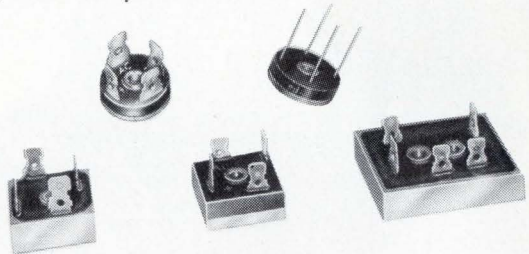

## Minibridge® fast recovery Rectifier Bridges

T<sub>rr</sub> as fast as 150 ns. • Peak Reverse Voltages from 50 to 1,200 • Currents to 30 Amp • For Heat Sink and Chassis Mounting • Single and 3-phase bridges • Center Tap and Doublers • Standard and U.L. Component Recognition Types • Many unique features • Attractive Prices

**edi** Free Samples

Write for catalog. Describe application and we will provide free samples and our best low prices.

**electronic devices, inc.**

21 Gray Oaks Ave., Yonkers, N.Y. 10710

[914] 965-4400 TWX [710] 560-0021 TELEX 13-1580

Circle 209 on reader service card

Circle 210 on reader service card

155



# Ben would have liked you.

Ben thought that there had to be more to lightning than just fire in the sky. So he ignored what people told him and did a little rainy-day research on his own.

Determined curiosity—like Ben's—has guided your imaginative progress in the microelectronics field. At Kodak, we have combined extensive research with a deep understanding of your industry, so that our skilled representatives can help improve your product or production techniques.

We try to make your job

a little easier, a little more efficient.

For more information about our products for microelectronics, write Eastman Kodak Company, Dept. 412L (48-F), Rochester, N. Y. 14650.

## RESULTS COUNT

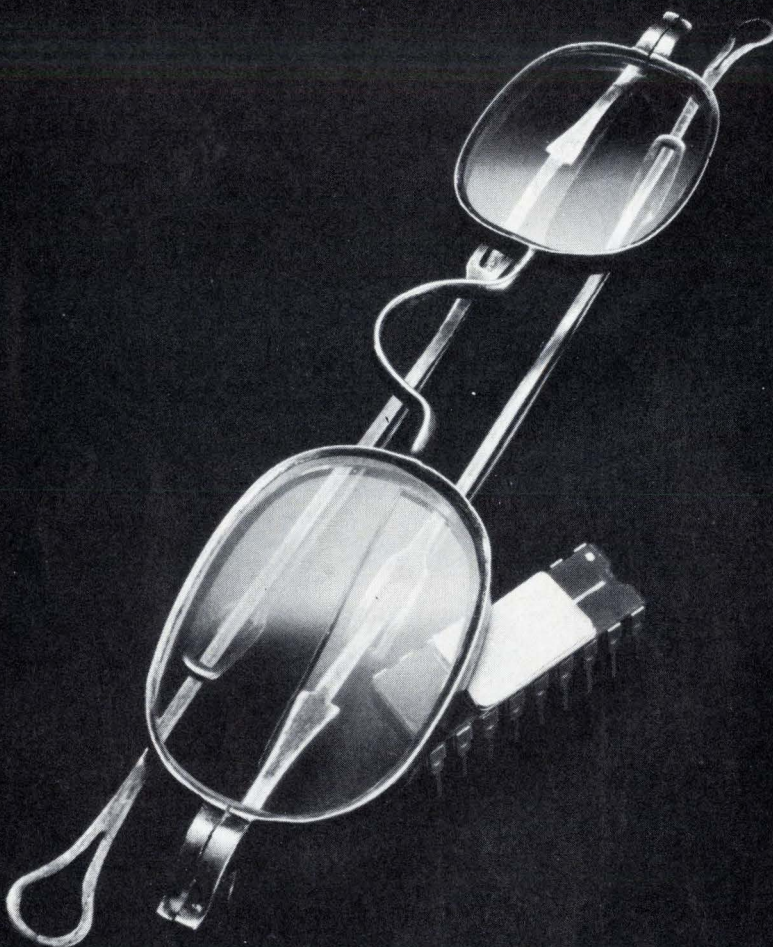

## New products

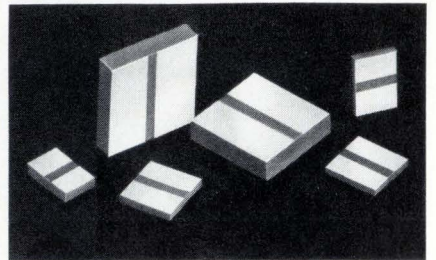

said to provide greater stability and narrower tolerances. Five standard sizes from 0.040 by 0.030 inch to 0.130 by 0.090 in., all 0.015 in. thick, will be available to start with. Prices typically will be 15% less than those of multilayer devices of equal capacitance, says the company.

Johanson Dielectrics Inc., Box 6456, Burbank, Calif. 91510. Phone (213) 848-4465 [343]

## Small hybrid relay handles low power at low cost

A TTL-compatible 241-series miniature ac hybrid relay will be particularly useful in low-power applications such as point-of-sale data terminals. Costing only \$3.25 each in quantities of 1,000, the solid-state device measures a mere 1 by 1.14 by 0.31 inch and is designed for mounting on printed-circuit boards. Current rating is 250 milliamperes, with a one-cycle surge current rating of 2.5 amperes peak; minimum dielec-

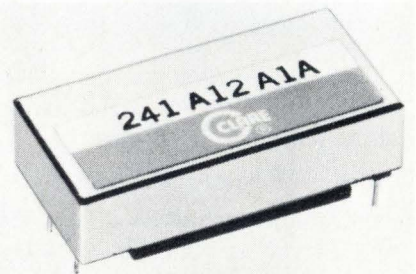

tric withstanding voltage is 1,500 volts ac, and insulation resistance is  $10^{10}$  ohms. Standard input ratings of 5, 12 or 24 v dc are available with the UL-recognized device.

C. P. Clare & Co., 3101 W. Pratt Ave., Chicago, Ill. 60645. Call George Neeno (312) 262-7700 [344]



Checkmated by high pushbutton switch costs?

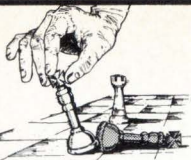

These three new Centralab Pushbutton Switch products are real money savers, yet they offer the high-quality features of all Centralab switches. Contact your Centralab Distributor for details. Ask for a copy of Centralab's New Pushbutton Switch Catalog, Series No. 301.

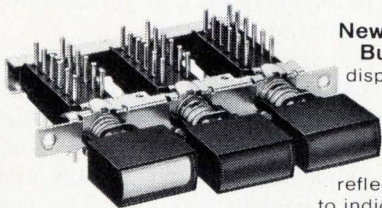

**New Status Indicator Button.** Adds visual display to non-lighted switches. The button, with a unique fluorescent display, uses reflected ambient light to indicate switch status. 6 display colors available.

**Low Cost Lighted Switch** uses T-1 $\frac{3}{4}$  wedge base lamp. Many lens and color options.

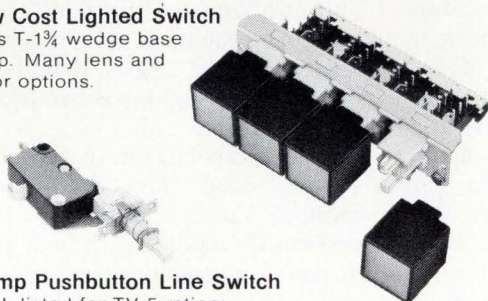

**5 amp Pushbutton Line Switch** is UL listed for TV-5 rating: 120V, 5A, 78A peak inrush current.

## Check These Centralab Distributors For 3 New Ways To Cut Switch Costs.

**CALIFORNIA**  
Kierulff Electronics, Inc.  
Los Angeles  
213/685-5511

Kierulff Electronics, Inc.  
Palo Alto  
415/968-6292

Kierulff Electronics, Inc.  
San Diego  
714/278-2112

**COLORADO**  
Kierulff Electronics, Inc.  
Denver  
303/371-6500

**FLORIDA**  
Hammond Electronics  
Orlando  
305/849-6060

**INDIANA**  
Radio Distributing  
Co., Inc.  
South Bend  
219/287-2911

**MASSACHUSETTS**  
Sterling Electronics  
Watertown  
617/926-9720

**MINNESOTA**  
Gopher Electronics Co.  
St. Paul  
612/645-0241

**NEBRASKA**  
Radio Equipment Co.  
Omaha  
402/341-7700

**NEW YORK**  
Electronic Equipment  
Co., Inc.  
Hempstead  
516/538-5510

Peerless Radio Corp.  
Lynbrook, L.I.  
516/593-2121

**NORTH CAROLINA**  
Kirkman Electronics, Inc.  
Winston-Salem  
919/724-0541

**OHIO**  
ESCO Incorporated  
Dayton  
513/226-1133

Pioneer-Standard  
Electronics, Inc.  
Cleveland  
216/587-3600

**PENNSYLVANIA**  
Cam/RPC Industrial  
Electronics  
Pittsburgh  
412/288-2600

Herbach & Rademan, Inc.  
Philadelphia  
215/426-1700

Pytronic Industries, Inc.  
Montgomeryville  
215/643-2850

**TEXAS**  
Southwest Electronics Inc.  
Stafford  
713/494-6021

**WASHINGTON**  
Almac/Stroum Electronics  
Seattle  
206/763-2300

Isostat Licensed

DISTRIBUTOR PRODUCTS



**CENTRALAB**  
Electronics Division  
GLOBE-UNION INC.

5757 NORTH GREEN BAY AVENUE  
MILWAUKEE, WISCONSIN 53201

Circle 157 on reader service card



## FREE Fiber Optics Catalog

Features the complete AO line of fiber optics products—from Inspection Fiberscopes and Light Guides to Illuminators, Image Conduits, Faceplates and Custom Components. Includes the four newest remote inspection fiberscopes now available.

Describes the principle, technology and techniques used to make flexible light and image transmissions a proven, practical fact. Write today for your FREE copy of the AO Fiber Optics catalog to American Optical Corporation, Fiber Optics Division, Southbridge, Mass. 01550.

**AO**  
American  
Optical

Circle 191 on reader service card

## Converting Force to mV's? That Takes Interface...

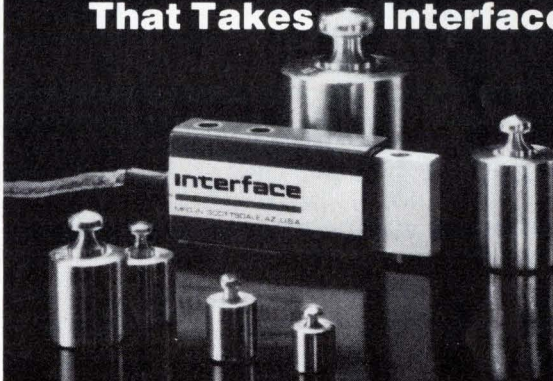

...Interface, Inc., designer and builder of a full line of precision strain gage load cells for force measurement and test systems. This low range Minibeam cell offers a guaranteed error band of less than  $\pm 0.04\%$ , is thermally compensated to within 8 ppm/ $^{\circ}$ F, yet is priced as low as \$160 in unit quantities. Like all Interface load cells, it's warranted for 2 years.

For specifications on 5 to 150 pound capacity Minibeams that operate in tension or compression—for details on load cells with capacities to 100 tons, contact Interface, Inc., 7401 E. Butherus Dr., Scottsdale, AZ 85260 USA. (602) 948-5555. Telex 668-394.



Low Profile



Sealed Super-Mini



Super-Mini

**interface**

ADVANCED FORCE MEASUREMENT

Circle 192 on reader service card

157



# Stamp out



## "IC Hotfoot"

Hot soldering irons can be murder on delicate electronic components such as IC's. That's why the DIGI-DESIGNER will become your bugs' best friend. It's a solderless breadboarding instrument that can save you time and burned out parts.

DIGI-DESIGNER comes complete with clock, dual pulsers, logic monitors, voltage switches, built-in 5 volt supply, binding posts for external power, input/output BNC's, and more. Everything you'll need for fast, efficient circuit design.

DIGI-DESIGNER. It means the end of "IC Hotfoot" and the start of efficient, creative circuit design for you. U.S. price - \$70.00 (in kit form). For more information and our current catalog complete and send in the following coupon.

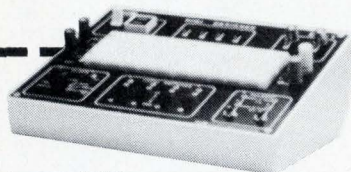

**E&I** E&I INSTRUMENTS, INC.  
61 First Street, Derby, Conn. 06418 (203)735-8774

Please send me your current catalog and more information on DIGI-DESIGNER.

Name \_\_\_\_\_

Address \_\_\_\_\_

City \_\_\_\_\_ State \_\_\_\_\_

Zip \_\_\_\_\_ Telephone \_\_\_\_\_

## New products

Packaging & production

### Furnace handles crystals to 5 in.

Silicon boules up to 40 in. long can be grown in Czochralski-type unit

For semiconductor manufacturers seeking greater efficiency by working with large-diameter wafers, the Lexington Vacuum division of Varian Associates has come up with a new crystal-growing furnace that accommodates silicon boules up to 5 inches in diameter and 40 in. long. The model 2850, which has a hot zone 10 in. in diameter, has a furnace chamber and power supply large enough to allow expansion to a crucible 12 in. in diameter.

Dennis Williams, the division's product manager for advanced mate-

rial equipment, points out that recently there has been a "horse-power race" that's measured in how big a charge can be put into the Czochralski furnace. Charge size in turn, relates to the cost per kilogram of material.

Williams estimates that the limit in charge size for the foreseeable future is 25 to 30 kilograms, "which can probably be achieved in a 12-in.-diameter hot zone and possibly with a 5-in.-diameter crystal." The new Varian furnace offers that potential and also contains the same type of vacuum system as its predecessor, Varian's model 2848A, though operation under slight positive-pressure is also possible.

Williams points out that a vacuum system needs less argon to be pumped through to produce zero-dislocation crystals with high yields. Argon is pumped downward past the melt to minimize the buildup of silicon-monoxide deposits on the furnace liner.

In positive-pressure systems, silicon monoxide can flake off the liner into the melt, causing crystal imperfections. In Varian's earlier positive-pressure furnaces, up to 150 cubic feet per hour of argon was required; the 2850 furnace uses as little as 40 ft<sup>3</sup>/hr. Williams says that reduction can save users as much as \$20,000 a year per furnace, depending on how extensively the furnace is used.

The new furnace also requires as much as 5% less power than positive-pressure systems because vacuum furnaces have less conductive loss. In addition, Williams says cleanup time between runs is shortened from 1½ hours to about 30 minutes, increasing the throughput. That's because there's less of that silicon monoxide to be cleaned from the chamber walls.

The furnace system includes a furnace tank and hot zone, front-opening chamber, crucible and seed shaft drives, temperature and automatic diameter controls, control console, vacuum-pumping system, and a 125 kilovolt-ampere power supply. The price of the new crystal-growing furnace is approximately \$95,000,

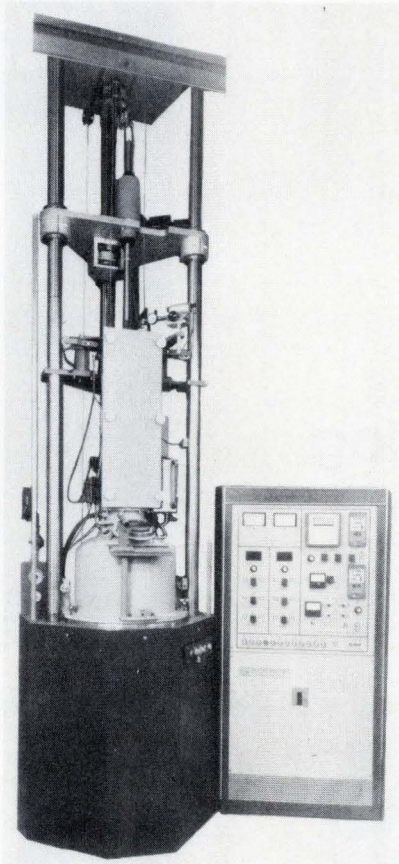



## New products

depending on options, and delivery time is five to six months.

Lexington Vacuum Division, Varian Associates, 121 Hartwell Ave., Lexington, Mass. 02173. Phone (617) 861-7200 [391]

Spring-contact probes can be located on 0.050-in. centers

A subminiature spring-contact probe of the type used in "bed-of-nails" fixtures can contact points located as little as 0.050 inch apart, like those often encountered on ceramic substrates used for hybrid circuits. Designated the series SPA-O, the probe can carry a current of 3 amperes. Its beryllium-copper tip is coated with rhodium over nickel

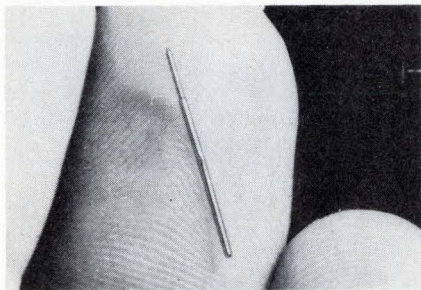

plate, and its housing is made of gold-plated phosphor-bronze. Probe resistance is 50 milliohms, and nominal mechanical life is one million actuations. Mounting-hole size for the snap-out probes is 0.035/0.0365 inch. Because the probe snaps out of its receptacle, there is no need to cut and reterminate wires when making a replacement.

Everett/Charles Inc., 2806 Metropolitan Place, Pomona, Calif. 91767. Phone (714) 593-2541 [393]

Kits make circuit boards without camera or darkroom

Two kits speed production of printed-circuit boards by the direct-art-then-etch process, which requires no investment in cameras or darkrooms. Differing only in the number of boards they can turn out, the kits contain positive-resist-coated circuit

## VECTORBORD® TENTH/TENTH HOLES MOUNT:

DIPS, SIPS, KLIPS, CHIPS

PINS, POSTS, POTS, PADS

RCs, ICs, PCs, SCs

Save Work — Time — Money

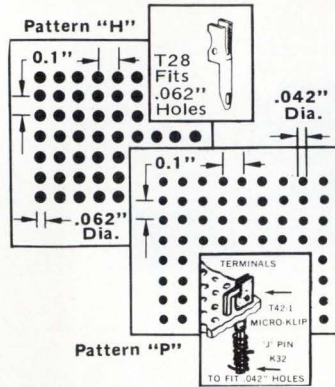

## 8800V MICROPROCESSOR PLUGBORD

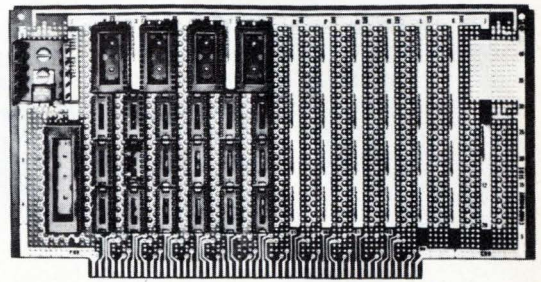

(Component Side with Added Sockets)

Has 100 contacts on 0.1" centers, is 10" wide by 5.313" high. Has heavy tinned back-to-back buses, overall 0.1" spaced 0.042" hole pattern. Socketed models available.

### WIDE SELECTION OF SIZES AND MATERIALS

**MICRO-VECTORBORD® "P"** — 0.042" holes match DIP leads. Epoxy glass, or glass composite, paper, copper clad. Also 1/64" to 1/16" thick and 10" max. width.

**VECTORBORD "H"** — For larger terminals, leads. Available in epoxy glass sheets 4.8" to 8.5" wide and 8.5" to 17" long. 1/32" and 1/16" thick.

**TERMINALS** — Complete selection of wire wrappable and solderable push-in terminals for 0.042" and 0.062" dia. holes — plus wiring tools available.

**PLUGBORDS** — For solder or wrap wire construction 2.73" to 10" wide and 4.5" to 9.6" long. With holes .1" x .1", .1" x .2", .2" x .2", or loaded with IC sockets.

*Vector*

Send for complete literature

**ELECTRONIC COMPANY, INC.**

12460 Gladstone Ave., Sylmar CA 91342  
(213) 365-9661 — TWX (910) 496-1539



41576

Circle 159 on reader service card

## NEW! NOW IN STOCK FROM

**CML  
MACARR**  
POWER SUPPORT EQUIPMENT

**THE LEADER IN SOLID STATE WIDE BAND POWER AMPLIFIERS!**

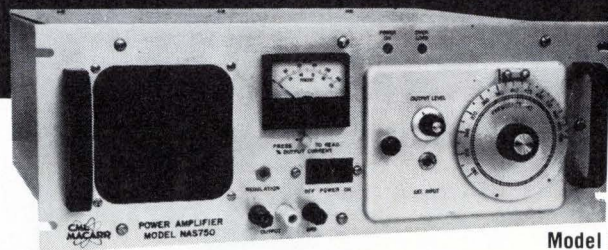

Model NAS-750-1

- Single & Three-Phase Models
- Full Rated Power @ 105-130/210-260V with .7 Pf. Loads
- Current Overload Protection with Automatic Reset
- Harmonic Distortion less than 0.5%
- Modular Plug-In Construction

**FREE!** Send for "How to Apply & Specify Wide Band Power Amplifiers and Frequency Converters."

A Product Line Of

**MARINE ELECTRIC RAILWAY PRODUCTS DIVISION**

166 NATIONAL RD., EDISON, NJ 08817

Telephone No. 201-287-2810 • TWX 710-998-0560

INC.





## New products

boards, bare copper-clad boards, a wide variety of rub-transfer artwork sheets, mylar film, other art materials, all necessary chemicals, and a chemical tray. The 32X-1 sample kit sells for \$11.50 and makes two boards. Kit 32XA-1, which is priced at \$28, makes seven boards.

Exposure of the photoresist re-

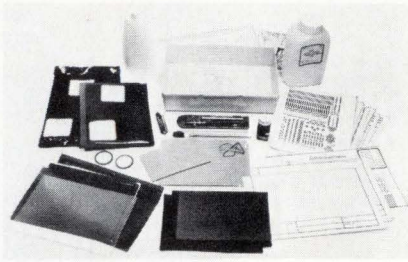

quires approximately four minutes of radiation from an ordinary sun lamp, a commercial ultraviolet lamp, or simply direct sunlight. The developing and etching process requires an additional 20 minutes.

Vector Electronic Co. Inc., 12460 Gladstone Ave., Sylmar, Calif. 91342. Phone (213) 365-9661 [394]

**BAUSCH & LOMB** 

# StereoZoom<sup>®</sup>

microscope

## Built-in dependability and the track record to prove it!

For almost two decades, the Bausch & Lomb StereoZoom microscope has outsold all competitors in the electronics industry. And it's no wonder—with the highest quality, economically priced, zoom optics available in a stereomicroscope. Plus, unparalleled versatility. StereoZoom has earned an impressive record of dependability, whether in use in production, testing or research, and has kept pace with the needs of this fast-changing, growth industry.

Write for a free StereoZoom catalog today and discover why more electronics instrument and component manufacturers use Bausch & Lomb StereoZooms than any other stereomicroscope.

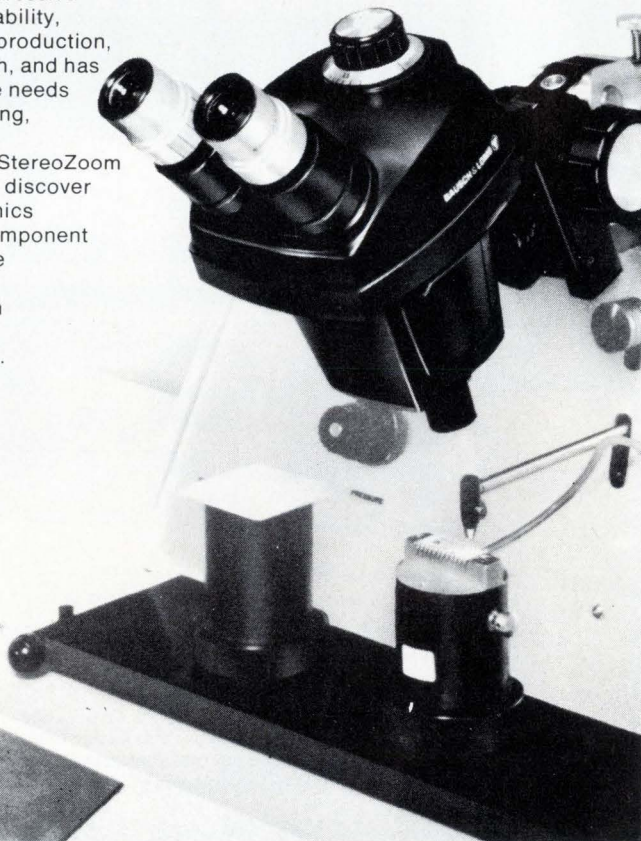

Bausch & Lomb, Scientific Optical Products Division, 62309 North Goodman Street, Rochester, N.Y. 14602.

## Board-edge connector handles 10 A per contact

Designed for use with single-sided 1/16-inch-thick circuit boards, the Berg Power-Edge Connector has a current rating of 10 amperes per contact. Spaced on 0.156-inch centers, its contacts derive their performance from a dual-beam design

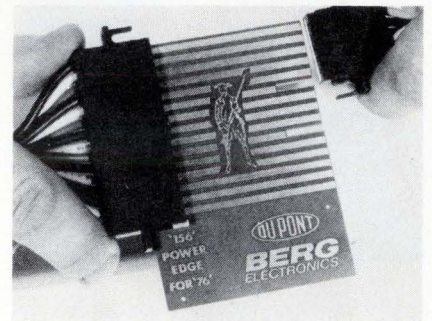

that combines low insertion force with positive pad-wiping action. The connector is offered with five, nine, and 15 positions and can accommodate 14- and 16-gauge wire.

Berg Electronics Division, Du Pont Co., Route 83 South, New Cumberland, Pa. 17070. Phone (717) 938-6711 [396]

## Parallel configuration makes parametric tester fast

Because it uses parallel pin electronic cards, the LSI-800 is able to perform parametric tests on all pins of an LSI device at the same time. As a result, the Datatron tester is claimed to be three to four times faster than conventional LSI testers. "Our patented parallel parametric capability helps us tally a two-station wafer-probe throughput on



**When you want a small package delivered fast, it's in the bag.**



Delta's DASH guarantees delivery on the flight or routing you specify between all Delta cities and most cities served by other airlines through interline agreements. Packages accepted up to 50 lbs. with length plus width plus height not to exceed 90".

Call Delta for an expedited pick-up, or bring your package to Delta's passenger counter at least 30 minutes before scheduled departure time (or to the air cargo terminal at the airport 60 minutes before scheduled departure time). The package can be picked up at the DASH Claim Area next to the airport baggage claim area 30 minutes after flight arrival at destination. Or we deliver it at an additional charge. **DELTA**  
The airline run by professionals.

**Rate examples (Tax included)**

Atlanta-Washington . . . . .	\$21.00
Boston-Miami . . . . .	26.25
Los Angeles-New Orleans . . .	31.50
Dallas/Ft. Worth-Los Angeles . . . . .	26.25
San Francisco-Atlanta . . . . .	31.50
Philadelphia-Houston . . . . .	26.25
New York-Tampa . . . . .	26.25
Chicago-Orlando . . . . .	26.25
Detroit-Memphis . . . . .	21.00

For full details, call Delta reservations.

For expedited pick-up and delivery at extra charge, call 1-800-424-1092 toll free anywhere in the Delta system. In Washington, D.C. call 466-3131.

**Delta is ready when you are.**

Circle 161 on reader service card

**New products**

7495 registers, for example, of 24,000 items per hour versus only 6,500 items per hour for all other testers," says Jim Sutter, director of corporate marketing.

The 10-megahertz computer-controlled machine sells for \$350,000 plus \$20,000 for a wafer prober. It can generate both algorithmic pat-

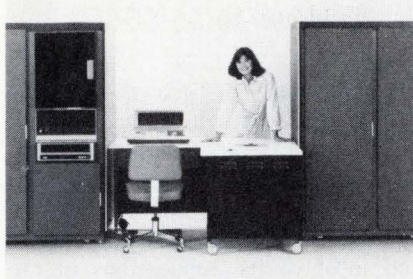

terns for testing random-access memories and true random patterns for microprocessor testing. A library of test programs that the user can access by means of an acoustic coupler built into every LSI-800 is maintained by the company.

Datron Inc., Test Systems Division, 1562 Reynolds Ave., Irvine, Calif. 92714. Phone Jim Sutter at (714) 540-9330 [395]

DEC-compatible panels have pins on same side as sockets

A series of wire-wrappable packaging panels that accepts plug-in ICs still is narrow enough to be used in Digital Equipment Corp. PDP/8 and PDP/11 minicomputers. The size compatibility is a result of mounting both wire-wrappable pins and IC sockets on the same side of the board. Previous wrapped-wire plug-in IC boards have had their pins on the back side where they demanded more total board clearance.

The panels can be spaced on half-inch centers, and each 16-position socket has wrapped-wire terminals long enough for three-level wiring. The boards range in price from \$50 to \$100 each and have a delivery time of four to six weeks.

Garry Manufacturing Co., 1010 Jersey Ave., New Brunswick, N.J. 08902. Phone Harry A. Koppel at (201) 545-2424 [398]

**Q. How do you resolve two signals spaced 1 Hz apart at 2 MHz?**

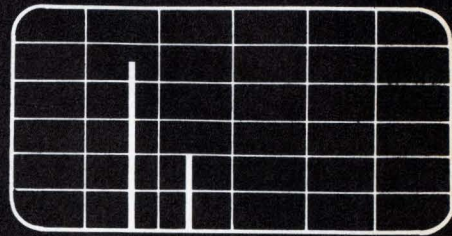

**A. With EMR's new Model 1520 Digital Spectrum Translator and Model 1510-03 Digital Real-Time Spectrum Analyzer.**

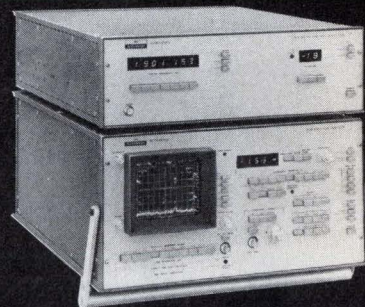

Why go partway in analyzing data? Get the resolution/performance edge of our Model 1510-03 Digital Real-Time Spectrum Analyzer, then go it one better. Enhance frequency resolution still more by adding the Model 1520 Digital Spectrum Translator to concentrate the full resolution of the Analyzer about a selectable point of interest in the spectrum. For that matter, why stop there? Step up from 25.6 kHz to a full 2 MHz upper frequency limit by adding the optional Model 1521 Range Extension Module, too!

Other features of the unequalled 1520 Translator: nine translatable frequency ranges from 25.6 Hz to 10.24 kHz; center frequency selectable in 1-Hz steps and automatic gain ranging — each with an easy-to-read LED display; plus, an automatic frequency sweep. Full-scale out-of-band signal to minimum-detectable in-band signal exceeds 100 dB.

**EMR Schlumberger**

EMR Telemetry  
Weston Instruments, Inc.  
Box 3041, Sarasota, Florida 33578  
(813) 371-0811

Circle 194 on reader service card



**Bypass the middleman!**

**Save more than 55%  
with unsurpassed quality  
and performance!**

**Delivery from stock!**



# Deltron Slashes the Price of $\mu$ Processor Power Supplies

**MPS-1: \$77**

**MPS-2: \$88**

**In any quantity!**

Full one year  
guarantee.  
Designed for U.L.

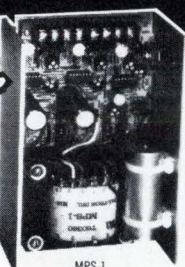

MPS-1

The MPS-1 or  
MPS-2 powers  
virtually any  
Microprocessor  
available. For that  
rare exception,  
talk to us about  
a custom unit.

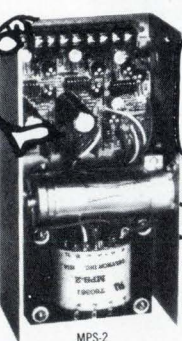

MPS-2

Automatic  
overload and  
adjustable  
overvoltage  
protection. Dual  
input voltage,  
0.1% regulation,  
1.5 mV ripple  
and noise.

MODEL	VOLTS	AMPS			PRICE ANY QUANTITY
		40°C	50°C	60°C	
MPS-1 7 x 4% x 2%	5 ± 5% Adj.	3.0	2.5	2.0	\$77
	12 ± 5% Adj.	0.6	0.5	0.4	
	9 to 12V Adj.	0.6	0.5	0.4	
	or 5V	0.38	0.38	0.38	
MPS-2 9 x 4% x 2%	5 ± 5% Adj.	7.0	6.0	5.0	\$88
	12 ± 5% Adj.	1.0	0.9	0.8	
	9V	1.2	1.1	1.0	
		0.75	0.65	0.55	

Why buy brand A?  
Deltron's got them  
spec for spec  
at half the price.

**Next time get the best  
for a lot less...  
write or call collect to:**

**Deltron inc.**

Wissahickon Avenue, North Wales, Pa. 19454  
215-699-9261, TWX 510-661-8061

## New products

Communications

### Synthesizer aims at CB market

Siemens uses metal-gate  
p-MOS to get price of  
device down to \$5-\$6

The phenomenal growth of the American market in citizens' band radio has not gone unnoticed by European manufacturers. For instance, Siemens AG now expects its S187 digital frequency synthesizer to find most of its applications in CB equipment and therefore the bulk of its sales in the U.S.

Originally a custom design for a German radio manufacturer, the highly sophisticated circuit needs only one quartz-controlled crystal to tune to any CB channel and can derive from that one crystal up to 550,000 frequencies. According to Werner Flagge, product marketing manager for industrial MOS circuits at the company's Munich-based components division, the metal-gate p-channel MOS circuit will sell for between \$5 and \$6 in quantity—less than the price of single-crystal frequency-synthesizer chips made by U.S. manufacturers from the more

expensive complementary MOS process. The S-187's huge channel capacity also suits it for scanning receivers, signal generators, and navigational aids, particularly for digital channel selection in uhf radio.

The S-187, to go to market this fall, integrates some 800 transistor functions in a 10-mm<sup>2</sup> area. The depletion-mode p-MOS process keeps power dissipation to a relatively low 100 to 120 milliwatts even at high frequencies. The device operates off a simple 10-volt supply, can be used over a temperature range of 0°C to 70°C, and comes in a 28-pin plastic package weighing only 3 grams.

As Flagge explains it, a large-scale-integrated-circuit chip is at the center of a phase-locked-loop frequency-synthesizer circuit, consisting of a 6.4-megahertz quartz-controlled reference oscillator (linked to an on-chip eight-stage switchable asynchronous reference divider) and a voltage-controlled oscillator (linked to an on-chip programmable synchronous signal frequency divider). The outputs from the two on-chip dividers are fed to an on-chip digital phase comparator.

Since a phase synthesizer on an MOS LSI circuit cannot have more than a 2.5-megahertz input, an external prescaler must be used. This circuit, which employs emitter-coupled logic, is switched between divide-by-10 and divide-by-11 ratios

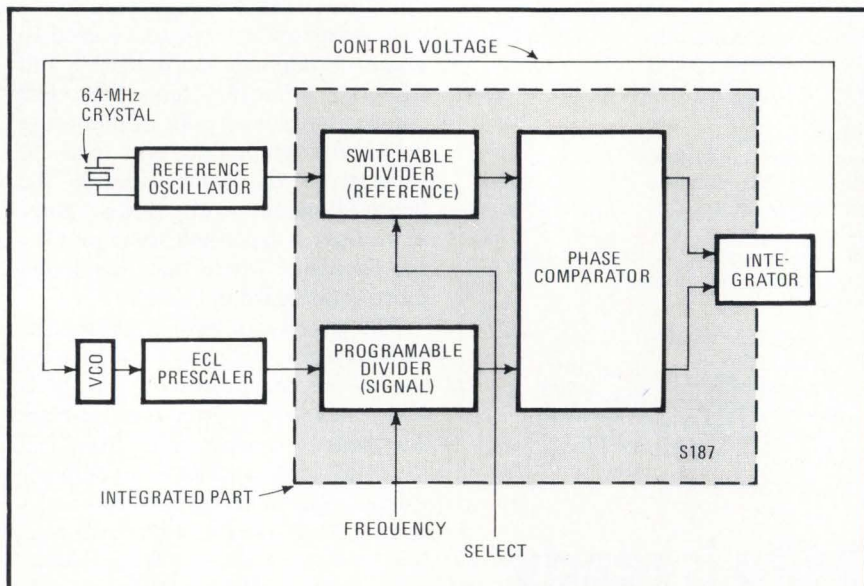



by a synchronous enable signal from the LSI chip.

For frequency programing, various signal sources may be used. In constant-frequency applications, for instance, the input to the dividers may be open or hard-wired to a supply or, when it's a multiple-channel application, driven by transistors, a digital network, or a programable read-only memory. The PROM, which might be a Siemens S353, would be driven by a multi-decade input circuit.

Siemens AG, Components division, 8000 Munich 80, Balanstr. 73, West Germany; Siemens Corp., 186 Wood Ave. South, Iselin, N.J. 08830 [401]

### Low-bloom CCTV camera has 57-dB dynamic range

Bright highlights cannot cause excessive blooming with the model TC1005/HO1 low-light-level closed-circuit-television camera. The camera, which has a dynamic light range of 500,000:1 (57dB), offers 650-line resolution and can be used at reflected-scene brightness levels as low as 0.02 foot-lambert. Its performance is largely attributable to a low-bloom, separate-mesh, magnetic-focus vidicon that uses a 1-inch silicon target.

Weighing only six pounds, the rugged camera is design-tested for 3-g swept sine-wave vibration from 15 hertz to 2 kilohertz and for 50-g shock. It will operate from 0°C to 140°C at relative humidities up to 95%. Price, without lens, is \$1,265 and delivery is from stock.

RCA Closed Circuit Video Equipment, New Holland Ave., Lancaster, Pa. 17604. Phone (800) 233-0421 [403]

### Voice-frequency-level tracer is aimed at lab and field

Battery-operated and light in weight, the model K2001 voice-frequency-level tracer is small and rugged enough for field-service use. Additionally, it operates from 115 v

# When Clear Displays Count

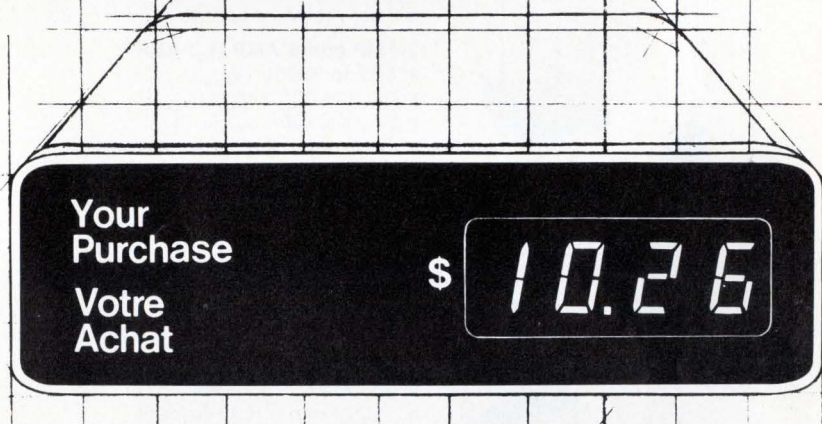
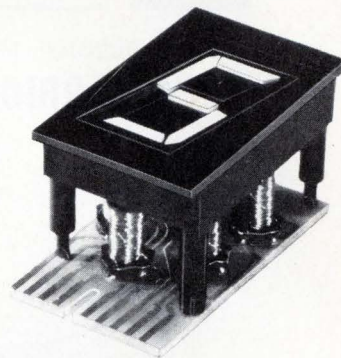

You can count on Ferranti-Packard's electromagnetic 7-Bar display module to give you the electronic compatibility you need plus the reliability and visibility your customers demand.

Only 7 moving parts to each display module — no complex mechanical linkages to wear out, or incandescent lamps and neon tubes to burn out. Performance-proven for over 5 years, the simple design and construction, backed by Ferranti-Packard research and engineering, gives you the combination of reliability, visibility and flexibility that no other read-out component can match.

When you design an electronic read-out system, Ferranti-Packard display modules will help you do it better. It's clearly the display module you should consider. See the difference for yourself, write or call us and we'll prove it.

**When clear displays count — Specify Ferranti-Packard.**



## Ferranti-Packard Limited

Electronics Division,  
121 Industry Street,  
Toronto, Ontario, M6M 4M3, Canada  
Telephone: (416) 762-3661  
Telex: 06-22007





The Industry's Most Complete Line of  
**EPOXY BRIDGE RECTIFIERS**

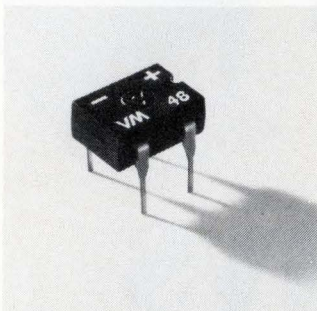

1 AMP

- DIB**  
**1 Amp Dual-in-Line Bridge**
- 4 pin, low-profile DIP
  - 25V to 1000V ( $V_{RRM}$ )
  - 25A 1/2 cycle surge, ( $I_{FSM}$ )
  - Standard .10" grid DIP lead spacing
  - Compatible with automatic handling, testing, inserting.

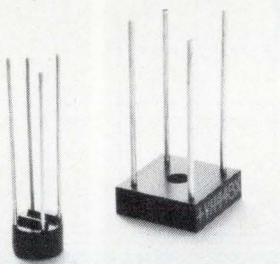

1 AMP    2 AMP    6 AMP

- 1 AMP ( $I_O$ ) EBR**
- 25V to 1000V ( $V_{RRM}$ )
  - 25A 1/2 cycle surge ( $I_{FSM}$ )
  - Controlled avalanche series (250V to 850V min  $V_{BR}$ )
  - Fast recovery series

- 2 AMP and 6 AMP ( $I_O$ ) EBR**
- 50V to 1000V ( $V_{RRM}$ )
  - 2A has 50A surge ( $I_{FSM}$ )
  - 6A has 100A surge ( $I_{FSM}$ )
  - Controlled avalanche series (250V to 850V min  $V_{BR}$ )
  - 2A Fast Recovery Series

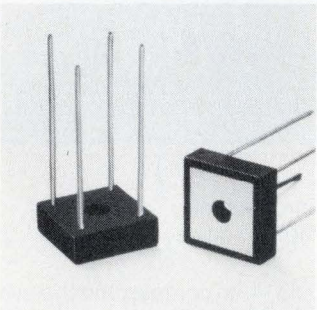

10 AMP

- 10 AMP ( $I_O$ ) EBR**
- 50V to 1000V ( $V_{RRM}$ )
  - 100A surge ( $I_{FSM}$ )
  - Controlled Avalanche series (250V to 850V min  $V_{BR}$ )
  - 200 nsec ( $t_{rr}$ ) series
  - 1500V min circuit-to-case insulation.

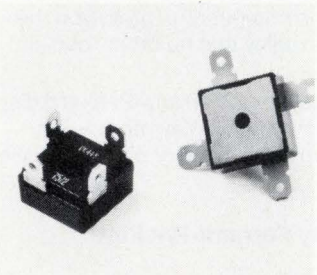

15 & 30 AMP

- 15 AMP & 30 AMP ( $I_O$ ) EBR**
- 50V to 1000V ( $V_{RRM}$ )
  - 15A has 100A surge ( $I_{FSM}$ )
  - 30A has 300A surge ( $I_{FSM}$ )
  - 200 nsec ( $t_{rr}$ ) series
  - 1500V min circuit-to-case insulation.
  - 1.5 °C/W max  $R_{\theta JC}$

Call Mike Hawkins  
 214/272-4551  
 for more information



Design us in . . . we'll stay there  
**VARO SEMICONDUCTOR, INC.**

P.O. BOX 676, 1000 N. SHILOH, GARLAND, TEX. 75040  
 (214) 272-4551 TWX 910-860-5178

EUROPEAN OFFICE: UK: VARO SEMICONDUCTOR INTERNATIONAL, INC.  
 Deepdene House, Bellegrove Road, Welling, Kent, England DA163PY, 01-304-6519/0

**New products**

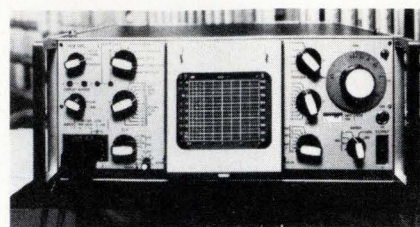

ac so that it can be used in the office or laboratory. The unit is designed to measure voice-frequency response from 200 hertz to 4 kilohertz. It has three fixed sweep times of 2, 4, and 8 seconds, as well as a fourth sweep rate that can be adjusted between 1 and 25 seconds. The K2001 has a 2.75-by-3.33-inch CRT display and a sensitivity of -104 dbm with the K3010 option. Its price is approximately \$3,000. Delivery time is two weeks.

Communications Equipment Division, Siemens Corp., 186 Wood Ave. South, Iselin, N.J. 08830 Phone (201) 494-1000 [404]

**Microprocessor-based fault locator is easy to use**

Designed to locate opens and split faults in telephone cables as quickly and easily as possible, the model 4910G contains a microprocessor that performs all necessary calculations. There is no analog meter to read, no multiplier scale to translate, and no null to adjust.

To locate an open circuit, the user connects tip, ring, and ground clips and then pushes the distance-to-open button. Distance is displayed automatically on a digital readout. Locating splits is just as easy with three push buttons yielding data on distance to the split, distance from the far end to the split, and distance to the far end.

Although calibrated for use with standard 0.083-microfarad-per-mile cable, the 4910G can be modified for use with other cable types. The battery-powered portable instrument is housed in a rugged water-resistant case. It sells for \$1,395. Deliveries are to begin late this year.

Inquiries Manager, Hewlett-Packard Co., 1501 Page Mill Road, Palo Alto, California 94304. [405]



## New literature

**Microwave detectors.** An article on the selection and application of microwave detectors comprises Vol. 8, No. 1, of *The Narda Probe*, a quarterly publication, which can be obtained from The Narda Microwave Corp., Plainview, N.Y. 11803. The eight-page document covers point-contact, Schottky, and back diodes. Circle reader service number 421.

**Optical instruments.** A catalog of optical production and inspection equipment for the electronics industry has been published by E. Leitz Inc., Rockleigh, N.J. 07647. It contains data on a step-repeat camera, mask comparators, a wide variety of measuring and inspection microscopes, optical comparators, automatic mask-measuring machines, a mask-repair station, and various other instruments and accessories. [422]

**Microwave counters.** Application Note 144, "Understanding Microwave Frequency Measurements," discusses and compares three common techniques for down-converting microwave signals: prescaling, heterodyning, and use of the transfer oscillator. It should help readers select the type of counter best suited to any specific measurement problem. Copies are offered by the Inquiries Manager, Hewlett-Packard Co., 1501 Page Mill Rd., Palo Alto, Calif. 94304 [423]

**Timers and programers.** A line of solid-state timers and programers for the control of machines, processes, and lighting displays is presented in a 16-page brochure put out by Bayside Timers Inc., 43-69 162 St., Flushing, N.Y. 11358. An introductory section briefly discusses the state of the art and provides guidance in choosing between solid-state and traditional electromechanical controllers. [424]

**Switches.** A 24-page catalog with line drawings, photos, specifications, and ordering information on more than 300 switches is available from Chicago Switch Inc., 2035 Waban-

**Every Allied Office Is A Stocking Location . . .  
And Now There Are THREE NEW Locations to  
Better Serve Your Electronic Needs . . .**

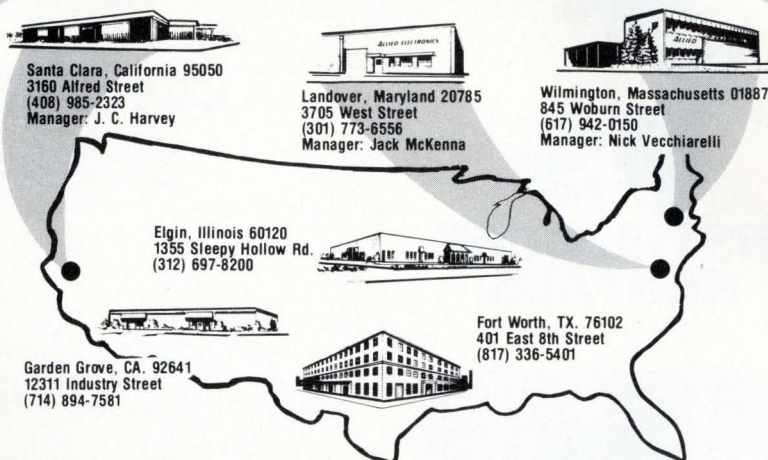

**Allied Shipped Complete FROM STOCK 88.9%  
of All Line Items Written During April,  
May and June of 1976**

**Also, on Over 50% of the Balance, Partial's Were Shipped!**

Need parts instead of promises? Put Allied's staff of trained sales personnel to work for you! Get the parts you need when you need them — our six coast-to-coast stocking locations are ready and eager to help you. While others have less than a 75% fill from stock, we are continuing to improve on our higher (88.9) percent fill. And, we put our money where our mouth is! Any catalogued line item that Allied does not ship within one week, Allied will pay the shipping charges. This applies to all orders with the exception of Export, Pack and Hold, Ship Complete and Drop Ships.

**NEW 1977 ALLIED ELECTRONICS ENGINEERING MANUAL AND  
PURCHASING GUIDE NOW AVAILABLE FOR YOU . . .**

Our 1977 Guide fully describes thousands of electronic parts, components and replacement devices for Design Engineers, maintenance people, planners, estimators, buyers — anyone who specifies and uses electronic products. FREE to readers of this publication. Circle Reply Number below ad or send your request on company letterhead to:

**Allied Electronics, Dept. E-9, 401 East 8th Street,  
Fort Worth, Texas 76102.**

**"Number One Parts Place"**

**ALLIED ELECTRONICS**

**A DIVISION OF TANDY CORPORATION**

Circle 165 on reader service card

**HOPE**  
**in a word is what we are.**

Project HOPE exists because there are people with hope — people who have given 3.5 million men, women, and children on four continents the chance for happier, more productive lives through improved health care.

Give to

**PROJECT  
HOPE**

Department A  
Washington, D. C. 20007



# NEW US INSTRUMENT RENTALS

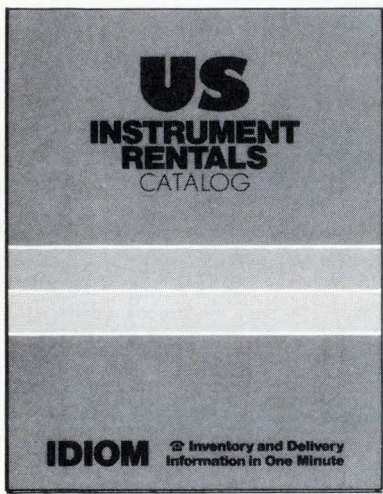

A RENTAL GUIDE  
FOR INSTRUMENTATION  
USERS

- Why **US** ?
- Rental Concept & Applications
- Complete New Equipment Index

Your Complimentary  
Copy is Waiting.  
Circle the Bingo or  
Call Any of the 14  
USIR Regional Offices.

Headquarters  
951 Industrial Road  
San Carlos, CA 94070  
(415) 592-9225

## New literature

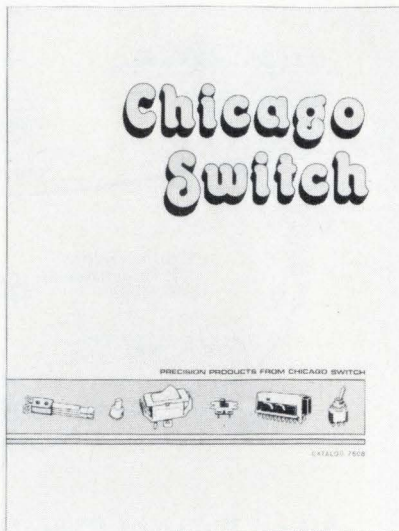

sia, Chicago, Ill. 60647. Among the new items in catalog 7608 are miniature toggle switches and the double-pole, double-throw 38 series rocker switch, which is housed in the same size of package as the company's single-pole rockers. [425]

**Power amplifiers.** The line of solid-state linear power amplifiers manufactured by ENI is described in a catalog that can be obtained from Electronic Navigation Industries



Inc., 3000 Winton Road South, Rochester, N.Y. 14623. The 24 pages deal with amplifiers that cover the frequency range of 9 kilohertz to 540 megahertz and power levels of 300 milliwatts maximum to more than a kilowatt. [426]

**VAC**  
VACUUMSCHMELZE

## VACOZET®

a semi-hard  
magnetic alloy  
with rectangular  
hysteresis loop  
for impulse controlled  
self latching relays.

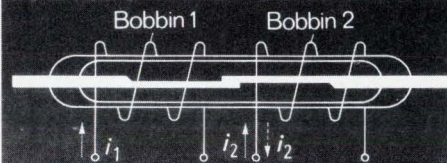

Properties:

- high remanence
- adjustable coercitive force

VACOZET	200	258	655	923	
H <sub>C</sub>	A/cm	15	30	50	75
B <sub>r</sub>	T	1.5	1.45	1.45	1.25
B <sub>r</sub> /B <sub>100</sub>	%	ca. 90			

For data sheet and  
further information apply to

**VACUUMSCHMELZE  
GMBH**

**6450 HANAU**

W.-Germany · POB 109



## New literature

**Microwave filters.** More than 23 types of filters covering the frequency range of 20 megahertz to 12 gigahertz are described in great detail in a 40-page catalog that also has a section devoted to integrated microwave subassemblies. Curves for attenuation, insertion loss, frequency-bandwidth tolerance, and filter length are among the specifications given. Copies may be obtained from Telonic Altair, 2825 Laguna Canyon Rd., Box 277, Laguna Beach, Calif. 92652 [427]

**Flat cable and connectors.** A 20-page catalog on flat cable and connectors is available from Alpha Wire Corp., 711 Lidgerwood Ave., Elizabeth, N.J. 07207. It contains information

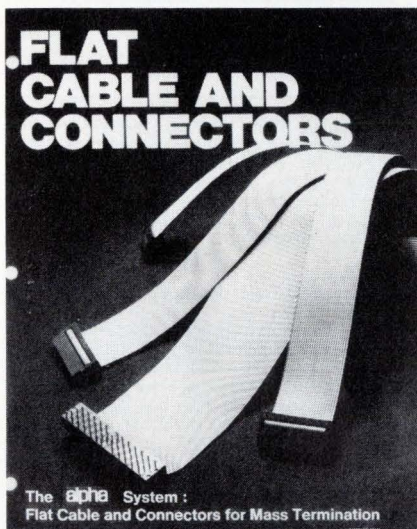

on: connectors that allow the user to inspect the connections before covering and crimping them; flat cables with from 14 to 50 conductors; 14- and 16-pin DIP connectors, and various other connectors and assembly tools. Ask for catalog FC-2. [428]

**Infrared microscopy.** An infrared imaging device for microscopic objects, the model RM-50, is the subject of a brochure put out by Barnes Engineering Co. 30 Commerce Rd., Stamford, Conn. 06904. The device is typically used for thermal studies of integrated circuits. Ask for bulletin 12-970 on the Infrared Micro Imager. [429]

# Balco

DIVISION

Capacitors for  
Time Circuits  
Delay Lines  
R. C. Oscillators  
Integrators

- Smallest Size
- Exceptional Performance
- Low Cost
- Fast Delivery
- Long Term Stability

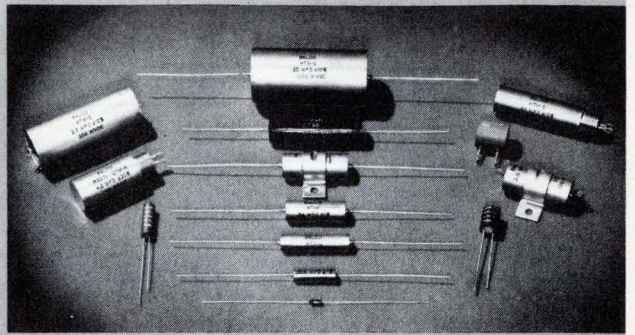

featuring Clear and Metalized DuPont TEFLON® types.

Style Parameters	Extended Foil (RTWGX)	Metalized Film (RTWGMX)
Capacitance Range ( $\mu\text{F}$ )	0.0005 to 2.0	0.05 to 4.0
Working Voltage (Vdc)	50 to 600	50 to 600
Temperature Coefficient	$\pm 1.5\%$	$-90 \text{ PPM}/^\circ\text{C}$ $\pm 40$
DF at 25°C and 1 kHz (%)	0.05	0.1
Operating Temperature Range ( $^\circ\text{C}$ )	$-55$ to $+175$	$-55$ to $+175$
Dielectric Absorption (%)	$< 0.05$	$< 0.05$
IR (Ohms)	$> 1 \times 10^{12}$	$> 1 \times 10^{10}$

Contact Custom for capacitors to suit your applications. Write for Brochure



**CUSTOM ELECTRONICS, Inc.**  
Balco Division

12 Browne Street, Oneonta, N.Y. 13820  
Ph: 607-432-3880 TWX: 510-241-8292

Circle 167 on reader service card

# THE SUNSHINE STATE OFFERS HIGHER PROFIT POTENTIALS TO ELECTRONIC PRODUCTS MANUFACTURERS THAN ELSEWHERE IN THE COUNTRY!

Florida's substantial labor and operating cost advantages, plus ready access to the markets of the United States, Latin America and the world, combine to offer a unique profit opportunity for a Florida-based manufacturer.

Before you make any decisions regarding your business, this new industry study documenting Florida's position should be reviewed carefully.

To get your copy of *Florida Profit Potentials in Electronic Products Manufacturing*, write or call:

**FLORIDA**  
WE'RE MORE THAN SUNSHINE

Joe Hennessy, Director  
Division of Economic Development  
Florida Department of Commerce  
107 W. Gaines Street, Room 103E  
Tallahassee, Florida 32304  
(904) 488-5507

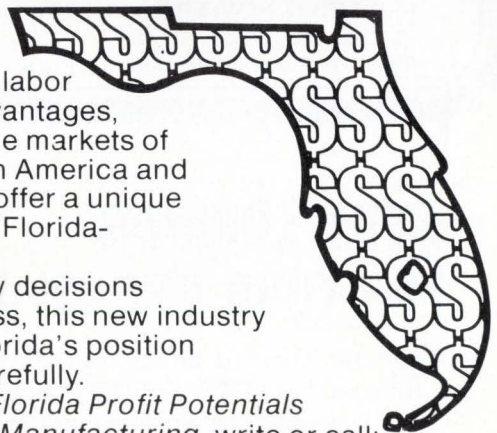



# Classified section FOR ENGINEERING/TECHNICAL EMPLOYMENT OPPORTUNITIES

## CLASSIFIED SALES REPRESENTATIVES

Atlanta ..... Joe Lane . . . . 404/892-2868  
 Boston ..... Holt Buchanan 617/262-1160  
 Chicago ..... Bill Higgins . . . . 312/751-3733

Cleveland ..... Connie Byers 216/781-7000  
 Dallas ..... Rick Ofstie . . . . 214/742-1747  
 Denver ..... Jay Johnson . . . . 303/266-3863  
 Detroit ..... Mac Huestis . . . . 313/873-7410

Houston ..... Rick Ofstie . . . . 713/659-8381  
 Los Angeles ..... Stan Kassir . . . . 213/487-1160  
 New York ..... Holt Buchanan 203/359/2860  
 Dave Hawksby . . . . 212/997/3594

Philadelphia ..... Dan Ferro . . . . 215/568-6161  
 Pittsburgh ..... Pam Petika . . . . 412/391-1314  
 San Francisco ..... Mary Kenny . . . . 415/362-4600  
 XEROX :00 TELECOPIER . . . . 212/997-6800

## PLASMA PHYSICS LABORATORY

A directed research arm of Princeton University funded by the United States Energy Research and Development Administration, is engaged in CONTROLLED THERMONUCLEAR RESEARCH. You will work with foremost scientists and be exposed to a broad interdisciplinary spectrum. Our sophisticated facility is exceptionally equipped. Our continuous growth has created the following opportunities . . .

### DIGITAL ELECTRONIC ENGINEER

An exceptional digital designer is needed in our Instrumentation Section to work with other engineers and programmers on a variety of projects involving mini-computer interface, micro-computers, memory systems, transient recorders, and data acquisition. Desire experience with MSI design techniques. **PROJECT I-22.**

### ELECTRONIC INSTRUMENTATION ENGINEER

Our Electronic Instrumentation Group is involved in a number of varied projects involving analog and digital circuit design, computer interface, radiation detection, signal conditioning, and signal transmissions problems which provide support for diagnostics and data acquisition from large fusion research devices. We seek a Design Engineer who is experienced in most of the above areas. This person must be able to work independently or as a member of a team, as may be required. **PROJECT I-20.**

We offer excellent salaries fully commensurate with your experience, exceptionally comprehensive benefits, and a stimulating and sophisticated environment.

For prompt consideration, please send detailed resume and salary requirements in confidence. Please indicate in your response which position you are interested in by using **PROJECT NUMBER.**

Director of Personnel

**Plasma Physics Laboratory**

POST OFFICE BOX 451  
 PRINCETON, NEW JERSEY 08540

An Equal Opportunity /  
 Affirmative Action Employer M/F

**Princeton University**



### METER ENGINEER

We are looking for an experienced electro-mechanical meter design engineer to help us design new meters using D'ARSONVAL movements. Salary for this key position is open. If a good climate and pleasant work conditions with growth opportunity appeals to you, send your resume now.

Steve Mixsell, Division Manager  
 Airpax Electronics, Inc.  
 6801 W. Sunrise Blvd.  
 Fort Lauderdale, Fla. 33313

Equal Opportunity/  
 Profit Sharing Employer

### ELECTRONICS ENGINEERS/MANAGERS

We are recruiting for nationwide openings. Client companies assume all costs & fees—Confidential. Send resume to **Career Advisors, 125 Wolf Rd., Albany, N.Y. 12205—Affiliates in Key Cities.**

### EMPLOYMENT SERVICE

If you are willing to relocate we have excellent opportunities in Electronics Industry. Executives, Engineers, Sales, others. U.S. abroad. Fee paid 15 to 50K. Send resume. Nationwide Executive Search, Suite 616 Fox Pavilion, Jenkintown, Pa. 19046.

**Biomedical Professionals:** Our clients have numerous openings for qualified and experienced individuals in Technical, Marketing and Managerial positions nationwide. Send resume in confidence to: Health Industry Consultants, P.O. Box 2634, Evergreen, Colorado 80439 or call (303) 674-4696.

**Electronics' Industry Newsletter** tells you which firms have current employment opportunities, in the field of Electronics, for all types of Engineers, Sales Representatives, Technicians, Executives, Computer Personnel and others. Latest product information is also reported. For information write: Electronics' Industry Newsletter, Dept. 304A, 23573 Prospect Avenue, Farmington, MI 48024.

## STILL LOOKING FOR YOUR DREAM JOB?

Then be sure to check out the employment opportunities contained in ELECTRONICS' Classified Section.

Or, why not consider placing a Position Wanted ad? The cost is low (only \$1.25 per line) and the results are often rewarding. For more information call or write:

**ELECTRONICS** Post Office Box 900  
 New York, N.Y. 10020 • Phone: 212/997-2556









# Product Safety Engineer

Tests and evaluates measurement products to applicable UL and CSA standards. Recommends design changes consistent with intent of circuit to achieve compliance with standards. Writes reports describing construction and tests to testing agencies.

Position requires a BSEE or equivalent; a minimum of 2 years design or test and evaluation experience and a good working knowledge of UL and CSA standards.

Tektronix, Inc. develops, manufactures and markets internationally recognized precision electronic measurement instruments, computer peripherals and related electronic instrumentation. Located near Portland, Oregon, we are within a two hour drive of the Cascade Mountains or Ocean Beaches. The close-by nature playgrounds and the City of Portland provide a variety of recreational and cultural interests.

We offer a competitive salary, profit sharing and an outstanding benefits package.

Please send resumes to: Bob Chambers, TEKTRONIX, INC., P.O. Box 500, E81, Beaverton, OR 97077.

An Equal Opportunity Employer M/F



**TEKTRONIX**  
committed to  
technical excellence

Engineering

## ELECTRICAL ENGINEERS R&D

Aggressive, growing manufacturer of data communication terminals has choice opportunities for experienced Electrical Engineers with a minimum of a BSEE degree to handle expanding Research and Development programs.

Strong background in computer software development or digital logic design required.

We offer attractive starting salaries plus participation in a liberal benefit program.



**TELETYPE CORPORATION**

5555 Touhy Ave.  
Skokie, Ill. 60076

An Equal Opportunity Employer M/F

### POSITION VACANT

The Colorado School of Mines is seeking applications to fill a faculty position at the Assistant or Associate Professor level in the area of industrial electronics, control, and instrumentation for the Mineral Industry. Although a Ph.D. degree is desirable, experience in the area is more important. Research in the problems of the Mineral Industry is encouraged. Rank and salary depend upon qualifications. Send a letter of application and resume to Professor Henry A. Babcock, Basic Engineering Department, Colorado School of Mines, Golden, Colorado 80401. An Equal Opportunity Employer.

Graduate Assistantships in Physics can begin during any quarter. Write: Dr. R. Madey, Kent State University, Kent, OH 44242.

### MANUFACTURERS' REPRESENTATIVES

Major U.S. manufacturer of matrix print heads, mechanisms and data terminals needs qualified manufacturers' representatives for France, Spain, Italy, Switzerland/Austria, Belgium, Scandinavia, Eastern Bloc Countries and Canada. Applicants should currently represent computer or peripheral companies, be technically competent and able to service our products. Send resume including current lines and sales volume to:

**MRW-1223**

Electronics, Class. Adv. Dept., P.O. Box 900  
New York, N.Y. 10020

### We have been placing graduate ENGINEERS



in **FEE-PAID** positions THROUGHOUT THE U.S. since '59. Over 1,000 client companies. We are graduate engineers working full-time for you. Send resume & salary history today or request confidential application.

**ATOMIC PERSONNEL, INC.**

Suite L. 1518 Walnut St., Phila., Pa. 19102  
An Employment Agency  
For All Technical Fields

# THIS SPACE AVAILABLE. ONLY \$322.

Your recruitment advertising in this three inch space will cost you only \$46 per inch, or \$322.

You'll reach over 68,000 domestic engineers and technical people, as they're reading to combat job obsolescence, while they're thinking about their future and bettering themselves.

There's no charge for typesetting and free layout service is provided. For more information, call or write:

## Electronics

Post Office Box 900  
New York, N.Y. 10020  
Phone: 212/997-2556



# WHAT ARE YOU WORTH?

In today's job market, that is. One way to see if you're in demand is to check the employment opportunities contained in ELECTRONICS' Classified Section.

Another way to get a reading on your value is to place a blind (box number) Position Wanted ad there. The cost is low (only \$1.25 per line) and the results are often rewarding.

For more information call or write:

## ELECTRONICS

Post Office Box 900  
New York, N.Y. 10020  
Phone: 212/997-2556

## This Classified Section,

featuring only recruitment and sales opportunities advertising, is designed to provide:

**Readers**—over 70,000 EE's and technical managers—with a useful and convenient employment market-place to consult whenever they're thinking about their future and bettering themselves. (Like when they're reading ELECTRONICS to combat job obsolescence.)

**Advertisers**—with low competitive rates (see above), pre-screened qualified circulation, bonus ADVANCE JOB LISTINGS preprint and free ELECTRONICS MANPOWER REGISTER searches and resumes.

We believe we offer both reader and advertiser alike the most complete recruitment program offered by any electronics publication. (And, ELECTRONICS is the technical magazine for technical people.)

To find out more about any of the above, contact the Classified sales representative in the McGraw-Hill regional office nearest you.

# SYSTEMS SOFTWARE

## Do you respond to challenge?

If you're one of those rare professionals that respond well to challenge, then perhaps its time you investigated these excellent opportunities now available with Lockheed. We're looking for dedicated professionals ready to advance the state-of-the-art in their field, and who require plenty of variety and rewards to equal the challenges. If you're such an individual, then see if you qualify now. *Positions on the San Francisco Peninsula.*

### Data Base Administrators

DBA with large scale IMS DB/DC experience required to aid in establishing a DBA function in an organization migrating from a large scale in-house DBMS to IMS/VS. You should have heavy data base design and implementation experience with extensive applications programming or systems software background. Data Dictionary Systems experience highly desirable.

### Systems Programmers

You must have a minimum 2 years' experience in data processing with some assembly language and familiarity with large scale operating systems. Experience on large IBM systems (360 or 370) preferred but not required. Experience and knowledge of internals would be required in any ONE of the following software areas:

\*Operating Systems \*Data Base Management  
\*Communications \*Teleprocessing \*Network Control Programs \*Timesharing Systems and associated languages \*Utilities \*Space Management

You will be responsible for installation and maintenance of IBM 370 systems Software and Development of in-house systems software as required; college degree or equivalent related experience preferred.

### Data Systems and Computer Software Engineers

Immediate openings available for senior individuals to conduct systems level hands-on design studies. Must have a minimum of 6-10 years' experience in the following:

\*conducting trade studies on airborne vs. ground data systems; \*developing algorithms for data processing; \*designing and implementing advanced data base concepts; \*implementing advanced design concepts using minicomputers, microprocessors; \*performing systems-level design including sizing, timing studies on real-time processing problems.

Appropriate BS degree mandatory, with MS degree desirable.

If you are interested and qualified, and a U.S. citizen, then take charge of your future today and advance the state-of-the-art with other dynamic professionals who enjoy challenge and responsibility. You can expect an excellent salary, wide range of benefits and the excitement of using your talents and ideas to the fullest.

For immediate consideration, please send your resume with salary history in confidence to Professional Employment, Dept. M-4, P.O. Box 504, Sunnyvale, California 94088. We are proud to be an equal opportunity affirmative action employer.

**LOCKHEED**  
MISSILES & SPACE COMPANY



## ELECTRONIC ENGINEERS

McDonnell Douglas Corporation, St. Louis, Missouri, has immediate career opportunities to support programs on F-18, F-15, F-4, AV-8B Harrier V/STOL, Future Tactical Strike, Air Combat and Reconnaissance, Harpoon, Tomahawk and Space Shuttle.

### AVIONICS

FIRE CONTROL  
DIGITAL FLIGHT CONTROL  
COCKPIT DISPLAY  
COMPUTER SOFTWARE  
INERTIAL GUIDANCE  
DIGITAL COMPUTERS  
ELECTRO MAGNETICS

### AGE

FLIGHT SIMULATOR  
SOFTWARE  
SYSTEMS

### FLIGHT SIMULATION

REAL-TIME,  
PILOT-IN-THE-LOOP  
SOFTWARE  
COMPUTER SOFTWARE  
DESIGN  
VIDEO SYSTEMS

### TECHNOLOGY

GUIDANCE & CONTROL

If you meet the above qualifications, please send your resume in confidence to:

J. H. Diller  
Section Manager-Professional Employment  
Department EL-16  
P. O. Box 516  
St. Louis, Missouri 63166

**MCDONNELL DOUGLAS**



An Equal Opportunity Employer m/f

electronics

## electronics engineer

Professional opportunity for Electronic Design Engineer, BSEE, with minimum five years' related experience.

Responsibilities will include design and development of micro-processor based electromechanical products, primarily in hardware and software interfaces, real time processor systems, software reliability and performance evaluation.

This position will require supervision of test technicians and customer applications support.

Please send your resume in confidence to Tally Corporation, 8301 South 180th, Kent, WA 98031.

An Equal Opportunity Employer M/F

**TALLY**

## MOS ENGINEERS

Extraordinary avenues to professional advancement begin at AMI...

As we begin our second decade of growth... with new leadership... exceptional growth opportunities exist as never before!

## DESIGN ENGINEERS

Assume complete responsibilities from customer specs through first silicon. Work on a variety of consumer and telecommunications products, as well as memories and State-of-the-Art technologies. Minimum 3 yrs. MOS experience and a strong background in device physics plus a BS degree required.

## PRODUCT ENGINEERS

You must have in-depth knowledge of MOS technology combined with minimum of 2 years experience in Product Engineering. Our Product Engineers are a vital link in both customer interface and AMI's Circuit Design and Applications Engineering BS preferred.

Send your resume, including salary history, to Terri Johnson, Employment Manager, AMI, 3800 Homestead Road, Santa Clara, CA 95051. We are an equal opportunity employer M/F.

**AMI**

AMERICAN MICROSYSTEMS INC.



## SENIOR ENGINEER Microelectronic Design

This is an outstanding opportunity to make significant contributions in the area of sophisticated hybrid microelectronics. Working in a high technology environment, you will be responsible for development and design, including layout and supervision of support activities through the selection of process and partitioning techniques. A BSEE is required plus a minimum of 3-5 years experience in design and development with a strong digital and analog background.

We offer a very competitive starting salary, excellent benefits, and an exceptional opportunity to grow in a new, and rapidly expanding technology. If you are a U.S. citizen, please send your resume to Dept. ELEC 827.

### GOULD OCEAN SYSTEMS DIVISION

18901 Euclid Avenue  
Cleveland, Ohio 44117

An Equal Opportunity Employer, M/F/H.



**RATES** \$46 per advertising inch (7/8"). Commissionable.  
**SIZES** 7/8" to 10" deep in widths of one column (1 1/8"), two (3 3/8"), three (5 1/8"), and four (7").  
**CLOSING** Two weeks prior to mailing.  
**MAILING** One week prior to issue date.  
**ISSUE DATE** Every other Thursday.  
**AD ORDERS/BOX NUMBER ANSWERS** Send to Electronics, Post Office Box 900, New York, N.Y. 10020.





**Would  
you hire  
an engineer  
who  
couldn't  
understand  
this  
magazine?**

Of course not. ELECTRONICS is the technical publication for technical people. If they can't understand it, they can't receive it. That's why, when you're looking for qualified engineers, you should consider our Classified Section.

For only \$46.00 per inch your recruitment advertising will reach 46,000 pre-screened engineers—that's just \$1 per thousand!—as they're reading to combat job obsolescence, while they're thinking about their future and bettering themselves.

There's no charge for typesetting and free layout service is provided.

For more information call or write:

**ELECTRONICS**

Post Office Box 900  
New York, N.Y. 10020  
Phone: 212/997-2556

“I've had offers from other companies, but I'm staying right here. I believe in Fairchild because Fairchild believes in me. If you work hard and take advantage of the training they offer, there's no limit to your advancement opportunities here. I did and I've advanced rapidly in 4½ years. Sure my salary has increased significantly, but even more important is the challenge and job satisfaction I've received. I can't think of anything another company could offer me that I'm not already getting at Fairchild.”

Hank Miranda  
Manufacturing Manager  
Bipolar Memory Wafer Fab

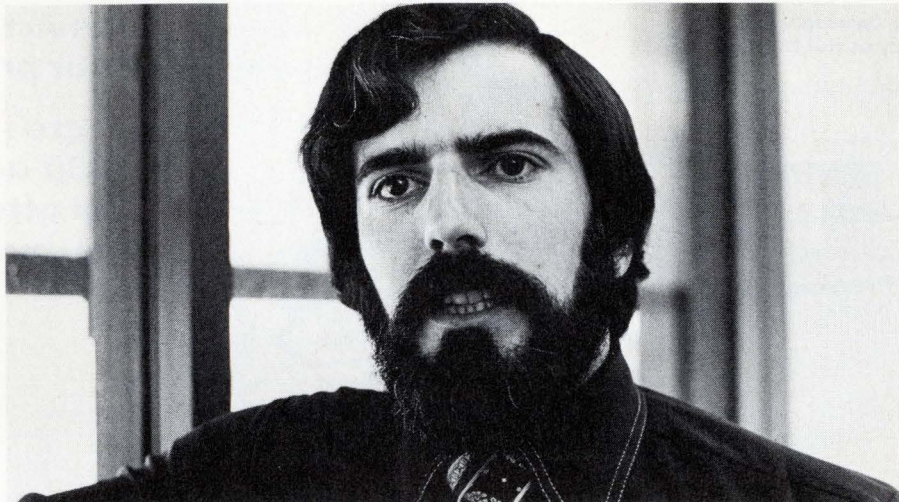

**Fairchild offers more of  
what you work for.**

Our immediate openings include:  
LIC Product Engineers  
Product Manager/Optoelectronics  
Sr. Process Development Engineer/R&D  
Supervisor, MOS Product Engineering  
Sr. Product Engineers/Bipolar/Memory/ECL  
Sr. Process Dev. Engineers/Bipolar & ECL  
MOS Process Development Engineers  
Product Engineer/Transistors  
CMOS Design & Product Engineers  
Hybrid Design & Appl. Engineers

Send your resumé to: Director of Professional Staffing, 464 Ellis Street, MS 22-0100, Mountain View, CA 94042. An Equal Opportunity Employer M/F.



**46,000 engineers for \$46.00**

For only \$46.00 per inch your recruitment advertising in ELECTRONICS' Classified Section will reach 46,000 career-conscious engineers—that's just \$1 per thousand!—as they're reading to combat job obsolescence, while they're thinking about their future and bettering themselves.

There's no charge for typesetting and free layout service is provided. For more information call or write:

**ELECTRONICS**

Post Office Box 900  
New York, N.Y. 10020 • Phone: 212/997-2556







# the Action book?

The Action book is for finding out who makes what, and then contacting the advertiser for information.

Your listing in the Action book is absolutely free. There's absolutely no obligation to take an ad next to your listing. Why do we recommend it? Because it's so much more than

an ad. It's a 230 dollar, year-long advertising campaign. It's the way you get the ultimate action from the Action book.

Telephone bells ring. Mail arrives. Questions are answered. Catalogs are mailed. Salesmen get leads. Orders arrive. This is the way it is with the Action book.

There's no waste circulation in EBG. Surveys show EBG is used

more, with 1/3 the circulation. Which is why your ad costs you much, much less.

You don't send out waste catalogs with EBG. Every catalog goes to somebody who asks for it, who wants it, needs it, uses it.

The Action book is to get sales.

## Action:

To get your current catalog, your prospect just circles his number on a postcard that comes with the Action book. No waste.

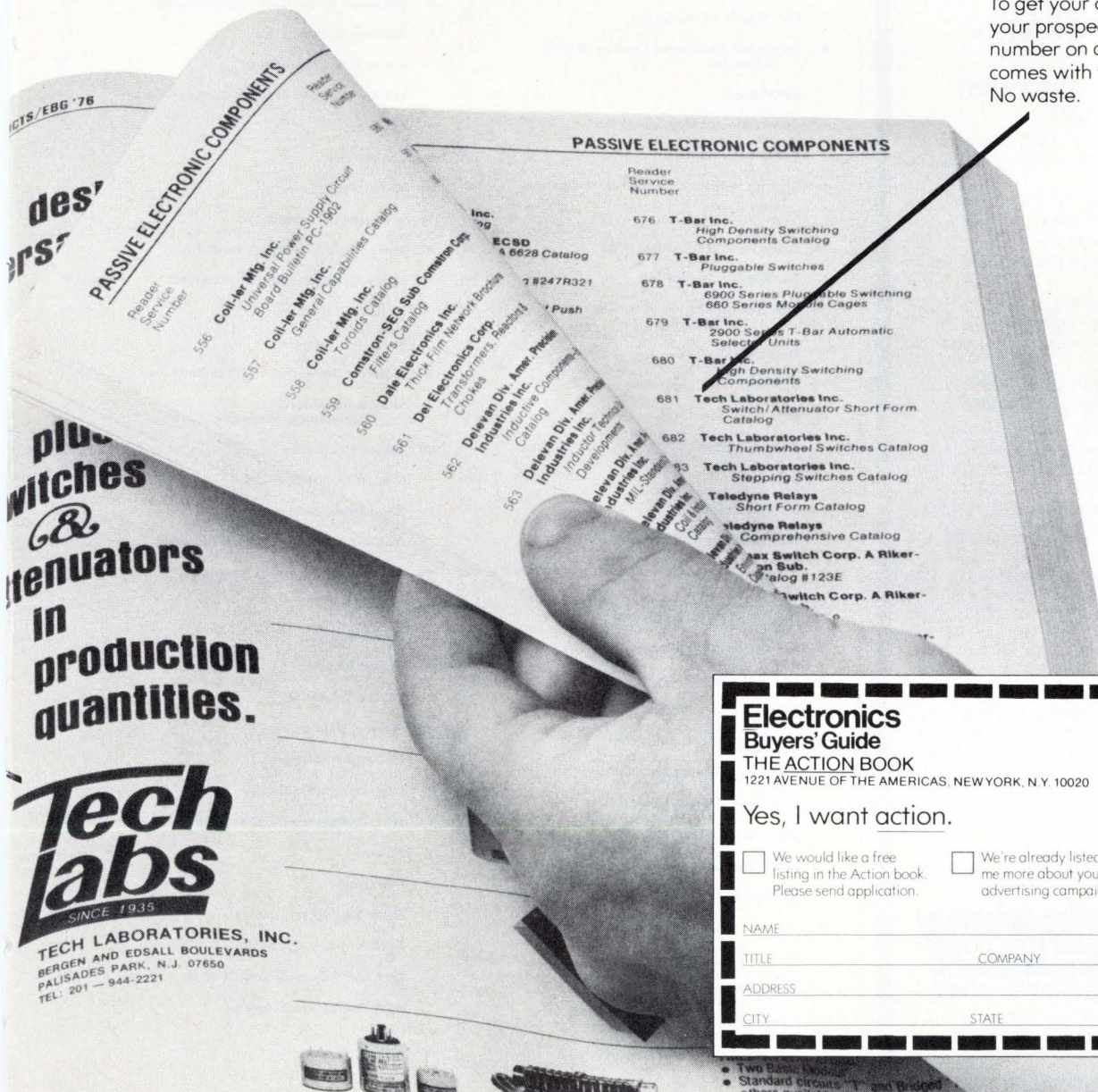

**Electronics Buyers' Guide**  
**THE ACTION BOOK**  
 1221 AVENUE OF THE AMERICAS, NEW YORK, N.Y. 10020

**McGraw-Hill**

Yes, I want action.

We would like a free listing in the Action book. Please send application.       We're already listed but tell me more about your \$230, year-long advertising campaign.

NAME \_\_\_\_\_

TITLE \_\_\_\_\_ COMPANY \_\_\_\_\_

ADDRESS \_\_\_\_\_

CITY \_\_\_\_\_ STATE \_\_\_\_\_ ZIP \_\_\_\_\_



# NEW 3½ Digit Multimeter from B&K-PRECISION



B&K-PRECISION  
MODEL 283—\$170

...you'll want it for its features  
...but its the price that will sell you!

- High intensity LED display is easily read from at least 6 feet in the brightest room
- Measures AC and DC voltage, AC and DC current and resistance.
- 0.5% DC accuracy
- 100% overrange (1000 scale reads to 1999).
- Automatic polarity
- Automatic decimal point
- Flashing overrange indication on display
- Four voltage ranges to 1000V
- Four current ranges to 1000mA.
- Six resistance ranges to 10 meg.
- In-circuit resistance measurements at voltage levels below conduction threshold of semiconductors.
- Overload protection on all ranges

Complete new circuitry makes the Model 283 the most dependable and versatile 3½ digit multimeter you can buy. The extra-bright display allows you to use it where other units would cause reading problems. The selectable "low ohms" function permits accurate measurement of semiconductor shunted resistors.

An optional, internal battery pack (BP-83, \$50.00) provides 8 hours of continuous use on one overnight charging and charges when the Model 283 is in use on 115/230 VAC. Your B&K-PRECISION distributor has the Model 283 in stock and will be glad to demonstrate its features to you. Call him, or write for additional information.

## B&K PRECISION

PRODUCTS OF DYNASCAN  
6460 W. Cortland Avenue  
Chicago, IL 60635 312/889-8870  
In Canada: Atlas Electronics, Toronto

Circle 176 for Product Information  
Circle 197 for Product Information

## Electronics advertisers

• Adret Electronique	4E	Figaro Engineering Inc.	177
Advanced Micro Devices	11	Florida Department of Commerce	167
■ Airpax Electronics	152	■ John Fluke Mfg. Co., Ltd.	79
■ Airpax Electronics Inc.	45	■ Frequency Devices Inc.	177
Allen Bradley Company	34	GCA/David W. Mann	136
Allied Electronics	165	General Instrument Corporation, Microelectronics Division	49
American Optical Corp. Fiber Optics & Industrial Products Division	157	■ Gould Inc., Instrument Systems Division	104
■ AMP Incorporated	128, 129	■ Hewlett-Packard	15-26
• Amphenol Tuchel	27E-30E	■ Hughes Aircraft Company	81, 117
Anritsu Electric Co., Ltd.	8	Indiana General	1
Anzac Electronics	120	Intel Corporation	28, 29
■ Bausch & Lomb Inc.	160	Intel Memory Systems	55
• Bayer AG	35E	■ Interface Inc.	157
Belden Corporation	9	• Intersil Inc.	32, 33
B & K Precision Division Dynascan Corporation	176	■ Ithaco, Inc.	151
■ Bourns Inc.	4th C	• ITT Cannon	19E
• Burr Brown Research Inc.	58	■ Johanson Manufacturing Corporation	30
■ Centralab Electronics Division of Globe Union Inc.	157	■ Johnson Company, E.F.	143
Centronics	2	Krohn Hite Corporation	5
■ Cherry Electrical Products Inc.	31	LFE Corporation Process Control Division	124
Continental Rentals	8	• Logabax	25E
‡ Cortron, A Div. of Illinois Tool Works, Inc.	58	■ Logimetrics	54
Crown Industrial	52	‡ Marconi Instruments	67
• C. P. Clare International N.V.	9E	• Marconi Instruments Ltd.	33E
■ Custom Electronics Inc.	167	■ Marine Electric Railway Prod. Div.	159
• Dale Electronics Inc. A Subsidiary of Lionel Corporation	12E-13E	Micro Switch Division of Honeywell	144, 145
Data Delay Devices	155	Monolithic Memories Inc.	51
Data General Corporation	37	Monsanto Company	130
■ Data Precision	68-69	■ Motorola Semiconductor Products Inc.	56-57
Delta Air Lines	161	• Munchener Messe und Ausstellungsgesellschaft Gmbh	142, 14E
Deltron	162	‡ Nikkei Electronics	178
■ Dialight Corporation	147	■ Nippon Electric Co. Ltd.	154
Digital Equipment Corporation (OEM)	149	■ Non-Linear Systems	150
‡ Digital Equipment Corporation (Components)	62	OAK Industries Inc. Switch Division	70, 71
■ Eastman Kodak Company GMD GD Photofabrication-Microelectronics	156	‡ Omron Corporation of America	32, 33
E. I. DuPont De Nemours & Co. Inc.	127	Optron, Inc.	12
■ E&L Instruments Inc.	158	• Oscilloquartz	20E
Electronic Devices, Inc.	155	• Philips Elcoma	64
■ Electro Scientific Industries	14	• Philips Industries	2E-3E
‡ Electronic Development Corporation	54	■ Phoenix Data Inc.	146
Electronic Navigation Industries	3rd C	■ Piezo Technology Inc.	48
Elgar Corporation	126	• Piher International Ltd.	22E
Elorg Electronorgtechnica	150	Plastics Engineering Company	88
EMR-Telemetry	161	■ Polarad	2nd C
■ Erie Technological Products Co. Inc.	27	■ Powermate	148
Fairchild Semiconductor Inc.	84-85	• Racal Thermionic Ltd.	11E
Faultfinders Inc.	6	Raytheon Semiconductor	53
■ Ferranti Packard	163	RCA Electro-optics and Devices	123
		RCA Solid State Division	77



Refac Electronics	141
✚ Rental Electronics Inc.	64
Reticon Corporation	87
* Rhone Poulenc	17E
* Rohde & Schwarz	1E
Scanbe Mfg. Corp.	148
* Schlumberger	6E, 21E
* Secme	32E
* Seimart	73
* Seem	18E
* Sefram	32E
* Sepa S.p.A	54
* Sescosem	5E, 15E
SGS Ates	13
* Siemens A.G. Munich	62
Sprague Electric Company	61
* Sycor Inc.	16E
Systron-Donner-Data Products Div.	47
* TEAC Corp.	36E
■ Tektronix IDD	132, 133
■ Tektronix Inc.	7, 43
Teledyne Philbrick	38
Teradyne Inc.	74
Teradyne Components Division	153
Texas Instruments Calculator	138, 139
Thyrotek Corporation	50
■ TRW Cinch Connectors	135
✚ TRW/IRC Resistors	72, 73
* Ultra Electronics Components Ltd.	34E
United Systems Corp. a Sub of Monsanto Co.	155
U.S. Instrument Rentals Inc.	166
Vacuumschmelze	166
Varo Semiconductor Inc.	164
Vector Electronics Company Inc.	159
Victoreen Instrument Division	140
■ Wavetek Indiana Inc.	90
* Yokogawa Electric Works Ltd.	67
Zilog	82, 83

**Classified and employment advertising**  
F. J. Eberle, Manager 212-997-2557

Airpax Electronics Inc.	168
American Microsystems Inc.	172
Atomic Personnel Inc.	170
Career Advisors	168
Fairchild	173
Gould Ocean Systems	172
Lockheed Missiles & Space	171
McDonnell Douglas Corp.	172
Memorex	169
Princeton University	168
Tally Corp.	172
Tektronix Inc.	170
Teletype Corp.	170

■ For more information of complete product line see advertisement in the latest Electronics Buyers Guide  
\* Advertisers in Electronics International  
‡ Advertisers in Electronics domestic edition

**Advertising Sales Staff**

**Pierre J. Braudé** New York [212] 997-3468  
Paris Tel: 720-73-01  
Director of Marketing

**Atlanta, Ga. 30309**  
100 Colony Square, 1175 Peachtree St., N.E.  
[404] 892-2868

**Boston, Mass. 02116:** Frank Mitchell  
607 Boylston St. [617] 262-1160

**Chicago, Ill. 60611:**  
645 North Michigan Avenue  
Robert W. Bartlett (312) 751-3739  
Robert M. Denmead (312) 751-3738

**Cleveland, Ohio 44113:** William J. Boyle  
[716] 586-5040

**Dallas, Texas 75201:**  
2001 Bryant Tower, Suite 1070  
[214] 742-1747

**Denver, Colo. 80203:** Harry B. Doyle, Jr.  
123 Speer Blvd. #400  
[303] 837-1010

**Detroit, Michigan 48202:** Robert W. Bartlett  
1400 Fisher Bldg.  
[313] 873-7410

**Houston, Texas 77002:** Paul Reiss  
601 Jefferson Street, Dresser Tower [713] CA 4-8381

**Los Angeles, Calif. 90010:** Robert J. Reilly  
Bradley K. Jones, 3200 Wilshire Blvd., South Tower  
[213] 487-1160

**New York, N.Y. 10020**  
1221 Avenue of the Americas  
Warren H. Gardner [212] 997-3617  
Michael J. Stoller [212] 997-3616

**Philadelphia, Pa. 19102:** Warren H. Gardner  
Three Parkway,  
[212] 997-3617

**Pittsburgh, Pa. 15222:** Warren H. Gardner  
4 Gateway Center, [212] 997-3617

**Rochester, N.Y. 14534:** William J. Boyle  
9 Greylock Ridge, Pittsford, N.Y.  
[716] 586-5040

**San Francisco, Calif. 94111:** Don Farris  
Robert J. Reilly, 425 Battery Street,  
[415] 362-4600

**Paris:** Alain Offergeld  
17 Rue-Georges Bizet, 75 Paris 16, France  
Tel: 720-73-01

**Geneva:** Alain Offergeld  
1 rue du Temple, Geneva, Switzerland  
Tel: 32-35-63

**United Kingdom & Scandinavia:** Robert Ghey  
Tel: 01-493-1451, 34 Dover Street, London W1

**Scandinavia:** Andrew Karnig and Assoc.  
Kungsholmsgatan 10  
112 27 Stockholm, Sweden  
Tel: 08 51 68 70 Telex: 179 51

**Milan:** Luigi Rancati  
1 via Baracchini, Italy Phone 86-90-656

**Brussels:** Alain Offergeld  
23 Chaussee de Wavre  
Brussels 1040, Belgium  
Tel: 13-73-95

**Frankfurt/Main:** Fritz Krusebecker  
Liebigstrasse 27c, Germany  
Phone 72 01 81

**Tokyo:** Tatsumi Katagiri, McGraw-Hill  
Publications Overseas Corporation,  
Kasumigaseki Building 2-5, 3-chome,  
Kasumigaseki, Chiyoda-Ku, Tokyo, Japan  
[581] 9811

**Australasia:** Warren E. Ball, IPO Box 5106,  
Tokyo, Japan

**Business Department**

**Thomas M. Egan,**  
Production Manager [212] 997-3140

**Carol Gallagher**  
Production Manager International  
[212] 997-2045

**Dorothy Carter,** Production Manager  
Domestic  
[212] 997-2908

**Frances Vallone,** Reader Service Manager  
[212] 997-6057

**Electronics Buyers' Guide**

**George F. Werner,** Associate Publisher  
[212] 997-3139

**Regina Hera,** Directory Manager  
[212] 997-2544

**Classified and Employment Advertising**

**Frank Eberle,** Manager  
[212] 997-2557



**TOUCH TONE\*  
DETECTORS  
MODEL 550-1 & 550-2**

provide  
Dial Tone Prefiltering  
Band Separation Filters  
Amplitude Scaling Circuits  
Level Detectors  
Output Logic Circuits

\*Reg. TM of AT & T

F.D.I. also manufactures  
Active Filters, Sinewave  
Oscillators, Tone Encoders and  
other Communications Products

**Frequency Devices Inc.**  
25 Locust Street  
Haverhill, Mass. 01830  
(617) 374-0761/TWX 710-347-0314

Circle 177 on reader service card

**Gas Sensing Semiconductor**

**FIGARO  
GAS  
SENSOR**

**TGS** quickly senses  
even small  
amount of  
gas.

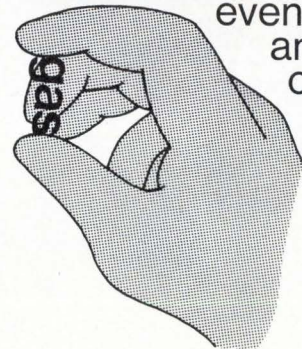

New Models,  
some with highly sensitive  
CO sensor, now on the market.

Please contact the address below directly for  
catalogs and price/delivery information.

**FIGARO ENGINEERING INC.**

3-7-3, Higashitoyonaka, Toyonaka City, Osaka 560,  
Japan/Tel: (06) 849-2156  
Cable: FIGARO TOYONAKA/Telex: 05286155 FIGARO J

Circle 198 on reader service card 177



# Talk to the 32,329 decision-makers in Japan's electronics industry.

# 翻訳

## We'll furnish the language.

If you want to reach the most influential group of management and professional electronics engineers in Japan, we're certain you couldn't choose a more important medium than Nikkei Electronics. Or a more helpful one, either.

When you're thinking about selling to our 32,329 decision-makers, we offer you our full communications resources.

For instance, we'll translate your advertising message from English into the kind of Japanese that we know gets results from our readers. Then we'll set type for you. Also lay out the entire ad for you. And, wonder of wonders, there's no extra charge for these services.

Speaking the precise language of our very important readership is just one of the ways Nikkei Electronics gets more value for your yen in Japan.

As the bi-weekly product of Japan's largest business-economic newspaper and McGraw-Hill, Inc., we're by far the most-respected

magazine in our field. (About 30% of our material is a translation of specialized contents from U.S. *Electronics*.)

As the only Japanese electronics magazine that's a member of the Japan Audit Bureau of Circulation, we can guarantee exclusivity as well as readability.

Our reader profiles are computer-controlled. The better to provide you with up-to-the-minute information on purchasing patterns, reader

analysis studies and proper market approaches.

And our Reader Information Service is a masterpiece of effectiveness. As many as 3,388 responses per issue, with 57.4% of the respondents acknowledging that they participate in or influence the purchasing decision of their companies.

Talk to the electronics decision-makers of Japan in our pages. We'll even furnish the language. Contact Mr. H.T. Howland (in English), Marketing Services Manager, Electronics, McGraw-Hill Publications Company, 1221 Avenue of the Americas,

New York, N.Y. 10020. Telephone: (212) 997-6642. Or talk to any member of McGraw-Hill's advertising sales staff in the U.S. or Europe, or contact us directly in Japan.



## Nikkei Electronics: Ask anybody who can read us.