

DECEMBER 26, 1974

Bell Labs: does it live up to its reputation?/51

European equipment and components market forecast chart/81

Sixteen-bit microprocessor chip minimizes parts count/87

LIBRARY
STATE TECHNICAL INSTITUTE
AT MEMPHIS

FOUR DOLLARS A MCGRAW-HILL PUBLICATION

Electronics®



**INFLATION
SOARS,
CLOUDS
GATHER**

**EUROPE'S
MARKETS**

Little trimmers are very big at our house...



Spectrol

We've Got Your Trimmer and We've Got Your Package!

Whatever you need you can get it right off the shelf from your nearest Spectrol distributor — wirewound or cermet — all available at prices that are right. Call for a quote, ask for free samples, or send for a data sheet.

Spectrol

SPECTROL ELECTRONICS GROUP

UNITED STATES Spectrol Electronics Corporation 17070 E. Gale Avenue, City of Industry, Calif. 91745, U.S.A. • (213) 964-6565 • TWX (910) 584-1314

UNITED KINGDOM Spectrol Reliance Ltd. Drakes Way, Swindon, Wiltshire, England • Swindon 21351 • TELEX: 44692

ITALY SP Elettronica spa Via Carlo Pisacane 7, 20016 Pero (Milan) Italy • 35 30 241 • TELEX: 36091

Circle 900 on reader service card

SURPRISE!

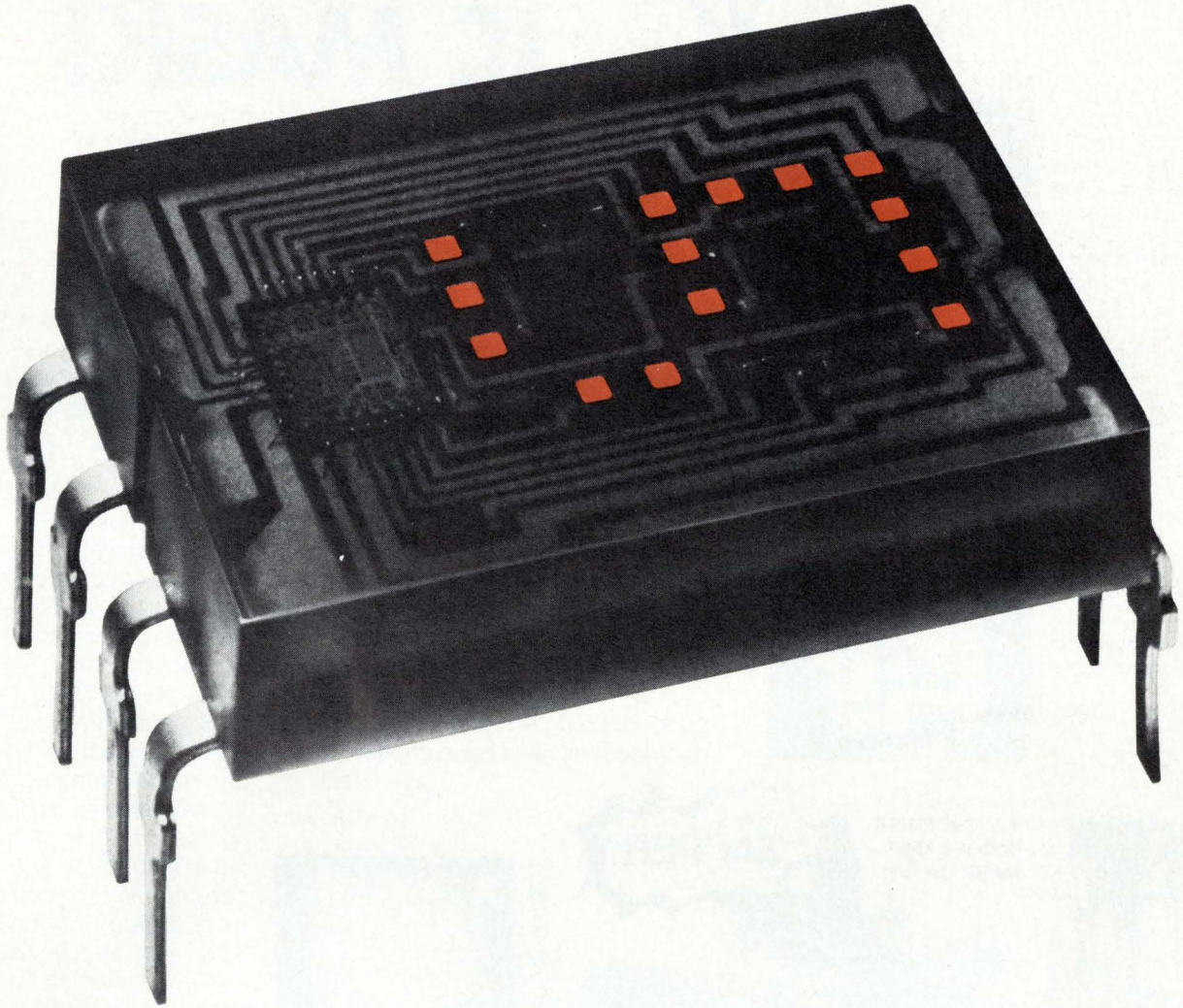

We built in the decoder/driver so you don't have to.

Not only the decoder driver but memory too!

HP's family of integrated displays was designed with an on-board IC to save you time and up to 50% of the space required by conventional LED display systems. These bright 0.29 inch high, shaped character displays are completely TTL compatible. All you do is address them directly with four-line BCD input.

HP's 5082-7300 series displays include numeric displays with right- or left-hand decimal points, a hexadecimal display (0-9, A-F), and a "±1" polarity/overflow indicator.

For immediate delivery of any quantities you need, call Hall-Mark, Schweber, Wilshire, or the Wyle Distribution Group (Liberty/Elmar) today.

HEWLETT  PACKARD

Sales, service and support in 172 centers in 65 countries.
Palo Alto, California 94304. Offices in principal cities throughout the U.S.

01329A



SAVE THAT IC MASK!

Don't throw your company's money away!

Circuit to be zapped is positioned in center of reticle crosshairs which are 5 microns apart in target area. Laser beam is set for 3 micron hole.

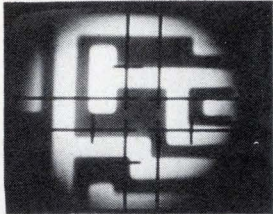

Laser beam in action.

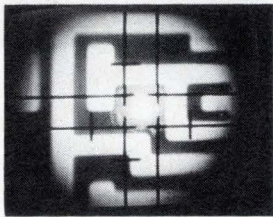

Chrome removed for 3 micron hole.

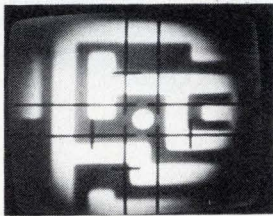

Now with the new Electromask Model 7500 Mask Saver (the "Zapper") you no longer have to scrap your 10X reticles and 1X production masks because of minor defects. Now you can quickly and accurately correct such problems as spot defects, circuit bridging, and protrusions. You can even modify circuit geometries.

The "Zapping" is done by a xenon-pulsed laser, and the total system includes a closed circuit TV, an optics unit, a precision inspection microscope, and a control unit with a digital readout of laser power. The system efficiently removes defects from hard surface masks with no printable damage to glass. Spot size is selectable from less than a micron to 20 microns and greater, depending on selected laser power and aperture.

Typical of the superb quality of the Model 7500, superior Leitz Orthoplan and Olympus Vanox inspection microscopes have been chosen. The selected microscope is

compatibly integrated into the Mask Saver system in such a way as to allow mask inspection and correction at the same work station — or the Mask Saver may also be used as a correction station to support a number of inspection stations.

For more information on the Model 7500 Mask Saver and how it could pay for itself in months, use the reader service card, or call or write us directly.

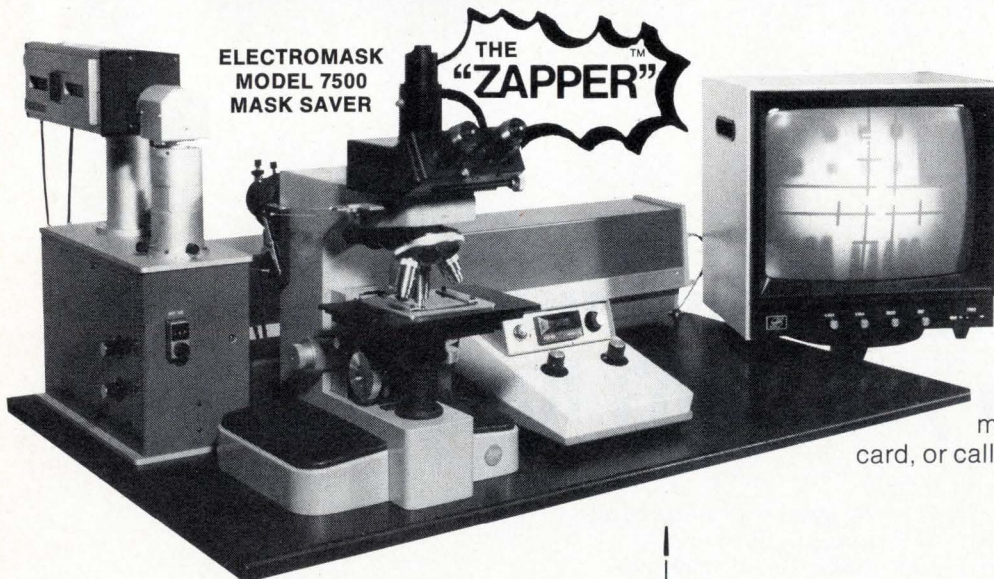

**ELECTROMASK
MODEL 7500
MASK SAVER**

THE "ZAPPER"™



ELECTROMASK, INC.

A subsidiary of TRE Corporation, 6109 De Soto Ave., Woodland Hills, Calif. 91364, Phone: (213) 884-5050, Telex 67-7143

Image Repeaters • Pattern Generators • Mask Savers • Environmental Chambers • Mask ID Printers • Precision Glass Cutters • Photomasking Services

23 Electronics Review

SOLID STATE: Rockwell shelves commercial SOS device activity, 23
Gain is up, size is down in new bipolar process, 23
MEMORY: Small package gaining favor in 4,096-bit RAMs, 24
Density could be increased by bubble-memory lattice, 25
MILITARY: Army seeks first-round artillery-locating capability, 25
CONSUMER: More TV receivers to get digital tuning, 26
INSTRUMENTS: Simple components measure microwave parameters, 28
NEWS BRIEFS: 28
AVIONICS: Ground warning system stirs heat but not sales, 30
COMMUNICATIONS: Europe getting its first high-speed digital line, 32

45 Electronics International

JAPAN: Hitachi brightens color-television tubes, 45
AROUND THE WORLD: 45

51 Probing the News

COMMUNICATIONS: Does Bell Labs live up to its billing? 51
MEMORIES: Josephson devices inch ahead, 55
COMMERCIAL ELECTRONICS: Behind the scenes at Disney World, 58
INSTRUMENTATION: Air monitoring grows complex, 62

65 Special Report: European markets

Overview, 65	Spain, 76
West Germany, 66	Belgium, 77
United Kingdom, 68	Switzerland, 78
France, 71	Denmark, 79
Italy, 73	Norway, 79
The Netherlands, 74	Finland, 80
Sweden, 75	Market forecast chart, 81

87 Technical Articles

MICROPROCESSORS: Single-chip CPU uses 8- or 16-bit words, 87
DESIGNER'S CASEBOOK: Counter uses cheap calculator chip, 96
Modified window comparator compensates for temperature, 97
Timer pulse widths range from seconds to hours, 99
ENGINEER'S NOTEBOOK: Counting microprocessor interrupts, 102
Simple step-function generator aids in testing instruments, 103
Timer IC and photocell can vary LED brightness, 105

109 New Products

IN THE SPOTLIGHT: Programmable calculator priced at \$395, 109
Pushing C-MOS RAM density to 1,024 bits cuts price, power, 111
COMPONENTS: Logic can drive electromechanical relay directly, 112
SEMICONDUCTORS: Microcomputers stress I/O capabilities, 114
DATA HANDLING: Signal processor is fast, flexible, 118
PACKAGING & PRODUCTION: Marking 16,000 DIPs an hour, 120

Departments

Publisher's letter, 4
Readers comment, 7
Meetings, 8
People, 14
Electronics newsletter, 19
Washington newsletter, 39
Washington commentary, 40
International newsletter, 47
Engineer's newsletter, 106
New literature, 125

Highlights

Cover: Inflation troubles European markets, 65

The 1975 outlook for electronics in Europe is "cautious, . . . not pessimistic." If a market does poorly in one country, it may do well in another, averaging out to an essentially flat year in real terms. Exceptions are sales of minicomputers, which will surge, and of color TV sets, which will drop. Cover is by designer Ann Dalton.

The electronic magic of Walt Disney World, 58

Behind many of the fantasies in Florida's Disney World are computers, which control animated figures and roller-coaster rides and will soon be running an ambitious people-mover. Other electronic equipment will also star in the House of Future Living.

Single-chip processor uses 16-bit words, 87

Because the PACE microprocessor employs a 16-bit word length for memory addresses, for instructions, and (optionally) for data processing, it can handle complex applications faster and with simpler programming than earlier one-chip processors having only 8-bit words.

C-MOS technology yields its first 1-k memory, 111

A very low standby power of 10 nanowatts makes the first 1-kilobit complementary-MOS random-access memory an attractive answer to the volatility problem—a low-power battery is the only backup required.

And in the next issue . . .

Electronics' 17th annual forecast of the U.S. markets . . . reading between the lines of C-MOS specifications.

EDITOR-IN-CHIEF: Kemp Anderson

EXECUTIVE EDITOR: Samuel Weber

MANAGING EDITORS: Lawrence Curran, *News*;
Arthur Erikson, *International*

SENIOR EDITORS: John Johnsrud,
H. Thomas Maguire, Laurence Altman,
Ray Connolly, Stephen E. Scrupski

ART DIRECTOR: Fred Sklenar

ASSOCIATE EDITORS: Howard Wolff,
Gerald M. Walker, Alfred Rosenblatt

DEPARTMENT EDITORS
Aerospace/Military: Ray Connolly
Circuit Design: Wallace B. Riley
Communications & Microwave:
Stephen E. Scrupski

Components: Lucinda Matterna

Computers: Wallace B. Riley

Consumer: Gerald M. Walker

Industrial: Margaret A. Maas

Instrumentation: Andy Santoni

New Products: H. Thomas Maguire,
Michael J. Riezenman

Packaging & Production: Jerry S. Lyman

Solid State: Laurence Altman

COPY EDITORS: Margaret Eastman,
Everett C. Terry, Bill Dunne

ART: Charles D. Ciatto, *Associate Director*
Patricia Cybulski, *Assistant Director*

PRODUCTION EDITOR: Arthur C. Miller

EDITORIAL SECRETARIES: Janet Noto,
Julie Gorgoglione, Penny Roberts

FIELD EDITORS

Boston: Gail Farrell (Mgr.), Pamela Leven

Los Angeles: Paul Franson (Mgr.)

Midwest: Larry Armstrong (Mgr.)

New York: Ron Schneiderman (Mgr.)

San Francisco: Bernard Cole (Mgr.)

Judith Curtis

Washington: Ray Connolly (Mgr.)

Larry Marion

Frankfurt: John Gosch

London: William F. Arnold

Paris: Arthur Erikson

Tokyo: Charles Cohen

McGRAW-HILL WORLD NEWS

Director: Ralph R. Schulz

Bonn: Robert Ingersoll

Brussels: James Smith

London: Marvin Petal

Madrid: Dom Curcio

Milan: Peter Hoffmann, Andrew Heath

Moscow: Peter Gall

Paris: Michael Johnson, Richard Shepherd

Stockholm: Robert Skole

Tokyo: Mike Mealey

PUBLISHER: Dan McMillan

DIRECTOR OF MARKETING: Pierre J. Braudé

ADVERTISING SALES SERVICE MANAGER:
Wallis Clarke

BUSINESS MANAGER: Stephen R. Weiss

CIRCULATION MANAGER: Nancy L. Merritt

MARKETING SERVICES MANAGER:
Tomlinson Howland

RESEARCH MANAGER: Margery D. Sholes

With the proliferation of electronics into more and more applications, why should the realm of fantasy—even the real-life fantasy of Walt Disney World—be an exception? Now, visitors there can see a home of the future and its heavy electronics content. But they will not see the behind-the-scenes computer controls as did our consumer editor, Jerry Walker (see p. 58).

In his reporting for the story, Walker was surprised by the expertise of the park's designers. "Many of the people who plan the sophisticated controls are not computer experts or systems engineers," he says. "For the most part, the appreciation of electronics has grown gradually with people who were originally moviemakers."

A long-time fan of the Disney characters, Walker could not resist interviewing Mickey Mouse. "For a star that great, Mickey was certainly unaffected and modest. In fact, he didn't talk at all."

It has been a decade now since we started publishing our year-end West European market report. Our first was bannered "The Boom Continues." This year, it's a completely different story, as you'll see when you turn to page 65.

About the only thing about the report that hasn't changed is the



way we put it together. First, some 300 questionnaires go to companies and government agencies. Then our field crew, headed by International Managing Editor, Arthur Erikson, follows up with interviews.

Working with Erikson were *Electronics* staffers William Arnold (United Kingdom) and John Gosch (West Germany) and World News correspondents Haakan Boerde (Oslo), Dom Curcio (Madrid), Andrew Heath (Milan), Al Pedersen (Copenhagen), Laura Pilarski (Zurich), Martin Schultz (Helsinki), Richard Shepherd (Paris), Robert Skole (Stockholm), and Jim Smith (Brussels).

December 26, 1974 Volume 47, Number 26
94,321 copies of this issue printed

Published every other Thursday by McGraw-Hill, Inc. Founder: James H. McGraw 1860-1948. Publication office 1221 Avenue of the Americas, N.Y., N.Y. 10020; second class postage paid at New York, N.Y., and additional mailing offices.

Executive, editorial, circulation and advertising addresses: Electronics, McGraw-Hill Building, 1221 Avenue of the Americas, New York, N.Y. 10020. Telephone (212) 997-1221. Teletype TWX N.Y. 710-581-5234. Cable address: MCGRAWHILLN.Y.

Subscriptions limited to persons with active, professional, functional responsibility in electronics technology. Publisher reserves the right to reject non-qualified requests. No subscriptions accepted without complete identification of subscriber name, title, or job function, company or organization, including product manufactured or services performed. Subscription rates: qualified subscribers in the United States and possessions, Canada, and Mexico \$12.00 one year, \$24.00 three years; all other countries \$25.00 per year, except Japan and Israel \$50.00 per year; Brazil \$40.00 per year; Australia and New Zealand \$60.00 per year, including air freight. Limited quota of subscriptions available at higher-than-basic rate for persons outside of field served, as follows: U.S. and possessions and Canada, \$25.00 one year; all other countries \$50.00. Single copies: \$4.00.

Officers of the McGraw-Hill Publications Company: John R. Emery, President; J. Elton Tushing, Executive Vice President-Administration; Gene W. Simpson, Group Publisher-Vice President; Senior Vice Presidents: Ralph Blackburn, Circulation; Walter A. Starbury, Editorial; John D. Hoglund, Controller; David G. Jensen, Manufacturing; Gordon L. Jones, Marketing; Jerome D. Luntz, Planning & Development.

Officers of the Corporation: Shelton Fisher, Chairman of the Board and Chief Executive Officer; Harold W. McGraw, Jr., President and Chief Operating Officer; Wallace F. Trendley, Group President, McGraw-Hill Publications Company and McGraw-Hill Information Systems Company; Robert N. Landes, Senior Vice President and Secretary; Ralph J. Webb, Treasurer.

Title registered in U.S. Patent Office; Copyright ©1974 by McGraw-Hill, Inc. All rights reserved. The contents of this publication may not be reproduced in whole or in part without the consent of copyright owner.

Subscribers: The publisher, upon written request to our New York office from any subscriber, agrees to refund that part of the subscription price applying to copies not yet mailed. Please send change of address notices or complaints to Fulfillment Manager; subscription orders to Circulation Manager, Electronics, at address below. Change of address notices should provide old as well as new address, including postal zip code number. If possible, attach address label from recent issue. Allow one month for change to become effective.

Postmaster: Please send form 3579 to Fulfillment Manager, Electronics, P.O. Box 430, Hightstown, N.J. 08520.

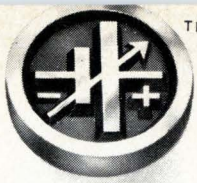

KEPCO

OPERATIONAL POWER SUPPLIES

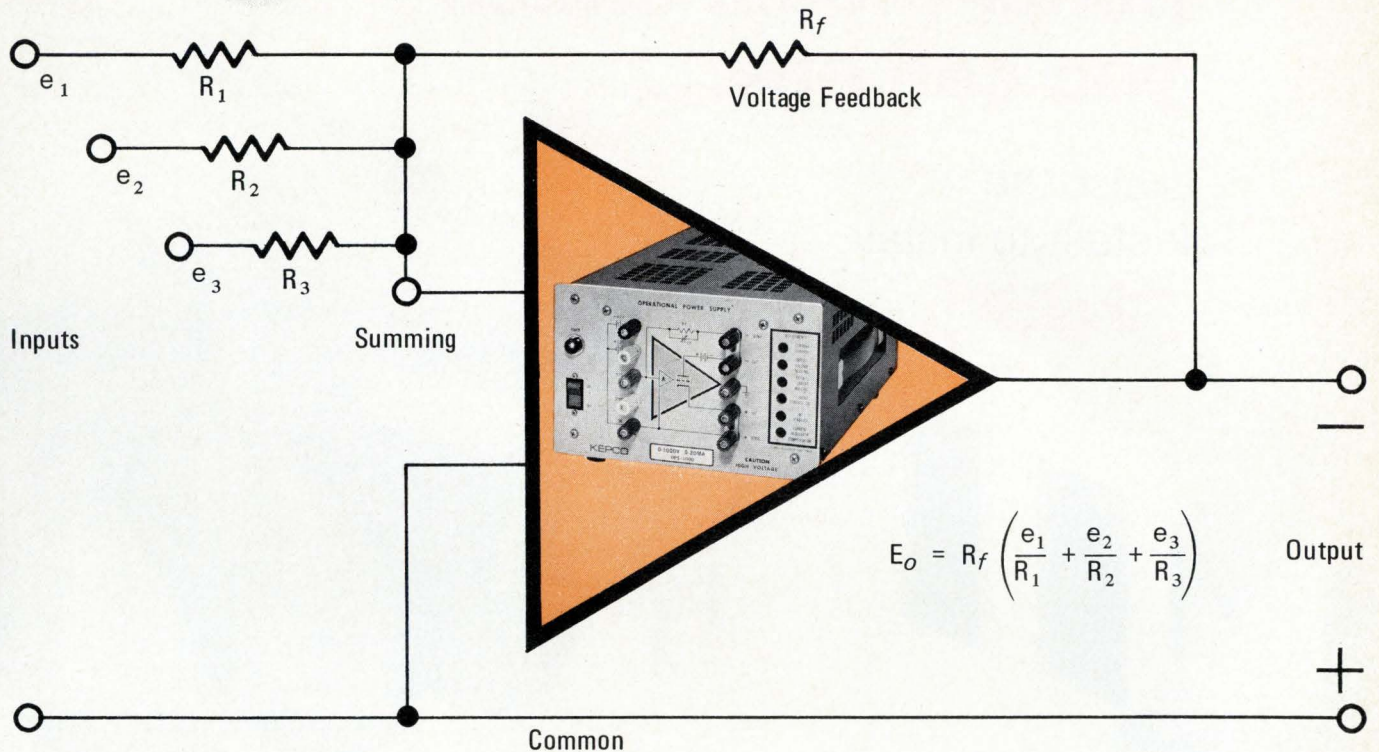

A Kepco **Operational Power Supply** is capable of producing more than mere voltage *stability* (though it does that admirably, too). An **Operational Power Supply** offers voltage *agility*. These unique power supplies allow you to exercise subtle, precise, rapid control, closed loop control, even digital control. They'll respond with better than 0.01% linearity to the most complex programming instructions, will slew to a new setting at speeds up to 1V/microsecond, and allow you to set zero with millivolt resolution. Kepco's Operational Power Supplies are most useful instrumentation for:

- **AUTOMATIC TEST EQUIPMENT (ATE)**, where the ability to rapidly settle at a programmed level, speeds your test cycle.
- **PROCESS CONTROL SYSTEMS**, where the **Operational Power Supply's** high gain and linear response permits you to close a variety of feedback loops.
- **THE STABILIZATION OF CURRENT**, where minimum offsets allow small currents to be effectively controlled and where *capacitorless* output circuits offer the dynamic compliance to track a varying load.
- **MEASUREMENTS**, where an **Operational Power Supply's** ability to sum, scale and integrate, permits the complex combination of inputs.
- **OPERATIONAL POWER SUPPLIES** are made *only* by **KEPCO, INC.**

Ask for your free copy of "Using Operational Power Supplies," our 32-page booklet that will open your eyes to what a power supply can do, besides producing a stable voltage.

write Dept. EU-14

KEPCO®

KEPCO, INC. • 131-38 SANFORD AVENUE • FLUSHING, N.Y. 11352
(212) 461-7000 • TWX #710-582-2631 • Cable: KEPCOPOWER NEWYORK

The most **FORGETTABLE** panel-mount switch you can buy...

is also the
fastest to install...

SNAP!

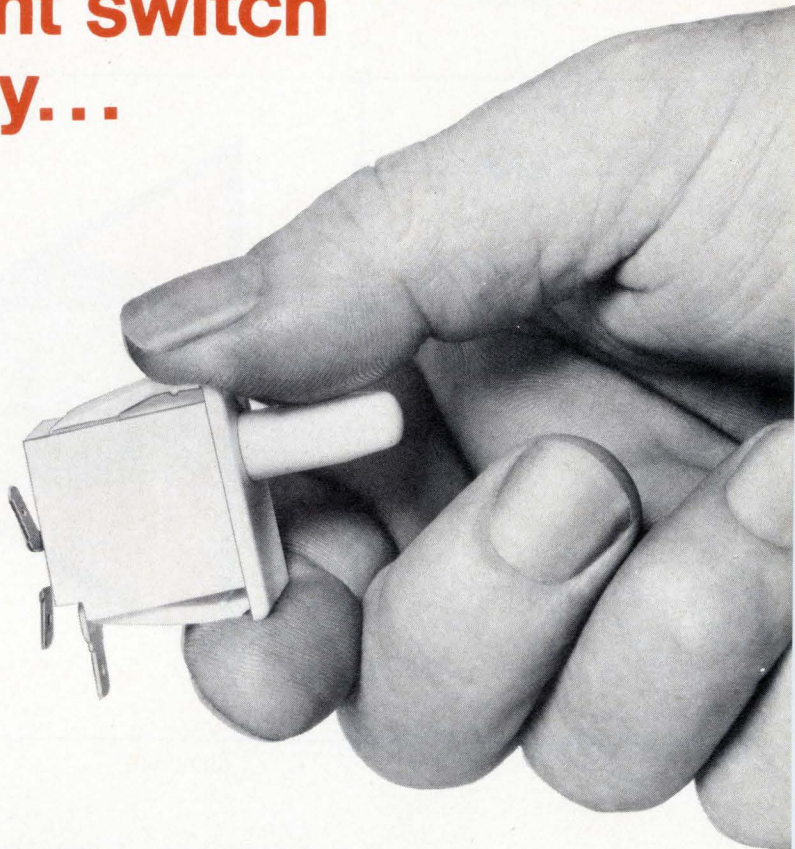
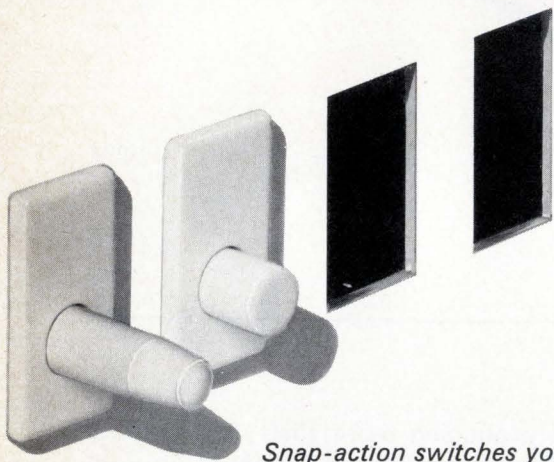

Snap-action switches you snap-in your panel . . . and forget. Switches that keep switching practically forever . . . because of Cherry's exclusive long-life, long-overtravel coil spring mechanism. Switches that stay put practically forever, too . . . because the semi-sealed nylon cases have molded-in serrated spring lock clips. These "forgettable" single pole (SPDT) switches are rated 10 amps, 125 VAC. Also available in double pole (DPDT) circuitry . . . and in Gold "Crosspoint" contacts for positive switching of low energy circuits.

SNAP UP A FREE SAMPLE FOR YOUR PANEL

Just TWX 910-235-1572 . . . or PHONE 312/689-7700 and ask Frank to give you facts on panel-mount switches . . . or circle appropriate reader service number.

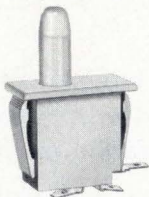

E69-00A Momentary Action
Circle No. 131
for Free Sample



E69-20A Push-Pull (Reset)
Circle No. 132
for Free Sample



E69-30A Momentary & Pull-to-Override Interlock
Circle No. 133
for Free Sample

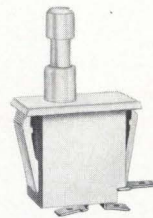

E69-60A Alternate Action
Circle No. 134
for Free Sample

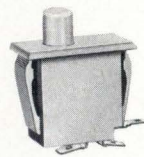

E69-40A Momentary Action/Short Button
Circle No. 135
for Free Sample

CHERRY

CHERRY ELECTRICAL PRODUCTS CORP.
3608 Sunset Avenue, Waukegan, Illinois 60085



Cherry affiliates worldwide • Hirose Cherry Precision Co., Ltd., Tokyo • G. W. Engineering Pty. Ltd., Sydney
Cherry Electrical Products (U.K.) Ltd., St. Albans, Herts • Cherry Mikroschalter GmbH, Bayreuth, Germany

Circle 6 on reader service card

Readers comment

Equation changes

To the Editor: Certain errors in the equations in our Designer's Casebook, "Single op amp compares bipolar voltage magnitudes," [Nov. 14, p. 123] have come to our attention. The errors were caused by changing from the complementary mode of operation of the comparator when the final draft was written.

First, the references to e_i in the first four equations have the words "negative" and "positive" reversed. Then, in the first equation the sign between e_i and e_d should be plus, not minus. In the second equation that sign should be minus, not plus.

The third equation, designated (1), should read:

$$-(e_i + e_d) = e_r (R_1/R_3) \quad (1)$$

In equation (2), the sign between e_i and e_d should be plus, and the minus sign in front of e_r should be deleted.

F.N. Trofimenkoff
R.E. Smallwood
The University of Calgary
Alberta, Canada

Across the Potomac

To the Editor: We are happy to get the publicity that went when you quoted me (*Electronics*, Oct.3,p.95). But we're in Washington, D.C., not Arlington, Va.

W.L. Pritchard
Satellite Systems Engineering, Inc.

Correcting an oversight

Some important data was omitted from a caption in "For solid-state watches, the time is at hand" [Dec. 12, p. 97]. The wafer and chip (left and middle photos) were designed and built by Micro Power Systems, Santa Clara, Calif., for various watch manufacturers, and the module assembly (right) is from National Semiconductor Corp. Micro Power's silicon-gate C-MOS watch chip contains all the functions for frequency-division and the related signal processing needed to display minutes, seconds, and date. Using only 12,000 square mils, it takes up about half the chip area of designs built with standard C-MOS.

GET ON BOARD...

with TANTALEX[®] Low-Cost Solid Tantalum Capacitors

Sprague Gives You a Choice for Flexibility in Your Printed Board Designs.

DIPPED ... SPRAGUE TYPE 196D



Small size economical capacitors that utilize high-quality tantalum pellet construction. Conformal epoxy resin coating is highly resistant to moisture and mechanical damage. This capacitor has found wide usage in consumer and commercial electronic equipment. Operating temperature range, -55 C to +85 C. Available in all popular 10% decade values from 0.1 μ F to 330 μ F. Voltage range, 4 to 50VDC. Standard lead spacing, 0.125" and 0.250". For complete data, write for Engineering Bulletin 3545B.

Circle 210 on reader service card

MOLDED ... SPRAGUE TYPE 198D

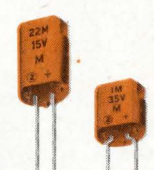

Economically priced, molded-case Econoline[™] capacitors. Standard lead spacing, 0.100", 0.200", and 0.250". Tough, flame-retardant, crack resistant case has flattened section and polarity indicator for easy-to-read marking and error-free insertion. Fixed external dimensions allow increased productivity during assembly of PC boards. Designed for severe vibration and shock environment, where lead support alone is not adequate. Operating temperature range, -55 C to +85 C. Capacitance values from 0.1 to 100 μ F. Voltage range, 4 to 50VDC. For complete data, write for Bulletin 3546.

Circle 7 on reader service card

Call your nearest Sprague district office or sales representative, or write for the bulletins mentioned above to Sprague Electric Company, 35 Marshall Street, North Adams, Mass. 01247.

THE BROAD-LINE PRODUCER OF ELECTRONIC PARTS

43E-4103R2
SPRAGUE[®]

THE MARK OF RELIABILITY

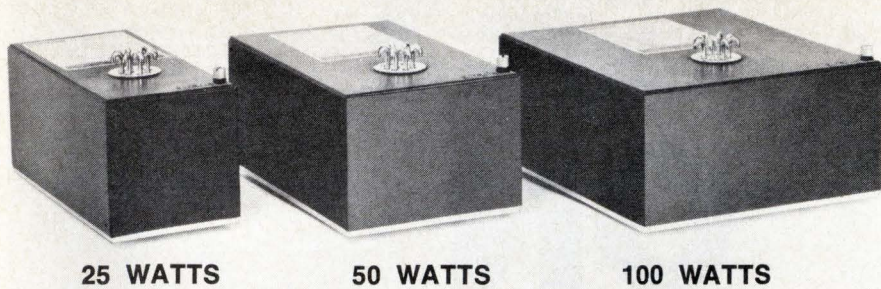

25 WATTS

50 WATTS

100 WATTS

Save 5 Ways with Abbott's New 77% Efficient Power Supplies!

Abbott has a Hi-Efficiency series of power modules that can save 5 ways in your system. The Model "VN" series converts 47-440 Hz AC lines to regulated DC power and uses a new approach in switching technology that provides a highly reliable line of sixty-three high efficiency power modules.

The Model "VN" series saves in the following 5 ways:

- 1 SAVES POWER** — High frequency pulse width modulation and C/MOS digital IC control circuitry allow efficiencies of up to 77% in the Model "VN" series. This high efficiency realizes almost twice the output power per input watt than dissipative regulators.
- 2 SAVES SIZE** — Off line techniques and IC technology combine for packages of 70% less volume compared to dissipative regulators.
- 3 SAVES WEIGHT** — High efficiency means less power dissipated and less heat generated, thereby reducing or eliminating the need for bulky heat-sinking and forced air cooling. This translates into less total weight and smaller system size.
- 4 SAVES TIME** — You can quickly get the power supply you need because we have an extensive line of models to choose from. Outputs of 25, 50 and 100 watts are available at any voltage between 4.7 and 50.0 VDC. With popular voltages in stock, chances are the unit you need is available immediately.
- 5 SAVES MONEY** — At only \$282 for 25w, \$301 for 50w, and \$325 for 100w in small quantities, the "VN's" are among the lowest priced Hi-efficiency units on the market.

Abbott also manufactures 3,500 other models of power supplies with output voltages from 2.7 to 740 VDC and output currents from 4 milliamps to 20 amps. They are all listed, with prices, in the new Abbott Catalog. Included are:

60 A to DC
 400 A to DC
 28 VDC to DC
 28 VDC to 400 A
 12-38 VDC to 60 A

Please see pages 307-317 Volume 1 of your 1974-75 EEM (ELECTRONIC ENGINEERS MASTER Catalog) or pages 853-860 Volume 3 of your 1974-75 GOLD BOOK for complete information on Abbott Modules.

Send for our new 60 page FREE catalog.

abbott transistor

LABORATORIES, INCORPORATED
 general offices eastern office

5200 W. Jefferson Blvd./Los Angeles 90016
 (213) 936-8185 Telex: 69-1398

1224 Anderson Ave./Fort Lee, N.J. 07024
 (201) 224-6900 Telex: 13-5332

8 Circle 8 on reader service card

Meetings

Optical Fiber Transmission Topical Meeting, IEEE, Williamsburg Lodge, Williamsburg, Va., Jan. 7-9.

Computer Architecture, IEEE, University of Houston, Houston, Texas, Jan. 20-22.

Reliability and Maintainability Symposium, IEEE et al., Sheraton Park Hotel, Washington, D.C., Jan. 28-30.

Physics of Compound Semiconductor Interfaces, University of California, Los Angeles, Feb. 4-6.

Wincon—Aerospace & Electronic Systems Winter Convention, IEEE, Aerospace & Electronics Systems Society, Americana Hotel, Los Angeles, Calif., Feb. 5-7.

Nepcon '75 West and International Microelectronics Exhibition, Industrial Scientific Conference Management Inc. (Chicago, Ill.), Anaheim Convention Center, Anaheim, Calif., Feb. 11-13.

CAD/CAM III. Computer-Aided Design and Computer-Aided Manufacturing, Society of Manufacturing Engineers, Hyatt Regency O'Hare Hotel, Chicago, Ill., Feb. 11-13.

International Solid State Circuits Conference, IEEE, Marriott Hotel, Philadelphia, Pa., Feb. 12-14.

Comcon Spring—Computer Conference, IEEE, Jack Tar Hotel, San Francisco, Calif., Feb. 25-27.

Industrial Applications of Microprocessors, IEEE, Sheraton Hotel, Philadelphia, Pa., March 11-12.

Reliability Physics Symposium, IEEE, MGM Grand Hotel, Las Vegas, Nev., April 1-3.

Southeastcon '75, IEEE, Sheraton Center, Charlotte, N.C., April 6-9.

Electronics Production and Test Equipment Exposition, U.S. Department of Commerce, Stockholm, April 7-11; London, April 15-18.

you can see why...

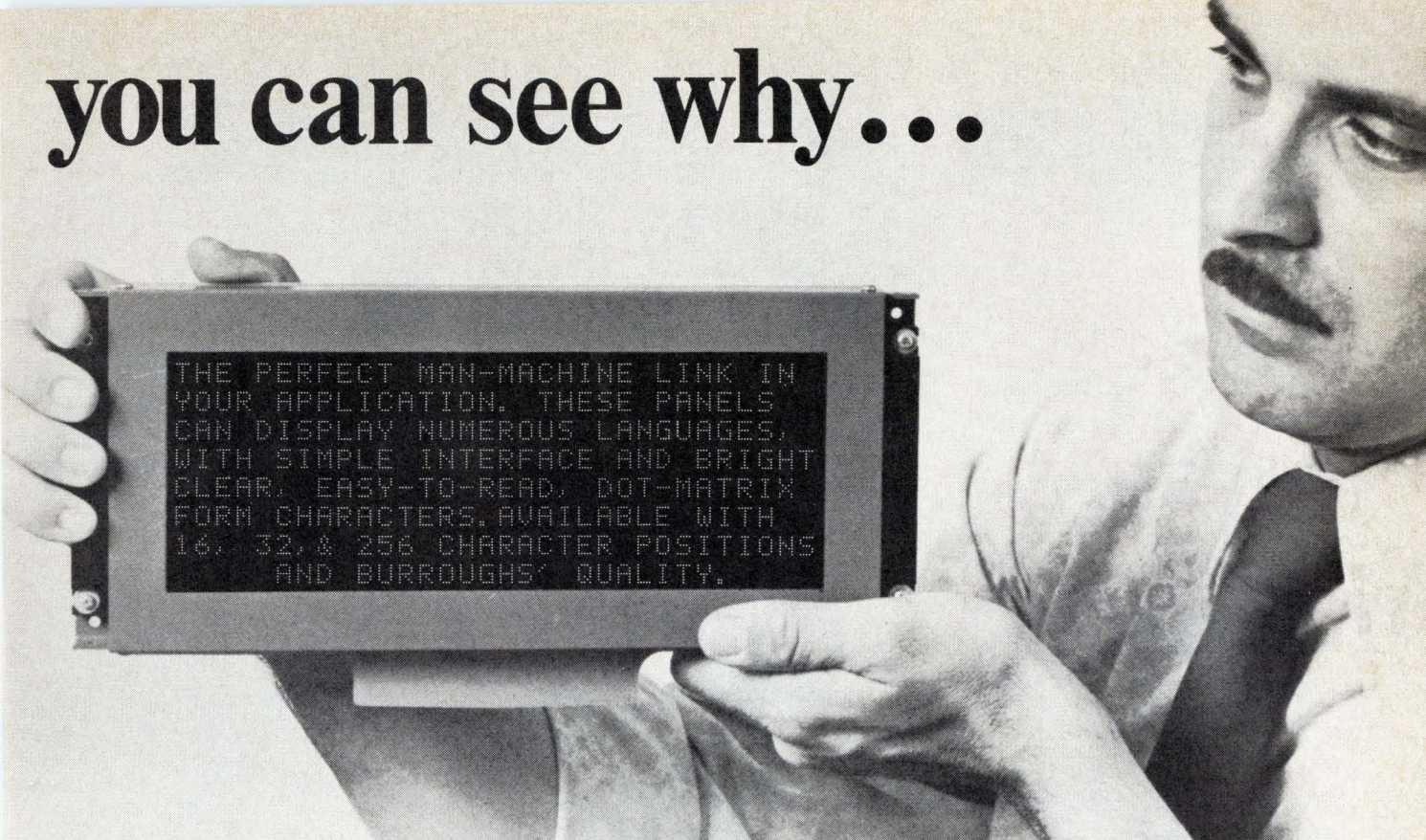

THE PERFECT MAN-MACHINE LINK IN YOUR APPLICATION. THESE PANELS CAN DISPLAY NUMEROUS LANGUAGES, WITH SIMPLE INTERFACE AND BRIGHT CLEAR, EASY-TO-READ, DOT-MATRIX FORM CHARACTERS. AVAILABLE WITH 16, 32, & 256 CHARACTER POSITIONS AND BURROUGHS' QUALITY.

a **SELF-SCAN**[®] PANEL is the best choice

SELF-SCAN panels are best because they can provide alphanumeric display of data — 16 to 256 characters per message — for data entry, automatic checkout systems, wherever man-machine interface takes place.

SELF-SCAN panels are best because they are brighter. Burroughs technology makes possible sharp characters with no fuzziness, no loss of focus, no distortion, a 120-degree viewing angle, and readability up to 25 feet with minimum glare and reading fatigue.

SELF-SCAN panels are best because they are the most versatile self-contained display panels commercially available. A wide variety of character generators offers 45 different displays, including Cyrillic, Hebrew and Katakana alphabets as well as standard ASCII code.

SELF-SCAN panels are best because they can be packaged in less than 1/2" depth and are less costly than CRT's with comparable message capability. The cost per light-emitting dot will amaze you.

Want to see SELF-SCAN panels in operation? Write the Electronic Components Division, P. O. Box 1226, Plainfield, New Jersey 07061, or call (201) 757-3400 or (714) 835-7335 for a demonstration.

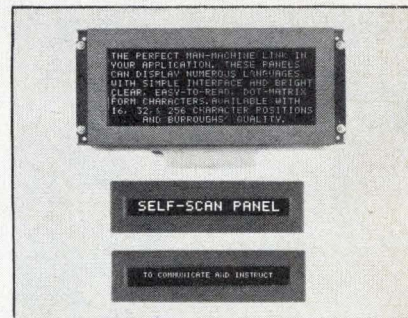

You can see the difference

Burroughs
Circle 9 on reader service card



HOW TO COMPARE APPLES & ORANGES

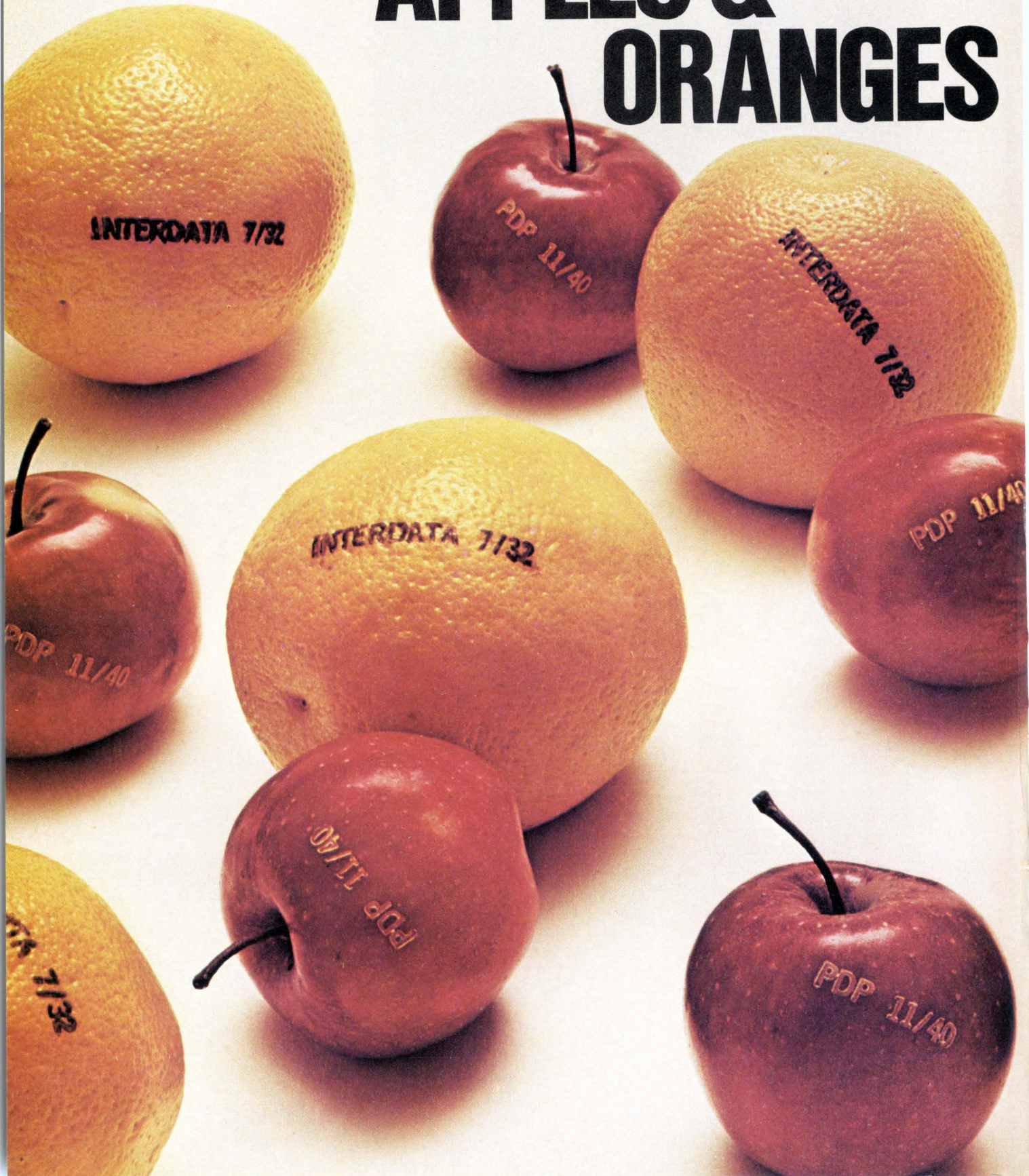

OR THE INTERDATA 7/32 VS. THE PDP 11/40

It's a simple comparison when you think about minicomputer hardware in terms of software.

Interdata believes that hardware exists to make programming easier. That's the reason we invented a 32-bit minicomputer. And that's the reason there really can be no comparison with any 16-bit machine.

Just think about it.

Most 16-bit mini's were designed when memory cost you a dollar a word. Multiple registers meant four. Software was a set of diagnostics. And hardware was king.

Not so now.

Large memories are the rule — not the exception. One program alone can exceed 65K. Multiple registers now

mean 32. And most of your dollars are spent on software.

That's why Interdata made the 7/32 happen — to make your software simpler and cheaper.

For example, the 7/32 has a Real Time Operating System you can understand. A system optimized for FORTRAN programs. And a set of editors, debuggers, and file packages to brighten any programmer's day. All with a CAL assembler that gives you efficient code and is compatible not only with Interdata 7/32's but with our 7/16's as well.

So don't try to compare apples and oranges. It's unfair to the apple. Especially when their apple only has 16 bits to help their software and our orange has 32.

Interdata, Inc., 2 Crescent Place, Oceanport, N.J. 07757 (201) 229-4040.

Gentlemen:

- Maybe I shouldn't compare, but I've got to try. Send me more about the 7/32.
- Let's talk oranges. Have an Interdata representative contact me.

Name _____ Title _____

Company _____

Address _____

City _____ State _____ Zip _____

Telephone _____

INTERDATA®

A subsidiary of The Perkin-Elmer Corporation

2 Crescent Place, Oceanport, N.J. 07757.
(201) 229-4040.

6486 Viscount Road, Mississauga, Ontario,
Canada L4V 1H3. (416) 677-8990.

Arundel Road, Uxbridge, Middlesex, England.
Uxbridge 52441.

8032 Grafelfing bei Munchen,
Waldstrabe 31, West Germany. 854-20-34-38.

92 Chandos Street, St. Leonards,
Sydney, Australia 2065. 439-8400.

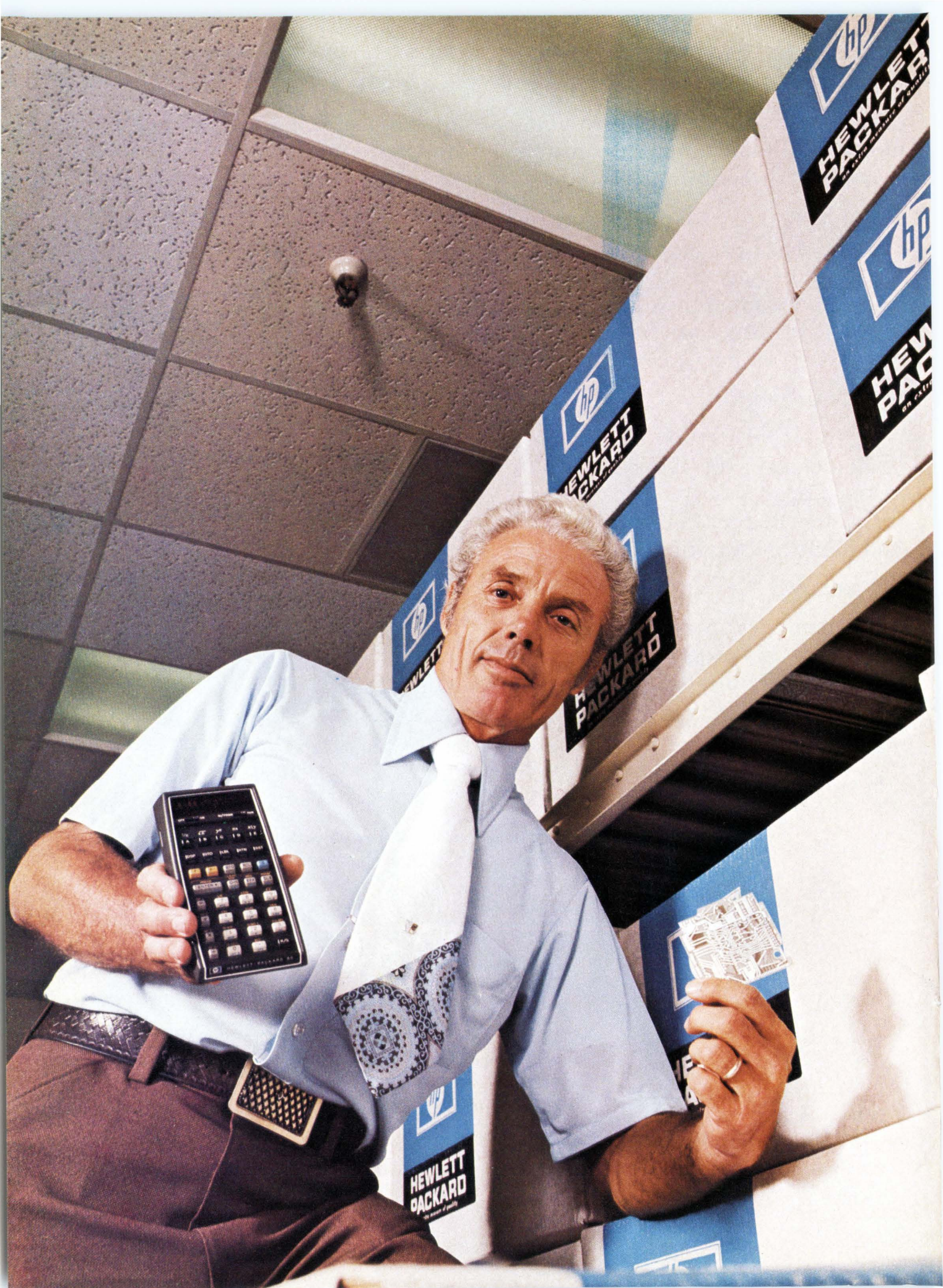

"My records prove it. Photocircuits shipped us over 1/2 million PCBs for calculators. Less than 1% were rejected."

Tom Miller, Production Control Supervisor, Hewlett-Packard

"I supervised in-house production of printed circuitry for Hewlett-Packard. When the demand for our pocket-sized calculators taxed our own capacity for making printed circuit boards, I had to look outside the company.

"The scientific and business calculators Hewlett-Packard makes have infinitely more functions than the typical 'housewife' variety. And we have sold over one-half million of them. So we needed large volumes of quality boards for logic and battery charger applications.

"Photocircuits' reputation for quality was confirmed by my first visit.

"I've been in this business since 1955, so I knew of Photocircuits even before we made a facilities check. What I had heard proved to be true. Their overall efficiency was evident and everyone seemed to know what they were doing.

"We had no qualms about dealing with an East Coast house either. They were only a short 5 hours away by plane. And seconds away by WATS line. In fact, when we asked for price quotes, they got back to us within ten days. And that

included mailing time.

"Their price was lower and they delivered what they promised.

"Long Island labor costs are comparable to the West Coast, but Photocircuits still managed to beat local prices. To me, that's another indication of overall efficiency.

"And even though we hit them at the same time as everyone else, Photocircuits guaranteed they would deliver a certain number of boards every week. They kept that promise.

"Quality-wise, they were the best boards I've seen in twenty years.

"We have some very stringent standards at Hewlett-Packard. Not only do we expect operational quality, but esthetics as well. If a customer tears the cover off one of our products, we want our components to look good.

"In both cases, performance and looks, Photocircuits was outstanding. Over half a million boards have been delivered. Less than 1% have been rejected for any reason whatsoever.

"What more is there to say?"

Photocircuits

Division of Kollmorgen Corporation, Glen Cove, New York 11542 (516) 448-1000

Printed circuitry for mass-produced electronics

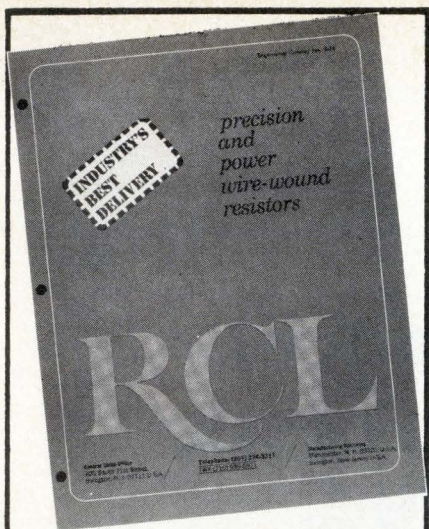

PRECISION/POWER WIRE-WOUND RESISTOR ENGINEERING HANDBOOK

The industry's most extensive and most accurate compilation of engineering information on wire-wound resistors

including: beryllium oxide core power resistors 22 special temperature coefficients, low cost computer resistors, commercial series.

Write for your free copy today!

**INDUSTRY'S
BEST DELIVERY
FROM THE
WORLD'S LARGEST
MANUFACTURER
OF
WIRE-WOUND
RESISTORS!**

RCL

ELECTRONICS DIVISION,
AMF INCORPORATED
700 South 21st Street
Irvington, New Jersey 07111
(201) 374-3311

People

Offshore assembly looks good to Parent

Up until about three months ago, 38-year-old Robert Parent was relatively content as production manager at Silicon General Inc.

Then he was approached by one of his clients, Jacob Ratinoff, president of Interlek Inc. of San Mateo, Calif., which, through its Philippine-based affiliate, Dynetics Inc., assembles about 9 million integrated circuits yearly for U.S. customers.

"Jake told me he wanted to expand to 100 million pieces a year, and he wanted me to be general manager," says Parent, who accepted the invitation despite some misgivings.

"The key is how you handle the expansion," he says. "You don't do it with 14- or 16-pin jelly beans. The advantage of offshore assembly is low labor cost. But the prices of the standard circuits are rock-bottom already, and no one is buying millions of devices."

Special. There is a market, however, for non-standard circuits, he believes, where the typical user wants quantities ranging from 10,000 to several hundred thousand custom parts.

"But to capitalize on this market you need a diversified production line," says Parent. "You must be able to produce a wide variety of pinouts, in several technologies, in several kinds of packages and at several levels of integration."

To this end, he says, Interlek/Dynetics has added 40,000 square feet to its original 10,000 square-foot IC assembly plant near Manila. It will assemble packages with anywhere from six to 40 leads for bipolar, MOS and C-MOS chips, with a choice of encapsulant.

In ceramic packages, says Parent, Interlek will be able to deliver side braze or Cerdip, including low-temperature glass types. In addition, the facility will have the capability of handling small-, medium-, and large-scale ICs.

The company currently has 450 employees, but Parent is negotiating

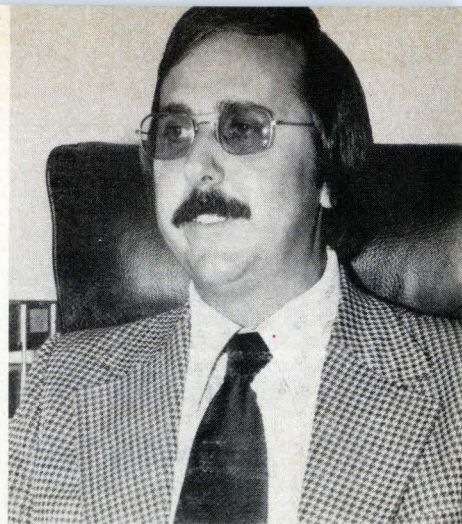

Growing. Assembly operations will grow if they're diversified enough, says Parent.

with about 20 new customers in the U.S. and three in Europe and expects to expand to about 2,000 people by June 1975. If all this seems to be a bit of a gamble, Parent thinks the payoff is worth it.

"The chief advantage to expanding during a down period is that when the turnaround does come you've got a tremendous edge on competitors who are just gearing up again," he says. "And the way we've decided to expand takes a lot of the gamble out of it."

Components are complex for DEC's Knowles

"My bag within the company is to get something going," says 38-year-old Andrew C. Knowles, group vice president and general manager of the recently formed Components group at Digital Equipment Corp.

In a sense, Knowles is taking the Maynard, Mass.-based mini-computer manufacturer back full circle—to its beginnings in 1957 when it was an "iron" house selling off-the-shelf logic modules with little or no software or services. Only now it's time, he thinks, for the concept of a "component" to be vastly expanded.

"We'll be selling microcomputers and peripheral devices such as cathode-ray-tube displays, teleprinters and cassette recorders, as well as our standard logic-module products," says the energetic cigar-smoker. "And by going after customers who are self-sufficient enough not to

Your Guardian Angel
(and dramatic engineering
developments) bring you

solenoids that last 100 times longer*

*And that's a minimum. Life tests have already gone past 100 million operations ...and are still running!

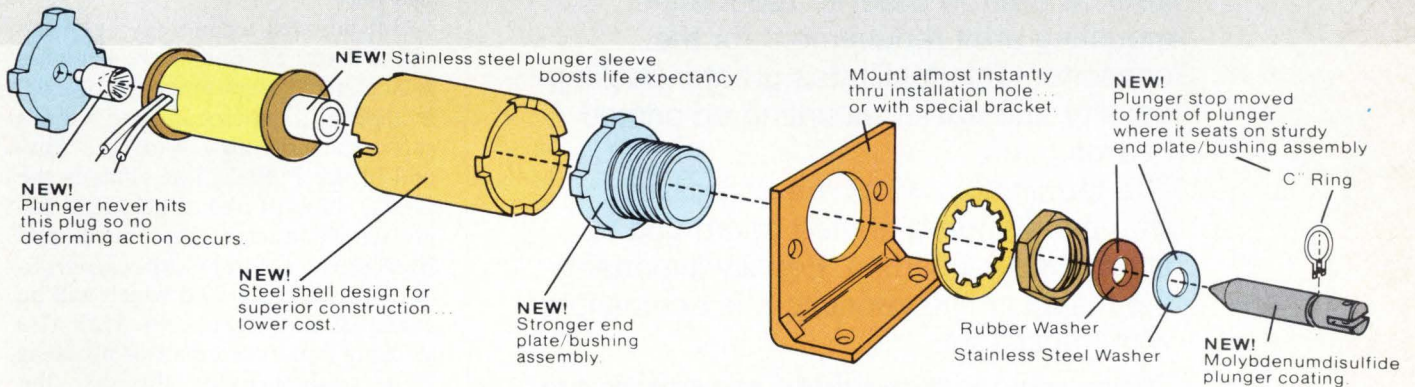

NEW! If the solenoid you're now using in your product lasts five years . . . you can now figure on 500 years. Because these new Guardian solenoids perform the 1 million operations you expect of a traditional life tubular solenoid . . . and keep right on . . . and on. Making them ideal for any place where a life expectancy of 1 million operations just won't do. Where 100 million is more like it.

All because of a unique new design that increases mechanical life . . . at just a little more cost. Only about 25% more, in fact, that traditional-life tubular solenoids. Yet you get 10,000% more life.

Get all the long-life facts in the brand new 72-page Guardian Solenoid Catalog. Yours free for the asking.



GUARDIAN®

GUARDIAN ELECTRIC MANUFACTURING CO. • 1566 West Carroll Ave., Chicago, Illinois 60607

Circle 15 on reader service card

Subminiature capacitors with small mounting areas for printed circuit boards

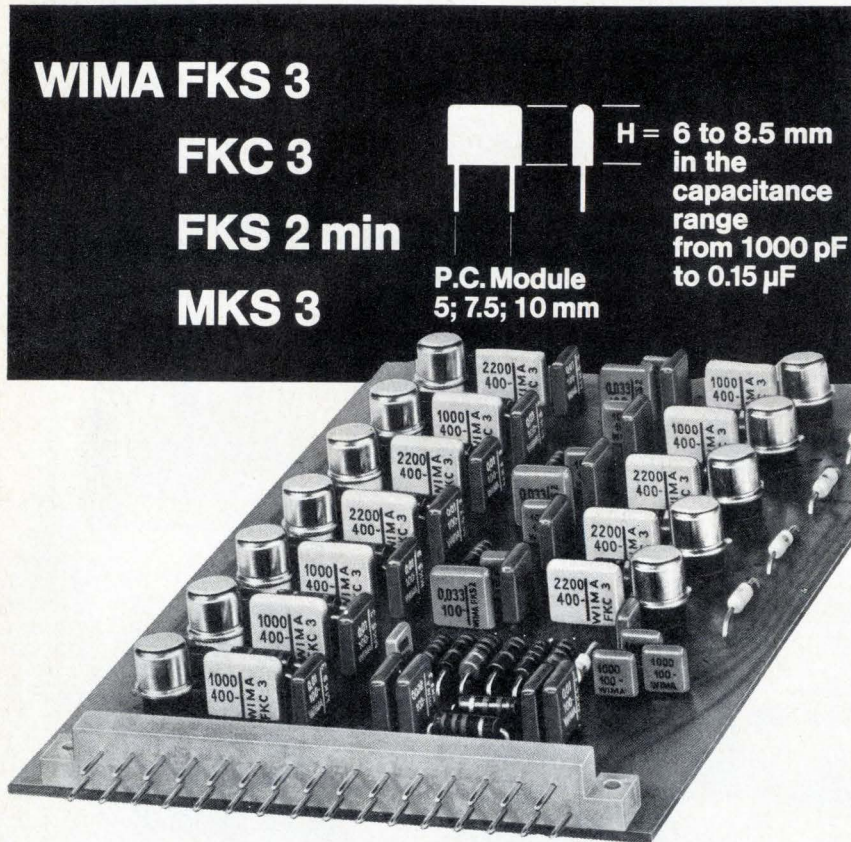

Characteristics:

The design has made better use of the vertical area in order to reduce the mounting area requirement for the capacitor. This facilitates greater packing density and easier mounting on printed boards.

The termination wires are compatible with the standard printed board grid to allow simple insertion. Equally important, the height of the capacitors is compatible with transistors.

These new cast-moulded capacitors are so small that they offer advantages hitherto not obtainable when used on printed circuit boards.



WILHELM WESTERMANN
 Spezialvertrieb elektronischer Bauelemente
 D-68 Mannheim · Fed. Rep. of Germany
 P.O. Box 2345 · Tel.: (0621) 40 80 12

People



Board man. Knowles is counting on the customers' not needing any help.

need software or services, we'll be able to sell things at rock-bottom prices."

Selling processors as if they were simple off-the-shelf components comes easy to him, Knowles says. He spent almost 10 years at RCA Corp., finishing up as manager of applications engineering for the company's semiconductor products. And when he joined DEC in 1969, he began as product-line manager for the PDP-11, one of the first general-purpose minicomputers with a unified bus.

But now LSI technology has been pushed to the point where Knowles is stocking "computers on a board," including a microcomputer that's software-compatible with the low-end of the PDP-11 line. This is the LSI-11, built of n-channel metal-oxide-semiconductor chips developed by Western Digital Corp. [*Electronics*, Oct. 31, p. 25] and which will be available early next year. He's also stocking a pair of processor products made available earlier this year—the MPS microcomputer board built around Intel Corp.'s 8008 p-channel 8-bit LSI chip, and the slightly larger PDP-8A microcomputer, which is program-compatible with DEC's PDP-8E mini. Orders for a thousand processors at a time are already coming in, says Knowles. And he expects to do as well in peripherals.

updating from

SGS

ATES

BU 406 - BU 407

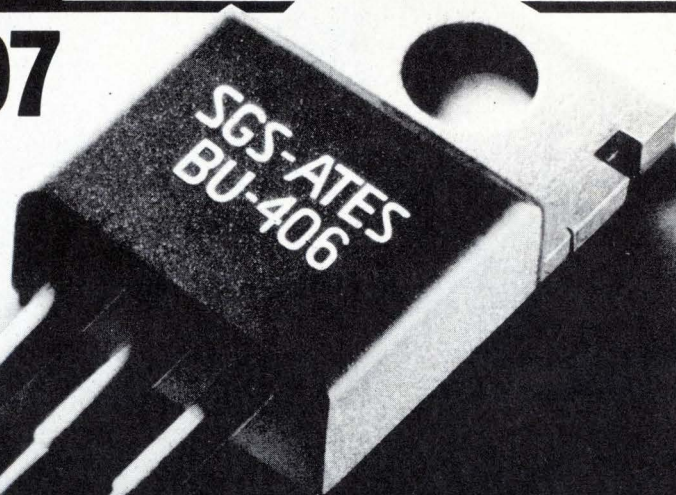

**The "no-sweat"
answer...**

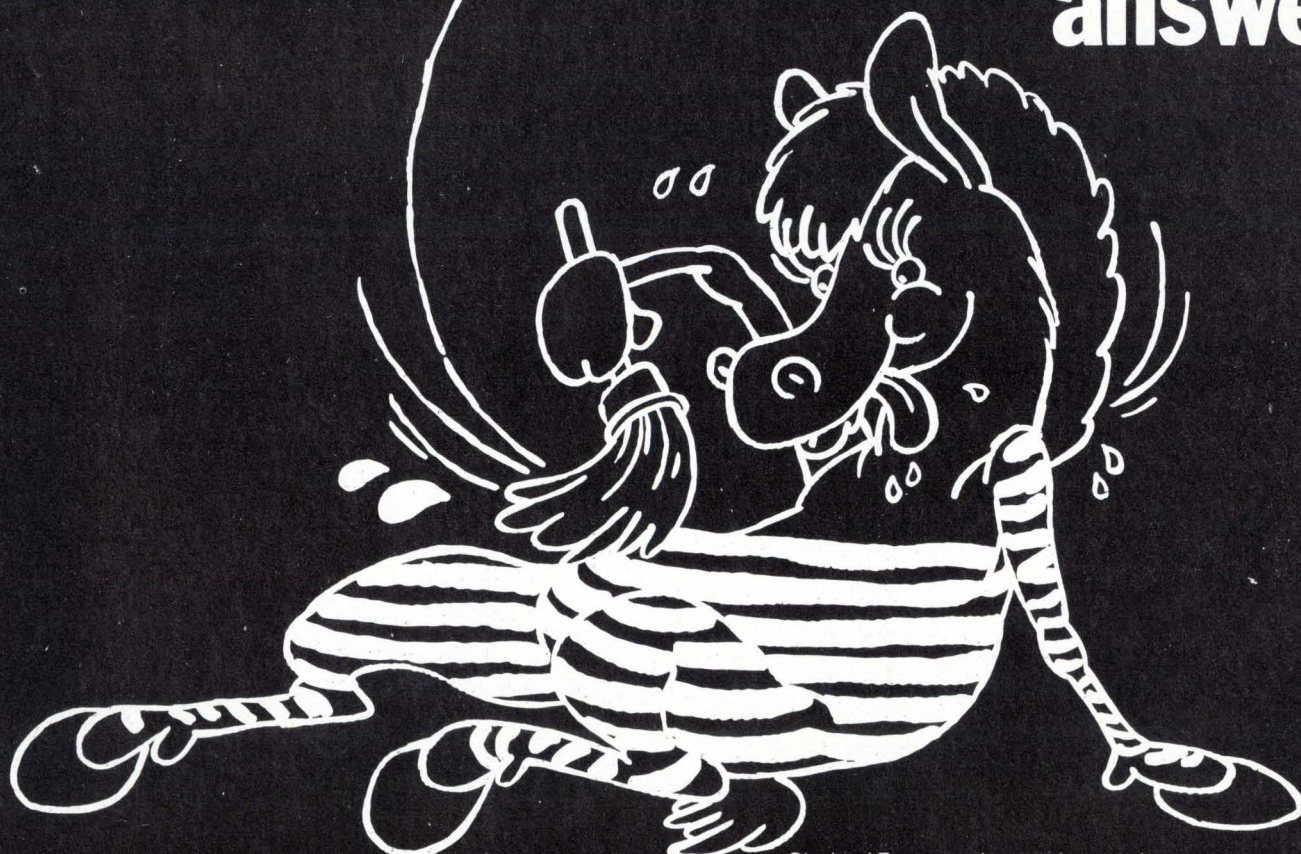

Circle 17 on reader service card

to your linescan problems

SGS-ATES
BU-406



BU 406 - BU 407: horizontal deflection with plastic transistors

BU406 and BU407 are NPN silicon epitaxial transistors designed specifically for horizontal deflection final stages in monochrome television sets. Even the largest popular screen sizes are catered for since the BU406 has a breakdown voltage of 400 V and a peak repetitive collector current of 10A. The BU407 with its 330V breakdown value will be found adequate for small and medium sized screens. This new family is the outcome of a directed development programme

Circle 18 on reader service card

involving computer aid to obtain optimal geometries. Particularly good performance has been achieved in various aspects of interest to deflection circuit designers:

- high resistance to flashover breakdown thanks to optimized geometry and a specially contoured h_{FE} vs I_C characteristic
- very low power dissipation as a result of efficient switching

- low leakage current due to advanced passivation techniques
- guaranteed second breakdown behaviour under typical operating conditions.

The reduced power dissipation has allowed these devices to be mounted in a plastic TO-220 case, thereby cutting the cost of the device, and offering the user cost savings in assembly and heatsink.

	BU 406	BU 407
V_{CES}	400V	330V
I_{CM} repetitive	10A	10A
P_{tot}	60W	60W
V_{CEsat} (5/0.5A)	max 1V	max 1V
t_{off} (5/0.5A)	max 0.75 μ s	max 0.75 μ s
$I_{s/b}$ (40V - 10 ms)	4A	4A

SGS-ATES

Machine fits gap between mini and microcomputer

A new computer that is intermediate between the traditional mini-computer and the semiconductor microcomputer will be introduced in early February by Computer Automation Inc., also known as the Naked Mini company. Selling for about \$500 each in quantity, the new unit, as yet unnamed, is half the size of, and performs about half as well as, the firm's minicomputers, including the LSI-1 and the LSI-2. The one-board LSI-1 accesses in 1.6 microseconds and measures 17 by 15 inches.

The new unit will use TTL MSI rather than MOS LSI—perhaps a reflection of the fact that Computer Automation is not yet in volume production of the MOS-based LSI-1 it announced over a year ago [*Electronics*, May 10, 1973, p. 154], though quantity shipments of the LSI-1 are now said to be imminent. The LSI-2 is also a TTL MSI machine.

Rockwell hiring reps, distributors for standard parts

Though Rockwell Microelectronics is no longer making silicon-on-sapphire LSI for the commercial market (see p. 23), it is underscoring its drive to establish a line of standard products by signing up reps and distributors. Rockwell will soon start shipments of its first standard part, a high-speed 1,024-bit 1103A random-access memory [*Electronics*, Dec. 6, 1973, p. 36], with a 4,096-bit RAM to be sampled late in the second quarter and produced in the fourth quarter. The company hopes to have 12 reps by the end of the second quarter, with distributors signed up in the third quarter.

Printer contains microprocessor, stepping motor

Interdata Corp. has built a microprocessor into the controller of a computer-output printer that it will introduce for the OEM market next month. The machine, the second peripheral to be made by the company, uses the microprocessor not only to control the printing element, but also to perform such additional tasks as monitoring communications lines and controlling transfers to and from the computer memory. The printing element, which has a new shape, is driven by a stepping motor instead of a servo.

The printer is designed to overcome problems with some recent servo-controlled designs. Under certain adverse conditions, these printers operate at as little as half the nominal rate, which causes misalignment and blurring of characters, says Interdata.

Novus adds scientific 1-chip calculators

Expanding out of strictly consumer-type calculators, the Novus Consumer Products division of National Semiconductor Corp. is bringing out a line of 10 new scientific and special-purpose hand-held machines. Prices range from \$80 to \$170 for 14 models from basic slide rule to full-function, dedicated-program units. The low prices for the scientific calculator stem directly from a chip technology that accommodates all the basic scientific and computational functions on a single p-channel chip, and the absence of discrete components. All programable functions are on a second chip.

National offers 22- and 18-pin 4-k RAMs

With a single move, National Semiconductor is catapulting itself into the thick of the 4,096-bit random-access-memory race **by supplying both the 22-pin and 18-pin versions** of that device by mid 1975 (see p. 24). According to Ron Livingston, MOS memory marketing manager, National is taking the 18-pin route for its high-density device "because that configuration offers both good board density and high speed without needing the multiplexing circuitry required of 16-pin packages."

National's 18-pin part, MM 5270, will be in the 200-nanosecond range. It differs from the TI design by sporting a more familiar three-state output instead of the open-drain TI design. National achieved the reduced pin requirements by letting the logic chip select, read/write, and V_{cc} reference share a single pin.

EM&M to add core systems for minis

A major core-memory supplier, Electronic Memories and Magnetics Corp., is aggressively expanding its efforts to reverse the slowing sales of cores. **The company will soon introduce plug-compatible add-on core-memory systems** for the General Automation SPC-16 and Interdata 7/16 and 7/32 minicomputers, the first such memories it has introduced. Memories for other minicomputers are also being developed.

Two in fly-off for altimeter in Army copters

A "fly-off" begins next month between Hoffman Electronics Corp. and Honeywell Inc. when the Army Electronics Command starts testing their **prototypes of an "absolute" radar altimeter for Army helicopters**. The Army wants accuracy within 3 feet $\pm 3\%$ of altitude from zero to 250 feet and $\pm 5\%$ from 251 to 2,500 feet. The system is expected to be sensitive enough to display the altitude from the tops of trees, snow, and ice, or the ground if there is no cover.

The toughest trick for the winner **will be to build the altimeter for \$3,500 each or less** to fill an initial order of 2,000 units. Radar altimeters that do the job now cost about \$7,300. The production award is expected in July 1975.

Leitz builds unit that enables blind to avoid obstacles

A lightweight, inexpensive electronic guidance unit for the blind is the aim of a \$250,000 development project partly financed by West Germany's Ministry for Research and Technology. The equipment is being developed by Ernst Leitz GmbH, and is said to overcome the weight and reliability problems of competing systems. **Leitz expects to have a prototype ready for next year and a marketable unit, to cost no more than about \$400, by 1976.**

Built like an ordinary hand-held flashlight, the unit is to enable the blind to detect objects at various distances to 10 feet and to help them avoid such obstacles as curbstones and staircase steps. **The system converts optical signals impinging upon photocells into perceptible electrical signals of varying strength.** The company is testing both sound and pressure for transferring the information.

Fused-In-Glass reliability by Unitrode

for zeners and rectifiers

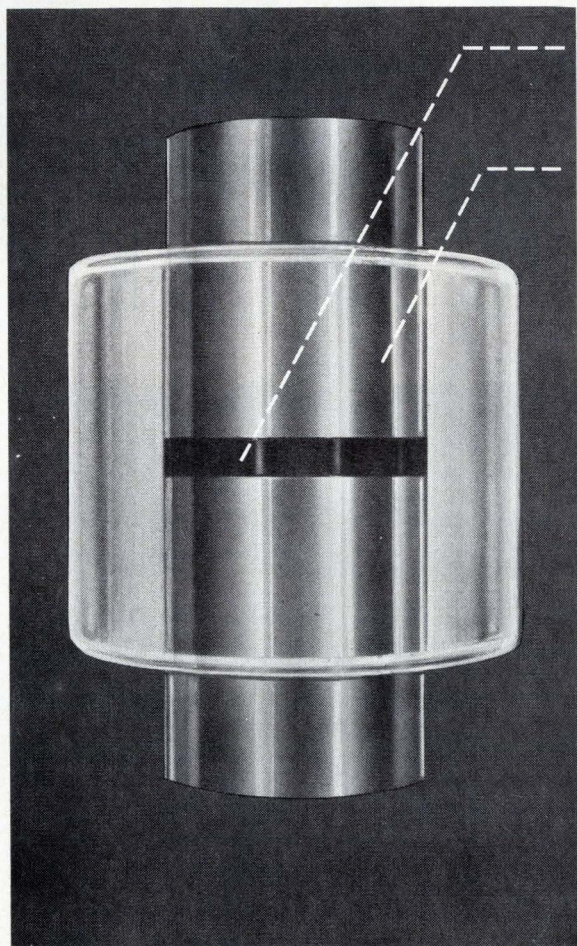

{ Diffused silicon die metallurgically bonded between two pins.

{ Hard glass sleeve fused directly to die and pins provides a voidless monolithic structure...seals out moisture and contaminants...virtually indestructible.

True high reliability is impossible if the design of a zener or rectifier permits anything to destroy the integrity of the chip. Unitrode's exclusive construction has been revolutionizing military reliability specifications since its introduction. Constant process improvements and new products for today's sophisticated electronic equipment maintain Unitrode's leadership.

When you need hi-rel zeners or rectifiers, talk to us. We're today's leader in hi-rel products. Send for our new *Fused-In-Glass Reliability* brochure. Or, for more information, call us at (617) 926-0404.

Unitrode makes over 1000 different hi-rel zeners and rectifiers. Full performance ranges are available in JAN, JANTX, and JANTXV types.

Product	Ratings
Zeners and surge suppressors*	1-10 W; 6.8-400 V
Rectifiers*	1-50 A; 50-1000 V; recovery times to 25 ns

*Available as high-voltage and high-current assemblies, and bridges.

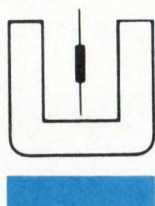

UNITRODE

580 PLEASANT STREET, WATERTOWN, MA 02172

GENERAL ELECTRIC OPTOELECTRONIC COUPLER LINEUP

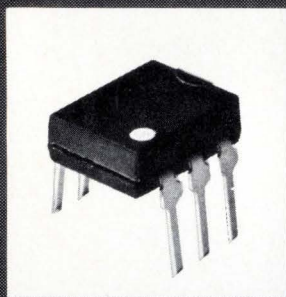

H11 SERIES COUPLERS

- 14 Different models — interchangeable with all popular industry types
- Transistor, Darlington and SCR outputs
- The Industry's first AC input coupler-H11AA and threshold coupler-H11A10
- GE's patented glass isolation yields the highest available CTR and isolation voltages-4N35 offers 100% CTR with 3500V isolation
- Covered under U.L. File E51868

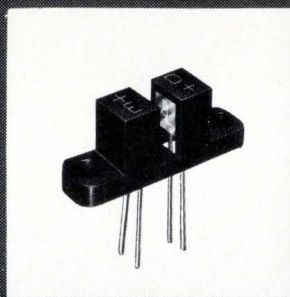

H13 SERIES INTERRUPTER MODULES

- 4 Models offer "no contact" switching
For use as:
 - shaft encoders
 - counters
 - position sensors
 - key boards
 - limit switches
 - electronic ignition systems

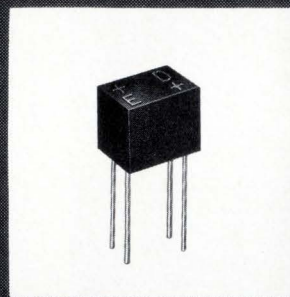

H15 SERIES COUPLERS

- 4000V isolation
- 4 low cost models for pulse transformer replacement, thyristor triggering, logic interfacing
- Transistor and Darlington outputs
- Solid state reliability at low cost
- Covered under U.L. File E51868



H17 SERIES MATCHED EMITTER DETECTOR PAIRS

- Industry's lowest cost matched pairs
- Transistor and Darlington outputs for general purpose detection applications and "no contact" switching
- Replacements for limit switches, small mechanical contacts and micro switches

**COMPETITIVELY PRICED AND AVAILABLE
NOW FROM YOUR GENERAL ELECTRIC DISTRIBUTOR
"THE BEST COST NO MORE"**

GENERAL  ELECTRIC

Rockwell shelves commercial SOS device activity

General Automation left without a supplier for single-chip CPU in its LSI-12 microcomputer

The outlook for commercial applications of silicon-on-sapphire semiconductor devices has suffered a serious setback because of the shelving of most of the commercial SOS effort at the Microelectronics Device division of Rockwell International Corp. The move leaves General Automation Inc., a Rockwell neighbor in Anaheim, Calif., without a supplier for the n-channel microprocessor that served as the single-chip central processor in its LSI-12 microcomputer [*Electronics*, Dec. 6, 1973, p. 39].

The Rockwell division, a pioneer in SOS work, will continue to develop silicon-on-sapphire technology for the military market. But it has also abandoned its own development of a 1,024-bit C-MOS-on-sapphire random-access memory device [*Electronics*, Jan. 10, p. 29].

According to Donn L. Williams, president of Rockwell's electronics operations, the commercial SOS activity was stopped because: "other projects have to take higher priority."

Low volume. In fact, Rockwell officials considered the General Automation CPU chip a laboratory effort, rather than a production run, partly because of the relatively small quantities involved. Even in full production, the device would represent only a small fraction of the Rockwell division's device output.

For his part, General Automation president Raymond J. Noorda complains that his company "hadn't been getting the supply of processor chips needed to continue the [LSI-12] program, so the microprocessor development has been put on the back burner. It will continue as a decent activity, but scaled down."

General Automation had another supplier for the SOS circuit—a small, unnamed Orange County, Calif., spinoff from Rockwell—but Noorda says that firm will concentrate on improving the process, to improve yields rather than product development. Poor yields, in fact, apparently killed the Rockwell effort. General Automation has built a number of the 8-bit LSI-12 microcomputers and delivered them to customers, but couldn't get enough chips to supply the expected production requirements.

The minicomputer maker is proceeding with a dual approach to a substitute CPU for the LSI-12 and still-to-come LSI-16 machines: a high speed MSI TTL microcomputer replacement for the LSI-12, and a lower performance MOS LSI computer to replace the LSI-16, which was not due until spring. "This activity had been going on in parallel because of some feeling that this might happen. We're taking the logic design and going into a more predictable technology," Noorda says.

Slippage. Noorda says that the 16-bit computer, the LSI-16 is not far behind schedule. "We never committed to customers on it. Our present plan is to deliver substitute technology within three months of when we had planned to deliver the

LSI-16 computer."

Noorda says that General Automation will be able to provide an alternate processor by the middle of next year—choosing either from among its own products or from something available on the market. For some customers, then, this means a microcomputer board using a microprocessor chip set. □

Solid State

Gain up, size down in bipolar process

Researchers at West Germany's Siemens AG have come up with a simple method for improving the performance and reducing the size of bipolar npn transistors. It relies on a modification of a standard transistor fabrication process.

Called the polysil-emitter process and developed by Helmuth Murr-

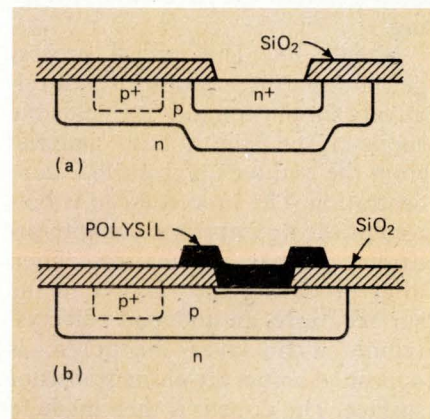

Difference. Polysil process, bottom, removes dip under the emitter and controls base width precisely.

mann and Andreas Glasl at the company's Munich laboratories, it facilitates the manufacture of npn transistors. Their base widths can be more precisely controlled than ever before and, for a given doping level of the active base, current gain can be 10 times that obtained by the standard process.

Using normal 4-micrometer-wide structures, the Siemens researchers expect they will soon be able to produce polysil-emitter transistors with oxide isolation that will have an area of only 500 square micrometers. This compares with roughly 3,000 μm^2 for a transistor fabricated by the standard process with pn-junction isolation. Murrmann says the process is "especially attractive" for large-scale integrated circuits.

In a standard npn transistor, the dip effect under the phosphorus-doped emitter is a big operational drawback. Showing up as a bulge in the base region (see top of figure on page 23), the dip makes it difficult to control the base width precisely during device fabrication. It also increases the internal base resistance, and the actual emitter efficiency turns out to be far below the theoretical value determined from the emitter's doping level.

The dip occurs because of the high doping concentration in the emitter's surface—usually a result of crystal imperfections. The reason for the lower actual efficiency, on the other hand, is the high recombination rate of the minority carriers and a drop of the effective emitter-doping.

Simple fix. The polysil process gets around these problems in a relatively simple manner. It shields the single-crystal silicon base material from the emitter's high surface concentration. The process (see the bottom of the figure) starts out with ordinary planar fabrication. Then after producing the window in the surface oxide, an undoped polycrystalline silicon layer—the polysil—is deposited across the entire transistor surface. The dopant is then made to diffuse through the polysil layer into the base material below, but the high doping concentration is con-

fined to the polysil layer on the surface.

Next, the polysil is etched so that an overlapping cover for the emitter hole is left. Finally, etching for the base contacts and the metalization step are performed in the usual fashion.

The high current gain results from the relatively low emitter-doping level in the single-crystalline material. This leads to a high emitter efficiency. The high current gain and the small base resistance—the latter stemming from the high doping concentration in the base—result in only a small voltage drop across the base region.

All this translates into a considerable area reduction, for the higher the current gain and the lower the base resistance, the smaller it's possible to make the emitter length and

the base area under the emitter.

Investigations into the experimental polysil-emitter transistors have shown some other surprising results, Murrmann points out. The base width is determined primarily by the base penetration, and this means that polysil transistors have a high degree of reproducibility.

Because of the low emitter penetration, a relatively high base width remains so that the cutoff frequency, f_t , of the polysil emitter is rather lower than the f_t of normal transistors. However, by reducing the penetration of the base, the base width can be controlled so that higher cutoff frequency values can be obtained without affecting the behavior of the polysil emitter. The Siemens researchers expect to obtain cut-off frequencies of up to 4 gigahertz. □

Customer desire for greater board density causes shift to small 4-k RAM packages

Just when it looked as if semiconductor manufacturers had settled on two package approaches for 4,096-bit random access memories—a 16-pin and a 22-pin version—suddenly a new volley is being aimed at providing parts that boost board densities.

First, Texas Instruments, Dallas, introduced an 18-pin version [*Electronics*, Dec. 12, p. 30], and now Intel Corp., Santa Clara, Calif., one of the standard bearers in the 22-pin camp, will put its 4-kilobit design into a 16-pin package, while continuing to supply the 22-pin part. And National Semiconductor Corp., Santa Clara, which intended to make the TI/Intel 22-pin standard, is now supplying an 18-pin device as well.

Samples of the National parts will be available in March or April, and production quantities are scheduled for the middle of the year. The company's 18-pin device differs from the TI part in that it has a more familiar tri-state type of output, instead of the open-collector type.

Dave West, marketing manager at Mostek Inc., Carrollton, Texas, points out that the 16-pin package, which Mostek pioneered, yields almost twice the packing density on a printed circuit board as the 22-pin part. And, points out Jim Coe, Mostek's applications engineering manager, users already have the automatic insertion equipment needed for 16-pin and 18-pin packages. Such equipment was purchased for the older 1,024-bit RAMs, which are supplied in the same packages. Equipment to handle the 22-pin package isn't readily available yet, Coe says.

Mostek received a big boost recently when NCR Co. selected its 16-pin RAM for its point-of-sale terminals, financial data systems, and mainframe computers.

But TI's counter-move with an 18-pin package could take some of the wind out of Mostek's sails. The difference in packing density on a board between 16- and 18-pin packages isn't nearly as great as it is between the 16- and 22-pin parts. The

18-pin part is faster than most 16-pin devices, so that users may opt for the greater speed rather than what could only be a rather modest increase in board-packing density.

Mike Markkula, North American marketing manager at Intel, doesn't believe that will happen. Manufacturers of minicomputer and remote intelligent-terminals, he points out, are particularly concerned about small size. But large-computer manufacturers put a premium on throughput.

"The first [type of manufacturer] wants high-density memories, and the second wants high-speed memories," says Markkula. "Mini-computer manufacturers use the 16-pin rather than the 22-pin because it allows them to use the same number of bits of memory but reduce the board size by 15% to 25%."

No plans. Texas Instruments has no plans to follow its 18-pin RAM with a 16-pin version, says Edwin S. Huber, product marketing manager for MOS memories. "Because of the particular circuitry that's used for the 16-pin's multiplexed addresses, a 16-pin package would require a completely new design, significantly changing our chip. We cannot get both the 18- and 22-pin RAMs from the same chip."

He points out that the 16-pin version with the two clocks and complicated phasing that are used may be more difficult to apply to transistor-transistor-logic memory where level-shifting is not required. □

Memory

Density pushed by bubble lattice

Working with a new storage concept, IBM Corp. researchers say they believe they can increase the capacity of bubble memories by 16 times and probably much more.

In fact, the IBM approach, called a Bubble Lattice File store, may indeed have no practical upper limit in terms of information storage den-

Army seeks first-round targeting capability

The war in Vietnam convinced Army officials they needed a system that would detect the first round of artillery fire, and by calculating its trajectory, pinpoint the gun that fired it. One solution to the problem is this artillery-locating radar, built by Hughes Aircraft Co. for the Army Electronics Command, Fort Monmouth, N. J. Sperry Rand Corp. is also submitting an entry in the AN/TPQ-37 competition and will shoot it out with Hughes at the Field Artillery Center, Fort Sill, Okla. Hughes employs a three-dimensional radar that scans the horizon with a pencil-beam that's electronically steered. The antenna array contains hundreds of discrete phase shifters. Until the test results are in, however, Army officials are taking a wait-and-see attitude. They suggest that a system combining radar and acoustic sensors may ultimately solve the artillery-locating problem, as well as the more perplexing mortar-locating problem. ECOM is also funding development of a mortar-locating radar, for which Hughes is also competing.

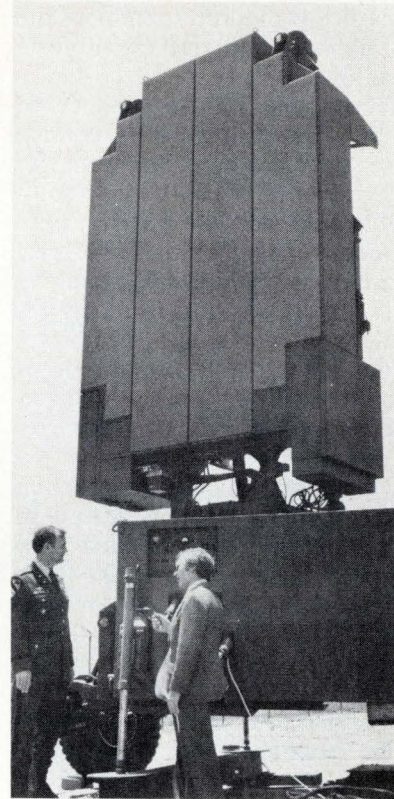

sity, says Otto Voegeli, of the company's Research Laboratory in San Jose, Calif.

"At the very least," he says, "it will separate the problem of boosting information storage capacity from the problem of improving the resolution of photolithographic techniques used to make bubble-memory devices."

In conventional bubble memories, magnetic bubbles—flat cylindrical shaped domains of magnetization contained in garnet material—are moved from point to point by applying a rotating magnetic field to thin-film permalloy patterns of T's and I's deposited on the garnet. The rotating field causes different parts of the pattern to alternate polarity, pulling the bubbles along. The presence or absence of bubbles at different points can represent binary 1s and 0s.

Crystalline. The new concept packs the bubbles close together in a configuration that resembles a crystalline lattice; hence, its name.

"In most other memory devices—core, semiconductor and conventional magnetic bubble—some device structure is used to define each bit position," says Voegeli. "As a result, the density of the memory depends on how small you can make that structure."

Thus, the storage density of magnetic bubble devices depends in part on how fine the dimensions of the T- and I-bar structures can be fabricated using photolithographic techniques. In the lattice file, these structures are eliminated, and, though photolithography is used, line geometries need not be as small. The storage density possible with conventional bubble memories is high. Bell Telephone Laboratories, for example, has fabricated a 250-by-195-mil memory chip containing 16,448 bits [*Electronics*, May 16, p. 29].

In the bubble lattice, the bubbles themselves define the bit positions in exactly the same fashion as atoms arrange themselves in a crystal. "The position of each bubble is de-

fined by its interactions with its neighbors," Voegeli explains. "Since the lattice is the lowest energy state the bubble can attain they will form one if given a chance."

Packed. The bubbles are packed together very densely with no empty spaces so that a zero can no longer be represented by the absence of a bubble. Instead, IBM scientists use magnetic differences in the wall surrounding each bubble. The magnetization gradually rotates along this boundary region from up to down. In some bubbles, the direction of rotation is constant around the perimeter. In others, the direction reverses many times.

"Not only can we generate ten states randomly but we can also generate them in a controlled fashion—that is, to write—only those bubbles which either do not reverse direction or which reverse once," says Voegeli. "We do this by imposing an in-plane magnetic field on bubbles fed through a channel."

The researchers have also found that bubbles with no reversals travel in a straight line when subjected to the in-plane magnetic field, while those with one reversal are deflected at an angle of about 30°. Thus by superimposing current conductors on the film, it was possible to construct a reading device to separate the two bubble types and detect 1s and 0s.

"At this point, we have built the read, write and storage functions of the BLF on separate chips," he says. "Before we integrate them in a single device we want to consider several alternative methods of reading, writing and storing." □

Consumer electronics

TV to get more digital tuning

Despite a dismal year for color television-sales, semiconductor manufacturers continue to offer all-electronic, digital tuning systems to penny-conscious TV-set makers.

Manufacturers were receptive to two new systems—one a joint development by Plessey Semiconductors Inc., Santa Ana, Calif., and National Semiconductor Corp., Santa Clara, Calif., the other from Fairchild Semiconductor division, Mountain View, Calif. Both were demonstrated at this month's Chicago Fall Conference on Broadcast and Television Receivers. Currently implemented with off-the-shelf small and medium-scale-integrated packages, they are variations on the frequency synthesis theme that's been around for several years. But the advent of inexpensive 1-gigahertz dividers to interface with broadcast oscillator frequencies that reach 931 megahertz makes the approach "ec-

onomically and technically feasible for the first time," comments Eric Breeze, a staff engineer for digital applications at Fairchild.

Under \$30. Fairchild's tuner-control package, including light-emitting-diode display, sells for less than \$30, he says, and if the components are integrated further, it could hit the \$15 range that's competitive with the electromechanical components now used.

The National/Plessey system is also under \$30 but without LEDs. When much of the electronics are integrated onto a single MOS chip next year, the system should go for \$12 or \$13 in half-million quantities, says Joseph Obot, consumer marketing manager at National. The

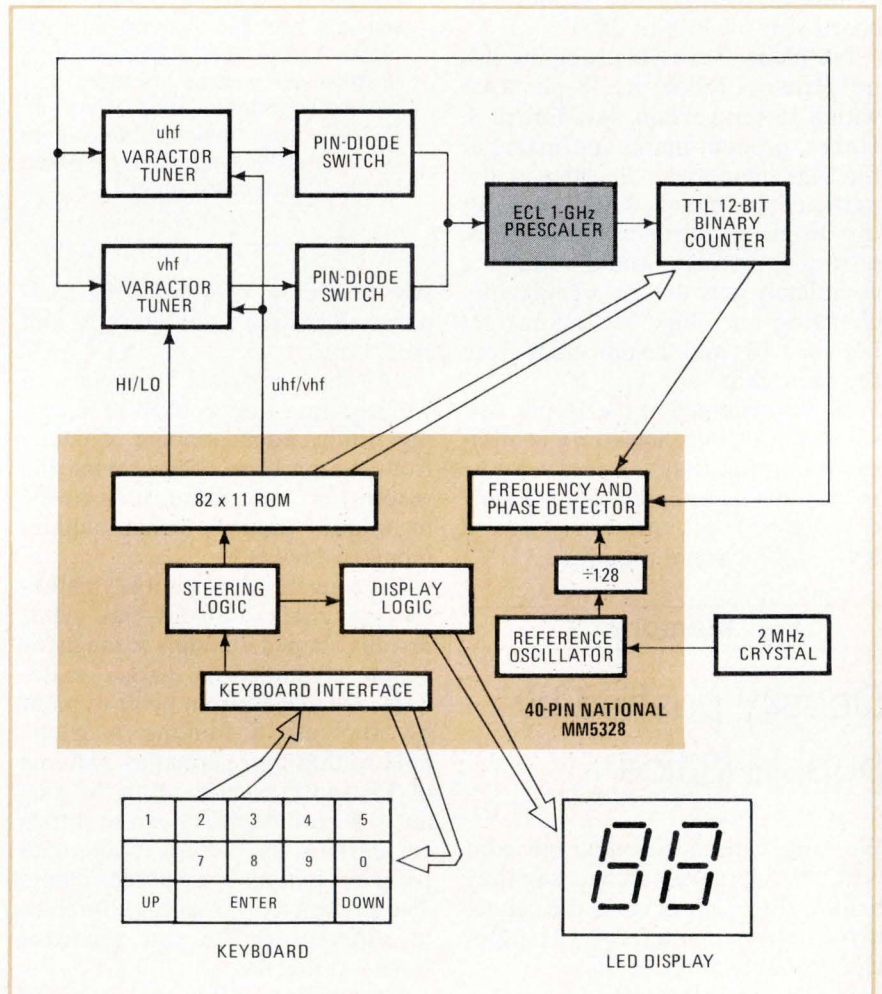

Turn-on. TV-channel synthesizer/controller section of digital tuning circuit developed jointly by National Semiconductor and Plessey Semiconductor eventually should be integrated in single 40-pin National package. Plessey is building the 1-GHz prescaler.

PICK A PERFORMER

Select any of 5 display modules...
15 plug-ins...
convert to cabinet or rackmount

Measurement capabilities, application flexibility and a conservative price tag are three sound reasons for specifying Tektronix 5100 Series low-frequency oscilloscopes. Designed to keep pace economically with changing measurements and applications, the 5100 Series offers a choice . . . five display units featuring dual and single beam, storage and non-storage displays . . . fifteen low-cost, interchangeable plug-ins with 1-8 traces . . . normal and delayed sweep . . . bench or rackmount models. Designed for operation from DC to 2 MHz. Depending upon plug-in selection, the 5100 provides conventional or differential measurement capabilities, curve tracing, and even sampling to 1 GHz. The scope buyer may now select the exact configuration and capabilities to meet his present needs, and be confident

that future measurement applications can be accommodated by adding other plug-ins or display units. The cost? As low as \$765 for a complete oscilloscope.

For detailed specifications contact your local Tektronix Field Engineer or write: Tektronix, Inc., P.O. Box 500, Beaverton, Oregon 97077. In Europe, write Tektronix Ltd., P.O. Box 36, St. Peter Port, Guernsey, C.I., U.K.



TEKTRONIX®

committed to
technical excellence

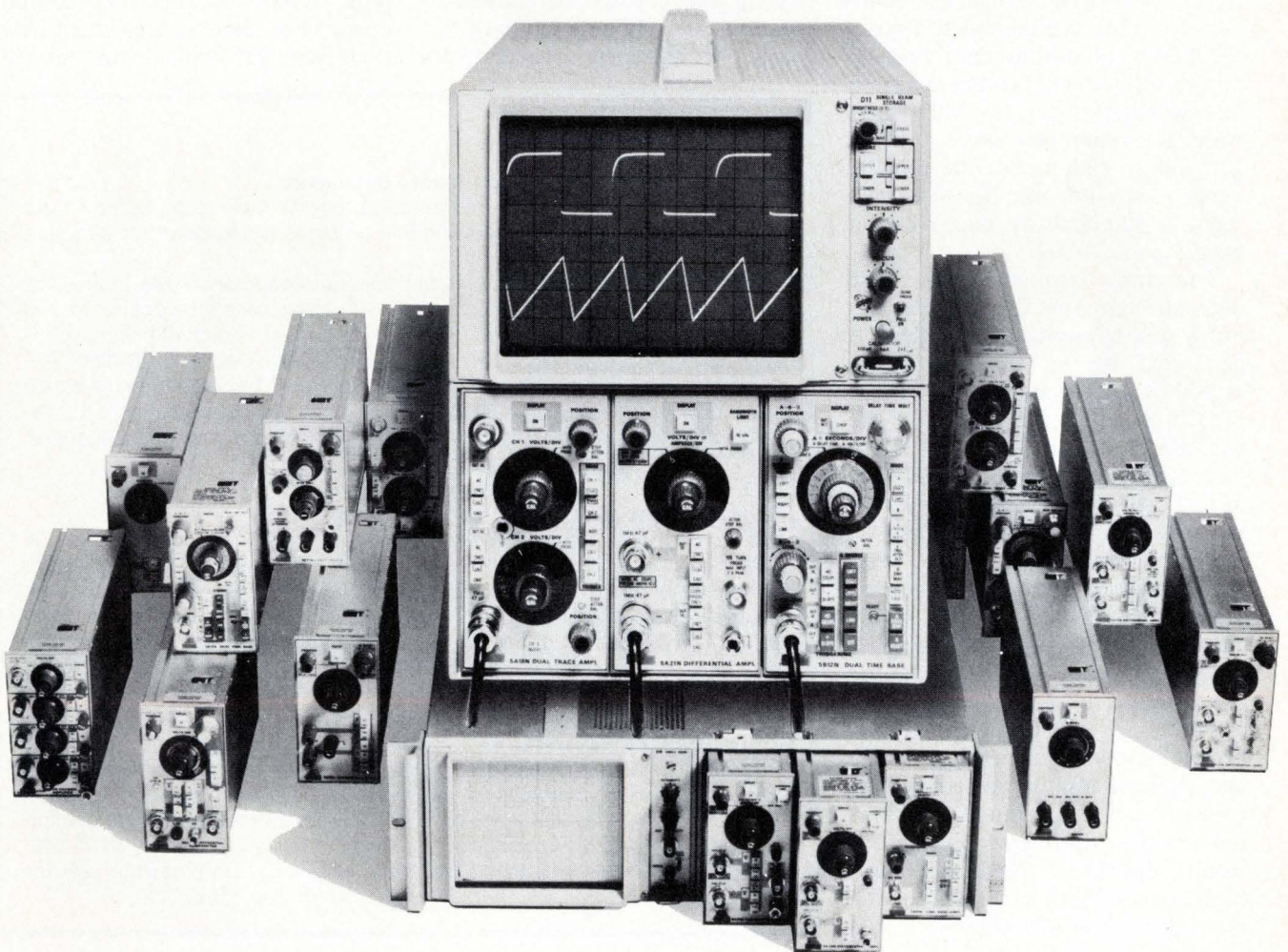

system has been shown privately to "several key accounts," and Obot expects to see it on dealers' floors some time next year.

At the center of this frequency-synthesis approach is a one-chip TV channel synthesizer/controller that National hopes to implement in metal-oxide-semiconductor technology. Plessey, responsible for manufacturing and marketing the complete system, shown in the figure on the preceding page, will also provide the 1-GHz emitter-coupled divider circuitry logic that serves as the system's prescaler, a fixed divider necessary to get high-frequency signals from the ultra- and very-high-frequency tuners down to transistor-transistor-logic ranges.

Converter. Working from a conventional calculator-type keyboard through on-chip decoder/interface circuitry, the proposed National MM5328N uses an 82-by-11-bit read-only memory to convert channel input into digital codes. Two of the ROM's 11 output lines turn on either uhf or vhf varactor tuners and switch between the vhf bands, while the remainder drive a 12-bit TTL binary counter. In the discrete version now offered, the ROM segment is handled by two 2-kilobit programable ROMs.

The chip's frequency and phase detector compares the counter output with a reference signal, which is generated by an external 2-MHz crystal oscillator, and then feeds the resulting dc signal back to the varactors to provide an exact phase lock with the divided-down reference. Data for a seven-segment LED or an on-screen channel display, such as is used by Magnavox Corp.'s STAR tuner [*Electronics*, June 27, p. 34], is supplied by the chip. The chip also has the capability for up-down channel scanning for remote control applications.

With an optional battery, the National/Plessey circuit can store the last channel number when the receiver is turned off; on-screen channel and time display require an optional character generator and digital clock, both now used in the Heathkit high-end television kit

[*Electronics*, Jan. 10, p. 38].

Fairchild's approach is similar, but instead of programing the 12-bit counter with a ROM, it uses a digital offset approach, which requires low-cost gating to detect the offset. To obtain the local oscillator frequency for input to the programable counter, the Fairchild algorithm multiplies the channel number by six and adds a constant, which changes for each of the three television bands. □

Instruments

Simple components gauge microwaves

Measuring the parameters of high-frequency signals over a wide frequency range is usually a time-consuming job. Precise test equipment must be carefully tuned at each frequency to eliminate frequency-de-

pendent errors caused by such things as impedance mismatches. And phase information about a signal requires even more specialized test gear.

But a physicist at the National Bureau of Standards, Boulder, Colo., has come up with a simple method for deriving complex amplitude/phase parameters from standard wattmeter readings.

According to Cletus Hoer, voltage, current, power and phase parameters on a transmission line can be calculated by using a six-port system (see figure on page 30) and combining the readings of four wattmeters in linear equations that he has developed. Only standard off-the-shelf hardware is used, and frequency-dependent variations in the couplers and elsewhere are canceled in the mathematical manipulations.

Originally, the design of the six-port called for precision components. But Hoer determined that even large variations across the fre-

News briefs

Reshuffle at Intel would make Moore chief exec

The names will be the same, but the top brass at Intel Corp., Santa Clara, Calif., will recommend the following title changes to the board of directors next April:

Robert N. Noyce, president, would become chairman of the board. Arthur Rock, the current board chairman, would become vice chairman and chairman of the executive committee. The president and chief executive officer would be Gordon E. Moore, who is now executive vice president. Andrew S. Grove, vice president of operations, would become executive vice president. Component operations would be divided between Leslie L. Vadasz, who will manage engineering and quality assurance, and Eugene J. Flath, who will head manufacturing.

Du Pont develops new fiber-optic-material

The du Pont Co. has developed a new plastic fiber-optic cable for use in data transmission. Called PFX, the material stems from du Pont's earlier development of its "Crofon." Transmission loss, at 656 nanometers, according to du Pont, is 470 decibals per kilometer for PFX, which is available in polyethylene-jacketed cables containing seven 15-mil fibers. Du Pont expects the material will be used in aircraft, computers, secure short-length communications lines and comparable data-transmission applications.

Color-TV leads November consumer-electronics drop

Electronic Industries Association says that consumer electronic products sales in November continued to decline in all categories. Color-TV receivers fell 30.6% to 628,382 units from the same month last year. The decline put sales for the first 11 months at less than 7.1 million receivers, off 13.6%. Monochrome receiver sales of 503,000 for November were down 27.2% for the month, while the 11-month total of 5.3 million was down 14%.

Why You Should Buy Telequipment...

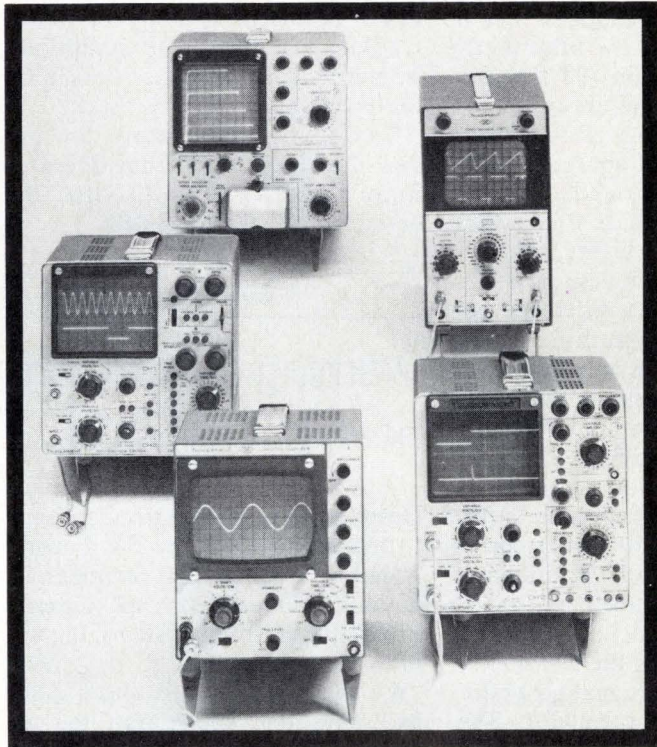

Telequipment instruments can be your best buy for trouble-shooting consumer electronic products at the bench or in the field, for many laboratory applications, for manufacturing production control, for student labs, and for broad areas of design engineering—virtually any price-sensitive area of application where the instrument specifications meet user demands. The performance and reliability of Telequipment instruments are well established.

The D61 10-MHz dual-trace oscilloscope, for example, has been acclaimed by independent experts for its "unique features and superior performance." (Use the coupon for a copy of the article, *Reports from the Test Lab.*) The D61 is chosen as a quality 10-MHz dual-channel oscilloscope throughout the industry. TV line or frame triggering and provisions for X-Y vector patterns make the D61 especially well suited to consumer product ser-

vice shops. Its stable triggering characteristics, front panel simplicity, and versatility make it an excellent choice for industrial and educational use, as well.

The Telequipment line also includes the DM64 10-MHz dual-channel storage oscilloscope, the exceptionally low-priced S51B 3-MHz oscilloscope, and more. There's an easy-to-operate transistor curve tracer, the CT71, that has wide application in schools and design labs.

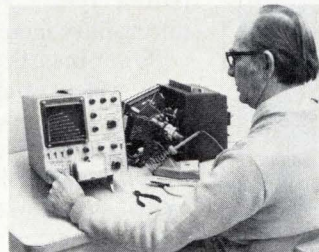

The D67 oscilloscope combines dual trace, 25-MHz bandwidth, FET inputs, regulated power supplies, and all solid-state circuits with delayed sweep capability—a combination of features seldom found in such a low-priced oscil-

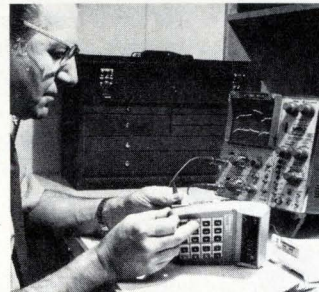

loscope. (Ask for the D67 article reprint, *Another Step Forward.*) Its sister scope, the D66, offers all features but delayed sweep at an even lower price. Both feature a SUM mode with normal/invert capability that improves visibility of small signals in the presence of common mode noise.

Tektronix supports Telequipment with its full corporate services and network of field engineers, providing complete specifications, applications notes, consultation and demonstrations, and warranty. Consider the prices as well...

Model	Features	Price
S51B	3 MHz, Single-Channel	\$ 325
D61	10 MHz, Dual-Channel with X-Y	545
CT71	Curve Tracer	895
D66	25 MHz, Dual-Channel	875
D67	25 MHz Dual-Channel, Delayed Sweep	1,125
DM64	10 MHz, Dual-Channel, Storage	1,195

There are many good reasons why you should buy Telequipment—some general, some specific. To learn more, contact your local Tektronix Field Engineer or write Tektronix, Inc., P.O. Box 500, Beaverton, Oregon 97077. In Europe, write Tektronix Ltd., P.O. Box 36, St. Peter Port, Guernsey, Channel Islands.

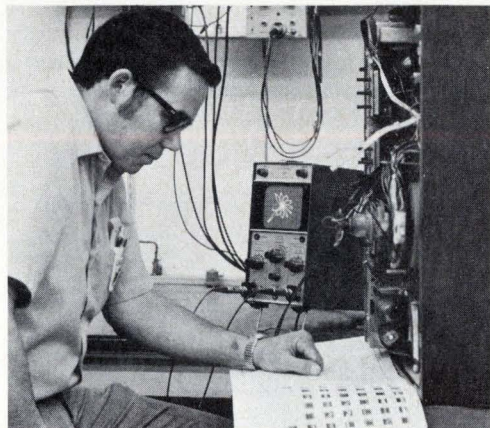

For demonstration circle 28 on reader service card.

I want to learn more about Telequipment instruments:

Name _____ Title _____

Company _____

Address _____

City _____ State _____ Zip _____

- I would like the full specifications on Telequipment instruments.
 I want a demonstration of _____, so have a Tektronix Field Engineer contact me.

I want the independent magazine article reprint on the D61 D67.

E 12/26/74

TEKTRONIX®
 committed to
 technical excellence

Circle 29 on reader service card 29

TRANSFORMING POWER TO YOUR NEEDS

When it comes to custom-made low-power transformers there is one company that has the edge over others.

Ofakim Transformers.

It designs and produces high-quality transformers for military and industrial applications worldwide, with strict adherence to the client's specifications (or U. L.) in terms of his power needs.

Prices are reasonable and delivery is fast for any quantity—but not before each model is carefully inspected for performance, reliability and durability.

OFAKIM TRANSFORMERS LTD

42 Hai Iyar St., Tel Aviv, Israel.
Tel. (03)257220 Telex Coin IL 32470

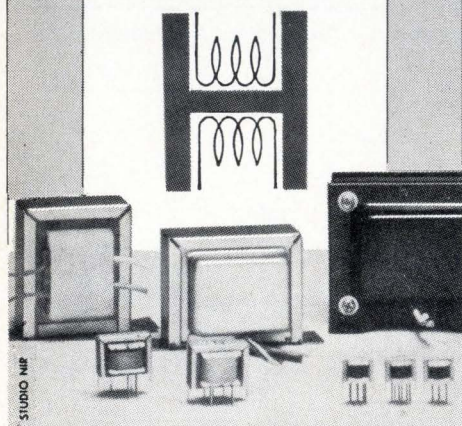

quency band of some of the component characteristics would not materially affect measurement accuracy.

"Ideally, you would want 90° phase shift in a quadrature hybrid, for example," says Hoer, "but as long as there is some appreciable phase shift, it is useful."

Uncertainty. He explains that if the system has a 1% uncertainty when using optimum (90°) phase-shift components, the uncertainty is still only 2% as long as the phase shift is within 60° of optimum—anywhere between 30° and 150°, he says. The error in phase shift makes the meter readings higher, and because the parameter desired is obtained by taking the difference between two large numbers, the uncertainty increases only slightly.

Power measurements with the six-port system and with a manually tuned system operating as a base for comparison showed agreement within 0.1% for low reflection coefficients, says Hoer. For higher coefficients, he expects similar, although not quite as close, agreement.

Hoer has automated the measurements by interfacing the wattmeters and a programable signal generator to a programable calculator. The calculator performs the required mathematical manipulations on the wattmeter outputs at frequencies it programs into the generator.

The equations themselves are straightforward. For example, the power at a point, P, might be expressed in the form:

$$P = q_1P_1 + q_2P_2 + q_3P_3 + q_4P_4$$

where each q is a constant that is affected by parameters such as phase

shifts within the six-port assembly, and the Ps are readings on the four wattmeters.

Hoer then determines the values of each q by introducing known conditions, such as pure reactances, at the measurement plane, reading the meters, and solving a series of linear equations relating the power readings and the circuit conditions. In effect, Hoer calibrates the circuit for its operating characteristics.

Two six-port systems are now under development. One operates from 1 gigahertz to 12 GHz, the other, from 2 GHz to 18 GHz. □

Avionics

Warning system stirs heat, but not sales

Despite the publicity given recently to the requirement by the Federal Aviation Agency that commercial aircraft be outfitted with Ground Proximity Warning Systems, the airlines are not rushing to buy them. "We will not be forced into a quick fix," says one spokesman for the aviation industry, which may have to spend \$30 million to install the GPWS in some 2,300 aircraft.

At present, there is only one source for the system, Sundstrand Data Control Inc., Redmond, Wash. And it has not received any new orders from any airline since the FAA requirement was announced in September [*Electronics*, Oct. 3, p. 46]. The Sundstrand system warns the pilot with a siren and in a loud recorded voice when the aircraft is not

New Way. Microwave circuit parameters are being measured at NBS without manual tuning by six-port junction (right). Calculator (left) is programmed to select signal frequencies.

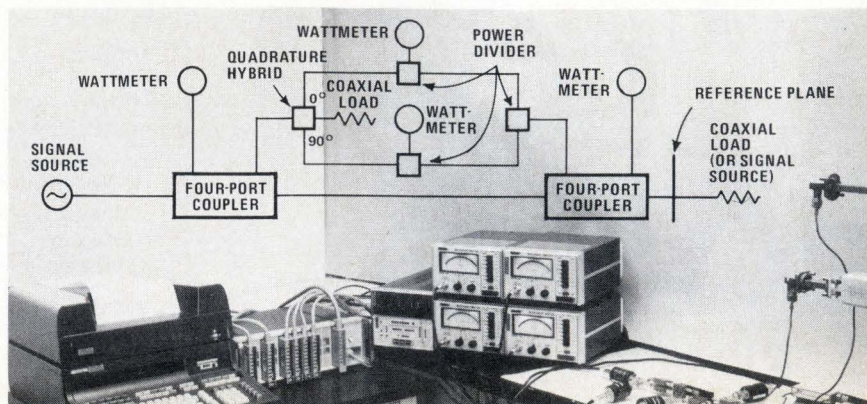

6 ways you can get design flexibility with Panasonic miniature aluminum electrolytics.

1. Panasonic L Series gives you a complete range of standard miniature electrolytics for commercial, industrial and entertainment use. Wide range, from .47 μ fd to 10,000 μ fd. 6.3 through 100 volts. Available in axial and radial design, with temperature range of -40°C to +85°C. Panasonic L series mini's can be ordered in standard capacitor tolerances of $\pm 10\%$; $\pm 20\%$; or -10%, +75%.

2. Panasonic MS Series can be used to replace larger, more costly mylar capacitors. Their small size reduces space and weight on your PC boards. And because of their extremely low leakage and ESR ratings the MS series can be used to replace dipped tantalums at considerable cost savings. Panasonic MS electrolytics have a capacitance range of .1 μ fd through 100 μ fd, 6.3 to 100 WVDC.

3. Panasonic 2H Series gives you top performance under wide temperature conditions. Temperature characteristics from -55°C to +105°C. They have long product life and are available in radial and axial types. These electrolytics can be ordered in a choice of tolerances; $\pm 10\%$ and $\pm 20\%$.

4. Panasonic 3H Series incorporates very wide temperature range (-55°C to +125°C) and attractive low temperature stability characteristics. The 3H Series can also meet most stringent environmental conditions. Available in axial and radial lead configurations with a choice of tolerances; $\pm 10\%$, $\pm 20\%$.

5. Panasonic Z Series are designed specifically for high stability over a temperature range of -40°C to

+85°C. These miniature electrolytics have exceptionally smooth performance curves for temperature vs. capacitance, temperature vs. impedance and D.F. vs. temperature. Both in radial and axial type.

6. Panasonic High Voltage Electrolytics rated up to 500 volts (axial type) and up to 350 volts (radial type). Temperature range from -25°C to +85°C. Panasonic High Voltage Electrolytics are available in capacitance tolerances from -10%, +100%; -10%, +75% or $\pm 20\%$.

Panasonic miniature electrolytics can meet most tough design specifications that call for very close tolerances, demanding ESR and leakage specs. We invite your special requirements. Panasonic's wide range of miniature electrolytics may be the answer to that special application problem you are trying to solve.

Matsushita Electric Corp. of America
Industrial Division
200 Park Avenue, New York, N.Y. 10017



- Have a representative call.
- Send more information on aluminum electrolytics.

Name _____
Title _____
Company _____
Address _____
Phone _____

Panasonic Electronic Components
our technology is all around you

Circle 31 on reader service card

1 AMERICAN MADE

Tolerance
SCHAUER
1-Watt
ZENERS

Immediate Shipment
Low Prices

ANY voltage from 2.0 to 16.0

Quantity	Price each
1-99	\$1.07
100-499	.97
500-999	.91
1000-4999	.86
5000 up	.82



Write for complete rating data and other tolerance prices.

Buy the kit-
Save
a lot



Kit contains a 51-piece assortment of SCHAUER 1% tolerance 1-watt zeners covering the voltage range of 2.7 to 16.0. Three diodes of each voltage packaged in reusable poly bags. Stored in a handy file box. Contact your distributor or order direct.

A \$54.57 value for

ONLY **\$24⁵⁰**

Semiconductor Division

SCHAUER

Manufacturing Corp.

4514 Alpine Ave. Cincinnati, Ohio 45242

Telephone: 513/791-3030

Electronics review

gaining altitude quickly enough after take-off, if descent is too rapid during landing, or if rising terrain requires increased altitude.

Installations were to have been completed by mid-1976. But, following a crash in Virginia last month of a Trans World Airlines Boeing 727 that killed all 92 persons aboard, the FAA moved up the installation schedule to December 1975.

Waiting. The airlines have not ordered the warning systems for several reasons, according to officials at the airlines and the Air Transport Association. They claim they are trying to add more capability to Sundstrand's system so it will alert pilots to more potentially dangerous situations. And they also want to see if the Bendix Avionics division, Fort Lauderdale, Fla., comes up with its integrated-circuit system by May 1975, as planned. Airlines want a choice of systems and more time to install them, says ATA.

An official of the airlines' technical consultant, Aeronautical Radio Inc., Annapolis, Md., says it would take the airlines about three years to install GPWS as part of a general maintenance schedule, although Pan American World Airways officials say they began installing the Sundstrand system earlier this year and will complete 250 aircraft in only nine months. "It's all a question of motivation," says an industry source. Arinc has yet to come up with a GPWS technical specification, though this is expected to be completed by early next year.

Commercial aviation has been rocked by criticism in the aftermath of the Virginia crash, which spurred Congressional criticism of the FAA's rule-making schedule. The Air Line Pilots Association has changed its position on ground-proximity-warning systems and has also been criticizing the FAA. Before the crash, ALPA said the system wasn't needed because it increases distraction in the cabin. But after the crash, ALPA became an advocate. To stop the loud warning signal and booming "pull-up" directive of the Sundstrand system, the pilot must act.

Sundstrand's market extends be-

yond the 2,300 domestic aircraft mandated by the FAA. In the U.S. alone, there are about 2,500 more turbojet aircraft, mainly business jets, for which systems probably will also be purchased.

Pan American and Boeing Co. have been Sundstrand's best customers. Boeing has included the Sundstrand system on all commercial aircraft it has produced since October. Braniff International Airlines and Scandinavian Airlines System have also installed them. □

Communications

Europe's first fast digital line

The British Post Office this month unveiled a trial digital telephone link operating at 120 megabits per second, which it claims is the first high-speed system to be put in the field in Europe. Besides inaugurating the impending conversion of the creaky English trunk telephone network, the system signals the start of digital procurements over the next few years.

Shown this month by Standard Telephones and Cables is a digital line system developed for the BPO which converts the 120-megabit stream into a 90 megabaud ternary line rate. The system transmits at one end and deconverts at the receiving end. After an 18-month trial of simulated traffic over the 40-mile hop between Guildford and Portsmouth, the BPO intends to order the first batch of equipment in 1976 for operation in 1978. Another trial link using digital line equipment jointly developed by The General Electric Co. and The Plessey Co. is planned to go into operation in 1975 between Portsmouth and Southampton.

Estimated cost for the 120-Mb line repeaters, which will go on existing 12-megahertz trunk lines, is about \$8 million. However, although the British chose the 120-Mb system to get moving and to be able to use

From the voltmeter house...



Discover how these auto-multimeters keep you out of trouble.

On the surface they may look like any well-designed digital multimeters.

Now look closer. What else do you see?

There... the Fluke name!

That indicates unusual performance.

We designed both the Fluke 8600A and the 8800A with auto range, auto zero, and auto polarity. **And every parameter is fully protected.** This means you can accidentally overload the instrument with too much current... too much voltage... or too much resistance!!... and you're still okay.

Another way you stay out of trouble: MTBF on each instrument is a minimum of 10,000 hours.

Now, the specs.

The 26-range Fluke 8600A, \$599. We packed this 20,000 count multimeter with five

ranges of volts from 200 mV through 1200 V ac and dc. Five ranges of current, 200 μ A to 2 A ac and dc. And six ranges of resistance from 200 ohms to 20 megohms.

Basic dc accuracy is a fully credible 0.02%. Options include built-in automatic rechargeable battery pack for up to 8 hours off-line operation. Digital output is also offered.

The 0.005% Fluke 8800A, \$1099.

This digital multimeter features five ranges of dc volts from \pm 200 mV

to \pm 1200 V. Four ranges ac from 2 V to 1200 V. And six ranges of four terminal resistance from 200 ohms to 20 megohms. For complete isolation the input resistance is better than 1,000 megohms on lower ranges and 10 megohms on the higher ranges.

For critical resistance measurements the instrument provides completely isolated four terminal ohms with less than 4 volts open circuit from 200 ohms through 20 megohms.

So there are the specs.

Impressive? We think so. But remember—specs are one thing. That name on the panel, however... It's what makes a Cadillac a Cadillac.

And a Fluke a Fluke.

For details, call your nearest Fluke sales engineer. Or simply dial our hot line.



For data out today, dial our toll-free hotline, 800-426-0361

In the continental U.S., dial our toll free number 800-426-0361 for the name and address of your nearest local source. Abroad and in Canada, call or write the office nearest you listed below, John Fluke Mfg. Co., Inc., P.O. Box 7428, Seattle, Washington 98133. Phone (206) 774-2211. TWX: 910-449-2850. In Europe, address Fluke Nederland (B.V.), P.O. Box 5053 Ledeborstraat 27, Tilburg, The Netherlands. Phone 013-67-3973. Telex: 844-52237. In the U.K., address Fluke International Corp., Garnett Close, Watford, WD2 4TT, England. Phone 0923-33066. Telex: 934583. In Canada, address ACA, Ltd., 6427 Northam Drive, Mississauga, Ontario. Phone 416-678-1500. TWX: 610-492-2119.

FLUKE[®]

For demonstration circle 129 on reader service card.

For information circle 33 on reader service card.

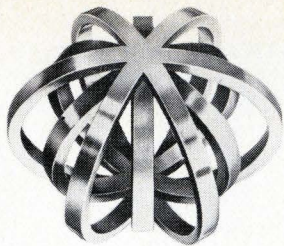

Keep on top of a market in constant evolution...

Two other sections will be devoted to the Press, Publications and Official Agencies.

In addition, there will be lectures, papers and films on technical subjects.

Specialists in automation, measurement, telecommunications, radio & TV, electro-acoustics, data processing, medical electronics, photo & film, automobile electronics, electronic household appliances, toys, watch & clockmaking, etc. . .

If you want to remain among the best informed specialists on a market in constant evolution, only a great international exhibition will allow you to size up the situation.

As in previous years, from April 2nd to 8th 1975 the 18th Salon International des Composants Electroniques will be the crossroads of technology, the source of new markets, the barometer of the business, and the foremost gathering place in world electronics.

The Salon International des Composants Electroniques will be held from April 2-8 inclusive (but excluding Sunday) at the Parc des Expositions, Porte de Versailles, Paris.

Total Floor area 61,000 M²
The equipment displayed will be broken down into four main sections:

- Electronic Components
- Measuring Instruments
- Materials specially prepared for electronics
- Equipment, Specific Products, and Production Line Methods for electronic components.

for you, this year again Paris is a must

Organization S.D.S.A.
20, rue Hamelin
75116 PARIS CEDEX
Tel: 553 13 26 - Telex 25688

For U.S.A.:
FRENCH TRADE SHOWS
1350 Avenue of the Americas
NEW YORK N.Y. 10019
Tel: (212) 582 4960 1

ENTRY CARD AND BROCHURE ON REQUEST

Electronics review

as much of its existing hardware as possible, it is out of phase with a Europe-wide 140-Mb system adopted after the British began their's. Thus, BPO officials have some crucial decisions to make on how to connect to the other system.

Links. The Post Office already operates low-speed 1.536 Mb/s local links. The new test hop extends digital PCM techniques to high-speed longer-distance hops for regular telephone, facsimile, television, or, eventually, computer data transmission. Speech in an ordinary telephone conversation will be digitized, transmitted and then reassembled as the original conversation. The 120-Mb/s line can handle up to 1,680 phone channels.

Basis for the digital network, whether local or trunk, is a 30-voice-channel pulse-code modulation multiplexer which encodes audio signals into 8-bit code and multiplexes them in a 2.48 Mb/s stream.

To step up the speed for the trunk network, a so-called second-order multiplexer developed by GEC combines four 2.048-Mb/s streams into a single 8.448-Mb/s stream. To kick this up to 120 Mb/s, a third-order multiplexer developed by Pye TMC Ltd. combines 14 8,448-Mb/s streams into the 120 Mb/s stream.

STC's digital line system transmits and receives the high-speed stream between stations. STC will also develop buried dependent regenerators, powered by cable from the repeater stations, to maintain signal quality at 1.2-mile intervals. The system is basically independent of the transmission medium, explains Mervyn Williams, BPO's director of telecommunications development. In addition to ordinary coaxial cable, it could transmit by microwave, or optical fibers, he says.

And, the new system is compatible with the existing 12 megahertz analog trunk transmission network, using the same repeater spacing, housing and power feeds. Compared with 174-Mb/s systems in the U.S. and Canada, the BPO system with its narrower cable will save on copper and installation costs and use less repeater power. □

**For PBX, computer memory
and instrument power
supply applications**

turn to CTS

for cermet resistor networks

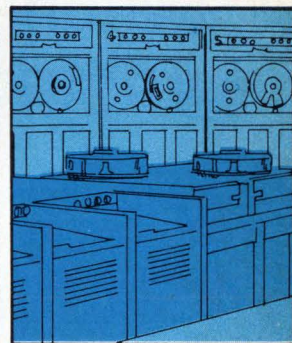
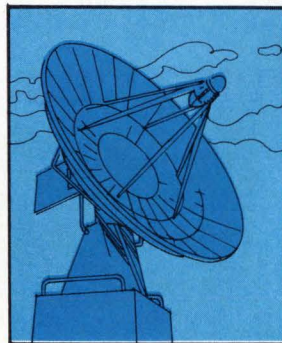
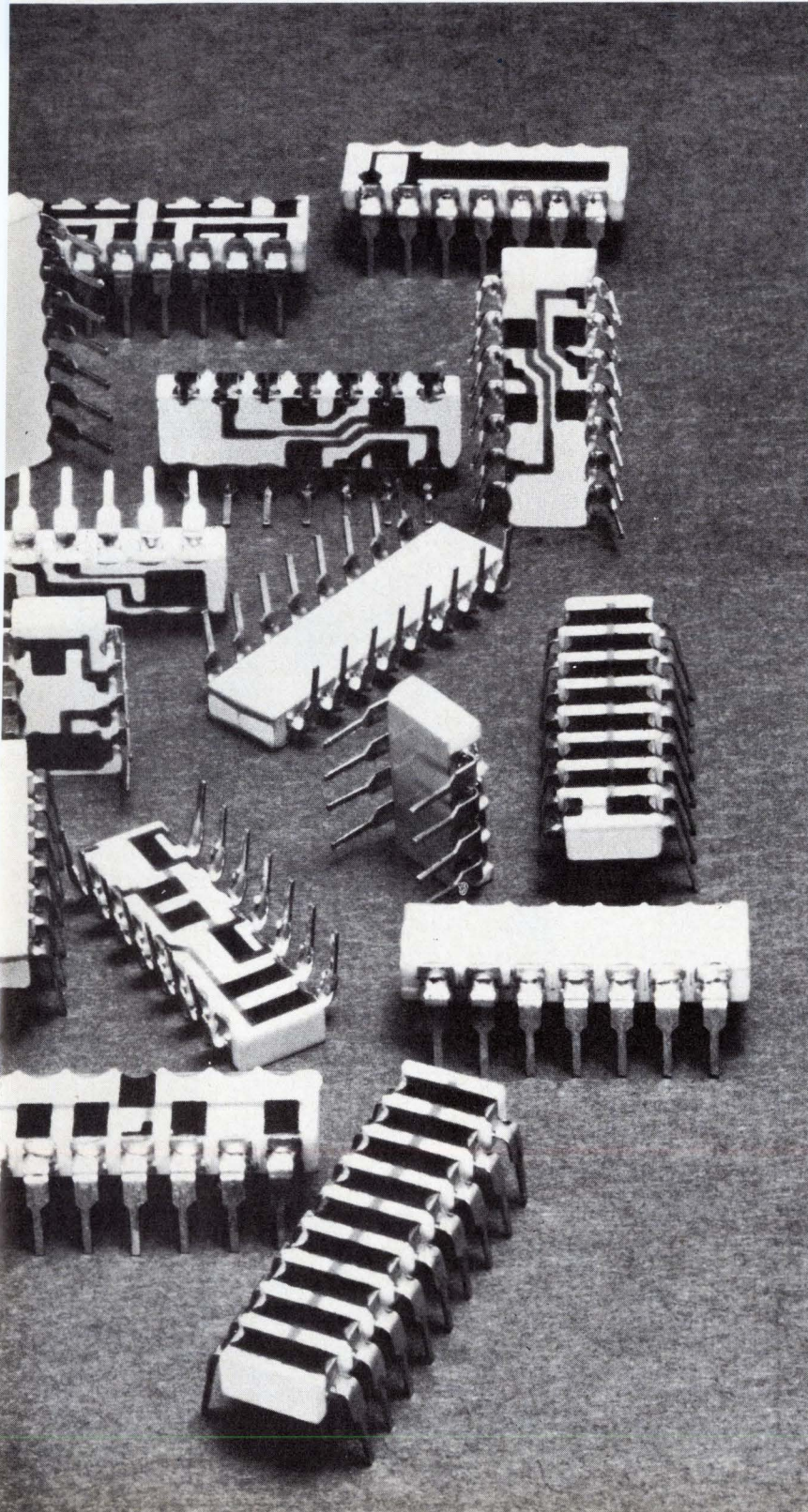

Save Space. Money. Time. It's easy with CTS Series 760 DIP Cermet Resistor Networks. Four popular packages . . . 8, -4, -16 and -18 lead styles . . . provide an infinite number of circuit combinations.

Compact, low profile design puts the squeeze on PCB space. Cost cutters, too. All designs eliminate lead forming and lead trimming for low cost automatic insertion along with IC's and other DIP components. Time saving? One 18-lead CTS 760 Series package can replace up to 32 separate components.

Available without organic cover coat, so you can trim for circuit balance. Precision .100" leads; rated up to 2 watts on 18 lead style; 5-lbs. pull strength on all leads.

Immediate delivery on standards. Custom designs to specifications. Be a saver. Turn to CTS of Berne, Inc., 406 Parr Road, Berne, Indiana 46711. Phone: (219) 589-3111.

Circle 35 on reader service card

CTS CORPORATION
ELKHART, INDIANA



A world leader in cermet and variable resistor technology.

Centralab perspectives

FOR USERS OF ELECTRONIC COMPONENTS

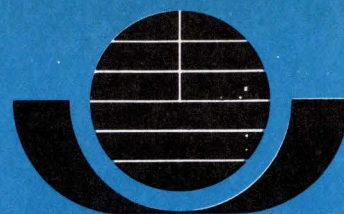

CENTRALAB

Electronics Division
GLOBE-UNION INC.

5757 NORTH GREEN BAY AVENUE
MILWAUKEE, WISCONSIN 53201

There's no easier way to select rotary switches – and Centralab's standardization program proves it.

A choice of four switch types, ten series and hundreds of optional switch-part combinations gives engineers a new and faster way to meet exact switching requirements of their designs.

No other line of standard rotary switches is as complete as the extensive new Centralab industrial line. It's everything that the word standardization implies – a way to quickly and exactly meet all your switching requirements and save both time and money.

The heart of this new line of standard rotary switches is the computer controlled factory inventory of standard switch components – with back-up stocks at local Centralab Distributors. This is the "bank" you draw upon in meeting your individual requirements. It assures you of the right switch, faster delivery and competitive prices.

Here's how the unique Centralab standardization concept works for you. The key to instant switch selection is our new 40 page catalog that gives complete specifications for sub-miniature, miniature, heavy-duty and power switches. It also details the wide choice of options available in shafts, bushings, indexes, spacers and standard

sections. Ordering your own "special" switch is simply a matter of checking off your requirements right from the catalog. You get the right switch for your individual needs by completing the simple specification sheet supplied and sending it to your local Centralab representative. Gone is the need to consult the factory. Your local representative can also provide complete information on price and delivery.

Before you specify another rotary switch send for the most helpful catalog ever printed. Its 40 pages give you all the details. Use the reader service card or call your Centralab representative. Discover what standardization really means.

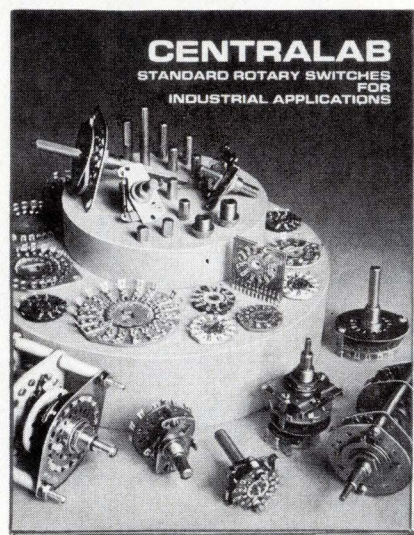

The wealth of engineering data in this new catalog on Centralab's unique line of standard industrial rotary switches makes it a real specifier's handbook. It is graphically simplified and color keyed for ease of use and contains reference charts like the one reproduced below, specifications, dimensional drawings, application data and easy ordering instructions. Ask for Catalog 1611S.

REFERENCE CHART

AVAILABLE FROM CENTRALAB DISTRIBUTORS

STANDARD INDUSTRIAL ROTARY SWITCHES	DIAMETER 	ELECTRICAL SWITCHING CAPACITY		MAXIMUM POSITION & THROW IN DEGREES	INSULATION	INDEX	STOPS	SHAFT TYPE	OTHER FEATURES		
		BRASS SILVER	SILVER ALLOY								
		0.12 amp @ 115 VAC 0.05 amp @ 250 VAC	0.12 amp @ 115 VAC 0.05 amp @ 250 VAC 0.1 amp @ 28 VDC 2.2 amp @ 28 VDC								
SERIES 140	1/16"	•	•	6 x 60° 8 x 45° 10 x 30° 12 x 30° 15 x 22 1/2° 18 x 20° 24 x 15°	Phenolic Ceramic GMA Epoxy	Easy Pushouts Slide Throat Hill & Valley Core Spring	Fixed Adjustable	Round Flanged Electroless (DIN/ISO)	•	53	
SERIES 160	1"	•	•	•	•	•	•	•	•	•	36
SERIES 050	1/2"	•	•	•	•	•	•	•	•	•	53
SERIES 500	1 3/8"	•	•	•	•	•	•	•	•	•	53
SERIES 550	1 1/2"	•	•	•	•	•	•	•	•	•	53
SERIES 670	2 3/8"	•	•	•	•	•	•	•	•	•	53
SERIES 710	1 3/8"	•	•	•	•	•	•	•	•	•	53
SERIES 300	1 3/8"	•	•	•	•	•	•	•	•	•	53
SERIES 650	2 3/8"	•	•	•	•	•	•	•	•	•	53
SERIES 230	2 3/8"	•	•	•	•	•	•	•	•	•	50

Centralab
perspective:

New ULTRA-KAP II™ capacitors

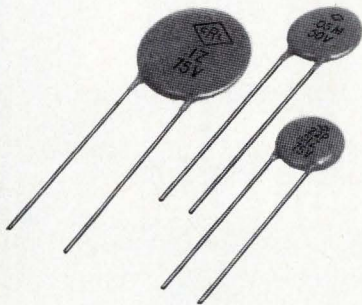

improved 3 ways

Ultra-Kap II doesn't replace our present Ultra-Kap line — it expands it. You still get more capacitance in less space, low dissipation and Y5F stability. In addition you enjoy these benefits:

NEW 75V SERIES in addition to 12, 16, 25 and 50V types. There are 3 standard values (.01, .05 and 0.1 μ F) to meet today's need for decreased size in this higher voltage rating.

INSULATION RESISTANCE that is 100 times better! On a 12V .05 μ F capacitor, for example, insulation resistance increases from 2 megs to 200 megs.

DIELECTRIC STRENGTH on the new Ultra-Kap II is rated at twice the working voltage. A 12V type can be used in applications having peak voltages of 24 volts. That's an added safety factor.

For details about new
ULTRA-KAP II, see your
Centralab Representative.



CENTRALAB
Electronics Division
GLOBE-UNION INC.

5757 NORTH GREEN BAY AVENUE
MILWAUKEE, WISCONSIN 53201

Circle 37 on reader service card

Centralab
perspective:

Trimmer resistors.

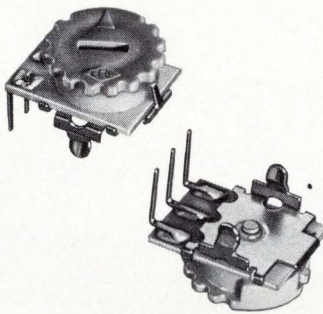

Now, with new Snap-Tite® rigid PC mounts.

When you specify the new Snap-Tite rigid mount you can simplify both installation and assembly. Available on both Centralab Series S carbon and cermet trimmer resistors, it lets you snap them into a PC board. Easy. The mount locks the trimmer securely into the board prior to soldering.

Centralab gives you more of the things you want in trimmers. Ceramic bases for higher wattage in a smaller space. Smooth positive adjustment. A variety of choices in mountings, terminations and knobs. And multiple sections too.

Send for Bulletin 1549T
so you'll have all the
specs.

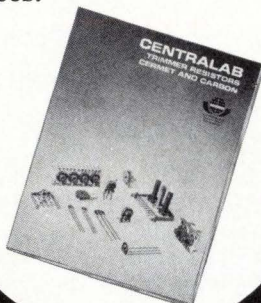

Circle 232 on reader service card

Centralab
perspective:

Transmitter Capacitors

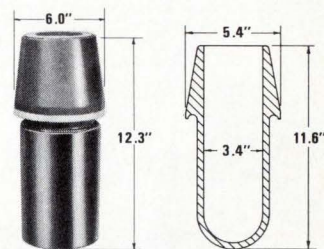

*Ceramic
dielectric
insert.*

Meet Specs For Extra Reliability and Save 50%.

When selecting capacitors for transmitter equipment, Centralab can help. Example: one ceramic dielectric type can replace two vacuum types — increase reliability — yet reduce both weight and cost by 50% or more. The cup type shown, meets specs calling for 6000 pf, 10 kV and current ratings of 100 amps at 500 kHz.

Centralab's line of special capacitors includes header, feed-thru, tubular, slug and water-cooled types — plus custom designs to meet any spec.

All it takes is a call to
Marty Hedrich at
414/228-2033.

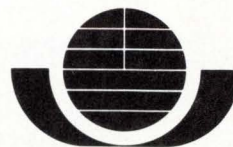

CENTRALAB
Electronics Division
GLOBE-UNION INC.

5757 NORTH GREEN BAY AVENUE
MILWAUKEE, WISCONSIN 53201

Circle 232 on reader service card

Q. what's new from the specialists in waveform analysis?

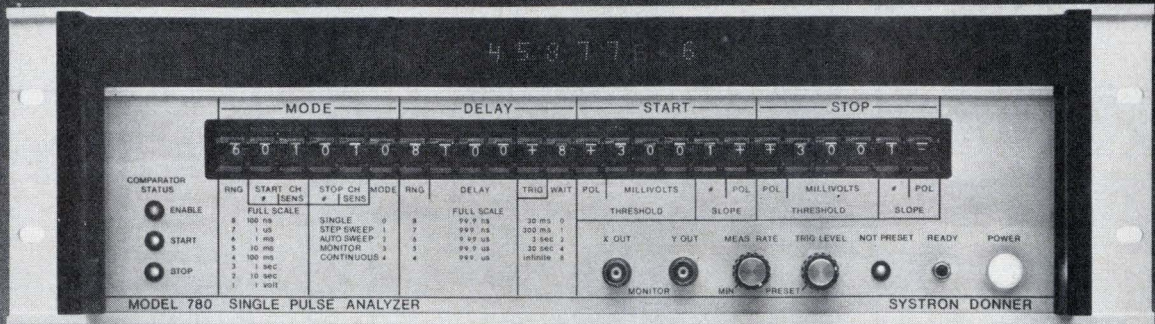

A. a systems measurement center that makes 3,000 measurements/sec!

Model 780 measures single transient to 100 MHz signals • Measures time from 0.1 ns to 10 s
Measures voltage with bandwidth from D.C. to 300 MHz • Calculator or computer compatible • ASCII buss programming.

For information on Systron-Donner waveform analysis instruments call your Scientific Devices office or Systron-Donner at 1 Systron Drive, Concord, CA 94518. Phone (415) 676-5000.

SYSTRON  **DONNER**

Circle 38 on reader service card

More news from the specialists in waveform analysis.

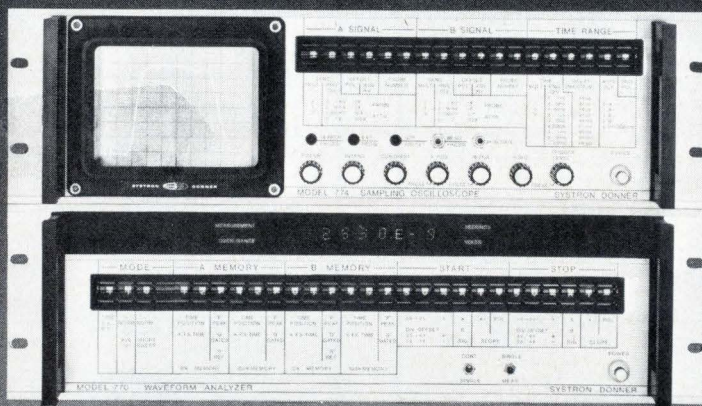

New automatic waveform analyzer ends signal seeking problems.

Fully programmable Model 770/774 features • Auto Delay to automatically find the signal and position it on CRT • Programmable trigger on signal capability • Select first through ninth pulse for analysis • 25 time ranges • Mix up to 100 programmable attenuator FET and sampling probes in the same system.

For information on Systron-Donner waveform analysis instruments call your Scientific Devices office or Systron-Donner at 1 Systron Drive, Concord, CA 94518. Phone (415) 676-5000.

SYSTRON  **DONNER**

38 Circle 39 on reader service card

Electronics/December 26, 1974

Inflation seen offsetting 1975 aerospace gains

U.S. aerospace sales in 1975 will reach a record \$28.9 billion, up 6.8% from this year's forecast \$27 billion, although "constant dollar figures will continue a three-year downturn" because of inflation and recession, says the Aerospace Industries Association. AIA president Karl G. Harr, Jr., estimates that 1975 military aerospace sales, for example, will rise less than 2% to \$13.3 billion but "the constant dollar figure indicates a better than 7% decline." **The National Aeronautics and Space Administration, faced with an actual dollar drop of 4.3% to \$2.4 billion next year by AIA's estimates, will buy 12.3% less than in 1974** (according to a constant dollar scale based on 1968). Commercial aerospace sales of \$8.2 billion in 1975, though gaining nearly 9% from this year, "will realize a very slight decline in real dollar value," says Harr.

Two maritime-satellite systems seek compatibility . . .

Shipboard communications terminals designed to work with Comsat General Corp.'s maritime satellite, Marisat, will be usable with its European counterpart, Marots, if negotiations now under way between the two systems developers are successful. Licensing arrangements are also being negotiated between terminal makers Scientific Atlanta Inc. and England's Marconi Ltd. Industry officials say **compatibility would greatly expand the shipboard-terminal market, which Comsat General predicts will go from 1,200 to about 4,500 units.**

Obstacles to eventual total system compatibility are largely political, rather than technical, says Comsat General president John Johnson, and relate to such issues as rates, billing systems, and on-shore arrangements for satellite signal distribution. Nevertheless, other Comsat General sources note that the expense of replacing Marots ground stations that operate at 11-14 gigahertz with others designed to handle the 4-6-GHz signal of Marisat may prove **an obstacle for the Europeans.**

. . . and U.S.-Europe digital-data satellite service begins soon

Comsat General Corp.'s **Digital Data Satellite Service will start operation between the United States and England in January 1975** if the company meets the target date it set upon receiving tariff approval for the Intelsat IV service from the Federal Communications Commission late in December. Negotiations are under way to set up firm European pricing structures for the 2.4-, 4.8-, and 9.6-kilobit-per-second services, and **customers are expected to include both the British post office and carriers in Italy, Spain, France, and Germany.** The international 50-kb/s service also offered by Comsat has attracted no big users except NASA. Comsat plans to introduce a lower-cost packet-switched DDSS.

Antiskid controls for trucks, buses to be postponed?

The National Highway Traffic Safety Administration seems to be re-considering its rule requiring antiskid controls on trucks and buses. Though the \$100 electronic packages were initially required for March 1, the agency has "requested comments on the postponement or cancellation" of the program—which is what the American Trucking Association and the air-brake manufacturers have been lobbying for, on the grounds that drivers fear electronic systems [*Electronics*, July 11, p. 74]. **But the NHTSA says merely that the "magnitude of the costs" of the system may be questionable** in the current economic slump.

The Pentagon's changing priorities

Defense Secretary James R. Schlesinger may be the "hawk-and-a-half" that many of his Pentagon colleagues believe him to be, but he is also a realist. Thus he has made a number of hard choices to cancel or curtail several weapons programs in the fiscal 1976 budget that goes to Congress in late January. "He had no choice," explains one of DOD's budget staff, "so he made the best of it. He made the cuts based on his view of the priorities before someone else made them for him."

Schlesinger's choices can still be altered by the President, of course, just as they are likely to be changed by Congress somewhat later in the legislative process. Nevertheless, his priorities are the subject of much discussion in the year-end memos that are moving to the corporate headquarters of military electronics and aerospace suppliers from their men in Washington.

The Navy's good news

There is good news, for example, for General Dynamics Corp. and Northrop Corp., whose YF-16 and YF-17 lightweight fighters are engaged in an Air Force competition. Schlesinger has approved more money for the Navy next year to speed up its choice of one of the planes for use, with modification, as its new carrier-borne air combat fighter. Some DOD sources believe that, since the military is favorably impressed with both aircraft and would like to have both in its inventory, the Navy will opt for the losing plane in the USAF competition—now widely expected to be General Dynamics Corp.'s YF-16.

Whichever way the Navy goes, Schlesinger's effort to hold down weapons system costs in years ahead is bad news for Grumman Aerospace Corp. and its costly F-14 Tomcat. The Navy's fiscal 1976 budget request for the Grumman interceptor will be cut by 14 planes to 36 and held to that level for three years. After that, F-14 buys will be scaled down to 24 a year for two years before the orders stop. "Of course, it could be worse for Grumman," observes a defense budget source. "There are a lot of people in Congress that would like to scuttle that program altogether. And Schlesinger knows that."

Another bit of bad news for Navy aviation advocates should turn out to be good news for Harpoon missile prime contractor McDonnell Douglas Corp. and its key subcontractor, Texas Instruments. Schlesinger's decision to cut costs by turning over part of the Navy's ocean sur-

veillance and control mission to the Air Force will result in that service equipping its B-52 bombers with Harpoon anti-shiping missiles. Money for that is in the new budget and likely to be approved.

Ship and missile cuts

The Navy's seagoing sailors seem unlikely to fare much better as a result of Schlesinger's priorities. In another economy move, sure to appeal to congressional budget watchdogs, the Defense Secretary is cancelling last year's proposed missile-launching submarine follow-on to the new Trident, itself a follow-on to the existing 41-boat Polaris/Poseidon fleet. Known as the SSBN-X, the new boat was first proposed in last year's budget but got nowhere in Congress. With that appropriation scratched, Schlesinger decided not to resubmit it, but to go back to Congress next year with a substitute proposal for a five-year submarine subsystem technology program to identify and perform needed R&D for future underwater weapons.

Topping that action, Schlesinger has also called for the Navy to berth two of its fleet of 15 aircraft carriers next year and another in fiscal 1977. "I think those were excellent choices," says one budget specialist of the submarine and carrier decisions. "The SSBN-X was only a paper effort anyway, so nothing was really lost—and we do have to factor in the realities of the impact of contractor layoffs, especially in this economy. As for the carriers, they will both be old ships just about ready for retirement."

Changing missions

To effect other economies, Schlesinger is considering other possible combinations and transfers of traditional missions between services like that of the Harpoon and the Air Force B-52. For example, the Trident II missile with its proposed 6,000-mile range may be taken from the Navy's submarine fleet and given to the Air Force for its land-launched ICBM force. This would leave the Navy with its 4,500-mile Trident I while giving the Air Force a possible substitute for its Missile-X follow-on for its Minuteman force.

Such proposals are regarded as wreaking havoc in the U. S. defense posture by some military professionals, but their numbers are few. To defense contractors and the members of Congress who are aware of them, Schlesinger's decisions were well made and should allow the services to make the most of the money that will be available to them. —Ray Connolly

We're not going to make extravagant claims for our 38 new circuit modules. Their performance will prove their value. We're simply going to show them to you. Tell you that they include 3 new multiplying DAC's, 2 new buffered integrating ADC's, a new QZ DAC and ADC, 3 new sample/hold amplifiers, a new fast settling op amp, 8 new V/F-F/V converters, 4 new multiplier/dividers, 4 new log modules, 2 new power supplies, 2 new ultra fast current DAC's, 4 new very high speed ADC's and 3 new multiplexers (2 are monolithic chip). They're all available now for immediate delivery. The price is good in singles, great in 100's. If you want more information fast, drop the coupon in the mail today.

We said 38 new circuit modules . . .



Here they are:

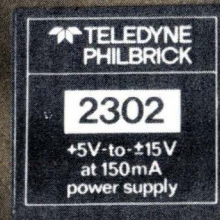

TELEDYNE PHILBRICK **411610**
buffered 8-bit A/D converter

TELEDYNE PHILBRICK **4070**
high speed 8-bit multiplying D/A converter

TELEDYNE PHILBRICK **411710**
buffered 2.5 digit bcd A/D converter

TELEDYNE PHILBRICK **4071**
high speed 10-bit multiplying D/A converter

TELEDYNE PHILBRICK **4131**
A/D converter

TELEDYNE PHILBRICK **4133**
2.5 μ s., 12-bit A/D converter

TELEDYNE PHILBRICK **4039QZ**
12-bit D/A converter

TELEDYNE PHILBRICK **4366**
log ratio module

TELEDYNE PHILBRICK **4072**
high speed 12-bit multiplying D/A converter

TELEDYNE PHILBRICK **4130**
750 ns. 8-bit A/D converter

TELEDYNE PHILBRICK **4367**
log ratio module

TELEDYNE PHILBRICK **4132**
3.5 μ s. 12-bit A/D converter

TELEDYNE PHILBRICK **4855**
ultra-high speed sample-hold

TELEDYNE PHILBRICK **4854**
sample-hold



TELEDYNE PHILBRICK COUPON 12-26-74

If you would like complete information on any or all of the 38 new circuit modules from Teledyne Philbrick, circle the number below. You'll get what you're asking for, fast.

1430 2301 2302 4039QZ 4060 4061 4070 4071 4072 411610
411710 4129QZ 4130 4131 4132 4133 4362 4363 4366 4367
4454 4455 4456 4457 4550 4551 4552 4706 4707 4708 4710
4711 4713 4714 4721 4854 4855 4856

Name _____ Title _____
Company _____
Address _____
City _____ State _____ Zip _____

Telephone (617) 329-1600. Or write, Dedham, Mass. 02026.
In Europe, Tel.673.99.88, Telex: 25881. Or write, 181 Chaussee De La Hulpe, 1170 Brussels.

Circle 43 on reader service card

SIEMENS

Cost-Effective Solutions to Semiconductor Test Problems

APPLICATION:

Verification of semiconductor memory performance from device to system level.

WHAT TO LOOK FOR IN A TESTER:

High speed microprocessor.
Independent X & Y addressing.
Off-the-shelf device interface.

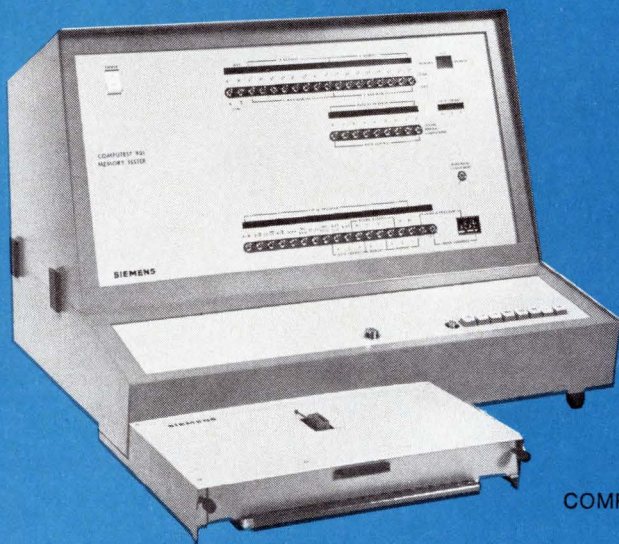

COMPUTEST MODEL 901

Semiconductor testing demands a practical low-cost solution. To check performance of semiconductor memory from the device through the system level requires memory-oriented addressing capability, a stable clock system, performance compatible device interface and real-time error detection. It's all found in the Computest Model 901 bench top memory tester.

The Computest 901 has an easy-to-use, 10 MHz microprocessor, independent X & Y address generator, and a flexible, multi-channel clock. A complete inventory of RAM/ROM interface modules puts the 901 to work for you immediately.

The Computest 901—flexible, versatile, tailored in price and performance for semiconductor memory testing from device to system level.

FREE!

Send for the Computest catalog of Semiconductor Test Equipment and our Semiconductor Program Library



NAME _____
COMPANY _____
ADDRESS _____
CITY _____
STATE _____ ZIP _____

**For applications assistance, contact:
John Lalley, (609) 424-2400**

**Siemens Corporation
Electronic Systems Division
Computest Products**

3 Computer Drive, Cherry Hill, N.J. 08002 (609) 424-2400

Hitachi brightens color-television picture tubes with mask-focusing

Mask-focusing has doubled the brightness and contrast, as well as reduced the power needed for deflection in a new color-television picture tube developed by the Electron Tube division of Hitachi Ltd. The first tubes are expected on the market early next year.

The key to success of the mask-focusing picture tube is to operate the shadow mask at low potential to form an electron lens at each of the apertures. The lens effect allows the apertures to be enlarged because electrons passing through each enlarged aperture are focused on the smaller phosphor dots.

Hitachi engineers overcame three major obstacles that have prevented development of these tubes in the past, although the principle has been known since the earliest days of the color tube. They used a black-matrix screen to reduce the degradation of contrast and color saturation from the secondary electrons that conventional tubes emit from the shadow masks. The metal shield inside the new tube's funnel operates at about 800 volts above the shadow mask's potential to collect many of the secondary electrons.

The engineers used a segmented discontinuous multiple lens Hitachi had earlier developed to optically correct the phosphor-dot pattern to match the landing pattern of the electron beams inside the tube's faceplate. Finally, they used a multifocusing gun with two unipotential main lenses that can operate at low voltage to obtain small spot size. Each of these lenses is weaker than the single main lens that would normally be used.

Electron guns in a delta configura-

tion are enclosed in a neck 36.5 millimeters wide to ensure good focus through use of guns having the largest practical diameter. Shadow masks in prototype tubes, because of the focusing effect on electrons headed for the aperture edges, have an electron trans-

parency exceeding 50%. Lower voltage and deflection power reduce heating of masks by electron bombardment to about 25% that of conventional tubes. Heating and consequent expansion of the mask are reduced, and it is unnecessary to compensate for heat distortion. □

Around the world

Parallel operation speeds up I²L microprocessor

The search for a standard device has led to a microprocessor based on integrated injection logic that attains high speeds through parallel operation. The P-8, built by RTC-La Radiotechnique Compelec, for Electronique Marcel Dassault (EMD), is now a custom chip that will be used in the next generation of EMD microcomputers. But the P-8, so called because it processes 8-bit words in parallel, is being considered as an eventual standard catalog item. And it meets military temperature specifications.

Because of parallel processing, logic operations take 900 nanoseconds at most, and arithmetic operations on 8-bit words last no longer than 1.2 microseconds. Maximum power consumption is a thrifty 400 milliwatts. A logic block performs 11 operations such as intersection, exclusion, and jumps. There's an arithmetic unit plus a block for forward-carry operations. These three main working blocks are linked to input and output registers through a pair of multiplexers and an 8-bit eight-channel shift register.

Three other main blocks handle control, tests, and three-state outputs. The output logic circuits interface the internal I²L circuitry to TTL. The P-8, which contains the equivalent of 520 gates plus I/O interfaces, has an area of 15 square millimeters and is mounted in a 40-pin ceramic package.

Siemens drives for MOS leadership in Europe

In a drive to become the top MOS manufacturer in Europe, West Germany's Siemens AG is relying on the latest available technology. The company is consolidating all its production in an \$8 million facility containing 10,000 square feet for initial production of \$40 million worth of devices a year.

To produce high-performance logic and memory chips, the company has developed the ESFI (epitaxial silicon film on insulator) process, which requires few production steps. For particularly small memory structures, Siemens will soon use an n-channel silicon-gate process. The company, which has already developed nearly 200 MOS circuits, has been relying primarily on p-channel metal-gate technology with ion-implantation to reduce circuit operating voltages and depletion-load techniques for devices with low and widely varying voltages, as well as low power dissipation.

The new center, built around six diffusion ovens and three ion-implantation systems has achieved ultrahigh purity of water and air. Erich Gelder, IC product manager, predicts that the MOS market, now more than \$800 million a year, will climb at a dazzling 30% annually.

Announcing the age of the P-ROM...
 The amazing little chip that gives you
The Sharp Edge.



What on earth is the P-ROM? It's a unique little educated chip programmed to do up to 256 steps for you — automatically! An out of this world concept? Not any more.

Introducing the Sharp PC-1002 — the 15 scientific function calculator, another "first" from Sharp, the Qualitronics Company. (We gave America its very first electronic calculator back in 1964!)

Most keys on the PC-1002 are dual function. But the real key to the Sharp PC-1002 is which P-ROM you choose when you buy it. There are many different interchangeable

P-ROM's available, such as for statistics, surveying, mathematics and the easiest metric conversion you could imagine.

In fact, you and the Sharp PC-1002 can handle problems like inverse trigonometric, hyperbolic trigonometric, exponential, logarithmic, factorial and azimuth calculations, polar to rectangular coordinates, and degrees, minutes, and seconds to decimal equivalents. We gave our PC-1002 a 10-digit mantissa and a 2-digit exponent.

The display appears in large, green numerals and the case is molded of high-impact material for durability. These human touches make the PC-1002 and most every Sharp calculator easier to operate and as mistake-proof as possible.

Our new PC-1002 marks the age of the P-ROM — it can put you a step ahead of the next person. Another example of the extra measure of quality, performance and innovation that gives you "The Sharp Edge."

To find your nearest Sharp dealer, call toll-free (800) 447-4700. In Illinois, (800) 322-4400.

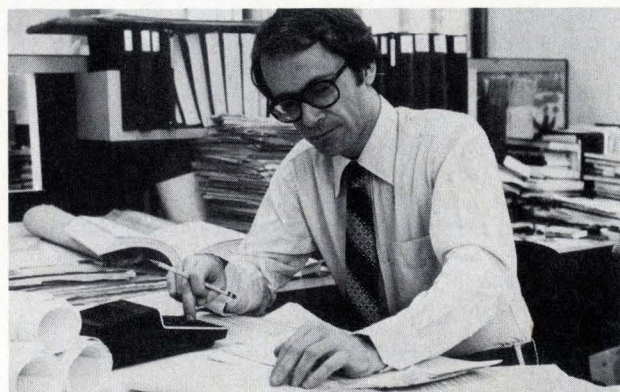

SHARP® Electronics, Dept. EL-74-02
 10 Keystone Place, Paramus, New Jersey 07652

Please send me information on: PC-1002
 Full line of Sharp Calculators.

Name _____

Occupation _____

Street _____

City _____ Tel. _____

State _____ Zip _____



The Qualitronics Company.

Japan's EIA sees electronics growth of 19.9% a year

Production of industrial and professional electronic equipment in Japan in fiscal 1978 will be worth \$6.3 billion. This is 2.47 times the figure for fiscal 1973 and will represent an average growth of 19.9% a year, predicts the Electronic Industries Association of Japan. **Leading in production and growth rates will be computers and associated equipment.** Production will be \$4.46 billion, which is 2.7 times the 1973 level and represents an average growth of 22% a year.

A sector that includes test and measuring instruments, as well as process controls, is forecast to reach a total of \$583 million which is a five-year increase of 2.37 times, a growth rate of 18.8% a year. Non-communications wireless equipment, which includes radar and other navigation and meteorological equipment, will total \$346 million, an increase of 2.13 times and a rate of 16.3% a year. **A miscellaneous industrial category that includes ultrasonic equipment and industrial television will total \$177 million, doubling in five years, at an annual rate of 14.8% a year.** The lowest growth rate will be registered by communications equipment. Fixed and mobile gear will reach \$649 million, an increase of 1.92 times and a growth rate of 13.9% a year. Television and radio-broadcast transmitters will reach \$85 million, an increase of 1.34 times and a growth rate of 6% a year.

Post Office ups phone-exchange request in UK

Suppliers of telephone-exchange equipment may get a New Year treat if the government approves the British Post Office budget. It calls for acquisition of semielectronic TXE4 telephone exchanges to be boosted by 20% to \$550 million by 1980. **Standard Telephone and Cables already has a head start in building the first 20 units, and the ITT subsidiary has contracted to build a prototype at reduced cost.**

Although GEC and Plessey will have a crack at later orders, all three will have to share the total main-exchange market with a newcomer, Pye TMC, a Philips subsidiary. **The three traditional suppliers are expected to approve BPO intentions that Pye later become a fourth main-exchange supplier for a market estimated at \$380 million a year.**

French develop exotic instruments for detection

Watch for some out-front detection instruments to hit the market in France in the next year or so. Initial versions of a Josephson-effect magnetometer and a cadmium-telluride gamma-ray detector, for example, turned up at the year-end 65th Physics Exposition in Paris. **The magnetometer, developed at a laboratory of the nuclear energy agency, Commissariat à l'Énergie Atomique (CEA), can pick up fields as feeble as 10^{-14} gauss,** about one thousandth the earth's magnetic field. The Josephson junction in the instrument is fabricated from a layer of niobium evaporated onto a quartz rod 2 millimeters in diameter; it operates at a temperature of 4.2K. Field strengths are determined by measuring impedance changes in the detector with a special LC circuit.

The CdTe gamma-ray detector, by contrast, works at room temperature instead of the usual liquid-nitrogen temperatures needed for silicon or germanium detectors. It's the work of Laboratoires d'Electronique et de Physique Appliquée of the Philips group. LEP developed a solvent-zone crystal-pulling technique to get CdTe monocrystals pure enough

International newsletter

for the detector. **The detector proper is paired with a preamplifier only 10 millimeters in diameter in a pen-size probe.**

Two new minis aid Panafacom's drive for 40% of market

Two 8-bit minicomputers have been introduced by Panafacom Ltd. in its latest effort to capture 40% of the Japanese minicomputer market. This would entail building 5,000 of the new machines in the next four years. Panafacom is the joint venture that has taken over the minicomputer-manufacturing operations of Fujitsu Ltd. and Matsushita Communication Industrial Co. **The Panafacom U-300 and U-400, which are equivalent to the Digital Equipment Corp. PDP-11/35 and PDP-11/45, are larger models of the U-200 introduced earlier, of which 700 have been sold.**

Both new models are available with either semiconductor or core memory, and both have submicrosecond cycle times. They have 12 interrupt levels. Instruction length is 16 bits. **The U-300 has a memory capacity of 64,000 8-bit bytes, and the U-400 has a capacity of 256,000 8-bit bytes.** Delivery of the U-300 is to begin in June and the U-400 in October. The line is expected to be extended to both smaller and larger systems for hierarchy and networking applications.

German group wins bid for drone target-locator

A contract for an experimental unmanned military reconnaissance aircraft has been awarded to a consortium of West German companies headed by VFW-Fokker, Bremen. **The drone will be used by the West German Defense Ministry in the second phase of the remotely piloted vehicle program to test the use of video sensors for target-acquisition and identification.** For the first phase, a manned aircraft will transmit data to a mobile command station containing monitors and receivers.

EMI's CRT console shows brain X-rays

A \$40,000 mobile diagnostic console from Britain's EMI Ltd. shows computer-enhanced X-rays of the brain remote from the X-ray scanner. Introduced this month in Chicago at an exhibition of the Radiological Society of North America, the console extends the capabilities of EMI's two-year-old \$350,000 scanner. **The new scanner is a computerized axial tomography system that takes thousands of X-ray readings of layers of the brain.** But instead of film, sensitive crystal detectors record variations in light intensities as they rotate around a patient's head. **The console's 12-inch cathode-ray tube displays computer-correlated pictures of the brain tissue.**

Two Norwegian firms win foreign electronics pacts

Two Norwegian electronics firms have made breakthroughs in international competition. Bidding against manufacturers in the U.S., UK, and West Germany, A/S Nera **has received orders totaling about \$300,000 for a Norwegian-developed instrument-landing system, to be installed in Athens, Greece, and Vaexjoe, Sweden.**

Norsk Dataelektronikk has won its first non-European order with a contract for almost \$3 million for a World Meteorological Organization (WMO) communications center to be located in Algeria. **Equipment includes Norsk computers and peripherals, plus other electronic equipment for processing meteorological data.** The WMO center will provide weather information mainly to North and West African nations.

Distributors Wanted.

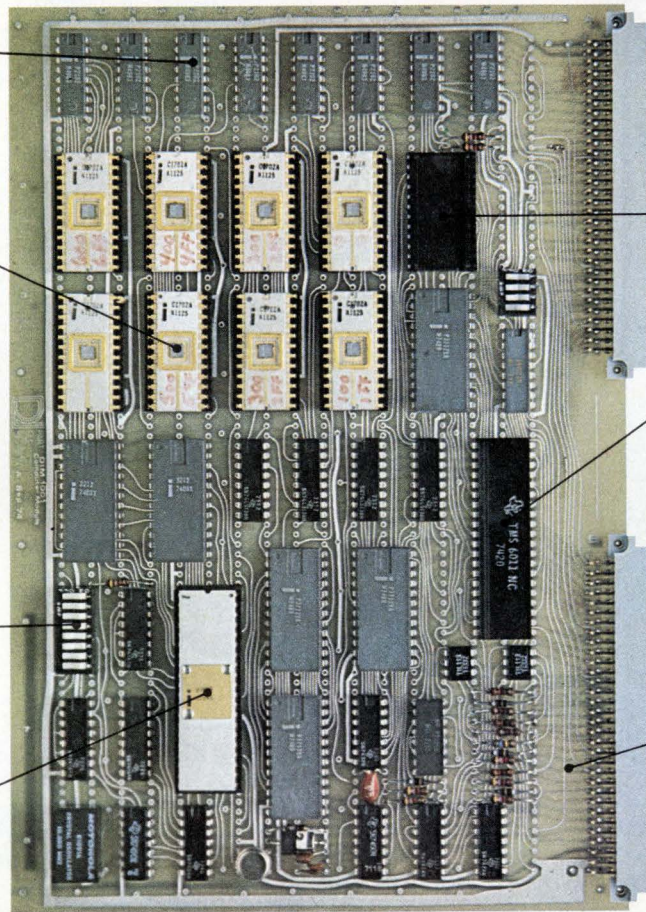

HOLTER YGR

We've developed a micro-computer that's ahead of its time, and we're looking for seriously interested distributors to help us sell it.

The MYCRO-1 is a truly complete computer on a single printed circuit board. Simply connect a teletype or display and a power supply and the computer is ready to work.

For more memory add on a

4K byte RAM or erasable PROM modules, any mix up to 64K. On the connectors the MYCRO-1 has a 16-bit address bus, an eight-bit bidirectional data bus and all the necessary signals for memory read/write, input/output control, eight interrupt control lines and DMA control.

All TTL-compatible and buffered for output drive and low input load.

Power supply and cabinet? The MYCRO-1 can either be

plugged into the purchaser's own system or we can supply a small complete box.

And price? Very competitive.

If you're interested in new developments in micro-computers, we think you'll be interested in the MYCRO-1 and associated modules. For further information write to Data Industri, Pilestredet 75C, P.O. Box 7175H Oslo 3, Norway.

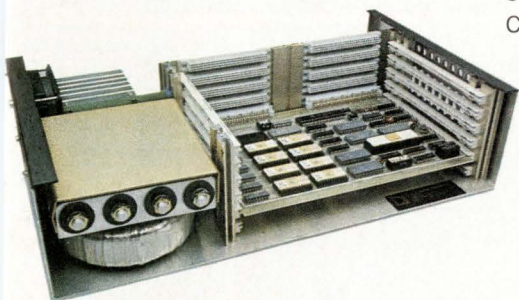

DATA INDUSTRI
A member of Norway's largest electronics group, Elektro Union.

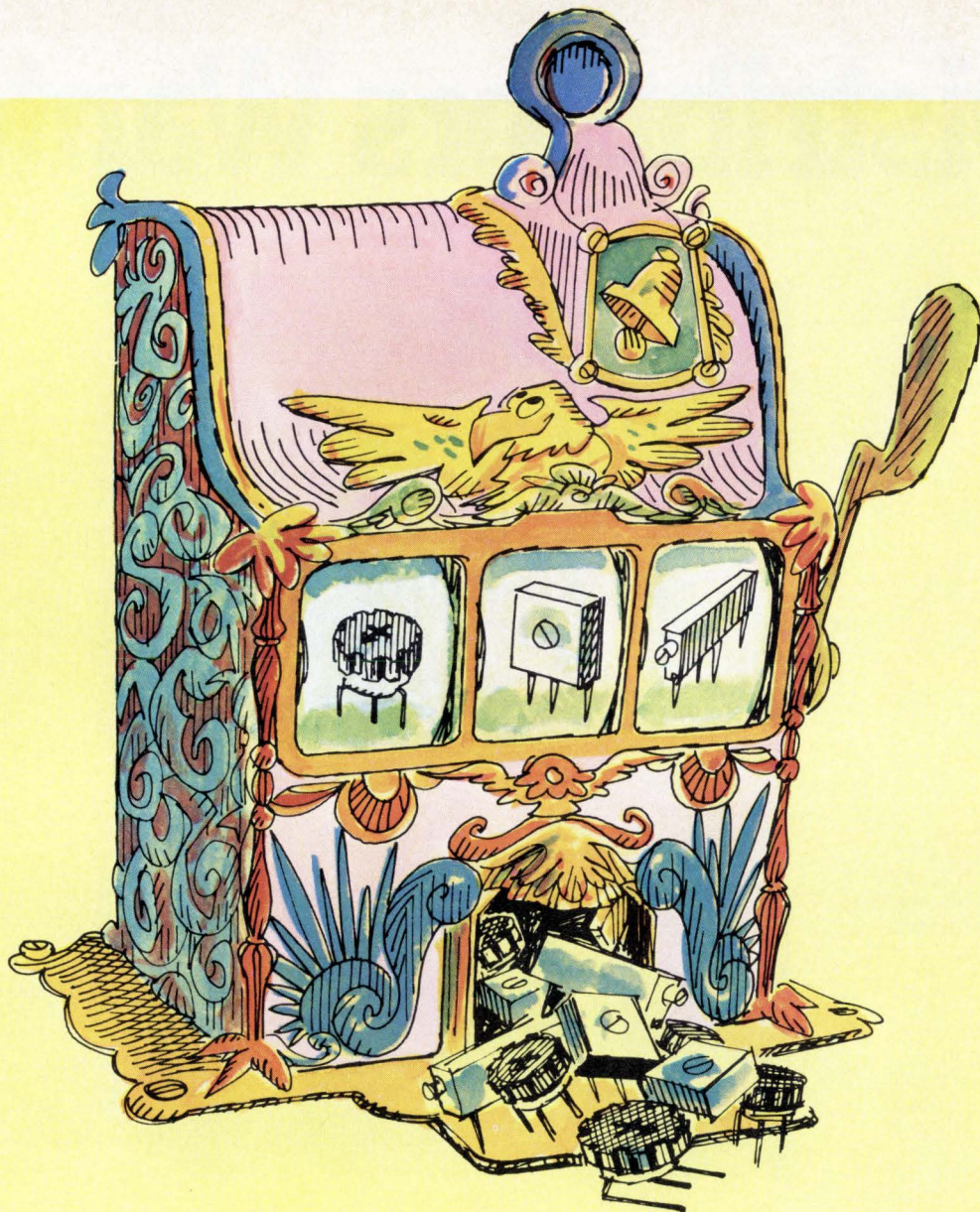

Take the gamble out of trimmer buying.

Three of the winners in our extensive cermet trimmer line can give you a sure jackpot, because, right now, they satisfy over 90% of all trimmer requirements and board layouts.

Pick the 3/8" square, single-turn, sealed Model 72. Or the 3/4" rectangular, multiturn, sealed Model 89. Or the 3/8" diameter, covered, single-turn Model 91. Each in 19 standard resistance values from 10 ohms to 2 megohms...and in a variety of pin spacings.

Prices are right, too. Models 72, 89, and 91 are respectively just \$0.58, \$1.13, and \$0.45 in the 500-piece quantity.

And after all that, if exceptional setability

and 100 ppm°C tempco isn't enough, think of this: They're all available for immediate delivery from stock at your local Beckman/Helipot distributor!

Considering the stakes in your own competitive field, you should look into the quality and performance of Beckman cermet trimmers.

If you need immediate technical literature or the phone number of your local Beckman/Helipot representative, call toll-free (800) 437-4677.

Beckman®
HELIPOT DIVISION

Probing the news

Analysis of technology and business developments



Working space. New building at Bell Labs in Murray Hill, N.J.

Does Bell Labs live up to reputation?

Basic research is outstanding, says study for FCC, but slowness is found in responding to needs of operating companies

by Ray Connolly, Washington bureau manager

By almost any measure, the position of Bell Laboratories is No. 1 in the world telecommunications community. Funded jointly by its parents, the American Telephone & Telegraph Co. and AT&T's manufacturing arm, Western Electric Co., Bell Labs operates on an annual budget in excess of \$500 million. That bankroll pays the salaries of more than 16,000 persons who annually publish about 2,300 papers, and, more important, collect an estimated 700 patents a year—more than any other organization in the world. That is part of the image that Bell Labs and its corporate owners like it to have, an image that's tarnished in several spots.

"The basic research effort at Bell Laboratories is outstanding," says New York consultant Touche, Ross & Co. in a contract study that is part of the Federal Communications Commission investigation of the interrelationships between Western Electric and the rest of the Bell system. Yet that is not all that Touche, Ross concludes about Bell Labs in its 132-page analysis and nine separate appendixes of supporting documentation [*Electronics*, Dec. 12, p. 53]. The study is made even more timely by the Federal antitrust suit against AT&T.

Despite its mom-and-apple-pie image in basic telecommunications research, Bell Labs is found wanting

in terms of translating its achievements into applications that will improve the U.S. telephone system. "There is a relative lack of follow-up, once a field has been established," reports Touche, Ross. Bell Labs is "slow in coming out with improved products, with design changes, and with adoptions of new technology in established areas."

What's more, the study finds Bell Labs to be unresponsive to the needs of the operating telephone companies and their customers. While Touche, Ross attributes this in large part to the lack of any formal mechanism for interaction between the operating companies and Bell Labs, it notes that the labora-

Probing the news

tories have been working to overcome the problem "in part due to pressures from the operating companies themselves and in part due to operating companies purchasing from non-Bell sources."

Disagreeing, a Bell Labs official says the study apparently overlooks many engineering improvements in alleging a lack of follow-up. He cites more than 200 improvements in the basic phone set, and more than 6,000 changes in the No. 5 crossbar switch. Pointing to product follow-up, he mentions the expansion in capacity of the TD2 microwave radio system to 16,500 simultaneous calls from 2,400.

As for the charge of a lack of responsiveness to operating companies' needs, the Bell official says there have been constant developments, ranging from small (an improved drop wire) to large (electronic switching and long-haul coaxial cable systems).

Bigness. The huge size of Bell Labs has advantages, as well as limitations, in the view of Touche, Ross, but most of the advantages relate to the peculiar needs of AT&T and the Bell System. "No other telephone company in the world requires the size of central-office

The boss. W.O. Baker, president of Bell Labs. Study says his lab gets high marks in research, but lags in some other areas.



equipment which is needed to service large metropolitan areas in the U.S.," the study notes, adding that with its enormous resources, "Bell Labs has demonstrated a unique capability to develop large-scale systems" such as the No. 5 crossbar, the No. 1 electronic switching system, and the traffic-service-position system for distributing calls among operators on the basis of service load.

Disadvantages of Bell Labs' "somewhat ponderous" size and resultant dispersion of effort are the "internal communications difficulties, while some overlap in job functions and project cases" has resulted.

Moreover, the laboratories suffer, says Touche, Ross, from "a hesitancy to utilize technology which was not invented by BTL.

Not all of Bell Labs' problems are of its own creation, however. Indeed, much of the evidence from Touche, Ross and elsewhere indicates that some significant criticisms of the labs have their origin within Western Electric.

For example, the criticism that the laboratories are unresponsive to telephone customers' needs is laid by Touche, Ross to a "poor marketing structure and is evidenced in increased consumer purchasing" from non-Bell companies. By creating a marketing organization, however, AT&T and its affiliates are responding to this competitive challenge.

Responsibility. Whose fault is it that Bell Labs is slow to develop new products for applications other than switching? At first glance, the responsibility would appear to be Western Electric's, since AT&T pays for "basic research and system-engineering studies," while "Western Electric is billed for applied research" and pays "on a case-by-case basis for product development."

Indeed, if money talks as loudly at Bell Labs as it does in the R&D operations of other companies, Western Electric should clearly have more clout than AT&T in directing the laboratories' efforts. In 1974, Western Electric picked up the tab for an estimated \$283 million. By comparison, AT&T's share was \$198.4 million. Nevertheless, Bell Labs' record of the distribution of those funds indicates that just about

all of Western Electric's money went for R&D that was about equally divided among three areas—systems for switching, transmission, and electronics technology.

Yet the Touche, Ross analysis of Western Electric's role in AT&T's product-development cycle shows the manufacturing company has little actual responsibility in the decision-making process. The decision of whether or not a new product is needed rests with AT&T and the operating company that raises the question. In contrast, AT&T and the laboratories determine whether a commercial product is available or whether Bell Labs' exploratory development is needed. Western Electric becomes involved only in deciding whether or not a specific Bell Labs effort should be undertaken, and then it participates only as a member of a tri-company council. "Indications are," says the report, "that Western Electric's involvement in these decisions is of a supplementary and advisory nature."

Conclusions. Nevertheless, the consultants report to the FCC that "Western Electric's efficient performance has resulted in lower costs than otherwise would have been incurred. Because of Western's pricing policies and practices," the Touche, Ross study goes on, "these lower costs have not increased profits, but have been passed on to operating companies [as] lower prices."

That encomium troubles a number of FCC staffers, however, particularly when it is coupled with the consultant's later conflicting observations that "the unique relationship Western Electric enjoys as the manufacturing arm of the Bell System makes performance comparisons with other companies impossible."

Some FCC staffers are highly critical of what they call the "waffling" of Touche, Ross & Co. on such issues as costs and pricing by Western Electric. Yet they are convinced that, in view of the specific criticisms raised about the operations of Bell Laboratories, the need for increased competition in American telecommunications is genuine, since it has provided one of Bell Labs' biggest incentives to develop new equipment. □



We feel a little flag-waving is called for

After all, it's not every day a Spanish company opens a manufacturing plant in the USA. Especially in the highly competitive world of electronics.

But that's just what we've done. Bearded the electronic giants in their own dens.

Our new American den is in Boston. Right now we're manufacturing carbon film resistors – with other component lines to follow – on our own specially designed machines, drawing on the identical advanced technology and production techniques that have taken us to the top in Europe.

And we know this little bit of flag-waving will catch the eye of our European customers. They'll appreciate how the extra production from our US plant will ease their own deliveries in Europe. We will no longer have to divert so much of our European capacity across the

Atlantic. So everybody benefits.

To our American friends we say, "Happy to be in the USA". We know *all* our customers are going to be happy we are.

Find out more about Piher. A leader in component technology.

PIHER International Corp., (Sales Office)
1239 Rand Road, Des Plaines, Illinois 60016.
Tel: 312-297 1560 Telex: 282514

PIHER Corp., (Manufacturing Plant)
399 Washington Street, Woburn, Mass. 01801
Tel: 617-935 8750 Telex: 94-9382



Circle 53 on reader service card

The first name in counters is not the counter you name first.

We aren't as well known for our counters as we are for our digital multimeters. But we should be. Because we make some of the best counters available for the money.

The nine models in our 8000B/8100 series feature measurements such as frequency, period, multiple period, time interval, time interval average and totalize modes.

A standard 8-digit display provides high resolution measurements. Models feature 10 nanosecond resolution for single shot time events along with 150 picosecond resolution for repetitive events.

ATE. For more accurate waveform parameter testing, the counters feature digitally programmed trigger-level resolution of .05 volts and trigger-level hysteresis compensation.

Communications. For low-level, high-frequency measurements, sensitivity as high as one millivolt at 500 MC is featured. Counters also employ a 150 MC direct count capability.

Yet prices start at \$1,390.

So before you talk to the biggest name in counters, talk to the best. Contact your Dana sales representative by calling toll-free 800-645-9200. In New York, phone 516-294-0990. In Europe, call 02-241-4550.



DANA®

Others measure by us.

Circle 54 on reader service card

Memories

Josephson tunneling shows promise

IBM's success with experimental memory and logic circuits underlines interest of computer makers in the technology

by Laurence Altman, Solid State Editor

The Josephson-junction effect, that ice-cold technology that operates at 4°K, close to the temperature where molecular structures freeze, continues to be a hot research project at some semiconductor laboratories. The reason: devices built with Josephson junctions could potentially operate thousands of times faster than today's devices, while consuming orders of magnitude less power in configurations that are astonishingly small—hundreds of thousands of elements of memory or logic could be packed on a chip no larger than standard sizes now in production.

That's why International Business Machines Corp. and other major manufacturers of large computers, as well as Government-funded research laboratories, are deeply involved in the technology. Although the Josephson effect has been known for more than a decade, and exploratory devices demonstrating the effect have been around for years, materials technology and fabrication skills have only recently begun to make feasible the building of memory and logic devices such as gates and static shift registers.

True, production-quality Josephson junction devices are still several years away because many basic problems still exist. Nevertheless, IBM has built memory and logic circuits and has even fabricated an experimental 8-bit shift register that shifts at a rate of 160 megahertz. With this device, power dissipation was only 20 microwatts per bit, in contrast to current state-of-the-art shift registers, which burn about 0.5 milliwatt per bit. Also, in papers presented last month at the Inter-

national Electron Devices Meeting, IBM's researchers say that computer simulation shows that the present design, with an improved power configuration, could shift at 360 MHz—about 150 times faster than today's devices.

IBM managed to attain these high data rates even though their early devices were built with relatively large 1-mil line widths. It's estimated that normal 5-micrometer geometries in optimized configurations could increase the speed 10 to 100 times.

How it's built. The simplest way to take advantage of Josephson tunneling—the tunneling of electron pairs through a thin insulating barrier between two superconducting materials—is to realize that a magnetic flux linked with superconducting loops can be trapped, thus setting up a persistent circulating current in the loop (see illustration). With this simple arrangement, the direction of current flow—clockwise or counter-clockwise—can be

made to represent the required binary information.

To use the principle of flux trapping, a thin-film superconducting loop is built that consists of three Josephson tunneling devices, one for writing, one for reading, and one for controlling the read-write operation. Then a common control line is provided for the writing and control elements, while a word line connects the memory-cell loops in the array's

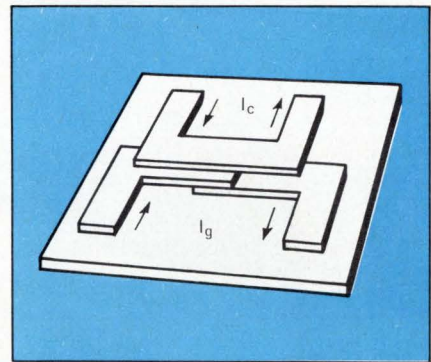

Separation. In this Josephson tunneling device, oxide film separates three elements to produce control and gate currents.

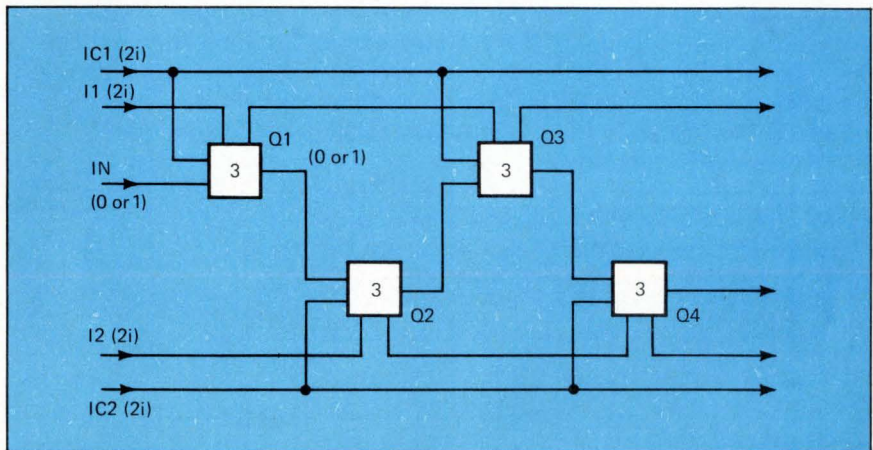

Data transfer. Two three-input gates (operating in master-slave mode from external clocks I_1 and I_2) transfer data from Q_1 to Q_2 and Q_2 to Q_3 by strobe pulses IC_1 and IC_2 .

A year ago we introduced 7 new JCM miniature RF coaxial connectors that "do the job for a fraction of SMA prices."

Here, by popular demand, are 8 more.

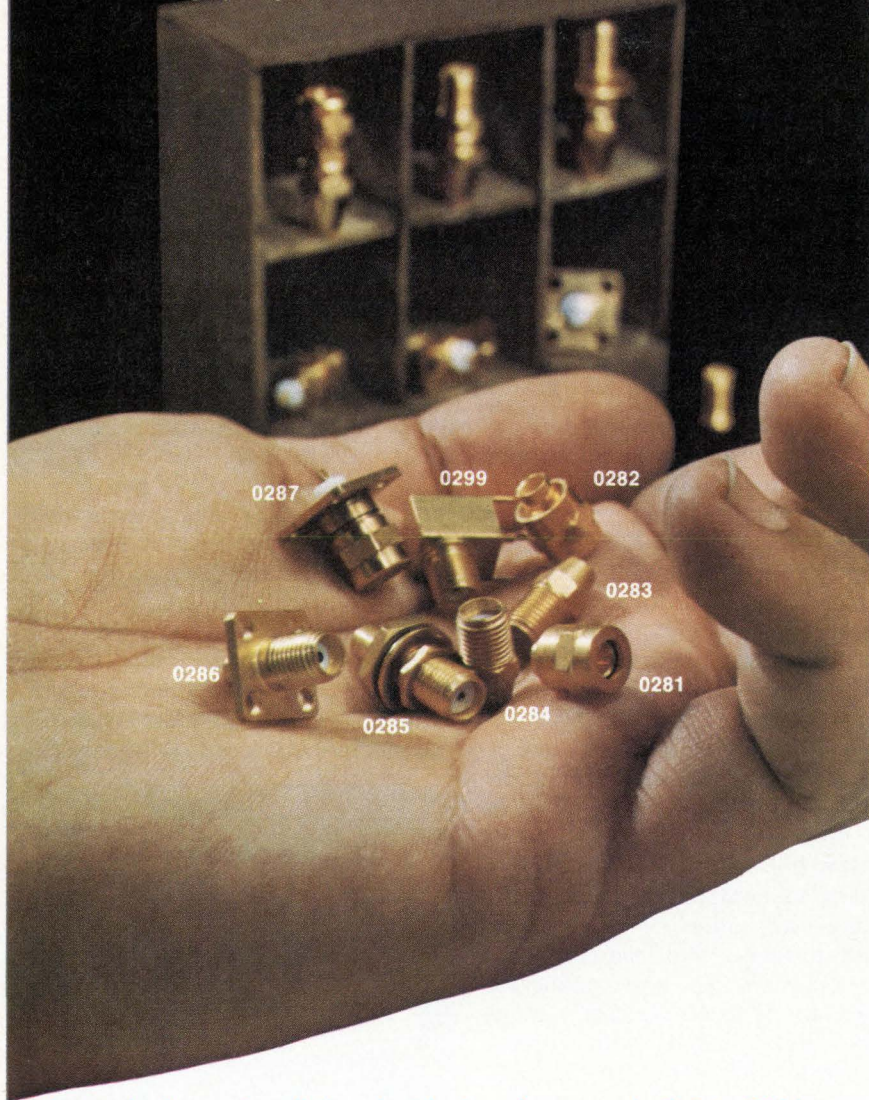

If you don't require all the electrical performance built into SMA type connectors, why pay for it? Up to 3 GHz for flexible cable assembly and even beyond 6 GHz for semi-rigid assembly, our new JCM series gives you the same electrical performance as the far more expensive SMA types. The series includes connectors for both panel and PC mounting. All are interchangeable and intermateable with the standard, expensive SMA connectors. So you can use them without making any changes . . . and without compromising required performance. There are JCM connectors to accept virtually any miniature size cable, so you don't have to stock a big variety. It's worth looking into, isn't it? All it costs is a stamp.

E. F. JOHNSON COMPANY / Waseca, Minnesota 56093
Please check for technical information or test samples of our new low-cost series 142-0200-001 JCM connectors.

- Please send technical information.
- I desire test samples. Please call me at _____

NAME _____

FIRM _____

TITLE _____

ADDRESS _____

CITY _____

STATE _____

ZIP _____



E. F. JOHNSON COMPANY

56 Circle 56 on reader service card

Probing the news

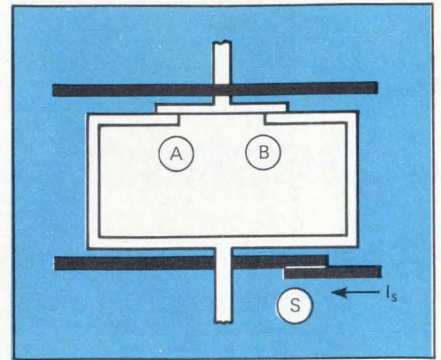

Together. Three Josephson tunneling devices form memory cell. A is for writing, S is nondestructive readout controlled by B.

column and a separate sense line connects the read devices in an array's row.

To form a shift register, IBM cascaded two three-input Josephson gates (Q_1 and Q_2 in the illustration) in series and operated them in a master-slave mode from an external clock. The data is transferred from Q_1 to Q_2 and then to Q_3 in normal shift-register fashion by virtue of two strobe pulses (IC_1 and IC_2). The pulse levels were designed to ensure that a data 1 condition would produce conduction at least three times the value of threshold condition, thus guaranteeing reliable operation.

What's coming. In this way, shift registers 3 to 8 bits long were fabricated with the 1-mil line width. Two levels of superconducting interconnections were used to duplicate standard fabrication techniques. IBM experimenters are encouraged by the operation of these four-phase shift registers.

Yet the question remains: Can these devices and their required passive components be built in an IC form with sufficiently high yield and reliability?

The problem is that the all-important threshold currents depend strongly on the thickness of the oxide tunnel barrier, which must be controlled to a fraction of an angstrom—and this is beyond today's production capabilities. The rf-sputter-and-oxidation technique with which IBM built these barriers is basically a laboratory method, say many observers.

SMART!



Between your finger and our micro-processor, you get a smart data system.

The new Esterline Angus PD2064 Key Programmable Data System uses a microprocessor, memory and a simple keyboard to multiply data acquisition capability and assure extraordinary flexibility.

You program up to 248 channels with one finger. The system gathers analog and digital data, measures the conditioned signal, supplies time base, engineering units, and outputs the data on a self-contained printer—at any scan rate up to 25 channels per second.

Or it will feed a teletypewriter, a magnetic or paper tape recorder, or computer as well.

Key Programmable capabilities include high/low alarm logic, I/O,

formatting functions, and optional features.

Two basic design ideas make this the best value data system around:

1. Versatility based on *proven* RAM, ROM, PROM, and microprocessor circuitry. Key-program the entire system or one channel at a time, and
2. Unprecedented attention to signal guarding and isolation from noise as found in the worst industrial or field environments—200 VDC common mode capability.

For laboratory, field, test cell, process, or facility monitoring at an unlikely low price, check out the PD2064. Any way you finger it, it's a smart new data system. Request Bulletin B110 from Esterline Angus Instrument Corporation, Box 24000, Indianapolis, IN 46224.

- Low level sensing to 1 microvolt resolution, programmable gains, automatic signal source check.
- Handles four types of multiple thermocouples, millivolts, volts, nonlinear functions, current, digital BCD inputs.
- Measurement-immune to noise, uses fully guarded circuits and dual slope integration with one cycle sample period.
- 100-day, 1 sec. resolution clock, battery-saver electronics, self-calibration—ideal for field use.
- Microprocessor memory allows optional special SMART programs such as ratios, rates of change, standard deviation, all math functions, dedicated system programs with keyboard override.



ESTERLINE ANGUS

A UNIT OF ESTERLINE CORPORATION

Circle 57 on reader service card



Commercial

Inside Disney's new world



Space Mountain and Home of the Future are typical of sophisticated use of computers in park

by Gerald Walker, Associate Editor

As they fly on a "space ride," then ride on a moving walkway past a futuristic home, few visitors to Walt Disney World's new Space Mountain attraction, which opens next month, will be able to catch their breath to appreciate the role electronics plays in the entertainment.

But electronics plays two roles at Space Mountain; first, the here and now, manifested by computer control of the ride; and second, the Tomorrowland, presented in the Home of Future Living that follows the ride. Space Mountain marks the culmination of almost 10 years of design and construction involving Disney organizations and RCA Corp. Together with the futuristic people-mover, called WED-Way, and General Electric's Carousel of Progress due later next year, as well as the Star Jets ride, the mountain completes for now the major attractions at the \$500 million-plus Walt Disney World Magic Kingdom.

Statistics for Space Mountain are impressive—it's 183 feet high, contains more than 4.5 million cubic feet, and cost more than the original Disneyland. But the main objective here, as elsewhere in Walt Disney World, is to put on a good show. In

so doing, the designers and builders have come up with an unusual blend of electronic controls and audio-visual effects. Interestingly, those designers are not electronics engineers—they are mostly film people and animators whose interest is in entertaining, not advancing the state of the art. They use a great deal of electronics only because it gives them what they want.

Up the mountain. While three computer systems at Disney World handle functions common to many locations, the Data General Corp. Nova minicomputer assigned to Space Mountain is dedicated.

Its main job is safety and traffic control for the twin indoor roller-coaster rides. Actually, the only thing in common between the Space Mountain ride and the typical outdoor roller coaster is that both run on guideways. Because of the size and layout of the building and the precise timing of car-dispatching by the minicomputer, this attraction will be able to accommodate 3,000 visitors an hour. Essentially, the Nova supports human dispatchers and monitors zones of the ride, keeping the cars evenly spaced.

Just as Space Mountain has been

Space Mountain. A new landmark at Tomorrowland, the Disney World Space Mountain (above) features a computer-controlled thrill ride and a view of an electronic home of the future. Computers at the park also monitor services and security (below).

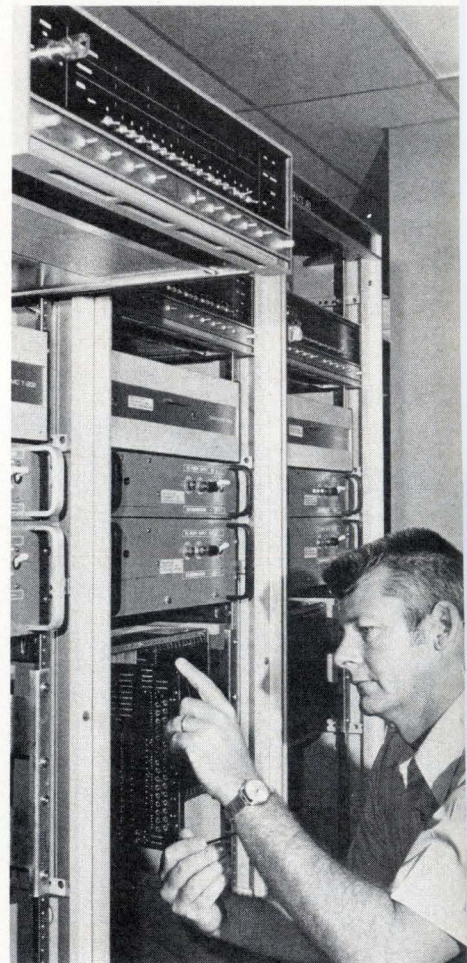

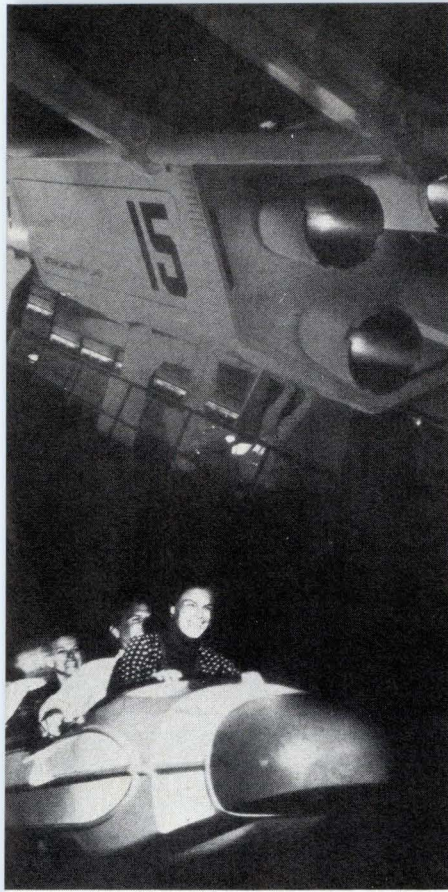

Fun. "Space ride" (left), is elaborate, indoor roller-coaster type trip with many visual effects. In RCA's Home of Future Living, inside Space Mountain, a businessman of the future (above) conducts a meeting by two-way satellite television; his wife (right) shops and monitors activities throughout the house via television.



derived from a previous attraction—the Matterhorn Mountain Bobsled at Disneyland—the next special ride scheduled for Walt Disney World will be a takeoff on the space flight. This is the people-mover being developed by WED Enterprises, Glendale, Calif., the R&D and creative power behind both parks.

Says Harry Mason, manager of audio animatronics (animated figures) and computers for Walt Disney World, "What we've learned about traffic-control dispatching in Space Mountain has made us super-optimistic about making the WED-Way people-mover work. Six months ago, I would not have been as ready to predict success."

The computers. The more sophisticated the show, the more important computer control has been. This is true throughout the 2,500-acre resort area located at Lake Buena Vista, Fla., 20 miles outside Orlando. There are four major nonaccounting computer systems.

The most unusual is the DACS computer, for Digital/Analog Control Systems, that runs totally automated shows involving audio animatronics. An Astrodata Inc. machine (built to Disney specifica-

tions before the computer company went out of the business) programs magnetic disks that "play" each of the many shows at the park.

Audio animatronics got its show-business start in electromechanical form at Disneyland in California. However, Walt Disney World advanced the technique into complete computer control. When the DACS computer is not programming the playing disks, it monitors a certain number of key functions at each of the shows. So, for example, the spotlights trained on each President during a roll call are monitored to make sure none is burned out. This procedure is a backup on the operating personnel who also make periodic checks on performances.

A second computer system, AMCS for Automatic Monitoring and Control Systems, could potentially be applied in other industrial or government enterprises. Designed by RCA, AMCS employs two Data General Nova machines to monitor fire and security alarms, air-conditioning, and refrigerators.

A more standard operation is the Leeds & Northrup Co. computer control of the entire resort's electrical-distribution system. A control

panel of 15 feet by 45 feet instantly indicates the status of power demands and use at the resort.

The RCA Home of Future Living at Space Mountain also fits this pattern of sophistication. Meant to be a rather quick look at communications, entertainment, and computer-aided education in the home, this exhibit is both an amusement for today and a framework for the future. Visitors will see a man conducting a business meeting via satellite in his living room by means of a two-way TV set no larger than an attaché case. Meanwhile, mom takes a pottery course from a video library and displayed on a large screen. Tiny television cameras monitor the entrances and keep an eye on baby.

In another group of settings, a boy does his homework while sitting at a computer console. Another boy practices skiing on a simulator without leaving his room. While a woman shops by video on a screen in the kitchen, two youngsters watch a television program on a wall-size screen in the den. Finally, to show that interests won't change too much, a teenager lounges in her room enjoying a video recording disk and talking on the phone. □

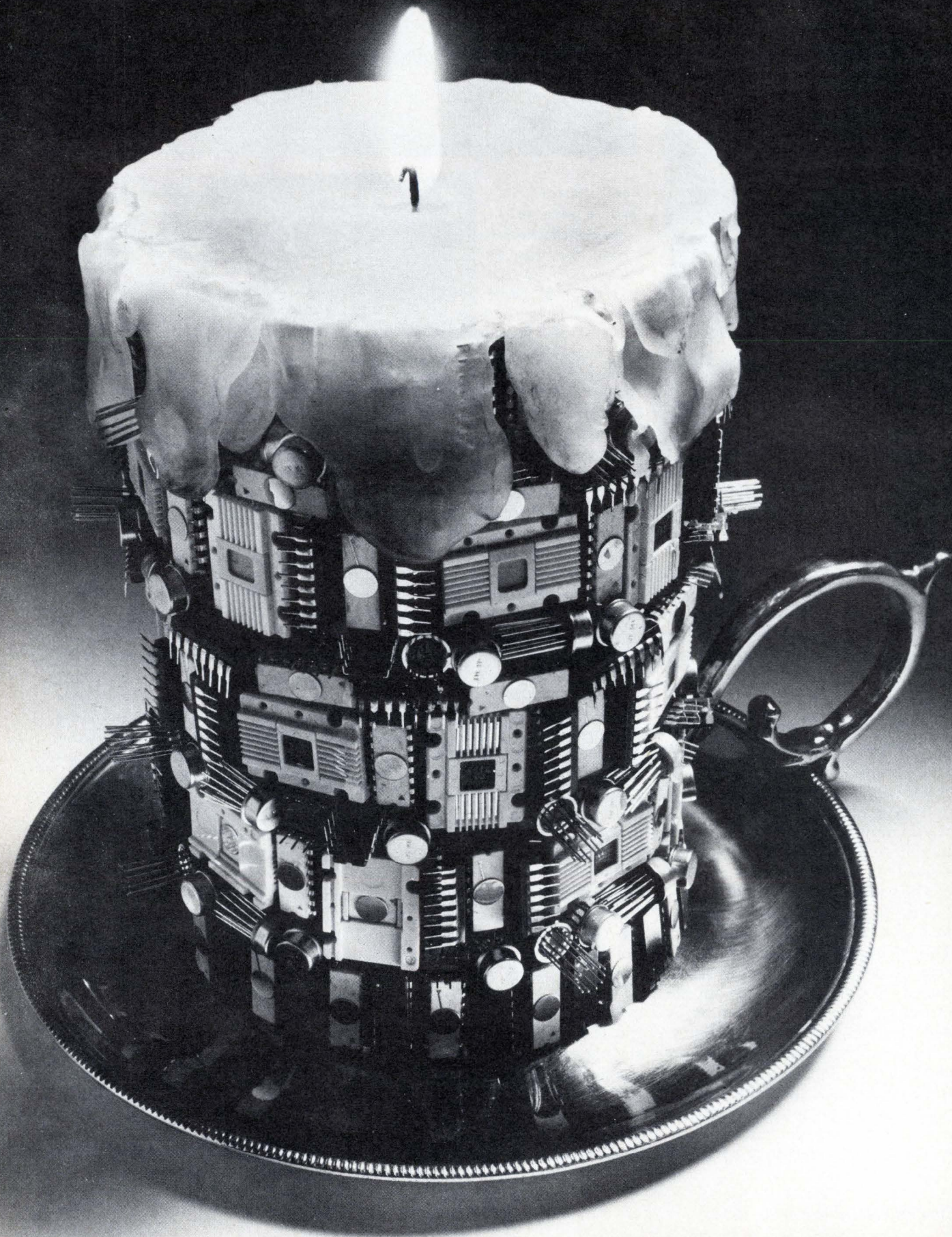

Why RCA can shed a lot of new light on your need for Linear ICs.

Recent new announcements from RCA.

Type	Description	Features
CA3600	Linear COS/MOS Array	Simplicity plus high impedance
CA3100	Wideband Op Amp	High slew rate plus stability
CA3099	Programmable Comparator	Micropower plus programmability
CA3097	SCR Transistor Array	Low cost plus density
CA3130	PMOS/Bipolar/CMOS Op-Amp	High performance plus simplicity
CA3127	UHF Five-Transistor Array	Low cost plus matching
CA3096	NPN-PNP Transistor Array	Density plus flexibility
CA3095	Super Beta Array	Super gain $h_{FE} > 1000$

If you're looking for the newest ideas in linear ICs check the chart above. Here are eight important new LIC devices. All originated and announced by RCA within the past year. Arrays, op amps, and a programmable comparator which might help you achieve new design objectives.

Our five-transistor array might help you save some money. Our super Beta array could give you the extra gain you want. And our CA3096 is intended to help you achieve greater product density.

Our ability to combine technologies on a single LIC chip can be important to you, too. It produced a higher slew rate with stable operation in the CA3100 which incorporates both bipolar and PMOS elements.

In the CA3130 we took the multiple-technology-on-a-chip idea one step further to bring you a highly versatile performer at low cost. Combining PMOS/FET,

bipolar and CMOS, RCA made possible, for the first time, a voltage swing to within 10 millivolts of either rail in single power supply operation. Yet, despite its many features, despite its sophistication and inherent reliability, you can buy the CA3130 for just 75¢ in quantities of 1K.

If these new RCA linear IC developments come as news to you, you should also know that we can produce a custom circuit to meet your special requirements. Or supply you with the popular industry standards such as the 301A, 307, 311 and 339 families, or supply you with premium types such as 101A, 107, 108A and 111, which you probably have had a hard time getting. The fact is, RCA is a full-house in linear ICs. In addition to product, this means a wide range of packages, and complete engineering support.

Contact your RCA distributor and have him fill your order. And if what you need isn't a stock item, address your inquiry directly to RCA.

For more information, and a free cross reference guide and wall chart, call your local RCA Solid State distributor, or write RCA Solid State, Box 3200, Somerville, N.J. 08876. Phone (201) 722-3200, Ext. 3145.

RCA Solid State
A full house in Linear ICs.

Instrumentation

Air-monitoring grows complex

System integrated by Rockwell is being studied by U.S. in St. Louis test; data-collection instruments were developed in past few years

by Paul Franson, Los Angeles bureau manager

The attention of environmental engineers is focused on St. Louis. There, with electronic hardware in a dominant role, the U.S. Environmental Protection Agency is about to crank up an ambitious pollution-detection study aimed at establishing a model monitoring system that could be used elsewhere.

The study, called RAPS for regional air-pollution study, a five-year, \$22 million program, is now completing test and acceptance. The \$2 million hardware portion, called RAMS for regional air-monitoring system, has been put together by Rockwell International's Science Center in Thousand Oaks, Calif. It is perhaps the most complex and up-to-date sensor and data-acquisition network ever assembled for such work.

RAMS consists of an extensive data-collection network that has been integrated with air-monitoring instruments that have become practical, says William L. Dowdy, managing director of Rockwell's Air Monitoring Center, only in the past two or three years. The system consists of 25 monitoring stations within a 50-mile radius of the Gateway Arch in St. Louis, which was chosen because it is a typical big American city and because its meteorology is already well known and predictable. The RAPS network is being supplemented by aircraft and balloons for three-dimensional

studies, plus existing weather stations.

Complex. Each RAPS station is highly complex, T. L. (Terry) Loucks, vice president and general manager of the Science Center, says. Each is designed to automatically monitor carbon monoxide, methane, total hydrocarbons, sulfur dioxide, total sulfur, nitrogen oxide, nitrogen dioxide, miscellaneous oxides of nitrogen, and ozone. And it's all done with continuous-process electronic sensors. In addition, meteorological instruments monitor wind speed, wind direction, outside temperature, delta temperature, dew point, barometric pressure, solar radiation, visibility, and turbulence.

The instruments that monitor these parameters are interfaced through analog-to-digital converters to a Digital Equipment Corp. PDP-

Inspection. Equipment in Regional Air Monitoring System is checked out. There are 25 stations scattered around St. Louis.

8/M minicomputer. A Pertec magnetic tape system stores the information, which is also transmitted approximately once a minute over leased lines to the central station in Creve Coeur, part of the St. Louis metropolitan area.

The central station has a dual processor to massage the incoming data. A DEC PDP-11/05 and a PDP-11/40 are used—the smaller 11/05 for foreground housekeeping and telecommunications tasks and the 11/40 for data reduction. The output of the system can be presented on a high-speed Gould model 4800 electrostatic printer/plotter for hard copy. Other peripherals, including disk, tape, and cathode-ray tube, also are included.

Among the most interesting parts of the system are the pollution sensors. Considerable work has gone into developing instruments suitable for unattended operation in industrial applications with direct electronic output. But they hadn't been combined with sophisticated sensor

and data-handling equipment. So Rockwell had to develop software and integrate the instruments. Typical is the Beckman model 6800 gas chromatograph, which had been used to monitor processes in chemical plants. The units are so new, in fact, that Rockwell has included daily automatic recalibration to ensure validity of data, a stipulation that is high on the

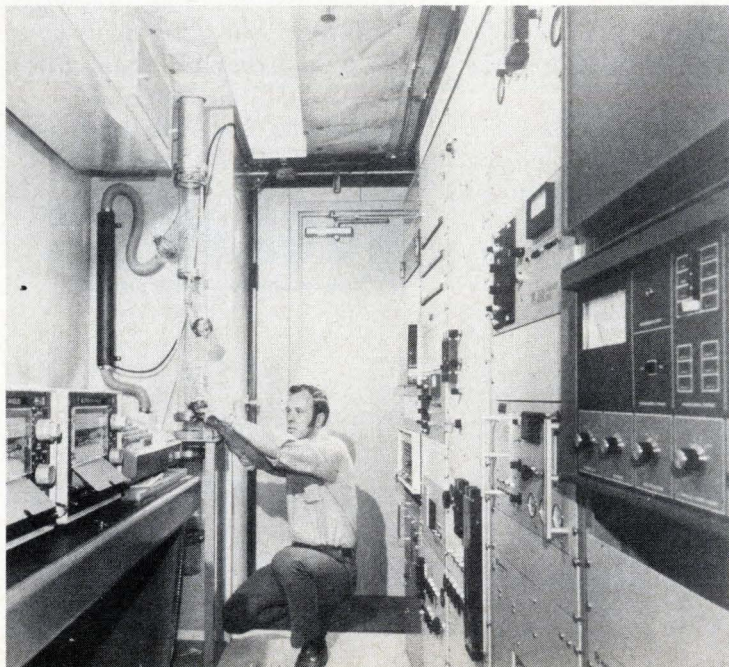

EPA's list of priorities because of questions that have arisen concerning past pollution studies.

Two units, both made by Monitor Laboratories in San Diego, Calif., use chemiluminescence to detect and measure ozone and various oxides of nitrogen. Sulfur compounds are measured at most stations with model 2700 gaseous-sulfur analyzers made by Tracor Inc. of Austin, Texas, although some use total-sulfur analyzers made by Meloy Labs of Springfield, Va. Both sulfur instruments use flame photometry. These instruments use photomultiplier tubes, a major source of drift, but the daily checks compensate. Rockwell is seeking solid-state replacements for the tubes, but they are not yet available.

The usual meteorological instruments come from Meteorology Research Inc., Altadena, Calif., and the dew-point sensor is made by EG&G Inc., Bedford, Mass. The solar-radiation monitors are made by Eppley Laboratory Inc., Newport, R.I. Meteorological sensors are mounted on 100-foot towers next to the self-contained metal enclosures.

Aerosol threat. A major instrument need is continuous monitoring of particulates, says George Lauer, Rockwell's director of air-quality research. Of special concern are the tiny aerosols that are increasingly being viewed as a threat to the ozone layer that shields the earth from excessive ultraviolet radiation. Lauer says that particulates are now checked with what is basically a filter and vacuum pump, with the filter weighted before and after exposure. This approach is not amenable to automated untended operation, he says, but Rockwell is investigating techniques.

"Sulfates are the big problem," says Lauer, and the group is now checking out a novel acid-aerosol evaluator. "There seems to be a strong correlation between sulfates and health problems, a subject of concern because new automobile catalytic converters may increase sulfate production."

Meanwhile, Rockwell, which hopes that systems may also be procured for other cities, has also supplied 23 fixed and five portable monitoring stations around the

country for the EPA's \$2.5 million community-health air-monitoring program (Champ), made studies of aerosols for the EPA and California's Air Resources Board, and is involved in other programs. It is also one of six firms that has recently qualified for a network of up to 50 monitoring stations for the Army's munitions plants, in what may be a multimillion-dollar contract with the Corps of Engineers. Others that

qualified for the project are General Electric, Westinghouse, Xonics of Van Nuys, Calif., Olson of Anaheim, Calif., and Radion of Austin, Texas.

In Europe, meanwhile, the Common Market is studying a possible linkup of air- and water-pollution monitors in various nations. This would include the Dutch system [*Electronics*, June 5, 1972, p. 75] and one proposed for Belgium. □

Automatic 0.25% impedance measure- ment:



Our new Model 251 Digital Impedance Meter provides the most accurate measurements of inductance (L), resistance (R), capacitance (C), and conductance (G) available in any instrument up to five times the cost—plus it's fast and reliable.

Big, fat claims, right? But consider this: Accuracy of 0.25% + 1 digit, measurement speeds of a fraction of a second, high-intensity 3½-digit read-out has overload blanking to prevent false readings, solid-state construction packed into a rugged 10-pound frame. And simple to operate.

You might consider this. Our reputation. We've led the building of precision impedance measur-

ing instruments for laboratory and quality control applications for 25 years.

Check us out, then call or write for the complete story. Ask about our discrete IC testers, too. Electro Scientific Industries
13900 N. W. Science Park Drive
Portland, Oregon 97229
Phone: (503) 646-4141

\$1200.
(U.S.A.)

esi
ELECTRO
SCIENTIFIC

Now. Produce error-free microprograms five times faster. And cheaper.

If you're designing a ROM-based system, you have a programming problem.

The design and implementation of digital logic and control functions are easier and less costly with microprogramming. But microprograms are very complex and always contain errors. Errors that may require weeks or even months to debug. The best way to accomplish this time-consuming task was to develop your own costly design aids. Up to now.

We have a better solution.

SMS now has the most economical, efficient answer to your microprogramming problems. Our design automation system includes both the hardware simulation aids and software necessary to do the job. You'll debug your microprogram in days, not months. And increase the number of error-free microprograms you generate and test by a factor of five.

Our hardware makes it easy.

The heart of our design automation system is the unique SMS ROM Simulator. With its read/write memory and instrumentation, you can literally

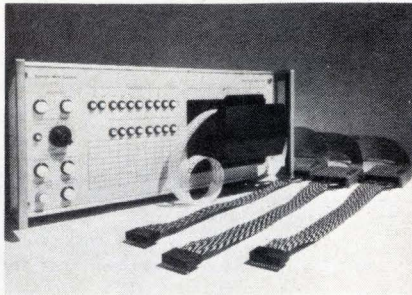

simulate the ROM's in your system. The ROM Simulator interconnects directly to your hardware by means of 16- or 24-pin DIP connectors. It will simulate any of the standard PROM's and ROM's available today. And with its 100ns access time, you can debug your system in real time.

The SMS ROM Simulator is modular and flexible to meet your particular requirements. You can specify up to 16 individual 4096-bit simulation modules. You can simulate a multitude of program arrays ranging from 512 words by 128 bits to 8192 words by 8 bits. All with the same unit. You'll easily locate and correct program errors. You won't have to worry about the time and expense of reprogramming PROM's or remasking ROM's.

Our software does it your way.

Our RAPID general-purpose soft-

ware package is designed for hardware engineers. It lets you generate your own assembler for your particular needs. You specify the input symbology, output code and format that are meaningful to you. And you do it in only a few hours, not days.

RAPID allows you to write programs in assembly language that's easily understood. Not in binary which can be a drudgery and error-prone.

You'll end up with the documentation you need during program debugging and for specifying the final pattern for each ROM component.

It's proven and available now.

The SMS ROM Simulator with RAPID Microcode Assembler is available now. Find out why this SMS design automation system has become an indispensable tool for many of the largest computer, calculator, and peripheral manufacturers. Send in the coupon today.

You've got nothing to gain but time and money.

Scientific Micro Systems
sms A Subsidiary of Corning Glass Works

For Microprogramming Application Notes, mail this coupon.

Application Notes

- | | |
|---|--|
| <input type="checkbox"/> Design of Microprogrammable Systems | <input type="checkbox"/> Design of a General Purpose Microcontroller |
| <input type="checkbox"/> Debugging Microprogrammed Systems | <input type="checkbox"/> Microprogramming Software Aids |
| <input type="checkbox"/> Economics of Microprogrammable Systems | |

I now use Plan to use the following ROM's:
Mfg. Type Qty./Yr.

I now use Plan to use the following microprocessors:
Mfg. Type Qty./Yr.

My company's estimated number of product programs using ROM's

In 1974: _____ In 1975: _____ In 1976: _____

I'd like a brief half-hour demonstration. Have a salesman contact me.

My phone number: _____

Name _____

Title _____

Company _____

Address _____

City _____

State _____ Zip _____

SCIENTIFIC MICRO SYSTEMS
520 Clyde Avenue, Mountain View, CA 94043
(415) 964-5700. TWX 910-739-6577.

E

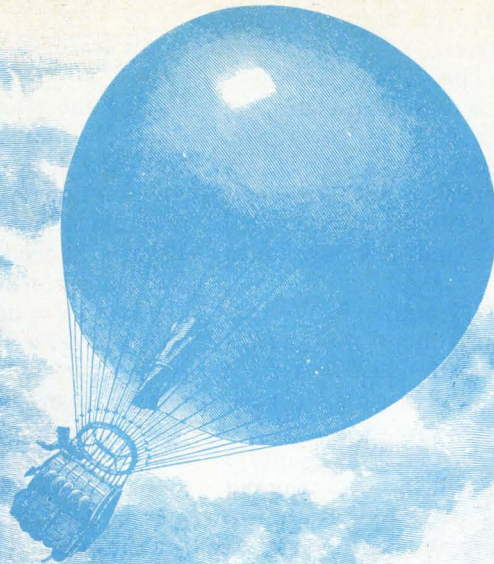

Western Europe's markets, beset by economic woes, to rise only about 10%

With inflation eating up a large part of that gain, the outlook for sales of electronic equipment is bleaker than in recent years; *Electronics'* survey puts 1975 equipment market at \$19.25 billion, up from \$17.5 billion

- 66 West Germany
- 68 United Kingdom
- 71 France
- 73 Italy
- 74 The Netherlands
- 75 Sweden
- 76 Spain
- 77 Belgium
- 78 Switzerland
- 79 Denmark
- 79 Norway
- 80 Finland

□ There's a good chance that 1975 will be a year many people in the electronics business will want to forget. Not since the end of World War 2 has Western Europe run into so many economic troubles at one time: business cycles headed downward in most countries, inflation everywhere, oil and raw materials prices almost out of sight.

What's more, the effects are showing up in more places than economists' charts and the business pages of newspapers. They are reflected by silent factories in the countryside, long lines at unemployment offices, and housewives turning their change purses inside out to make ends meet at the end of the month.

Despite the dismal overall outlook, virtually no one feels ready to predict for the electronics industry the kind of plight that's fallen on automakers and construction outfits. As they made their annual rounds through 12 countries this fall for the survey, *Electronics'* reporters time and again had people tell them something like, "we are cautious, but not pessimistic."

This year's reading has 1974 equipment markets for the various categories (see the foldout chart at the end of this report) at \$17.5 billion. The 1975 forecast puts total equipment markets at some \$19.25 billion, a 10% rise. But the only thing certain about the various markets is that price inflation will make any "gains" deceptively high. Throughout this report, incidentally, market sizes—based on inputs obtained mostly in September and October—are figured at factory sales prices for domestic equipment and at landed cost for imports. Dollar

figures throughout were calculated for both 1974 and 1975 at the rates shown on the chart.

As usual, consumer electronics checks in at the top of the list. But for the first time in a decade, it ranks last among equipment markets when it comes to growth. The survey figures a rise of 7% next year to \$6.7 billion from \$6.3 billion this year. There's no problem spotting the hitch here. Sales of color-TV sets in the United Kingdom plummeted this year, and few see much chance for a recovery next year.

Since Britain is the No. 2 color-TV market in Western Europe, slow business there distorts the overall market pattern. "I don't see a bright outlook for 1975," says Jan F. G. Lamet, who heads the central planning department for Western Europe's largest electronics group, Philips Gloeilampenfabrieken. Consumer electronics is Philips' strong point, and in late fall the company cut working hours for 6,000 of its employees in Western Europe in a bid to keep inventories from rising too high.

There are no particular surprises further down the list of equipment markets.

- Computers—at roughly \$5.5 billion this year and a projected \$6 billion-plus next—are a close second to entertainment electronics. As expected, the growth rate here has slipped from the high teens of yesteryear; next year is predicted to run 12% higher. Minicomputers are another matter; they're pegged to move up better than 35%.

- Despite lagging prospects for telecommunications-equipment manufacturers in West Germany, Italy, and a couple of smaller countries, there's acceptable growth in sight for other communications-equipment markets. In all, they are forecast to move up from this year's \$3.1 billion to \$3.5 billion.

- A drive to hold down the labor content in all sorts of products will keep sales of process-control and automation equipment up during 1975. Industrial-equipment markets seem set for an 11% rise to roughly \$1.5 billion. Instruments markets generally won't do quite as well, and some smaller producers may not make it through the year.

For components makers, what a difference a year makes. Most went into 1974 with bulging order backlogs and delivery delays dangerously stretched out. They'll go into 1975 with delivery times back to normal and, in some cases, booking-to-billing ratios below one. The marketing scenarios for the year ahead are generally being plotted as flat. *Electronics* survey projects a barely perceptible rise to just under \$5.5 billion next year from \$5.2 billion this year.

Semiconductor makers won't outrun other components suppliers this time around. The 1975 market for discretely and ICs may slide up only to \$1.35 billion from the 1974 tally of \$1.3 billion. There'll be strong pressure on prices until bookings start to pick up, particularly for consumer-grade discretely, small-scale TTL packages, and C-MOS. Most people in the industry say there will not be a repeat of the debacle that developed the last time the market went really sour. Robert Heikes, head of Motorola's semiconductor operations in Europe, says, "I don't think the industry is as dumb now as it was in 1971."

West Germany

Having the strongest and least inflation-ridden economy in Western Europe has not entirely protected West Germany from the doldrums experienced elsewhere. An iron-fisted policy of credit restrictions and cuts in government spending have made for sluggish business at home. Indeed, despite record exports the real overall economic growth this year has been a piddling 1%.

Some seers figure that Chancellor Helmut Schmidt will channel a little more government money into the economy next year, and that way trigger a modest rebound—perhaps enough to have the \$400 billion economy growing at something like 3% annually during the second half. "It will still be a difficult year," admonishes Manfred Beinder, head of market research at Standard Elektrik Lorenz AG, an ITT company.

Few would quarrel with Beinder's assessment. *Electronics*, after querying dozens of firms throughout the country, pegs the total of 1975 West German equipment markets at \$6.08 billion. That's some 8% better—nominally at least—than the estimated \$5.61 billion in the charts for this year. Since bloated prices account for much of the apparent gain, the real growth looks like something around 4% or 5%, far off the pace for a good year.

Like almost everybody in the electronics-equipment business, components suppliers will have to drown their sorrows next year in beer rather than sparkling Rhine wine. *Electronics*' survey indicates an essentially flat market for components: \$1.94 billion this year, \$1.96 billion next.

Semiconductor makers, this time around, are not proving the rule. To be sure, there'll be growth for "new" products like MOS logic, optoelectronics, and possibly linears. But sales gains for these favored few will barely offset the decline in discrete devices like small signal transistors. "We are in a buyers market where customers determine prices," asserts Dirk G. Vogler, manager of marketing administration at Texas Instruments Deutschland GmbH.

For Vogler and his counterparts at the other major semiconductor houses, accustomed as they are to spectacular gains, it's an unsettling state of affairs. But so far, no one expects a repeat of the great semiconductor debacle of 1970-1971. "We saw the slump coming as

GERMAN ELECTRONICS MARKETS FORECASTS
(IN MILLIONS OF DOLLARS)

	1974	1975
Assembled equipment, total	5,067.3	6,078.9
Consumer products	2,138.4	2,278.9
Computers	1,978.3	2,202.7
Communications	613.0	636.8
Industrial electronics	431.8	479.1
Test and measuring	125.8	130.4
Medical electronics	320.0	351.0
Components	1,940.1	1,960.9

Exchange rate: \$1 = 2.6 marks

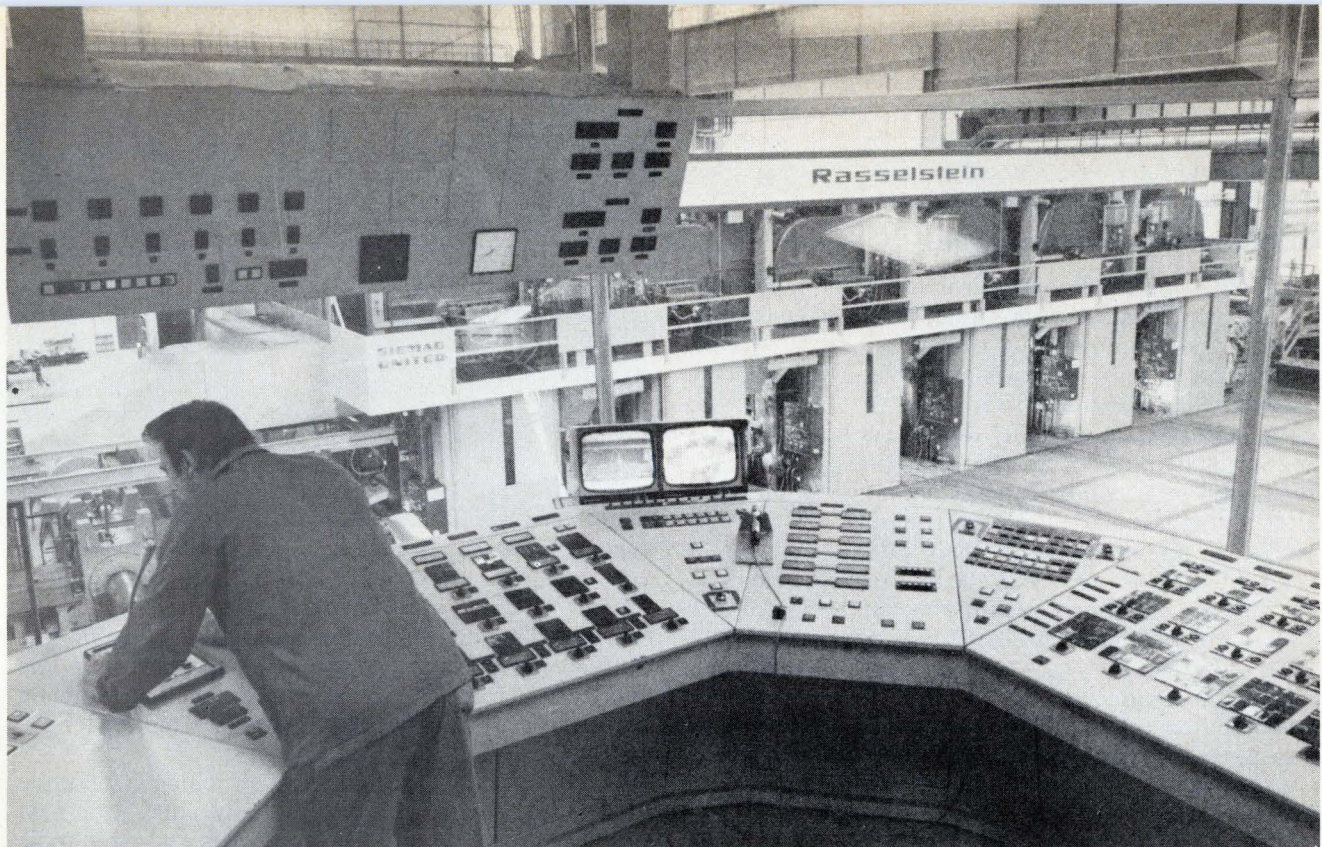

On line. Process-control computers, which run such industrial machinery as a six-stand tandem cold-rolling mill in Rasselstein, will continue to sell well in West Germany, although competition from minicomputers will keep growth rate to 35%.

early as mid-1974 and prepared for it," says Joachim Prange, a market researcher at Siemens AG.

"This time," says Fritz G. Höhne, manager for worldwide semiconductor marketing at AEG-Telefunken, "We saw a slump in demand simultaneously in the U.S. and Europe, and we reacted swiftly to it." Swift reaction has come, too, from Texas Instruments and Philips Gloeilampenfabrieken, the leaders in European semiconductor markets. Both have curtailed production.

Along with all this awareness, the West German semiconductor makers have going for them a solid customer—the country's consumer-electronics industry. It gobbles up some 60% of West German semiconductor output.

Although shining examples of semiconductor sales next year are few, bright items of new technology will abound. There will be an 8-bit n-channel microprocessor from Siemens, for example. AEG-Telefunken will compete with an eight-bit p-channel device with aluminum gates fabricated by ion-implantation—which are compatible with microprocessors that will be put on the market by SGS-Ates and General Instrument Europe, both headquartered in Italy. Intermetall and others plan to make time with new MOS circuits for TV remote controls and for timepieces.

For set makers, the game changes

German set makers have found an unexpectedly good color-TV market this year. Most of them entered 1974 fairly sure that the two-year buying spree touched off by the Munich Olympic Games would wind down. But they misjudged the country's passion for soccer and its adoration of the national team. Largely because of

the four-week-long World Soccer Championships held throughout Germany this summer—and won by the West Germans—color-TV-receiver sales have soared. At mid-year, in fact, some companies were reporting sales gains of 50% over the comparable 1973 period. That was enough to lift the market to roughly 2 million color sets—a record, of course. For the first time, points out Johanna von Ronai-Horvath, head of market research for the ITT entertainment-electronics companies Schaub-Lorenz GmbH and Graetz GmbH, color sets outsold monochromes. Reckoning in money rather than units, Saba-Werke's market research chief Wieland A. Liebler figures the 1974 gain for color-TV sets at 25%.

There's nothing like that in sight for 1975, marketing people at ITT, Grundig, Saba, and Philips Germany all agree. Consumers will waltz off with some \$1.18 billion worth of color sets, 11% more than they did this year, according to *Electronics'* survey. Add radios, hi-fi gear, tape recorders, and monochrome TV receivers to the mainstay, color receivers, and the prospects for entertainment electronics in 1975 wind up as a dull show—a modest rise of 6% to \$2.28 billion.

The survey, however, doesn't show everything. Consumer-electronics business will be lifted a little by sales of the ubiquitous pocket calculator, which is now metamorphosing from a semiprofessional product into a full-fledged consumer item. Reliable figures are still hard to come by, but it's a fairly safe bet that at least 1.3 million calculators were sold in West Germany this year. That's as many as had been sold in all the years before 1974.

There could be some brand new business in entertainment electronics, too, since AEG-Telefunken says it will finally get its Teldec video-disk system, dubbed

TED, onto the market. A redesign forced the company to boost the list price for a TED player by 25% to about \$580. All the same, Telefunken believes it can sell between 25,000 and 30,000 units next year.

Computers slow their pace a little

Computer makers know their market will be up next year but not as much as this year. "No longer do customers look on computers as prestige objects," says Eckhard Reimann, manager for market planning at Sperry Rand's Univac division in Germany. "Instead they are scrutinizing systems carefully these days before changing over to computer operations or upgrading models."

With the market edging toward caution, forecasters see some tapering-off next year in growth of general-purpose computer systems. Their sales moved up a strong 12% in 1974; next year the figure will be closer to 10%. *Electronics'* survey puts the market at just under \$2 billion in 1974 and forecasts a rise to just under \$2.2 billion in 1975.

For the traditional sectors of the computer business, minicomputers and small systems (with monthly rents up to \$3,000) appear set to lead the rise. But "contrary to earlier predictions, large systems will enjoy continuing growth, too," asserts Jochen Rössner, a Univac marketing specialist. By "large" Rössner means systems renting for \$60,000 a month and up.

Process-control computers will do much better than general-purpose business/administration machines. For 1975, the Cologne computer firm Dietz Elektronik pegs the growth at 45% in number of installations. But Dietz points out that heavy price competition by the mini-makers will cut the gain in revenues to more like 35%.

Meanwhile, some new data-processing markets are taking shape. One of the most promising seems to be point-of-sale systems, still a small market but growing fast. Sales next year will double or triple to about \$10 million. What's still lacking, laments Univac's Reimann, is a uniform coding scheme for price tags. But that may not be too far off. Already several chain stores have large-scale POS test programs under way.

Communications cut back

The talk by telecommunications-equipment makers is nearly all bad; "The worst in recent times," is the way one company executive describes the slump.

For starters, the post office—their major customer—slashed its spending for telecommunications this year by more than 12%. Instead of the \$2.54 billion earmarked originally, the outlay was cut to \$2.23 billion. Since further cuts look likely, 1975 probably will turn out no better. "Kurzarbeit"—shorter working hours—and even layoffs are the word at most of the country's two dozen-odd communications houses. Siemens AG, the largest, is paring its manpower in telephone-switching plants from 22,000 to 16,000.

The purely electronics side of the communications business isn't flourishing either. *Electronics'* consensus forecast points to a relatively flat market: \$613 million this year and \$637 million next. About the only consolation is that it apparently can't go on forever. The post office is readying for a large-scale introduction of its

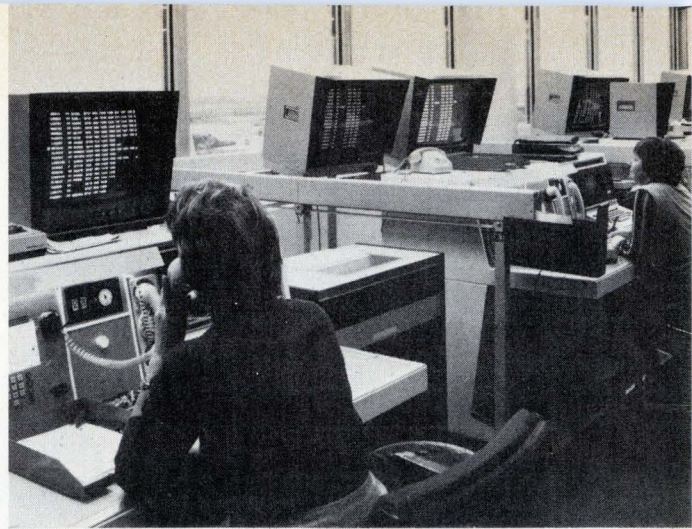

Fast access. Terminals are popping up all over West Germany, as for example at the Frankfurt airport's new passenger building.

EWS electronic switching system starting in 1977. The first two systems were cut over for regular service late this year. Siemens spearheaded the EWS development, laying out nearly \$400 million of its own money for the project.

Then there's the electronic data-switching system, the EDS; three more are expected to go into operation next year. The EDS uses multiplex techniques and can handle up to 28,000 data channels depending on transmission speeds. The post office isn't stinting on pulse-code-modulation systems for short-haul telephone trunks either. By the end of the year, there will be about 150 systems in operation.

Likewise, there's no letup in the market for modems. As for post office versions, the number jumped from 6,000 last year to 8,000 this year and is expected to go to 10,500 in 1975. On top of that come "private" modems with a rate of installation that should be just as high. Their number is difficult to pin down but it is estimated to be twice that of the post office models.

United Kingdom

The United Kingdom, having already shed its imperial trappings, seems headed for a time when it will don shabby garments. Indeed, no less a government official than foreign secretary James Callaghan publicly warns that the country is "sliding downhill" toward one of the lowest standards of living in Europe. By Britain's own reckoning, 1980 will see its economy half that of West Germany or France and equal to Italy's, measured in terms of average gross national product per capita.

Among its current ills are an inflation rate that may top 20% before it starts to subside, labor costs shooting up nearly 25%, a horrendous payments deficit, and a sagging growth rate for the gross national product. The overall output of goods and services seems headed toward zero growth from this year's 3%. To make it worse, some economists now think the country has already borrowed more than it can ever recoup from its North Sea oil fields.

It's not surprising, then, that many a marketing manager shudders when asked to put down numbers for 1975. For those who supplied inputs to *Electronics'* an-

nual survey, it was mostly a question of bad or worse. In the electronic-equipment sector, total projections for 1975 add up to \$3.47 billion. That's 8.4% above the \$3.2 billion estimated for 1974, and that figure does not take inflation into account. Traditionally strong British product areas—such as computers, radar, navigational aids, and communications equipment—look as though they generally can hold their own.

Color-TV, the bright star of the electronics industries for 1973, burned far less brightly in Britain this year, and 1975 won't bring it any new luster. Consumer consumption, from both retailers and the rental companies that dominate the market, shot up to 2.7 million sets last year. This year it tumbled to less than 2 million sets, and that's where it appears likely to stay. The forecast is for a flat market at \$815 million.

In its latest budget, the third this year, Prime Minister Harold Wilson's Labor government kept the reins on consumer credit. Therefore, set makers may have to wait until 1977, when a replacement market should emerge, for an upturn. Meanwhile, with color-TV sales flat, the entertainment-electronics market has little else going for it. Next year's outlook is for a piddling rise of 3.5% to \$1.45 billion.

What's bad for British consumer electronics producers has to be bad—or worse—for the country's components suppliers. Rental companies and radio-TV dealers have built up whopping inventories of color sets. The actual number is controversial, but it's in the hundreds of thousands. With an inventory like that, and dull consumer demand, set production can't expand much, if at all. And there goes the components makers' chance for much growth. *Electronics'* survey forecasts an overall components market next year of \$1.02 billion, up only 5.1% over this year's estimated \$970 million.

Semiconductor makers, for once, won't fare much better than producers of passive devices, even though semiconductor content is on the rise in most equipment. Sales of discrete components next year will barely top this year's \$125 million. As for ICs, they'll climb only 6% to \$105 million. Chalk that up to heavy pressure on prices.

Systems are "go" at the BPO

While the TV-set makers fret over their stagnant home market, communications-hardware producers can count on being aided by a big-spending customer at

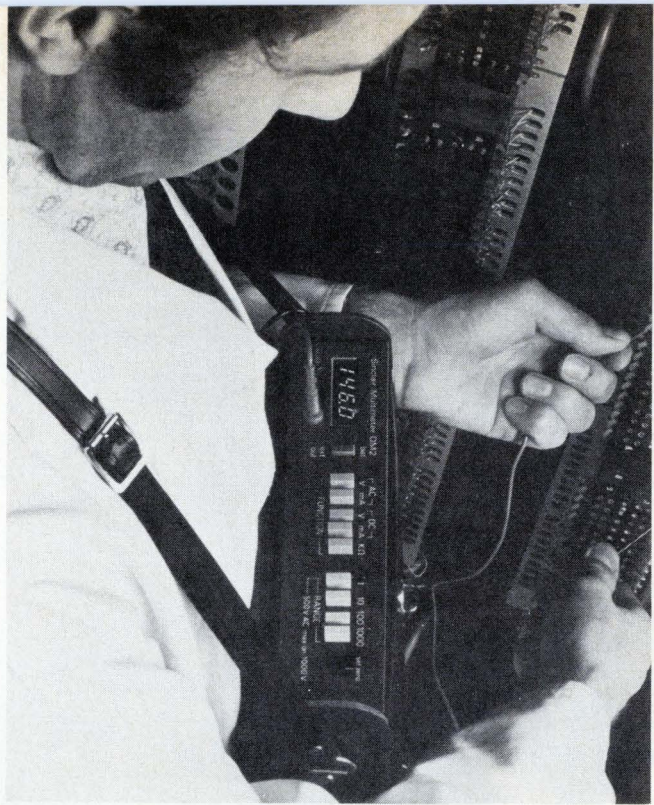

Testing. With such new items as a Sinclair multimeter, Britain's equipment markets will grow—but inflation may erase gains.

home and a satisfying list of buyers abroad. At home, the British Post Office plans to spend some \$200 million next year on electronic gear for the country's telecommunications networks, which it owns and manages. However, BPO, a public corporation, took a net 13% cut-back in 1974 funding, and further restrictions might be on the way. But suppliers think that, whatever happens, it will mean stretching out programs, not curtailing them. For one thing, the BPO has committed itself to a complete overhaul of its over-age telephone switching exchanges. So the hardware market should be long and lucrative for BPO's traditional suppliers—General Electric Co. Ltd., Plessey Ltd., and Standard Telephone & Cables Ltd., an ITT company.

Of the \$200 million, about \$160 million is targeted for trunk-exchange hardware, split \$92.5 million for switching and \$67.5 million for transmission. The teletypewriter network gets about \$28 million—\$16 million for machines, \$7 million for switching, and about \$2 million for multichannel voice-frequency gear. Another \$8 million is budgeted for data-transmission trials, and there's some \$2.3 million to improve telegraph services.

All this adds up to some whopping orders to keep telecommunications makers busy. STC has the initial contract for about 20 semi-electronic TXE-4 large exchanges. The first will be installed in 1975. Late next year, the experimental public packet-switched digital network, which is based on Ferranti Ltd. computerized switches, should go into operation. The hardware here cost about \$2.3 million, and another \$4.6 million outlay is planned to upgrade the network from experimental to trial status in 1976 or 1977.

Until the Wilson government thrashes out what to do about Britain's defense programs, radar and avionics makers can't pin down what their business next year

BRITISH ELECTRONICS MARKETS FORECASTS (IN MILLIONS OF DOLLARS)

	1974	1975
Assembled equipment, total	3,203.7	3,473.5
Consumer products	1,404.1	1,451.7
Computers	673.8	768.7
Communications	665.6	768.9
Industrial electronics	266.1	275.3
Test and measuring	90.1	98.9
Medical electronics	104.0	110.0
Components	970.3	1,017.8

Exchange rate: \$1 = 43 pence (£1 = \$2.33)

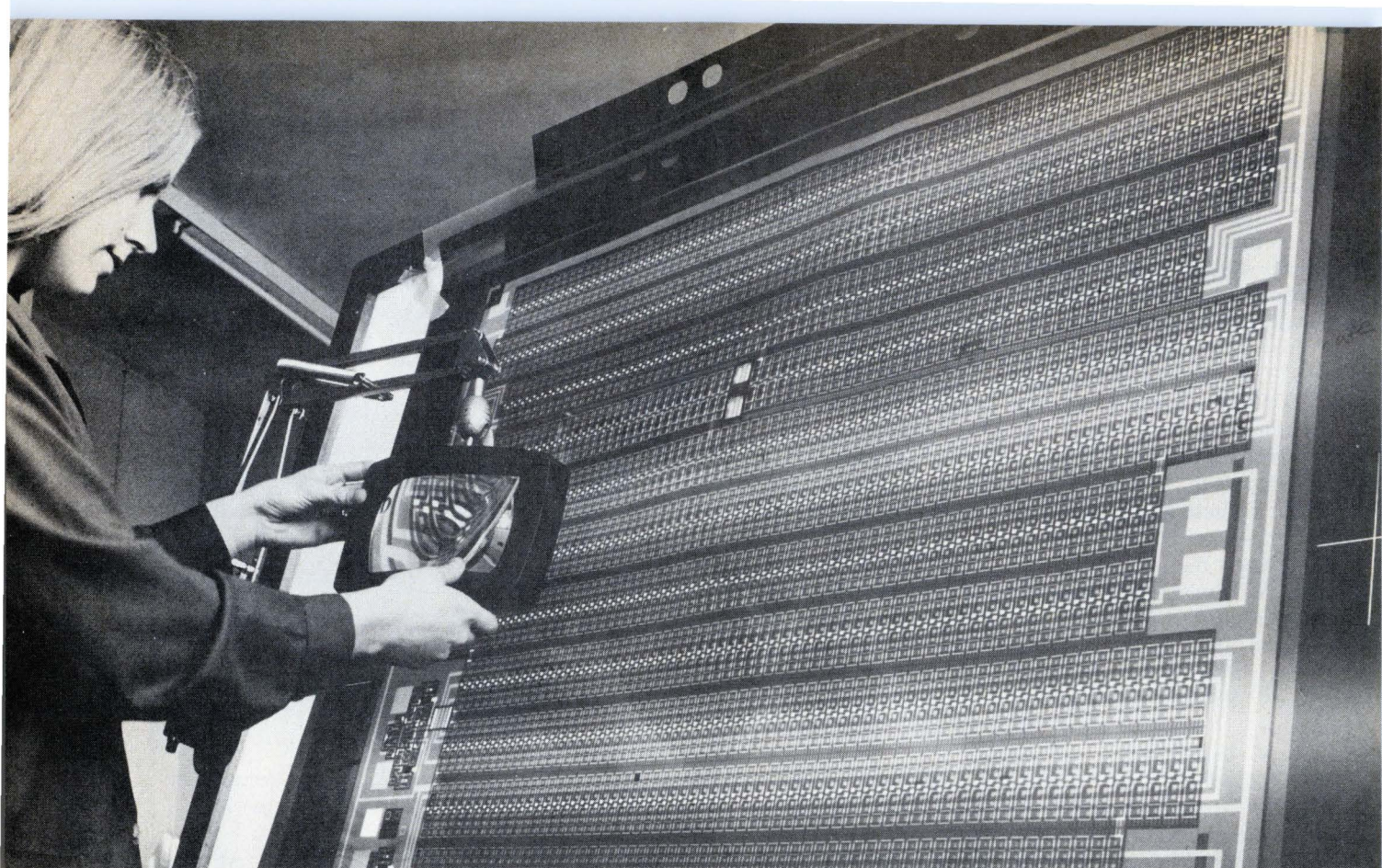

Bleak picture. Despite a rise in the semiconductor content of made-in-Britain electronic gear, the value of the discrete-device market should stay nearly even with this year's output. With heavy pressure on prices, IC sales will climb only about 6%.

will be. Nonetheless, the *Electronics*' consensus forecast points to strong markets for navigation aids, radar, and radio-communications equipment. They, along with BPO outlays for electronic switching gear and data transmission are mainly what's behind the predicted jump of some \$100 million for communications equipment, a jump that will carry the total market to roughly \$770 million.

Even if the home market doesn't do all that well, radar makers like Raytheon-owned Cossor Electronics Ltd., Decca Ltd., EMI, Marconi Ltd., and Plessey should fare nicely in 1975. All have strong possibilities in military markets abroad—even though there's an "over-supply of suppliers," as one avionics-company manager put it.

Plessey, for example, has prospects for its new AR-3D single-antenna three-dimensional ground radar at defense establishments around the world. Marconi has the same hopes for its airborne radars. In avionics, Marconi-Elliott will start working on its third thousand of head-up displays for export; more than 1,000 of the company's displays have gone into the U.S. A-7 fighter program. Not content with that success, Marconi-Elliott has readied an extended version of its head-up hardware that incorporates a computerized weapons-aiming system.

Steel reinforces computer makers

Computer people in the UK won't have to worry about the wherewithal for their pints of bitter next year. The data-processing market looks set for a respectable

rise from this year's estimated \$674 million in sales to nearly 769 million next. All sizes of computers will participate in the upward push as local governments, industry, and the armed forces rush to beat down rising manpower costs. As in most West European countries, minicomputers and data terminals will move out faster than other equipment.

Watch for brisk action in big machines—systems valued at \$1.68 million and up. International Computers Ltd., the native computer company, put a new range of big machines—the 2900 series—on the market this fall and expects big things from them. Already, ICL has logged nearly \$50 million in orders for 2900 machines. Most of the business has come from the government, which picked up the tab for about a quarter of the \$460 million or so it cost ICL to get its new series on the market. But ICL will joust with IBM for big-machine business, both in Britain and in selected international markets.

One big chunk of business is the \$135-million packet-switched computer network that British Steel Corp. plans to start putting together next year. In a system similar to the Defense Department's Arpanet in the U.S., the nationalized steel company wants to interconnect four administrative centers, a program-development center, a research bureau, and 10 production-planning and control centers over the next seven years. IBM and ICL will split the business for the administrative and program-development centers, while the processor equipment for the research bureau presumably will be ordered next year after competitive bidding.

France

Ever since Charlemagne started them going to school, the French have shown a penchant for doing things differently. Valéry Giscard d'Estaing and his countrymen really meant it, until the beginning of 1974, when they cried "vive la différence." Their economy was growing so fast and so soundly that some pundits figured France would rank third behind the United States and the Soviet Union among the world's economies by the end of the century.

No way, now. France's surge has been checked by the woes that beset most West European economies—oil priced out of sight, whopping payments deficits, and harrowing inflation. To be sure, Giscard and his men have moved to brake inflation, mainly through a credit squeeze. But that's brought business to a crawl and sent unemployment winging upward. To make matters worse, a prolonged postal workers' strike has accentuated the slowdown. Things may get better from next summer on, but now it looks as if the real growth of the economy will run only slightly above 4% next year, down from nearly 5% this year.

Little wonder that electronics industries executives are shifting from champagne to *vin ordinaire*. They can't count on any substantial new business, apart from exports, to offset the general slowdown. The suggestion that an infusion of high technology is one answer to high-priced energy has gone out to the nation's industrialists, but for the most part they are too short on investment capital to act on it. Traditional markets, except for computers and communications, will be lackluster, so 1975 will probably shape up as merely passable. French equipment markets should bring total sales of just over \$3.5 billion. That works out to an 11% gain over this year's estimated \$3.16 billion.

As usual, the sensitive components business picked up the first sniff of trouble. Even a year ago, in the midst of a boom, components people were worried about late 1974. Their worries were well-founded. After roaring through most of the first half, business pulled up short in September. Squeezed by high-cost energy and falling demand, component buyers began cutting back or canceling orders and started working off inventories.

French components producers are also keeping a ner-

vous watch on the U.S. market. They're anxious over the chance that the big U.S. suppliers will try to channel excess products to Europe to alleviate their own market slump. "We are seeing some signs now of the beginning of a price war," warns a senior government official who keeps tabs on the components business. "U.S. companies are starting to cut prices, and they need only a tiny profit margin to stay alive."

Managers at U.S. companies might dispute this, but there's no quarrel over softening prices. At Texas Instruments, second only to Philips in European semiconductor markets, European marketing manager François Dufaux predicts price reductions on sophisticated products. But he adds that TI has been expecting a market slowdown at this time for a couple of years. "It's not taken us by surprise," he claims.

Few, in fact, were taken in by the first-half boom. And so there's little that's surprising in the *Electronics* consensus forecasts for 1975 components markets in France. They should edge up about 6% to about \$1.02 billion, and that's mostly because of price rises for passive components. For the first time in years, semiconductors will not pace the market. Discrete devices will hover a little below this year's estimated \$117 million while ICs will gain very little—perhaps going to \$97 million next year from \$94 million this year.

Hard times at home for equipment makers

Components makers have company. "It's going to be no worse for them than for us," says Louis Le Saget, executive vice-president of CIT-Alcatel, a communications-making subsidiary of the Compagnie Générale d'Electricité (CGE), the largest electrical-electronics group in France.

The country's TV-set makers share that sentiment. Like others on the Continent, they had crowds of soccer fans turning up in their retailers' shops during the first half of 1974 to buy color sets. But the spurt subsided in the fall, and the year's sales probably will end up at roughly \$330 million. To be sure, that's a solid 28% rise over last year's mark. But the country's setmakers, with a market far from saturation, had counted on doing much better.

For 1975, the outlook is for a very modest rise to \$365 million. And with color-TV sales sluggish, not much can happen in the total entertainment-electronics market. It's pegged to expand 6% from \$800 million this year to \$850 million next year.

For the lackluster color-TV sales in sight, set makers have to take part of the blame as well as the consequences. They switched massively to wide-angle picture tubes last year, a move one government industry-watcher now questions. "They were mad to bring in the 110° tube," he charges. "It added another \$200 to the price so people have to wait longer to buy. Still, the industry is preparing to launch another improved tube [precision-in-line type] at the end of next year." The upshot, he feels, may be a new interest in monochrome sets and hi-fi systems as consumers shy away from \$1,000 color-TV sets.

Industrial equipment makers find themselves in much the same fix. Their customers, even though big in-

FRENCH ELECTRONICS MARKETS FORECASTS
(IN MILLIONS OF DOLLARS)

	1974	1975
Assembled equipment, total	3,158.8	3,504.9
Consumer products	801.0	851.4
Computers	1,129.6	1,265.3
Communications	794.7	921.0
Industrial electronics	182.6	187.3
Test and measuring	126.6	136.8
Medical electronics	124.3	143.1
Components	961.0	1,018.4

Exchange rate: \$1 = 4.8 francs



In the air. With up to \$4.5 million in electronics gear per plane, the Mirage F-1 will keep France's avionics and radar builders happy.

dustrial outfits, are strapped for investment money. Thus, the big business that market planners see for automation electronics won't come next year. *Electronics'* consensus forecast points to an essentially flat market next year at \$187 million. CIT-Alcatel's Le Saget is even more pessimistic. He predicts a drop in sales for numerical controls and process automation systems.

As for instruments makers, the large ones anyway, they are bravely predicting some growth for 1975. The survey indicates a small rise, from \$127 to \$137 million. But business probably won't be buoyant enough to keep some of the smaller instrument makers afloat. At year-end, several faced serious financial troubles.

Communications-equipment makers, by contrast, will be well ballasted by heavy workloads. Still holding to its



Check out. Still ringing up sales in France are point-of-sale terminals, such as the 75 machines at Europe's biggest hypermarket.

vow to get the country's telephone system on a par with neighboring Northern European countries by 1978, the government has budgeted close to \$3 billion for telecommunications next year. That's a hefty 35% rise over this year's allotment. But in actual equipment purchases, the rise won't be nearly as impressive; inflation will slim it down.

What's more, there will be a significant shift in equipment policy by the government's ministry for telecommunications next year, a shift that will hurt electronics. Originally, the agency planned to spend up to 10% of its outlay for new switching equipment on electronic systems, particularly CIT-Alcatel's E-10 time-division Platon system. But it has turned out costlier than first thought, and the agency is under pressure to get as many new lines in service as it can for its money. So the share for electronic switching will run only between 4% and 6%. Companies with strong positions in the microwave business, however, see a lot of appeal in the ministry's plans to step up spending on interurban microwave links and coaxial-cable trunk lines.

The most favored lot of French electronics companies over the next year will fall to high-technology companies like Thomson-CSF, avionics producer Electronique Marcel Dassault, missile maker Engins Matra, and Le Matériel Téléphonique (LMT), an ITT company that makes a wide range of navigational aids and radio gear in addition to what its name indicates. These manufacturers will thrive on military-equipment orders, but they generally don't like to talk about it. "The military business is static in France," blandly asserts Edouard Guignon, the commercial director for Thomson-CSF. "In real terms, it may even show a decline next year."

That may be true for deliveries to the French army, navy, and air force. But there's no doubt that overseas arms sales by the French are flourishing and may continue to do so for several years to come. With little official information to go on, the guessing is that plane-maker Marcel Dassault, Thomson-CSF, Engins Matra, and the country's other weapons makers have piled up some \$2.5 billion in new orders this year. LMT reports brisk export business for its nav aids, for example. At CIT-Alcatel, orders for underseas-warfare systems are up 30% this year over last year's \$42 million. But perhaps the surest sign that France's military-hardware makers are going full tilt comes from the quasi-official economic forecasting agency BIPE—for Bureau d'Information et de Prévisions Economiques. The weapons business, confirms the agency's top electronics forecaster, Jean-Philippe Dauvin, will play a large role in keeping the high-technology companies busy next year. As a result, he feels, there is now little chance of a crisis for components producers.

The computer makers, obviously, don't face a crisis, either. But they can't expect to match this year's growth of nearly 15% overall. *Electronics'* forecast puts the market at \$1.27 billion, up 11% over the 1974 figure of \$1.13 billion. It's the medium and large systems that look the most vulnerable to the squeeze on investment capital, according to BIPE's Dauvin. Minicomputers should spurt better than 30%, and point-of-sale equipment should be a high-flyer.

Italy

La Dolce Vita has run its course as a life style in Italy and now Italians are getting a strong taste of "Bitter Rice." The day's news is a routine recital of woe—both political and economic. Reports of bombings, political scandals, and threatened *coups d'état* fill columns. Alongside are run grim stories about the Italian economy—inflation at 25% annually and accelerating, unemployment rising past the million mark, an incredibly bad cash-flow situation, and a foreign-trade payments deficit pushing past \$10 billion. Recession—if not chaos—seems inevitable, and some economists now think the country's real output of goods and services will shrink about 1½% in 1975.

Electronics' consensus forecast, based on inputs supplied this fall by most of the major Italian electronics firms, has all electronic equipment sales rising to \$1.45 billion next year from the \$1.26 billion logged in 1974. On the face of it, that's a 15% rise, but it works out to practically no real growth because of inflated prices. But there are a couple of major exceptions. Automation-hardware sales will go up, mainly because machines don't clamor for pay rises as workers do. And there'll be reasonable growth for sales of color-TV sets.

Pirate transmitters help set makers

For a long time now, Italian TV-set makers have known what they needed to tonic their sales: color transmissions by the official broadcast agency, RAI-TV. But there's so little chance of that happening soon that they've even given up lamenting about it. All the same, the set makers are not without consolation. For some time now, so-called "pirate" transmitters have been relaying colorcasts from France, Switzerland, and Yugoslavia. The programs now reach well into northern Italy, and are expected soon to reach as far south as Rome.

While lacking legitimacy, these colorcasters apparently provide as much market stimulation as the Italian set makers need at present. This year's sales ran some \$24 million, according to *Electronics'* survey, and next year's should run \$34 million. Not overwhelming, but, as a beginning, not bad.

But, for the mainstay, black-and-white TV, *Electronics* forecasts an essentially flat market at just under \$150

million for 1975. Mainly because of color-TV sales, total consumer electronics will move up to \$307 million next year from this year's \$281 million, according to the charts.

Telecommunications a disappointment

Until this year, Italian telecommunications-equipment makers considered growing markets as one of the certainties of life, but the economic tailspin has changed all that. "We face some very tough months ahead," worries Aldo Calderelli, who is vice president for Europe at General Telephone & Electronics in Milan.

Calderelli and his counterparts at other suppliers of telecommunications to the state-owned telephone company SIP indeed have their problems. SIP has been working on what was once an ambitious expansion plan—to add nearly 5 million new subscribers to its network between 1974 and 1978. But inflation has undermined the program.

The solution, says SIP, is higher phone rates, but so far the government has balked at that. However, the government may yet come through with a new five-year plan for improving the telecommunications network. It would allocate \$1.7 billion for the years 1974 through 1978. This plan was proposed by the post and telecommunications ministry and is now before a high-level economic planning committee. It would supplant an existing five-year plan involving \$864 million.

Meanwhile, the waiting list for phones mounts at a time when SIP has been forced to cut back its equipment buys. Some companies report their orders from SIP have been slashed by as much as 30% in recent months. And they look for similar setbacks in 1975.

For the electronics industries, the only consolation to count on here is that SIP's heavy cuts mostly affect electromechanical switching. But there'll be setbacks for electronic-hardware programs too. ASST, the state agency that handles the country's trunk lines—just as SIP runs the local networks—wants to upgrade its microwave network, but probably won't get the necessary government approval. RAI-TV ordinarily would be in the market for broadcast equipment next year—it's working mostly with over-age transmitters and repeaters—but the government keeps the broadcast agency on a hand-to-mouth, year-to-year basis that effectively rules out investments.

One program that could fare better than most is improvement of the nation's airports. Some \$110 million was earmarked by the parliament this summer for "indispensable" improvements on runways and buildings, plus another \$55 million for navigation aids. It's mainly because of expected sharp rises in radio communications gear and radar that *Electronics'* survey points to a spurt in communications-equipment markets, from \$290 million this year to \$367 million next.

Manpower costs a motive for minis

There's a spurt in sight, too, for industrial-automation equipment. Giovanni Mantovani, marketing director for Nuove Pignone, figures the market as a whole will rise at least 20% next year. Mantovani's company, part of the state-owned oil group ENI, saw its own orders

ITALIAN ELECTRONICS MARKETS FORECASTS
(IN MILLIONS OF DOLLARS)

	1974	1975
Assembled equipment, total	1,257.8	1,451.0
Consumer products	281.3	306.6
Computers	471.5	525.9
Communications	290.9	367.0
Industrial electronics	143.8	172.1
Test and measuring	36.8	42.4
Medical electronics	33.5	37.0
Components	336.7	357.9

Exchange rate: \$1 = 675 lire

jump 40% this year and expects to do even better next. But Mantovani stresses that the gains stem from such new developments as pollution control and hospital automation. Equipment sales to traditional customers like petrochemicals makers are fairly sluggish in Italy, although Nuove Pignone has a solid backlog from East European countries.

Amidst the general gloom, the computer market continues to glow, although not nearly as brightly as before. *Electronics*' survey shows an 11% climb to \$526 million next year. The 1974 gain was a shining 18%.

Not unexpectedly, the minicomputers are selling faster than their bigger brothers. Many, though, serve as little more than billing machines for small businesses. It's mainly a matter of saving labor costs. Indeed, the urge to keep labor costs in line is bolstering the market to such an extent that next year's growth may be as much as 50%. Olivetti, which obviously knows a good

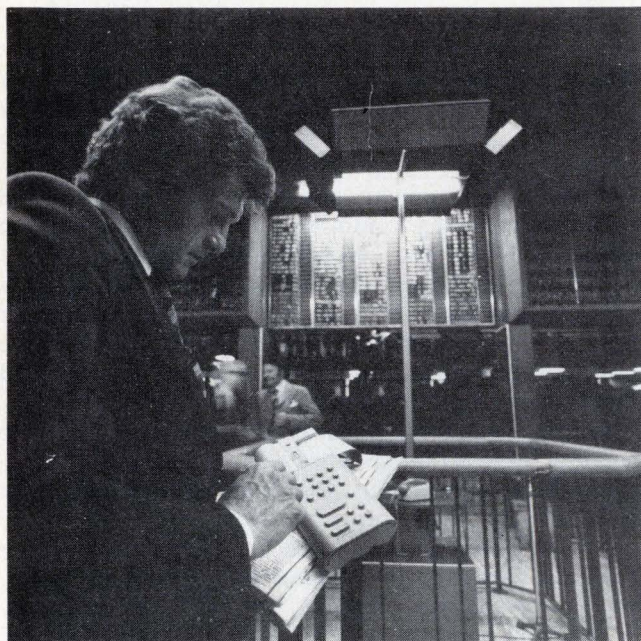

Adds up. The Italian market for business accounting systems—from hand-held calculators to big computers—keeps on growing.

thing when it sees one, has entered the market with new modular accounting systems—the Audit 5 and the Audit 7, plus a computer terminal, the TC 800.

While small businesses turn to minis, more mature data-processing users are shifting upward from minis to small machines, notes Renato Levrero, a market researcher at Honeywell Information Systems Italia. And there's still big-system business going on with the government.

Electronics' survey pegs next year's components markets in Italy at just under \$360 million. That would be 6% up on the 1974 figure and not terribly exciting when inflation is running at 25%. As a result, Italian components producers are turning heavily to the export markets. Sergio Minoretti, General Instrument Europe's vice president for marketing, reports his company now ships 70% of its output to export markets. "The downturn is less pronounced there," he maintains.

The Netherlands

There's downbeat news coming out of Eindhoven, in the Netherlands, headquarters for Philips Gloeilampenfabrieken, far and away the largest electronics company in Western Europe. Philips at year's end figured its sales worldwide for 1974 would add up to just under \$9.5 billion. That's a gain of 11% over the 1973 figure, but it hasn't boosted profits. Steep rises in labor and materials costs have cut so deeply that company officials say they're "hoping"—but not sure—that they will wind up the year with the same \$340 million net profit they managed in 1973.

Conservative when it comes to pulling back the curtains on the outlook for the year ahead, Philips executives now say so many hitches are possible in business worldwide that they are not going on record yet with estimates for their 1975 sales. Holland, however, amounts to just another small market for Philips. And *Electronics*' survey did turn up a few hardy souls with ideas on how the country's electronics markets might perform next year. The consensus forecast is for a climb from \$844 million for electronic equipment this year to some \$950 million next.

That works out to an apparently good-looking 12%, but a thick layer of inflation masks little real growth. Communications and computers look like the strongest equipment performers next year. Nothing special seems in sight for the entertainment-electronics sector. It's predicted to go beyond \$350 million—up from the \$322 million this year. As for components suppliers, their markets are forecast as essentially flat; \$172 million this year, \$176 million next.

Sales figures for communications equipment will spurt next year. *Electronics*' forecast puts 1975 markets at roughly \$107 million, up a solid 25% over the \$86 million racked up this year. Much of the credit goes to electronic switching. The Dutch postal and telecommunications authority, the PTT, last year made it known it would switch to stored-program-control switching as much as possible. And the PTT has backed up its intentions with some 30,000 lines worth of Philips PRX exchanges this year. Leo Marijnen, managing director of Philips Telecommunicatie Nederland, expects the total will run to 100,000 lines in 1975. At \$200 or so a line, the PRX business is a big plus for Philips. L M

DUTCH ELECTRONICS MARKETS FORECASTS (IN MILLIONS OF DOLLARS)

	1974	1975
Assembled equipment, total	844.4	952.3
Consumer products	322.4	352.9
Computers	270.3	307.8
Communications	86.3	107.4
Industrial electronics	95.1	107.9
Test and measuring	48.9	54.4
Medical electronics	21.4	21.9
Components	171.6	176.2

Exchange rate: \$1 = 2.65 guilders

Ericsson, too, could come in for some semi-electronics switching business; it's in line for a trunk switching exchange at Dordrecht.

The PTT still has its video-telephone trials running. Although there are no formal results yet, some potential users have let on already that they wouldn't want the service if they had to pay for it. "We ran the experiment as much for ergonomics, to see how people would react to them, as anything else," says Hendrik Wijers, a telecommunications official at PTT. The same consideration lies behind the nine-man conference-television studios at Amsterdam and the Hague that the PTT plans to open late this year. They'll be linked to studios in London and Stockholm.

Radar will be a propellant for the communications sector next year. Philips has orders totalling \$7 million—some \$2.2 million of that for electronic gear—to build the first phase of a radar chain for the Scheldt River estuary, the channel that leads from the North Sea to the port of Antwerp. The first phase, which should be in operation at the end of 1975, includes a couple of unmanned stations on towers—one of them on an artificial island that Philips will build in the estuary.

The Dutch police, too, will do their part. They've taken delivery this year on a \$3 million system that routes teletypewriter messages automatically to police stations throughout the country. Some 200 terminals are linked to a central station, based on a Philips DS-714 message switcher. Next year, a computer for car-registry retrieval will be added and by 1976—maybe earlier—the number of terminals will be up to 500. Arnold Janssen, the project engineer, thinks this is the first such nationwide system in Western Europe.

After communications come computers on the list of fastest-growing markets. The consensus figure is a 1975 market of \$308 million for data-processing and related gear, a jump of nearly 14%. Unfortunately for makers of traditional EDP hardware, most of the bulge is coming from things like electronic calculators, point-of-sale equipment, and minicomputers. New EDP systems will show a rise of about 8% to \$142 million, compared with a gain of some 10% this year. As Jan Schapers, computer systems manager in Holland for Hewlett-Packard puts it, "We are probably heading for a difficult time, but a lot of people are exaggerating the difficulties."



On trial. The Dutch telecommunications office is still running tests of commercial video-telephone service, which started early in 1974.

Sweden

Like guests who arrive late at the annual village smorgasbord, the Swedes find themselves out of phase with their neighbors. The country's industrial plants are running at full capacity, manufacturers' order books are plump with backlogs, and companies are earning record profits. Foreign trade has figured heavily in all this, but domestic consumption has held up, too. And although Swedes worry about it like everyone else, inflation so far has not advanced to the dangerous double-digit stage on Sweden. Unless the other European economies turn unusually sour next year, the Swedes expect they can push up their real output of goods and services between 4% and 5%, the same kind of growth they logged this year for their gross national product.

That prospect explains the confidence that reigns in the industrial-electronics sector. The consumer-electronics people, by contrast, won't have it so good. Largely because color-TV sales have peaked, the total figures for Swedish electronic-equipment markets don't show much glow. *Electronics'* survey turned up a consensus forecast of \$876 million for 1975, up less than 5% over this year's \$839 million. Components makers can count on doing a little better. The forecasts for their markets add up to \$217 million, a rise of 7%.

Computer field looks good

The drabness falls away, though, when you get to computers and industrial equipment. They stand to chalk up double-digit advances next year. Suppliers of computer and related equipment should see their markets rise to \$208 million from the 1974 figure of \$185 million. That's a 12% spurt. The same sort of thing can be expected in the industrial-electronics markets. They are forecast to go to \$63 million from this year's \$56 million.

For both sectors, in fact, the long-term outlook is solid. A royal investigating commission this spring took a long look into the country's data-processing needs and the ways and means to develop a sane Swedish computer industry. Its conclusion: the government alone would need something like \$25 million worth of new EDP systems every year from now until 1980 plus another \$65 million annually for replacement systems. The report recommends that Sweden move toward data-communications-oriented networks tied to big computers.

All this is good news for the major terminal makers, like Svenska Philips AB, SAAB-Scania AB, and Nixdorf Computer. It also points to a change in the market for the mainframe makers, thinks Stig Walstam, marketing director for Sperry Rand's Univac division in Sweden. Extensive systems with real-time responsibilities, like the system that the Swedish police are getting, mean computer makers will more and often be supplying turnkey data-processing installations rather than merely hardware and software.

As for industrial-equipment makers, they may be heading to a best-of-both-worlds situation. With plants running at full blast, industrialists figure to spend heav-

SWEDISH ELECTRONICS MARKETS FORECASTS
(IN MILLIONS OF DOLLARS)

	1974	1975
Assembled equipment, total	839.4	875.9
Consumer products	396.5	391.3
Computers	184.5	207.6
Communications	155.7	163.8
Industrial electronics	56.2	63.1
Test and measuring	20.2	21.9
Medical electronics	26.3	28.2
Components	200.4	217.2

Exchange rate: \$1 = 4.35 krona

ily for automation equipment. And the government has a couple of more inducements in mind.

Last month, the government sent a bill up to parliament that would require companies to deposit 15% of their pretax profits into special funds. The money would be earmarked for industrial and other investments during the next five years. This bill follows a similar one, already approved by parliament, that puts a 20% levy on pretax profits to set up funds destined to improve the working environment. Finance minister Gunnar Straeng estimates that companies will put about \$500,000 into the funds. Part will go for monitoring devices and control equipment to improve the environment in plants. Musing on that, Harry Nelson, a financial executive at the big instrument and computer importer Erik Ferner AB, says that "in general, I think the market isn't going to be too bad."

Communications-equipment makers generally are a notch below industrial-equipment makers in their enthusiasm for 1975. *Electronics'* survey spots the sector at \$164 million next year, up minimally over this year's estimated \$156 million. Ake Nylander, a director of Standard Radio & Telephon AB, an ITT company, notes that the growth of telephone traffic has started to level off, a state of affairs that doesn't put any special pressure on the state telecommunications agency, Televerket, to pour money into its network. And as investment growth slows, the companies likely to have their orders cut last are those that Televerket owns in whole or in part.

The fastest growth in sight in telecommunications is for data traffic. Televerket is now putting together a

Off the ground. A small run of interceptor versions of Sweden's Viggen jet will see the country's avionics makers through the year.



trial data network that's scheduled for service in 1976. There's also a teletypewriter network in the works—based on two big exchanges and 27 smaller ones—that should be completed by the end of the decade. Most of the business is destined for Ellemtel.

The military-electronics business, on the other hand, is slated to stay flat in money terms—another way of saying it's on the wane. Some help at home for radar and avionics producers will come from the interceptor versions of the Viggen military jet that the defense department has ordered from SAAB-Scania. In late November, Stansaab, SAAB-Scania's electronics outfit, was in the running for a \$75 million contract to equip three large airfields in the Soviet Union with air-traffic-control gear. The outlook would turn absolutely euphoric, of course, if by some miracle SAAB flew off with the "aircraft order of the century" that should be decided next year when Belgium, Denmark, Holland, and Norway order planes to replace their over-age F-104 Starfighters. But no one really expects that.

Nobody expects anything sensational, either, in the color-TV market in Sweden next year. Ulf Tidics, head of market research at Svenska Philips, figures the market peaked this year at over 300,000 sets. A temporary cut in the purchase tax was partly responsible for that peak so, at best, next year's figure might match this year's. More likely, there will be a drop, and *Electronics'* consensus forecasts that the color-TV market will shade down to some \$241 million from this year's \$253 million. Monochrome-TV sales will fall off, too, along with radios. Radio/recorder sales will rise, as will the decibel count at the cash registers of hi-fi makers, but not enough to recoup the drop-off for video. So all told, the entertainment electronics market will remain essentially flat next year somewhere just below \$395 million.

Spain

On top of the uncertainty permeating the rest of Western Europe, Spain faces an especially worrisome political situation. Should the aged and ailing Generalissimo Franco depart the scene in the midst of economic hard times, the social fabric of Spain would be doubly tested. Clearly, Premier Carlos Arias shares this perception. With his plan to revitalize the economy by next year, massive government spending is in sight.

Barring political turmoil, then, the Spanish economy should do all right in 1975, despite fairly high inflation—something like this year's 12%. For the entire market *Electronics'* survey forecasts a gain from this year's \$653 million to \$765 million in 1975. That's a climb of 17%—not bad even when adjusted for price inflation.

Entertainment electronics traditionally tops the list, and that will continue in 1975, according to the survey. The total figure should be about \$275 million. Computers aren't far behind at \$218 million, and communications equipment follows at \$173 million. Although much smaller than the other three, industrial-electronics sales are predicted to rise by 21%, to \$46 million.

Electronics is listed in the Arias program as one of the "industrias preferentes." Outsiders who want to invest in them with Spanish partners qualify for a special pack-

SPANISH ELECTRONICS MARKETS FORECASTS
(IN MILLIONS OF DOLLARS)

	1974	1975
Assembled equipment, total	653.0	764.8
Consumer products	215.0	274.7
Computers	198.8	217.8
Communications	153.8	172.8
Industrial electronics	38.1	46.1
Test and measuring	15.3	17.4
Medical electronics	32.0	36.0
Components	109.8	116.1

Exchange rate: \$1 = 58 pesetas

age of inducements, like preferential loans, tax relief, and waivers on duties on most plant equipment. In return, the government wants guarantees that the enterprises will grow to worthwhile sizes and eventually export a significant chunk of their output.

Overall, the program covers a broad spectrum of professional electronics: computers, communications, instruments, industrial hardware, defense equipment, and medical electronics. But the initial push will be in computers; the government has been trying for two years now to set up a "native" producer under the wing of the Instituto Nacional de Industria (INI). This fall, Japan's Fujitsu Ltd. seemed to have the inside track to join forces with INI and Telesincro SA in a joint venture. But by late-November, rumor had it that West Germany's Nixdorf Computer AG was back in the running.

At Telesincro, Spain's sole Spanish-owned computer maker, the feeling is the decision may not come in 1975. But that doesn't particularly bother Juan Majó, the company's president. Telesincro has been doing quite well on its own. Sales this year hit \$85 million, up a startling 62% over 1973's figure.

Majó expects sales will swell around that level in 1975 and then take off again. The company has new peripherals and a new range of office computers in its pipeline, but Majó will shift to new markets like point-of-sale hardware and digital scales to meet the company's ambitious expansion goals. Industrialist Juan Luis Heredero's Piher SA now is the largest shareholder in Telesincro, and Heredero wants it to grow 50% annually for a few years after the economy starts to pick up. Ordinarily, expansion like that would endanger a small company, but Telesincro is backed by both Piher and a big Barcelona bank.

By contrast, TV-set makers' expansion plans are tinged with moderation. The government has kept entertainment electronics off the preferential list and has further stung set makers by upping the tax on radios and TV sets, as well as curbing credit buying. Nor is there much chance that the government-run broadcast network will officially start colorcasts next year, a move the set makers count on to stimulate sales.

But experimental broadcasts continue, and there's an embryonic color-TV market taking shape. Color-set sales this year ran roughly \$25 million, and they'll go up to \$65 million next, according to *Electronics'* forecasts, which are based on inputs obtained before recent tax

hike and credit curbs. When the market does finally take off, Spanish set makers expect to be well along the runway. Iberia Radio SA, for example, has readied a completely modular 26-inch color receiver and is producing a dozen or so a day.

With set makers' output on a plateau, the parts makers need something to cheer them on in 1975. *Electronics'* forecast peg the market at \$116 million next year, up from this year's \$110 million. Some producers even think the market could wind up below the 1974 mark. Piher marketing director Javier Garcia-Nieto points out that components sales fell sharply during the last four months of 1974 and probably won't recover until late next year. Unless the recovery comes fast, he sees no chance of getting up to this year's levels.

Belgium

The times are out of joint, and business has boomed in Belgium this year in unusual contrast to downturns in the economic fortunes of her two biggest trading partners, West Germany and Holland.

But Belgium's turn will come in 1975, the country's economy watchers generally predict. This year's real growth in the gross national product has been about 4.6%, while the figure is expected to slide to 3% next year. The nominal GNP checks out at roughly \$54.5 billion for 1974 and is expected to reach \$62.7 billion next year, but those figures are distorted by inflation—something like 16% this year.

It all points to an adequate year—not much more—for Belgian electronic-equipment markets. "Everyone is being careful about their purchases," says Henri van Gysel, a marketing executive at Manufacture Belge de Lampes et de Matériel Electronique (MBLE), a Philips affiliate. Next year's equipment markets should total \$642 million, according to the *Electronics* survey. That's 12% above the estimated \$571 million for 1974. But, as always, price rises mask the real gains.

There's not much doubt over which sector of electronics will move up sharply next year. Wages are rising between 16% and 20% annually because practically everyone is covered by an escalator clause that ties wages to a consumer-price index. That is pushing industrialists to invest heavily in labor-saving automation gear. Also, the energy crisis has touched off a number of new nuclear power plants to come on line over the next few years. The upshot is a projected spurt of 31% for industrial electronics, to \$76 million.

Observers disagree over the outlook for consumer electronics, and particularly color-TV receivers. Color-set sales this year have run higher than expected—between 230,000 and 250,000 sets instead of the expected 200,000.

One school of thought has it that the market can't go much higher than 250,000 sets in 1975. A more bullish school ties its optimism to the fact that market saturation point is still far off in Belgium; its adherents believe the boom will be back after a slow first quarter and that next year's sales will top 300,000 units. *Electronics'* consensus forecasts has next year's sales at just over \$142 million, up from \$118 million this year. That would

carry the whole entertainment-electronics sector to about \$240 million.

However the set makers fare, operators of cable-TV systems seem set for solid growth once more. Belgium is farthest along with cable-TV in Western Europe with about 600,000 of the country's 2.5 million set owners wired in. Another 250,000 sets may be added next year by the country's 40-odd cable-TV companies.

All the same, spending for cable-TV equipment will drop next year. Most systems already have their active equipment installed. Adding subscribers is mainly a matter of hooking them up. But the cable people will spawn other business for communications-equipment builders. The government telecommunications agency, RTT, is moving ahead with a microwave-cable network to feed telecasts from neighboring countries and Great Britain to cable-TV operators throughout Belgium.

RTT spending for traditional telecommunications networks probably will rise next year. That's a turnabout from this year when the agency had its credits cut 20% as part of the government's antiinflation program. For 1975, RTT is figured for a "normal" increase—about 5% over the original 1974 level; "but we could be cut back again," warns an official of the agency.

Any shortcomings at the RTT next year should be offset partly by orders for military equipment. To be sure, the avionics companies are counting on fallout from the upcoming buy of 115 lightweight fighters to replace the aging F-104 Starfighters, but it may not come in time to help 1975 business much. Belgium has joined Denmark, Holland, and Norway to buy some \$2 billion worth of fighters from among the competing French Dassault Mirage F-1, the Swedish Viggen, the General Dynamics YF-16, and the Northrop YF-17. It looks as if it will be mid-year or later before the choice can be made. But already some advance fallout has come as France and the U. S. maneuver for the business, billed as the arms order of the century.

As it was last year, there's a long list of military equipment coming out of the shops now, or about to. Among others, MBLÉ has sizable orders from the Belgian and Dutch navies for fire-control displays on four frigates, from the Belgian Army for \$12.5 million in gear for two Epervier drone systems, and from NATO for Sea Sparrow hardware. Sabca, an aircraft producer, expects to get into production next year on laser-guided-missile systems for 120 Leopard tanks.

BELGIAN ELECTRONICS MARKETS FORECASTS
(IN MILLIONS OF DOLLARS)

	1974	1975
Assembled equipment, total	570.9	642.4
Consumer products	210.8	240.0
Computers	153.0	167.1
Communications	115.9	124.2
Industrial electronics	58.0	75.6
Test and measuring	18.2	19.2
Medical electronics	15.0	16.3
Components	189.9	194.7

Exchange rate: \$1 = 38 francs

Switzerland

There's more to Switzerland—luckily for the Swiss economy—than farmers making cheese in Alpine huts and gnomes making money in Zurich banks. An industrious throng of skilled craftsmen peoples the country's factories, and their specialty products—like precision machinery, watches, and quality chemicals—have carried the economy this year, largely through surprisingly high exports.

Even so, the Swiss seem headed into what is, for them, strange territory: a plateau of zero economic growth. At an estimated \$48.5 billion, the country's gross national product this year, when adjusted for double-digit inflation, is only slightly more than 1% above last year's figure. Economists figure that next year's GNP growth will slip closer to zero as the government holds to an anti-inflation program that has hit construction particularly hard and has curbed capital investments.

So it seems that Swiss electronic-equipment suppliers will be in for a staid, yet far from disastrous, year. *Electronics'* survey points to equipment markets totalling just over \$527 million in 1975. That works out to 10% rise over the 1974 estimate of \$480 million.

TV-set makers next year might get the feeling they're dragging a cog-railway car uphill. "There's no external stimulant like the Olympic Games or the World Cup," says one market researcher of color-TV prospects, "so the growth rate has to slow." There's some hope for growth in hi-fi equipment and radio receivers. All told, however, entertainment-electronics sales are pegged to edge up only a little, to \$163 million next year from this year's \$154 million.

As for communications-equipment makers, they are not expecting too much either. The Swiss postal and telecommunications ministry will be working under an austerity budget again next year. And avionics producers are still waiting for the fallout that will come when the government finally orders the 60 to 80 jet fighters it has been mulling over since 1967. Time will force a decision; it may come next year. At year's end the leading contender seems to be the Northrop F-5 Tiger.

Almost by default, computers are the market leaders. *Electronics'* survey sees a rise from \$169 million this year to better than \$191 million next. The bulk of the business, according to one computer company, is now coming from old customers upgrading their original systems. And a computer marketing manager predicts a shift to smaller-scale installations over-all. "Everybody is becoming a lot more price-conscious," he explains.

There will be some new systems business, however. The city of Zurich, for example, has decided to buy a Honeywell-built model 6060 for an integrated management system. And the post office is still moving ahead—albeit slowly—with a plan to computerize telephone operations. When finally installed, over the next several years, this will be a \$75 million investment.

Components suppliers are in for a modest 8.5% lift to \$128 million next year from this year's \$118 million, according to the survey. The numbers are not sensational, but the components sector bears watching; a couple of

SWISS ELECTRONICS MARKETS FORECASTS
(IN MILLIONS OF DOLLARS)

	1974	1975
Assembled equipment, total	479.2	527.3
Consumer products	153.6	162.5
Computers	168.9	191.9
Communications	80.5	90.3
Industrial electronics	42.8	46.8
Test and measuring	18.3	19.8
Medical electronics	15.1	15.9
Components	117.8	128.1

Exchange rate: \$1 = 2.9 francs

big Swiss companies plan to give the country some independence from the U.S. semiconductor houses, which now supply most of the integrated circuits and digital displays to Swiss electronic-watch makers.

Ebauches SA, whose output of some 2.5 million electronic movements this year makes it the front-runner in that field in Switzerland, says it plans to set up its own IC plant, perhaps breaking ground for it next year. There's talk that Ebauches may take on an American partner for the venture.

The second company on the move is Brown, Boveri & Cie, Switzerland's largest electrical/electronics outfit. The company went into pilot-line production of liquid-crystal displays this year at a new plant. Company officials say the facility will go into mass production during 1975, building up to an annual output of several hundred thousand pieces. Orders are already in, the company says, from all over the world. Its liquid-crystal display is a field-effect type that gives a dark image on a light background at very low voltage.

Denmark

Official economy watchers around Copenhagen these days are mostly melancholy Danes, and with reason. For starters, there's continued political instability with a minority government. The inflation rate is close to 20%, unemployment has shot past 8%, and the payments deficit doubled this year to about \$1 billion. And, if not already there, Denmark is heading into recession.

Ordinarily, a soft home market does not impact too heavily on Danish electronics producers. They're heavy

exporters—so much so that this year's \$335 million of sales abroad adds up to more than the totals for beer, furniture, and ships combined. But what's happening in Denmark is happening in most other Western countries. "We'll have some slowdown in growth," says Frede Ask, director of the country's electronics producers' association. This year's output totaled \$430 million, some 10% above the 1973 level. The 1975 gain probably will be just a few percentage points.

Nonetheless, some Danish electronics companies expect to see their sales figures move out strongly again next year. For example, Mogens Andersen, marketing manager for Soren T. Lyngso, expects industrial-automation systems will climb close to 25%, and the company predicts a strong market for its process-oriented STL 250 microcomputer, built around an Intel 8008 chip. At Christian Rovsing A/S, the company has a strong backlog of orders from big international organizations like ESRO and CERN, among others. It has interesting new hardware, too, such as its fast preprocessing computer for signal handling. At A/S Regnecentralen, Denmark's computer maker, the word is that the RC 3600 data-communications support system is "selling like hotcakes." Danish hearing-aid producers expect their worldwide markets will hold next year, too, particularly if the United Kingdom goes through with its plan to give away hearing aids through its health service.

Companies that concentrate on the Danish home market obviously can't count on much. *Electronics'* survey puts the 1975 market for assembled equipment at just under \$410 million. That's an 11% climb, but is well below the inflation rate. Entertainment electronics still remains a key market, checking in at \$190 million for 1975. A sharp falling-off in the growth of color-TV sales looks inevitable, but it has been much better than expected this year to reach roughly \$80 million. But next year's rise will carry the sector only a little past \$91 million. Industrial electronics and computers, then, seem to be poised to make the strongest gains.

As for components suppliers, they face a slow year. The consensus figures predict a market of \$105 million next year, 7% above the 1974 level. Even this forecast could be high in light of recent cutbacks in production plans.

Norway

The tremendous oil reserves under the sea off Norway's fjord-studded coast apparently assure affluence for this small country for years to come.

Just the start of the job of getting the oil to market has brought boom times to Norway. There's inflation, to be sure, and cash flow is a problem for a lot of businesses. "But the overall mood is optimistic," reports Gustav A. Ring, whose intercom company sells to a wide spectrum of Norwegian business.

It's not hard to spot the electronics sectors where oil-drilling operations are spurring sales. Platform-shore communications, data-logging, and dynamic-positioning come immediately to mind. The standout commercial prize to date, though, has gone to Japan's Mitsubishi Electric and Fujitsu Ltd. They have won a

DANISH ELECTRONICS MARKETS FORECASTS
(IN MILLIONS OF DOLLARS)

	1974	1975
Assembled equipment, total	369.0	409.0
Consumer products	173.7	189.8
Computers	89.1	100.8
Communications	58.8	62.5
Industrial electronics	30.0	37.1
Test and measuring	9.1	9.9
Medical electronics	8.3	8.9
Components	97.6	105.5

Exchange rate: \$1 = 5.95 kroner

NORWEGIAN ELECTRONICS MARKETS FORECASTS
(IN MILLIONS OF DOLLARS)

	1974	1975
Assembled equipment, total	261.4	300.0
Consumer products	84.0	98.5
Computers	77.4	86.6
Communications	53.0	60.4
Industrial electronics	23.5	26.9
Test and measuring	12.3	14.3
Medical electronics	11.2	13.3
Components	62.1	67.8

Exchange rate: \$1 = 5.5 krone

contract worth about \$9 million to build the first phase of a satellite-communications system that will link drilling platforms to a ground station in southwest Norway through an Intelsat satellite.

Norwegian electronics companies that don't make equipment for oil company use have mixed feelings about the North Sea oil. The country's electronics producers export close to 40% of their output, and they worry that the oil boom will lift costs and salary levels so high that Norwegian electronics products won't stay competitive. There's the worry, too, that there will be a shift of intellectual resources to the oil industry.

So far, though, none of these fears have materialized. Norwegian electronic-equipment producers last year turned out some \$261 million worth of equipment, and there's something around 20% growth in sight for this year. Exports are holding up. Ring has sold its Garex radio-communications-switching equipment to customers ranging from Saudi Arabia to New Zealand, for example. Nera A/S bid jointly with RCA but missed out on the first phase of the oil-field satellite-communications system at home. However, it continues to pick up orders for its microwave links from as far off as Latin America and the Middle East.

The home market too, looks healthy, and *Electronics* forecasts 1975 electronic equipment sales of \$300 million, up 15%. Worth noting on the forecast chart is the spurt in color-TV sales—up 31% next year to \$47 million. At first glance, that might seem due to the official start of colorcasts next Jan. 1. Actually, it's mainly nothing more than a burgeoning market in a booming economy: there have been "experimental" colorcasts since 1971 and some 60% of Norwegian TV programs already are in color.

Strong prospects both at home and abroad make for a climate that fosters new companies, and a couple of interesting new arrivals came along this year. By joining forces to set up United Marine Electronics, Nera and the L M Ericsson subsidiary A/S Elektrisk Bureau became joint owners of what they call the world's largest marine-radio company. Elektro-Union, Norway's largest electrical/electronics combine, has backed electronics engineer Lars Monrad-Krohn in a firm called Data Industri A/S. Monrad-Krohn, formerly of Norsk Dataelektronikk A/S, expects to sell more than 1,000 of his Mycro-One microcomputers built around Intel 8080 chips, throughout Europe next year.

Finland

Finland is a land of extremes as far as *Electronics*' annual survey goes. Next year's total market for equipment adds up to just under \$260 million, and that puts Finland at the bottom of the list by market size. But with markets that are predicted to rise by 17.5%, Finland is at the top of the list for growth.

The 17.5% spurt will come despite a fairly stiff set of problems for the economy. Real growth sagged from last year's 6% to 3.5% this year, and there's a further slide to 3% in view for 1975. Inflation will drop a little next year but still remain in the low teens. And there will be the mounting deficit in the balance of payments to fret over.

For all this, electronic-equipment suppliers are reasonably confident about 1975. Entertainment-electronics sales should run particularly strong, largely because the government is expected to ease its restrictions on imports of consumer durables. The survey spots the market at just above \$101 million, up 23% over 1974. Color-TV sets, hi-fi equipment, and radios are predicted to provide the main push here.

The outlook abroad

With this kind of potential growth at home, only export markets could give the country's set makers troubles. The largest of them, Salora OY, alone produces about twice as many color-TV sets as the Finnish market consumes. Salora insists it is ready for the year ahead, with its entire planned production sold out. Even if its major British customer, Granada TV Rentals, cuts back on deliveries, Salora officials say, they can compensate easily in Sweden or in new markets like Australia.

What's more, the government plans to invest some \$5.7 million over the next two or three years to set up a color-tube plant with an initial capacity of 300,000 tubes a year—probably precision in-line types. The idea is to cut down imports of tubes. Salora, which put a TV-components subsidiary into operation this year, will be a minority partner in the venture, and OY Nokia AB may join in, too. Salora also is toying with the idea of going into production of consumer-grade semiconductors, including linear ICs for TV sets. □

FINNISH ELECTRONICS MARKETS FORECASTS
(IN MILLIONS OF DOLLARS)

	1974	1975
Assembled equipment, total	220.3	259.4
Consumer products	82.6	101.5
Computers	66.0	74.8
Communications	25.3	28.3
Industrial electronics	24.7	28.4
Test and measuring	6.0	7.3
Medical electronics	15.7	19.1
Components	88.5	104.2

Exchange rate: \$1 = 3.8 marks

Reprints are available at \$4 each. Write Electronics Reprints Department, P.O. Box 669, Hightstown, N.J. Copyright 1974 Electronics, a McGraw-Hill publication.

European 1975 components markets

	Belgium		Denmark		Finland		France		Italy		Netherlands		Norway		Spain		Sweden		Switzerland		United Kingdom		West Germany		Total	
	1974	1975	1974	1975	1974	1975	1974	1975	1974	1975	1974	1975	1974	1975	1974	1975	1974	1975	1974	1975	1974	1975	1974	1975	1974	1975
Passive and electromechanical, total	89.1	94.9	63.2	67.5	48.0	56.7	555.4	601.9	149.5	158.0	110.3	117.9	34.0	36.4	55.8	59.3	120.4	131.9	73.9	80.0	485.7	514.1	998.0	1,003.8	2,783.3	2,922.4
Capacitors, fixed	17.1	17.8	11.8	12.8	8.0	9.1	96.9	102.1	45.4	46.7	19.6	20.4	6.5	6.9	19.0	20.0	31.4	33.7	15.2	15.5	109.5	114.2	250.0	250.0	630.4	649.2
Capacitors, variable	1.7	1.8	1.1	1.3	0.6	0.6	4.8	4.8	2.4	2.4	1.7	2.0	0.5	0.5	3.0	3.0	1.2	1.4	1.0	1.0	8.1	8.1	19.2	18.5	45.3	45.4
Connectors, plugs, and sockets	5.1	5.6	3.7	4.0	3.3	3.9	72.9	76.0	14.8	18.5	7.0	7.2	2.6	2.8	4.2	4.5	8.2	8.8	6.2	7.4	74.5	81.5	100.0	107.7	302.5	327.9
Filters, networks, and delay lines	2.0	2.0	2.5	2.8	1.1	1.3	10.8	11.4	2.2	2.4	2.0	2.1	0.5	0.6	0.5	0.5	4.6	5.1	1.2	1.2	10.0	10.7	15.4	16.1	52.8	56.2
Loudspeakers (OEM type)	5.0	5.4	8.4	9.2	3.4	4.2	12.5	13.9	6.1	6.0	4.9	4.9	2.2	2.5	2.2	2.3	6.3	6.7	0.9	0.9	18.2	19.8	26.9	27.3	97.0	103.1
Microphones (OEM type)	1.1	1.2	1.8	1.9	0.1	0.1	2.3	2.3	1.0	1.1	1.1	1.2	0.1	0.1	0.5	0.6	1.5	1.6	0.4	0.5	3.7	4.2	13.5	14.6	27.1	29.4
Potentiometers, composition	3.4	3.6	4.2	4.5	2.6	3.1	12.5	13.1	9.6	10.1	5.3	5.7	1.8	2.0	4.0	4.1	7.0	8.2	1.7	1.8	18.6	19.1	71.1	65.4	141.8	140.7
Potentiometers, wirewound	0.8	0.9	0.8	0.9	0.4	0.5	8.3	8.5	1.1	1.2	1.2	1.3	0.4	0.4	0.7	0.8	0.9	1.0	0.6	0.6	14.0	14.0	17.3	17.3	46.5	47.4
Power supplies (OEM type)	6.6	7.4	2.0	2.1	0.1	0.1	32.3	34.2	3.2	3.4	9.0	9.8	1.9	2.0	2.2	2.4	4.6	4.9	3.1	3.5	30.7	32.6	53.8	61.5	149.5	163.9
Printed circuits	12.4	13.7	3.7	4.0	2.9	3.4	93.7	109.4	16.3	17.0	15.8	17.7	2.6	2.7	1.9	2.2	4.6	5.6	12.7	14.5	30.3	36.1	69.2	65.4	266.1	291.7
Quartz crystals (includes mounts and ovens)	1.8	1.8	1.5	1.7	0.6	0.8	10.4	11.7	2.4	2.6	2.2	2.4	1.1	1.3	1.1	1.2	3.0	3.5	2.2	2.6	11.4	11.6	15.4	16.5	53.1	57.7
Readout devices	1.1	1.4	0.7	0.8	0.4	0.5	6.0	6.9	1.0	1.1	—	—	0.4	0.4	0.1	0.5	0.6	0.7	0.9	1.2	3.5	4.0	10.0	11.2	24.7	28.7
Relays (for communications and electronics)	6.4	6.7	4.4	4.7	0.6	0.7	50.0	53.1	12.1	12.4	12.3	13.3	3.4	3.6	5.0	5.3	14.4	15.6	5.9	5.9	38.4	40.8	72.3	73.1	225.2	235.2
Resistors, fixed	8.5	8.7	4.0	4.4	2.2	2.5	51.0	55.0	10.1	10.1	9.5	10.2	2.5	2.6	3.1	3.3	9.3	10.5	6.5	6.9	34.9	34.9	103.8	100.0	245.4	249.1
Resistors, nonlinear	0.9	1.0	0.5	0.5	0.4	0.5	7.3	7.9	1.0	1.0	1.2	1.2	0.3	0.3	1.2	1.3	1.2	1.2	0.7	0.7	8.1	7.7	10.0	10.0	32.8	33.3
Servos, synchros, and resolvers	0.9	1.0	0.5	0.6	2.9	3.4	8.3	9.2	2.2	2.5	1.5	1.6	0.5	0.6	1.0	1.0	1.3	1.4	2.7	3.1	16.8	18.2	29.0	28.0	67.6	70.6
Transformers, chokes, coils, TV yokes and flybacks	4.7	4.9	3.7	2.9	9.2	11.0	25.0	28.5	3.8	4.0	5.8	6.2	2.2	2.4	1.6	1.6	7.5	8.1	4.8	4.8	17.7	18.9	46.1	48.1	132.1	141.4
Semiconductors, discrete, total	17.2	16.0	11.0	12.1	11.0	12.7	116.9	114.7	57.5	57.6	20.9	20.0	9.2	9.9	17.7	19.4	20.2	19.7	17.9	18.4	124.8	129.1	319.6	315.4	743.9	745.0
Microwave diodes, all types (above 1 GHz)	0.3	0.4	0.2	0.2	0.1	0.1	2.5	2.3	1.4	1.7	0.6	0.6	0.3	0.3	0.2	0.3	0.4	0.4	0.4	0.4	2.1	2.1	3.1	3.1	11.6	11.9
Rectifiers (and diodes rated more than 100 mA)	2.1	2.2	2.4	2.5	3.1	3.6	18.7	19.4	9.5	10.1	2.6	2.7	1.2	1.3	4.1	4.3	4.6	4.9	2.1	2.2	21.0	21.0	42.3	45.0	113.7	119.2
Signal diodes (rated less than 100 mA)	2.8	1.0	1.0	1.8	0.7	0.8	9.4	8.3	3.7	3.7	3.4	3.5	0.9	0.9	2.3	2.6	2.0	1.7	2.1	2.2	7.5	7.0	30.8	30.8	66.6	64.3
Thyristors (SCRs, four-layer diodes, etc.)	1.8	1.9	0.7	0.7	0.7	0.8	11.4	12.5	4.4	4.6	2.4	2.6	0.6	0.7	1.3	1.5	1.7	1.7	2.6	2.7	10.7	11.0	33.8	35.8	72.1	76.5
Transistors, power (more than 1-W dissipation)	3.0	3.1	1.8	2.0	2.5	2.9	23.9	24.6	13.3	14.2	3.8	3.8	1.6	1.8	1.7	1.8	3.5	3.8	3.4	4.1	28.0	32.6	57.7	58.5	144.2	153.2
Transistors, small-signal (includes FETs and duals)	6.3	6.4	4.1	4.0	3.3	3.8	40.6	36.5	20.5	18.5	7.0	5.7	3.8	4.0	6.4	6.9	6.5	5.8	6.5	6.0	46.6	46.6	118.5	109.6	270.1	253.8
Tuner varactor diodes	0.3	0.3	0.2	0.2	0.1	0.1	3.3	3.9	2.2	2.2	0.3	0.3	0.2	0.2	0.6	0.7	0.5	0.5	0.2	0.2	1.9	1.6	14.4	13.8	24.2	24.0
Zener diodes	0.6	0.7	0.6	0.7	0.5	0.6	7.1	7.2	2.5	2.6	0.8	0.8	0.6	0.7	1.1	1.3	1.0	0.9	0.6	0.6	7.0	7.2	19.0	18.8	41.4	42.1
Semiconductors, integrated circuits, total	13.0	13.1	7.9	8.4	4.6	5.6	93.7	96.8	35.7	41.7	17.4	17.6	5.3	6.9	6.6	7.9	16.6	19.4	14.0	17.8	99.0	105.5	195.7	211.7	509.5	552.4
Hybrid ICs, all types	0.9	1.0	0.7	0.7	0.4	0.5	9.4	9.8	3.7	4.0	2.6	2.9	0.4	0.4	1.2	1.3	1.3	1.9	1.7	2.4	13.5	14.7	19.2	21.1	55.0	60.7
Linear ICs (except op amps)	1.6	1.7	1.8	1.9	1.8	2.2	14.5	15.4	10.4	11.9	2.0	2.2	0.9	0.9	1.1	1.3	2.3	2.8	1.7	2.2	23.5	25.5	61.5	63.5	123.1	131.5
Logic circuits, bipolar	3.9	3.8	2.3	2.0	0.6	0.8	34.5	30.4	10.4	11.0	5.3	4.9	1.3	2.2	1.8	2.0	5.3	5.1	2.7	2.2	23.5	25.5	60.0	58.8	151.6	148.7
Logic circuits, MOS and C-MOS	1.1	1.2	0.2	0.3	0.4	0.5	6.2	9.4	1.6	1.9	1.5	1.6	0.7	0.9	0.5	0.5	0.9	1.7	1.5	2.5	5.1	9.3	10.4	15.4	30.1	45.2
Memory circuits, bipolar	0.2	0.1	0.2	0.3	0.1	0.1	2.9	2.5	1.3	1.8	0.8	0.9	0.5	0.6	0.7	0.9	0.8	1.0	0.4	0.5	2.3	2.8	4.1	4.5	14.3	16.0
Memory circuits, MOS and C-MOS	1.1	0.9	1.0	1.1	0.6	0.7	15.0	16.7	4.7	6.2	3.2	3.0	1.3	1.5	0.4	0.5	3.8	4.0	0.7	1.0	17.5	15.6	20.0	23.5	69.3	74.7
Microprocessors (includes CPU, memory, and I/O chips)	*	*	*	0.1	*	*	0.4	1.2	0.2	0.4	0.1	0.1	*	*	0.5	0.6	0.3	0.7	0.3	0.7	0.4	0.5	0.9	1.8	2.8	5.5
Op amps, monolithic	0.9	1.0	0.4	0.5	0.2	0.2	5.6	5.2	1.5	1.5	1.9	2.0	0.2	0.3	0.3	0.4	0.7	0.9	0.9	1.1	5.0	2.3	11.9	13.5	29.5	28.9
Special-purpose circuits, bipolar and MOS (includes calculator and timepiece chips)	3.3	3.4	1.3	1.5	0.5	0.6	5.2	6.2	1.9	3.0	—	—	*	*	0.6	1.0	1.0	1.4	4.1	5.2	8.2	9.3	7.7	9.6	33.8	41.2
Semiconductors, optoelectronic, total	1.0	1.2	0.5	0.6	0.4	0.5	5.0	5.8	2.3	3.0	1.3	1.5	0.2	0.2	0.4	0.8	0.4	0.6	0.6	0.8	13.9	16.3	16.9	19.4	42.9	50.7
Circuit elements (photoconductive cells, photodiodes, phototransistors, isolators, etc.)	0.9	1.0	0.2	0.2	0.2	0.2	2.9	3.4	1.8	2.2	1.1	1.3	0.1	0.1	0.2	0.3	0.2	0.3	0.4	0.5	8.1	9.3	9.2	10.8	25.3	29.6
Indicating devices (light-emitting diodes, LED arrays, etc.)	0.1	0.2	0.3	0.4	0.2	0.3	2.1	2.4	0.5	0.8	0.2	0.2	0.1	0.1	0.2	0.5	0.2	0.3	0.2	0.3	5.8	7.0	7.7	8.6	17.6	21.1
Tubes, total	69.6	69.5	15.0	16.9	24.5	28.7	190.0	199.2	91.7	97.6	21.7	19.2	13.4	14.4	29.3	28.7	42.8	45.6	11.4	11.1	246.9	252.8	409.9	410.6	1,166.2	1,194.3
Cathode-ray tubes (except for TV)	0.1	0.1	0.3	0.4	0.3	0.4	4.2	4.6	2.0	2.2	2.0	2.2	0.1	0.2	0.6	0.7	0.7	0.7	0.4	0.4	11.6	12.8	4.6	5.4	26.9	30.1
Image and light-sensing tubes	0.9	1.0	0.4	0.4	0.3	0.4	8.3	8.7	3.0	3.2	1.3	1.2	0.1	0.1	0.2	0.2	0.7	0.7	1.4	1.5	14.					

European 1975 equipment markets

Factory sales in millions of U.S. dollars

Note: Estimates in this chart are based on inputs obtained mostly in September and October 1974 and reflect the outlook for 1975 at that time. Some of the nearly 200 sources who supplied data have since revised their market forecasts.

The figures show consensus estimates for consumption of equipment in each country whether produced there or not. Imports are valued at landed cost. Participants were asked to value markets at factory prices in current local money or to specify the exchange rate used for estimates in dollars. All estimates were first computed in local currency and then converted into dollars using the rates shown below for both 1974 and 1975. Because of fluctuations in exchange rates and some differences in categories, estimates in this chart should not be compared with those published in previous years without correcting for these changes.

The rates for this chart (per U.S. \$1)

Belgium, 38 francs
Denmark, 5.95 kroner
Finland, 3.8 marks
France, 4.8 francs
Italy, 675 lire
Netherlands, 2.65 guilders
Norway, 5.5 krone
Spain, 58 pesetas
Sweden, 4.35 krona
Switzerland, 2.9 francs
United Kingdom, 43 pence (£1 = \$2.33)
West Germany, 2.6 marks

¹Includes stand-alone minicomputers but not computers that are integral parts of process-control and like systems.

²Electronic or semi-electronic

*Less than \$75,000

	Belgium		Denmark		Finland		France		Italy		Netherlands		Norway		Spain		Sweden		Switzerland		United Kingdom		West Germany		Total		
	1974	1975	1974	1975	1974	1975	1974	1975	1974	1975	1974	1975	1974	1975	1974	1975	1974	1975	1974	1975	1974	1975	1974	1975	1974	1975	
Consumer, total	210.8	240.0	173.7	189.8	82.6	101.5	801.0	851.4	281.3	306.6	322.4	352.9	84.0	98.5	215.0	274.7	396.5	391.3	153.6	162.6	1,404.1	1,451.7	2,138.4	2,278.9	6,263.4	6,699.9	
Audio tape recorders and players	17.1	17.1	21.0	21.8	8.2	11.3	92.1	96.2	24.4	26.7	22.6	26.0	10.0	12.2	17.0	20.0	29.9	32.2	17.2	19.3	104.8	114.2	169.2	163.5	534.5	560.5	
Hi-fi equipment (meets DIN 45500 standard)	15.5	17.9	35.3	38.1	8.7	12.6	72.9	76.0	8.8	10.4	32.8	34.7	18.2	20.0	10.0	12.0	42.5	46.0	14.5	16.5	40.8	46.6	215.4	230.8	515.4	561.6	
Phonographs and phonoradio combinations	4.7	5.0	4.7	4.8	5.3	6.6	45.8	50.0	28.1	31.1	16.1	17.0	3.3	3.3	15.0	16.0	14.9	13.8	10.0	11.0	163.1	177.1	76.9	80.8	387.9	416.5	
Radios (includes car radios)	21.0	22.4	16.0	17.6	10.5	13.1	96.9	100.0	41.5	44.4	35.8	33.4	9.1	9.1	22.0	24.0	20.7	21.8	15.0	14.1	121.2	130.5	269.2	276.9	678.9	707.3	
Radio recorders	13.1	15.8	4.2	5.0	6.8	7.9	20.4	22.9	9.6	11.8	13.2	15.8	1.3	1.5	5.0	5.7	17.2	20.0	7.6	9.3	70.2	93.2	111.5	126.9	280.1	335.8	
TV sets, black-and-white	21.0	19.7	11.8	10.9	10.5	10.5	139.6	141.7	145.2	148.1	32.1	29.8	5.7	5.1	121.0	132.0	18.4	16.1	11.7	10.3	88.5	74.6	238.5	219.2	844.0	818.0	
TV sets, color	118.4	142.1	80.7	91.6	31.6	39.5	333.3	364.6	23.7	34.1	169.8	196.2	36.4	47.3	25.0	65.0	252.9	241.4	77.6	82.1	815.5	815.5	1,057.7	1,180.0	3,022.6	3,300.2	
Communications, total	115.9	124.2	58.8	62.5	25.3	28.3	794.7	921.0	290.9	367.0	86.3	107.4	53.0	60.4	153.8	172.8	155.7	163.8	80.5	90.3	665.6	768.9	613.0	636.8	3,093.5	3,503.4	
Broadcast	—	—	3.4	2.7	1.0	1.0	50.0	52.1	4.3	4.7	1.7	1.9	3.6	4.5	6.0	8.6	6.9	4.6	6.5	6.9	16.3	17.5	11.5	11.1	111.2	115.6	
Cable TV	9.2	7.9	1.0	1.2	0.4	0.7	0.5	0.6	0.1	0.4	—	—	0.9	0.9	*	*	1.6	2.1	0.5	0.6	7.0	8.1	—	—	21.2	22.5	
Closed-circuit TV	4.2	4.7	1.0	1.1	0.7	0.8	13.1	14.2	11.8	13.3	2.9	3.3	0.9	1.1	3.8	5.8	1.1	1.4	2.7	3.0	13.3	14.2	21.1	25.2	76.6	88.6	
Data communications	0.6	1.3	—	—	—	—	37.5	60.4	3.0	3.7	—	—	0.9	1.3	3.8	5.2	3.4	3.7	0.7	1.0	11.2	17.5	11.5	17.3	72.6	111.4	
Intercoms and intercom systems	6.6	7.9	11.4	12.6	0.5	0.5	34.4	39.6	4.4	5.2	9.4	10.2	3.1	3.6	6.8	8.8	11.0	11.9	4.8	5.0	10.7	11.6	28.5	32.7	131.6	149.6	
Microwave relay systems	2.0	2.1	1.7	1.7	3.7	3.9	66.7	68.7	18.5	21.2	3.8	4.1	3.1	2.7	18.0	19.0	5.7	5.7	1.5	1.5	4.7	5.8	34.6	42.3	164.0	178.7	
Navigation aids (except radar)	—	—	10.9	11.9	3.2	3.4	81.2	91.7	59.2	81.5	12.1	12.6	10.9	11.6	13.2	15.0	18.4	18.4	4.1	3.4	120.0	137.5	40.4	42.3	373.6	429.3	
Radar (airborne, ground, and marine)	—	—	6.7	7.2	3.2	3.7	156.2	183.3	51.8	81.5	20.7	22.6	12.7	13.6	15.2	17.4	18.4	18.4	—	—	168.0	191.0	115.4	130.8	568.3	669.5	
Radio communications (except broadcast)	7.4	9.2	14.3	15.1	4.7	5.4	87.5	102.1	41.5	47.4	17.0	18.2	5.4	6.2	15.0	16.5	6.9	8.0	10.3	11.3	174.7	198.0	138.5	142.3	523.2	580.7	
Telephone switching, PABX ²	1.7	1.9	0.2	0.3	—	—	8.3	12.5	—	—	2.5	2.9	0.4	0.4	4.0	4.5	20.7	21.8	0.4	0.4	2.3	4.7	—	—	47.9	58.3	
Telephone switching, public ²	68.4	72.4	1.5	1.7	2.6	3.4	15.6	25.0	—	—	7.0	20.4	1.1	3.6	*	*	46.0	51.7	21.4	27.9	55.9	81.5	—	—	219.5	287.6	
Telephone and telegraph carrier	15.8	16.8	6.7	7.0	5.3	5.5	243.7	270.8	88.9	99.2	9.2	10.0	10.0	10.9	68.0	72.0	15.6	16.1	27.6	29.3	81.5	81.5	211.5	192.3	783.8	811.6	
Computers and related equipment¹, total	153.0	167.1	89.1	100.8	66.0	74.8	1,129.6	1,265.3	471.5	525.9	270.3	307.8	77.4	86.6	198.8	217.8	184.5	207.6	168.9	191.9	673.8	768.7	1,978.3	2,202.7	5,461.2	6,117.0	
Analog and hybrid computers	0.3	0.3	*	*	*	*	2.9	3.4	0.7	0.7	0.7	0.7	0.1	0.1	0.4	0.5	0.7	0.8	0.2	0.3	3.3	3.3	5.4	6.3	14.7	16.4	
Data-processing systems, total	109.4	85.9	47.9	53.6	32.3	35.8	664.2	716.6	199.8	219.4	131.6	141.8	35.0	37.4	102.4	104.5	90.2	95.0	97.2	104.2	325.7	368.2	941.5	1,025.4	2,757.2	2,986.9	
Mini (system value less than \$50k)	5.0	6.6	3.0	3.8	2.0	2.4	35.0	50.0	8.7	12.0	17.1	10.9	6.0	7.8	5.0	6.5	6.4	8.5	10.3	12.5	43.8	56.0	49.2	65.8	181.5	241.9	
Small (\$50k-\$420k)	33.5	36.8	16.0	17.6	5.3	7.9	179.2	187.5	66.7	78.5	26.4	29.0	12.3	12.7	38.0	22.0	10.3	10.6	29.3	29.3	37.3	44.3	223.1	250.0	677.4	726.2	
Medium (\$420k-\$1,680k)	48.7	39.4	17.6	18.8	18.4	18.9	250.0	260.4	87.4	94.8	52.1	65.3	9.3	10.4	53.0	60.0	26.4	29.9	34.5	36.5	139.8	151.4	400.0	423.1	1,137.2	1,199.5	
Large (\$1,680k and up)	2.2	3.1	11.3	13.4	6.6	6.6	200.0	218.7	37.0	34.1	46.0	46.0	7.4	6.5	6.4	16.0	47.1	46.0	23.1	26.9	104.8	116.5	269.2	286.5	761.1	819.3	
Add-on memories (core and semiconductor)	3.7	4.2	3.4	4.5	1.7	1.7	22.9	26.0	14.8	14.8	6.8	8.7	1.6	1.8	5.0	5.6	5.0	5.7	4.1	5.2	37.3	40.8	84.6	92.5	190.9	211.5	
Data-entry and data-output peripherals	16.7	22.4	11.8	12.6	7.9	9.2	116.7	141.0	74.1	89.6	35.8	40.0	7.8	8.2	22.0	26.0	13.8	16.5	23.1	28.6	58.2	65.2	230.7	250.0	618.6	709.3	
Data-storage equipment	30.5	38.1	20.2	22.5	14.5	15.5	229.2	260.0	37.0	37.0	53.6	58.4	13.1	13.6	43.0	49.0	34.5	36.8	37.9	45.5	130.5	139.8	461.5	515.0	1,105.5	1,231.2	
Data-terminal equipment	8.9	11.8	5.4	7.2	5.3	7.4	93.7	118.3	44.4	54.8	17.0	20.6	6.0	8.2	11.0	13.0	12.6	13.8	5.5	6.9	69.9	93.2	57.7	73.1	337.4	428.3	
Electronic calculators, desk type	2.5	3.0	—	—	—	—	—	—	71.1	77.0	9.4	13.2	9.1	10.2	11.0	13.0	17.2	19.5	—	—	{ 48.9	{ 58.2	{ 192.3	{ 230.8	{ 399.5	{ 476.1	
Electronic calculators, portable	—	—	—	—	—	—	—	—	14.8	17.8	6.0	10.2	4.5	6.9	4.0	6.0	4.8	5.7	—	—	—	—	—	—	—	—	
Point-of-sale equipment	1.0	1.4	0.4	0.4	0.4	0.6	—	—	14.8	14.8	9.4	15.1	0.2	0.2	0.2	0.2	5.7	13.8	0.9	1.2	—	—	4.6	9.6	37.4	57.3	
Industrial, total	58.0	75.6	30.0	37.1	24.7	28.4	182.6	187.3	143.8	172.1	95.1	107.9	23.5	26.9	38.1	46.1	56.2	63.1	42.8	46.8	266.1	275.3	431.8	479.1	1,392.7	1,545.7	
Machine-tool controls	2.0	2.1	1.5	1.7	0.8	1.0	10.6	10.0	11.8	13.3	1.6	1.7	1.8	2.1	2.5	2.9	2.3	2.6	5.0	5.3	11.6	12.1	21.5	23.1	73.0	77.9	
Photoelectric controls	0.6	0.7	0.5	0.6	0.2	0.2	3.1	2.7	1.5	1.6	1.0	1.0	2.1	2.2	0.9	1.2	1.3	1.4	1.4	1.4	14.9	14.9	25.8	27.7	53.3	55.6	
Pollution-monitoring	2.6	11.8	—	—	—	—	2.9	3.1	—	—	—	—	—	—	1.5	3.1	—	—	—	1.0	1.2	5.1	5.8	—	—	17.8	30.3
Power electronics	2.2	2.4	0.8	0.9	2.0	2.3	11.4	12.5	6.5	8.0	3.4	3.8	1.3	1.4	2.1	2.5	2.6	3.0	1.9	2.1	68.0						

Monroe announces the world's most powerful hand-held computer.

More program power.

Over 50,000 program steps on tape plus internal storage.

More storage power.

Over 4,000 registers on tape plus internal storage.

More keyboard power.

Over 100 hard-wired functions directly accessible from the keyboard.

More sub-routine power.

Unlimited with symbolic addressing.

More metric conversion power.

Unlimited Metric/English conversions.

More simplicity.

Fully algebraic operation.

More equation power.

Nested parentheses up to 4 levels.

More portable power.

Ready for use with either rechargeable batteries or AC current.

More available power.

See the 326 or the printing model 325 in your office today. Just call Monroe in any of 365 cities in the United States and Canada.

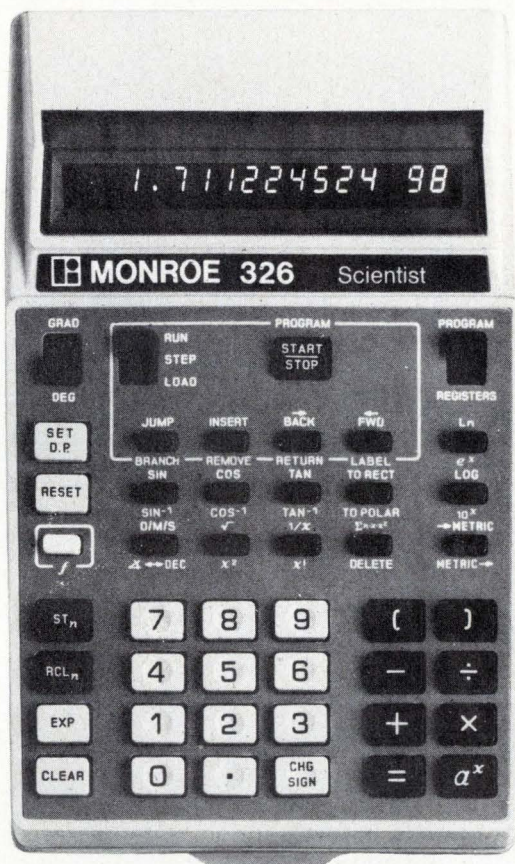

More calculators for business.
More calculators for engineering.
More calculators for science.
More desk-top computers.
More service centers.

MONROE
The Calculator Company.

No other company has more.

Monroe, The Calculator Company
 550 Central Avenue,
 Orange, New Jersey 07051

- I'd like more information.
 Have a representative call.
- Send me complete information
 on your line by return mail.

Name _____
 Company Name _____
 Address _____
 City _____ State _____ Zip _____
 Phone _____

E



Syntron Semiconductor Sales Organization

ARIZONA
Fryco, Engineering Reps.
Scottsdale
(602) 945-3281

CALIFORNIA
Carl E. Holmes Co.
Los Angeles
(213) 256-2255

COLORADO
Gossard & Associates
Denver
(303) 985-0602

FLORIDA
L. Haas Co., Inc.
North Miami Beach
(305) 949-9143
(305) 949-5157

ILLINOIS
Syntron Chicago Sales Co.
Hinsdale
(312) 325-3250

INDIANA
Seawood Sales, Inc.
Montgomery
(513) 793-6702

MARYLAND
Callas Electronics, Inc.
Baltimore
(301) 744-7711

MASSACHUSETTS
Garrettson Co., Inc.
Needham
(617) 449-2640

MICHIGAN
L. H. Dickelman
Detroit
(313) 255-3300

MINNESOTA
Northport Engineering Inc.
St. Paul
(612) 698-3841

MISSOURI
Harlan J. Weisler & Associates
St. Louis
(314) 428-3934

NEW JERSEY
Syntron Newark Sales Co.
Hasbrouck Heights
(201) 288-1845

NEW YORK
J. Lazor Associates
Penfield
(716) 473-8337

NORTH CAROLINA
Jake Rudisill Associates, Inc.
Charlotte
(704) 377-6901

OHIO
Allen Nace Co., Inc.
Brecksville
(216) 526-4323

PENNSYLVANIA
W. Reeves Associates, Inc.
Media
(215) 566-6709

TEXAS
Palatine Sales, Inc.
Richardson
(214) 231-9489

WASHINGTON
Bergford & Associates
Olympia
(206) 866-2001

WISCONSIN
Syntron Semiconductor Sales Co.
Milwaukee
(414) 273-6773

Syntron Power Thyristors

Syntron Thyristors (SCRs) are diffused, three junction, semiconductor units designed for medium and high power solid state control applications.

Available in the popular standard JEDEC configurations from 25 amps rms to 850 amps rms with V_{80} ratings to 1600 volts and transient ratings to 2000 volts, these Thyristors exhibit the same reverse voltage avalanche characteristics found in all Syntron silicon diodes.

In a single element application, they can be used for direct conversion and continuous control of AC to DC power requirements or they can be used as a DC switch to initiate current flow.

Rigid quality control and years of field testing have made Syntron Thyristors among the most reliable devices available for solid state power control.

For detailed information, contact:

FMC Corporation
Semiconductor Products
Operation
Homer City, Penna. 15748
(412) 479-8011

FMC Special
Products

Single-chip microprocessor employs minicomputer word length

By providing 16-bit instructions and addresses and a choice of 8- or 16-bit words for data processing, a new microprocessor speeds up operation and simplifies programing for many applications

by George F. Reyling Jr., *National Semiconductor Corp., Santa Clara, Calif.*

□ Because the development cost of custom large-scale integrated circuits can only be justified by high product volumes, LSI-chip designers have turned to developing standard circuits that can be customized by programming: the read-only memory, the programmable logic array, and now the programmable microprocessor.

The 8-bit word length of the first single-chip microprocessors does, however, handicap them for the many applications that require 16-bit words for instructions and memory addresses. For these jobs, a new single-chip device, the processing and control element (PACE), has been developed that provides 16-bit instruction and address-processing plus a choice of either 8-bit or 16-bit

data processing. It not only is faster, but it also needs shorter programs, and hence less memory.

In complex microprocessor applications, the chip with the 8-bit word length may have to use double-precision arithmetic to attain the necessary data accuracy. Worse still, multiple registers are needed to form 16-bit memory addresses, and multiple accesses to memory must be made to fetch multibyte instructions—yet fetching instructions and forming addresses are the operations most frequently performed by processors.

This adds up to a strong case for optimizing the word length for a processor's instruction set and addressing capabilities rather than the data it is handling. Indeed,

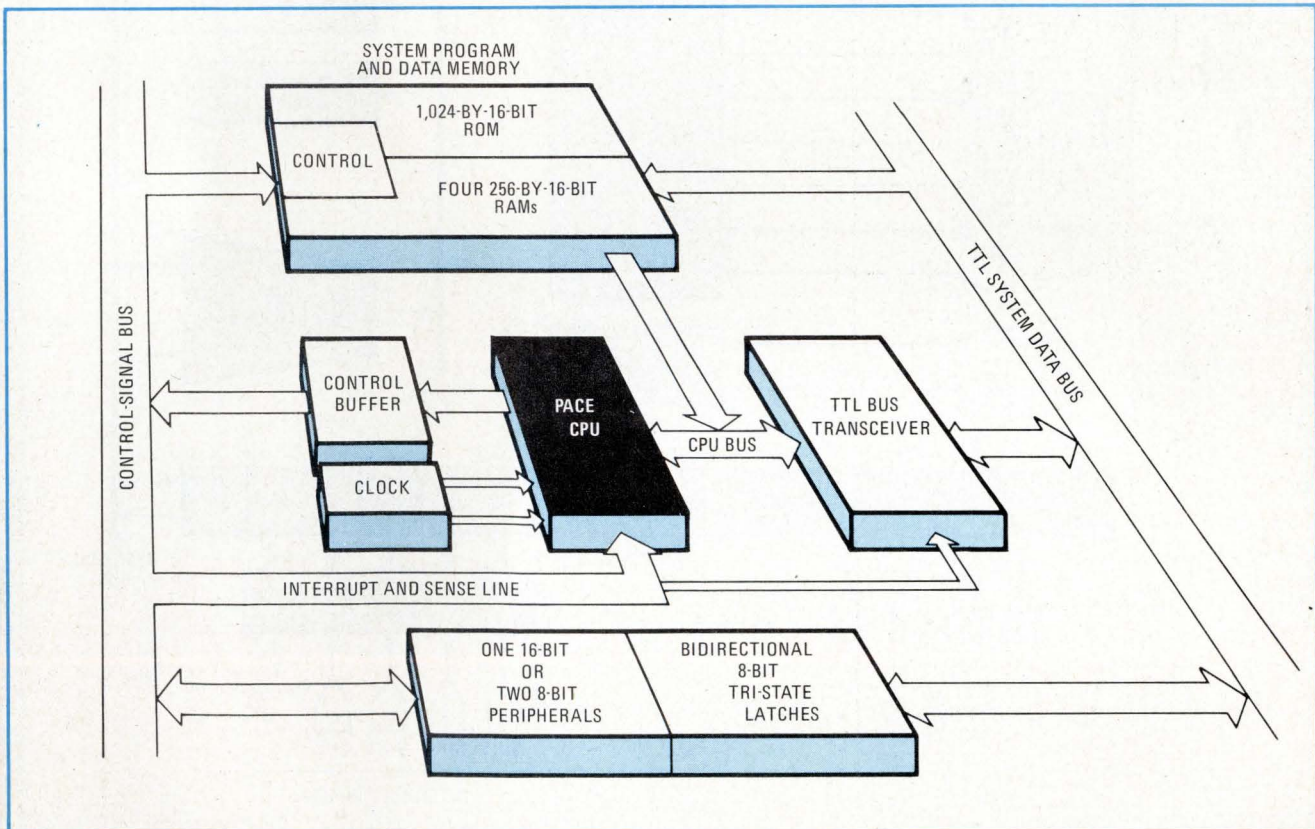

Few parts. The PACE chip allows a complete microcomputer system to be built with a minimal parts count. This system requires five integrated circuits for the 16-bit central processing unit, clock, and buffering circuits, six ICs for the memories, and two ICs for interfacing.

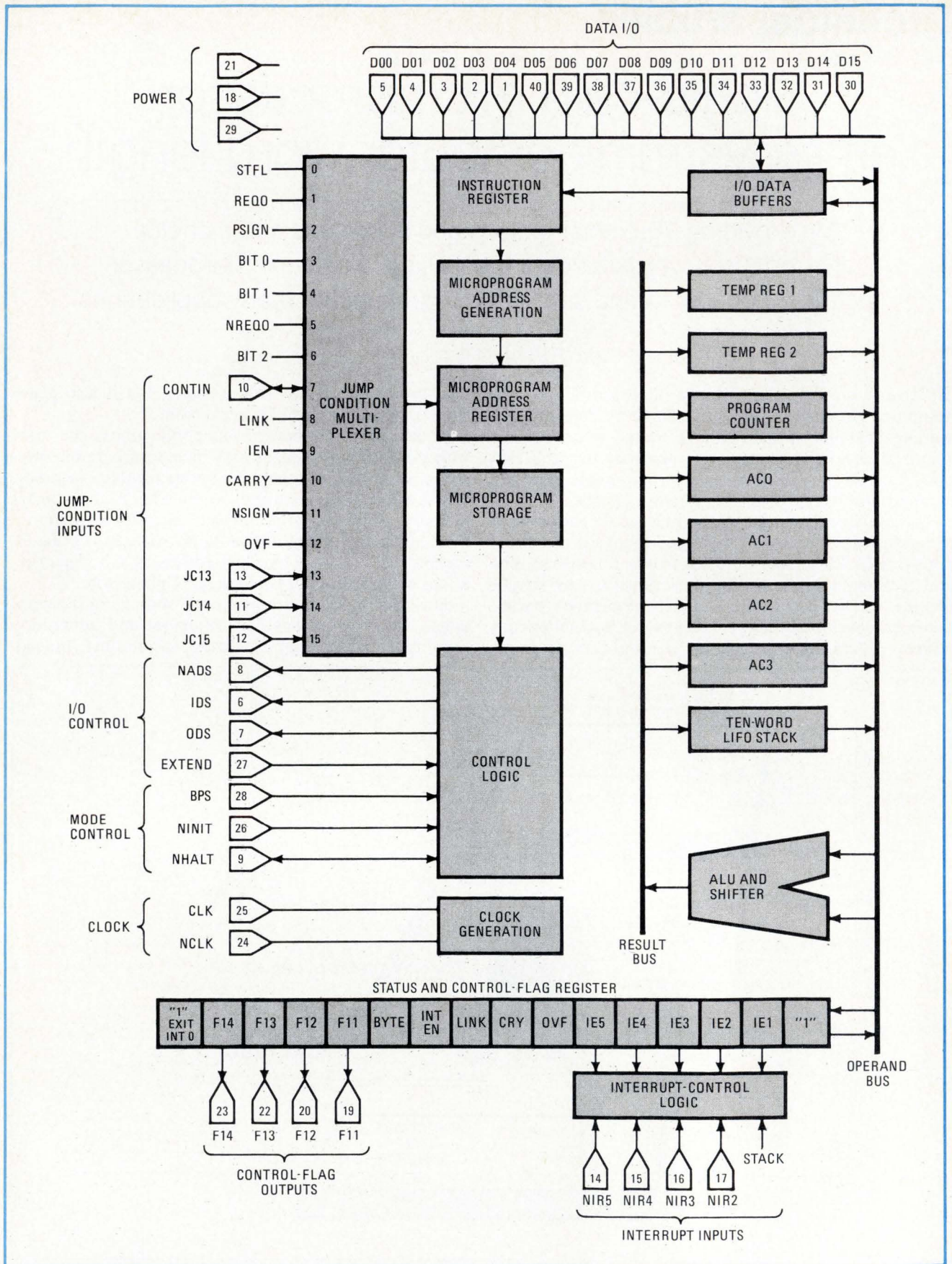

2. On the Inside. Seven 16-bit registers are included in PACE, along with a last-in, first-out stack for additional storage of up to 10 words. The status-flag register can be loaded from any accumulator. The byte flag is used to specify 8-bit or 16-bit data lengths.

the evolution of minicomputers has seen almost universal adoption of the 16-bit word length over 8- and 12-bit designs. PACE has gone one step further by allowing the data length to be independently optimized to 8 or 16 bits, and this should also extend the usefulness of microprocessors in such applications as test and medical instruments, machine-tool controls, navigation systems, process controls, electronic games, cash registers, and traffic controls.

Finally, compatibility with a more powerful, micro-programable microprocessor—National Semiconductor's IMP-16—provides a means of upgrading the system and makes the IMP-16's extensive hardware and software support available to PACE.

All PACE functions are performed by one chip in a 40-pin dual in-line package. This chip integrates not only the functions of the five MOS LSI chips used in the IMP-16 but also most of the functions previously carried out by TTL devices. The chip contains status and control circuitry, conditional-branch sense circuitry, interrupt logic, and even a portion of the clock generation circuitry. The two functions required in external circuitry—a simple, single-phase, true and complement clock input plus data-buffering—can be provided by two separate chip types.

By adding a ROM and four RAMs, all with on-chip address latches, designers can implement a complete microprocessor system in about a dozen packages. It will include 16,384 bits of ROM program storage, 4,096 bits of read-write data storage, and a 16-bit TTL data-bus interface (Fig. 1).

Basic goals

The PACE microprocessor uses p-channel silicon-gate metal-oxide-semiconductor technology. This was chosen as the most economical and reliable process capable of satisfying the two basic design requirements: a typical instruction execution time of 10 microseconds, and a density that would allow a complete 16-bit processor to fit on a chip small enough to be manufacturable in high volume.

Though n-channel silicon-gate MOS would also have been fast and dense enough, p-channel was preferred, because it is today's most predictable, best-established process and has been used successfully on other products of similar complexity. Admittedly, commercial n-channel microprocessors execute instructions in as little as 2 μ s, but its designers believe that PACE's throughput is as good or better, thanks to its 16-bit word length, efficient architecture, and powerful instruction set.

The need to maintain high speed while reducing chip size and power dissipation also affected the circuit design. For instance, output buffers on the PACE chip were designed to drive current-sense amplifiers (with Tri-State capability) which further buffer the signals. However, the current-sense amplifiers do not raise the package count higher than those in other microprocessor systems, which usually require the addition of TTL buffers to drive the data bus. On-chip pullup resistors provide TTL-compatible inputs, and the use of dynamic logic also keeps power dissipation down.

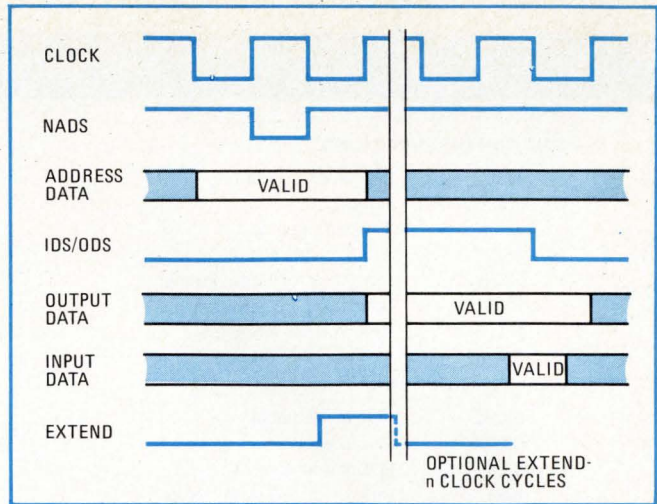

3. I/O controls. During data input and output, the address data strobe (NADS) occurs in the middle of the address-data time period. The EXTEND input allows the I/O cycle time to be extended.

A built-in microprogram controls the PACE microprocessor as it repeatedly fetches instructions from the external program store and executes the corresponding operations. The microprogram is stored in a programable logic array that is not accessible to the user.

For internal data storage, PACE has seven 16-bit registers, four of which—accumulators AC0 to AC3—are directly available to the programmer for data storage and address formulation (Fig. 2). AC0 is the principal working register, AC1 is the secondary working register, and AC2 and AC3 are page pointers or auxiliary data registers. The other three registers—one program counter and two temporary registers—are used by the control section to carry out the PACE instruction set.

Additional data storage for up to 10 words is provided by a last-in, first-out (or push-pull) stack not previously available in many single-chip microprocessors. This stack primarily stores the contents of the program counter during subroutine execution and interrupt servicing, but it may also be used for storing status information or data.

In some simple applications, like controllers for peripheral devices, only one word of data is handled at a time, and here the stack, with four additional accumulators, may provide enough storage so that expensive read-write memories would not be required. For more complex applications, external read-write memory may be used as a stack extension. In such cases, the stack-full and stack-empty interrupts cause execution of a simple stack service routine.

A three-transistor dynamic random-access-memory cell is used in the registers and stack. The RAM is refreshed by internal logic in a manner that is completely transparent to the user.

Data handling

The arithmetic and logic unit (ALU) provides the data-manipulation capability basic to every processor. The operations performed by the ALU include AND, OR, XOR, complement, shift left, shift right, mask byte and sign extend. PACE can add four-digit-per-word binary-

PACE INSTRUCTION LIST

BRANCH INSTRUCTIONS

BOC	Branch on condition
JMP	Jump
JMP@	Jump indirect
JSR	Jump to subroutine
JSR@	Jump to subroutine indirect
RTS	Return from subroutine
RTI	Return from interrupt

SKIP INSTRUCTIONS

SKNE	Skip if not equal
SKG	Skip if greater
SKAZ	Skip if and is zero
ISZ	Increment and skip if zero
DSZ	Decrement and skip if zero
AISZ	Add immediate, skip if zero

MEMORY DATA TRANSFER INSTRUCTIONS

LD	Load
LD@	Load indirect
ST	Store
ST@	Store indirect
LSEX	Load with sign extended

MEMORY DATA OPERATE INSTRUCTIONS

AND	And
OR	Or
ADD	Add
SUBB	Subtract with borrow
DECA	Decimal add

REGISTER DATA TRANSFER INSTRUCTIONS

LI	Load immediate
RCPY	Register copy
RXCH	Register exchange
XCHRS	Exchange register and stack
CFR	Copy flags into register
CRF	Copy register into flags
PUSH	Push register onto stack
PULL	Pull stack into register
PUSHF	Push flags onto stack
PULLF	Pull stack into flags

REGISTER DATA OPERATE INSTRUCTIONS

RADD	Register add
RADC	Register add with carry
RAND	Register and
RXOR	Register exclusive-OR
CAI	Complement and add immediate

SHIFT AND ROTATE INSTRUCTIONS

SHL	Shift left
SHR	Shift right
ROL	Rotate left
ROR	Rotate right

MISCELLANEOUS INSTRUCTIONS

HALT	Halt
SFLG	Set flag
PFLG	Pulse flag

coded-decimal (BCD) data, as well as straight binary data, thus eliminating the program-storage and execution time usually required for BCD-to-binary conversions. This is useful in such BCD-oriented applications as display controllers, electronic cash registers, billing systems, accounting machines, navigation aids, and industrial controllers and test systems.

The programmer, using a status flag, sets the ALU to operate on either 8- or 16-bit data. This option allows character-oriented and other 8-bit applications to be executed using an 8-bit peripheral data bus and read-write memory, while address formation and instruction storage can be implemented in 16 bits.

Data transfers

All input/output transactions consist of an address-output interval (in which the address specifies an external memory location or peripheral device) followed by a data-transfer interval. If 8-bit data is being transferred, the unused bits can be treated as "don't care" bits by the hardware.

Address and data transfers between PACE and external memories or peripheral devices take place over 16 data lines (Fig. 2) and are synchronized by four I/O control signals: NADS (address data strobe), IDS (input data strobe), ODS (output data strobe), and EXTEND (Fig. 3).

The NADS pulse occurs in the center of the address-data time period and may be used to strobe the address into an address latch on the external ROM or RAM.

(Such memories are commercially available with address latches on the chip.) The IDS and ODS indicate the type of data transfer and may be used to enable Tri-State I/O buffers and to gate data into registers or memories. The EXTEND input allows the I/O cycle time to be extended by multiples of the clock cycle and thus adapted to various memory and peripheral devices or to direct-memory-access/bus operation.

The EXTEND input and all other signal inputs to PACE are designed to accept signals that are asynchronous with respect to the clock signal. Clocks for the dynamic logic are derived internally from single-phase true and complement clock inputs. These inputs are divided by the internal circuitry into the eight clock phases that constitute a microinstruction cycle.

Data transfers occur at two times: during each access to an instruction (usually contained in a ROM) and during the access to data (usually contained in a RAM) called for by a memory-reference instruction. (Memory-reference instructions in PACE could perhaps more properly be called I/O-reference instructions, since the same instructions control all data transfers, whether with memory, peripheral devices, or a central processor's data bus.)

The same buses are used for memory and peripherals, saving system hardware. This unified-bus architecture contrasts with that of many other microprocessors and minicomputers, in which one instruction type (I/O class) communicates with peripheral devices and an-

Memory addressing in PACE

Part of the PACE microprocessor's powerful instruction set is a flexible method of addressing the memory. This method makes it possible to reference three sequences of 256 words located anywhere in the 65,536-word memory, as well as another 256 words in fixed positions.

The fixed words from what is called a "base" page, and the others form three "floating" pages. The mode of addressing is specified by the 2-bit XR field (bits 8 and 9) of the 16-bit instruction, as shown in the figure.

When the XR field is 00, it specifies base-page addressing. The base page may consist of either the first 256 words in the memory, or the first 128 plus last 128 words. The base-page-select (BPS) signal input decides which option will be used.

To address the first 256 words of memory (locations 0-255), BPS is set to 0, and the 16-bit memory address is formed by setting bits 8 through 15 to zero and by using bits 0 through 7 to specify one of 256 locations.

If BPS is 1, the 16-bit memory address is formed by setting bits 8 through 15 equal to bit 7 and by using 0 through 6 to locate the first 128 words of the memory (when bit 7 is 0) and the last 128 words (when bit 7 is 1). This technique is useful for splitting the base page between read-write and read-only memories or between memory and peripheral devices, so convenient base-page addressing can access data or peripherals.

When the XR field is 01, it specifies that addressing be relative to the program counter (PC). In this mode, the memory address is formed by adding the contents of the program counter to the value of bits 0 through 7, treated as a two's complement number with sign. That is, the bits

0 to 7 are interpreted as a 16-bit value with bits 8 through 15 set equal to bit 7. This allows numbers from -128 through +127 to be represented. Bits 0 to 7 are called displacement bits, since they can represent a range of words around a center position.

When the XR field is 10 or 11, addressing is relative to an index register, and any memory location within the external 65,536-word address space may be referenced. As before, the displacement field is interpreted as a signed value ranging from -128 through +127. The memory address is then formed by adding the displacement bits to the contents of either accumulator AC 2 (when XR = 10) or accumulator AC3 (when XR = 11). This type of addressing is desirable for those applications that require addresses to be computed at execution time, since addresses can not be modified when a ROM is serving for program storage (as is usually the case with microprocessors as opposed to minicomputers).

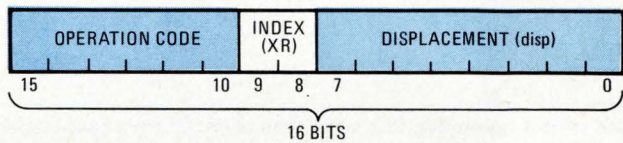

XR FIELD	ADDRESSING MODE	EFFECTIVE ADDRESS
00	Base page	EA = disp
01	Program-counter relative	EA = disp + (PC)
10	AC2 relative (indexed)	EA = disp + (AC2)
11	AC3 relative (indexed)	EA = disp + (AC3)

other instruction type (memory-reference class) communicates with memories. The advantage of the PACE approach is that a wider variety of instructions—in fact, the entire memory-reference class—is available for communicating with peripherals. For example, the DSZ (decrement and skip if zero) instruction can be used to decrement a peripheral-device register, or the SKAZ (skip if AND is zero) instruction can be used to test the register's contents. The LD (load) and ST (store) instructions handle simple data transfers.

Flags and jumps

The PACE flag outputs and jump commands give it flexibility in controlling peripherals. They can be used for many simple control functions, such as start reader and rewind in a tape controller.

The flag and jump conditions also can be used together as a serial I/O port, eliminating the hardware that would otherwise be required to interface to the data bus and to decode the device address. The jump condition inputs serve as data-sense inputs, for one bit of data, since their state can be determined by instructions in the program. A flag, on the other hand, can be set and cleared and serve as an output for one bit. For example, for a teletypewriter, a flag output becomes a serial bit-stream output, and the jump a serial bit-stream input.

All status and control bits for PACE are contained in a single status-flag register (Fig. 2), the contents of which may be loaded from or into any accumulator on the

stack. This makes it convenient to test, store, and even—where a specific group of bits are of interest—to mask status. In addition, a number of status bits may be tested directly by the conditional-branch instruction, and any bit may be individually set or reset.

The bits in the 16-bit status-flag register serve various functions:

- The carry flag is set to the state of the carry output that results from binary and BCD arithmetic instructions and can serve as a carry input for some of these instructions.
- The overflow flag is set if an arithmetic overflow results from a binary-arithmetic instruction.
- The link flag serves as a 1-bit extension for certain shift and rotate instructions.
- The byte flag is uniquely important, since it is used to specify an 8-bit data length for data-processing instruction while arithmetic operations for address formation remain at the 16-bit data length. (In the 8-bit data mode, modifications of the carry, overflow, and link flags are based on the 8 least-significant data bits only).
- Six status flags enable the interrupt request lines.
- Four flags (bits 11-14) can be assigned functions by the programmer. These flags drive output pins and may be used as direct controls for external system functions or as software-status flags.
- Bits 0 and 15 of the status register are not intended for use and always appear as a logic 1.

In the past, microprocessors' interrupt features have

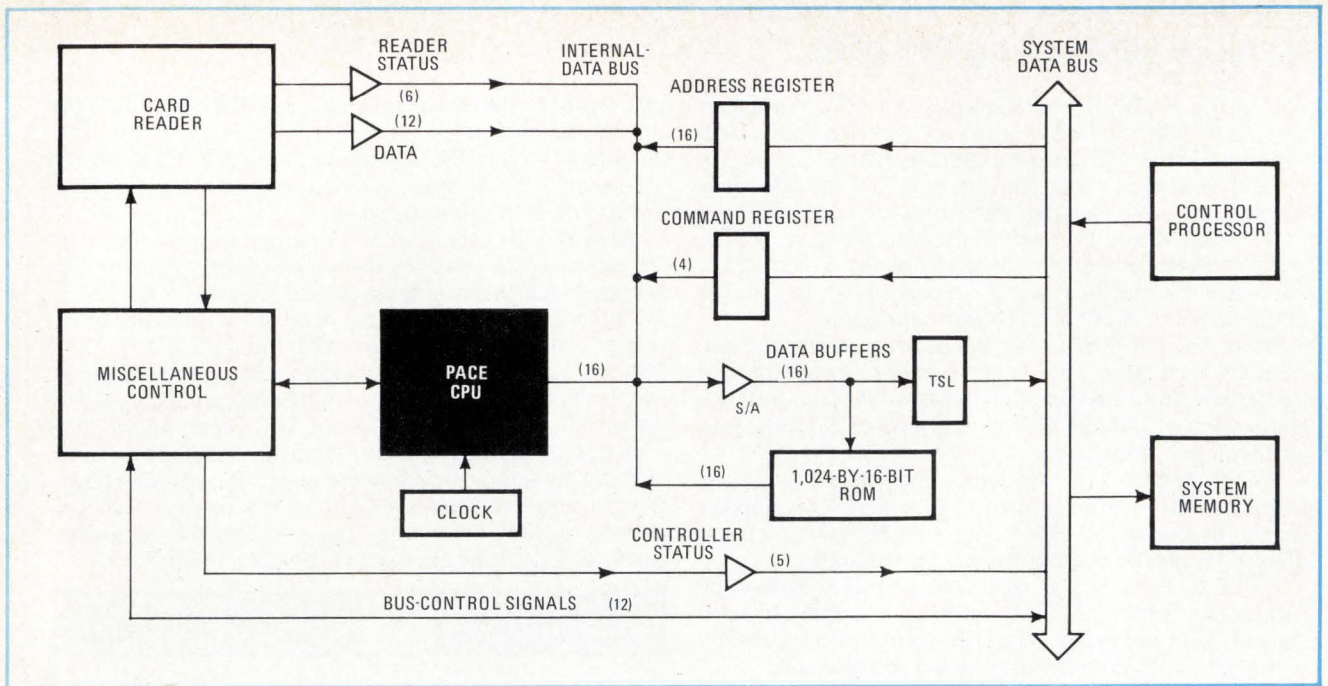

4. Card-reader controller. One application of PACE is in a card-reader controller, which requires about 20 IC packages. A central processor commands the controller to complete various operations, and the controller generates timing and control signals for the card reader.

been inadequate for many applications and have also required excessive hardware and software. Yet interrupts are essential in those applications where alarm conditions or transient conditions must be serviced immediately, as in controls for automobiles, chemical processes, or machine tools. They are also useful in many other systems to eliminate the program overhead required to scan asynchronous system inputs, as in a controller for multiple terminals or for an intersection traffic light.

Six interrupt levels

The PACE microprocessor, however, provides a six-level, priority-interrupt structure. As a result, the interrupting device's level is automatically identified, and all devices on an interrupt level can be enabled or disabled as a group, independently of other interrupt levels. An individual interrupt-enable is provided in the status register for each level, and a master interrupt-enable (IEN) is provided for all five lower-priority levels as a group. Negative-true interrupt request inputs allow several interrupts to be "wire-ORed" on each input.

The PACE interrupt system can save considerable hardware and software in applications that tend to need several interrupts. The on-chip priority logic and subsequent "vectored" (or immediate) branch to the interrupt routine can eliminate many of the logic circuits that are often required with other microprocessors. For example, PACE can internally resolve priority questions and immediately put an address vector onto the data bus. The interrupt-servicing capability in addition saves the program-storage-and-execution time that would otherwise be required to access the appropriate interrupt-service routine.

The PACE microprocessor's 337 individual instructions are a general-purpose mix of 45 types of instruc-

tions. The mix is powerful enough to allow program-coding to be considerably more efficient than with most microprocessors, and it also compares favorably with many minicomputers.

The memory-reference instructions, for example, use a flexible memory-address scheme to provide one fixed, or "base," page of 256 words in the external memory, and three "floating" pages, which allow the user to pick out 256 words anywhere in the memory. The floating pages can be selected according to the contents of the program counter or either of the two accumulators (see "Memory addressing in PACE").

Instruction types

Among the types of instruction used in PACE are:

- Branch instructions, which allow transfer of control to anywhere in the 16-bit addressing space.
- Conditional branches, which allow testing of any one of 16 conditions, including status flags, the contents of the principal working register (AC0), and user inputs to the chip.
- Skip instructions, which provide additional testing capability and comparisons of memory without altering data.
- Memory-data-transfer instructions, for transferring data between the accumulators and either memory or peripheral devices.
- Load-with-sign-extended instructions, which convert 8-bit, two's-complement data to 16-bit data, allowing 16-bit address modification when the 8-bit data length has been selected.
- Memory-data-operate instructions, for operations between the principal working register (AC0) and memory or peripheral data. They include both binary and BCD arithmetic instructions (no correction required).
- Register-data-transfer instructions, which provide a

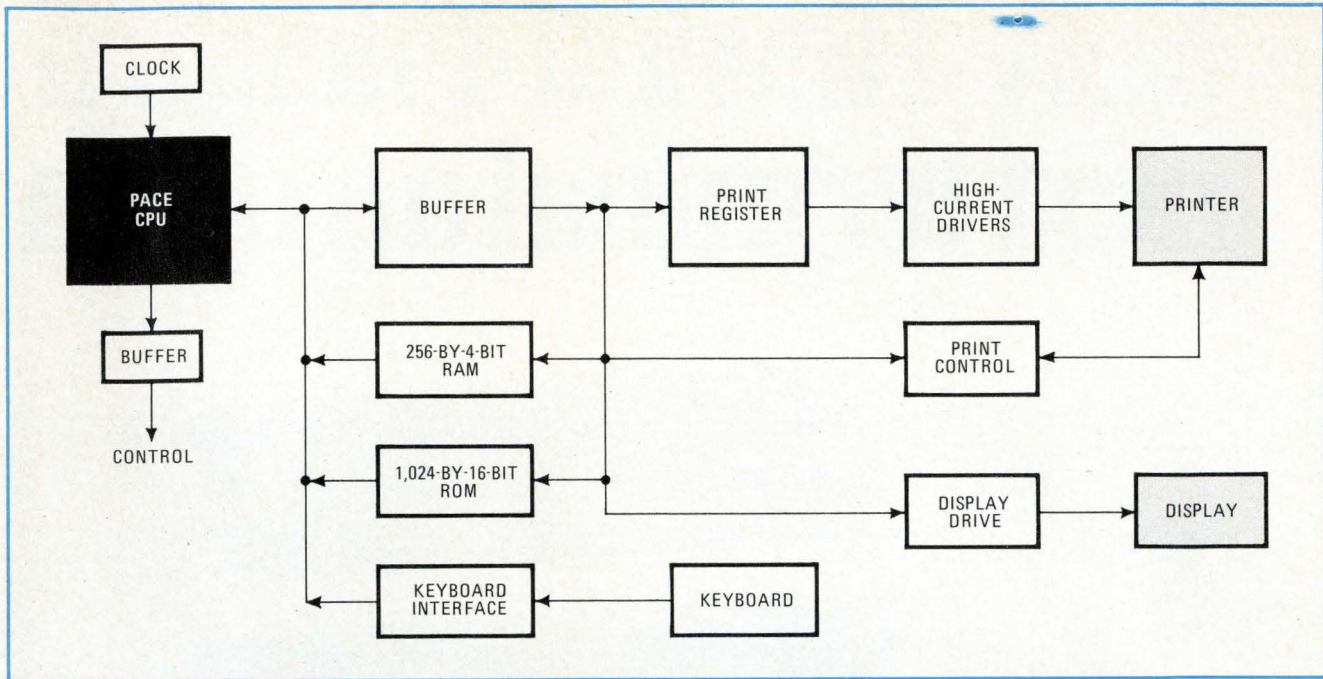

5. Cash register. An electronic cash register using PACE can perform such functions as tax computations and multiple-item pricing. The entire system has been built with 35 IC packages, eight of which comprise the CPU and the memory.

complete set of transfer possibilities between the accumulators, flag register, and stack, and which include the capability to load immediate data.

- Register-data-operate instructions, for logical and arithmetic operations between any two accumulators. They may be used to modify addresses and data and to reduce the number of time-consuming memory references in a program.
- Shift-and-rotate instructions, which allow eight different operations that are useful for multiply, divide, bit-scanning, and serial input-output operations.
- Miscellaneous instructions, including the capability to set or reset any of the 16 bits of the status-flag register individually

Two applications

A card-reader controller and an electronic cash register illustrate the use of the PACE microprocessor.

The card-reader controller (CRC) is designed to interface with a system that is under the control of a central processor and has a direct memory-access channel (Fig. 4). The central processor issues commands to the CRC over a 16-bit multiplexed data bus. The CRC then responds to these commands by generating appropriate timing and control signals to the card reader and by monitoring the card reader's data and status outputs. Data read from the card is then transferred directly to the system memory over the data bus, and the CRC generates an interrupt to the central processor to signal completion of the order or the occurrence of an error condition.

The CRC has two modes of operation. In the bootstrap mode, a control-panel switch causes one card to be read and its data deposited in packed form in the first 40 locations of system memory. In the normal mode, the CRC also transfers data directly to memory, but does so

under control of the central processor.

Data output from the PACE chip is buffered with sense amplifiers, which drive the 1,024-by-16-bit ROM chip (with internal address latch) and the Tri-State system data-bus buffers for time-multiplexed address and data output. Input commands to the CRC are received in the 4-bit command register, while the address register stores those system-memory starting addresses specified by the read commands.

The PACE priority-interrupt inputs are very useful in this application. They monitor the index pulses and signals for motion check, hopper check, and read error. The jump-condition inputs monitor less critical signals, such as reader-ready. Control-flag outputs drive the reader's card-pick input and gate data from the register onto the internal data bus.

The total controller function, including memory and I/O, requires about 20 packages. This is a quarter the number required for a TTL MSI version (which also does not include character conversion). The PACE design, with its programmable feature, also allows easy modifications for changes in command requirements or for a variety of card readers.

The electronic cash register (Fig. 5) consists of the CPU, memory, a 6-digit display, and 18-column printer, and a keyboard. In addition to providing all the functions of a mechanical cash-register, the system performs automatic tax computations and multiple-item pricing. The 256-by-4-bit RAM with on-chip address latches provides the programmer with 32 8-digit registers to store totals, calculate taxes, and so on.

The CPU and memory section is implemented with only eight packages, while the entire system requires approximately 35 packages. Again, effective use is made of the interrupts, jump conditions, and flags to reduce hardware and software requirements. □

Now Hewlett-Packard next terminal an open

Plug-in character sets.

The 2640A can store four 128 character sets concurrently. Adjacent characters on the display can be selected from any set. There's already an optional math character set and a line drawing set in addition to full upper/lower case Roman set.

Smart memory (with 4K RAM's).

Efficient storage with our Dynamic Memory Allocator assures maximum utilization. Store as many as 50 short lines with the standard 1024 byte memory or over 3 full pages with the maximum 8K memory.

Pop-in, pop-out modularity.

Flip a couple of latches and you access every component. Want to add features? Plug them in. New state-of-the-art options? Plug them in. Need a repair? Pop out the old. Plug in the new.

Computer-born micro-processor technology controls the show.

An on-board micro-processor supervises memory allocation, data communication, keyboard scanning and display control.

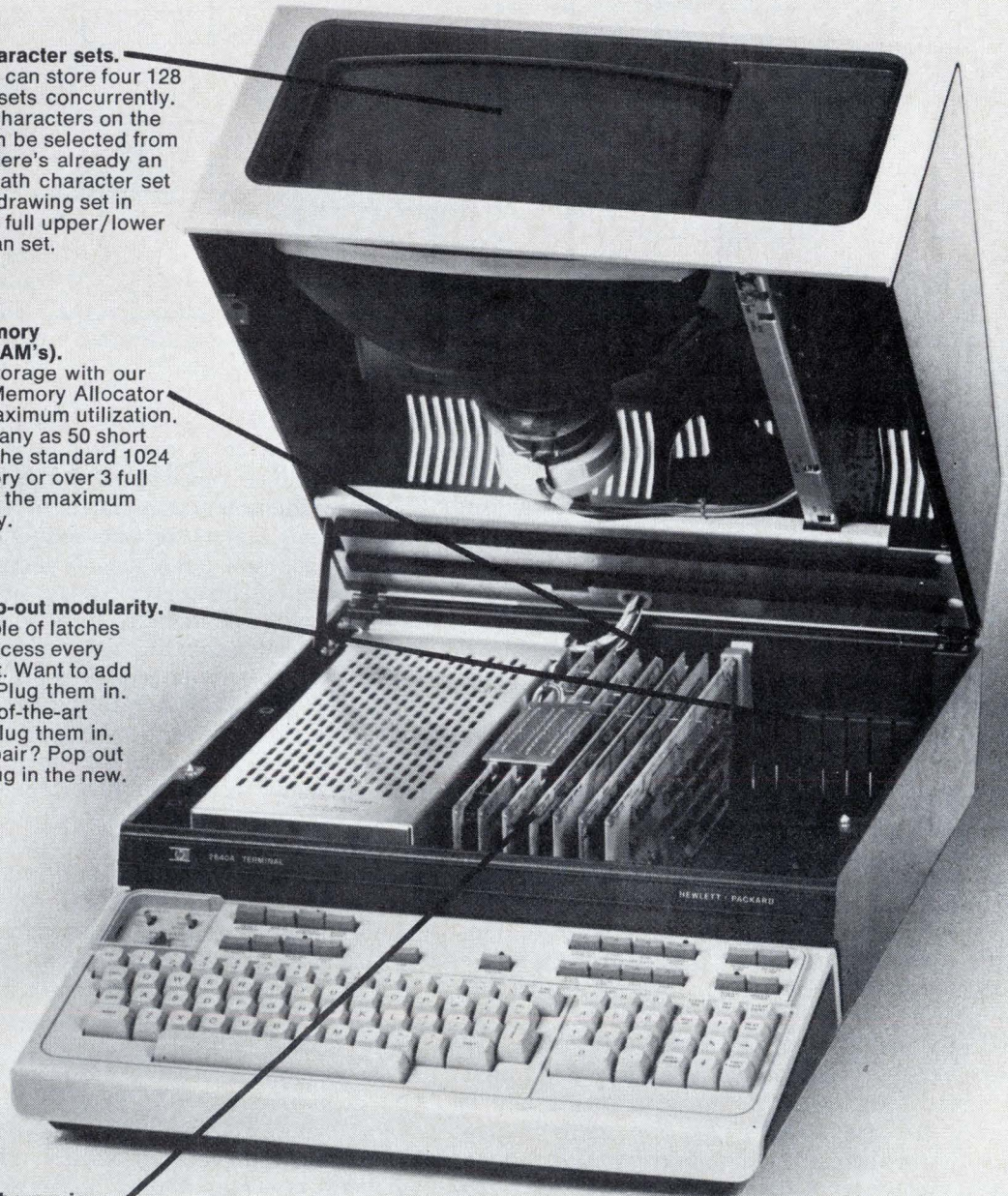

makes selecting your and shut case.

Inspect its features. At \$2640* you won't find another terminal that comes close. Inside or out. HP's 2640A. The terminal that grows with your system. It's from Hewlett-Packard. Come and get them.

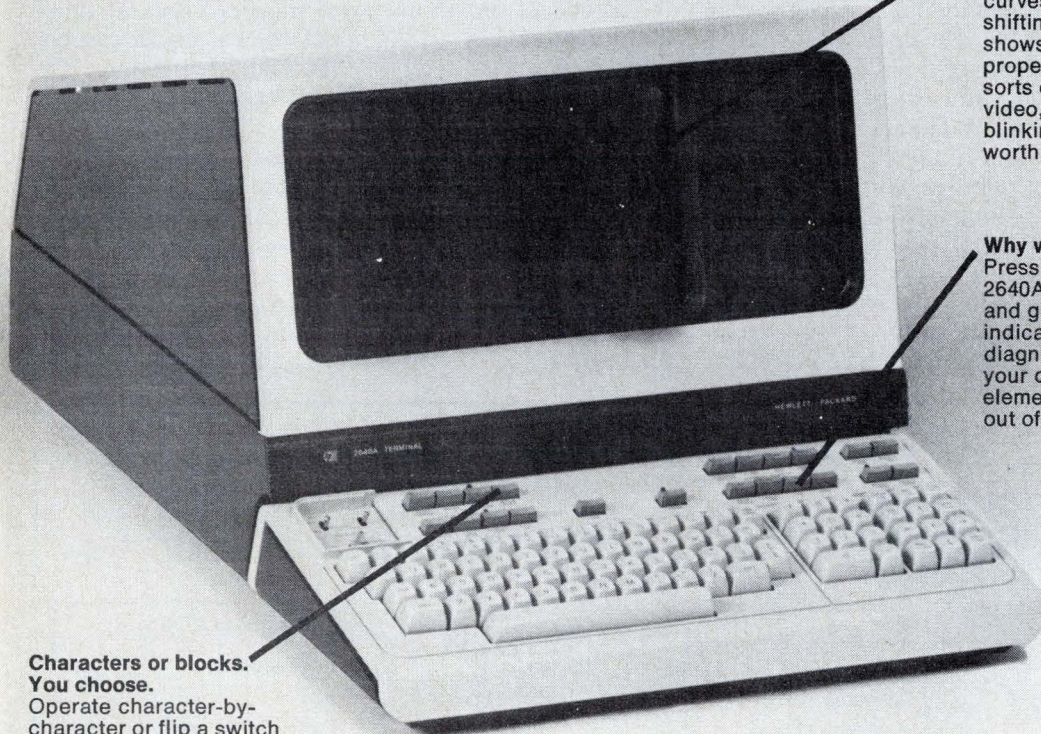

A display that people like.

Precise. Crisp, with 9 x 15 dot character cell. Character curves are smoothed by dot shifting. The 5" x 10" screen shows characters in their proper 2x1 aspect ratio. All sorts of options, such as inverse video, underlining, half bright, blinking, because a picture's worth a thousand words.

Why wait on us? Self-test.

Press the TEST key and the 2640A agreeably tests itself and gives you a go/no-go indication. Or load our diagnostic test program into your computer for complete, element-by-element check out of the entire unit.

**Characters or blocks.
You choose.**

Operate character-by-character or flip a switch and operate a block at a time. Text can be composed and edited locally allowing user verification before transmission to the CPU. Editing and CPU connect time are slashed by user-oriented features such as character or line insert and delete; programmable protected fields; and off-screen storage with scrolling. Plus, eight special keys for user-defined functions.

HP terminals. They work for a living.

HEWLETT  PACKARD

Sales and service from 172 offices in 65 countries.
1501 Page Mill Road, Palo Alto, California 94304

*Domestic USA price in quantities of six.

22430

Low-speed counter uses low-priced calculator chip

by Dennis J. Flora
Stevens Institute of Technology, Hoboken, N. J.

A totalizing counter that runs at less than 40 hertz makes novel use of an inexpensive calculator IC, one of several now available. The IC in the illustrated counter is the MM 5736, a six-digit calculator chip that can directly drive the segments of small common-cathode light-emitting-diode displays. Because of this capability, the single IC replaces many discrete counter and decoder ICs; only a few extra logic chips are required.

The MM 5736 has seven segment outputs, six digit outputs, and three keyboard inputs. In normal usage, the segment outputs drive the individual segments of all digits in a conventional display. The digit outputs drive the digits of the display, scanning rapidly from one to the next in synchronism with the segment outputs so that individual numerals are illuminated. These digit outputs also scan the keyboard. If any key is depressed, a connection is made from one digit output to one of the three keyboard inputs, uniquely identifying that key. The logic circuits in the chip respond to that input to display a digit or to begin an arithmetic operation.

The logic that is added in lieu of a keyboard includes three 555 timers, four two-input NAND gates, four inverters, and a few discrete components. The calculator

chip and this logic together count events as signaled by an external count pulse, incrementing the display by 1, 2, or any integer up to 9.

The negative-going leading edge of each count pulse triggers a 555 timer connected as a monostable multivibrator, generating a pulse about 15 milliseconds long. This is long enough for the six digit outputs of the chip to complete many full scans, connecting what looks to the calculator like a key depression to one of the keyboard inputs. (In normal operation, a key depression is usually much longer than 15 ms because of human reaction time, and the corresponding digit entry is made in the calculator chip many times.) The "key" in this case is a hard-wired connection from one of the digit outputs to a NAND gate-inverter combination, and another is a hard-wired connection from the inverter to one of the keyboard inputs, in accordance with the table. By this means, the counting increment is entered into the calculator.

The end of the 15-ms pulse triggers a second timer that forces a delay during which the calculator can become stable after receiving the "key depression." (In normal operation, this delay is created as the user moves a finger from one key to another.) At the end of this delay, the third timer is triggered to produce a pulse that gates the digit output d_4 into the keyboard input k_3 to enter what the calculator sees as an instruction to add. Thus, for every incoming count pulse, the calculator chip adds the wired-in increment to the previous total and displays the result.

Normally, to clear this calculator, the clear button on the keyboard is pressed twice. To provide time to clear

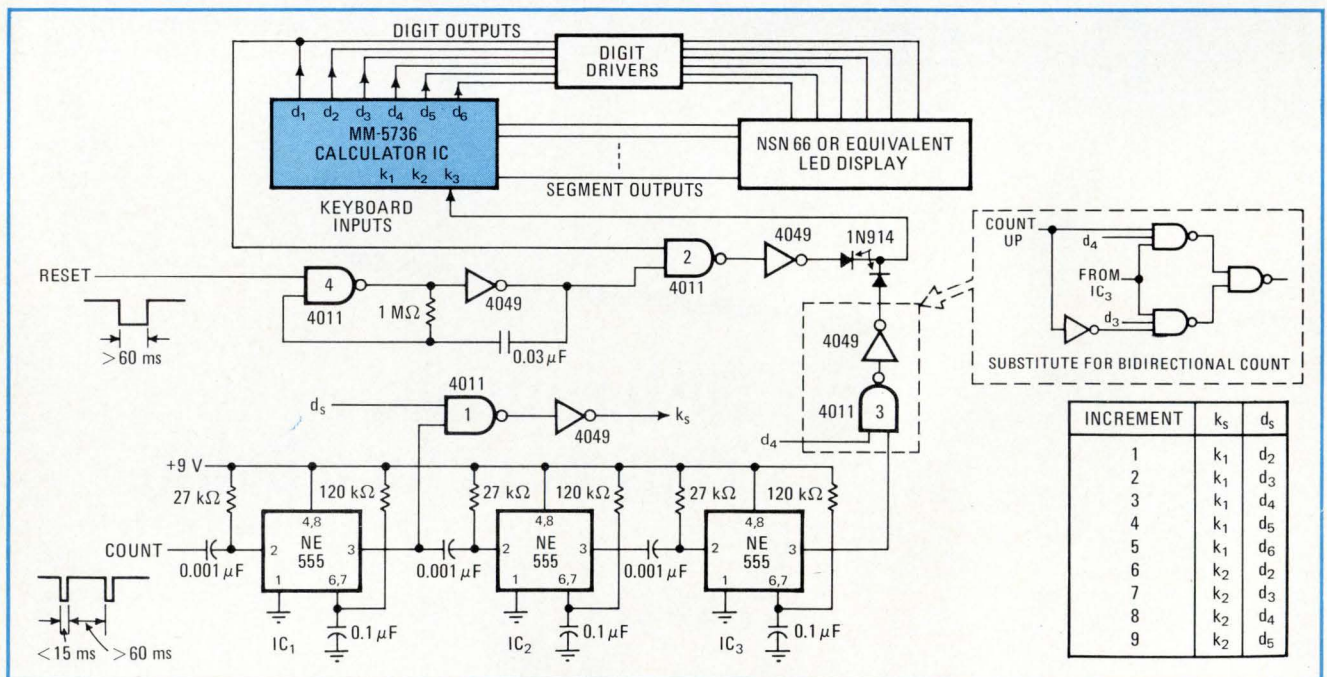

Calculator counter. Logic blocks take the place of a keyboard to provide appropriate signals for the single-chip calculator, MM 5736, to serve as a simple counter. It costs less than the collection of discrete devices that otherwise would be required.

the counter, the reset pulse must be held low for at least 60 ms. During that time, an astable multivibrator assembled from another NAND gate, an inverter, a resistor, and a capacitor, provides at least two connections of digit output d_1 to keyboard input k_3 . Since this is the same input used by the "add" pseudo-instruction, two diodes create the equivalent of an OR gate in front of k_3 .

The counter can be expanded to count either up or down by removing the inverter following NAND gate 3 and inserting, before the gate, two three-input NANDs,

as shown in the inset of the diagram. This connects either d_4 to k_3 to count up, as in the main diagram, or d_3 to k_3 to count down, controlled by a single additional logic input that specifies the direction of counting. This input has to be inverted to provide the proper level at both the three-input gates; the removed inverter can be used for this function.

The whole counter can be built for \$15 to \$20, an economical substitute for the six discrete counters and six decoder/drivers that would otherwise be required. □

Modified window comparator compensates for temperature

By C. E. Musser
General Electric Co., Binghamton, N. Y.

A window comparator circuit, which detects signal voltages at two different levels by comparing them to fixed references, can be modified to compensate for temperature variations that otherwise can affect the trip points that define the window.

In the circuit's simplest configuration (Fig. 1), two voltage-reference dividers are connected to the inputs of an operational amplifier. Both dividers have the same excitation polarity, but the non-inverting input reference must be more positive than the inverting. Choosing the fractional resistance values establishes this inequality and defines the window's width.

An input signal is applied between diodes D_1 and D_2 from a low-impedance source, such as another op amp. For all signals that are at least one diode voltage drop more negative than the inverting input reference, diode D_2 is back-biased and not conducting, and the op amp is in negative saturation.

When the input signal is more than one diode drop more positive than the junction of the voltage divider at the inverting input, diode D_1 turns off and D_2 turns on.

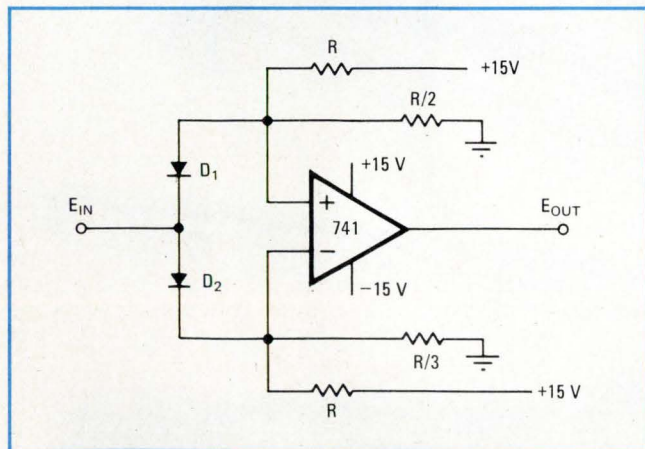

1. Plain window. Operational amplifier, otherwise in positive saturation, is in negative saturation whenever input signal is more than 0.6 volt below negative reference or above positive reference.

When the non-inverting op amp input becomes slightly more positive than the inverting input, the amplifier switches to positive saturation. In Fig. 2 this level is called E_{in1} .

A still larger positive excursion of the signal, to E_{in2} in Fig. 2, pulls the inverting input above the non-inverting one, making the op amp switch back again to negative saturation.

The two voltage references can be made negative by reversing the polarity of the excitation voltages and the input diodes. Doing this also reverses output polarity—it effectively turns Fig. 2 upside down. The reference volt-

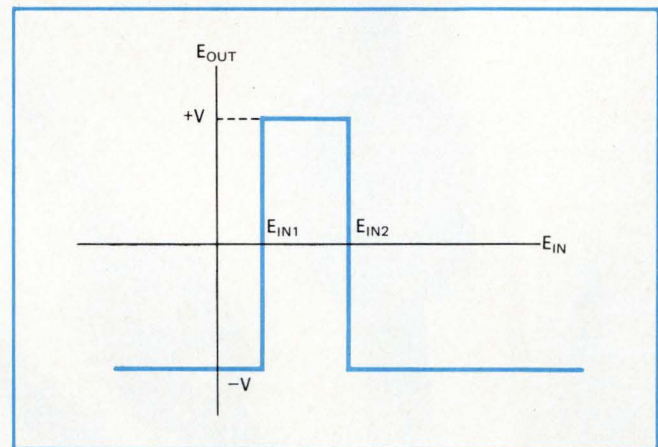

2. Switching points. Op amp output is positive whenever input lies between E_{in1} and E_{in2} , negative for other levels.

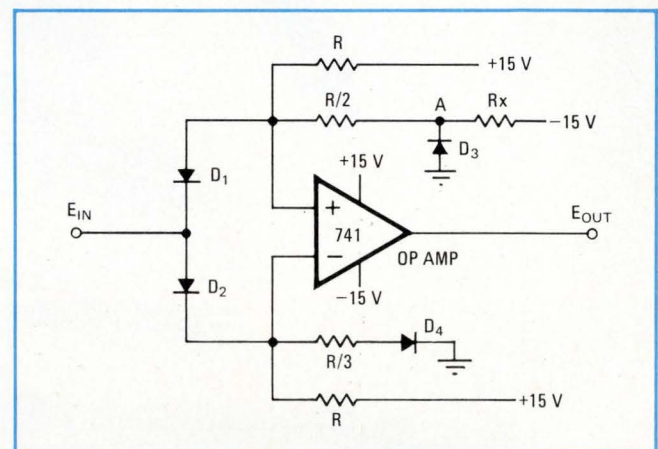

3. Modified window. Because temperature changes can vary diode characteristics and change trip points, extra diodes in dividers vary in the same way and minimize the extent of the change.

The choice is yours...

for image storage

- Air traffic control ● Harbour and river traffic control ● Remote display
- Image offset and Zoom ● Multisensor displays ● TV image freeze
- Banking, luggage check ● Scan conversion (PPI, random, TV standards)
- Signals handling ● Low light level imaging. Integration.

We offer the widest choice of storage tubes to solve your problems: permanent recording or progressive erasure, single or dual-gun for sequential or simultaneous write and read-out, full grey scale capability, rugged, compact and high resolution types.



THOMSON-CSF

MARKETED IN NORTH AMERICA BY DUMONT ELECTRON TUBES & DEVICES / CLIFTON N.J. / TEL (201) 773-2000
FRANCE - THOMSON-CSF GROUPEMENT TUBES ELECTRONIQUES / 8, RUE CHASSELOUP-LAUBAT / 75737 PARIS CEDEX 15 / Tél. (1) 566 70 0
Germany - THOMSON-CSF Elektronenröhren GmbH / Am Leonhardsbrunn 10 / 6 FRANKFURT/MAIN / Tel. (0611) 70 20 99
Italy - THOMSON-CSF Tubi Elettronici SRL / Viale degli Ammiragli 71 / ROMA / Tel. (6) 38 14 58
Japan - THOMSON-CSF Japan K.K. / Kyosho Building / 1-9-3. Hirakawa-cho / Chiyoda-ku / TOKYO 〒 102 / Tel. (03) 264 6341
Sweden - THOMSON-CSF Elektronrör AB / Box 27080 / S 10251 STOCKHOLM 27 / Tel. (08) 22 58 15
United Kingdom - THOMSON-CSF Electronic Tubes Ltd / Bilton House / Uxbridge Road / Ealing / LONDON W 5 2TT / Tel. (01) 579 55 11 / Telex 26 659



ages for this circuit are

$$E_{in1} = V[(R/3)/(R+R/3)] - V_d = (V/4) - V_d$$

$$E_{in2} = V[(R/2)/(R+R/2)] + V_d = (V/3) + V_d$$

where V_d is the diode voltage drop.

Temperature changes cause diode variation that affect the trip points. Additional diodes in the dividers (Fig. 3) vary in the same way as the input diodes, and thus partially compensate for such changes. The resistor R_x should be chosen so that point A is slightly negative, just enough to bias the diode into continuous conduc-

tion. For the modified circuit the reference voltages are

$$E_{in1} = \eta[(V - V_d)(R/3)/(R + R/3)] + V_d\theta - V_d = (V - V_d)/4$$

$$E_{in2} = \eta[(V + V_d)(R/2)/(R + R/2)] - V_d\theta + V_d = (V + V_d)/3$$

Both of these circuit versions have been tested at room temperature using $\pm 1\%$ metal-film resistors, 1N4148 diodes, and 741 op amps. Assuming V_d to be 0.6 volts, the measured trip points agreed well with the calculated values. \square

Timer pulse widths range from seconds to hours

by Ken Erickson
Interstate Electronics Corp., Anaheim, Calif.

A timer with output durations ranging from a few seconds to more than 100 hours can be built around a plating cell, thus avoiding the special low-leakage components or high resistances that such timers often require.

When the current direction in a plating cell is from reservoir electrode to working electrode, silver is plated onto the working electrode in an amount proportional to the charge passed through the cell. Conversely, when the current direction is from working electrode to reservoir electrode, silver is removed from the working electrode. As long as the electrode is plated, the impedance of the cell is only a few kilohms; but after all the plating is removed from the anode, the impedance across the cell increases to several megohms. When this happens, transistor Q_1 is turned on; otherwise, when the cell is plated, Q_1 is cut off.

The plating charge is the charge on capacitor C. When the input and output have both been low for a long time, C has charged fully to about 3.6 volts, and at 1,000 microfarads as shown, it holds 3.6×10^{-3} coulomb. Then, when the external input to gate G_1 goes high, its output drops to ground, and C discharges

through the plating cell. The current, I_d , with the reference shown, is negative, causing the cell to be plated. The current's magnitude is limited by resistor R_1 ; the time constant for the values shown is about 1 second. Plating the cell drops the voltage at the base of Q_1 below its threshold, thus turning Q_1 off and Q_2 on. The collector of Q_2 drops almost to ground; this level is inverted by gate G_2 , and the output goes high. This output feeds back to gate G_1 to make the circuit's operation independent of the input line once the timing cycle has begun.

The deplating current flows continuously through R_2 ; it is 1 microampere for the value of R_2 shown. When deplating is nearly completed, the cell's impedance begins increasing gradually, Q_1 turns back on, the timer output goes low, and if the timer input is low, capacitor C charges again.

The charge transferred during either plating or deplating is represented by

$$Q = CV = I_d T$$

From this relationship, the time to transfer this charge is

$$T = CV/I_d$$

For a 1,000-microfarad capacitor, the time to deplate the cell is 3,600 seconds—a full hour. Other times can be obtained by using different values for the capacitor C or the resistor R_2 . \square

Designer's casebook is a regular feature in Electronics. We invite readers to submit original and unpublished circuit ideas and solutions to design problems. Explain briefly but thoroughly the circuit's operating principle and purpose. We'll pay \$50 for each item published.

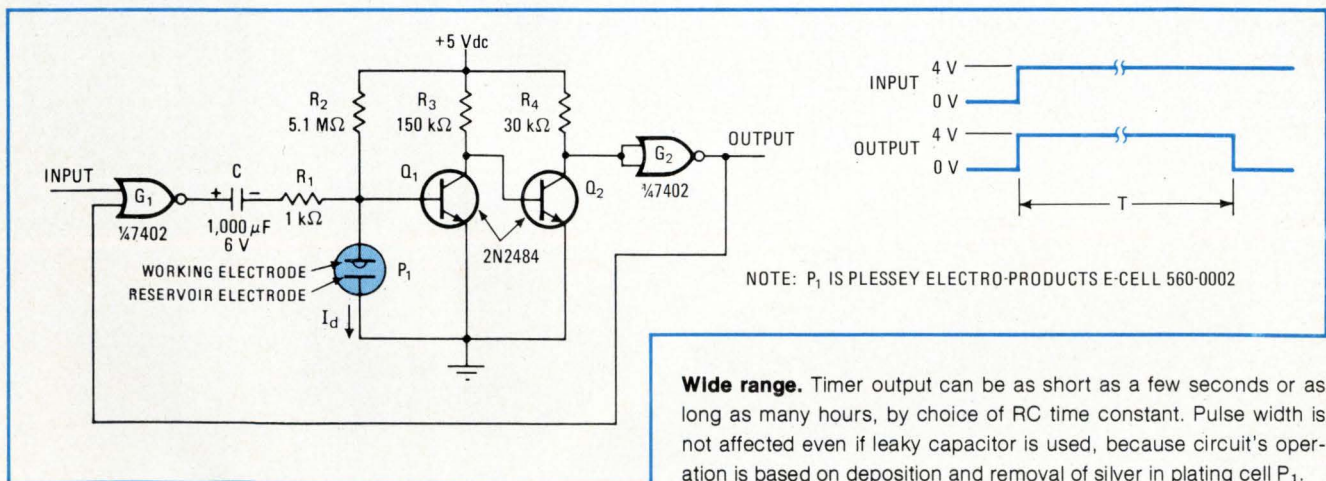

Wide range. Timer output can be as short as a few seconds or as long as many hours, by choice of RC time constant. Pulse width is not affected even if leaky capacitor is used, because circuit's operation is based on deposition and removal of silver in plating cell P_1 .

Digital introduces a pair of minis for the price of micros.

**8/A-400 with
8K core. \$1845.**

**8/A-200 with
4K MOS. \$1317.**

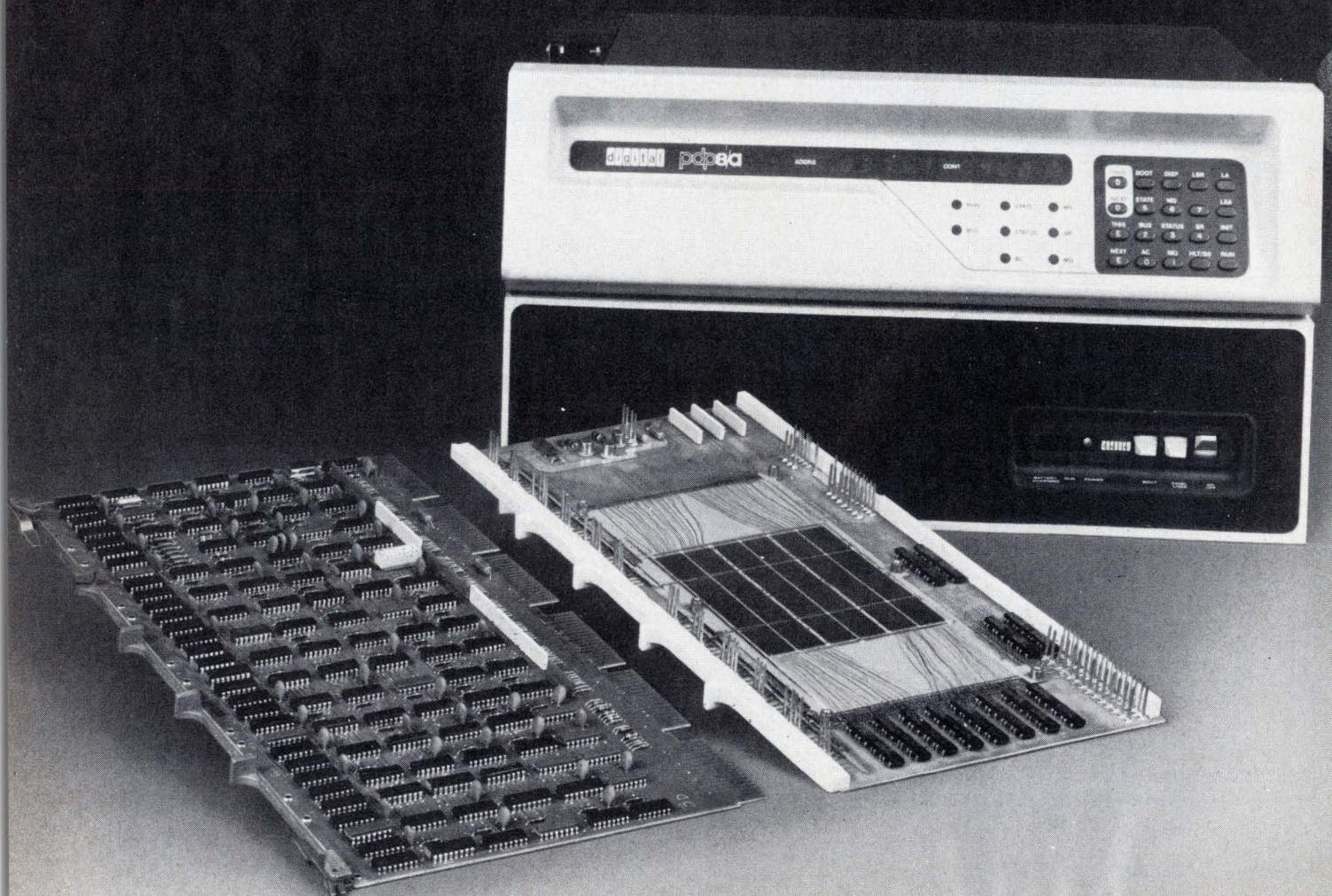

Two new small computers.
Two new bottom-busting prices.

The 8/A, with central processor, 4K of MOS (RAM) memory, chassis, power supply, operator's console, and battery backup. Just \$1317 in quantity 50.

The 8/A-400, with central processor, 8K of core memory, chassis, power supply, and operator's console. Only \$1845 in quantity 50.

Now take a look at the quantity prices in the table below. And while you're at it, take a close look at the competition's prices.

What you learn may surprise you.

But price is only half the story.

As part of the largest computer family in the world (over 25,000 PDP-8's installed), both these new computers are backed by 10 years of PDP-8 software development.

Dozens of PDP-8 peripherals. And a complete range of interfaces.

We've become the world's leading supplier of small computers by helping you make the most of computers.

Now prices are going to

keep us there.

For more information on these new computers, write Digital Equipment Corporation, Maynard, MA 01754. (617) 897-5111. European headquarters: 81 route de l'Aire, 1211 Geneva 26. Tel: 42 79 50. Digital Equipment of Canada, Ltd., P.O. Box 11500, Ottawa, Ontario K2H 8K8. (613) 592-5111.

digital

		CPU & 1K RAM Boards Only	CPU & 4K RAM Package	CPU & 8K CORE Package	CPU & 16K CORE Package
Digital Equipment	PDP-8/A	\$ 591	\$1317	\$1845	\$2505
Computer Automation	LSI 2/10	\$1050	\$2135	\$2459	\$3491
Data General	Nova 2/4	Not Available	\$2112 (CORE)	\$2432	\$3456
General Automation	LSI 12/16	\$ 635 (Qty. 100)	\$2000 (Qty. 100)	\$2300 (Qty. 100) (RAM)	\$3100 (Qty. 100) (RAM)
National Semiconductor	IMP-16L	\$ 713	\$2660	\$3510 (RAM)	\$5210 (RAM)

Based upon current published prices for discount level of 50 units.

Prices apply to U.S.A. and Canada only.

Counter keeps track of microprocessor interrupts

by Douglas M. Risch
Woodward Governor Co., Fort Collins, Colo.

A counter for keeping track of the number of times a microprocessor executes its interrupt-enable and interrupt-disable instructions permits the use of nested interrupts. With nesting, a routine that interrupts another program can itself be interrupted by a subroutine, which may be subject to still another interrupt, and so on to almost any desired depth. By this means, the power of the microprocessor to implement complex logic designs can be greatly extended.

A single microprocessor can often be assigned several related tasks, which it executes in rotation, either with a fixed amount of time devoted to each task, or to interrupt on a demand basis. A program yields when the interrupting program requires service.

However some programs may contain segments that must not be interrupted. For instance, if a routine that fetches information from a multiplexed analog interface (Fig. 1) is interrupted after the input channel is selected, but before that channel's signal moves to the analog-to-digital converter, erroneous information could be trans-

mitted. Or, when a multiple precision operation is under way (Fig. 2), an interrupt after the first word is loaded into the register, but before the second, may generate an incorrect output for a period much longer than normal in this period.

These examples show why the newer microprocessors include interrupt-enable and interrupt-disable instructions with their interrupt capabilities. Simpler microprocessors can implement these instructions with hardware (Fig. 3). But a simple enable/disable capability would be insufficient when a program that would disable the interrupt called a subroutine that would also disable the interrupt. The subroutine, when finished, would enable the interrupt before the program could tolerate enablement.

The solution is to remember how many interrupt-disable instructions were given and to prevent interrupts until each disable instruction has been matched with an enable instruction. A hardware implementation (Fig. 4) is just a modification of the simple enable/disable logic, including an up/down counter to remember the number of disable signals. A corollary software solution is also possible; it merely implements the up/down counter in a memory location instead of in a separate register.

Interrupt-disable commands can be nested as deeply as $2^n - 2$ for the hardware implementation, using an n-stage counter, or $2^n - 1$ for the software implementation, where n is the number of bits in a word. □

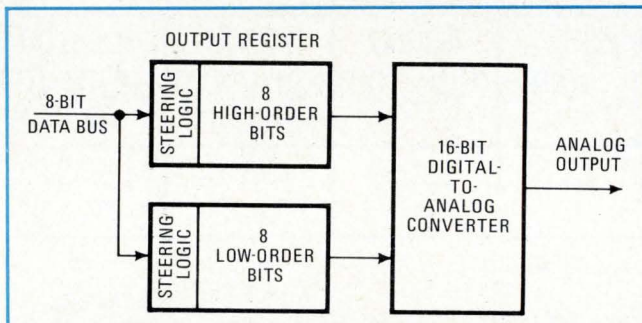

1. Multiple precision. When desired precision requires more than one word, all bits must be loaded before an interrupt can be tolerated. This prevents an incorrect level from appearing at the output.

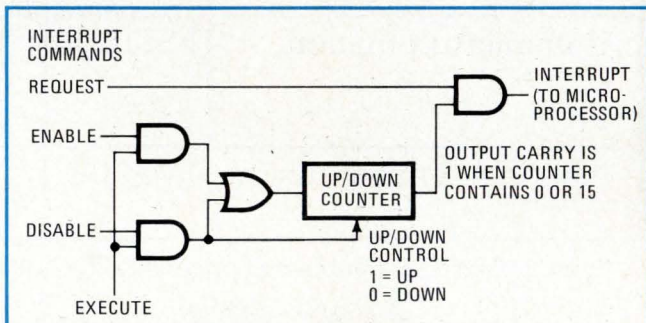

3. Counter for nesting. Successive disable and enable instructions step the counter respectively up and down. Only when enables have canceled previous disables can interrupts pass.

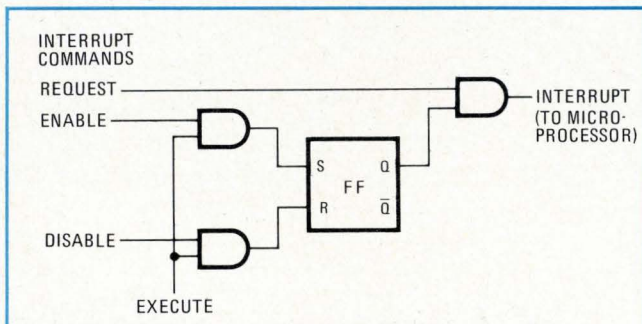

2. Interrupt gate. An enable instruction, stored in the flip-flop at execution time, permits subsequent interrupts to pass. A disable resets the flip-flop and blocks following interrupts.

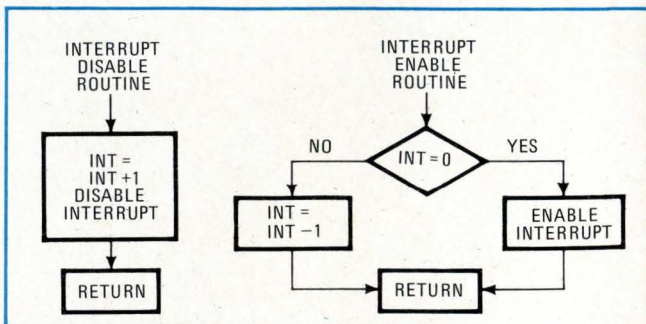

4. Software counter. These routines count the enables and disables as does the counter in Fig. 3, but the count is stored in a memory location called INT, rather than in a separate register.

Simple step-function generator aids in testing instruments

by Michael M. Lacefield
Honeywell Inc., New Orleans, La.

Three integrated circuits plus a few discrete components will generate step functions that are useful, for example, in the life testing or unattended functional checking of potentiometric recorders, controllers, and transmitters. The values of individual components in the circuitry can be varied to provide different step timings, output amplitudes, and step-to-step ratios.

With the component values shown in Fig. 1, the cir-

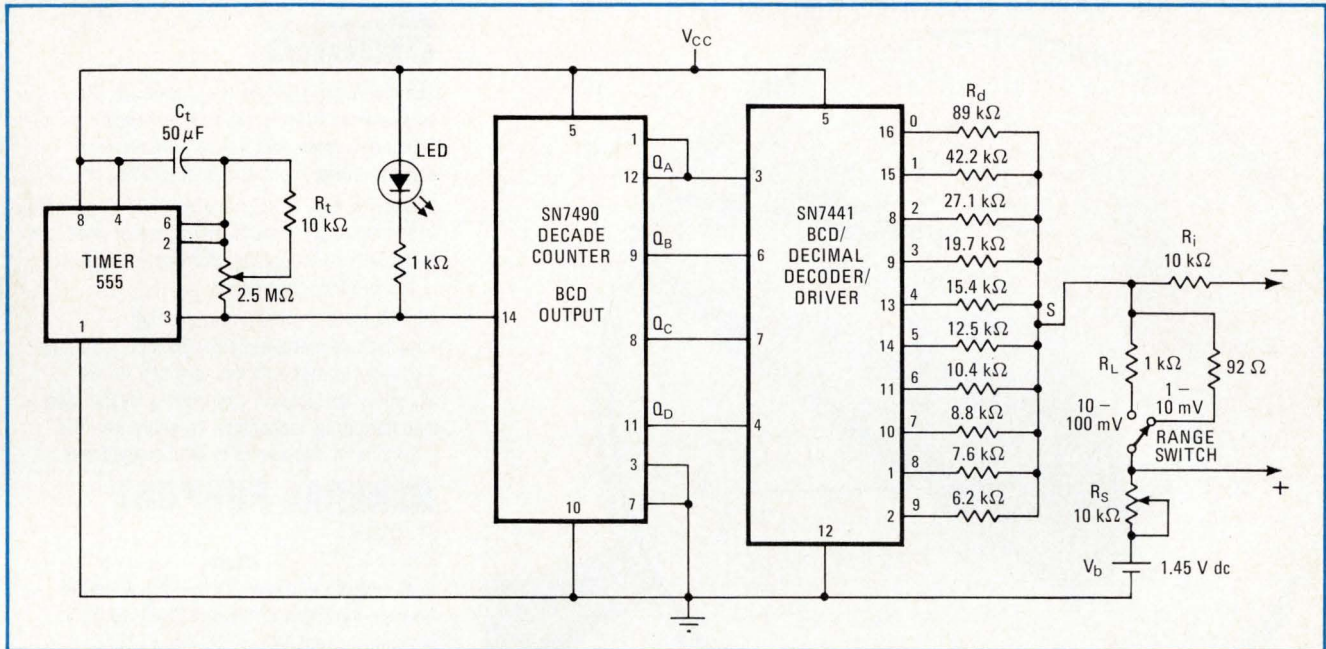

1. Function generator. Successively lower resistances at the decoder outputs create a stairstep function for testing instruments of various kinds. A different sequence of resistances, or a set of variable resistors, generates different kinds of step functions.

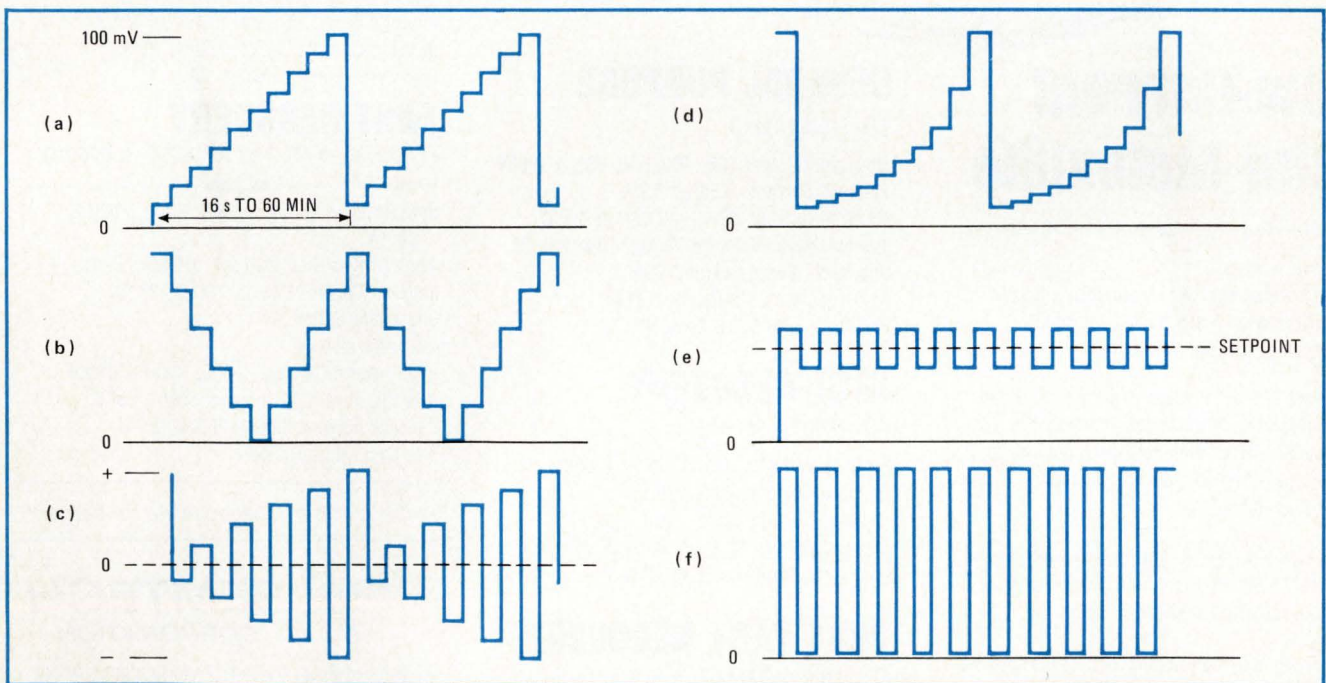

2. Variety. The circuit of Fig. 1 generates many waveshapes, variants of the basic stairstep waveform (a), which ranges from 5 to 120 millivolts and lasts anywhere from 16 seconds to 60 minutes. Increasing and decreasing steps (b) test electrical and mechanical balancing functions. Ever-increasing step amplitudes, either with a center zero (c), or all positive (d), test the response to such steps. Ordinary square waves of large (e) and small (f) amplitudes check positive and negative excursions from setpoints, large-scale process-variable changes, and mechanical drive assemblies. Waveshapes (c), (d), and (f) also check for response to full-scale retrace of function.

NEW MINI-METOXILITE SILICON RECTIFIERS

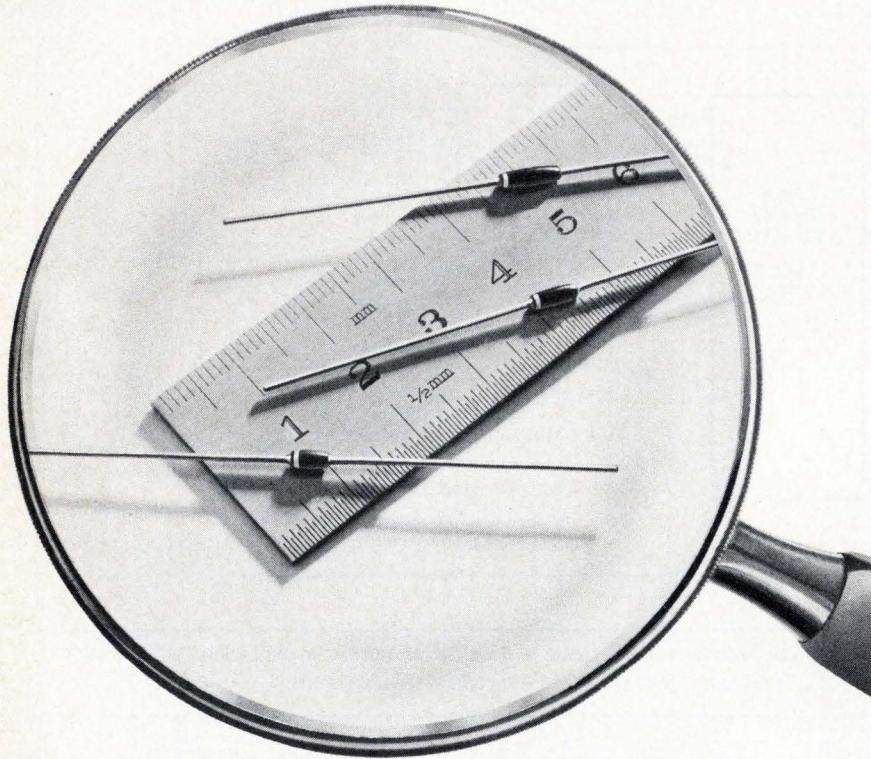

Low-Current Mini-Metoxilite

New low current, Mini-Metoxilite silicon rectifiers are ideally suited for small modular electronic packaging.

Through the application of new design and manufacturing techniques Semtech has produced these Mini-Metoxilite devices to guarantee the ultimate in hermeticity and ruggedness.

The metal oxides, which form the outer case, are fused directly to the high temperature metallurgically bonded assembly.

These devices meet or exceed environmental requirements of current military and space program specifications.

Devices maximum dimensions are:
body — .165" long by .070" in diameter;
leads — 1.25" long by .021" in diameter.

GENERAL PURPOSE

(*T_{rr}*) 2 μ S (Max.)

Reverse Voltage: 200, 400, 600, 800 & 1000V.
Forward Current: 0.5A @ 55°C.
Reverse Current (Max.): 100nA @ 25°C.
Instantaneous Forward Voltage (Max.): 1.0V.
One Cycle Surge Current: 25A.
Also supplied as JAN, JTX & JTXV.
1N645-1, 1N646-1 & 1N647-1.

FAST RECOVERY

(*T_{rr}*) 150 ns (Max.)

Reverse Voltage: 100, 200, 400 & 500V.
Forward Current: 0.5A @ 55°C.
Reverse Current (Max.): 250nA @ 25°C.
Forward Voltage @ 0.5A, 25°C (Max.): 1.2V.
One Cycle Surge Current: 12.5A.

VERY FAST RECOVERY

(*T_{rr}*) 100 ns (Max.)

Reverse Voltage: 100, 200, 400 & 500V.
Forward Current: 0.5A @ 55°C.
Reverse Current (Max.): 250nA @ 25°C.
Forward Voltage @ 0.5A, 25°C (Max.): 1.2V.
One Cycle Surge Current: 12.5A.

High Voltage Mini-Metoxilite Stacks

Semtech's Mini-Metoxilite stacks are the smallest rectifier stacks in the industry to meet or exceed environmental requirements of current military and space programs.

Measuring only .215" long by .070" in diameter (maximum body dimensions) these devices are suitable for all applications where reliability is the primary consideration.

Mini-Metoxilite stacks feature high temperature metallurgically bonded junctions. A coating of metal oxides is fused to the assembly surfaces by proprietary design and manufacturing techniques to guarantee the maximum in hermeticity and ruggedness.

GENERAL PURPOSE

(*T_{rr}*) 2 μ s

Peak Inverse Voltage: 2000, 3000 & 4000V.
Average Rectified Current: 125MA @ 55°C.
Reverse Current (Max.): 100nA, 25°C.
One Cycle Surge Current: 7A.
Available also . . .
Peak Inverse Voltage: 5000 & 6000V.
Average Rectified Current: 5A @ 55°C.
Reverse Current (Max.): 250nA, 25°C.
One Cycle Surge Current: 5A.

FAST RECOVERY

(*T_{rr}*) 250 ns (300 ns for 4000 to 6000V)

Peak Inverse Voltage: 1500, 2000, 2500 & 3000V.
Average Rectified Current: 100MA, 55°C.
Reverse Current (Max.): 100nA, 25°C.
One Cycle Surge: 5A.
Available also . . .
Peak Inverse Voltage: 4000, 5000 & 6000V.
Average Rectified Current: 50MA, 25°C.
Reverse Current (Max.): 250nA, 25°C.
One Cycle Surge: 2.5A.

"We're number 1 because we try harder"



SEMTECH
CORPORATION

652 Mitchell Road, Newbury Park, California 91320
(805) 498-2111, (213) 628-5392 / TWX: 910-336-1264

CHICAGO: (312) 352-3227
DALLAS: (214) 253-7644
FLORIDA: (305) 644-5404
NEW JERSEY: (201) 654-4884
SAN FRANCISCO: (415) 328-8025
EUROPEAN SALES HDQ: Bourns AG Zug,
Switzerland (042) 232-242

cuit generates a staircase function with 10 equally spaced, ascending steps of equal height, covering a total range of either 5 to 12 or 50 to 120 millivolts, depending on the setting of the range switch and potentiometer R_s . The spacing between steps ranges from 1.6 seconds to 6 minutes, so that the total time for the complete staircase is 16 s to 60 min, depending on the setting of the potentiometer on the timer.

The circuit is based on the 555 timer configured as an astable multivibrator. In this configuration, the timer's output remains low for about a third of the complete cycle and high for the other two thirds; the length of the cycle is determined by the value of the capacitor C_t and the setting of the 2.5-megohm potentiometer; the minimum length, as mentioned, is 1.6 s. The 10-kilohm resistor R_t is added to the potentiometer wiper so that the total resistance tapers properly for particular instruments that need it. The light-emitting diode is a visual indicator that the timer is operating; it is on whenever the time output is low.

Every negative-going transition from the timer increments the decade counter, which steps from 0 to 9 repeatedly and produces its outputs in binary-coded decimal form, on lines Q_A through Q_D . These are translated into the low state on the 10 individual outputs of the

BCD-to-decimal decoder/driver. Thus the 10 progressively lower resistance values R_d are successively coupled into the divider network $R_d:R_L:R_s$, so that the voltage at the summing point S is a staircase waveform, developed across R_L . This waveform is fed to the device under test through the isolation resistor, R_i .

The diagram shows a reference voltage V_b generated by a mercury cell at 1.45 volts, but any convenient battery or power supply can be used, provided only that it meets the requirements of the application and does not overload the decoder. The decoder's rating of 70 v and 7 milliamperes leaves plenty of latitude in the choice of power sources.

The component values shown provide fixed 10% increments in the staircase, which is suitable for testing most instruments. However, different values of resistors at R_d will change the increments. In fact, variable resistors can be used if the shape of the waveform is to be frequently changed—for example, in testing recorder inking systems, intermittent amplifiers or transmitters, or worn mechanical servo assemblies. The basic waveform and a few variations are shown in Fig. 2. □

Engineer's Notebook is a regular feature in Electronics. We invite readers to submit original design shortcuts, calculation aids, measurement and test techniques, and other ideas for saving engineering time or cost. We'll pay \$50 for each item published.

Timer IC and photocell can vary LED brightness

by F. E. Hinkle and Jim Edrington
Applied Research Laboratories, University of Texas, Austin

The relative brightness of a light-emitting-diode display can be varied automatically by combining a cadmium-sulfide photocell and a 555 timer into a pulse-width-modulated astable multivibrator. Such variability is obviously important in aircraft and automotive instrumentation, as well as in calculators and digital watches, or wherever ambient light conditions vary.

The circuit is the standard astable configuration for the 555, with two modifications: the photocell replaces one of the timing resistors, so that ambient light controls the duty cycle of the astable oscillator; and diode D_1 bypasses the 15-kilohm timing resistor during the charging of the timing capacitor, increasing the maximum duty cycle of the 555 beyond the normal 50% limit, and allowing the display to obtain full brightness.

As increasing ambient light level decreases the photocell's resistance, the timer's duty cycle increases. The varying duty cycle controls the length of time the display drivers are on, and this controls the brightness.

This circuit varies the duty cycle from less than 5% in total darkness to more than 90% in sunlight. Manually setting control R_1 establishes the minimum brightness level in total darkness; if such adjustment is considered unnecessary in a particular application, R_1 could be replaced with a fixed resistor. □

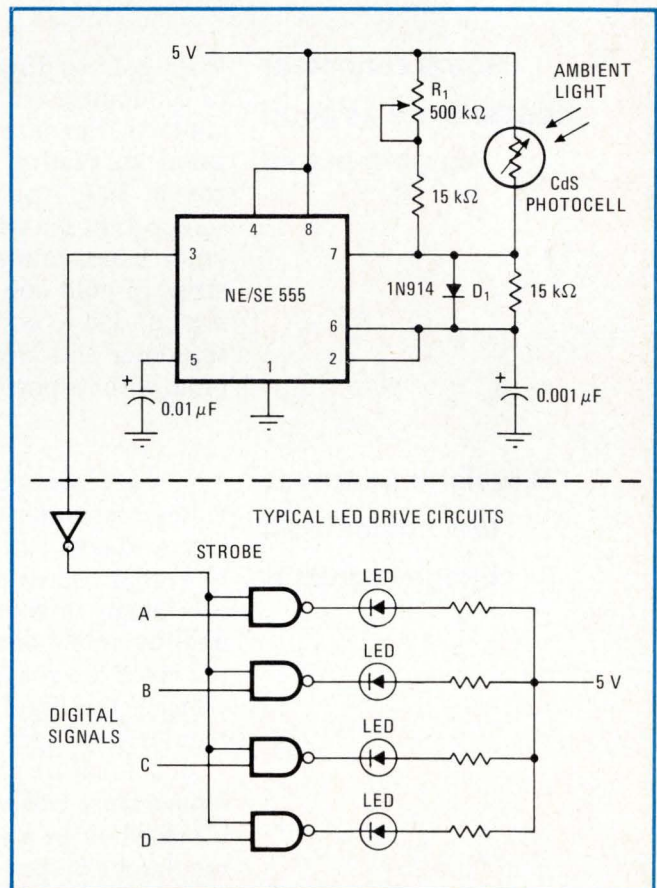

Fader. Brightness of LED display is varied by using a photocell in place of one timing resistor in a 555 timer, and bypassing the other timing resistor to boost the timer's maximum duty cycle. Result is brighter display in sunlight, fainter in the dark.

Microprocessors in a nutshell

Microprocessors are multiplying fast. **Already at least 26—count 'em, 26—different models are available or will shortly become available** in at least sample quantities. Here's the line-up: Intel has five models—two 4-bit sets, two 8-bit sets, and a bipolar slice job; National has five—three IMPs, its GPC/P, and **a single-chip 16-bit model**; Rockwell has a 4-bit and an 8-bit p-channel set; RCA and Intersil have C-MOS versions; Motorola has an **8-bit n-channel device**, as do Fairchild, Signetics, Electronic Arrays, Microsystems International Ltd., and Toshiba, whose product has **a 12-bit word length**; Mostek's 8-bit device, Burroughs' 8-bit device, and Fairchild's 4-bit CPU are all p-channel systems, and, finally, Monolithic Memories, Raytheon, and Transitron all offer **4-bit bipolar microprocessor sets**.

The various overlapping and often confusing properties of these devices are neatly summarized in a colorful wall-size Microprocessor Scorecard published by Microcomputer Technique Inc. of Reston, Va. The scorecard is bound into the September issue of the consulting company's New Logic Notebook, along with a page-size black-and-white reproduction. It costs \$95 to subscribe to the notebook, which **describes all available microprocessors in detail and includes user design information each**.

Some connector contacts are as good as gold-plated

With gold soaring in price, connector manufacturers are being forced to economize on their use of it—or even find other metals for plating contacts. For instance, Jermyn of San Francisco, Calif., has gone to a **tin-nickel plating that is said to reduce contact resistance by 20% and cost by 10%**. Apparently, contact oxidation is negligible, and there's no solder-joint embrittlement. Vector Electronic of Sylmar, Calif., on the other hand, minimizes the amount of gold needed by **using wrought strips of gold only where device leads contact the terminal**. The strips are bonded to contacts of copper-nickel alloy and, being wrought, are smoother and have a lower contact resistance than conventional gold plate with its porous surface.

A resistor improves that customized voltage regulator

This page two weeks ago described how to make a three-terminal IC voltage regulator operate at a voltage level other than its specified rating. And now Peter H. Helmers of Metapiana Enterprises in Rochester, N.Y., has come up with an addition to the technique. **The original idea was simply to connect a zener diode between the regulator's ground pin and the actual power-supply ground** in order to create a voltage pedestal; since the zener voltage simply offsets the regulator's normal output voltage, the regulated output becomes the sum of the zener and the regulator voltages.

But to assure that the zener remains insensitive to any variations in temperature and load current, Helmers points out that it's best to keep it biased on by a substantial margin. A resistor connected between the regulator's output pin and the zener's cathode is all that's needed. **For a 5-v regulator and a 4-v zener, the resistor should be about 270 ohms.** The reverse bias current flowing through the zener will then be around 25 mA, making the regulation of the offset output voltage about as good as that of the regulator alone.

—Laurence Altman

Way to go

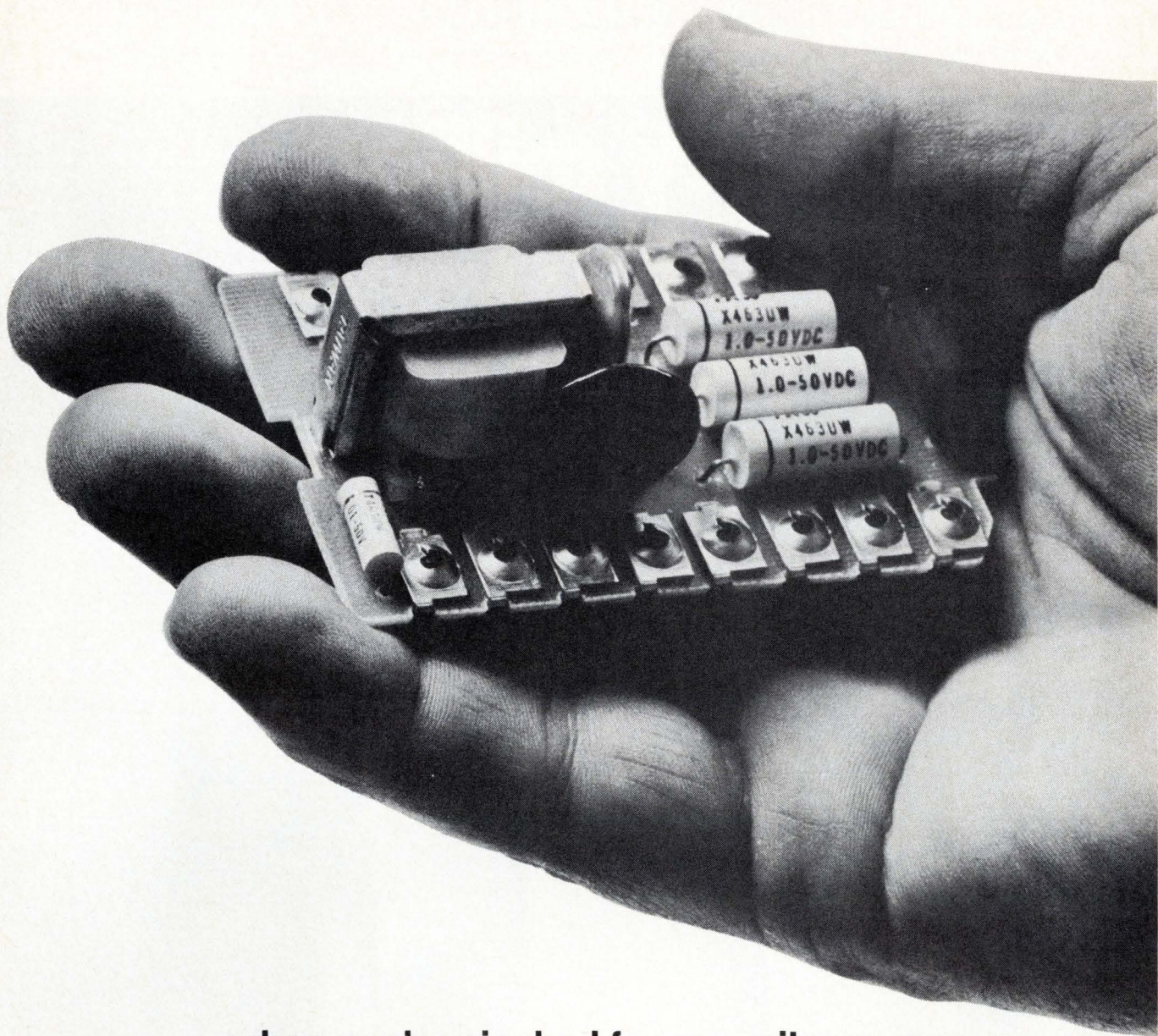

...when you're pinched for capacitor space

Way to go is with TRW X463UW metallized *polycarbonate* subminiatures. These capacitors give you the size and weight savings you expect with a metallized dielectric, *plus* the improved electrical performance of polycarbonate.

For example. Less than 1.5% capacitance change from -55°C through $+125^{\circ}\text{C}$ (with no voltage derating). Dissipation factor of less than 0.3% at $+25^{\circ}\text{C}$ and 1 KHz. IR of 60,000 megohm x mfd minimum at $+25^{\circ}\text{C}$. Stability 2-3 times better than polysulfone in humidity and shelf life tests.

Capacitances from .001 to 10.0 mfd (higher for special applications)—in 50, 100, 200 and 400 vdc. Real "problem solvers," these—for precision circuitry demanding real stability combined with smallest possible size.

Write for catalog or application engineering assistance. TRW Capacitors, an Electronic Components Division of TRW, Inc., Box 1000, Ogallala, Neb. 69153. (308) 284-3611.

TRW CAPACITORS

Crank up this high-performance machine and you'll have 30 MHz at your command. Enough frequency for about any test situation you can name.

Of course top end isn't everything. The Wavetek 164 has the sophistication to maneuver smoothly on anybody's test bench.

You can shift to any of nine

different waveforms in continuous, triggered or gated modes. Drop to 3 μ Hz and then run up the entire range in 1000 to 1 sweeps or discrete 10% steps. You can even adjust rise-and-fall times with the unique trapezoidal waveform.

The price is \$1,095*. A bit more than average. But a few minutes at the controls will convince you

that the Model 164 is no average function generator.

*F.O.B. San Diego, wheels optional at extra cost.

WAVETEK®

P.O. Box 651
San Diego, California 92112
Tel. (714) 279-2200, TWX 910-335-2007

Circle 108 on reader service card

Thirty million Hertz puts you in the driver's seat.

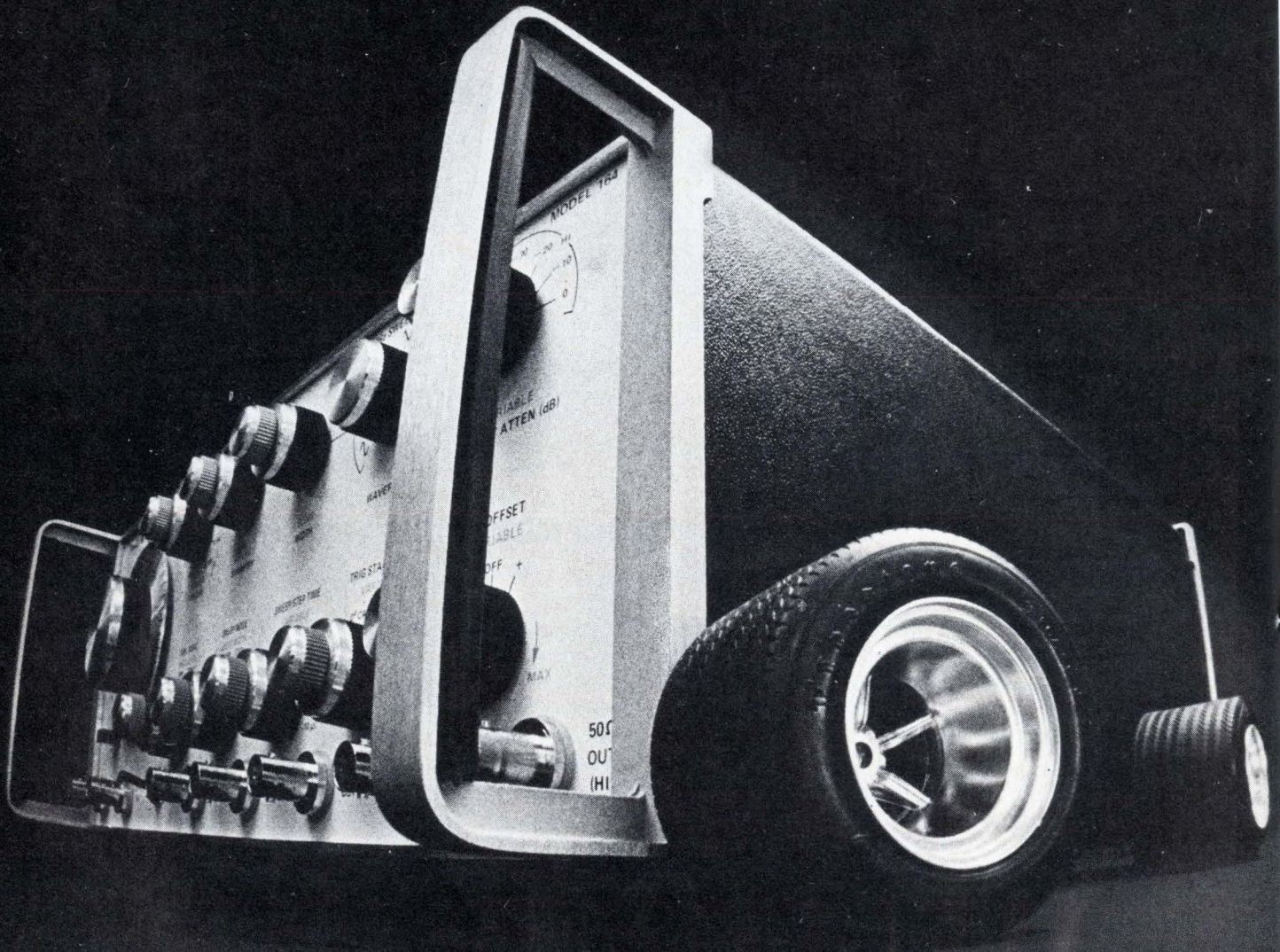

New products

Programmable calculator costs \$395

Shirt-pocket machine has total of 86 keyboard functions, 49 steps of program memory, 20 addressable memories, and a 100-hour digital timer

by Michael J. Riezenman, *New Products Editor*

Like the HP-35 and -45 before it, Hewlett-Packard's HP-55 is a shirt-pocket calculator and, like them at their introduction, it has a \$395 price tag. Unlike the earlier models, the new machine is programmable. It has 49 steps of program memory, plus branching, testing, and editing capabilities. A built-in timer can also store and recall up to 10 elapsed-time readings.

Unlike the more-expensive (\$795) HP-65, the model 55 has no provision for storing programs permanently on magnetic cards. When the calculator is shut off, the program is cleared from the memory, and must be reentered to be used again. However, the model 55 has considerably more preprogrammed functions than any previous pocket calculator: 86, compared with 51 for the -65 and 44 for the -45. And the model 55 has 20 addressable memories, 10 of which can be used to perform register arithmetic. Earlier H-P pocket calculators had a maximum of nine addressable memories.

Perhaps the most unusual feature of the HP-55 is its inclusion of a digital timer—essentially a high-quality digital stopwatch—which uses a crystal-controlled oscillator to measure intervals as long as 100 hours with a resolution of 0.01 second, and a maximum error of $\pm 0.01\%$.

While the timer is running, the user can acquire and store as many as 10 splits (elapsed-time readings within an event) simply by pushing digit keys 0 through 9. After the timer is stopped, the splits may be recalled and manipulated like any other data.

Like other H-P pocket calculators, the HP-55 uses the RPN (reverse Pol-

ish notation) logic system with a four-memory operational stack of registers that holds intermediate answers and brings them back when they are needed in a calculation. It can work in three trigonometric modes: degrees, radians, and grads, and the user can convert from any one to any other. The machine will add and subtract degrees, minutes, and seconds (DMS), and can convert decimal degrees to DMS and vice versa. Single-keystroke polar-to-rectangular and rectangular-to-polar conversions are also included.

The HP-55's statistical functions, along with its 20 addressable memories, make possible the easy calculation of two-variable mean and standard deviations, as well as the performance of linear regression, linear estimate, and curve-plotting calculations. Further, the calculator can solve a set of four linear equations with four unknowns.

Unlike the HP-45, which is preprogrammed with constants for use in English/metric conversions, the HP-55 ac-

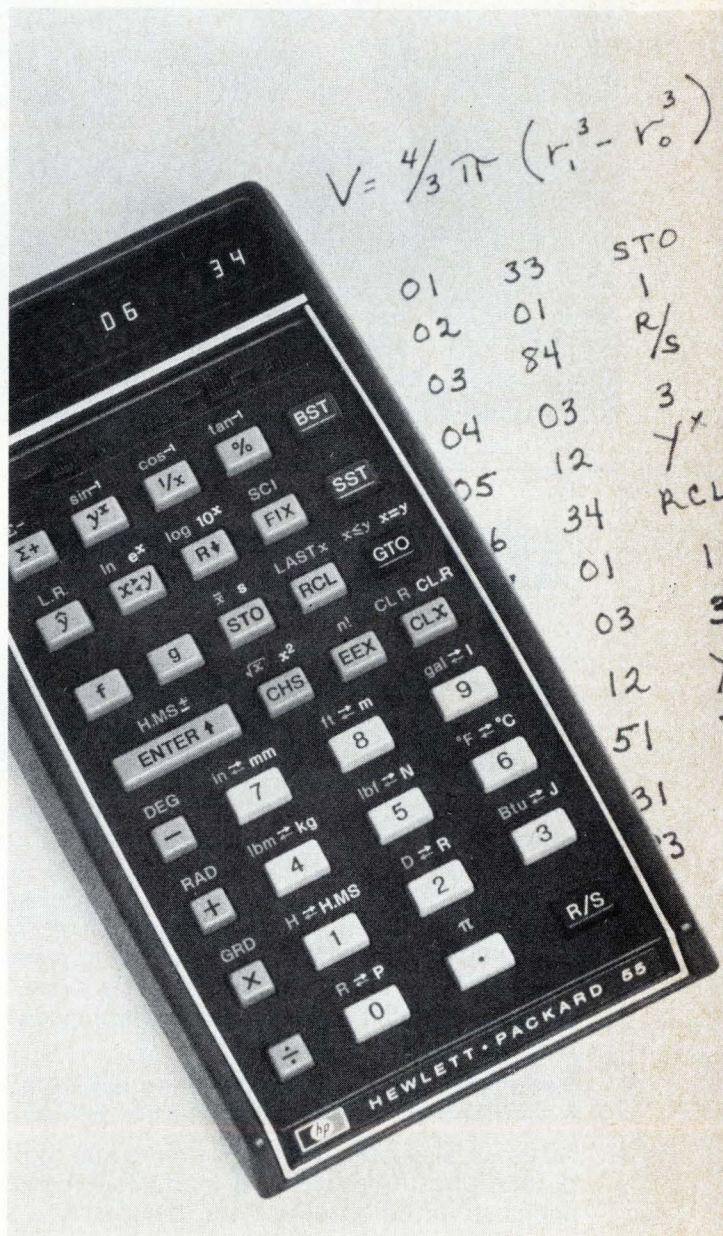

Programmable. Able to store programs as long as 49 steps, the \$395 HP-55 is aimed at the gap between the HP-45 advanced scientific calculator, which costs \$325, and the magnetic-card-programable HP-65, at \$795.

CUSTOM ELECTRONICS' MICA CAPACITORS: short on DELIVERY long on RELIABILITY

That describes our CMR type capacitor, ideal for "potted-in" applications where minimum size and low per-unit cost are important. All our dielectric is screened *before* production to avoid failure in the field.

Installation No.	TYPICAL UNITS:			1 to 10 Qty. Price
	Cap.	WVDC	L x W x T Max.	
CMRIA102104K	0.1 μ f	1,000	2.062" x 1.425" x 0.200"	\$8.05
CMRIA302104K	0.1 μ f	3,000	2.562" x 1.620" x 0.270"	9.25
CMRIA103103K	0.01 μ f	10,000	2.562" x 1.800" x 0.350"	8.80

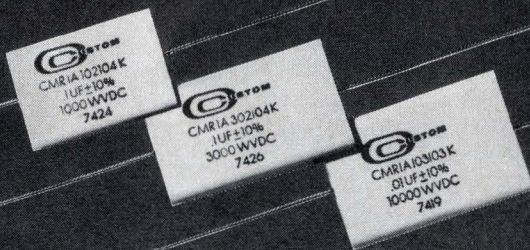

FREE: Descriptive TechniTip,
includes Mica Sample. Write:



CUSTOM ELECTRONICS, Inc.

12 Browne St., Oneonta, N.Y. 13820
PH: (607) 432-3880 TWX: 510-241-8292

Circle 110 on reader service card

the light fantastic

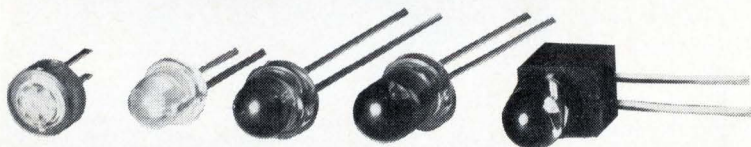

National Semiconductors Ltd. can now offer you a complete line of high efficiency, low current gallium phosphide LEDs. A sampling of our LED lamps available include the panel-mount MA 2300 series with its built-in lens/reflector system, typically producing 2 mcd luminous intensity at 5 mA, the MA 2400 series in the industry accepted panel-mount package, the low profile MA 2600 series, the side-viewing MA 2700 series, and the MA 2800 series in a wide viewing plastic TO-18 package.

Red and green LEDs are generally available in optional clear, clear diffused, tinted clear, or tinted diffused epoxy packages.

NSL can also offer you a complete line of photocells, photodiodes, phototransistors, optocouplers, optoelectronic arrays and customized optoelectronic devices.



NATIONAL SEMICONDUCTORS LTD

331 Cornelia St., Plattsburgh, N.Y. 12901; Tel.: (518) 561-3160
2150 Ward St., Montreal, Que., H4M 1T7; Tel.: (514) 744-5507;
TWX 610-421-3362

110 Circle 142 on reader service card

New products

tually performs the conversions with a single keystroke. The conversions include: inches and millimeters, feet and meters, U.S. gallons and liters, pounds mass and kilograms, pounds force and newtons, degrees fahrenheit and degrees celsius, and British thermal units and joules.

For ease of editing, debugging, and reviewing programs after they are written, the model 55 has a single-step key and a back-step key. While in the program mode, the calculator display shows a two-digit line number (from 00 to 49) and a two-digit keycode that tells what command or function was keyed in for that step. Thus, if the 24th step were the reciprocal function, the display would show "24 13," since the reciprocal key is the third key from the left in the first row of keys.

Branching is accomplished by the HP-55 in one of three ways: by means of an unconditional "GO TO" command, or by means of two conditional tests, "X-Y" or "X is less than or equal to Y" with the "GO TO" command implied. By comparison, the HP-65 has 100 steps of program memory and four conditional branching tests.

The 15-digit light-emitting-diode display can be formatted in a variety of ways at the user's discretion. It can show numbers in fixed-decimal-point or scientific notation, and can display from zero to nine places after the decimal point, in either mode, while the calculator maintains full accuracy internally, the company says.

The HP-55 is equipped with a special "Last X" storage register that enables a user to correct an error in arithmetic or in number-entry without having to start over in the middle of a lengthy calculation. The "Last X" register can also be used to compute multiple operations of the same argument.

The HP-55 weighs nine ounces and comes with an ac power-line adapter/recharger, an owner's guide, a quick-reference guide, and a program-notation pad.

Inquiries Manager, Hewlett-Packard Co., 1501 Page Mill Rd., Palo Alto, Calif. 94304 [338]

Electronics/December 26, 1974

Pushing C-MOS RAM up to 1 kilobit cuts price and power



Intersil device operates at 10 milliwatts with 10 nanowatts standby, yet access is fast—400 nanoseconds at 5 volts, nearly 80 ns at 10 V

by Bernard Cole, San Francisco bureau manager

Combining 1,024-bit memory density with very low power consumption is the idea behind the complementary-MOS random-access memories now beginning to hit the market. Intersil, early maker of C-MOS memories, appears to be the first to stock its distributors' shelves with production quantities of 1,024-bit C-MOS RAMs.

The rush is on to C-MOS RAMs for several reasons. Prime among them is the need to retain memory contents when the power goes off. C-MOS is considered a better solution than auxiliary core or programable-read-only-memory storage because very little power is used when the C-MOS memory system is not in operation. A low-power battery is all that is needed in most cases to assure that the memory is never lost [*Electronics*, Nov. 14, p. 42]. In addition, a C-MOS RAM is a static memory, needing no refresh clocks and only one power supply.

Intersil's fully decoded and buffered C-MOS silicon-gate RAM is organized as 1,024 words by 1 bit and is designated the IM6508/IM6518.

According to Joseph J. Zabkar, vice president of marketing at Intersil, the speed of the device "batters that of most n-channel 1-k RAMs now on the market. And it's not that far away from bipolar speeds under certain conditions." Although access time is specified at a maximum of 400 nanoseconds at 5 volts, the RAM can be typically accessed at 200 ns. And at 10 V it can be pushed as fast as 80 ns.

This speed is achieved with operating power that, says Zabkar, can only be termed phenomenal when compared with either bipolar or n-channel MOS memories. At 1 MHz, power consumption of the IM6508, he says, is less than 10 mW.

Standby. The other side of the power story—and the one that makes the new device so desirable for low-power applications or where nonvolatility is required—is standby-power dissipation.

According to Shep Hume, Intersil's C-MOS design manager, this is typically 10 nanowatts for the IM6508. For most n-channel RAMs operating in the 60- to 150-ns range,

standby-power-dissipation ratings are between 30 and 60 mW. For bipolars, the rating in the power-down mode, when there is one, is about 300 to 400 mW.

And for users of 1-k bipolar RAMs who are getting nervous about power consumption and are looking for an alternative that can be easily merged into their existing systems without sacrificing too much speed, Intersil has made both its 16-pin version (IM6508) and 18-pin version (IM6518) pin-for-pin compatible with bipolar counterparts.

Other attractive features of the memory, says Zabkar, include high noise immunity, TTL compatibility on inputs and output, a supply-voltage operating range from 3 to 7 V, an on-chip address register, and an operating range of 0°C to 70°C for commercial units and -55°C to +125°C for the military version.

The 100-piece price for the commercial version of the IM6508/6518 is \$62 each; the militarized version is \$98.75 each.

Intersil Inc., 10900 N. Tantau Ave., Cupertino, Calif. 95014 [339]

Components

Logic can drive relay directly

Electromechanical device handles 3-A loads, needs only 5 mW of coil power

Relay manufacturers have been rushing to bring out hybrid solid-state relays as an answer to today's need for interfacing with popular logic families. But the hybrid versions, which contain built-in amplifiers, are expensive, and they often require an external power supply to bias the relay's coil to just underneath its pickup point. Now, however, Potter & Brumfield has developed a highly sensitive electro-

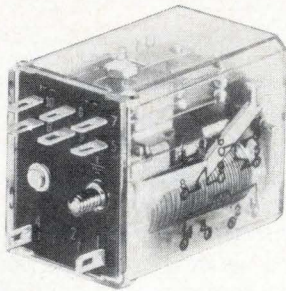

mechanical relay that offers high-power-handling capability, and it can be driven directly by diode-transistor, transistor-transistor, emitter-coupled, or high-threshold logic—without buffer networks.

Designated the R10S, this current-sensitive relay comes in 1-, 2-, 3-, and 4-pole, double-throw versions that will switch resistive loads from dry circuit up to 3 amperes maximum at 28 volts dc. Maximum power needed to activate the relay is only 5 milliwatts per contact pair. A single form C (single-pole, double-throw) contact pair with a 1-kilohm coil, for example, requires a maximum pickup current of 2.3 milliamperes, while four form C contacts with a 1-kilohm coil require over 4.5. Coil resistances range from 500

ohms as high as 30 kilohms.

Drop-out is a minimum of 10% of the actual pickup current. The initial breakdown voltage is rated at 500 v rms across the contact gaps. Typical capacitance values are 2 picofarads contact to contact, as well as coil to contacts; and 30 pF coil to frame.

Mechanical contact-life expectancy is 100 million operations, and at full electrical load, the relay can be cycled at least 100,000 times. The R10S is offered with printed-circuit board, solder, or octal-type terminations, and sockets are available. A two-pole unit measures 1.5 inches high by 0.735 in. wide by 0.95 in. long.

The new relay is considerably cheaper than its solid-state counterparts. Furthermore, because solid-state relays are generally available with only one form A (single-pole, normally open) contact pair, additional systems savings can be achieved by using multi-pole configurations of the R10S. Finally, the device's low power consumption makes it attractive even when a logic interface is not required.

The new relay will be available from distributor stock in January. It will list from \$4.60 to \$5.60 in unit quantities, depending on coil and contact configuration.

Potter and Brumfield Division, AMF Inc., 1200 E. Broadway, Princeton, Ind. 47670 [341]

Potentiometer-switch modules have plastic parts

Four years ago, Allen-Bradley Co. of Milwaukee introduced its modular series 70 potentiometers and switches, which give the user millions of different possible combinations from which to choose. Now Allen-Bradley is extending the MOD POT line by adding its series 72 controls. These units, which have plastic shafts and bushings for electrical isolation, are intended for high-voltage applications.

The potentiometers contain carbon-composition resistive elements,

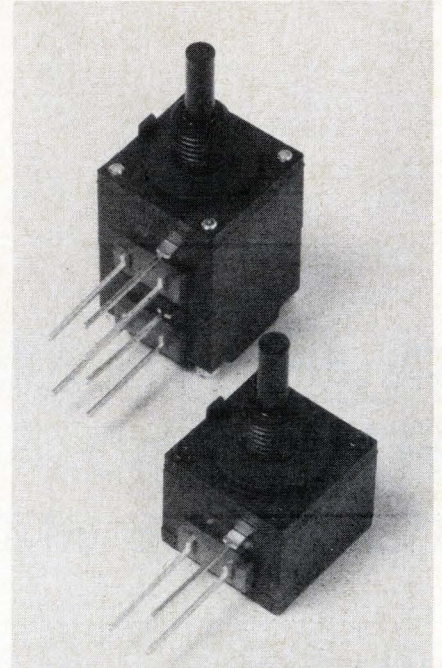

ranging in value from 50 ohms to 10 megohms, with tolerances of $\pm 10\%$ or $\pm 20\%$. A full selection of complementary switches is available. A single control can consist of one or two sections.

Like the older series 70 controls, the series 72 devices are $\frac{3}{8}$ inch square. Each section is rated at 0.5 watt, and operating temperature range is -55°C to $+100^{\circ}\text{C}$. The new MOD POT line is priced competitively, and delivery time is six to eight weeks.

Allen-Bradley is also introducing a kit of its older series 70 units, to become available in January. The kit contains a selection of components for building up to 20 controls. Tools, fixtures, lubricants, and an instruction manual are included in the kit, which is supplied in a desktop container. Price will be approximately \$95.

Allen-Bradley Co., Electronics Division, 1201 South Second St., Milwaukee, Wis. [342]

Relays occupy 1.2 cubic inches, handle up to 10 A

The HC series of miniature relays can occupy as little as 1.2 cubic inches but have large current-

New products

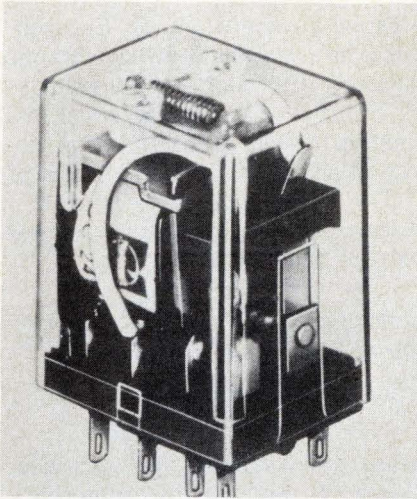

switching capabilities—10 amperes for the single-pole, double-throw unit, up to 7 A for the double-pole, double-throw version, and up to 5 A for the four-pole, double-throw relay. The four-pole double-throw version is believed to be the only relay of its kind. All the current ratings are for resistive loads and for voltages of 240 v ac. Coil voltages range from 6 to 240 v ac or 6 to 110 v dc. Plug-in, printed-circuit-board, and direct chassis-mounting type terminal arrangements are standard, as is a broad range of socket mounts. The relays, which all have a life expectancy in excess of 10^8 mechanical operations, are available with hermetically sealed plastic cases. Small-quantity prices range from \$2 to \$6, depending upon contact arrangement and voltage; delivery is from stock.

Arrow-M Corp., 250 Sheffield St., Mountainside, N. J. 07092 [343]

Multiple pc-board switches can be custom-designed

Designed for use in avionics, industrial, and instrumentation equipment, a multiple rotary printed-cir-

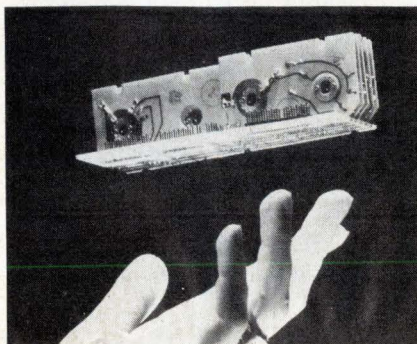

cuit-board switch has metal edge-mount terminals for easy insertion into a pc motherboard, thus eliminating expensive hand wiring. The ganged switch can be custom-designed to fit into limited space. Switch choices include any circuitry pattern desired, and as many wafer decks as necessary, with up to 20 positions per deck. Resistors, diodes, and similar components can be added to switch boards to form complete function modules.

Standard Grigsby Inc., 920 Rathbone Ave., Aurora, Ill. 60507 [345]

DIP resistor network has 14, 16, or 18 pins

Unlike other thick-film resistor networks packaged in dual in-line packages, Dale LDP networks are available with 14 and 18 leads, as well as in the standard 16-pin configuration. They are offered in a

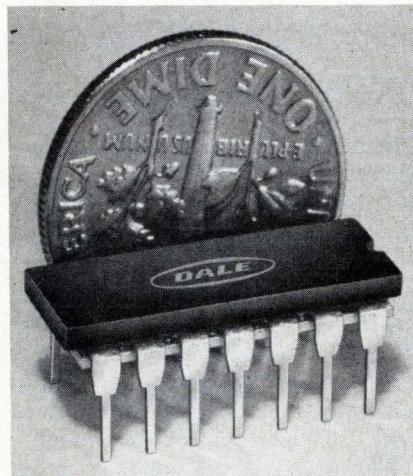

range of resistances from 10 ohms to 1 megohm and have a maximum temperature coefficient of ± 250 parts per million per degree Celsius. Tolerances as tight as 1% are available, as well as 2, 5, 10 and 20%. Ratio matching to within 0.5%, and temperature-coefficient tracking to within 50 ppm/ $^{\circ}$ C are available on special request. Power ratings, based on a maximum per-resistor dissipation of 0.125 watt at 70 $^{\circ}$ C, are 1 w for 14-pin models, 1.125 w for 16-pin units, and 1.25 w for the 18-pin

devices. The price of a typical LDP (14 pins, 13 resistors, 10% tolerance) is 68¢ each in lots of 1,000.

Dale Electronics Inc., Box 74, Norfolk, Neb. 68701 [344]

Push-button switches have LED illumination

A series of push-button switches is internally illuminated by a red light-emitting diode. The LED, which operates on 6 volts dc, has a 180 $^{\circ}$ viewing angle and requires no external dropping resistor because

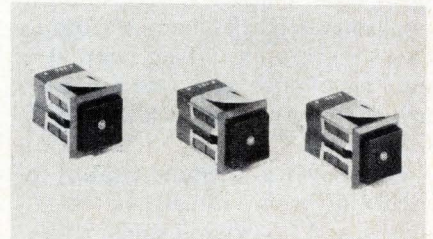

one is built into the unit. The series DUS switches are single-pole, single-throw, normally open devices with silver-plated brass terminals. They are rated at 250 milliamperes, 30 watts maximum, under noninductive ac loads. Small-quantity price is \$5.

Switchcraft Inc., 5555 No. Elston Ave., Chicago, Ill. 60630 [346]

Four-inch CRT is built for low-cost oscilloscopes

A 4-inch-diameter round cathode-ray tube has deflection-voltage requirements that have purposely been held within the capabilities of ordinary transistor circuits. Its horizontal sensitivity, for example, is 26 volts per centimeter at a final anode voltage of 1,500 v. The gun of the Brimar D10-230 produces a line 0.012 in. wide. Manufactured by Thorn Radio Tubes and Valves Ltd., the CRT has an over-all length of 10.25 in. The useful screen area measures 3.25 by 2.5 in.

The Inter-Technical Group Inc., P. O. Box 23, Irvington, N. Y. 10533 [348]

Semiconductors

Microcomputers emphasize I/O

Family of four systems aimed at communications and control applications

In some control and communications applications for microcomputers, data processing capacity is not nearly as important as input/output efficiency. Scientific Micro Systems, a subsidiary of Corning Glass Works, is taking aim at a number of such applications with a family of four systems called MicroControllers.

Applications include control of machine tools, intelligent instruments, and peripherals and communications tasks such as data acquisition, switching, and concentration.

Each of the four microcomputers, with modifications dependent on specific applications, contains the following: a microprocessor with an instruction time of 300 nanoseconds; up to 4,096 words of ROM/PROM program storage; up to 256 bytes of RAM working storage; and—most importantly—from 32 to 224 individually addressed I/O connection points. Prices range from about \$385 in 100 quantities for the basic System 10 MicroController to \$1,580 for the top-of-the-line fully implemented System 40. Each package contains three hermetic ceramic modules: the processor (containing the program storage, a program counter, an arithmetic logic unit, and 12 registers having a repertoire of eight instructions), the interface vector (a program-addressable, buffered connection between the controlled elements of a user's system and the MicroController), and the working storage module.

"What all this means," says James Geers, marketing vice president, "is that control, status, and data lines of user devices are immediately accessible by the MicroController pro-

gram. There's no speed penalty for talking with the outside world because the input data is treated with the same speed the internal registers are operating at—300 nanoseconds."

I/O data may be addressed in various field sizes, from a single bit up to 8 bits. This feature means, Geers says, "that only those control and status points of immediate interest may be directly accessed without masking."

Scientific Micro Systems has also checked out the architecture in a MSI prototype, which will be made available as a MicroController simulator for program modification and control during MicroController system debugging. Using a symbolic programming language, the system can be programmed, says Geers, with an assembler-level instruction set, reducing concept-to-manufacturing time as much as 50%.

Scientific Micro Systems, 520 Clyde Ave., Mountain View, Calif. 94043 [411]

1-gigahertz counter built for logic uses

A counter from Motorola Semiconductor is said to be the first 1-gigahertz unit that is a true decade counting unit and not merely a pre-scaling divider. Designed for such high-frequency-logic applications as direct frequency synthesis, the MC1696 biquinary decade counter has a typical maximum frequency of 1.2 GHz and a typical input sensitivity of 800 millivolts peak to peak.

The new counter includes reset and clock-enable inputs and divide-by-10 and binary-coded decimal outputs. The BCD outputs cannot follow the 1-GHz input all the way to the top of the frequency range, but can be read a few nanoseconds after the unit stops counting. The real-time divide-by-10 output operates all the way up to 100 megahertz with a duty cycle that is 60% high and 40% low. The output is direct-coupled, while the input is ac-coupled and is internally biased.

Unlike some other 1-GHz dividers, the MC1696 will not oscillate

without an input signal. Encapsulated in a standard 16-pin ceramic package, it requires supply voltages of -7 and -5.2 v. Typical power dissipation is 650 milliwatts. The device is priced at \$89 each in lots of 100.

Motorola Semiconductor Products Inc., Box 20912, Phoenix, Ariz. 85036 [412]

Microcomputer system runs on one 5-V supply

Right on schedule [*Electronics*, March 7, pp. 29-30], Motorola's M6800 microcomputer system, which can operate from a single 5-volt supply, is moving out of the sampling stage and into full produc-

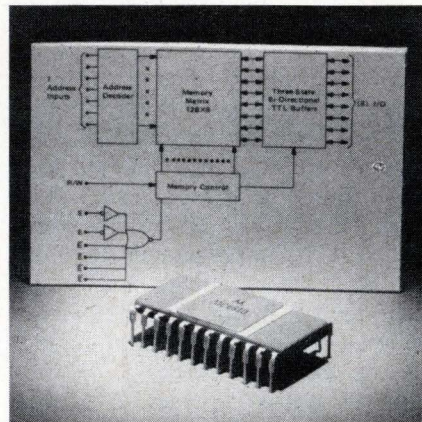

tion. Five of the system components are immediately available: the MC6800 microprocessor unit (MPU) itself, the MCM6810 128-word-by-8-bit random-access memory, the MCM6830 1,024-word-by-8-bit read-only memory, the MC6820 peripheral interface adapter (PIA), and the MC6860 modem. All are TTL-compatible, n-channel MOS silicon-gate devices. The PIA, which provides a means for interfacing peripheral equipment with the MPU, contains six registers which are available to the MPU via a bidirectional 8-bit bus. The PIA, housed in a 40-pin ceramic dual in-line package, costs \$28 each in small quantities. The single-chip modem, which operates at 0 to 600 bits per second, employs frequency-shift keying for communicating over

voice-grade telephone lines. Housed in a 24-pin ceramic DIP, it has a small-quantity price of \$75 each. Other small-quantity prices are: \$360 for the MPU, \$35 for the ROM, and \$30.50 for the RAM. Actually, the RAM comes in two versions: the MCM6810L, with a maximum access time of 1 microsecond, costs \$30.50, and the MCM6810L-1, rated at 600 nanoseconds, goes for \$37.50.

Technical Information Center, Motorola Inc., Semiconductor Products Division, P. O. Box 20294, Phoenix, Ariz. 85036 [413]

LED displays go orange

Orange light-emitting-diode displays have joined the ranks of red, yellow, and green units as standard commercial products. Designated the MAN3600 series, Monsanto's orange displays are 0.3-inch devices that are electrically and mechanically compatible with other standard displays. Prices at the 1,000-quantity level are also the same—\$2.20 each. The MAN3600 units radiate at a wavelength of 630 nanometers (red is 650 nm, and yellow is 590 nm), and have a typical luminous intensity of 1,200 microcandelas at a current of 10 milliamperes per segment.

Monsanto Commercial Products Co., 3400 Hillview Ave., Palo Alto, Calif. 94304 [414]

Circuit demodulates a-m, fm, or SSB signals

Capable of acting as a synchronous detector for amplitude-modulated signals, a quadrature detector for frequency modulation, and a prod-

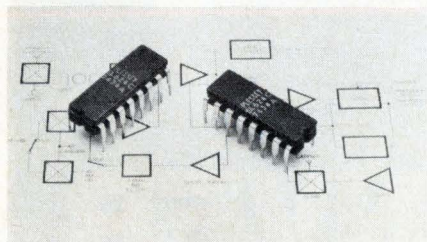

NO ONE

Customizes Switches Like CDI
Nor Has a More Complete Line

THUMBWHEEL SWITCHES

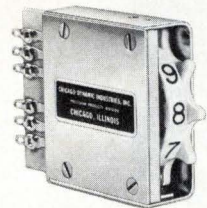

Completely sealed against hostile environments.



Mounts on 1/2" centers, retrofits most panel openings for miniature thumbwheel switches.

ROTARY SWITCHES

Snap-in, snap-out modules in seconds, eliminating downtime.

Tabet Pat.

2841660,
2971066,
3015000,
2956131,
2988607.



PUSHBUTTON SWITCHES

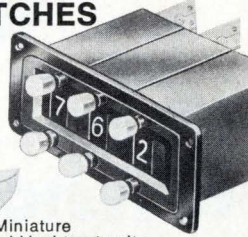

Miniature add/subtract units retrofit most minithumbwheel switch panel openings.

CDI earns its reputation every day for Consistently High Quality, Consistently Good Delivery.



CHICAGO DYNAMIC INDUSTRIES, INC.

PRECISION PRODUCTS DIVISION
1725 Diversey Blvd., Chicago, Illinois 60614
Phone: 312, 935-4600

Circle 115 on reader service card

Power Line Disturbance Monitor

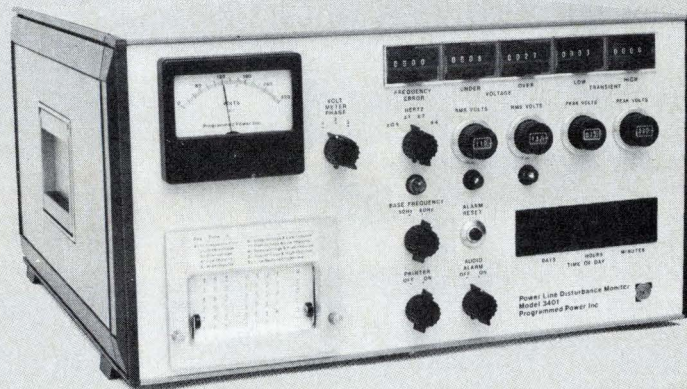

You may not need U.P.S. Monitor and evaluate. Then decide.

Transient risetime response: 0.2 μ s
Monitors single or three phase power
Transient amplitudes \pm 50 to 1000V
50-60 Hz or 400-415-441 Hz
Event registers:
undervoltage and overvoltage
under/overfrequency
low-magnitude transients
high-magnitude transients

Wide voltage range: 100-480 VAC
Audio and visual alarms
Time and event recorder
Quartz crystal clock
Solid state circuitry
Portable and lightweight
Easy to use: no attendant needed
Virtually maintenance-free

Programmed Power Inc.
141 Jefferson Drive
Menlo Park, CA 94025
(415) 323-8454

Subsidiary of Franklin Electric





SEE WHAT
GARDNER-DENVER
IS DOING NOW.

Profit by our experience in solving wire preparation problems

The Gardner-Denver Wire Preparation Unit delivers wire cut to length, stripped one end or both, in any quantity. For low or high volume users. Just set a dial, flick a switch, and profit from more than a decade of our experience in processing all types of insulated wire. This automated machine can be used as an on-line system with a Gardner-Denver Terminal Locator or other semi-automatic wiring equipment, or as a bench unit to process bulk wire. We also have a machine to produce twisted-pairs. De-reelers too. Write for Bulletins 14-111 and AC-35. Gardner-Denver Company, Grand Haven Division, Grand Haven, Michigan 49417.

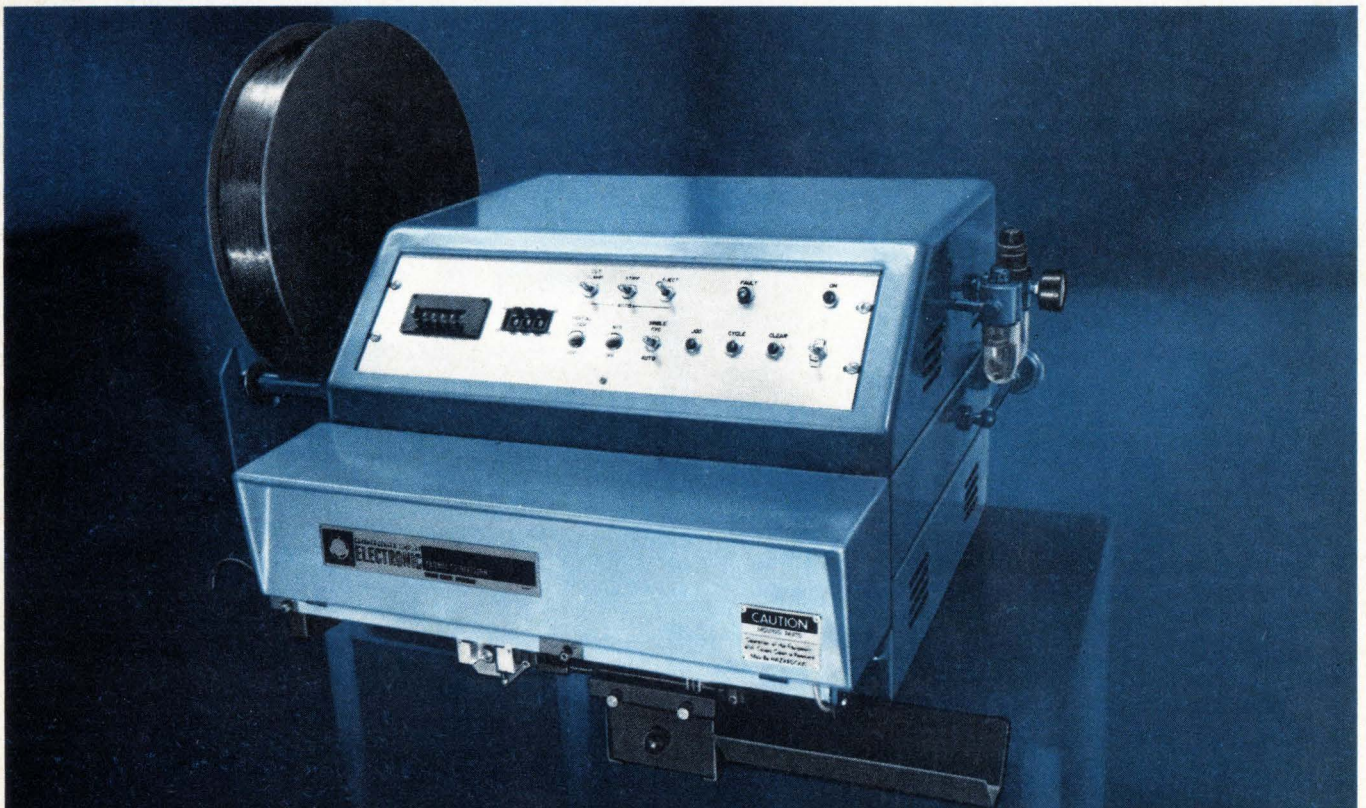

GARDNER·DENVER

New products

uct detector—with a built-in oscillator—for single-sideband and continuous-wave transmissions, the SL624 also contains a variable-gain audio amplifier. Intended for use in multi-mode receivers, the integrated circuit may be switched from one mode to another. Or, since it costs only \$4.44 in hundreds, it may be cheaper to use two of them to reduce switching costs. Usable at frequencies up to 30 megahertz, the unit operates with supply voltages from 9 to 12 volts and draws about 20 milliamperes.

Plessey Semiconductors, 1674 McGaw Ave., Santa Ana, Calif. 92705 [416]

Static shift register

uses n-channel technology

Claimed to be the industry's first n-channel static shift register, the IM7733 is a 1,024-bit silicon-gate, enhancement-mode MOS device. Fully compatible with DTL and TTL levels, the shift register requires only one 5-volt supply and no external pull-up circuitry. The unit's push-pull output has a fanout rating of two TTL loads. Typical clock-to-output delay is 100 nanoseconds. The IM7733 is available in commercial and military temperature ranges, and in plastic, ceramic, and TO-100 packages. In quantities of 100 to 999, the plastic and TO-100 packaged commercial (0° to 75°) units cost \$9.90, while the ceramic-packaged military (-55° to 125°C) devices cost \$16.80. Other combinations fall in between.

Intersil Inc., 10900 North Tantau Ave., Cupertino, Calif. 95014 [415]

10-kV opto-isolator

is only 0.5-inch long

The OPI 110 optically coupled isolator measures 0.5 inch long by 0.3 in. in diameter, and has an input-to-output isolation-voltage rating of 10 kilovolts. Consisting of an npn planar silicon phototransistor coupled to a high-efficiency gallium-

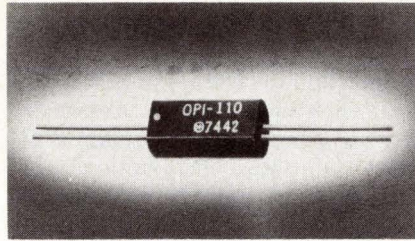

arsenide infrared-emitting diode, the device has a typical current-transfer ratio of 40% with an input current of 10 milliamperes. Typical switching time is four microseconds. Price of the OPI 110, in lots of 1,000 is \$2.90; delivery is from stock. Leads can be formed to permit use in automatic insertion equipment.

Optron Inc., 1201 Tappan Circle, Carrollton, Texas 75006 [417]

Darlington pairs have

built-in diode protection

A series of three monolithic high-voltage, high-current Darlington transistor arrays features open-collector outputs, and integral suppression diodes for protection against inductive loads. Each of the devices consists of seven silicon npn Darlington pairs on a single monolithic substrate. The type ULN-2001A is a general-purpose array intended for use with a wide variety of logic families including DTL, TTL, p-MOS and C-MOS. The type ULN-2002A is specifically designed to work with 14- to 25-volt p-MOS devices. Each input has a zener diode and a resistor in series to limit the input current to a safe level. The type ULN-2003A has a resistor in series with the base of each Darlington pair, and thus allows direct connection to TTL or C-MOS devices operating from 5-V supplies. In all cases, the individual pairs have maximum current ratings of 500 milliamperes; however, outputs may be connected in parallel to drive heavier loads. The absolute maximum collector-emitter output voltage rating of all the devices is 50 V.

Technical Literature Service, Sprague Electric Co., 315 Marshall St., North Adams, Mass. 01247 [418]



SEE WHAT
GARDNER-DENVER
IS DOING NOW.

Pass!
It's wrapped.

In less than one second, your operators make permanent, gas-tight electrical connections with Gardner-Denver Wire-Wrap* Tools. Tool weighs only 13½ ounces. Handles 18 through 32 gauge wire. Send for Bulletin 14-1 on Gardner-Denver Wire-Wrap tools, bits, and sleeves. Gardner-Denver Company, Grand Haven Division, Grand Haven, Michigan 49417.

*Wire-Wrap is a registered
Trademark of Gardner-Denver Company.

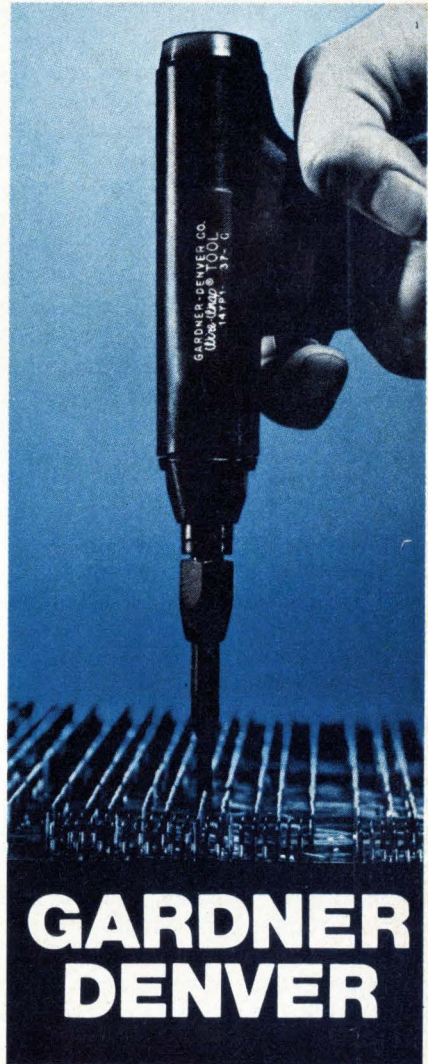

**GARDNER
DENVER**

Data handling

Signal processor is fast, flexible

Two versatile types can be directed by host computer or operate on their own

The design of signal processors usually requires a tradeoff between speed and flexibility—but not with two systems developed by Signal Processing Systems Inc. According to the company, the systems—one twice as fast as the other—can process signals at high speeds, yet both have the programing flexibility of general-purpose computers.

The SPS-41 can compute a fast Fourier transform of 1,024 complex data points in less than 8.7 milliseconds, and it can filter digitized signal samples at a 500-kilohertz rate. The SPS-81 completes the same FFT in 4.2 ms. Both processors can be programed either to perform under the command of a host computer or to operate alone. Both can perform linear predictive coding of speech waveforms, process radar and sonar signals, demodulate digital communication signals, and enhance photographic and television images.

Functional specialization is the key to improved flexibility, says president Joseph R. Fisher. The SPS units have two major subunits: an input/output processor and an arithmetic processor, permitting signal processing to proceed concurrently with computation.

The I/O processor is a 16-bit stored-program unit that controls independent data transfers in various channels in accordance with assigned priorities. The approach resembles that used by multi-programed computers, except that they switch from program to program under software control, and the SPS unit is hard-wired.

The arithmetic processor is further divided into two sections, arithmetic and index. The index section

keeps track of the sequence of signal-processing operations to be performed and delegates the actual manipulation of data to the arithmetic section. The arithmetic section is attached to the index section, performing real and complex addition, multiplication and other operations serially by byte; it contains a scratchpad memory and a read-only table of complex exponentials—the multipliers required by the fast Fourier transform or an equivalent algorithm.

Each section of the processor has its own separate program, data and register file memories, which typically contain 256 words each and are used as cache memories. This is the first commercial application of cache memory in a signal processor, according to the company. The basic memory with add-on capacity has a range of 4 to 128 kilowords.

The SPS-41 is priced at \$31,000; the faster SPS-81 costs \$50,000, including interfacing to customers' present computers.

Signal Processing Systems Inc., 223 Crescent St., Waltham, Mass. 02154 [361]

Intelligent terminal has 3 built-in microprocessors

A user-programable intelligent terminal and display system provides high-speed communications and simultaneous multiple input/output processing. Called the model OP-1 and designed for the OEM market, the terminal contains three microprocessors that provide high-speed input/output capabilities. The three microprocessors in the low-cost, stand-alone terminal are a central processor, a display processor and an input/output unit. With the CPU, the OP-1 can be programed by the user for applications such as reservations, inventory, ticketing, sales, and typesetting. The system can operate with a variety of host computers. Optional device controllers available for field or factory installation include a synchronous communications controller, a 3M tape cartridge for controlling four tape



transports, a disk controller and a printer controller. The basic OP-1 terminal system is priced at \$2,285 in quantities of 100. Delivery time is 90 days.

Intel Corp., 3 Fairchild Cr., Plainview, N.Y. 11803 [363]

One-board data-acquisition system is Nova-compatible

Made to plug directly into the main-frame of a Nova, Supernova, Nova 800, or Nova 1200 minicomputer, the model 500-DGC system is a data-acquisition and control system built on a single 15-by-15-inch printed-circuit board. The 12-bit system is available with a variety of multiplexers for handling from eight differential-input channels up to 64 single-ended inputs. Depending upon the number and type of inputs, basic system prices range from \$1,800 to \$2,370. The system includes a regulated, isolated dc-to-dc converter which gets its input power from the host computer, a fast (100 kilohertz) 12-bit analog-to-digital converter, and a program interrupt interface. Extra-cost options include a programable-gain amplifier and anywhere from one to four 12-bit

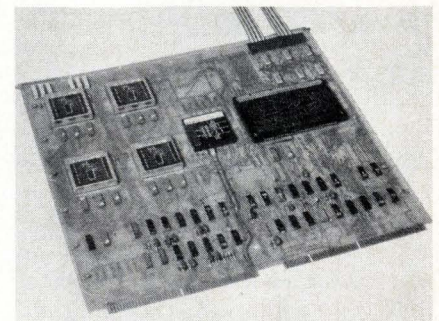

digital-to-analog converters for providing analog outputs for control or display. The \$250 programmable-gain option includes automatic amplifier zeroing at no extra cost.

Adac Corp., 29B Cummings Park, Woburn, Mass. 01801 [364]

Data-acquisition system uses programmable calculator

Scanning up to 520 channels under calculator control, measuring dc, ac and ohms at up to four readings per second, and calculating results on-line or off-line, the model 3050B data-acquisition system from Hewlett-Packard sells in the range from \$14,000 to \$25,000. With a scanner coupled to the H-P model 3490 digital multimeter, the system measures dc in five ranges from 100 millivolts to 200 volts with a resolution of 1 microvolt. Ac is measured in four ranges from 1 V to 200 V with 10- μ V resolution over the range from 20 hertz to 100 kilohertz, and resistance is measured from 100 ohms to 10 megohms with 1-milliohm resolution. Data logging is under control of an H-P 9820A, 9821A, or 9830A programmable calculator. A common-carrier interface bus is available as an option.

Inquiries Manager, Hewlett-Packard Company, 1501 Page Mill Rd., Palo Alto, Calif. 94304 [365]

Interface designed for use with Honeywell minis

A flexible data-line controller is capable of interfacing virtually any RS-232C-compatible unit with Honeywell minicomputers. The model S100 asynchronous interface unit is designed specifically for use with H316, DDP416 and DDP516 minicomputers. The unit allows interface with line printers, CRTs, modems, and teletypewriters, including multiple stations, without need for additional equipment. Each S100 can be customized for the specific user requirement. Models are available

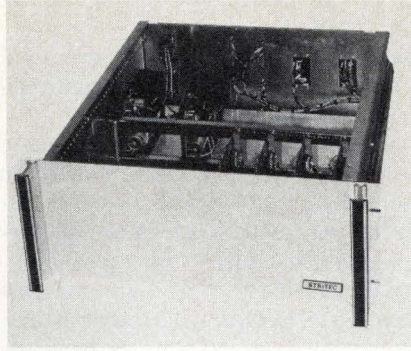

with from one to eight channels. Plug-in-card construction is used and the interface is 7 inches high by 19 in. wide by 17½ in. deep. Price is \$3,500 to \$5,000, depending on number of channels and configuration. Delivery time is eight weeks.

Stritec Inc., 5352 Sterling Center Dr., Westlake Village, Calif. 91361 [366]

Tape formatter handles up to eight drives

A tape formatter designated the model 86008 consists of a single printed-circuit card and will handle up to eight Quantex 600 drives. It accepts 8-bit parallel bytes and converts them to the required phase-encoded serial format. The preamble, postamble, and cyclic-redundancy-check character are internally generated in accordance with the proposed ANSI specification during write operations. In reading data, the preamble, postamble, and CRCC are automatically removed. A CRC pulse output is provided when an error is detected. Price is \$570 each.

Quantex, 200 Terminal Dr., Plainview, N.Y. 11803 [367]

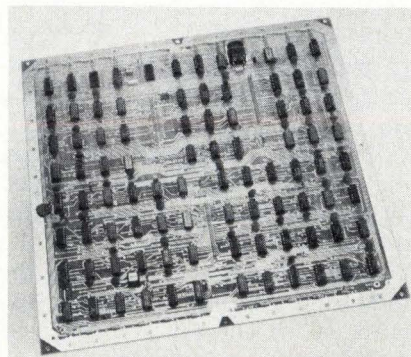

NOVA/DCC-116 General Purpose Interface Board

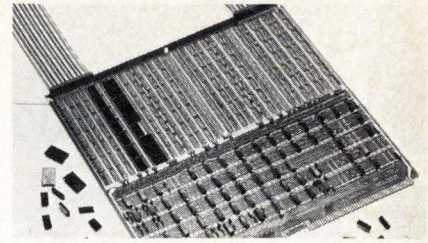

BASIC BOARD HAS: ● Multiple device selection. ● Interrupt request and acknowledge logic. ● Interrupt mask and I/O signal selection. ● Space for 105 sockets or IC's (will take 24 & 40 pin, as well as 14 & 16 pin devices). ● Plugs directly into a single slot of any NOVA or DCC-116 computer chassis. ● Provides for mounting 2 ribbon cable edge connectors. ● Extractor kit & board stiffener.

OPTIONS INCLUDE: ● Four 16 bit I/O registers (with byte packing and unpacking). ● Data channel connection (includes data channel synchronization and request logic, zero word count detection (OVFL indicator)).

BASIC BOARD PRICE IS \$385.
Delivery from stock.

MOB MDB Systems, Inc.,
981 N. Main St.,
Orange, CA 92667
(714) 639-7238

Circle 119 on reader service card



UD-876M
Uni-directional
Dynamic Microphone

The UD-876M microphone is a unidirectional cardioid dynamic microphone intended for the most demanding needs of professional musicians. The dynamic cartridge used in this microphone has been designed with the needs of the performer on stage in mind.

The wind screen provides exceptional rejection of both breath blast and wind sounds.

● For catalog, write to:

PRIMO MICROPHONE INC.

2468 DELTA LANE, ELK GROVE VILLAGE
ILLINOIS 60007, U.S.A. TEL: 312-595-1022
TELEX: 28-3474 PRIMO MUS ELGR

PRIMO COMPANY LIMITED

6-25-1 MURE, MITAKA-SHI, TOKYO, JAPAN
TEL: 0422-43-3121~9
TELEX: 2822-326 PRIMO J

Packaging & production

Marking 16,000 DIPs per hour

Curing oven, an integral part of printing system, uses 1,000°F focused air blast

Each of the billions of dual in-line packages produced each year must have two or three lines of information printed on it. But printing the part number and other information on the DIP body is more than a simple inking process. Two additional steps are involved—handling the units in extremely large quantities and curing the epoxy-based ink after printing.

Machines are now capable of

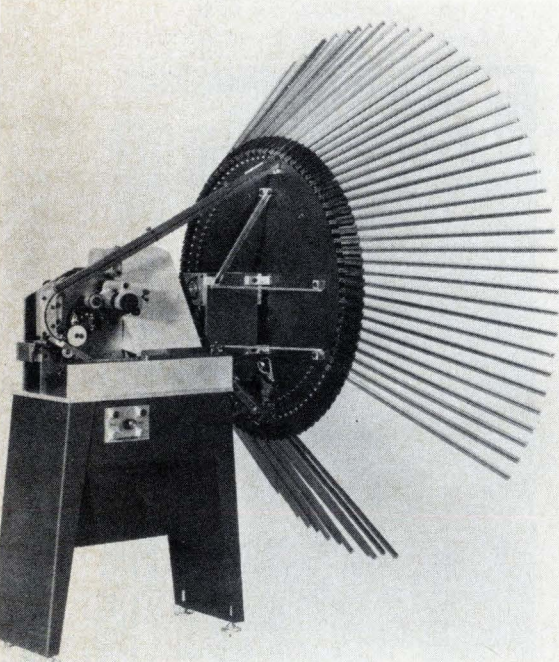

printing on as many as 15,000 DIPs per hour, but the manufacturer must still remove a plastic carrying-stick full of printed DIPs from his machine, put them in heat-resistant aluminum sticks, cure the inks in an oven, and then repackage the DIPs in plastic sticks for shipment. Curing requires from one to one-and-a-

half hours beyond the printing and drying stages of the conventional marking process.

Now Markem has introduced a DIP printer, the U1228, which can feed, print, and cure 16,000 DIPs per hour. All of these steps are accomplished by one machine that eliminates the extra curing time needed by conventional DIP printers. Markem's system consists basically of a feeder/handler, a rotary printing mechanism, and a curing oven.

In addition to eliminating the time and expense of going from aluminum sticks for curing and back to plastic sticks for shipping, the Markem printer eliminates the need for large space-consuming ovens.

The printer is top-loaded and DIPs are fed through gravity flow to the rotary print station. As they approach the station, each piece is mechanically held for exact registration. The basic machine has a semiautomatic feeder that has a throughput of 8,000 to 10,000 DIPs per hour. An automatic carousel-type feeder (shown in photo), available as an option, increases throughput of the machine to 16,000 DIPs per hour.

For quick legend changes, the U1228's rotary printer can use either loose type or a ceramic printing plate from Markem. As a third choice, a manufacturer can produce his own plates with Markem's model 452 platemaker, which consists of an exposure unit and a wash-out unit, both of tabletop size. The model 452 can produce a finished printing plate from a negative in 15 minutes.

Once printed, each component is individually moved on a conveyor to the integral curing oven. This enclosure is 8 inches long and cures a DIP in 3 seconds. During this interval, a 1,000°F air blast is focused on the DIP, and excess heat is sucked away by an exhaust. Because of this quick heat/cool cycle and the U1228's conveyor transfer of the DIPs from the printing head to the oven, it is not necessary to use aluminum sticks for handling. After

curing, the U1228 machine automatically reloads the DIPs into plastic sticks.

Depending on options, the U1228 is priced at about \$18,000 with a semiautomatic feeder, and at about \$25,000 with a fully automatic version. The platemaker costs \$2,000, and blank plates are priced at 75 cents each.

Markem Corp., 150 Congress St., Keene, N.H. 03431 [391]

Augat introduces boards for Schottky TTL, ECL

Two series of packaging boards—one for extremely fast emitter-coupled logic, the other for

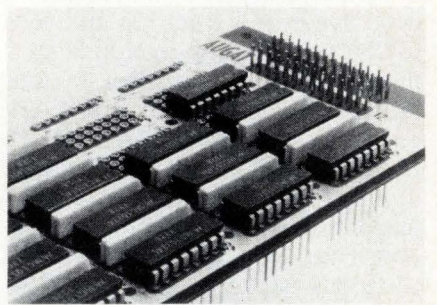

Schottky-clamped transistor-transistor logic—are designed for automatic wrapped-wire interconnection. The ECL boards (shown) are designed to accommodate a single in-line package (SIP) of terminating resistors in between the dual in-line logic packages. The Schottky TTL board has an extended copper supply-voltage plane sandwiched between two ground planes. Each DIP is connected to both ground planes, and decoupling-capacitor zones are established for each DIP location. The result is an increase in distributed board capacitance of as much as 400% over currently used interconnection panels, with a consequent reduction of high-frequency noise. The TTL board is available in sizes that accommodate from 30 to 180 DIPs, in multiples of 30, at prices that range from \$1.29 to \$2.40 per DIP pattern, depending upon variations and quantity. The ECL boards

We improved our micro resist.

New KODAK Micro Resist 747 is the purest, most stringently controlled resist we've ever made.

It's filtered to a value of 0.5 micrometer, and there are less than 10 parts per million of metal ions. (Less than three parts per million each of sodium, lithium, potassium, tin, or gold.) Viscosity and solids are also closely controlled.

And there are processing solu-

tions of equally high quality: KODAK Micro Resist Developer, Thinner, and Rinse. All of which help you get more uniform coatings and better process reliability. And *that* means economy.

There's convenience, as well. This negative-working resist comes in four ready-to-use viscosity grades: 30, 45, 60, and 110 centistokes.

We couldn't improve our offer.

Technical assistance.

We'd be pleased to share our experience in microelectronics with you. As a start, why not send for the comprehensive six-page data sheet on KODAK Micro Resist 747? Or have a representative demonstrate it for you. Either way, just use the coupon.



Eastman Kodak Company	12-48
Dept. 412-L, Rochester, N. Y. 14650	
<input type="checkbox"/> Please have a representative demonstrate KODAK Micro Resist 747.	
<input type="checkbox"/> Please send detailed information.	
Name _____	
Title _____	
Company _____	
Address _____	
City _____ State _____ Zip _____	
For information on sales outside the U.S. and Canada, contact the International Photographic Division, Eastman Kodak Company, Rochester, N. Y. 14650, U.S.A.	

New products

maintain the same form factor as the company's older ECL series. Prices on the ECL boards vary from \$1.83 to \$3.39 per pattern.

Augat Inc., 33 Perry Ave., Attleboro, Mass. 02703 [399]

Multilayer card extenders have up to 216 signal lines

A family of multilayer card extenders is available in sizes large enough to handle 216 signal lines. The five-layer panels contain two ground planes to prevent undesired coupling of high-frequency signals, and they have provision for either connecting the ground planes for electrical conduction or leaving them unconnected for shielding be-

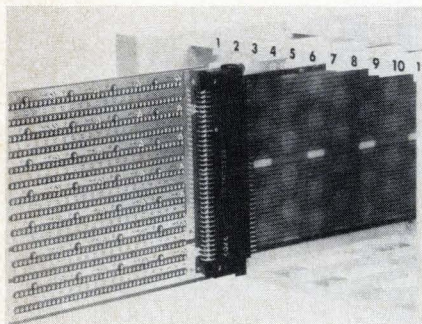

tween signal leads. The extenders cost \$70 each in quantities of 10 or more; delivery is from stock.

Mupac Corp., 646 Summer St., Brockton, Mass. 02402 [395]

Wrapped-wire system made for metric dimensions

A family of high-density electronic packaging cards and associated hardware for wrapped-wire interconnection of integrated circuits has a basic card size of 100 by 160 millimeters. Called Euro-Cards, the line includes preassembled 14- and 16-pin socket cards with distributed supply-voltage and ground connections—both with or without connectors. Copper-clad, blank, and two types of general-purpose cards are also available. Three versions of

“M” series Euro-Racks are offered to house the Euro-Cards. The system uses 64-pin, two-piece, high-reliability pc card connectors organized as two rows of 32 pins each. Assemblies are available with or without mounted back-plane connectors, and the manufacturer can also provide fabrication and wire-wrapping services.

Cambridge Thermionic Corp., 445 Concord Ave., Cambridge, Mass. 02138 [396]

Gold inlays cut connector costs

By bonding wrought-gold strips only to the contact points on copper-nickel terminals, Vector Electronic Co. has produced a pair of 24-pin IC sockets that offer the performance of gold-plated units at slightly more than the price of conventional nickel-plated devices. Actually, the 50-microinch surface finish of the wrought-gold inlays yields lower contact resistances than does the porous surface of conventional gold plating. The sockets are made of glass-filled nylon, and measure 1.28 inches long by 0.7 in. wide. The model R724 is 0.28 in. high and has 0.69-in. leads for wrapped-wire termination. The R724-2 is 0.15 in. high, and has 0.15-in. leads for soldering. The R724 is priced at \$1.50, while the R724-2 goes for 88 cents—

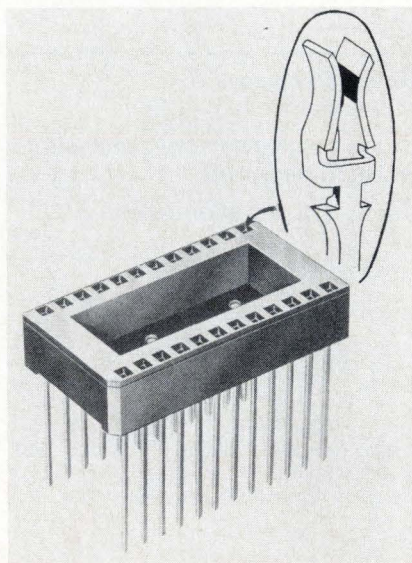

both for 100 to 500 units. Delivery is from stock.

Vector Electronic Co. Inc., 12460 Gladstone Ave., Sylmar, Calif. 91342 [397]

Temperature testing of chips and wafers goes automatic

A programable temperature-control system for use in automatic systems that measure the temperature characteristics of semiconductor wafers and chips covers the range from -60 to +200°C. The model TP350 ThermoChuck system accepts digital commands to change its temperature from a computer or a semiconductor test system. In addition, three temperatures can be set on front-panel thumbwheel switches and selected by push buttons. The unit provides both a front-panel digital display and digital output data on the chuck temperature. The heating-cooling system is self-contained and provides temperatures that are stable to within 0.5° and repeatable to within 1°C. Maximum error is 1% of range. Delivery time for the TP350 system is 14 to 16 weeks.

Temptronic Corp., 40 Glen Ave., Newton, Mass. 02159 [393]

Tin-nickel plating lowers DIP contact resistance

Two dual in-line sockets—an eight- and a 14-pin unit—have Nasglo-plated contacts. This tin-nickel plating is said to be extremely hard and to offer a contact resistance some 20% below that of conventional gold plating. Other advantages over gold plating are said to be a 10% cost reduction, and the avoidance of the embrittlement problems associated with gold-plated contacts. Price of the eight-pin model A23-5034 is 40 cents in hundreds, while the 14-pin A23-5028 is priced at 42 cents in similar quantities. Delivery is from stock.

Jermyn, 712 Montgomery St., San Francisco, Calif. 94111 [398]

New from **eltex** INC.

ADC12QZ and DAC12QZ

A/D CONVERTER

12 Bits/40 μ sec

- Unique Low-Noise Successive-Approximation Design
- Fully Self-Contained with Guaranteed No Missing Codes Over 0° to 70°C
- Pin Configuration Conforms to Popular Industry Standard
- Quantities 1-9 . . . \$129.00

There are several variations of the above models also available featuring:

- Resolutions from 8 to 14 Bits
- Speeds to 3 μ sec (ADC) and 300 nsec (DAC)
- Extended Temperature and Military Performance

All Pin-Interchangeable!



D/A CONVERTER

12 Bits/5 μ sec

- Gain Stability Less Than 10 ppm/°C, Offset Stability 3 ppm/°C
- Fully Monotonic Over 0°C to 70°C
- Pin Configuration Conforms to Popular Industry Standard
- Quantities 1-9 . . . \$ 79.00

To place your order now,
call Gene Lavielle (415) 686-6660 or
TWX 910-481-9477

eltex INC. 940 DETROIT AVE. CONCORD, CA 94518
(415) 686-6660 TWX 910-481-9477

Circle 123 on reader service card

ANNOUNCING...THE LR INNOVATOR SERIES A NEW WAY TO TEACH DIGITAL ELECTRONICS

The new LR Innovator Series, from E&L Instruments, represents a radically new approach to the teaching of electronics. Check these features.

The student encounters hardware on the very first day of laboratory instruction. The software (seven hundred pages—over 90 experiments) is designed for both formal instruction or for self-programmed learning. The student is initially introduced to digital rather than analog electronics, and is taught through the use of the actual integrated circuit chips. The student is directed toward the use of manufacturer's specifications, with the goal of making him independent and self-sufficient in his approach to creating more sophisticated digital electronic circuits. The hardware has been designed "open ended". As electronics technology changes and evolves, the student can obtain and use the exciting new integrated circuit chips.

Write today for full details of this exciting new system.



E&L INSTRUMENTS, INCORPORATED
61 First Street, Derby, Conn. 06418

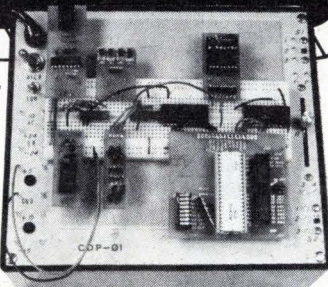

Circle 145 on reader service card

Circle 146 on reader service card →

instant pulse

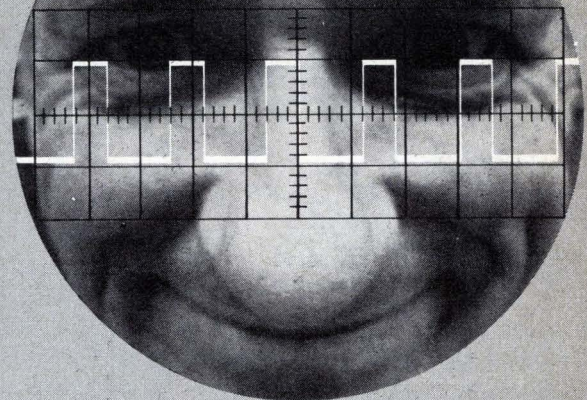

Interstate Pulse Generators have Constant Duty Cycle

Engineers are always surprised when they select the Constant Duty Cycle mode and adjust the width control on an Interstate Series 20 Pulse Generator — they get an instant pulse. It's "countdown-free," too.

For the whole story on Interstate's Instant Pulsers, call John Norburg collect. He'll send you Interstate's Series 20 Pulse Generator catalog — instantly.

Phone (714) 772-2811



Dept. 7000, Box 3117, Anaheim, California 92803
TWX U.S.A. 910-591-1197 TELEX U.S.A. 655443 & 655419.

SEARCHLIGHT SECTION

- CLASSIFIED ADVERTISING
- BUSINESS OPPORTUNITIES
- USED OR SURPLUS EQUIPMENT

RF-PACKAGES—MICROWAVE SYSTEMS

WORLD'S LARGEST RADAR & MICROWAVE INVENTORY

AUTOTRACK ANTENNA SCR-584 RADAR SYSTEM

360 deg AZ 210 deg EL. 1 mil. accuracy. Missile vel. accel. and slew. rates. Amplidyne control. Handle up to 20 ft. dish. Compl. control chassis. ALSO in stock 10 cm. van mounted rad. system. Conical scan. PPI. 6 ft. dish. 300 pg. instr. bk. on radar \$25



RF SOURCES

CW: 300-535KHz 500W; 2-30MHz 3KW; 4-21MHz 40KW; 24-350MHz. 100W; 385-585MHz 1KW; 750-985MHz 10KW; 95-8.8GHz 150W; 1-1.5GHz 110W; 1.7-2.4GHz 10KW; 4.4-5GHz 1KW; 8.8-11GHz 200W. Many more.

UHF: 1 Megawatt 210-225MHz .5µsec 180 PPS; 14KW 400-420MHz .002DC; 1KW 400-700MHz .002DC.

L BAND: 1KW 1-1.5GHz .1DC; 500KW 1.2-1.35GHz .2µsec 400PPS.
S BAND: 1KW 2.4-2.6GHz .75µsec 1200PPS; 250KW 2.7-3.3GHz .8µsec 1600PPS; 1 Megawatt 2.7-2.9GHz .1µsec 1200PPS; 5 Megawatts 2.75-2.85GHz 2.5µsec 400PPS.

C BAND: 225KW 6275-6575MHz .4µsec 680PPS; 250KW 5.4-5.8GHz .5µsec 680PPS; 1 Megawatt 6GHz .1µsec 1000PPS.

X BAND: 100W 9.2-9.5GHz .5µsec 1000PPS; 1 KW 8.9-9.4GHz .001DC; 65KW 8.5-9.6GHz .001DC; 250KW 8.5-9.6GHz .0013DC; 400KW 9.1 GHz 1.8µsec 450PPS.

Ku-K BAND: 50KW 16.4-16.6GHz .001DC; 135KW 15.5-17.5GHz .0006DC; 40KW 24GHz .0007DC; 40KW 35GHz .0004DC.

PULSE MODULATORS + H.V.P.S.

245 KW LINE Output 16 KV 16 A. .25 µs 4000 PPS.
405 KW FLOATING DECK Output 20 KV 20 A 1 µs to 10 millisecond pulse.

500 KW LINE Output 22 KV 28 A. 4/1.75/2.25 µs 2500/550/300 PPS.

1 MW HARDTUBE MIT MODEL 9 Output 25 KV at 40 A. .25 µs .002 DC.

2.0 MW LINE 30 KV 70 A. 1/2 µs 600/300 PPS.

3 MW LINE Output 39 KV 75 A. .25/1 µs 500 PPS.

10 MW LINE 76 KV 135 A. 2.5 µs 350 PPS.

17 MW LINE 17 KV 1000 A. 2-5 µs 150-2000 PPS.

SEND FOR FREE 24 PG. CATALOG

SPARE PARTS IN STOCK

Nike Ajax, Nike Hercules, M-33, MPS-19, TPS-1D, TPS-10D, FPS-6, SPS8, SCR-584, HIPAR. Many more. write

RADAR SYSTEMS

K BAND MONOPULSE 40KW E-34
KU BAND SEARCH 135KW B-58
X BAND MISSILE CONTROL NIKE AJAX/HERC
X BAND FIRE CONTROL 250KW M-33
X BAND WEATHER/SEARCH 250KW AN/CPS-9
X BAND AIRBORNE TRACKER 50KW B-47
X BAND MOBILE TRACKER 40KW AN/MPQ-29
X BAND WEATHER/SEARCH 40KW AN/SPN-5
X BAND TRANSPONDER 100W AN/DPN-62
C BAND HGT. FDR. 5MW FPS-26; 1MW TPS-37
C BAND SEARCH 285KW AN/SPS-5B/D
S BAND HEIGHT FINDER 5MW AN/FPS-6
S BAND SEARCH COHERENT 1MW AN/FPS-18
S BAND ACQUISITION 1MW NIKE AJAX/HERC
S BAND TRACKER 10' DISH 500KW AN/MPQ-18
S BAND MORTAR LOCATOR 250KW AN/MPQ-10A
S BAND TRACKER 250KW AN/MPS-9
L BAND SEARCH 40' ANTENNA 500KW AN/FPS-75
L BAND SEARCH 500KW AN/TPS-1D/GSS-1
UHF SEARCH 1MW TPS-28

DRONE CONTROL SYSTEMS

UHF COMMAND SYSTEM AN/URW-14
X BAND DATA LINK AN/UPW-1
X BAND TRACKER AN/MPQ-29
X BAND TRACKER AN/MSQ-51

AN/GPG-1 SKYSWEEP TRACKER

3 cm. Comp. pkg. w/indicator sys. Full target acquisition & auto. track. In stock for imm. del. Entire sys. 6'x3'x9'. 9n.

MOD IV HI-RES MONOPULSE TRACKER

Instrumentation radar; freq. 8.5-9.6 GHz. Pwr: 250 KW. 1 mil. accu. Trk. Rng: 50 or 200 mi.



**Radio
Research
Instrument
Co., Inc.**

3 QUINCY ST., NORWALK, CONN. 06850
(203) 853-2600

CIRCLE 951 ON READER SERVICE CARD

SAME DAY SHIPMENT Minis & Peripherals

PRINTERS

Some "BRAND NEW"

DATA PRODUCTS

2440—700 LPM
2470—1250 LPM. \$9500

MOHAWK DATA SCIENCES

4320—300 LPM
4330—380LPM

CONTROL DATA CORP.

9322—200 LPM . \$2500
9352—600 LPM

ALSO

CENTRONICS, POTTER, CDC
A. B. DICK, IBM, HIS, UNIVAC
(617) 261-1100

Send for Free Report "Maintenance of Computers"

AMERICAN USED COMPUTER CORP.
P.O. Box 68, Kenmore Sta., Boston, MA 02215
member COMPUTER DEALERS ASSOCIATION

CIRCLE 957 ON READER SERVICE CARD



**EMPLOYMENT
OPPORTUNITIES**

POSITIONS VACANT

Five-year research-rank position in cosmic-ray physics. The physicist will work on a highly versatile study of high energy hadronic cross sections and ultra-high-energy astrophysics in an experiment observing the air scintillation of extensive air showers up to 10^{21} eV. Candidates should be capable of mature design of an experiment involving optics, mechanical structures, particle detection techniques, photon counting, state-of-the-art electronics, and the development of a sophisticated data-handling system using a PDP 11/45. Applications should be sent to Peter Gibbs, chairman, Department of Physics, University of Utah, Salt Lake City, Utah 84112 Telephone (801) 581-7468. An equal opportunity employer.

Post-Doctoral position in Cosmic Ray Physics. The Physicist will work on building and operating apparatus designed to make a precision measurement of the cosmic ray anisotropy near 1 TeV. Candidates should be experienced in high energy experimental techniques, particularly in the use of minicomputers. Applications should be sent to Peter Gibbs, Chairman, Department of Physics, University of Utah, Salt Lake City, Utah 84112 Telephone (801) 581-7468.

FIBERCOM

FIBER OPTIC
COMMUNICATION LINKS
Analog - Digital
Bandwidths To 50MHz

RADIATION DEVICES CO. PO BOX 8450
BALTIMORE, MD. 21234, 301-665-2764

CIRCLE 952 ON READER SERVICE CARD

free catalog

POTTING APPLICATORS
MANUAL OR AIR OPERATED
2½cc 6cc 12cc 30cc
FOR POTTING, ENCAPSULATING ETC.

PHILIP FISHMAN CO., INC.
7 CAMERON ST WELLESLEY, MASS. 02181

CIRCLE 953 ON READER SERVICE CARD

ZIP CODE
MOVES THE MAIL

FREE CATALOG

HARD-TO-FIND PRECISION TOOLS

Lists more than 2000 items—pliers, tweezers, wire strippers, vacuum systems, relay tools, optical equipment, tool kits and cases. Also includes ten pages of useful "Tool Tips" to aid in tool selection.

JENSEN TOOLS
4117 N. 44th Street, Phoenix, Ariz. 85018

CIRCLE 954 ON READER SERVICE CARD

HERMETIC SEALING

CONNECTORS • HEADERS • DETONATORS
GLASS/CERAMIC TO MFTAL • SINCE 1959

DETORONICS CORPORATION

10660 E. RUSH • S. EL MONTE, CA 91733
(213) 579-7130 • TWX 910-587-3436

CIRCLE 956 ON READER SERVICE CARD

Q. Whom do I contact or call to renew my classified ad or make corrections?

A. Write Electronics, Class. Adv. Dept., P.O. Box 900, NY, NY 10020 or call: (212) 997-6585 or 6586. Give full company name, size of ad, & date or dates it is scheduled to appear.

New literature

Industry opportunities. A free 18-page report entitled "Structural Changes and New Opportunities in the Electronics Industry" by Ray Stata, president of Analog Devices, Inc., is available from the company at Route 1 Industrial Park, Norwood, Mass. 02062. The report analyzes the industry's growth over the past decade with an eye on its consequences for the future. Circle 421 on reader service card.

Solder and flux guide. Published in handy slide-rule form, a guide from Kester Solder, 4201 Wrightwood Ave., Chicago, Ill. 60639 (Attention Mack Haraburd), aids in the selection of solders and fluxes. The guide gives flux choices for 22 metals, and lists 36 solder alloys. [422]

Thermistor testing. Six-page technical data sheet No. TD-2A, entitled "Considerations in the Testing of Thermistors," covers such subjects as resistance measurement, unbalanced thermocouple-voltage errors, and self-heating errors. The data sheet can be obtained from Fenwal Electronics, 63 Fountain St., Framingham, Mass 01701. [423]

Photoresist filtration. The importance of keeping photoresist solutions free of particles, and how to do it is elucidated in bulletin AB502, published by Millipore Corp., Bedford, Mass. 01730. [424].

Relay guide. A guide to the company's line of general-purpose relays, including electrical and mechanical data on 79 relays in 13 basic configurations has been published by North American Philips Controls Corp., Frederick, Md. 21701. [425]

Timesharing with Basic. A 16-page brochure describing features of the company's model 100 and model 200 Advanced Basic timesharing systems can be obtained from Inquiries Manager, Hewlett-Packard Co., 1501 Page Mill Rd., Palo Alto, Calif. 94304. The systems make use of the H-P 3000 minicomputer family. [426]

Parallel Entry Printer

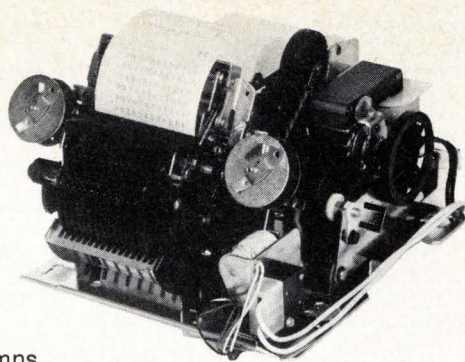

Prints 3 lines per second, 11 character locations per column with a capacity up to 16 columns. Print mechanism is small (5 1/4" x 10" x 8").

Options available: Serial or parallel BDC interface
Power supply Attractive case

With the addition of calculator logic, it becomes our "Intelligent Printer".

Write for catalog of
Addmaster computer peripherals.

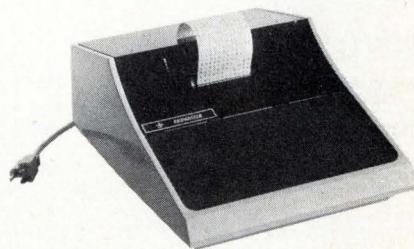

416 Junipero Serra Drive • San Gabriel, California 91776

Circle 125 on reader service card

39.999999 MHz



MODEL 5500

BEST FREQUENCY SYNTHESIZER

- 10 KHz to 39.999999 MHz Range
- 1 Hz Resolution throughout range
- LED Display of Frequency
- Full Programmability & Fast Switching — 1 MS TYPICAL
- High Spectral Purity: —70 dB SPURIOUS
—60 dB PHASE NOISE
—40 dB HARMONIC
- High Stability: ±2x10⁻⁸/°C STANDARD
±2x10⁻¹⁰/°C OPTIONAL
- 1 v RMS Output (+13 dBm)
- Amplitude Modulation: 0.95%, 400 Hz, 1 KHz, EXTERNAL
- Auxiliary TTL Square-wave Output
- ASCII, Calculator and Minicomputer Interface Options

SOME APPLICATIONS:

- Communication systems alignment and calibration.
- Precision sweep testing of High Q networks.
- Frequency agile automatic systems.
- Programmable local oscillator.

For immediate information on how Rockland can meet your specific application and delivery requirements — call our local rep or Dave Kohn directly at

ROCKLAND

ROCKLAND SYSTEMS CORPORATION 230 W. Nyack Rd., W. Nyack, N.Y. 10994 • (914) 623-6666

Abbott Transistor Labs, Inc. Technical Advertising Agency	8	Hewlett-Packard Richardson, Seigle, Rolfs & McCoy, Inc.	1	RCA Ltd. Marsteller, Ltd.	42E-43E
Addmaster Corporation Mich Associates	125	Industrial & Scientific Conference Burlingame Grossman, Inc.	54E	RCA—Solid State Division Marsteller, Inc.	60-61
AEG Telefunken Werbeagentur Dr. Kuhl GmbH	31E	Industrie Bitossi s.a.s. Studio Ruini	46E	RCL Electronics, Inc. Morvay Advertising Agency	14
AEROCOM Jacster Enterprises, Inc.	48E	Israel Section International Media		Rockland Systems Rolf Johnsen, Inc.	125
Alcatel	14E	Israel Export Institute	21E	Rohde & Schwarz	1E, 11E
Ampex Cassey and Hull Ltd.	15E	Tadiran	22E-23E	RTC Feldman Calleux Associes	17E
Anritsu Electric Co., Ltd. Diamond Agency Co., Ltd.	140	Supaco Engineering Supply Co., Ltd.	24E	S.A.F.T. U.N.C.C.	55E
Ballantine Laboratories, Inc. MLF Graphics	128	Microelectronics Ltd.	24E	Scientific Micro Systems Inc., Sub of Corning Glass Works Durel Advertising	64
Beckman Instruments, Inc., Helipot Division N.W. Ayer/Jorgenson/MacDonald, Inc.	50	Tedea	24E	Schauer Manufacturing Corp. Nolan, Keelor & Stites	32
Burroughs Corporation Conti Advertising	9	Sharnoa Electronics	25E	S.D.S.A. Public Service	34
Carlo Erba MVC Pubblicitas & Marketing	12E	Elitek Ltd.	25E	Selmar CPM Studio	13E
Centralab Electronics Div., Globe-Union, Inc. Action Communicators	36-37	Elco	26E	Semtech Corporation Adgraphix Corporation	104
Cherry Electrical Products Corp. Kolb/Tookey and Associates, Inc.	6	Micronics Ltd.	26E	Sescosem Bazaine Publicite	41E
Chicago Dynamic Industries Burton Browne Advertising	115	International Media	26E	Siemens A.G. Munich Linder Presse Union GmbH	44
Cialrex Corporation Marquardt & Roche	4th Cover	Elbit Computers Ltd.	27E	SGS—ATES International McCann-Erickson	17-18
Continental Specialties Corporation Robert A. Paul	127	Vishay Israel Ltd.	27E	Sharp Electronics Corporation SSC&B Advertising	46
CTS Corporation Reincke, Meyer & Finn, Inc.	35	Koor's Electronics Wing	28E-29E	Siemens Corp.—Electronic Systems Division, Computest Products J L Associates	44
Custom Electronics, Inc. Laux Advertising, Inc.	110	Israel Export Institute	30E	Sodeco-SAIA PR Service	6E
Dana Laboratories Dailey & Associates	54	Interdata Shaw-Elliott Advertising	10-11	Spectrol Electronics Corporation J M R Inc.	Second Cover
Data Industri Holter, Young & Rubicam AS	49	Interstate Electronics Corp. Chris Art Studio, Inc.	123	Sprague Perez Publicite	4E-5E
Digital Equipment Corporation Creamer, Trowbridge, Case & Bastford, Inc.	100-101	Johnson Company, E F Martin Williams Advertising	56	Sprague Electric Company Harry P. Bridge Company	7
Ducati Elettrotecnica Microfarad Studio Busoli Gastone	16E	Kepeco Inc. Weiss Advertising	5	Systron Donner Concord Instruments Fred Schott & Associates	38
Eastman Kodak Co.—GMD GD Photofabrication-Microelectronic Rumrill-Hoyt, Inc.	121	LTT	18E	TEAC Corp. Dentsu Advertising Limited	53E
EL Instruments, Inc. Langelier-Stevens, Incorporated	120	Matsushita Electric Trading Co., Ltd. Hakuhodo, Inc.	50E-51E	Tektronix, Inc. Tektronix Advertising	27, 29
Electromask, Inc. JMR Advertising	2	MDB Systems, Inc. The Sunshine Group	119	Teledyne Philbrick Ingalls Associates	41-43
Electronics Circulation	56E-D	Monroe, The Calculator Company Division of Litton Industries Hartel Cattano & Associates, Inc.	85	Thomson CSF Bazaine Publicite	98
Electro Scientific Industries Commark Group, Inc.	63	Motorola Semiconductor Graham & Gillies Limited	35E	TRW/Capacitors Gray & Rogers, Inc.	107
Esterline Angus, A Unit of Esterline Corporation Odiorne Industrial Advertising, Inc.	57	National Semiconductors Limited Greiner Harries Maclean, Ltd.	110	Unitrode Corporation Culver Advertising, Inc.	21
Fabbrica Italiana Magneti Marelli S.p.A. Publicor	39E	Nuovo Pignone Attivita Pignone Sud Linea Spn	56E	Wandel und Goltermann Werbeagentur	52E
Fluke Manufacturing Co., John Bonfield Associates	33	Ofakim Transformers Limited International Media	30	Wavetek San Diego Chapman Michetti Advertising	108
FMC Corporation— Semiconductor Products Operation DeSales Advertising, Inc.	86	Panasonic Ogilvy & Mather, Inc.	31	Wima, Westermann Oliver-Beckmann GmbH	16
Gardner-Denver Co. Buchen Advertising, Inc.	116-117	Phillips Elcoma Intermarco Nederland	19E	Yokogawa Electric Works, Ltd. General Advertising Agency, Inc.	49E
Garrett Corp. J. Walter Thompson Company	53	Phillips Elcoma Brookies Communications	37E	Zeltex Zeltex Advertising Agency	123
General Electric Co. Semiconductor Products Department Advertising & Sales Promotion Syracuse Operation	22	Phillips Electrolgica Intermarco Nederland	45E, 32E	La ZincoLere S.p.A Studio Dr. Giuliano Blei	47E
General Instrument Europe S.p.A. Studio Sigismondi	20E	Phillips Industries Vaz Dias	2E-3E		
General Magnetics McCarthy/Scelba/DeBiasi Advertising Agency, Inc.	3rd Cover	Phillips N.V. Pit/T & M Division Brookies Communications Systems SA	46		
General Radio Grad Associates	9E	Photocircuits Ries Cappiello Colwell, Inc.	12-13		
Guardian Electric Manufacturing Company Kolb/Tookey and Associates, Inc.	15	Piher International Ltd. Scott MacTaggart Advertising	53		
Hewlett-Packard Richardson, Seigle, Rolfs & McCoy, Inc.	94-95	Primo Co., Ltd. General Advertising Agency, Inc.	119		
		Procond S.p.A. Quadrangolo	44E		
		Programmed Power, Inc. Moser & Associates	115		
		RCA Electronic Components Al Paul Lefton Company, Inc.	15		

Classified & Employment Advertising

F. J. Eberle, Manager 212-997-2557

EQUIPMENT (Used or Surplus New) For Sale	
American Used Computer Corporation	124
Detronics Corporation	124
Fishman, P. Co.	124
Jensen Tools & Alloys	124
Radiation Devices Company	124
Radio Research Instrument Company	124

For more information on complete product line see advertisement in the latest Electronics Buyer's Guide
 * Advertisers in Electronics International
 † Advertisers in Electronics domestic edition

Advertising Sales Staff

Pierre J. Braudé New York [212] 997-3468
Director of Marketing

Atlanta, Ga. 30309: Joseph Lane
100 Colony Square, 1175 Peachtree St., N.E.
[404] 892-2868

Boston, Mass. 02116: James R. Pierce
607 Boylston St. [617] 262-1160

Chicago, Ill. 60611:
645 North Michigan Avenue
Robert W. Bartlett (312) 751-3739
Paul W. Reiss (312) 751-3738

Cleveland, Ohio 44113: William J. Boyle
[716] 586-5040

Dallas, Texas 75201: Charles G. Hubbard
2001 Bryant Tower, Suite 1070
[214] 742-1747

Denver, Colo. 80202: Harry B. Doyle, Jr.
Tower Bldg., 1700 Broadway
[303] 266-3863

Detroit, Michigan 48202: Robert W. Bartlett
1400 Fisher Bldg.
[313] 873-7410

Houston, Texas 77002: Charles G. Hubbard
Dresser Tower, 601 Jefferson St., [713] 224-8381

Los Angeles, Calif. 90010: Robert J. Rielly
Bradley K. Jones, 3200 Wilshire Blvd., South Tower
[213] 487-1160

New York, N.Y. 10020
1221 Avenue of the Americas
Warren H. Gardner [212] 997-3617
Michael J. Stoller [212] 997-3616

Philadelphia, Pa. 19102: Warren H. Gardner
Three Parkway,
[212] 997-3617

Pittsburgh, Pa. 15222: Warren H. Gardner
4 Gateway Center, [212] 997-3617

Rochester, N.Y. 14534: William J. Boyle
9 Greylock Ridge, Pittsford, N.Y.
[716] 586-5040

San Francisco, Calif. 94111: Don Farris
Robert J. Rielly, 425 Battery Street,
[415] 362-4600

Paris: Alain Offergeld
17 Rue-Georges Bizet, 75 Paris 16, France
Tel: 720-73-01

Geneva: Alain Offergeld
1 rue du Temple, Geneva, Switzerland
Tel: 32-35-63

United Kingdom & Scandinavia: Keith Mantle
Tel: 01-493-1451, 34 Dover Street, London W1

Milan: Robert Saidel
1 via Baracchini, Italy Phone 86-90-656

Brussels: Alain Offergeld
23 Chaussee de Wavre
Brussels 1040, Belgium
Tel: 13-73-95

Frankfurt/Main: Fritz Krusebecker
Liebigstrasse 27c, Germany
Phone 72 01 81

Tokyo: Tatsumi Katagiri, McGraw-Hill
Publications Overseas Corporation,
Kasumigaseki Building 2-5, 3-chome,
Kasumigaseki, Chiyoda-Ku, Tokyo, Japan
[581] 9811

Australasia: Warren E. Ball, IPO Box 5106,
Tokyo, Japan

Business Department

Stephen R. Weiss, Manager
[212] 997-2044

Thomas M. Egan,
Production Manager [212] 997-3140

Carol Gallagher
Assistant Production Manager [212] 997-2045

Dorothy Carter, Contracts and Billings
[212] 997-2908

Frances Vallone, Reader Service Manager
[212] 997-6057

Electronics Buyers' Guide

George F. Werner, Associate Publisher
[212] 997-3139

Regina Hera, Directory Manager
[212] 997-2544

Plug in...wire...modify...build...test

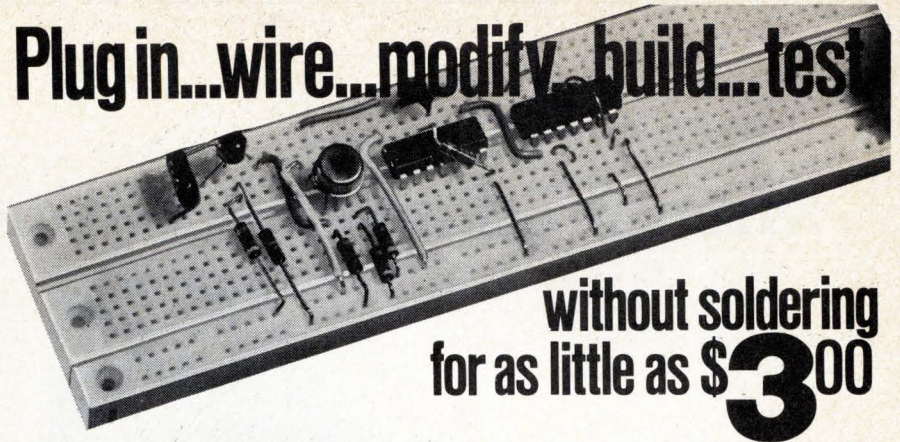

without soldering for as little as \$300

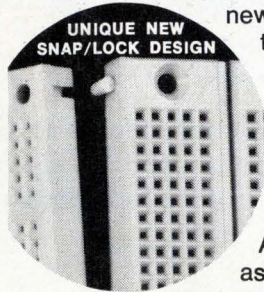

Introducing QT SOCKETS™ and BUS STRIPS, a flexible new breadboarding system with unique SNAP/LOCK that lets you expand or contract your project by simply snapping together as many QTs as you need. Test ICs, transistors, resistors, capacitors and more. Just plug in, connect with solid #22 AWG hook up wire—no soldering needed! Reuse QTs again and again. No more shorting or burnt fingers! No special patch cords! Available in 10 different sizes, starting as low as \$3 for QT Sockets, \$2 for Bus Strips.

FREE SELECTION GUIDE

Write or phone today for application and product photos, drawings, specs, socket sizes and ordering information.

Continental Specialties Corp 44 Kendall St., New Haven, CT Tel 203/624-3103

Circle 127 on reader service card

Presenting in your corner: THE ELECTRONICS BOXER!

Why mess around when you can have the ELECTRONICS BOXER clean up your copies—keep them in top condition.

And, it's easy and inexpensive to keep the ELECTRONICS BOXER in your corner. Just complete the coupon and mail. Your order will be processed immediately, postpaid.

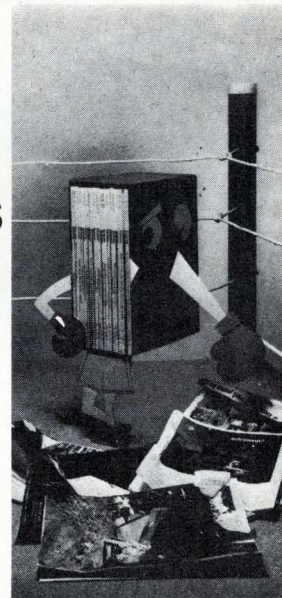

ELECTRONICS BOXER

Jesse Jones Box Corporation

2250 E. Butler St., Philadelphia, Pa. 19137

Please send me: boxes @ \$4.25 each;

3 boxes @ \$12.00; 6 boxes @ \$22.00

My check or money order is enclosed.

Name _____

Address _____

City _____ State _____ Zip _____

when it comes to communications...



ECI designs, manufactures and supplies Electronic equipment and systems.

- Airfield Towers Control Systems. • Mobile (Shelters) and Static Communications Systems.
- Versatile Intercommunication Equipment-commercial, military, marine, airborne.

Shifrin & Naaman

ELECTRONICS CORPORATION OF ISRAEL LTD.

88 Giborei Israel Street, Tel-Aviv, Israel.

Tel: 255181 (5 lines) Cables: Elcoris Telex: 03-3578



member of the
CLAL Group

Circle 128 on reader service card

The Ballantine 512 MHz DIGITAL COUNTER



The 5700A Frequency Counter. Range 10 Hz to more than 512 MHz. Nine digit display. Carrier measurements to 1 Hz resolution in 2 seconds of keyed transmitter time. Selective signal tone checks to 0.1 Hz resolution. Sensitivity 10 mV rms with AGC. Stability 3/10⁷/month. 3/10⁹/day optional.

- HIGHEST SENSITIVITY
- BEST RESOLUTION
- FASTEST COUNT RATE
- LOWEST PRICE **\$995**

Meets FCC Requirements



Ballantine Laboratories, Inc.

P.O. Box 97, Boonton, New Jersey 07005
201-335-0900, TWX 710-987-8380

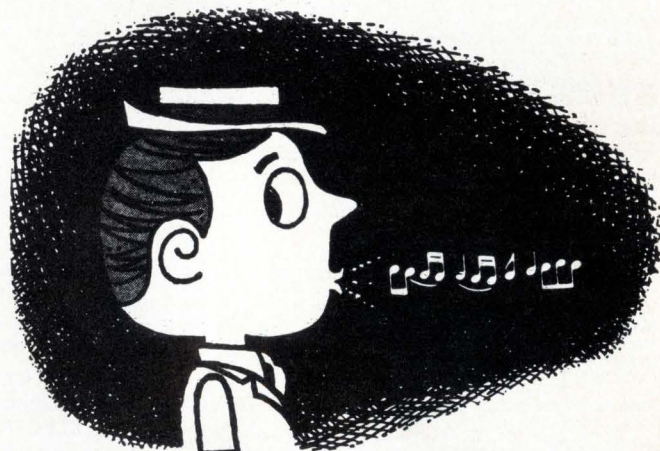

YOU'RE WHISTLING IN THE DARK...

if you think that heart disease and stroke
hit only the other fellow's family.

**GIVE ... so more will live
HEART FUND**



Contributed by the Publisher

128 Circle 148 on reader service card

Electronics/December 26, 1974