

- 96 Coping with errors in fast Fourier transforms
- 108 Technology update: semiconductor random-access memories
- 113 Thermal design, part 7: handling power-dense LSI

LIBRARY  
STATE TECHNICAL INSTITUTE  
AT MEMPHIS

# Electronics®

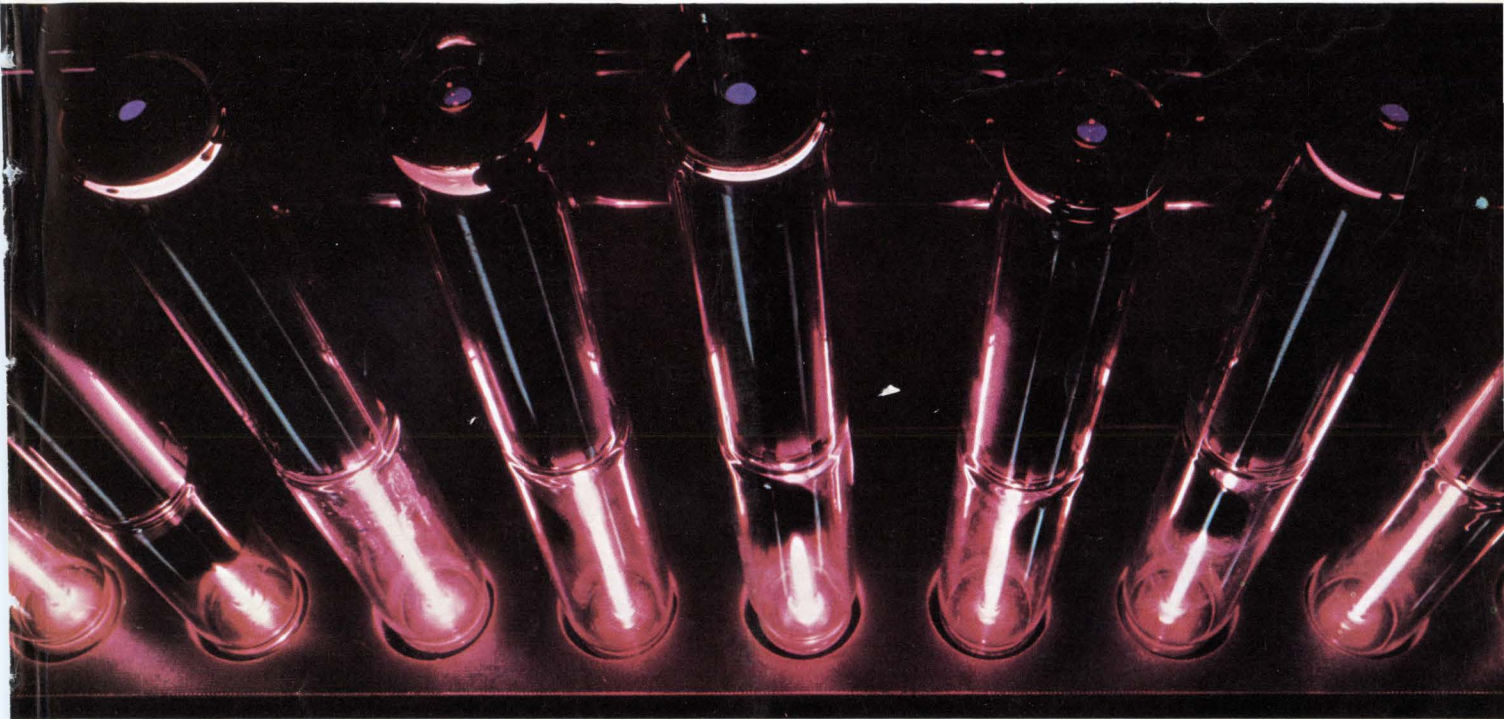

## LOW COST LASERS LINE UP FOR NEW MASS MARKETS

1420 TCH596 NCSA9 JUN75  
STATE TECHNICAL INSTITUTE  
LIBRARY PERIODICALS 14585  
5983 MACON COVE  
MEMPHIS TN  
38134

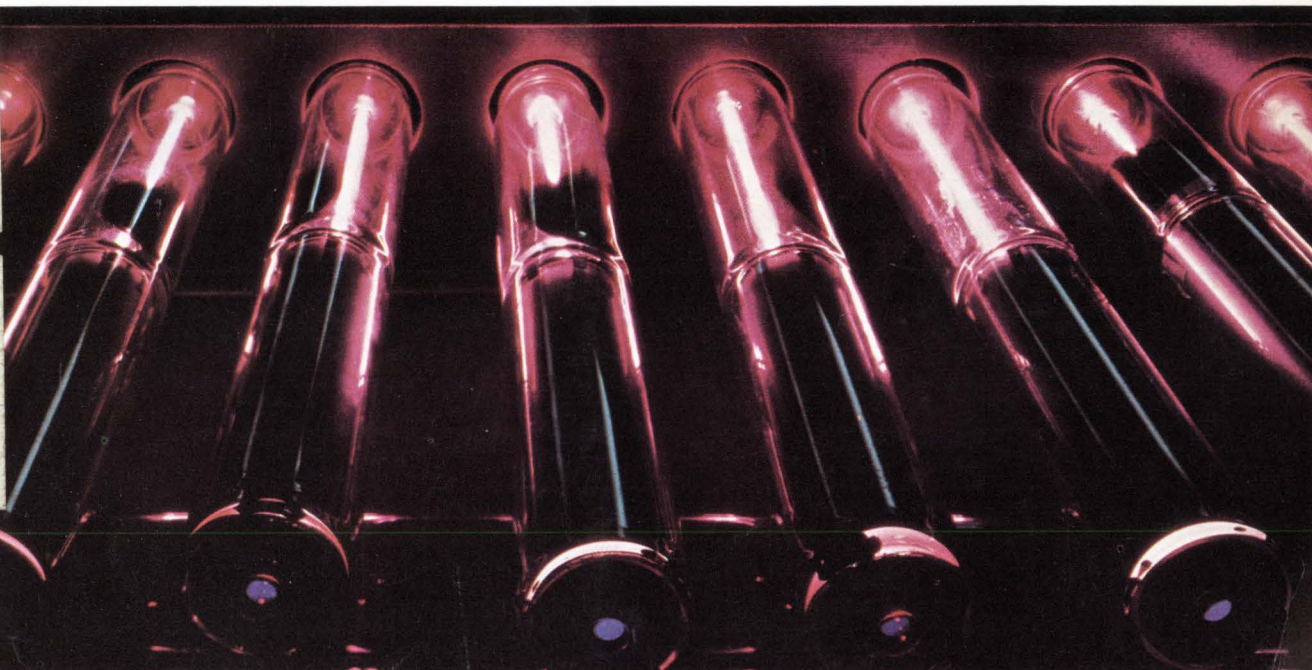

# Ludwig Lectures.

## Getting a fix on fast settling.

In numerous linear-circuit applications where the nature of the signal is pulse-like or step-like it is essential to reach a new level quickly and accurately after a large signal transition. However, we find that we cannot predict this performance from the classical specifications of frequency response and slew rate. Therefore, a direct specification — settling time — was established which defines the maximum total time required from the occurrence of an abrupt input transition until change is *satisfactorily complete*.

### A slight misunderstanding...

The major areas of concern are in defining the input conditions, and what it means for the output change to be *satisfactorily complete*.

The real settling spec ought to cover these by defining a settling time to within X% (for example .01%) of final value for a large signal change (usually 10V) on the input. But both must be stated.

### Close, but no cigar.

Some vendors base "Settling Time" specs on a small step change at the input and you still don't know what will happen in the large signal case. But the issues of "satisfactorily complete" on the output is full of cute pitfalls — let me show you.

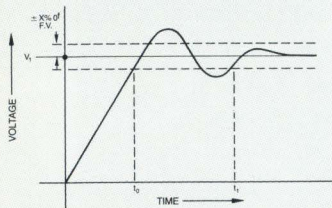

Notice in the curve that the output first occurs with  $\pm X\%$  a full-scale-error-to-final-value at  $t_0$  but doesn't stay within this error band. It thereafter bangs around due to the underdamped nature of the system. The real settling time should be stated as  $t_1$ .

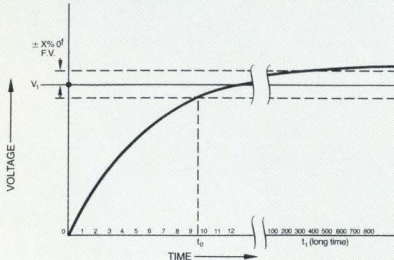

Now look at graph B. The response is critically damped and settling seems to occur at  $t_0$ . But watch out. If we look far down scale we note that the apparent final level  $V_1$  wasn't the final level at all.

Circle 900 on reader service card

Question, how long do you wait to define what  $V_1$  (final level) really is? You have to figure that out.

This long settling "tail" often occurs with time constants long compared to any computable electrical time constants in the system and is usually the result of less than ideal thermal management or slight pole/zero mismatch. If you're trusting your vendor's settling time measurements, make sure that you (and your vendor) understand his definition and their use of it, otherwise you're in trouble.

### Who needs it?

Anyone handling signals having discontinuities needs fast settling. For example, following a multiplexer, on a PAM Bus, at the output of a DAC, in building a precision square wave, at the input to an oscilloscope, etc.

### How good can you have it?

At Philbrick we give you *guaranteed* settling time because we figure your system has to always meet its spec — not just typically and that's more than just important. We offer a host of op amps, discrete modules, hybrid IC's and monolithic IC's with state of the art settling including our T099 units, 1322 (300 ns to .1%), 1324 (1  $\mu$ sec. to .01%), guaranteed. The star of the show is our new DIP unit with FET inputs, the 1430, which offers 100 ns to .1% and 200 ns max to .01%. And you

don't give up dc performance to get it. The 200 ns to .01% is just what you need for a fast 12 bit system and open loop gain of 200K plus, input currents of 10 pA, and offset voltage of 1mV give you the dc accuracy to go with it. The 50 mA output capability will let you drive almost anything, but you don't pay for it with high quiescent current and its attendant power consumption.

### Don't settle for less.

You could have the fastest settling op amp in the world and get lousy system settling unless you're very careful. Some of the common pitfalls that catch people are things like too much load capacity, too much summing point capacity, too high a circuit impedance for the stray and input capacities, use of inductive wire-wound resistors, and not figuring on the effect of current source output capacities in current-to-voltage converter applications. You've got to handle your power supplies very carefully too, by bypassing up close to the unit with the right kind of capacitor.

In any event, to make sure you get the right story on settling time and use the information properly, telephone, (617) 329-1600. Or write us, Dedham, Mass. 02026. In Europe, Tel. 73.99.88, Telex: 25881. Or write, 1170 Brussels, Belgium.

 **TELEDYNE  
PHILBRICK**

Dave Ludwig  
Director of Engineering

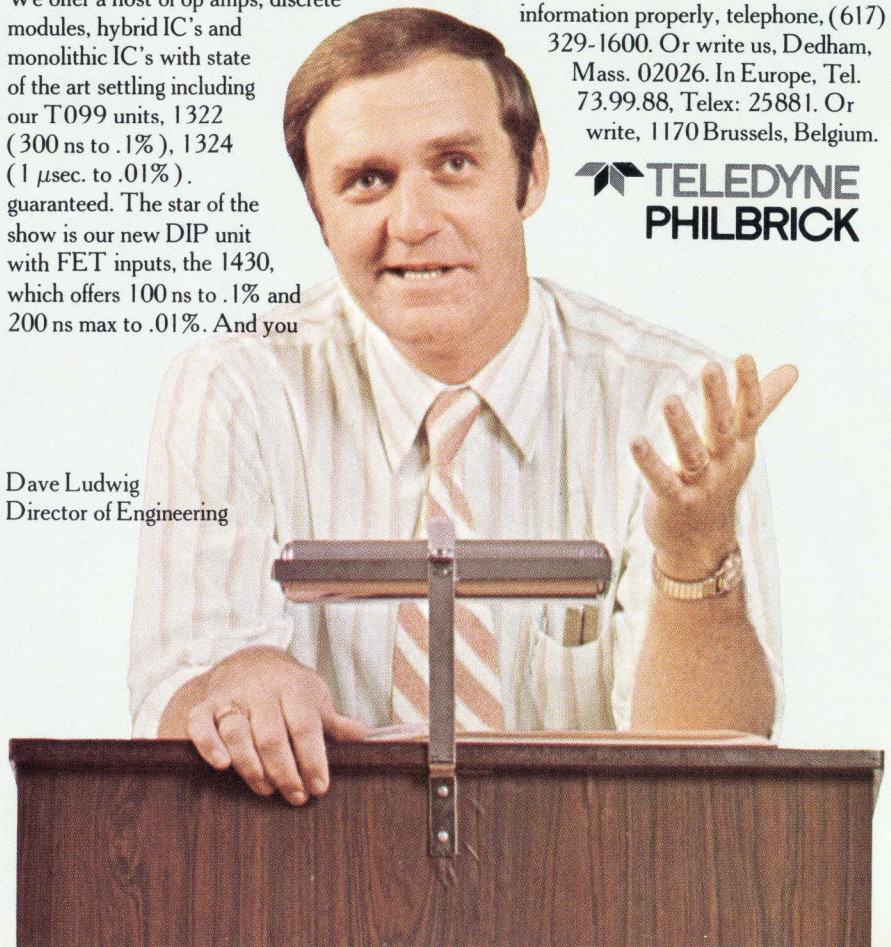

# KEPCO

## programming interface



The five Kepco SN models offer a selection of DAC's for the digital control of anything that can be programmed by a 10V analog signal. You need no digital experience to use the SN. We've built-in the power—all you need is the 115/230V a-c line. We've built-in the data storage and delayed strobe for glitchless programming. All you need is a 10 microsecond pulse or a switch closure. We've built-in the isolation—so you don't need to worry about grounding. We've built the PC board and a variety of housings—all you need to mount them is a bench top or rack space or a small slot in your equipment.

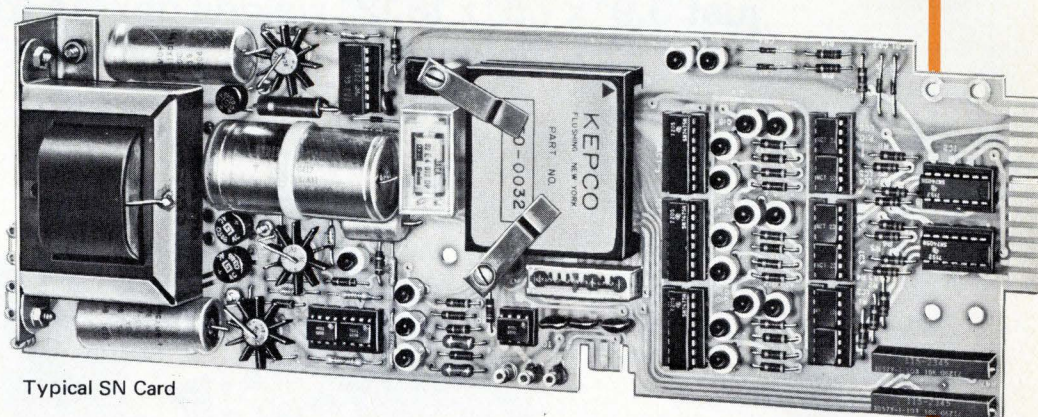

Typical SN Card

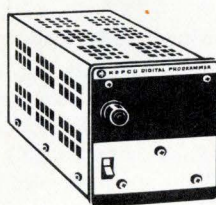
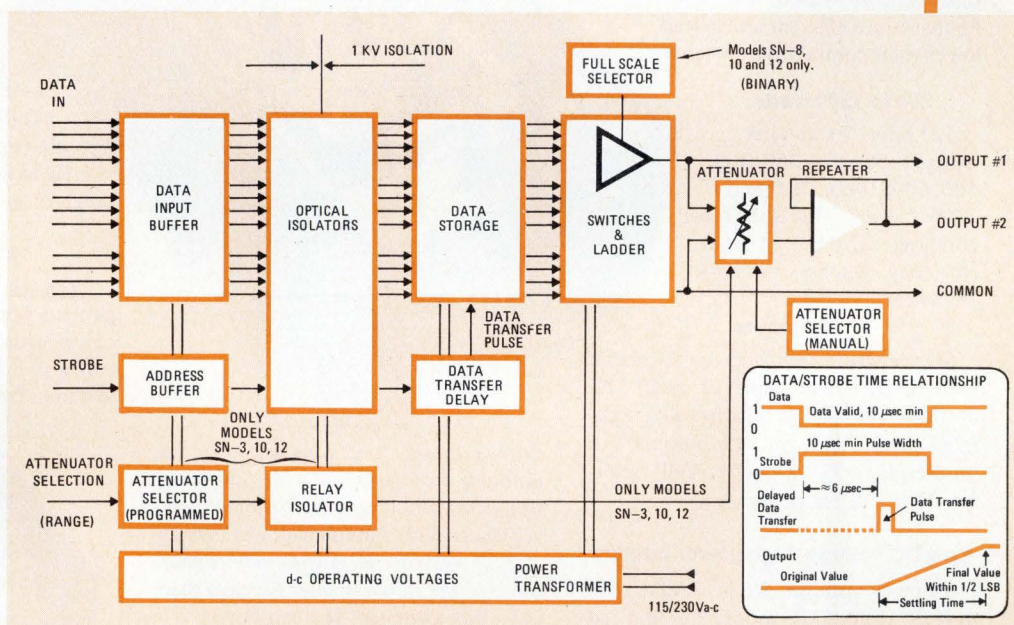

The CA-6 enclosure accommodates 2 SN Cards.

The SN Cards mount up to 6 abreast in a convenient plug-in format.

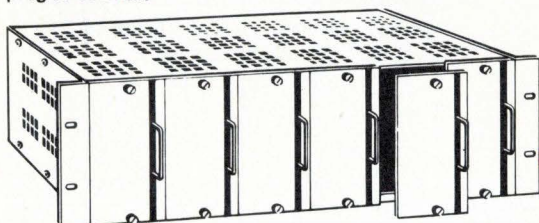

SPECIFICATIONS	MODEL SN-2	MODEL SN-3	MODEL SN-8	MODEL SN-10	MODEL SN-12
RESOLUTION	2-Digit	3-Digit	8-Bit	10-Bit	12-Bit
INPUT DATA CODING	COMPLEMENTARY BINARY CODED DECIMAL 4 LINES PER DIGIT 8-4-2-1		BIPOLAR OUTPUT: COMPLEMENTARY OFFSET BINARY UNIPOLAR OUTPUT: COMPLEMENTARY BINARY		
ACCURACY @ 25°C (% OF FULL SCALE READING) SCALE FACTOR ERROR <sup>(1)</sup>	±0.2%	±0.1%	±0.1%	±0.1%	±0.05%
ZERO OFFSET	ZEROING TRIMMER IS BUILT-IN.				
LINEARITY	±0.2%	±0.05%	±0.2%	±0.05%	±0.01%
PRICE	\$370.00	\$532.00	\$370.00	\$469.00	\$571.00

(1) May be calibrated with optional trimmer, Option "R"—Price: \$10.00. Add the option letter as a suffix to the model number.

For complete specifications and applications notes, write Dept. EH-14

# KEPCO

**New! A 600-watt, 5V, 100 amps switching regulated power supply that has four outputs, measures just 3.9" x 7.5" x 16.12", weighs only 14 lbs., is 75% efficient and costs only \$493.\***

**And LH has 84 other equally exciting models to choose from** — all of them smaller, lighter, more efficient and priced lower than competitive switchers.

**250 to 1500 watts**

LH offers 7 standard wattage ratings — 250, 300, 500, 600, 1000, 1200 and 1500\*\* watts. This is the most comprehensive line of high-efficiency switchers available anywhere.

**4 outputs**

Standard LH switchers are available with single, dual, triple or quad DC outputs. Primary output is fully regulated. 2nd, 3rd and 4th outputs are semi-regulated, but may be fully regulated for \$30 per output.

**Low DC voltage, high power outputs**

Primary voltages are at 5 VDC; 50, 100, 200 and 300\*\* amps. 2nd and 3rd voltages are standard  $\pm 12$ ,  $\pm 15$  and  $\pm 18V$  at 8 amps each; 4th voltage is 24V at 2 amps. Other voltages available.

**Input voltages externally selectable**

110/220 VAC, 47 to 440 Hz, can be selected by simply changing a jumper on the front terminal strip. DC input, 24 to 300 VDC, also available.

**6 case configurations**

All LH switchers use one basic

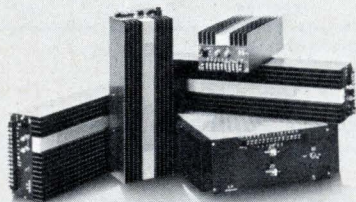

\*1000 pc. qty.

\*\*Available Sept. '74

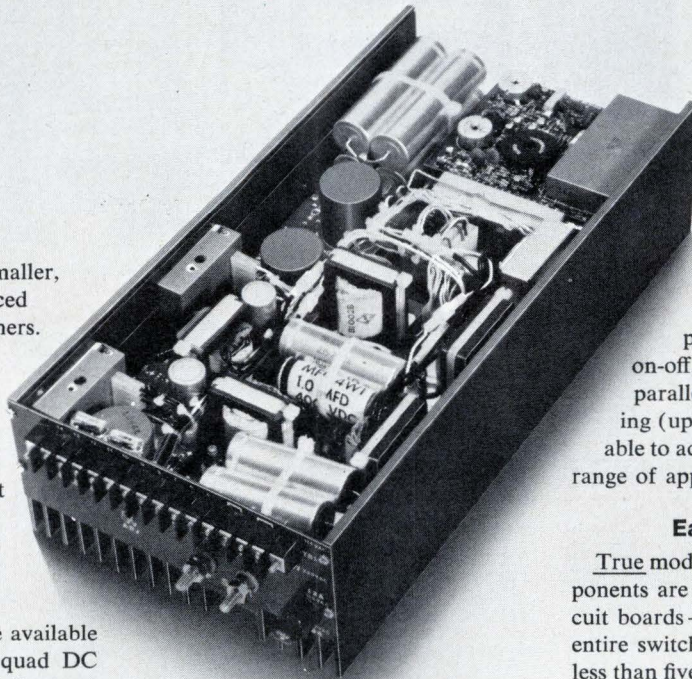

**A number of options**

Over-voltage protection, power fail detection, remote on-off, thermal cutoff, DC input, paralleling, master-slave paralleling (up to 10 units) — all are available to adapt LH switchers to a wide range of applications.

**Easy maintenance**

True modular construction — all components are mounted on just three circuit boards — make servicing easy. The entire switcher can be disassembled in less than five minutes.

proven design and package it in six different case shapes — wide and short or narrow and long — for customer convenience. With a nominal power density of 1.37 watt/cu. in., LH switchers pack more power into a smaller package than any other switchers you can buy.

**80% efficient**

On single output models, over 80% of the primary input power is delivered to the output terminal. On models with dual, triple and quad outputs, efficiency averages 75%.

**Lighter weights**

For example, LH's 250-watt single output model weighs only 7 lbs.; the 1200-watt, quad output unit, just 30 lbs.

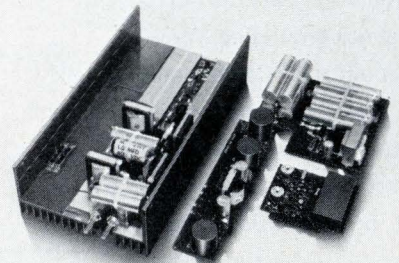

**Priced as low as 63¢/watt**

Watt-for-watt, LH units are the lowest priced switching regulated power supplies you can buy. In 1 to 24 quantity, a 250-watt single output model sells for \$360; a 1200-watt quad goes for \$1245.

**Ask for full-line folder**

The LH rep in your area has a new six-page folder that fully describes the 85 standard LH switchers, and discusses possible options and modifications to meet specific requirements.

Ask him for a copy today.



LH RESEARCH, INC., 2052 South Grand Avenue, Santa Ana, CA 92705 • (714) 546-5279

## 39 Electronics review

DISPLAYS: LED with storage simplifies drive circuitry, 39  
Thin-film light makes TV panel, 40  
COMMERCIAL ELECTRONICS: OCR equipment reads hand printing, 40  
MATERIALS: Key to faster crystal growth studied at RPI, 41  
FIBER OPTICS: Thin-film layer cancels polarization, 41  
PRODUCTION: Microprocessors monitor torque, 42  
INDEX OF ACTIVITY: 44  
MEDICAL ELECTRONICS: Ultrasonic diagnosis speeded up, 44  
NEWS BRIEFS: 46  
MEMORIES: A CCD memory sits and waits, 48  
CONSUMER ELECTRONICS: Quasar goes to Matsushita, 48  
MILITARY ELECTRONICS: French and U. S. fighters compete, 48  
Defense outlays seen rising beyond 1975, 50  
GOVERNMENT ELECTRONICS: ESS economies cited in FCC probe, 50  
SOLID STATE: MOS 1974 sales to hit \$800 million, 52

## 62 Electronics International

ITALY: SGS-Ates packs 20 W into IC audio amplifier, 62  
GREAT BRITAIN: BBC looks at digital TV recording, 62  
JAPAN: Sony colors its gas-discharge TV panel, 62  
AROUND THE WORLD: 63

## 75 Probing the News

COMMERCIAL ELECTRONICS: Has checkless banking bounced? 75  
COMMUNICATIONS: Marisat partners seek accord, 78  
SOLID STATE: LSI testing: A three-way street, 84  
INTERNATIONAL: Hot Line takes space journey, 86  
PATENTS: Components makers in Europe get reprieve, 89

## 91 Technical Articles

LASERS: Laser becomes a component for mass-market gear, 91  
MEASUREMENTS: Predicting fast Fourier transform errors, 96  
DESIGNER'S CASEBOOK: Noise blanker cleans up audio signals, 104  
Variable voltage source has independently adjustable TC, 105  
Switched frequency doubler provides multiple outputs, 106  
TECHNOLOGY UPDATE: Matching RAMs to systems, 108  
THERMAL DESIGN: Part 7, Air through hollow cards cools LSI, 113  
ENGINEER'S NOTEBOOK: Probing system noise, 122  
Another way to build a two-gate flip-flop, 124  
Polynomial expansion beats calculator-display limits, 125

## 133 New Products

IN THE SPOTLIGHT: Multimeter rides piggyback on scope, 133  
Optical waveguide spans 500 meters, 137  
COMPONENTS: Switches aimed at metric design, 140  
INDUSTRIAL: Digital process indicators cover wide range, 149  
SUBASSEMBLIES: D-a converter uses C-MOS switches, 159  
COMMUNICATIONS: Receiver can test propagation paths, 171  
MATERIALS: Elastomer has characteristics of a sensor, 178

## Departments

Publisher's letter, 4  
Readers comment, 6  
People, 14  
40 years ago, 28  
Meetings, 30  
Electronics newsletter, 35  
News update, 54  
Washington newsletter, 59  
Washington commentary, 60  
International newsletter, 65  
Engineer's newsletter, 128  
New literature, 186  
New books, 194

## Highlights

### The cover: Lasers penetrate big, new markets, 91

Transformation of the helium-neon laser into a safe, reliable assembly-line product has pushed the price below \$100 apiece in quantity. First volume applications will probably be in label readers for the supermarket and video-disk scanners for the home.

### Checkless banking is still in the balance, 75

Deterred by the high cost of computerizing every transfer of funds, banks are at present installing only partial systems. But total electronic systems will become more economical than manual processing if the flood of paperwork rises much higher.

### Learning to live with FFT errors, 96

The errors that almost always accompany the fast Fourier transform are inherent in the process of digitizing an analog wave form. Being predictable, they are easy to recognize and correct.

### Technology update: semiconductor RAMs, 108

Products of a technology that refuses to stand still, random-access memories on chips have expanded their capabilities enormously in the last two years. This survey first discusses the devices available today in terms of their major applications, then describes the RAMs that will hit tomorrow's market.

### And in the next issue . . .

How eight European EEs view their profession . . . a two-chip analog-to-digital converter . . . speaking the microprocessor's language.

EDITOR-IN-CHIEF: Kemp Anderson

EXECUTIVE EDITOR: Samuel Weber

MANAGING EDITORS: Lawrence Curran, *News*;  
Arthur Erikson, *International*

SENIOR EDITORS: John Johnsrud,  
H. Thomas Maguire, Laurence Altman  
Ray Connolly, Stephen E. Scrupski

ART DIRECTOR: Fred Sklenar

ASSOCIATE EDITORS: John N. Kessler,  
Howard Wolff, Gerald M. Walker

DEPARTMENT EDITORS

*Circuit Design*: Lucinda Mattera  
*Communications & Microwave*:  
Stephen E. Scrupski

*Components*: Joel DuBow  
*Computers*: Wallace B. Riley  
*Consumer*: Gerald M. Walker  
*Industrial*: Michael J. Riezenman  
*Instrumentation*: Stephen E. Grossman  
*Military*: Ray Connolly  
*New Products*: H. Thomas Maguire  
*Solid State*: Laurence Altman

COPY EDITORS: Margaret Eastman,  
Everett C. Terry

ASSISTANT EDITOR: Marilyn Offenheiser

ART: Charles D. Ciatto, *Associate Director*  
Patricia Cybulski, *Assistant Director*

PRODUCTION EDITOR: Arthur C. Miller

EDITORIAL SECRETARIES: Janet Annunziata,  
Julie Gorgoglione, Penny Roberts

FIELD EDITORS

*Boston*: Gail Farrell  
*Los Angeles*: Paul Franson (Mgr.)  
*Midwest*: Larry Armstrong (Mgr.)  
*New York*: Alfred Rosenblatt (Mgr.)  
*San Francisco*: Bernard Cole (Mgr.)  
Judith Curtis  
*Washington*: Ray Connolly (Mgr.)  
*Frankfurt*: John Gosch  
*London*: William F. Arnold  
*Paris*: Arthur Erikson  
*Tokyo*: Charles Cohen

McGRAW-HILL WORLD NEWS

*Director*: Ralph R. Schulz  
*Bonn*: Robert Ingersoll  
*Brussels*: James Smith  
*London*: Marvin Petal  
*Milan*: Peter Hoffmann, Andrew Heath  
*Moscow*: Axel Krause  
*Paris*: Michael Johnson, Richard Shepherd  
*Stockholm*: Robert Skole  
*Tokyo*: Mike Mealey

PUBLISHER: Dan McMillan

DIRECTOR OF MARKETING: Pierre J. Braudé

ADVERTISING SALES SERVICE MANAGER:  
Wallis Clarke

BUSINESS MANAGER: Stephen R. Weiss

CIRCULATION MANAGER: Nancy L. Merritt

MARKETING SERVICES MANAGER:  
Tomlinson Howland

RESEARCH MANAGER: Margery D. Sholes

**T**echnology Update is the name of a new series of articles that we have inaugurated with this issue. The first installment in the continuing series covers semiconductor random-access memories, one of the most active areas in all of electronics technology.

So turn to page 108 for a status report on the state of the art in semiconductor RAMs. There you'll find a summary of what's been happening recently as consumption of these memories-on-a-chip have grown from 3 million units two years ago to more than 75 million.

You'll find, too, a look into the immediate future, as Solid State Editor Larry Altman pins down the best industry estimates about near-term availability of devices, technological trends, and—most important—pricing. There's also a glossary explaining some RAM buzzwords.

This new series in *Electronics* does for our technology feature articles what another recently started column—News update (p. 54)—does for our news sections. Both are designed to bring you up to date on the wide variety of developments in the fast-moving field of electronics.

## Has checkless banking bounced?

That's the question we raise in the Probing the News story on page 75. The answer? No. But the pace of progress toward electronic funds-transfer systems (EFTS) has been far from rapid. Indeed, as Consumer Editor Jerry Walker indicates in the story, the "cashless society" that such systems would make possible is still a long way off.

Yet trials of such systems are under way around the country, and several aspects of the cashless society—such as direct point-of-sale

## Publisher's letter

credit verification and remote "convenience" terminals promoted by some full-service banks—are already catching on.

The main obstacles to electronically containing the rising flood of banking paperwork appear to be standardization and the high cost of converting from one system to another. Yet, points out Walker, "few technical problems stand in the way of EFTS. Rather its a question of organizing the computers, communications networks, and terminals into workable systems."

**T**hanks to the British, whose new government is reconsidering whether the United Kingdom should even be in the Common Market, component makers have won a reprieve from the terms of new European patent laws.

Dick Shepherd, McGraw-Hill World News correspondent reporting from Brussels, follows the rocky course the European nations are taking toward unity and spotted the story that you'll find on page 89. It seems that in reevaluating its own position in Europe, Britain refused, only five days before its start, to join in a meeting where a Common market patent treaty was to be signed. And, the treaty would have outlawed one of the frequently used marketing strategies of the electronic-component makers: controlling trade of their products between countries in which they have patents. But that is just one of several complaints that industry has against Europe's patent-streamlining plans. You can read about it on page 89.

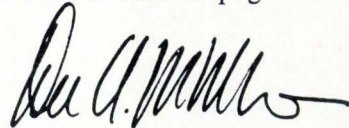

June 13, 1974 Volume 47, Number 12  
94,913 copies of this issue printed

Published every other Thursday by McGraw-Hill, Inc. Founder: James H. McGraw 1860-1948. Publication office 1221 Avenue of the Americas, N.Y., N.Y. 10020; second class postage paid at New York, N.Y., and additional mailing offices.

Executive, editorial, circulation and advertising addresses: Electronics, McGraw-Hill Building, 1221 Avenue of the Americas, New York, N.Y. 10020. Telephone (212) 997-1221. Teletype TWX N.Y. 710-581-5234. Cable address: MCGRAW HILL L.N.Y.

Subscriptions limited to persons with active, professional, functional responsibility in electronics technology. Publisher reserves the right to reject non-qualified requests. No subscriptions accepted without complete identification of subscriber name, title, or job function, company or organization, including product manufactured or services performed. Subscription rates: qualified subscribers in the United States and possessions, Canada, and Mexico \$12.00 one year, \$24.00 three years; all other countries \$25.00 per year, except Japan \$50.00 per year, Brazil \$40.00 per year, Australia and New Zealand \$60 per year, including air freight. Limited quota of subscriptions available at higher-than-basic rate for persons outside of field served, as follows: U.S. and possessions and Canada, \$25.00 one year; all other countries \$50.00. Single copies: United States and possessions and Canada, \$1.50; all other countries, \$2.00.

Officers of the McGraw-Hill Publications Company: John R. Emery, President; J. Elton Tuohig, Executive Vice President-Administration; Gene W. Simpson, Group Publisher-Vice President; Senior Vice Presidents: Ralph Blackburn, Circulation; Walter A. Stanbury, Editorial; John D. Hoglund, Controller; David G. Jensen, Manufacturing; Gordon L. Jones, Marketing; Jerome D. Luntz, Planning & Development.

Officers of the Corporation: Shelton Fisher, President; Wallace F. Traendly, Group President, McGraw-Hill Publications Company and McGraw-Hill Information Systems Company; Robert N. Landes, Senior Vice President and Secretary; Ralph J. Webb, Treasurer.

Title registered in U.S. Patent Office; Copyright © 1974 by McGraw-Hill, Inc. All rights reserved. The contents of this publication may not be reproduced either in whole or in part without the consent of copyright owner.

Subscribers: The publisher, upon written request to our New York office from any subscriber, agrees to refund that part of the subscription price applying to copies not yet mailed. Please send change of address notices or complaints to Fulfillment Manager; subscription orders to Circulation Manager, Electronics, at address below. Change of address notices should provide old as well as new address, including postal zip code number. If possible, attach address label from recent issue. Allow one month for change to become effective.

Postmaster: Please send form 3579 to Fulfillment Manager, Electronics, P.O. Box 430, Hightstown, N.J. 08520.

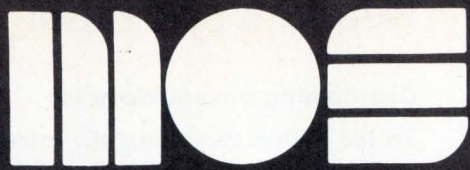

# 20 KEY SCIENTIFIC CALCULATOR ARRAYS

**18**  
MATHEMATICAL  
FUNCTIONS

**6**  
MEMORY  
OPERATIONS

**25**  
ENTRY AND  
CONTROL FUNCTIONS

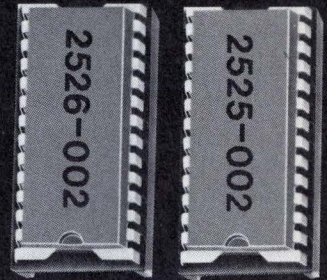

## FEATURING:

- ALGEBRAIC PROBLEM ENTRY
- TWO PARENTHESIS LEVELS
- SCIENTIFIC NOTATION
- 14 DIGIT DISPLAY
- FULL MEMORY CONTROL

## AND SIMPLIFIED ELECTRICAL DESIGN:

- DIRECT LED SEGMENT DRIVE
- MINIMUM POWER CONSUMPTION (200 mw Avg.)
- ON-CHIP CLOCKS, POWER-ON-CLEAR, LOW BATTERY DETECTOR AND DISPLAY CUTOFF

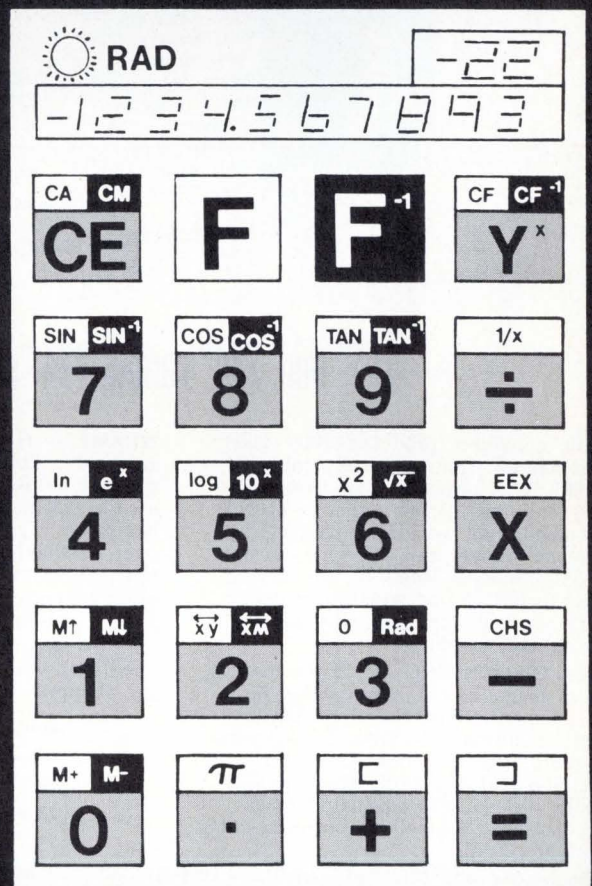

HEADQUARTERS — Applications Mgr.: Mr. Julius Hertsch  
MOS Technology, Inc., Norristown, Pa. 19401

CENTRAL REGION — MOS Technology, Inc., 838 S. Des Planes St.,  
Chicago, Illinois 60607 • (312) 922-0288

EASTERN REGION — Mr. William Whitehead, Suite 307 — 88 Sunnyside  
Blvd., Plainview, N.Y. 11803 • (516) 822-4240

WESTERN REGION — MOS Technology, Inc., 2172 Dupont Dr., Suite 221,  
Patio Bldg., Newport Beach, Calif. 92660 • (714) 833-1600

a proud affiliate of ALLEN-BRADLEY

WE'VE TURNED A TECHNOLOGY INTO A COMPANY



**MOS TECHNOLOGY, INC.**  
VALLEY FORGE CORPORATE CENTER, NORRISTOWN, PA. 19401 (215) 666-7950

# A Smart Way to Beat Your Power Supply Size Problem

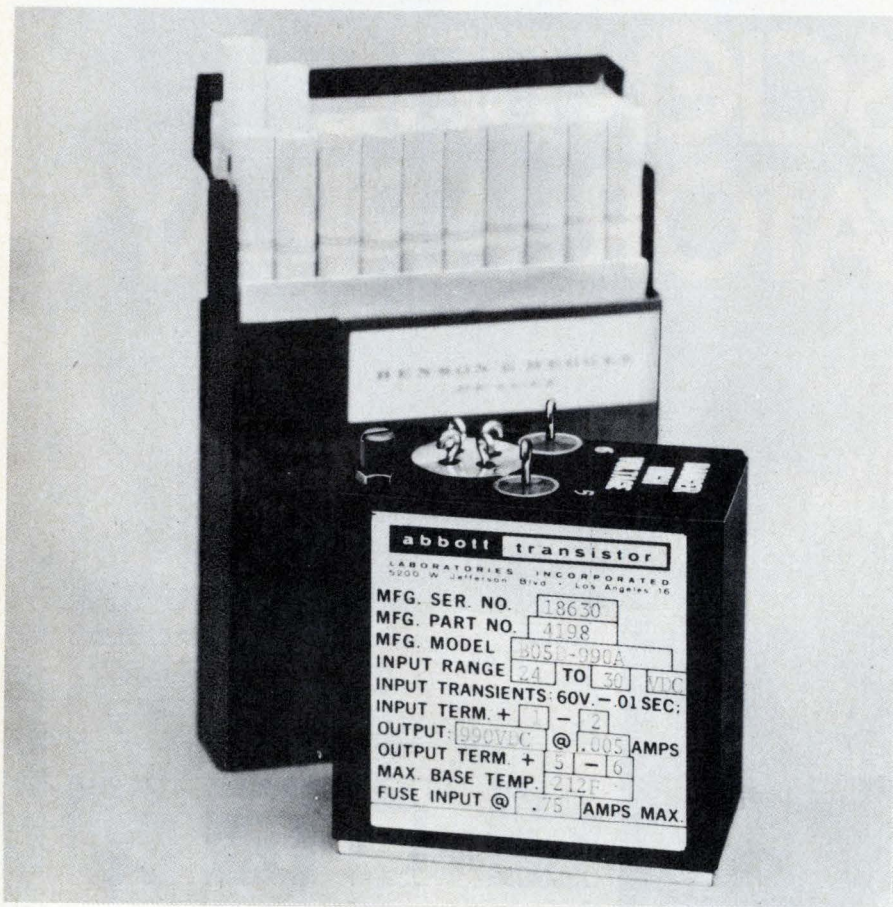

1½" thin, 2¾" narrow, 2¾" short

yet this converter produces 1000 volts DC, regulated, from a battery input of 28 VDC! It weighs less than 15 ounces. This is only one of our wide variety of many small light weight converters, inverters and power supplies — there are over 3000 models listed in our newest catalog, including size, weight and prices. If you have a size problem, why not send for an Abbott catalog?

**MIL SPEC ENVIRONMENT** — All of the power modules listed in our new catalog have been designed to meet the severe environmental conditions required by modern aerospace systems, including MIL-E-5272C and MIL-E-5400K. They are hermetically sealed and encapsulated in heavy steel containers. New all silicon units will operate at 100°C.

Please see pages 581-593 of your 1973-74 EEM (ELECTRONIC ENGINEERS MASTER Catalog) for complete information on Abbott Modules.

Send for our new 56 page FREE catalog.

**RELIABLE** — Highest quality components are used in Abbott power modules to yield the high MTBF (mean time between failure) as calculated in the MIL-HDBK-217 handbook. Typical power modules have over 100,000 hours MTBF — proving that the quality was built in from the beginning.

**WIDE RANGE OF OUTPUTS** — Any voltage from 5 volts DC to 3,650 VDC is available by selecting the correct model you need from our catalog with any of a variety of inputs including:

- 60 $\sim$  to DC, Regulated
- 400 $\sim$  to DC, Regulated
- 28 VDC to DC, Regulated
- 28 VDC to 400 $\sim$ , 1 $\phi$  or 3 $\phi$
- 24 VDC to 60 $\sim$ , 1 $\phi$

## Readers comment

### Overcoming waveguide noise

**To the Editor:** Regarding the interesting article on optical waveguides [*Electronics*, March 21, p.89], authors Thiel and Bielawski give a graph (Fig. 4, p.92) of minimum detectable signal for a photodiode-preamp combination. Ordinarily one thinks of "minimum detectable signal" as implying a noise figure on the order of 0 to 6 decibels. Their quoted figure of 10 nanowatts at 30 megahertz is about 50 dB above 300-kelvin thermal noise. I find it rather remarkable that the state of the art in this area is so poor.

Steve Smith  
Quatt Wunkery  
Richmond, Calif.

■**Mr. Thiel replies:** The figure of 10 nW at 30 MHz is indeed much in excess of thermal noise at 300 K. Thermal noise, however, is not the relevant parameter. One must consider shot and multiplication noise in the avalanche photodiode.

Even if followed by a perfectly noiseless transimpedance amplifier, this combination would have a noise output equivalent to a photon input at 900 nanometers of about 0.5 nW, some 36 dB above thermal noise. Photons of approximately 1.4 electronvolts of energy—and not electrons characterized by  $kT = 0.026$  eV—must be detected.

To the shot and multiplication noise must be added the contributions of thermal noise within the detector and shot and thermal noise in the transimpedance amplifier.

### Staking the 'wraparound' claim

**To the Editor:** In your article, "Energy crisis spurs development of photovoltaic power sources," [*Electronics*, April 4, p. 99], reference is made to "the 'wraparound' contact technique (for solar cells) recently developed by NASA."

Ferranti Ltd. designed, developed, and produced a solar cell with a wrap-round contact (WRC) back in 1969. A number of our WRC solar cells (0,005-inch thick) are carried on the British applications satellite, Black Arrow X3, launched in 1971.

Ira S. Gewant  
Ferranti Electric Inc.  
Plainview, N. Y.

**abbott transistor**

**LABORATORIES, INCORPORATED**

general offices

eastern office

5200 W. Jefferson Blvd./Los Angeles 90016  
(213) 936-8185 Telex: 69-1398

1224 Anderson Ave./Fort Lee, N.J. 07024  
(201) 224-6900 Telex: 13-5332



# Now you have an alternate source for 2GHz & 3GHz microwave transistors

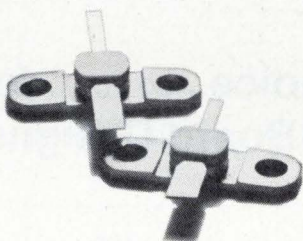

TRW's new 2GHz & 3GHz microwave amplifier parts are available right now, off-the-shelf, from any authorized TRW distributor. So, soon as you qualify these parts, you are no longer at the mercy of a single-source manufacturer!

And here's some more news: our transistors are **not** simply "just as good" as the originals; they're better! Gold metalized to last longer. Metal migration failure is virtually non-existent. The 2GHz parts can also withstand infinite VSWR and overdrive. Yet TRW's gold metalized parts cost the same as ordinary aluminum ones (maybe less!).

These are practically drop-in parts. You can use them right now, in your present amplifiers—and, of course, in future designs. That means instant

improvement in the reliability of your amplifiers. Part for part:

	2GHz PART NUMBERS 3GHz			
	Aluminum	Gold	Aluminum	Gold
1W	MSC2001	TRW2001	MSC3001	TRW3001
3W	MSC2003	TRW2003	MSC3003	TRW3003
5W	MSC2005	TRW2005	MSC3005	TRW3005
10W	MSC2010	TRW2010	—	—

For details, call Don Comm, (213) 679-4561.

Or write TRW RF Semiconductors, an Electronic Components Division of TRW Inc., 14520 Aviation Boulevard, Lawndale, California 90260.

## TRW<sup>®</sup> RF SEMICONDUCTORS

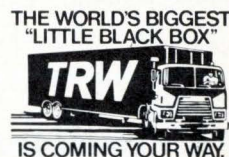

**These products are available through the following authorized distributors:**

Almo Electronics  
Bell Industries  
Cramer Electronics Inc.

Electronics Marketing Corp.  
Elmar Electronics Inc.  
Hall-Mark Electronics Corp.

Pytronic Industries Inc.  
Rochester Radio  
Semiconductor Concepts Inc.

R. V. Weatherford Co.  
Westates Electronics Corp.  
Wilshire Electronics

# GET ON BOARD...

## with TANTALEX<sup>®</sup> Low-Cost Solid Tantalum Capacitors

### Sprague Gives You a Choice . . . . . for Flexibility in Your Printed Board Designs.

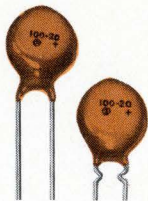

#### DIPPED . . . SPRAGUE TYPE 196D

Small size economical capacitors that utilize high-quality tantalum pellet construction. Conformal epoxy resin coating is highly resistant to moisture and mechanical damage. This capacitor has found wide usage in consumer and commercial electronic equipment. Operating temperature range, -55 C to +85 C. Available in all popular 10% decade values from 0.1  $\mu$ F to 330  $\mu$ F. Voltage range, 4 to 50 VDC. Standard lead spacing, 0.125" and 0.250". For complete data, write for Engineering Bulletin 3545B.

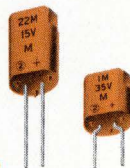

#### MOLDED . . . SPRAGUE TYPE 198D

Economically priced, molded-case Econoline<sup>™</sup> capacitors. Standard lead spacing, 0.100", 0.200", and 0.250". Tough, flame-retardant, crack resistant case has flattened section and polarity indicator for easy-to-read marking and error-free insertion. Fixed external dimensions allow increased productivity during assembly of PC boards. Designed for severe vibration and shock environment, where lead support alone is not adequate. Operating temperature range, -55 C to +85 C. Capacitance values from 0.1 to 100  $\mu$ F. Voltage range, 4 to 50 VDC. For complete data, write for Engineering Bulletin 3546.

Call your nearest Sprague district office or sales representative, or write for the bulletins mentioned above to Sprague Electric Company, 35 Marshall Street, North Adams, Mass. 01247.



THE BROAD-LINE PRODUCER OF ELECTRONIC PARTS

8 Circle 8 on reader service card

### Readers comment

#### MisLED Rdr RAMs Abbrs

**To the Editor:** The March 7 issue of *Electronics* LED me into HiNIL to improve my constitution. With this, my constitution could easily adapt to TTL, DTL, RTL, MOS, and C-MOS, all neatly packaged in DIPS.

I was sorry to hear that TI is having 4,096-bit RAM trouble, but happy to read of Motorola's CCITT modem. Perhaps I might suggest that VDO's speedometer, developed by Intermetall GmbH (an affiliate of ITT) might be used to measure the new muzzle velocity of Philips' LEP Gunn amplifier.

I let out a GaAsP when I read that RCA's Hi-Rel team can tackle my linear-IC RFQs (ouch). Now that I can change my MOS wafer in 36 hr, everyone can now mind his OEM business. It was interesting to read that T<sup>2</sup>L has multiplied to T<sup>3</sup>L and that 21 MPCs will now fit in a sardine can. Some of the new products, such as the static SOS/C-MOS RAM, the PS<sup>2</sup>L, and the DAFL are great, but they are all QED and FOB Detroit. NO MOR Abbrs PLS.

Wayne M. Pope  
Northern Alberta  
Institute of Technology  
Edmonton, Alta., Canada

■ *Abbreviations and acronyms are handy shortcuts for communicating in technical terms, but, admittedly, their over-use can become confusing to someone unfamiliar with the technology to which they refer.*

*However, to minimize confusion when we use less familiar abbreviations and acronyms, we spell out the words from which they are derived the first time they appear in a story. The editors believe that it would make lugubrious reading if such terms as metal-oxide semiconductors were spelled out every time.*

#### On dropping meter readers

**To the Editor:** McGraw-Edison may be dropping the meter reader because of the energy shortage [May 25, p.26], but since AT&T has no tariff structure covering the readers, we doubt that tariff is a factor.

Conrad Pologe  
AT&T  
New York, N. Y.

from General Instrument...

# MOS KEYBOARD ENCODERS

General Instrument is now supplying N-KEY and 2-KEY Keyboard Encoders in production quantities. Each type is a single-chip MOS Read Only Memory containing all the logic necessary to encode single-pole, single-throw keyboard closures into usable codes. And each type is available as a standard pre-programmed device with a modified ASCII code. Quick turnaround is offered for custom patterns. Both encoders are supplied in 40 lead dual-in-line packages.

## **N-KEY (AY-5-3600)**

N-KEY rollover operation, 90 keys, 4 modes, 10 bit output code, with:

- N-KEY lockout
- Output enable
- Pulse or level data ready output signal
- "Any Key Down" output

## **2-KEY (AY-5-2376)**

2-KEY rollover operation, 88 keys, 3 modes, 9 bit output code, with:

- N-KEY lockout
- External control for selection of odd or even parity  
(when parity is programmed as one of the 9 output bits)

### **Both types also feature:**

- Inputs/outputs directly compatible with TTL/DTL or MOS logic arrays
- Self-contained oscillator circuit
- Output data buffer register
- External data complement control
- Externally controlled delay network to eliminate the effect of contact bounce
- Programmable coding with a single mask change
- Static charge protection on all input and output terminals
- Entire circuit protected by glass passivation

For further information call the toll-free number below (In New York State call 516-733-3107) or write.

# 800-645-9247

TOLL  
FREE



GENERAL INSTRUMENT CORPORATION • 600 WEST JOHN STREET, HICKSVILLE, L. I., NEW YORK 11802

# **A Report on the Leading Producers of Schottky/TTL:**

## Starting alphabetically, there's Advanced Micro Devices of Sunnyvale, California.

Advanced Micro Devices currently produces 31 different Schottky/MSI and LSI devices, making its Schottky MSI family the second largest in the world.

Of the total number of Schottky/MSI and LSI devices currently being produced by AMD, twenty-two devices are alternate source versions of the most popular designs now available, while nine devices are designs proprietary to Advanced Micro Devices.

Significantly, all Schottky/MSI and LSI parts currently produced by AMD are available to operate over the full military temperature range.

All AMD Schottky/MSI and LSI devices are built in accordance with MIL-STD-883 and MIL-M-38510.

Immediate delivery is offered on every Schottky/MSI and LSI device presently being produced by Advanced Micro Devices, the next giant.

---

### Schottky/TTL Devices Proprietary to Advanced Micro Devices

#### Am25S05

4-Bit by 2-Bit Two's  
Complement Digital Multiplier

#### Am25S07

6-Bit Register with Clock Enable

#### Am25S08

4-Bit Register with Clock Enable

#### Am25S09

4-Bit Register with 2-Input — Multiplexer on Inputs

#### Am25S10

4-Bit Shifter used for Shifting or Scaling

#### Am26S12

Quad Bus Transceiver

#### Am26S12A

Quad Bus Transceiver

#### Am27S02

64-Bit Random Access Memory with  
Open Collector Outputs

#### Am27S03

64-Bit Random Access Memory with  
Three-State Outputs

---

### Schottky/TTL Devices Alternate Sourced by Advanced Micro Devices

#### 54S/74S139

Dual 1-of-4 Decoder

#### 54S/74S151

8-Input Multiplexer

#### 54S/74S153

Dual 4-Input Multiplexer

#### 54S/74S157

Quad 2-Input Multiplexer;  
Non-Inverting Outputs

#### 54S/74S158

Quad 2-Input Multiplexer;  
Inverting Outputs

#### 54S/74S174

6-Bit Register with Master Reset

#### 54S/74S175

Quad Register with True and Complement Outputs

#### 54S/74S181

4-Bit Arithmetic Logic Unit

#### 54S/74S189

64-Bit Random Access Memory with  
Open Collector Outputs

#### 54S/74S194

4-Bit Shift Register;  
Shift Right, Left, or Load

#### 54S/74S195

4-Bit Shift Register; JK Inputs;  
Shift Right or Load

#### 54S/74S251

Three-State 8-Input Multiplexer

#### 54S/74S253

Three-State Dual 4-Input Multiplexer

#### 54S/74S257

Three-State Quad 2-Input Multiplexer;  
Non-Inverting Outputs

#### 54S/74S258

Three-State Quad 2-Input Multiplexer;  
Inverting Outputs

#### 54S/74S289

64-Bit Random Access Memory with  
Three-State Outputs

#### 82S62

9-Input Parity Checker/Generator

#### 93S10

Synchronous Decade Counter (Edge Triggered)

#### 93S16

Synchronous Hexadecimal Counter (Edge Triggered)

#### 93S21

Dual 1-of-4 Decoder

#### 93S22

Quad 2-Input Multiplexer

#### 93S48

12-Input Parity Checker/Generator

---

**(EDITOR'S NOTE: Unfortunately, time and space do not permit us to go into additional detail on the other major producers of Schottky/MSI and LSI at this time.)**

Not just a second source. But a

# Introducing Harris'

Here they are—22 device types offering true alternate-source availability for 54C/74C CMOS. Combined with our existing 4000 series and custom LSI capability, addition of these new units makes Harris one of the few suppliers with total CMOS capability. So, choose from our 54C/74C series—44 devices with more on the way.

Our 54C/74C series, designed to reduce system costs, is pin-for-pin and function-for-function equivalent to T<sup>2</sup>L 7400 devices. Among their cost-saving features are low power supply requirements, less power supply regulation, fewer bypass capacitors, simpler design, and simplified power

distribution. The units also offer high noise immunity—typically 45% of supply voltage, and they have a guaranteed 1V noise margin. This means that 1V of noise at the input will not cause the output to rise beyond T<sup>2</sup>L levels. As a result, logic errors are less likely.

Applications are easy, too, with industry standardized input and output characteristics. Experience acquired with the 7400 series can also be applied directly to use of the 54C/74C's. For details, see your Harris distributor or representative.

	100-999 UNITS	
	-55°C to +125°C	0°C to +70°C
HD-54C00/74C00 Quad 2 NAND Gate	2.98	.69
HD-54C02/74C02 Quad 2 NOR Gate	2.98	.69
HD-54C04/74C04 Hex Inverter	3.30	1.04
HD-54C10/74C10 Triple 3 NAND Gate	2.98	.69
HD-54C20/74C20 Dual 4 NAND Gate	2.98	.69
HD-54C42/74C42 BCD to Decimal Decoder	7.15	3.30
HD-54C73/74C73 Dual J-K Flip Flop with Clear	4.75	2.26
HD-54C74/74C74 Dual D Flip Flop	4.20	1.45
HD-54C76/74C76 Dual J-K Flip Flop with Clear and Preset	4.75	2.26
HD-54C107/74C107 Dual J-K Flip Flop with Clear	4.75	2.26
HD-54C151/74C151 8 Channel Digital Multiplexer	6.40	3.95
HD-54C154/74C154 4-Line to 16-Line Decoder/Demultiplexer	16.20	5.40
HD-54C157/74C157 Quad 2 Multiplexer	5.10	2.88
HD-54C160/74C160 Decade Counter with Asynchronous Clear	10.40	5.70
HD-54C161/74C161 Binary Counter with Asynchronous Clear	10.40	5.70
HD-54C162/74C162 Decade Counter with Synchronous Clear	10.40	5.70
HD-54C163/74C163 Binary Counter with Synchronous Clear	10.40	5.70
HD-54C164/74C164 8-Bit Parallel Out Serial Shift Register	11.00	4.35
HD-54C173/74C173 Three State Quad/D Flip Flop	9.15	3.80
HD-54C192/74C192 Synchronous 4-Bit Up/Down Decade Counter	10.30	5.65
HD-54C193/74C193 Synchronous 4-Bit Up/Down Binary Counter	10.30	5.65
HD-54C195/74C195 4-Bit Register	5.70	3.75

WHERE TO BUY THEM: ARIZONA: Phoenix—Hamilton, Liberty, Weatherford, Scottsdale—HAR (602) 946-3556 CALIFORNIA: Anaheim—Weatherford; El Segundo—Liberty, Glendale—Weatherford; Long Beach—HAR (213) 426-7687; Mountain View—Elmar; Palo Alto—Weatherford, HAR (415) 964-6443; Pomona—Weatherford; San Diego—Liberty, Weatherford COLORADO: Commerce City—Elmar; Denver—Hamilton, Englewood—Weatherford CONNECTICUT: Danbury—Schweber, Norwalk—Harvey FLORIDA: Hollywood—Hamilton, Schweber; Melbourne—HAR (305) 727-5430 GEORGIA: Atlanta—Schweber, Norcross—Hamilton ILLINOIS: Elk Grove Village—Schweber, Schaumburg—HAR (312) 894-8824; Schiller Park—Hamilton INDIANA: Indianapolis—Pioneer KANSAS: Lenexa—Hamilton MARYLAND: Baltimore—Hamilton; Rockville—Schweber MASSACHUSETTS: Burlington—Hamilton; Lexington—Harvey; Wellesley—HAR (617) 237-5430 MICHIGAN: Livonia—Hamilton; Troy—Schweber MINNESOTA: Edina—Hamilton; Schweber; Minneapolis—HAR (612) 432-6111 MISSOURI: Hazelwood—Hamilton NEW JERSEY: Cedar Grove—Hamilton; Mt. Laurel—Hamilton; Somerset—Schweber NEW MEXICO: Albuquerque—Hamilton; Weatherford NEW YORK: East Syracuse—Hamilton; Melville—HAR (516) 249-4500; Syracuse—HAR (315) 463-3373; Rochester—Schweber; Westbury—Schweber; Woodbury—Harvey NORTH CAROLINA: Raleigh—Schweber OHIO: Beachwood—Schweber; Cleveland—Pioneer; Dayton—Pioneer; HAR (513) 226-0636 PENNSYLVANIA: Wayne—HAR (215) 687-6680 TEXAS: Dallas—Hamilton, Weatherford, HAR (214) 231-9031; Houston—Hamilton; Weatherford UTAH: Salt Lake City—Hamilton WASHINGTON: Seattle—Liberty, Weatherford WASHINGTON, D.C.: HAR (202) 337-3170 CANADA: Mississauga, Ontario—Hamilton; Montreal, Quebec—Hamilton, Ottawa, Ontario—Hamilton.

LEGEND FOR HARRIS SALES OFFICES & DISTRIBUTORS: Elmar Electronics (Elmar); Hamilton Avnet Electronics (Hamilton); Harris Semiconductor (HAR); Harvey Electronics (Harvey); Liberty Electronics (Liberty); Pioneer Standard Electronics (Pioneer); Schweber Electronics (Schweber); R. V. Weatherford Co. (Weatherford).

source with total CMOS capability.

# New 54C/74C Series

Our 4000 (S) series offers you the fastest, low-power logic devices available today. With 10-volt power supplies, speeds are typically twice that of comparable IC's. Power supply range is 3 to 15VDC, while noise immunity is typically 45% of supply voltage. Other advantages are low power dissipation and elimination of SCR latch-up problems. All units are pin-for-pin compatible with the CD-4000A series. And you have a choice of high-speed or direct CD-4000A replacement characteristics. To order a high-speed unit just add the suffix "S" to the HD-4000 part number (HD-4000S). For a direct CD-4000A replacement add an "A" to the number (HD-4000A).

In addition to the HD-4000 series, we offer the HD-4800 group of Harris proprietary devices. Among these devices are six units which together comprise the first family of three-state CMOS interface circuits available. By providing the ability to regulate the state of hard wired outputs, these interface circuits permit an extremely high level of flexibility in buss oriented systems design. These units also have buffered outputs for driving high capacitive lines and T<sup>2</sup>L directly. When four circuits are utilized, they permit the user to perform logic translation (i.e. MOS to T<sup>2</sup>L) directly at the buss line. For complete details on our 4000 and 4800 series, see your Harris distributor or representative.

	100-999 UNITS			
	-40°C to +85°C		-55°C to +125°C	
	A	S	A	S
HD-4000 Dual 3 NOR Gate plus Inverter, 14 pin DIP	.78	1.86	1.17	3.10
HD-4001 Quad 2 NOR Gate, 14 pin DIP	.78	1.98	1.17	3.30
HD-4002 Dual 4 NOR Gate, 14 pin DIP	.78	2.04	1.17	3.40
HD-4007 Dual Complementary Pair plus Inverter, 14 pin DIP	.78	1.59	1.17	2.65
HD-4009 Hex Inverter/Buffer, 16 pin DIP	1.69	3.15	2.54	5.25
HD-4010 Hex Buffer, 16 pin DIP	1.69	3.15	2.54	5.25
HD-4011 Quad 2 NAND Gate, 14 pin DIP	.78	1.98	1.17	3.30
HD-4012 Dual 4 NAND Gate, 14 pin DIP	.78	2.07	1.17	3.45
HD-4013 Dual D Flip Flop, 14 pin DIP	1.62	2.85	2.43	4.75
HD-4019 Quad AND/OR Select Gate, 14 pin DIP	1.91	3.03	2.87	5.05
HD-4023 Triple 3 NAND Gate, 14 pin DIP	.78	2.06	1.17	3.44
HD-4025 Triple 3 NOR Gate, 14 pin DIP	.78	2.06	1.17	3.44
HD-4030 Quad Exclusive OR Gate, 14 pin DIP	1.63	2.27	2.45	3.79
HD-4804 Three State Hex Buffer with Level Translator, 16 pin DIP	—	6.15	—	7.67
HD-4805 Three State Hex Buffer Inverter with Level Translator, 16 pin DIP	—	6.15	—	7.67
HD-4806 Three State Triple True/Complement Buffer with Disable, Independent Level Translator, 16 pin DIP	—	6.15	—	7.67
HD-4807 Hex Buffer with Disable, 16 pin DIP	—	6.15	—	7.67
HD-4808 Three State Hex Buffer with Disable, 16 pin DIP	—	6.15	—	7.67
HD-4809 Triple True/Complement Buffer, 16 pin DIP	1.69	3.15	2.54	5.25
HD-4810 Three State Triple True/Complement Buffer with Disable, Common Level Translator, 14 pin DIP	—	6.15	—	7.67
HD-4811 Quad Exclusive NOR Gate, 16 pin DIP	1.63	2.27	2.45	3.79
HD-4814 Hex Inverter, 16 pin DIP	.97	2.27	1.45	3.80



P.O. Box 883, Melbourne, Florida 32901  
(305) 727-5430

# YOUR DEPENDABLE SOURCE OF SUPPLY

NO DELIVERY  
PROBLEMS On  
RBR'S (Mil R 39005) And  
RWR'S (Mil R 39007)  
From  
**RCL**



RCL—a major source of supply for ESTABLISHED RELIABILITY RESISTORS. RCL has all basic materials in stock... cores, resistance wire, bobbins, leads, etc. . . . . all of which means . . .

## RCL DELIVERS ON TIME!

Call our hotline for prompt service and delivery.

(201) 374-3311

# RCL

**ELECTRONICS, Inc.**

General Sales Office:  
700 So. 21st Street  
Irvington, N. J. 07111

## People

An official 'yes' to Loran-C agrees with John Beukers

When the U.S. Coast Guard decided last month to standardize on the Loran-C navigation system for ships sailing the coastal and inland waterways [*Electronics*, Jan. 18, 1973, p. 139], John M. Beukers breathed a sigh of satisfaction. For as president of Beukers Laboratories, a Bohemia, N.Y., manufacturer of precise navigation and communications equipment, Beukers has long propounded the view that a combination of Loran-C for navigation of coastal-confluence areas and the longer-range Omega system for the high seas would offer "the best signals available for each job."

Beukers is a charter member of the Wild Goose Association of manufacturers and users interested in the possibilities of Loran-C. As one of the association members that presented the case for Loran-C before the House of Representatives Subcommittee on Coast Guard and Navigation in April, he has done much to aid in establishing the status of the Loran-C navigation system.

The pleasant-spoken, English-born electronics engineer does not have an equipment ax to grind. Rather, with respect to navigation, at least, he practices what he preaches, applying the best attributes of both Loran-C and Omega in the equipment he designs.

This is true, for example, in Beukers Laboratories' Lo-Cate system, for tracking such objects as weather balloons, ocean buoys, small boats in distress, and helicopters. One of Beukers' several patents in the hyperbolic navigation-aid field is for a technique that applies Omega signals to the rapid acquisition and cycle identification of Loran-C signals.

In addition to navigation, Beukers has long been interested in meteorology. His compact and low-cost sondes—sensing devices that, when dropped from an aircraft or sent aloft in a balloon, radio back information on atmospheric conditions—are used almost universally by weather-forecasting and research

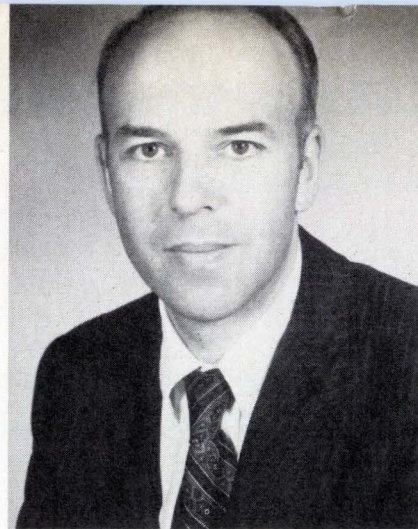

**Navaid.** John Beukers helped promote recently approved Loran-C standard.

groups in the United States. Moreover, Beukers has placed his Lo-Cate system aboard a mobile van, and it is monitoring environmental conditions at land-based sites.

For the future, Beukers sees the possibility of Loran-C becoming available as a means for land-based, as well as offshore, navigation. Once the Coast Guard installs its stations, only three more will be needed to cover the entire United States.

Thus, it may now be feasible to use Loran-C for locating police cars and other emergency vehicles and for its use by aircraft in area navigation. With increased use, price of the Loran-C receiver should also be decreased within four years, says Beukers, to less than \$1,000 for a simpler unit from the \$3,000 to \$5,000 now.

At EA, Boucher hmlps carry management burden

When a company's sales nearly double in a year, and the president can't find enough hours in the day to get the job done, it's time to hire some help. Electronic Arrays Inc. did just that when the Mountain View, Calif., firm brought in Richard Boucher two months ago to serve as assistant president and share the duties that had begun to overburden the MOS LSI manufacturer's president and chief executive officer, Mois Gerson. It was under Gerson's leadership that EA's sales went from \$9,756,000 in fiscal 1973 to \$17,849,000 in fiscal 1974.

To free himself and Gerson from



# Blowbacks. Another good reason for microfilm.

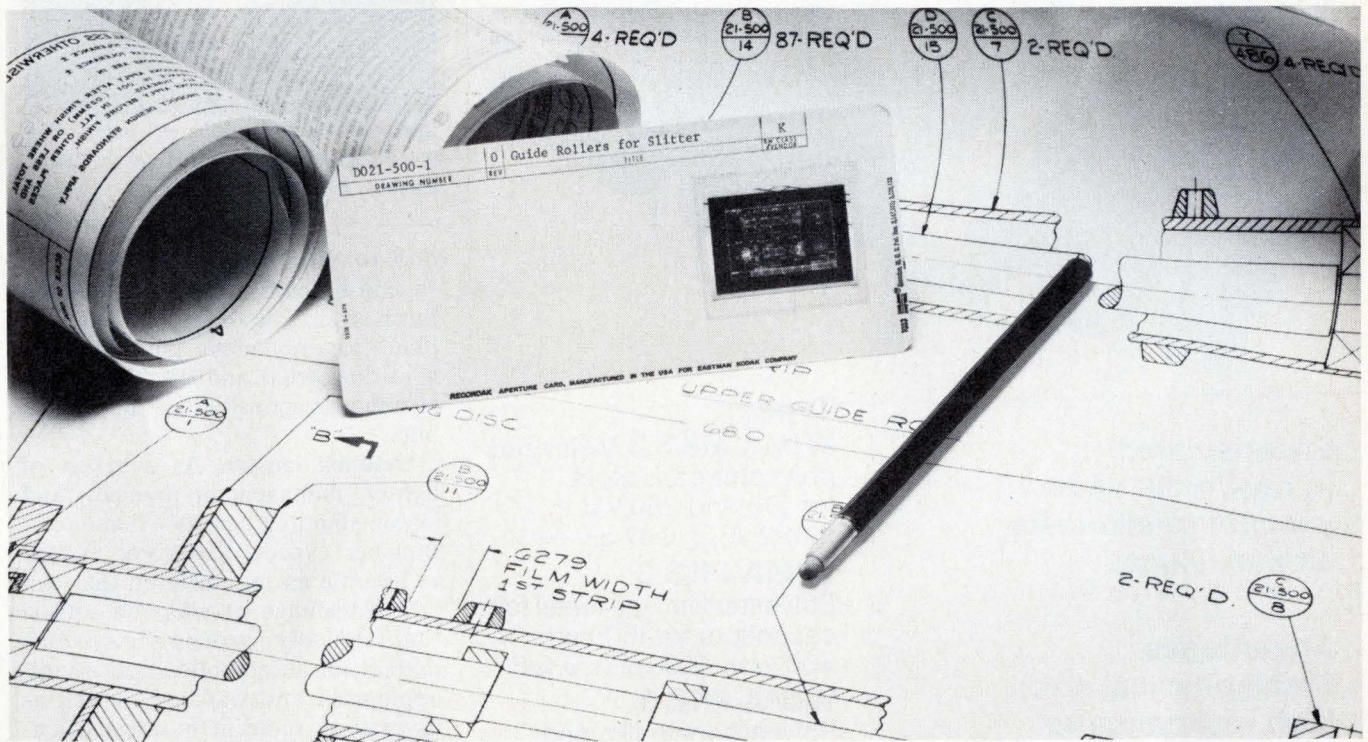

Put the flexibility of Kodak microfilm into your engineering program.

There are many advantages to microfilming your drawings. It saves space, it provides security, and it's one of the most efficient methods of filing and retrieving engineering data. And now, you can make high-quality enlargements directly from the sharp, crisp microfilm images that Kodak products have produced.

Blowing back onto Kodagraph films or papers from microfilm is a fast, easy way to make second originals. And you not only eliminate the need to use original drawings; you also save material because you can

produce the exact size reproductions you require.

You'll find that you save in other ways, too! Whether the job is revising drawings or restoring them, or even making distribution prints, blowbacks from Kodak microfilm can save you time and money.

Get the details.

Find out how Kodak microfilm and drawing reproduction products can benefit your department. Write for our booklet on Engineering Document Control or ask for a sales representative to call. Eastman Kodak Company, Business Systems Markets Division, Dept. DP773, Rochester, N.Y. 14650.

**Kodak products for engineering data systems.**



# Cast moulded WIMA<sup>®</sup> capacitors

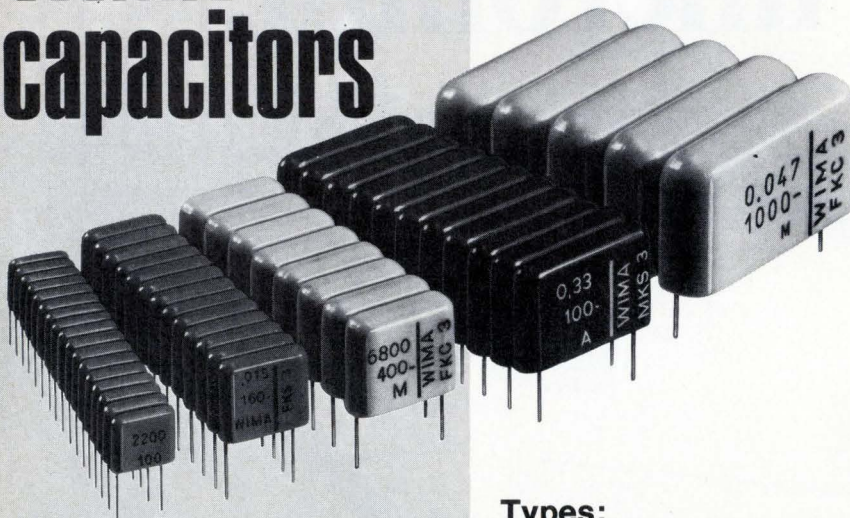

**Encapsulated  
in cast resin under  
vacuum to eliminate  
air inclusions.**

**Advantages:  
Small physical size;  
high resistance to  
moisture, favourable  
a. c. characteristics.  
Voltage ratings  
up to 1000 V d. c.**

**For stringent  
requirements.**

## Types:

**WIMA MKS 3** Metallized polyester capacitors for 100 and 250 V d. c. 0.022  $\mu$ F ... 0.47  $\mu$ F.

**WIMA FKS 3** Polyester film and metal foil capacitors for 160 and 400 V d.c. 1000 pF... 0.1  $\mu$ F.

**WIMA FKS 3** Polycarbonate film and metal foil capacitors suitable for frequency divider circuits. Close tolerances available. 160, 400, 630 and 1000 V d. c. 100 pF ... 0.1  $\mu$ F.

**WIMA FKS 2 min.** Polyester film and metal foil capacitors, subminiature, suitable for very small equipment. 100 V d. c. from 100 pF ... 0.047  $\mu$ F.

## WILHELM WESTERMANN

Spezialfabrik  
für Kondensatoren  
Augusta-Anlage 56  
P.O. Box 2345  
D-68 Mannheim 1  
Fed. Rep. of Germany  
Tel.: (621) 40 8012

*Please send for  
our latest  
catalogue.*



## People

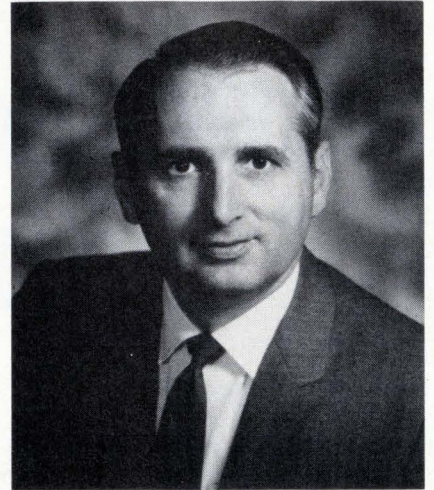

**Systems-oriented.** Boucher helps steer Electronic Arrays to more sales by understanding OEM needs.

day-to-day operations and to "spend time on what really makes a business double or triple," Boucher plans to implement guidelines on who does what and establish management responsibilities down the line.

**Systems impact.** As a result of tighter management policies and "understanding OEMs' demands," Boucher expects Electronic Arrays to become an organization that can take advantage of what he calls a "fantastically growing" systems market for automobile applications, appliances, and watches, as well as its existing stake in business calculators. Expected EA sales growth is set at 45% for next year.

One of the first lessons Boucher wants to get across to his management team is that the semiconductor industry is very systems-oriented. "We can't just be component-oriented," says the former president of CMX Systems Inc., a Mountain View, Calif., firm and the former general manager at Memorex Corp., Santa Clara, Calif. Rather, he warns, "we have to know how a component fits into someone else's system."

To penetrate the systems marketplace, Electronic Arrays plans advances in LSI memories and microprocessors. It is now conducting research into an 8-bit n-channel processor on a chip, for introduction as early next year.

JUNE, 1974



## in this issue

Two new low-cost  
crystal-based counters

New price reductions  
for the HP-35 and HP-45

Information management  
keeps up with technology

## New wave analyzer for precision and portability in the field

Here, the 3581A wave analyzer checks field equipment performance for the Omega navigation system, a global system that should become fully operational in 1975.

HP's new low-frequency analyzer has a built-in counter for frequency accuracy and a battery option for convenience and portability. Take the 18 lb. (8.1 kg) wave analyzer where you need it the most—out in the field—to check power or telephone lines.

Accurate single-frequency measurements are fast and easy, from 15 Hz to 50 kHz with 1 Hz resolution and 3 Hz bandwidth. The built-in counter displays tuned frequency on a 5-digit LED readout. Signal amplitude appears on a four-scale analog meter. Two scales are for log displays of 90 dB and 10 dB (expanded), and the other two are linear with 1 or 3 full scale.

*(continued on page 3)*

## Super-counter for superb time interval measuring and easy system interface



The HP 5345A counter's unmatched capabilities in time interval measurements and automatic systems operation pay off in applications such as the time interval jitter measuring system shown above.

**Precision time interval** measurements are central to measuring rise time, propagation delay, slew rate, and phase. These are just a few applications that can be served better than ever by the time interval capability of HP's new 5345A electronic counter.

Compatibility with the HP interface bus makes the counter a natural for systems applications. For example, the system shown above is easily assembled using an HP 9820A calculator, 9862A plotter, and the 5345A counter to analyze time interval jitter.

The 5345A offers 2 ns single-shot time interval resolution. With an improved averaging technique, resolutions to 2 ps are achieved for repetitive signals. High sensitivity of the 500 MHz input amplifiers (better than 10 mV rms) ensures accurate trigger level settings. And for very fast pulses in 50 $\Omega$  systems, you can switch to 50 $\Omega$  impedance to prevent error-causing reflections.

The 5345A also makes frequency, frequency average, period, period average, ratio, totalize, and gated measurements over the dc to 500 MHz bandwidth. Plug-ins extend the counter's capability for communications and microwave measurements.

*There's more. Just check the HP Reply Card.*

**Calculator control** and HP's new ASCII programmable modules that extend the 5345A's measurement capabilities are explained in a new series of application notes. The series includes: the characterization of voltage controlled oscillators, determining probability density distribution of a series of measurements, frequency stability measurements, and the measurement of fractional frequency deviation and FM deviation. VCO characteristics covered are: the transfer function measurement, differential and integral non-linearity and dual VCO tracking error.

Each application note describes how to connect the necessary equipment, how to operate the resulting calculator-controlled system, and certain key measurement considerations that should be noted. The notes also include a complete listing of the HP 9820/21 calculator program and a flow diagram of the software.

*To learn more, check the HP Reply Card.*

## New quality counters at surprisingly low prices



These new counters have 25 mV sensitivity, LED displays, measure ratio as well as frequency, and weigh just 4.75 lbs. (2.2 kg).

**Two new electronic counters** carry extremely low price tags, yet offer high-stability crystal time bases crucial to counter accuracy and usually found only in costlier models. Either new counter is ideal for production line testing, frequency monitoring, service and calibration, training classes or—at this price—even for hobbyists and radio hams.

The 80-MHz model 5381A has a 7-digit display. Model 5382A counts to 225 MHz and displays 8 digits. Resolution is 10 Hz at 0.1 sec gate time, 1 Hz at 1 sec, and 0.1 Hz in 10 sec.

Aging (drift) rate is <3 parts in 10<sup>7</sup> per month, reducing recalibration. Temperature-resistant and rugged, the two counters also protect against overload. Even in their wide-open settings, they'll take 200 Vdc without harm.

A three-position input attenuator lets you measure noisy or high voltage inputs. Unlike other low-priced counters, these will also operate on an external precision time base through a built-in rear connector.

*For more information, check the HP Reply Card*

## Get 4-channel lab quality recording with portable tape recorder

The 3960A instrumentation tape recorder gives you portability along with performance and features found only in the most expensive laboratory machines. Portability is the ruggedness of the solid aluminum casting, the capability of operating from either ac or dc power sources, and a built-in dc calibrator.

Use the 3960A in data acquisition and data reproduction applications. Tape speeds range from 15/16 ips for long-term FM recording of slowly changing phenomena to 3 3/4 ips for acoustic evaluation and up to 15 ips for vibration studies. The low-speed performance is outstanding, an important asset to medical researchers and others who record slowly changing variables.

The FM signal-to-noise ratio at 15/16 ips is 44 dB. At higher speeds, the FM signal-to-noise ratio is 48 dB. Data electronics for direct recording has a frequency response up to 60 kHz and up to 5 kHz for FM.

For more information, check the HP Reply Card.



The 3960A recorder uses 1/4 in. (0.6 cm) tape or standard 7 in. (17.8 cm) reels.

## HP multiprogrammer system expands your I/O capability to 240 channels

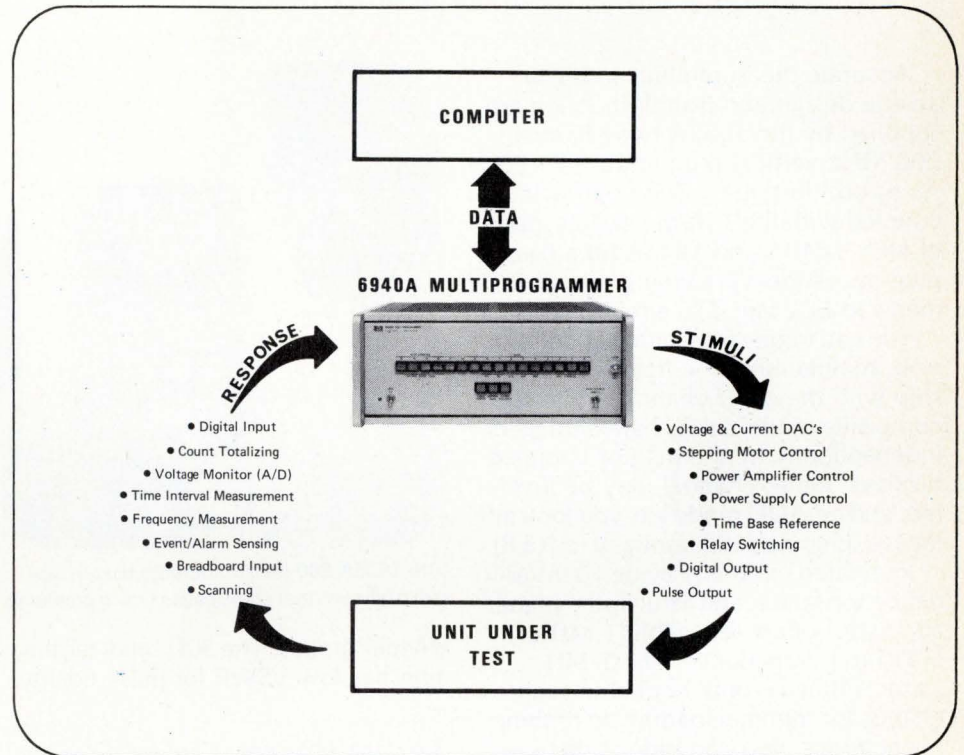

Multiprogrammer mainframes and plug-in cards let you design and build low-cost automatic test systems more efficiently.

You'll never run out of computer I/O slots when you design your automatic test system around the 6940A multiprogrammer. You need just one 16-bit duplex computer I/O channel to interface with the multiprogrammer. The 6940A holds up to 15 plug-in analog and digital I/O cards, mixed in any combination. Some plug-ins convert programmed data into analog and digital output signals to stimulate units under test; others convert analog and digital responses into digital data for input to the computer.

If you need more than 15 programmable I/O channels, simply add 6941A extender mainframes. Each extender

holds 15 plug-ins, and you can add up to 15 extenders—giving you a total of 240 plug-in cards controlled from one computer I/O slot.

Just one software driver controls any variety of multiprogrammer plug-ins. This lets you make changes and additions in the type and number of I/O cards without worrying about reconfiguring the software driver or operating system.

There's more. Just check the HP Reply Card.

(continued from page 1)

It's ideal for harmonic analysis, fm and phase noise measurements of high-frequency signals, evaluating sonar devices, and analyzing low-frequency radio transmission systems. Portability lets you check power line interference simply, accurately, on-site.

A communications version, model 3581C, analyzes telephone voice channels, both single and up to 12 multiplexed. You can also pinpoint interference on data channels, look for spu-

rious tones, and analyze levels of transmitted tones. We even provide a loudspeaker, headphone jack, and transformer so you can patch the 3581C directly onto telephone lines. Optional rechargeable batteries run the analyzer for 12 hours.

To learn more, check the HP Reply Card.

## Scope plug-in aids design and troubleshooting

Accurate measurements in digital/analog design and troubleshooting are supplied by the 1835A two-channel 200 MHz vertical plug-in for HP 183 series oscilloscopes. Wide bandwidth, coupled with the 1 ns/div sweep speed of HP's 1840A and 1841A time base plug-ins, is ideal for timing measurements in ECL and TTL circuits.

You can trigger from either channel A or B, maintaining true time relationship with the other channel. With the composite mode, each channel triggers independently in alternate or chopped displays. Either channel may be inverted, and an ADD mode lets you look at the two channels differentially ( $\pm A \pm B$ ).

Integrated circuits provide 10 mV/div deflection factor, and a thick-film planar attenuator offers selectable 1 M $\Omega$  or 50 $\Omega$  input impedance. The 1 M $\Omega$  (ac/dc) input has only 12 pF shunt capacitance for minimal loading. In probing applications, you can reduce this low capacitance even further by using 10:1

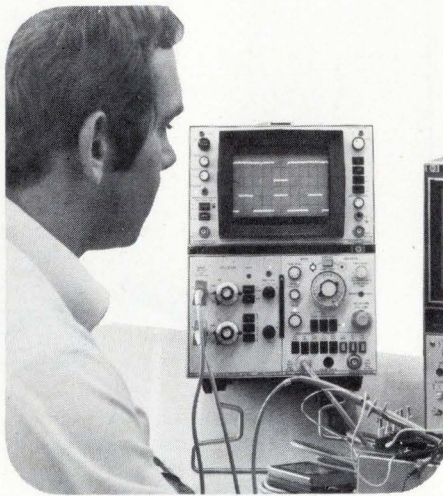

The 1835A 200-MHz bandwidth plug-in displays glitches that could cause timing problems.

divider probes. The 50 $\Omega$  input termination has low VSWR for pulse fidelity.

Send the HP Reply Card for details and specifications.

## Universal card reader inputs 300 cards per minute

HP's 300 cards-per-minute optical mark reader is flexible as well as fast: the 7260A accepts all types of punched

This desktop serial card reader is quiet enough for the office, fast enough to keep up with your computer.

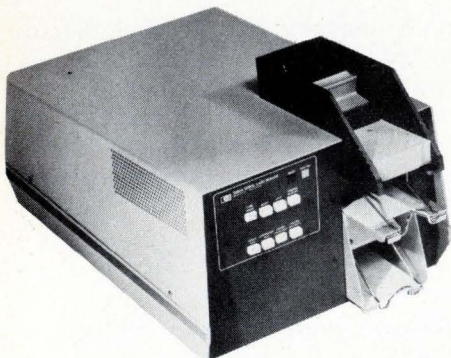

or marked card, even specially designed forms. With appropriate clock marks, single cards may be both punched and marked, in any number of columns from 1 to 80.

The 7260A can be used with terminals, computers or remote data systems via a modem or direct connection. Data rates are switchable from 110 baud to 2400 baud. Data is stored in buffers so that you can optimize the card feed rate for high transmission efficiency. The 7260A transmits 7-level ASCII code, but other decoding options are available.

Quantity and OEM discounts are also available.

For more information, check the HP Reply Card.

## New line printer handles calculator output

Usually line printers are considered computer system peripherals; but now HP offers a reliable line printer for your 9830 calculator system.

The new HP 2607A line printer prints 200 lines per minute, has a full 132 column line width, and 8-level tape control for vertical formatting. The 64 character set is standard USASCII code; characters are styled from a 5 x 7 dot matrix. The line printer is so compact, you can use it on a movable stand or keep it on a desktop or tabletop next to your calculator.

Installation is quick and easy. Simply plug an 11287A interface card into the 9830 calculator, connect the interface cable, and configure the system to your requirements. With the powerful programming capability of the 9830, it's difficult to tell where the calculator system ends and the computer system begins.

To learn more, check the HP Reply Card.



This new line printer substantially increases the through-put of the 9800 series calculators.

## New multiplexer options for HP 9600 systems

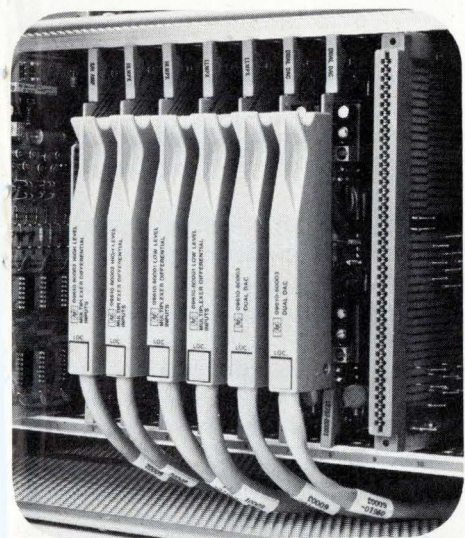

Each multiplexer input circuit provides high common mode rejection from transients and noise. Drift is eliminated by an offset sampling amplifier which further improves accuracy.

Two new multiplexer options for HP 9600 series computerized measurement and control systems let you input analog signals as low as 10 mV.

The 12760 is a relay low-level multiplexer while the 12761A is a solid-state model. Either one switches low-level analog inputs to an HP 2313B A/D interface subsystem. To install the multiplexer, simply slip a printed circuit card into the subsystem.

Both multiplexers accept 16 differential analog inputs and have programmable gains. The solid-state model provides 8 low-level ranges from  $\pm 10\text{V}$  to  $\pm 800\text{V}$  full scale. Sampling rate is up to 50 Hz. The relay multiplexer provides 7 low-level ranges from  $\pm 10\text{mV}$  to  $\pm 400\text{V}$  full scale and offers protection against high common mode voltage and rejection. Sampling rate is up to 20 Hz.

Send the HP Reply Card for details and specifications.

## New low-cost microwave step-attenuators

Automated manufacturing and testing procedures enable HP to offer precision coaxial step-attenuators with outstanding performance at attractive prices. There are two attenuation ranges, 0-70 dB and 0-110 dB in 10 dB steps. The units can be specified for either dc-18 GHz or dc-4 GHz frequency coverage. The HP 8495/8496 attenuators contain thin-film (tantalum or sapphire substrate) attenuation elements that are switched in or out with extremely high repeatability (typically within 0.02 dB), even after thousands of switching cycles.

Both units have high accuracy (typically 1.6% to 4 GHz, 4% to 18 GHz) and low VSWR (1.35 at 4 GHz, 1.7 at 18 GHz). Bench models have three connector types available: type N, SMA and APC-7. Step-attenuator versions for installation within equipment are also offered.

*There's more. Just check the HP Reply Card.*

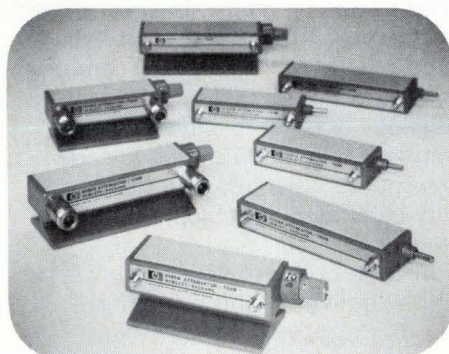

Compact size makes these precision attenuators ideal for bench use or installed in equipment.

## Expedited entry keyboard speeds calculations



The new expedited entry keyboard for the HP-81 business calculator makes problem-solving even faster.

Thanks to a new optional expedited entry keyboard, the HP-81 business desktop calculator solves problems as fast as you can use it. The calculator stores up to 64 keystrokes while simultaneously performing your previous calculations. You can start a new problem while the calculation is solving another.

This preprogrammed business machine solves problems of investment analysis, loans, bonds, annuities, depreciation and statistics. Simply key in your figures, and the calculator prints the answer. There's no programming involved—if you can use an adding machine, you can operate the HP-81.

Besides the built-in financial functions, the HP-81 can compute mean and standard deviation, correlation coefficient, and a two-variable trend line. If you make an error, such as dividing by zero, an error message tells you why the operation cannot be performed.

All this computational power comes in a small 13.5 lb (6.12 kg) machine that fits easily on a corner of your desk.

For more information, check the HP Reply Card.

## Digital triggering pinpoints analog problems

A handy new measurement technique: capture the analyzer's trigger signal on a scope display and use both to find the cause of trouble.

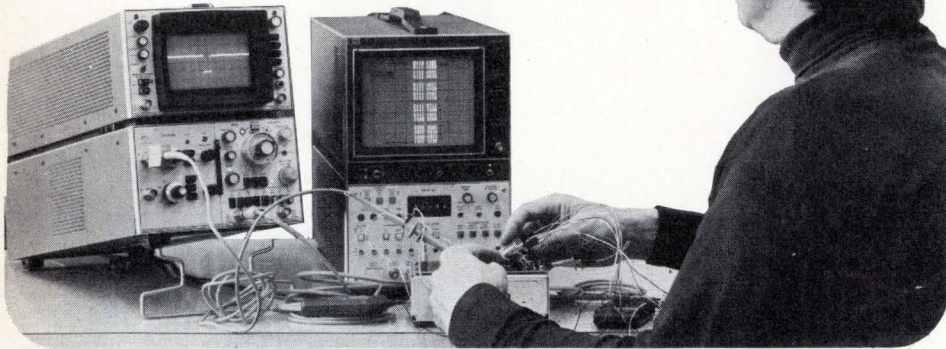

Twelve-bit parallel pattern recognition capability enables the 1601L logic state analyzer to trigger on a particular logic pattern. The unique trigger signal, available as a front panel output, is an extremely powerful tool in digital circuit analysis. By applying this trigger signal to an oscilloscope, the scope's display is positioned in the same "time window" as the digital event.

Let's look at a practical application of digital triggering. Functional checks of a two-decade BCD counter reveal that it is resetting to zero at state 89 rather

than 99. A problem on the reset line is the probable cause. However, when the oscilloscope is connected to the master reset line, several pulses that could cause the problem are displayed. The one that's causing the premature reset is not readily apparent. By connecting the analyzer trigger output to the scope's external input and setting the analyzer trigger switches to state 89, the glitch is readily apparent.

*Send the HP Reply Card for details and specifications.*

## HP solid-state sweepers deliver high power output



High power output across all bands—a value feature of HP's 8620 solid-state plug-in sweeper.

The 8620 series solid-state sweepers cover 3 MHz to 18 GHz with high power output that makes these solid-state

sweep oscillators comparable to BWO-type sweepers. Standard units deliver at least 40 mW to 4.2 GHz and  $\geq 10$  mW all the way to 18 GHz.

Modular design gives you unparalleled flexibility. Start with either of two mainframes, then choose from 9 single-band plug-ins or RF module combinations to get multi-band coverage conveniently and compactly. Standard features include 1% sweep linearity, low spurious signals, high stability, fully-calibrated Start/Stop, and  $\Delta F$  sweeps.

In 6 weeks or less, your 8620 sweeper will be delivered and operating.

*Send the HP Reply Card for details and specifications.*

## New low prices for HP-45, HP-35 pocket calculators

In these days of rising inflation, powerful computation capability in the palm of your hand now costs less. Prices for the HP-45 and HP-35 have been reduced.

The HP-45 has a 4-register stack, 9 addressable memory registers, and more than 44 sophisticated functions. You can perform register arithmetic, polar/rectangular coordinate conversions, metric/U.S. conversions, logarithms, and trigonometric functions in 3 different input modes—degrees, radians and grads.

The HP-35—with 4-register stack and an addressable memory register—handles logarithms, exponents and trigonometric functions within seconds.

Each calculator comes with a carrying case, an ac adapter/recharger, and an owner's handbook.

*For more information, check the HP Reply Card.*



New lower prices for the HP-45 and HP-35 are really something to smile about.



# HEWLETT-PACKARD COMPONENT NEWS

## Introducing three new isolators

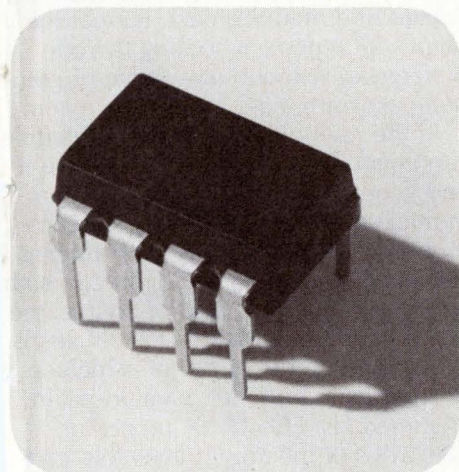

For maximum dc/ac isolation between each input and output, use HP's new 5082-4364 dual isolator.

HP now offers the 5082-4370 series isolators containing a high gain, high speed photodetector that provides a minimum current transfer ratio (CTR) of 300% at input currents of 1.6 mA for the 5082-4370 and 400% at 0.5 mA for the 5082-4371. The excellent low input current CTR lets you use these devices in applications that require low power consumption. Separate pin connections for the photodiode and output transistor permit high speed operation and TTL-compatible output.

Also available is a dual version of our popular high-speed optically-coupled isolator. The new 5082-4364 consists of a pair of optically-coupled gates in an 8-pin dual-in-line package. It's completely TTL compatible and has propagation delays of 50 ns. The high speed of this device makes it ideal for use as a line receiver in high noise environments.

There's more. Just check the HP Reply Card.

## Optoelectronics at a glance

HP's new short-form *Optoelectronics Catalog* describes our complete line of lamps, displays, and isolators—in just 6 pages. This concise guide contains the three latest additions to the HP optoelectronics line: the 5082-7740 common cathode LED display, the 5082-4487 low-cost LED lamp, and the 5082-7430 low-power numeric display.

For your free copy, check the HP Reply Card.

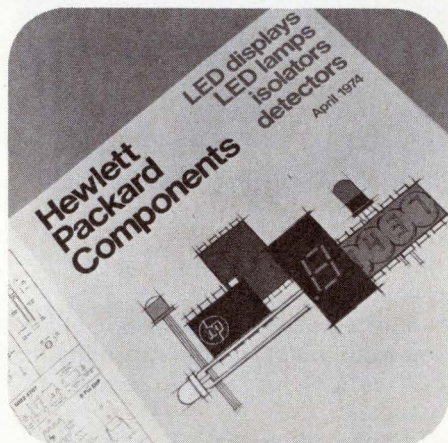

## New diode and transistor catalog now available

Which diode or transistor meets your design specs? Simply refer to HP's new *Diode and Transistor Catalog*, a comprehensive reference containing complete specifications on:

- Microwave transistors
- Schottky diodes
- PIN diodes
- Impatt diodes
- Step recovery diodes
- High reliability devices

The catalog includes packaging specifications and drawings to aid the circuit designer.

For your free copy, check the HP Reply Card.

## New large-digit LED display

LEDs are growing—in size as well as popularity. Now, HP offers a seven-segment display with large .43 in. (1.1 cm) high numbers. The 5082-7750 series devices are common anode LED displays with a choice of right or left hand decimal point.

You can read these bright displays from up to 20 feet away. Distance viewing is also enhanced by the high contrast ratio and wide viewing angle. IC compatibility makes the 5082-7750 series ideal for electronic instrumentation, point of sale terminals, TVs, radios, and digital clocks.

Send the HP Reply Card for details and specifications.

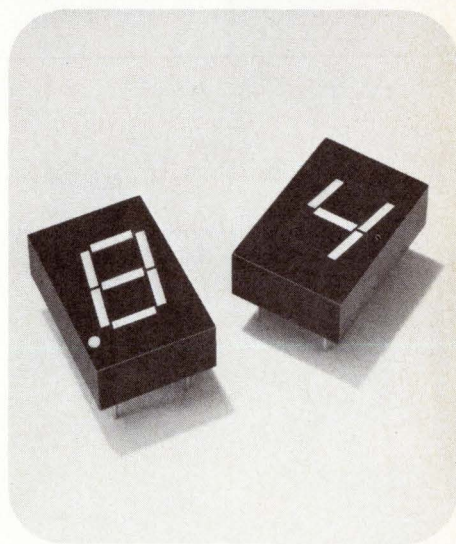

Standard 0.3 in. (0.66 cm) dual-in-line package permits easy mounting on PC boards or in standard IC sockets.

# New scientific minicomputer system performs maxi-computer information management tasks

Compact, streamlined, and capable:  
HP's new S/250 scientific  
information management system.



If you are in charge of an engineering laboratory or research project, your data management procedures may be inadequate for the rapid accumulation of information. You need to store growing data files yet access them quickly. Not only do your variables change, but the data sets interact dynamically. Timely reporting gets difficult. Outside services may be unreliable and costly.

Then there's the security problem—preventing unauthorized personnel from accessing sensitive data. Until now, you could find the capability that you need only in large, expensive computers.

The new HP S/250 scientific data management system solves all these problems. This compact system combines a proven minicomputer with a

versatile disc operating system and powerful data base management software. You can use it in a dedicated environment or in multiple modes. You can write application programs in FORTRAN, ALGOL and assembly language. The built-in data manipulation software (IMAGE/2000) reads, updates, deletes and modifies data. Format the output for reports according to your preference, without knowledge of computer programming.

In the multiple user mode, 32 people can concurrently enter data, retrieve it and generate reports. In the data communications mode, a special telecommunications software package enables the S/250 to communicate directly with an IBM 360 or 370. And of course, the S/250 interfaces with other HP systems.

Standard hardware features include floating point arithmetic, micro-programmed fast FORTRAN processor, 48K bytes of memory, removable cartridge disc that stores 4.8 million bytes (alternately expandable to 93 million bytes), keyboard display console, 200 lpm line printer, 1600 bpi magnetic tape drive, and microprogramming capability. Like all HP computer systems, the S/250 is supported worldwide

*To learn more, check the HP Reply Card.*

HEWLETT  PACKARD

East-20010 Century Blvd., Germantown,  
MD 20767, Ph. (301) 428-0700.

South-P.O. Box 2834, Atlanta, Ga. 30328,  
Ph. (404) 436-6181.

Midwest-5500 Howard Street, Skokie, Ill. 60076,  
Ph. (312) 677-0400.

West-3939 Lankershim Boulevard, North  
Hollywood, Calif. 91604, Ph. (213) 877-1282.

Europe-Post Office Box 85, CH-1217 Meyrin 2,  
Geneva, Switzerland, Ph. (022) 41 54 00.

Canada-6877 Goreway Drive, Mississauga,  
Toronto, L4V 1L9, Ph. (416) 678-9430.

Japan-Yokogawa-Hewlett-Packard, 1-59-1,  
Yoyogi, Shibuya-ku, Tokyo, 151.

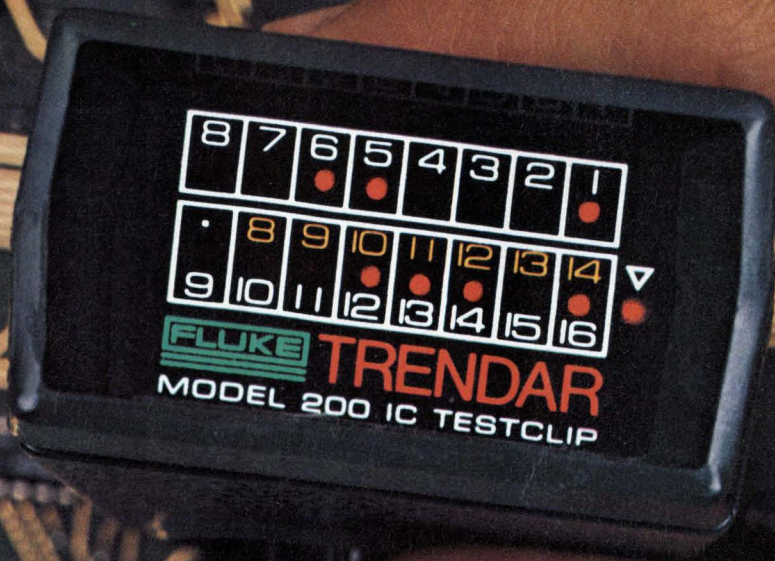

# Fastest IC Troubleshooter- \$395



"Twice as fast," says a famous three-letter computer company\*. When 23 of their service managers tried TESTCLIP™, troubleshooting speed *more than doubled* . . . because only TESTCLIP packs so much diagnostic ability in a pocket-size package.

Think of it as a 16-channel logic probe . . . plus a multi-MHz truth-table tester which automatically finds and *displays* faults. Plug in a reference IC and TESTCLIP does the rest. It finds stuck pins . . . or solder slivers . . . or glitching gates . . . or counters missing beats. And it nails those infuriating loop faults that frustrate the most experienced technicians.

TESTCLIP has become indispensable to production and service people worldwide. Your Fluke representative has it in stock — ask him for a free trial.

**FLUKE TRENDAR**  
a subsidiary of John Fluke Mfg. Co., Inc.

500 Clyde Avenue, Mountain View, California 94043, 415/965-0350  
TWX 910-379-6573

Europe, Fluke (Nederland) B.V., P.O. Box 5053, Tilburg, Netherlands  
Tel. 013-673973. Telex 52273

U.K., Fluke International Corp. Garnett Close, Watford, WD2 4TT,  
Tel. Watford (0923) 33066, Telex 934583

\*Name on request

Available on GSA

Circle 27 on reader service card

# AMPEREX DOT MATRIX PRINTERS

*Fast, Quiet, Versatile, Low Cost -  
And they're a breeze  
to integrate into your system!*

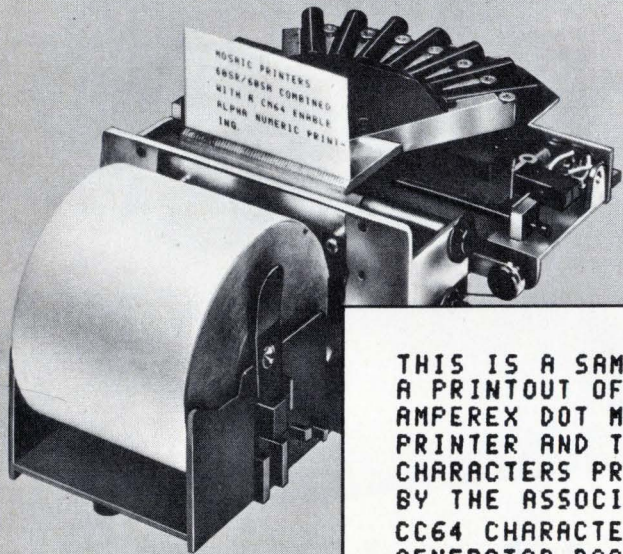

MODEL 60SA

THIS IS A SAMPLE OF  
A PRINTOUT OF THE  
AMPEREX DOT MATRIX  
PRINTER AND THE  
CHARACTERS PRODUCED  
BY THE ASSOCIATED  
CC64 CHARACTER  
GENERATOR BOARD.  
ABCDEFGHIJKLMNQRST  
UVWXYZ < . / ; - : ! " #  
\$ % & ' ( ) \* = ? +  
1234567890

If you're designing equipment that must print hard copy, Amperex has the Printer for your system.

With an Amperex Printer and the available Amperex Electronics you have all the tools you need to produce at low cost—and on very short notice—high quality medium-speed printout.

Amperex Printers, Models 60SR and 60SA, offer full dot matrix character flexibility and print up to three copies of 20 characters per line data on 2¼ inch paper. Intermittent operation of the (no-clutch) motors guarantees long life, quiet operation and reliability for such applications as POINT OF SALE TERMINALS, PROCESS CONTROL MONITORS, MEDICAL DATA SYSTEMS AND DIGITAL METERS.

## OUTSTANDING FEATURES

### THE PRINTERS

- LOW POWER CONSUMPTION:  
(no standby power; no clutches)  
Motors: 8.5 watts; Head: 40 watts
- LONG LIFE:  
10 million lines (frame)
- MEDIUM SPEED:  
1 20-character line per second
- LIGHT WEIGHT:  
only 4.4 pounds
- LOW COST (100 Quantity)  
Model 60SR (with ribbon): \$185.  
Model 60SA (without ribbon): \$170.

### THE ELECTRONICS

- FULL 64 CHARACTER, ASCII FORMAT
- DTL/TTL COMPATIBLE INPUT
- LOW POWER CONSUMPTION:  
less than 1 watt
- EASILY INTEGRATED  
INTO YOUR SYSTEM
- HEAD SOLENOID DRIVER
- LOW COST (100 Quantity)  
Model CM64:  
Complete Electronic  
Control Package: \$135.

For complete data and information on available applications assistance, write: Amperex Electronic Corporation, Hicksville Division, Hicksville, New York 11802.

# Amperex®

TOMORROW'S THINKING IN TODAY'S PRODUCTS

Sold through  
North American Philips Electronic Component Corporation

## 40 years ago

From the pages of Electronics, June 1934

### Television nears reality

Describing television as being no longer around any corner, but as at the end of a long street, much of which remains to be traversed, engineers of the RCA Victor company disclosed their efforts toward developing a new system of communication to the members of the Institute of Radio Engineers at their 9th annual convention just closed. Major advances in the art were stated to be the ability to pick up and transmit outdoor scenes through the medium of a cathode ray television camera, the accomplishment of much greater detail than has been possible heretofore, and the solution of near perfect synchronization between the transmitter and receiver for both the video and the audio sidebands of the million-cycle wide carrier.

Each of the engineers who had a major share in the development of some particular phase of the research described the status of his work to date. These engineers were E.W. Engstrom, R.D. Kell, A.V. Bedford, M.A. Trainer, C.J. Young, R.S. Holmes, W.L. Carlson, and W.A. Tolson.

Prior to the reading of the technical papers describing the year's work leading to the experimental television system in operation at Camden, New Jersey, W.R.G. Baker, vice president and general manager of the RCA Victor company, spoke of the tremendous cost of establishing a national television system.

One gathered the major problem at the present time was cost, and after hearing the technical papers engineers in attendance at the convention felt that if the cost problem could be solved a saleable television system was ready.

Thus was laid to rest the old bogey of the necessity for some fundamental invention that would enable television to take place without the necessity of taking the picture apart with piece-meal transmission; perhaps this fundamental invention in the iconoscope of Dr. Zworykin has already been made.

# Single-Shot Storage to 100 MHz

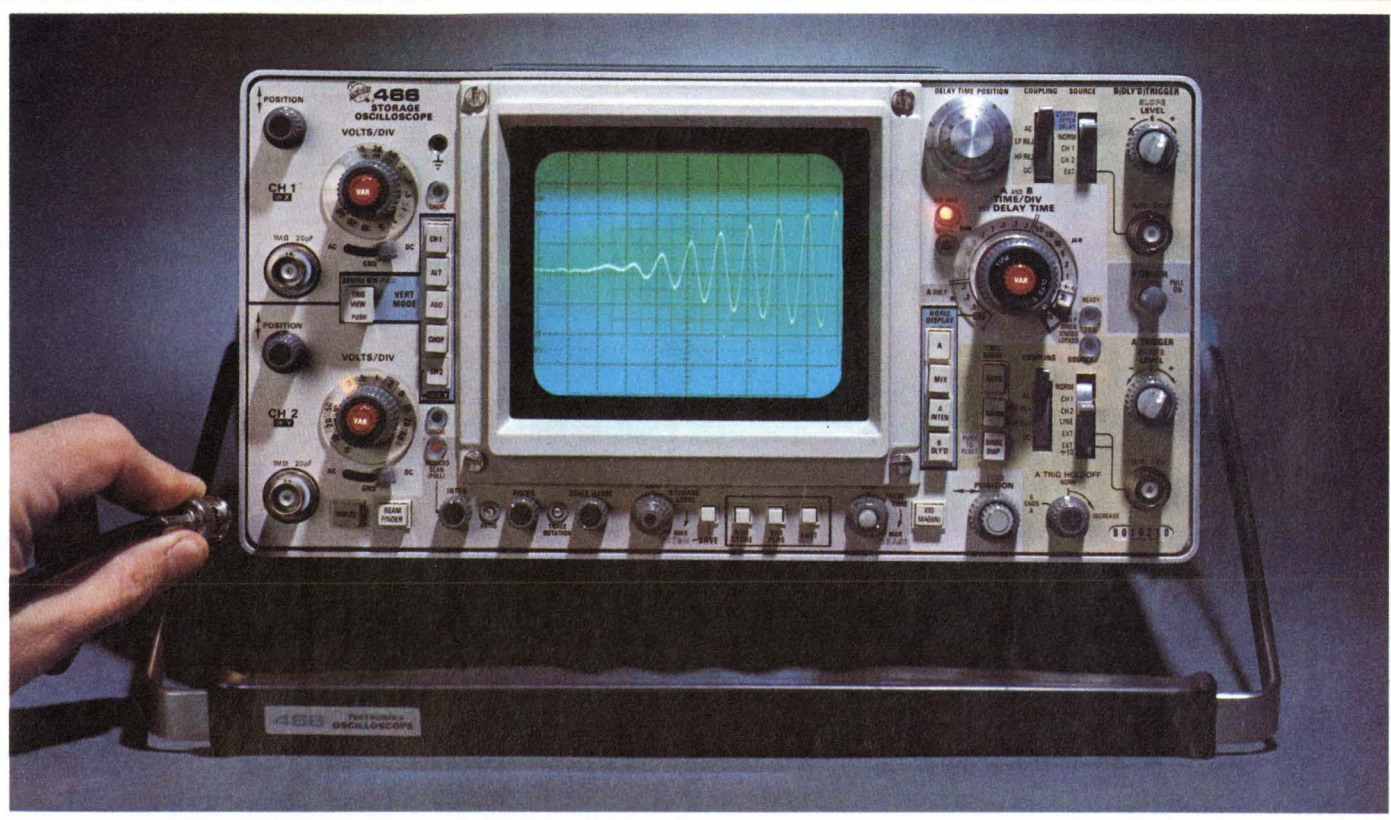

## for DESIGN

The 466 Portable offers the fastest stored writing rate of any Tektronix direct-view oscilloscope—1350 cm/ $\mu$ sec throughout its 100 MHz bandwidth. (5 divisions magnitude for single shot 100 MHz sine wave.) It provides up to a 5 nsec/division sweep rate through the X10 magnifier and vertical deflection sensitivity to 5 mV/division. You can view and retain fast rise, low repetition rate, single shot, or slow moving waveforms. Here are Tektronix's reliable trigger characteristics and CRT's that minimize residual image and burn problems. Now you can display phenomena that could never before be viewed with ease on an oscilloscope.

## for PRODUCTION

The 466's fast stored writing rate offers the production engineer unequalled capabilities. Stored waveforms are brighter—more visible in the high ambient light of assembly areas. Stored waveforms allow personnel to make faster, more accurate decisions and they permit study, comparison to a photo standard, and review by supervisors. Here is an oscilloscope that is essential in computer, aerospace, and many areas of communications. It is designed for minimum training of personnel. And on a dollar per MHz of bandwidth comparison, it is by far your best storage scope buy.

## for FIELD SERVICE

The 466 is the answer to field troubleshooting and calibrations that require the same exacting standards as those originally specified in the lab, production, or engineering. Weighing under 30 lbs., it carries easily. And the 13-position handle provides a versatile support stand. Take an instrument with Option 7 to a missile site or into an aircraft and power it with 12-24 VDC or the 1106 or 1105 battery pack. Its 1350 cm/ $\mu$ sec stored writing rate can make the Tektronix 466 your most valuable test instrument.

If the high writing speed of the 466 is not required, the 464 (which is otherwise identical) features 110 div./ $\mu$ sec. 466 Oscilloscope, \$3850. 464 Oscilloscope, \$3300.

Discover what the 466 can mean to you. For a demonstration or more information, contact your local Tektronix Field Engineer, or write Tektronix, Inc., P.O. Box 500, Beaverton, Oregon 97005. In Europe write Tektronix Ltd., Guernsey, C.I., U.K.



A new concept:



# The ANALOG COUNTER

**Smaller  
cheaper  
faster  
lighter  
and  
tougher  
than  
the digital counter**

Curtis coulometer technology opens new possibilities in timing and counting. Compared to motor driven, gear-limited counters, Curtis Analog Counters are much smaller, considerably cheaper, respond in microseconds, weigh less, never jam or lose count.

These characteristics have opened up whole new fields of application where counters were considered impractical before. May we tell you more?

Write or call us, we'll send you our literature.



# CURTIS

**CURTIS INSTRUMENTS, INC.**  
200 Kisco Avenue, Mt. Kisco, N.Y. 10549  
Tel. (914) 666-2971 • TWX 710-571-2163  
U.K.: Newcastle Upon Tyne, NE1 6AE

## Meetings

**The Intelligent Factory**, Quantum Science Corp., O'Hare Airport Inn, Chicago, June 21.

**1974 Government Microcircuit Applications Conference**, DOD, NASA, AEC, U. of Colo., Boulder, (clearance required), June 25-27.

**Precision Electromagnetic Measurements Conference**, Royal Society, IEE, London, July 1-5.

**Electromagnetic Compatibility Symposium**, IEEE, Hilton Hotel, San Francisco, July 16-18.

**Electromagnetic Compatibility Symposium**, IEEE, San Francisco Hilton Hotel, San Francisco, July 16-18.

**Circuit Theory and Design Conference**, IEEE, IEE, London, England, July 23-26.

**Summer Computer Simulation Conference**, IEEE, Shamrock Hilton Hotel, Houston, Texas, July 24-26.

**The Second Jerusalem Conference on Information Technology**, The Jerusalem Economic Conference and its Computer Committee, Jerusalem, Israel, July 29-Aug. 1.

**Computer Communications International Conference**, IEEE, Stockholm, Sweden, Aug. 12-14.

**National Electronics Conference of New Zealand (Nelcon)**, New Zealand Section, IEEE, University of Auckland, Auckland, Aug. 26-30.

**Compcon Fall**, IEEE, Mayflower Hotel, Washington, D. C., Sept. 10-12.

**Western Electronic Show and Convention (Wescon)**, IEEE, Los Angeles, Sept. 10-13.

**Fourth European Microwave Conference**, Microwave Exhibitions and Publishers Ltd., Maison des Congres, Montreux, Switzerland, Sept. 10-13.

**European Solid State Devices Res. Conference**, Inst. of Phys., IEEE, Univ. of Nottingham, England, Sept. 16-19.



Your closest SIGNETICS distributor is...

- ARIZONA**  
Phoenix: Hamilton/Avnet Electronics (602) 275-7851  
Phoenix: Kierulff Electronics (602) 273-7331
- CALIFORNIA**  
Culver City: Hamilton Electro Sales (213) 870-7171  
El Segundo: Liberty Electronics (213) 322-8100  
Los Angeles: Kierulff Electronics (213) 685-5511  
Mountain View: Hamilton/Avnet Electronics (415) 961-7000  
Palo Alto: Kierulff Electronics (415) 968-6292  
San Diego: Cramer Electronics (714) 565-1881  
San Diego: Hamilton/Avnet Electronics (714) 279-2421  
San Diego: Kierulff Electronics (714) 278-2112  
Sunnyvale: Cramer Electronics (408) 739-3011
- CANADA**  
Downsview: Cesco Electronics (416) 661-0220  
Downsview: Cramer Electronics (416) 661-9222  
Montreal: Cesco Electronics (514) 735-5511  
Montreal: Hamilton/Avnet Electronics (514) 735-6393  
Ottawa: Cesco Electronics (613) 729-5118  
Ottawa: Hamilton/Avnet Electronics (613) 725-3071  
Quebec City: Cesco Electronics (418) 524-3518  
Vancouver: Bowtek Electric Co. Ltd. (604) 736-7677
- COLORADO**  
Denver: Cramer Electronics (303) 758-2100  
Denver: Hamilton/Avnet Electronics (303) 534-1212
- CONNECTICUT**  
Hamden: Arrow Electronics (203) 248-3801  
Georgetown: Hamilton/Avnet Electronics (203) 762-0361  
North Haven: Cramer Electronics (203) 239-5641
- FLORIDA**  
Hollywood: Hamilton/Avnet Electronics (305) 925-5401  
Hollywood: Schweber Electronics (305) 927-0511  
Orlando: Hammond Electronics (305) 241-6601
- GEORGIA**  
Atlanta: Schweber Electronics (404) 449-9170  
Norcross: Hamilton/Avnet Electronics (404) 448-0800
- ILLINOIS**  
Elk Grove: Schweber Electronics (312) 593-2740  
Elmhurst: Semiconductor Specialists (312) 279-1000  
Schiller Park: Hamilton/Avnet Electronics (312) 678-6310
- INDIANA**  
Indianapolis: Semiconductor Specialists (317) 243-8271
- KANSAS**  
Lenexa: Hamilton/Avnet Electronics (913) 888-8900  
Lenexa: Hall-Mark Electronics (913) 888-4747
- MARYLAND**  
Hanover: Hamilton/Avnet Electronics (301) 796-5000  
Rockville: Pioneer Washington Electronics (301) 424-3300  
Rockville: Schweber Electronics (301) 881-2970
- MASSACHUSETTS**  
Burlington: Hamilton/Avnet Electronics (617) 273-2120  
Newton: Cramer Electronics (617) 969-7700  
Waltham: Schweber Electronics (617) 890-8484
- MICHIGAN**  
Detroit: Semiconductor Specialists, Inc. (313) 255-0300  
Livonia: Hamilton/Avnet Electronics (313) 522-4700  
Troy: Schweber Electronics (313) 583-9242
- MINNESOTA**  
Edina: Hamilton/Avnet Electronics (612) 941-3801  
Minneapolis: Semiconductor Specialists (612) 854-8844
- MISSOURI**  
Hazelwood: Hamilton/Avnet Electronics (314) 731-1144  
St. Louis: Hall-Mark Electronics (314) 521-3800
- NEW MEXICO**  
Albuquerque: Cramer Electronics (505) 265-5767  
Albuquerque: Hamilton/Avnet Electronics (505) 765-1500
- NEW YORK**  
Buffalo: Summit Distributors (716) 884-3450  
Farmingdale, L.I.: Arrow Electronics (516) 694-6800  
Rochester: Schweber Electronics (716) 328-4180  
Syracuse: Hamilton/Avnet Electronics (315) 437-2642  
Westbury: Hamilton/Avnet Electronics (516) 333-5800  
Westbury: Schweber Electronics (516) 334-7474
- NORTHERN NEW JERSEY**  
Cedar Grove: Hamilton/Avnet Electronics (201) 239-0800  
Saddlebrook: Arrow Electronics (201) 797-5800
- SOUTHERN NEW JERSEY AND PENNSYLVANIA**  
Cherry Hill, N.J.: Milgray-Delaware Valley (609) 424-1300  
Moorestown: Arrow/Angus Electronics (609) 235-1900  
Mt. Laurel, N.J.: Hamilton/Avnet Electronics (609) 234-2133
- CENTRAL NEW JERSEY AND PENNSYLVANIA**  
Somerset, N.J.: Schweber Electronics (201) 469-6008
- NORTH CAROLINA**  
Greensboro: Hammond Electronics (919) 275-6391
- OHIO**  
Beechwood: Schweber Electronics (216) 464-2970  
Dayton: Hamilton/Avnet Electronics (513) 433-0610  
Cleveland: Arrow Electronics (216) 464-2000  
Cleveland: Pioneer Standard Electronics (216) 587-3600  
Kettering: Arrow Electronics (513) 253-9176
- TEXAS**  
Dallas: Cramer Electronics (214) 350-1355  
Dallas: Hamilton/Avnet Electronics (214) 661-8661  
Houston: Component Specialties (713) 771-7237  
Houston: Hamilton/Avnet Electronics (713) 526-4661
- UTAH**  
Salt Lake City: Alta Electronics (801) 486-7227  
Salt Lake City: Hamilton/Avnet Electronics (801) 262-8451
- WASHINGTON**  
Bellevue: Hamilton/Avnet Electronics (206) 746-8750  
Seattle: Cramer Electronics (206) 762-5722

# Open up your options in Linear ICs.

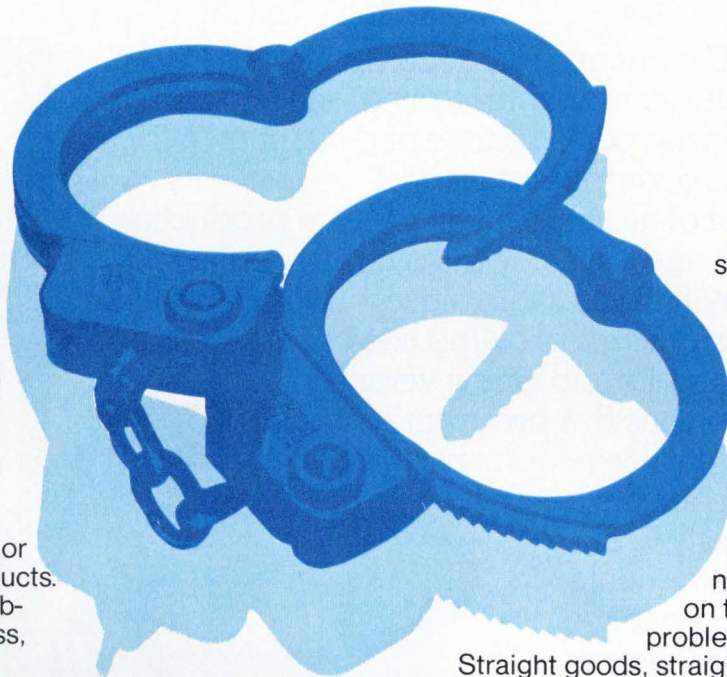

What you need, to free up your buying power, is a good strong alternative to single-source linear supplies. Because nothing breaks you out of most price/delivery binds, like that simple basic: freedom of choice.

The key to Buyers' Lib is Signetics. With a major commitment in linear products. For years we've been established in the linear business, in a big, broad-line way.

Volume we've got—our production capacity's doubled in the past year. And variety that just won't stop. A solid line of standard devices to back up a wide range of purchasing requirements. To help you cut delays, wipe out stoppages, and get your system delivered (and paid for) sooner.

But maybe the biggest spread between Signetics and other so-called linear sources is—

service. First, a nationwide network of linear-wise distributors—every region with at least one office within easy call. Second, the industry's most thorough cataloging and applications material. Plus on-the-spot assistance from our traveling platoon of technical specialists—always on the road, for on-site problem solving.

Straight goods, straight talk. And that means anytime we get a sudden run, putting a specific device in short supply, you'll get realistic commitments. Probably the most important option you can pick up from any supplier, when you lift the phone to source linear from Signetics.

Signetics Corporation, a subsidiary of Corning Glass Works, 811 E. Arques Ave., Sunnyvale, California 94086, (408) 739-7700.

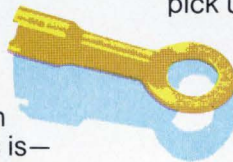

## Available through your local distributor. Now.

<b>Comparators</b>	7520	75451	<b>Op Amps</b>	MC1556	<b>PLL's</b>
$\mu$ A710	7521	75452	$\mu$ A709	NE510	NE560
$\mu$ A711	7522	75453	$\mu$ A740	NE511	NE561
NE526	7523	75454	$\mu$ A741	NE515	NE562
NE527	7524	$\mu$ A733	$\mu$ A747	NE531	NE565
NE529	7525	75S107	$\mu$ A748	NE536	NE566
NE522	75S207	75S108	LM101A	<b>Voltage</b>	NE567
NE521	75S208	DM8880	LM201A	<b>Regulators</b>	
<b>Memory</b>	NE521	DM7820	LM301A	$\mu$ A723	<b>Consumer</b>
<b>Interface</b>	NE522	DM8820	LM107	NE550	NE540
3207		DM7830	LM207		NE546
3207-1	<b>Peripheral</b>	DM8830	LM307	<b>Timers</b>	ULN2111
3207A	<b>Interface</b>	NE501	LM308	NE555	PA239
3207A-1	75450	NE592	MC1456	NE556	MC1496

## signetics

# From CPU 8080 Microcom

Intel's new 8080 n-channel microcomputer is here—  
incredibly easy to interface, simple to program and with up  
to 100 times the performance of p-channel  
MOS microcomputers.

Best of all, the 8080 is real—in production  
at Intel and available in volume quantities,  
today. It's also available through distributors  
along with a growing line of peripheral  
circuits and a new version of the  
Intellec 8, a program and hard-  
ware development  
system for the 8080,

all supported with software  
packages, design documenta-  
tion and manuals, and backed  
by more than 100 man years  
of microcomputer expertise.

The 8080 is the inevitable  
successor to complex custom  
MOS and many large discrete  
logic subsystems. It is the  
industry's first general purpose  
n-channel microcomputer and  
the first high performance  
single-chip CPU, with extremely  
simple interface requirements and  
straightforward programming. It runs a  
full instruction cycle in 2 microseconds.

As such, the 8080 extends the economic  
benefits of Intel's p-channel microcom-  
puters to a new universe of systems that need  
fast, multi-port controllers and processors. These  
systems include intelligent terminals, point of sale  
systems, process and numeric controllers, advanced





# to software, the puter is here.

calculators, word processors, self-calibrating instruments, data loggers, communications controllers, and many more.

You can use 256 input and 256 output channels, handle almost unlimited interrupt levels, directly access 64 kilobytes of memory, and put many satellite 8080 processors around a single memory.

Interfacing is minimal and design is easy with the 8080 because all controls are fully decoded on the CPU chip itself and inputs and outputs are TTL compatible. There are separate data, address and control buses.

The 8080 microcomputer has 78 basic instructions, including the 8008 set plus new ones that make possible such features as vectored multi-level interrupt, unlimited subroutine nesting and very fast decimal and binary arithmetic.

Program development for the 8080 can be done either on a large computer using the Intel software cross products (PL/M systems language compiler, macro-assembler and simulator), or on an Intellec 8 development system with a resident monitor, text editor and macro-assembler.

The new 8080 product family includes performance matched peripheral and memory circuits configured to minimize design effort and maximize system performance. Large, low cost RAMs, ROMs, PROMs and I/O devices are available now and we will soon announce other 8080 LSI support circuits.

The 8080 is easier to use and more economical than any high performance microcomputer in sight. It's here now, in volume, from the inventors of the microcomputer and the people who lead the industry in production and design support.

Intel Corporation, 3065 Bowers Avenue, Santa Clara, California 95051.  
(408) 246-7501.

INTEL 8080	RAM MEMORIES		
	8101	256 x 4 STATIC	AVL: 3RD Q
	8111	256 x 4 STATIC WITH COMMON I/O	AVL: 3RD Q
	8102	1024 x 1 STATIC	AVL: NOW
	8107	4096 x 1 DYNAMIC	AVL: NOW
	ROM MEMORIES		
	8308	1024 x 8	AVL: 3RD Q
	8316	2048 x 8	AVL: NOW
	PROM MEMORIES		
	8702	256 x 8	AVL: NOW
	8704	512 x 8	AVL: 4TH Q
	8604	512 x 8	AVL: 4TH Q
	PERIPHERAL CIRCUITS		
	8205	1 of 8 DECODER	AVL: NOW
	8210	4K RAM CLOCK DRIVER	AVL: NOW
8212	8 - BIT I/O LATCH	AVL: NOW	
8216	BI-DIRECTIONAL BUS DRIVER	AVL: 3RD Q	
8201	COMMUNICATIONS INTERFACE	AVL: 4TH Q	

INTEL 8080 PRODUCT FAMILY

**intel**® Microcomputers. First from the beginning.



New  
space  
saving  
additions  
to our  
line  
of 1/2" diameter  
variable  
resistors.

If you're really  
serious about cost,  
be serious about quality.

Our 1/2" diameter variable resistors help you fight panel congestion. Type WR (lug terminals on side of case) and Type WRS (WR with rear mounted SPST switch). Both types give you famous Allen-Bradley hot molded composition resistance tracks for dependable, long term perform-

ance. Power rating 0.5 watt at 70°C. Linear taper available in values from 100 ohms to 5 megs. Four other standard tapers available from 500 ohms to 2.5 megs. Tolerance  $\pm 20\%$  or  $\pm 10\%$ . Request specifications publication 5220. Contact your Allen-Bradley Electronic Distributor or

write Allen-Bradley Electronics Division, 1201 South Second Street, Milwaukee, Wisconsin 53204. Export: Bloomfield, New Jersey 07003. Canada: Allen-Bradley Canada Limited, Cambridge, Ontario. United Kingdom: Jarrow, Co.. Durham NE32 3EN.



Actual Size

Circle 34 on reader service card



**ALLEN-BRADLEY**

Milwaukee, Wisconsin 53204

## **Small N. J. firm selling \$99 digital watch**

While the old hands in the watch business race to get under-\$100 digital watches to the market, **a small liquid-crystal house affiliated with Sprague Electric Co. has stolen their thunder.** Princeton Material Sciences, Princeton, N.J., is selling its timepiece through Alexander's department-store chain in New York City, which in two weeks sold or took orders for 5,000 units at \$99. Princeton Material won't comment on the development.

Timex, which is test-marketing a digital watch that it reportedly will introduce in the fall for \$85, refuses to comment. But a spokesman for Waltham says that **the digital-watch industry "has been turned upside down"** by Princeton Material's action; an official at Gruen agreed. And to add to the turmoil, Utah's Cox Electronics says it's going to introduce a \$99 liquid-crystal model at the end of the year.

## **Inselek working on microprocessor with 300-ns cycle**

Look for a C-MOS-on-sapphire microprocessor with a cycle time of 300 nanoseconds—**nearly seven times faster than Intel's recently announced model.** Being developed by Inselek Corp. of Princeton, N.J., the device will be ready early next year if all goes according to plan. Joseph Burns, president of the company, which specializes in silicon-on-sapphire ICs, divulged the timetable and confirms that work is under way, but he is reluctant to disclose details of the microprocessor.

By comparison, the new Intel n-channel MOS 8080 cycles in 2 microseconds, which itself is an order of magnitude faster than the same company's groundbreaking 8008 and 4004 microprocessors.

## **UK artillery control system interests U.S. Army**

The U.S. Army may go to Britain to get an automated field artillery fire-control system that works. Plagued by continuing development problems and rising costs of Litton's highly automated Tacfire system, **the Pentagon is seeking a field test of the less-computerized field-artillery computer equipment (FACE)** made by Marconi Space and Defense Systems Ltd. and used by the British Army since 1969. Requests for the field test are to be made through a U.S.-Commonwealth Defense Committee, which including Canada, Australia, and New Zealand, all users of FACE, sources say.

Tacfire, under development since 1967, is facing continuing Congressional budget pressure and is considered in the UK as too ambitious and unwieldy. FACE units, in keeping with British practice, **control only one battery and cost about the same as Tadcac**, in U.S. service since the late 1950s. Meanwhile, Marconi is actively seeking sales in Africa and South America for the system, which fits into the back of a Land Rover, a Jeep-like vehicle.

## **RFPs for DAIS due in July**

The Air Force Avionics Lab at Wright-Patterson Air Force Base will request proposals next month **for the digital processor in the anxiously awaited Digital Avionics Information System.** DAIS is a multi-aircraft, general-purpose system that interconnects a variety of on-board avionics.

Among the 45 companies surveyed for the computer RFP are IBM, Univac, Control Data, Autonetics, Honeywell, TI, and Rolm. **The Air Force is interested in off-the-shelf technology**, though such minor modi-

fications as substituting semiconductor memory for core could be handled. Sixteen machines will be purchased initially for delivery from March to June 1975, with each having a capacity of at least 24,000 words of 16 bits.

## Motorola working on EFL design

Emitter-follower logic, that old workhorse of the 1960s, may be making a comeback in a new streamlined form. Motorola Semiconductor's Integrated Applied Research Laboratory is building **two different triple-diffused emitter-follower logic LSI chips for a government agency**. And, according to Robert Jenkins, director of the lab, Motorola is seeking to determine if the technology is a viable one to add to its processes.

The EFL, which has been under primary development at TRW Systems in Redondo Beach, Calif., for military computer and communications applications, **is a very high yield, simple technology capable of relatively high density and good speed performance—40 megahertz**. It's also adaptable to computer design techniques. Jenkins says the process is a good one but does have limitations, notably that it's most adaptable to combinational logic rather than memory circuits. He adds that Motorola is not looking for additional business in EFL.

## Static RAM accesses in 145 ns

Designers of peripheral equipment will soon be able to design with a static memory that accesses in only 145 nanoseconds. The usual access time for such devices is 500 to 1,000 nanoseconds. **However, the speed is obtained at a price:** static memories are generally easy to handle because they use only one power supply, which is what makes them slow. But the new device, a 1,024-bit n-MOS part from the SEMI subsidiary of Electronic Memories, uses three power supplies—the same as a dynamic memory.

SEMI will offer two parts: the 145 ns model 1217 and the 260 ns model 1216. They'll be interchangeable, but won't be plug compatible with other RAMs. **And the company expects to complete a second-source agreement soon.** The parts will be priced at \$11 and \$13 in 100 to 999 quantities.

## Addenda

Matsushita will buy \$1.75 million worth of TV tuners and \$1 million worth of flyback coils and deflection yokes this year from General Instrument, **the first time Japan's largest TV and components maker has gone aboard for any parts except semiconductors**. The company cites better prices and a shortage of tuners meeting the U.S. uhf-vhf equality rules as reasons for the move. . . . Experimental fiberoptic material has been fabricated at Bell Laboratories, Murray Hill, N.J., **with losses of only 1.2 decibels per kilometer**. The fibers are made with chemical vapor deposition techniques familiar to the semiconductor industry. Lowest losses so far were measured at the infrared wavelength of 1.06 micrometers with fibers consisting of a pure fused-silica core with a borosilicate cladding. . . . Motorola's \$220 million suit against Fairchild, filed in 1968 after C. Lester Hogan left Motorola to head Fairchild, **has been dismissed**.

# Perfect for power supply design.

Unitrode's new ESP Power Switch provides the power transistor and catch diode functions required in switching regulator applications. One convenient package delivers the extra *Efficiency, Speed, and Power* needed to improve response time over regulating components commonly used in power supplies... and at no extra cost.

Unitrode selects and matches its exclusive ESP high speed rectifiers and power transistors to produce a single, plug-in TO-66 package... saving hours of design time.

This new ESP power switch operates with more than 80% efficiency. That's at least 15% better than most switching regulator circuits. Switching rates can be increased from the normal 10-20 KHz to 50 and even 100 KHz. And the ESP power switch can be driven by any IC regulator with no external biasing required.

Since no diode recovery spike is generated, there's less noise and RFI. Circuit designers can use a smaller LC filter, further reducing total power supply size, weight and cost.

For detailed specifications and performance characteristics on both 5A and 15A units, send for our ESP Power Circuit literature. Or, for faster action call Ernie Crocker at (617) 926-0404.

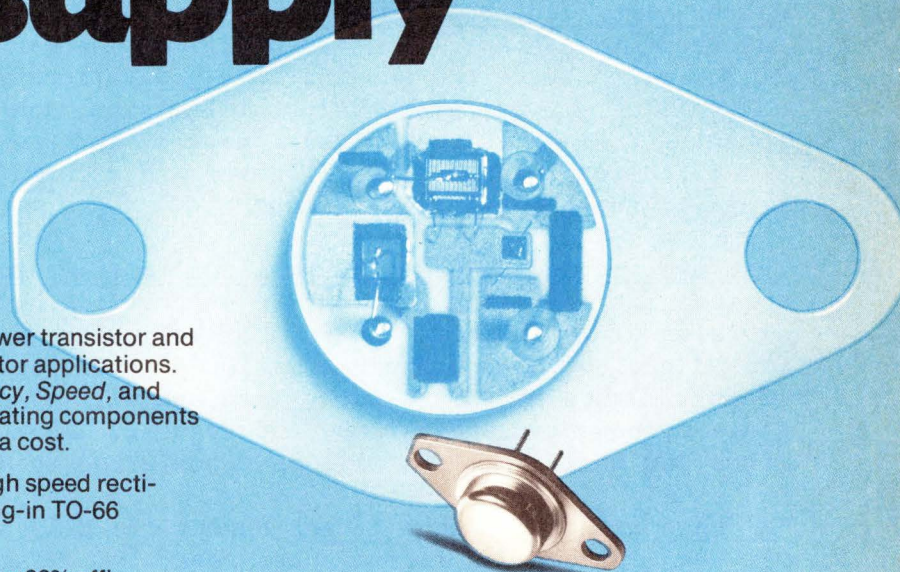

## New Unitrode ESP Switching Regulator Power Switch

Type	Max. Output Current $I_1$	Max. Input Voltage $V_{4-2}$	Typical Efficiency $\eta$	Typical Rise Time $t_{rv}^*$	Typical Fall Time $t_{fv}^*$
POSITIVE OUTPUT					
PIC600 PIC601	5A	60V 80V	85% @ 2A	30nSec	50nSec
PIC625 PIC626	15A	60V 80V	82% @ 10A	45nSec	70nSec
NEGATIVE OUTPUT					
PIC610 PIC611	-5A	-60V -80V	85% @ -2A	40nSec	50nSec
PIC635 PIC636	-15A	-60V -80V	82% @ -10A	50nSec	65nSec

\*Measured with  $V_{in} = 25V$ ,  $V_{out} = 5V$ ,  $f = 20$  KHz, Input pulse width =  $10\mu$ Sec  
See Electronics Buyers' Guide Semiconductors Section for more complete product listing.

Circle 37 on reader service card

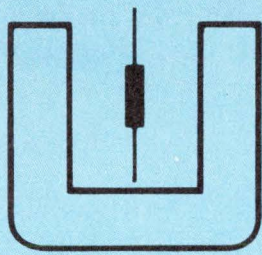

**Available  
off the shelf**

# UNITRODE

580 PLEASANT STREET, WATERTOWN, MA 02172

# SCIENCE / SCOPE

Westar, the first U.S. domestic communications satellite, which was successfully launched by NASA April 13, was built for Western Union by Hughes. Positioned 22,300 miles above the equator in a geostationary orbit, Westar is designed to relay telegram, mailgram, voice, television, and data communications to the continental U.S. as well as Alaska, Hawaii, and Puerto Rico. A second Westar is scheduled to be launched this summer and a third will be held on the ground until traffic growth warrants its launch.

Iran has awarded Hughes a \$25-million contract to design and equip an electro-optical facility in a new 480,000-square-foot building at Shiraz. It will be a division of Iran Electronic Industries, which is the result of the Shah of Iran's stated goal of broadening his nation's technological and industrial base. It will support Hughes systems used by Iran and will eventually be used to fabricate complete components, subsystems, and systems. About 170 Hughes engineers and technicians and their families will be transferred to Shiraz during the next 24 months.

The Phoenix missile went to sea during the U.S. Navy's F-14 Ship-Suitability Trials off the Southern California coast recently. Missile, aircraft, and AWG-9 weapon control system were completely exercised for the first time aboard the USS Enterprise. The trials included underway replenishment of Phoenix missiles from an ammunition ship, handling of the missiles from magazine to aircraft, and a firing mission in which a Phoenix-loaded F-14 took off from the carrier. The Phoenix, the AWG-9, and the shipboard support equipment were built by Hughes.

A military version of the Interdata Model 70 minicomputer is being produced by Hughes under license from Interdata, Inc. Designated the H-1670, it is packaged to withstand the extremes of shock, vibration, temperature, and humidity encountered in tactical military operations. The micro-programmed 16-bit processor has 16 hardware general registers, addressing of main memory up to 262K bytes, and 115 instructions. All Model 70 software is directly applicable without modification.

Hughes Research Laboratories has an opening for a Senior Staff Electrical Engineer with experience in high-voltage and high-current switching. Also a PhD Physicist with experience in R&D in liquid crystal chemistry for display purposes. Please write: Mr. A. J. Simone, Hughes Research Laboratories, 3011 S. Malibu Canyon Road, Malibu, CA 90265. An equal opportunity M/F employer.

New products from Hughes include: a series of solid-state linear power amplifier modules in the 1.7 to 2.4 GHz frequency range for incorporation into customers' systems; they range from 0.12 watts minimum power output at 20 dB minimum gain to 0.8 watts at 28 dB....a wire bonder and a die bonder for high-rate semiconductor or hybrid circuit production; their modular design provides adaptability to various bonding techniques....a 1-watt CW argon ion laser suitable for OEM installation utilizing a light feedback stabilization system; it is designed for instrument, system, or laboratory applications requiring a noise level of less than 1% rms and output power stability of  $\pm 1\%$ .

Creating a new world with electronics

**HUGHES**

HUGHES AIRCRAFT COMPANY

## LED with storage makes feasible large displays

Ferranti has developed a means of multiplexing LED matrixes without diminishing emitted brightness.

**Providing internal storage** for light-emitting diodes may make LEDs practical for large arrays, and a new development from Ferranti, Oldham, England could hold the key. Although multiplexed LED displays are widely used because they simplify interconnections and drive circuitry, each additional multiplexed point or segment reduces the brightness of the image. This is generally not a problem in common seven-segment readouts, but it becomes increasingly serious in large matrix displays, especially those used in bright environments.

The alternative to multiplexing, direct addressing, requires large and complex interconnection arrays, plus substantial external storage circuitry to keep the points lit. Some

designers have proposed using either four-layer, or Shockley, diodes or p-i-n diodes, but both of these diodes are difficult to reproduce uniformly with low switching voltage and bright light output.

The new approach to a storage diode by researchers at Ferranti was described at the 1974 Society for Information Display conference in San Diego, Calif., last month. The diodes, called Thyropters, depend on optical feedback within the device structure. Ferranti's Victor Pastore says the devices thus far fabricated have turn-on currents of about 1 milliamperere at potentials between 8 and 11 volts, and holding voltages can be in the 2- to 4-v region.

Thus, for normal operation, the diodes are forward-biased at approximately 7 V, below the turn-on threshold, and are turned on and off with pulses of  $\pm 5$  V of over 1 microsecond duration. The nominal device current is 15 milliamperes with a brightness of 400 foot-lamberts at a wavelength of 5,650 angstroms in the green spectrum.

The device is similar, except in one regard, to a LED with a p-type region diffused into an n-type epitaxial layer grown on an n-type substrate. The difference is a high-resistivity layer incorporated in the epitaxial layer; this, in effect, forms a photosensitive region. This layer restricts current flow through the device at low voltages, but as current increases with higher voltages, light is emitted at the pn junction.

**Turned on.** This light causes current flow at the barrier between the epitaxial layer and the high-resistivity layer, resulting in a negative-resistance characteristic that keeps

the device on, even when voltage is reduced somewhat. At present, the current must be limited by external resistance of about 180 ohms because of the difficulty of integrating this high resistance value.

The devices have been designed into a small hybrid matrix display, and work is proceeding toward a monolithic array with much higher density, which is scheduled to be available commercially in two years, Pastore says. The optical isolation required between cells has been demonstrated, but many problems in uniformity and contact resistance remain.

Interestingly, since the individual device elements are sensitive to light at approximately 5,650 Å, they can be turned on by an optical pen. Thus, because the elements can be sensed electronically, data can be entered, as well as retrieved. Normal room lighting is not a problem if the usual contrast-enhancement filters are used; a 5,145-Å argon laser has been used for addressing the display. □

**Thyropter structure.** Once turned on, Ferranti-made LED remains lit.

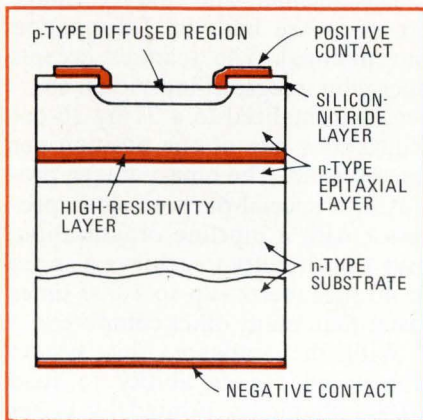

### Displays

## Thin film lights matrix TV panel

Electroluminescent panels, which have never appeared to be practical for commercial markets in their 15 years of development, may now be headed for a new life. Researchers at Sharp Corp.'s Central Research Laboratories in Japan, have developed a sealed ac-coupled display that offers high light output and

long life. The lack of these properties are the two major problems with present electroluminescent displays. With its thin-film approach, Sharp has already made a 120-by-90-dot matrix TV display measuring 36 by 48 millimeters.

According to Sharp, the panels have operated more than 10,000 hours with outputs of 1,000 foot-lamberts. The light, at 5,800 angstroms, is yellow-orange. The color is a result of the 5% manganese-doped zinc-sulfide layers forming the emitting material. Other colors are possible. For example, green can be obtained with a tellurium-fluoride activator.

**Device structure.** The structure of the device is a sandwich of a 5,000-Å thin-film of manganese-doped zinc sulfide with a 2,000-Å insulating layer above and below. These two layers seal the emitting material. An aluminum electrode is fixed to the back of the device, and a transparent tin-oxide layer to the front.

This unit is constructed on a glass substrate. The two insulating layers between the active layer and the contact areas appear to represent the major change from the previous short-lived devices, which have the metal in contact with the zinc sulfide. The insulators are composed of yttrium oxide, evaporated from an electron-bombarded source, silicon nitride, or alternate layers of silicon nitride and aluminum oxide. Protection from moisture is provided if the outer layer is silicon nitride.

The device gets brighter as it is used—at least up to a plateau. This brighter value can be accelerated by a two-hour operating bake at 200°C.

The drive for the device consists of ac pulses at approximately 250

volts. The display brightness depends on the applied voltage, a dependency the earlier powder-type electroluminescent displays did not exhibit. The brightness is also highly dependent on pulse width, making it possible to obtain TV-type gray-scale displays.

**TV-display mode.** The Sharp researchers developed the TV display by depositing a large sheet of emitting material between insulating layers, with vertical and horizontal conductors arranged over and under in the familiar parallel strips. By this means, any crossover could be addressed separately. A contrast ratio of more than 50 to 1, with 50 foot-lamberts average brightness, has been achieved at a scan rate of at 60 fields per second.

Eight gray scales are available, and the driving voltages are 130 V peak vertical and 130 V horizontal. One line at a time is addressed out of every three lines. The firm expects to have an 8-inch display within a year and a half. □

Commercial electronics

OCR unit reads hand-printing

Of all the efforts to speed up entry of raw data to computers, perhaps none has proved more complicated than direct reading of standard hand-printed text. But the complications are neatly negotiated in some new software that Information International Inc. developed to enable its Graftix I optical-character-recognition system to read conventional

hand-printing, as well.

Other firms—including Scan-Data Corp., Norristown, Pa., Recognition Equipment, Dallas, Texas, and IBM, Armonk, N.Y.—have developed optical character readers that read either numerals only or alphanumeric characters carefully copied from the American National Standards Institute standard set. The program by the Los Angeles, Calif., firm, however identifies normally hand-printed alphanumeric characters in any sequence, the only requirement being that an I have bars at top and bottom and a Z have a slash through it. The system processes about 200 characters a second.

The program, which was developed by Steve Gray and Arnold K. Griffith, senior members of the technical staff, begins with a relatively conventional, algorithmic "filter," which recognizes about 70% of the characters very rapidly by following a fixed pattern of analysis. This is followed by a more novel "verifier," which is slower but more thorough. The operation of the verifier is based on heuristic principles—its route to recognizing most of the remaining characters is not fixed, but varies with what it discovers along the way.

The large and complex Graftix I, of which the program is an extension, is a medium-scale time-shared computer system that combines a sophisticated flying-spot scanner and a very-high-speed specialized computer, called the binary image processor, with a DEC PDP-10. The PDP-10 has 150,000 36-bit words of core memory, plus a full range of peripherals.

The scanner and binary image processor are built by Information International. The scanner accepts microfilm images of individual characters normalized to a 31-by-36-dot matrix at a rate of one position per microsecond. The binary image processor, a special-purpose slave processor with a pipeline organization, uses TTL circuitry to achieve a speed of 40 megahertz—up to 1,000 times faster than many other computers.

With the software, this system was tested for its ability to read 10,000 characters printed by clerks

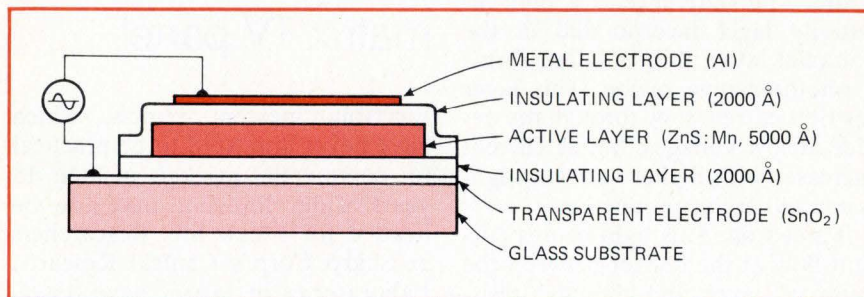

**Electroluminescent sandwich.** Using a matrix of these devices, Sharp has already fabricated a TV-type display measuring 36 by 48 mm.



## Growing crystals in space spurs study for speed, higher quality

Some of the basic ideas about the physical processes involved in crystal growth may be upset when studies of semiconductor crystals grown aboard Skylab II are completed at Rensselaer Polytechnic Institute, Troy, N.Y. The major result is likely to be a means of growing higher-quality crystals faster.

That is the opinion of Heribert A. Wiedemeier, professor of chemistry at RPI's Materials Research Center, who prepared ampules containing source material of germanium selenide and germanium telluride for growth by means of vapor-phase, a widely used technique for growing epitaxial layers for semiconductors.

For the Skylab experiment, Wiedemeier expected that the crystals would have fewer imperfections, but that the transport rate of materials would be slower. He found, however, that the crystals not only had fewer imperfections, but that the rate of growth was much faster than on earth. The next step is to isolate the factors causing the increased growth.

The major environmental change in the Skylab experiments was the lack of a gravitational field. According to the traditional diffusion-convection model of crystal growth, turbulence caused by gravity during the convection phase results in imperfections in crystal structure.

If convection is minimized (it can-

not, of course, be eliminated on earth) by keeping the pressure low in the sealed ampule containing the source material, crystal quality is improved. This procedure usually results in slower growth; not so in Skylab, however.

Because it is unlikely that a chemical reaction is fundamentally different in space than on earth, Wiedemeier reasons that the predominance of gravity-driven convection in crystal growth may veil other mechanisms at work during diffu-

sion. He has postulated that there may be a previously unsuspected transport mode that has not been considered in the present diffusion-convection model.

Whatever the mechanism, it must be understood physically in order to control it and apply it to industrial methods of crystal growth. Analysis of the Skylab crystals may be sufficient, but even more data may be supplied by a similar experiment Wiedemeier is now readying for the Apollo-Soyuz mission next year. □

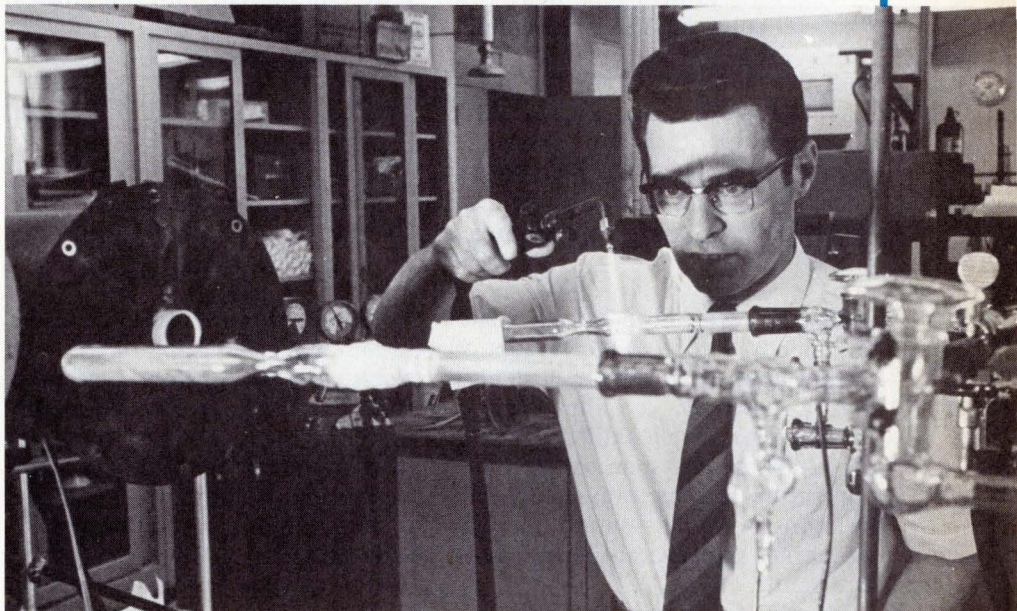

with only 5 minutes of training and 5 minutes of practice. It rejected 4% of the characters and mixed up 0.05%, or five characters out of the 10,000.

Information International is looking first to the Government for use of the hand-print-reading capability, says Daniel Forsyth, vice president for advanced systems. Social Security is a prime candidate because of the tremendous number of forms it processes, and even more growth is expected as medical programs increase. The company has already sold one of the \$1.25 million

Grafix I systems to the Navy for reading conventional printing, but the same hardware could handle hand-printing. □

### Fiber optics

## Thin-film layer cancels polarization

The information-carrying capacity of optical transmission lines could be doubled if the components of op-

tical-waveguide systems were not polarization-dependent. And they need not be, says Leonard Bergstein, professor of electrical engineering at the Polytechnic Institute of Brooklyn, N.Y. A thin-film technique can modify the reflection coefficient at the interface of two optical media to allow matching of the phase velocities of two perpendicularly polarized signals.

In a polarization-independent waveguide, two perpendicular polarizations, like the TE and TM modes, could be independently modulated and demodulated by

only one coupling at the input and output, Bergstein explains. In a polarization-dependent waveguide, however, perpendicular polarizations will propagate with different phase velocities, so that only one of the two can be demodulated with any feasible input/output coupling.

**Clad and unclad.** There are two major sources of polarization dependence in cylindrical waveguides: polarization-dependent reflection coefficients at dielectric interfaces, and birefringence within the fiber. The former dominates in low-loss clad fibers, where multiple reflections between the core material and the cladding occur. The latter becomes important in long lengths of unclad fibers.

According to Bergstein, there is a practical solution that is essentially

the same in both cases—the insertion at the critical dielectric interfaces of thin-film phase-matching layers. For clad fibers, this critical interface between the cladding, the core glass, and the phase-matching layer must therefore run the full length of the fiber. For unclad fibers, coating the ends of the fiber is sufficient. The thin-film material has an index of refraction that is the geometric mean of the refraction indexes of the two surrounding media, since this is what cancels the polarization-dependent components of the reflected waves.

Bergstein has applied the same techniques to filters and wave-splitters, thus making feasible a complete set of polarization-independent components for an optical communications system. □

for all tooling connected to the stations. The date and time of day can be included, as well. At the option of the user, an alarm light or buzzer may be substituted for an out-of-tolerance printout. A general-purpose interface at the host minicomputer matches each Plant box to the computer via the high-speed serial communications lines.

**Stripped threads seen.** The data itself comes from dc strain gages on each torquing tool. These gages send over a shielded cable low-level dc analog voltages that indicate the actual torque characteristic of each fastening operation. Equivalent torque voltages are stored in memory, and the processor is able to calculate actual torque applied to a fastener. The system also includes a special tool-controller module that provides excitation for the transducer, as well as transducer-signal amplification, peak-torque detection, an automatic tool shut-off signal when maximum torque is reached, and 10 bit analog-to-digital conversion for output to the microprocessor card.

In addition, a timer determines how long it takes the transducer signal to get from the threshold where torque is first applied to peak. This enables a fault such as crossed threads on a fastener to be detected immediately—the fastener would be torqued to a final value in only 50 milliseconds, when it should have taken 100 to 300 ms. Moreover, stripped threads might show up when a relatively long time is taken for torque to build up—say 400 ms.

Communications between the host minicomputer and each Plant box are serial at 40,000 to 160,000 bits per second, using the company's high-speed serial input/output controller modules. A standard interface module—PCS series 2000—is used as well.

Originally, Process Computer had thought of using Hewlett-Packard minicomputers at each of the remote stations, says chief engineer Richard Barnish. However, the microprocessors offer several distinct advantages, he points out. The systems cost less and also allow the company to boost the value that it

---

## Production

---

### Microprocessors add new twist to torque-monitoring

Since Federal auto-safety regulations now extend to the amount of torque applied to tighten fasteners during assembly, a Flint, Mich., company has put together a microprocessor-based system for monitoring torque at remote assembly-line locations. And the system is already earmarked for several General Motors plants.

Process Computer Systems Inc. designed its Torque Certification System to monitor, control, and provide hard-copy documentation for the 30 to 50 critical fasteners installed in a vehicle. Although each remote unit can stand alone, high-speed data links can connect as many as 256 remote microprocessor terminals to a host minicomputer to obtain factory-wide information.

Each microprocessor terminal, in turn, can handle up to 25 torquing tools so that a single 16-bit minicomputer—a Hewlett-Packard 2100—and 256 small satellite processors can accommodate some 6,400 tools. Moreover, the builders of the system say it has uses, not only in

the defect-conscious auto industry, but in other industries faced with excessive field repair, replacement of fasteners, or new Federal quality and safety standards. In the auto industry, for example, assembly plants must employ additional personnel to check and often to retorque critical fasteners.

Each satellite terminal, sealed in an environment-proof enclosure, is built up of standard modules, also developed by Process Computer, in what is called a Plant box. The company's CM4400 microprocessor module uses the 8-bit Intel 8080 chip and includes six 8-bit registers, 8-bit accumulator, 8-bit parallel arithmetic unit and 16-bit stack pointer. Four different memory modules may be used in any combination for up to 64 kilobytes of read-only and random-access memory for storing data, data tables, and application software.

Also included in the Plant box is a teletypewriter that prints torque readings and out-of-tolerance messages, along with summary reports

# DigiTec introduces the first in the **HT** SERIES *(a breakthrough in High Technology)* with five new Digital Recorders.

DigiTec's new HT Series (High Technology) is the culmination of a long term program to produce a complete line of digital instruments of the future for your needs. DigiTec has combined the state of the art with our own patented circuitry to offer truly innovative in-

strumentation. The HT Series, our proudest achievement, delivers instruments with the ultimate in reliability and performance. Reflecting the advanced technology contained within, all units utilize a new designer-styled, diecast enclosure.

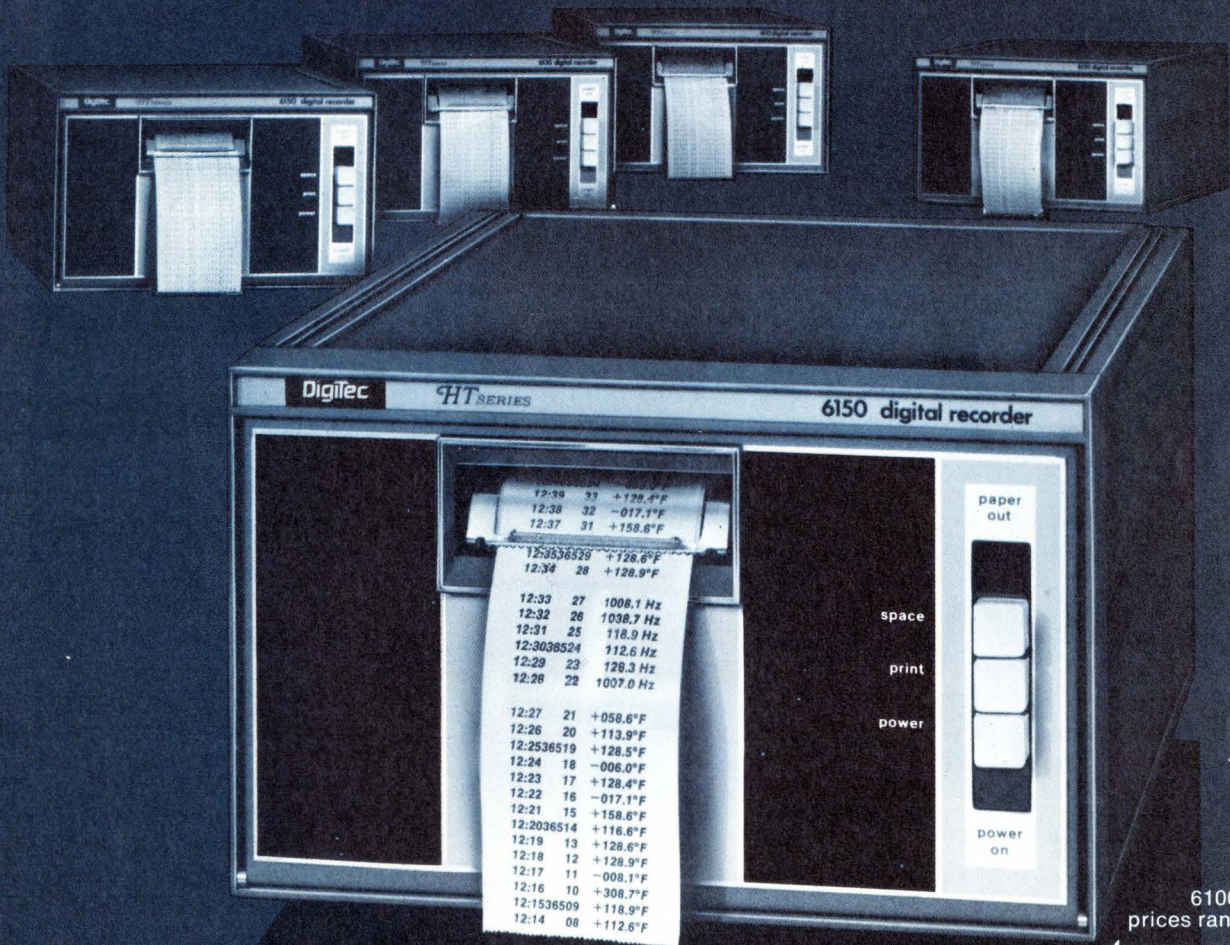

6100 Series  
prices range from

## \$549.

with generous OEM discounts

Selected models in the 6100 series Digital Recorders offer combinations of: 10 or 18 column capacity / integral quartz clock, printing real or elapsed time and integral events or day counter.

All models feature: printing rate, 3 lines per second nominal / wide variety of parameter symbols / programmable floating decimal / "paper out" protection / programmable red or black print / TTL compatible, BCD input / programmable single or double spacing / systems output / automatic column blanking / front loading / rack mountable diecast enclosure / compact, half-rack size (5¼" h x 8½" w x 12½" d). Contact your nearest DigiTec representative for an immediate demonstration.

UNITED SYSTEMS CORPORATION  
918 Woodley Road, Dayton, Ohio 45403  
Ph. (513) 254-6251 Twx. (810) 459-1728  
a subsidiary of

**Monsanto**

**DigiTec®**

"Information only" circle 42 on reader service card.

"Demonstration wanted" circle 43 on reader service card.

## Electronics review

adds to the product. What's more, the microprocessor cards are better able than the minis to withstand the severe factory environment. □

## Medical electronics

### Hospital speeds up ultrasonic diagnosis

Ultrasonic devices have been gaining ground as new weapons against

artery disease. The ultrasonic technique is a safe, noninvasive way of monitoring a patient's organs [*Electronics*, Sept. 13, 1973, p. 103]. But the results often take hours to assemble and require skilled interpretation. Now, researchers at Guy's Hospital Medical School, London, have designed and built their own system, in which doppler signals are monitored by specially designed circuitry—plus a Texas Instruments calculator chip. The result: an analysis now takes 10 minutes.

**Real time.** The principle under-

lying this and other ultrasonic angiology systems is that the red blood cells will backscatter 5-megahertz doppler signals with enough accuracy to indicate blood flow and condition of the arteries. But to achieve the faster analysis, the researchers at Guy's combined a real-time spectrum analyzer with a data collector containing the doppler-signal generator, probes, and a cassette tape recorder for recording the signals.

The spectrum analyzer converts the cassette's signals into waveforms, which it prints out as hard copy. Inputs from a pen tracing the waveform are then used by what the hospital calls a pulsitivity-index meter. This computes pulsitivity (or ripple), damping factor, and transit time of a signal, normalized for a patient's blood pressure. The TI chip is the heart of the meter.

The researchers are concentrating on leg arteries. By placing two doppler emitter/receiver probes along a leg artery, clinicians determine, from the system's analysis, whether an artery is normal, or whether and where it is narrowing, or clotted. Five readings are usually taken along each leg.

A key part of the system is the real-time spectrum analyzer, called a Spectrascriber, says David H. King, an electronics engineer who is a research assistant at the hospital. The more commercial type of time-compression analyzer may have up to 1,000 channels and is biased for frequency, rather than time-analysis, because it is often used to monitor vibration. And the vast number of channels slows it up.

**From 1,000 to 80.** The Guy's Hospital group dropped the number of channels to 80 per doppler channel for quick response, which, since they also optimized the time-frequency bias, got them the required precision. Hybrid analog-digital circuitry, using an MOS shift register, for example, made possible some data-sharing within the unit, also saving time. The analyzer synthesizes with the equivalent of 80 parallel filters, King explains.

The pulsitivity-index meter takes the tracing of the analyzer's wave

## Electronics Index of Activity

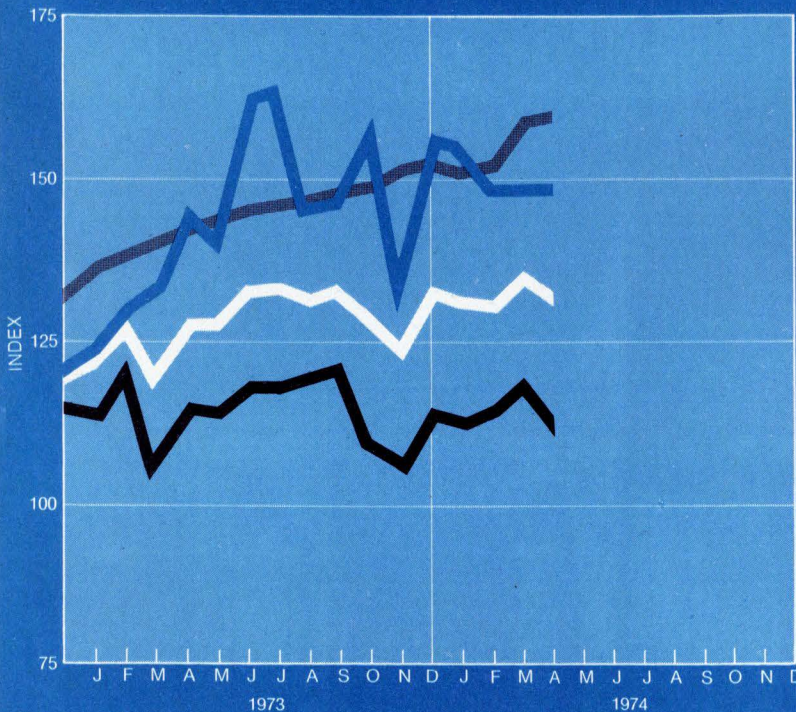

Segment of Industry	Apr. '74	Mar. '74*	Apr. '73
Industrial-commercial electronics	148.6	148.6	163.6
Consumer electronics	112.9	118.8	117.0
Defense electronics	159.8	158.8	141.7
Total industry	133.0	135.9	132.4

The over-all index fell 2.1% in April, leaving it 0.5% ahead of last year's level. The only decline was in the defense sector, down 5.0% from March and down 3.5% from a year ago. Consumer electronics remained the same for the third straight month. Industrial-commercial electronics, which rose 0.8% over March's level, caused the index to be 12.8% higher than a year ago.

Indexes chart pace of production volume for total industry and each segment. The base period, equal to 100, is the average of 1965 monthly output for each of the three parts of the industry. Index numbers are expressed as a percentage of the base period. Data is seasonally adjusted.  
\*Revised.



forms and produces "three parameters of interest," says King: the pulsitivity of the waveform, or ripple; the damping factor, the ratio between the upstream and downstream doppler probes; and the time delay between them, which is relative to a drop in pressure in the artery.

The system will be especially important for patients recovering from an artery-bypass operation, in which continuous monitoring is necessary and dye-tracing methods are inadvisable. Moreover, since the computation of the pulsitivity-index meter comes from a simple tracing, adding a graphic display to it means that less specialized hospital personnel can be used, thus freeing specialists for other duties.

Also, a data base of healthy persons' profiles can be used by doctors to pinpoint the degree of artery disease more precisely. In fact, the staff at the teaching hospital already has established threshold values for the system data, according to Dr. Raymond G. Gosling, reader in physics applied to medicine, who says that a large data base could lead to automated, objective diagnosis of artery disease.

From preliminary work in the hospital, the system is about to become part of a three-year trial sponsored by Servier Ltd., a drug company.

The group estimates that the whole system could be made commercially for about \$25,000, considerably less than anything remotely comparable. □

---

## Memories

---

### 8-kilobit CCD memory runs fast

Getting around the inherently slow serial nature of CCD memories has been a major problem. But Bell-Northern, Ottawa, Canada, has organized an 8,192 bit CCD chip into recirculating tracks to boost its speed, and the company is now assembling a 1-megabit memory that

## News briefs

### TI wins \$40 million Navy award

The U.S. Navy has selected Texas Instruments to develop its new air-to-ground High-Speed Anti-Radiation Missile, known as HARM, at an estimated cost of \$40 million. With the award of the first \$1.4 million for preliminary design, the Dallas-based company becomes the winner in competition with General Dynamics, Hughes Aircraft, and Lockheed Missiles & Space Co.

### RCA dropping audio-product line

RCA's Consumer Electronics division, Indianapolis, is phasing out the company's line of home audio products in order to concentrate on TV-related home electronic products. The 1975 line will be the last for radios, audio-tape players and recorders, and phonograph equipment. William Hittinger, executive vice president of the division, said the reason for the decision is that the audio product line has not been profitable in recent years.

### National shifts executives

National Semiconductor Corp.'s marketing organization now has a new marketing director, Gene Carter, former director of integrated-circuit marketing. Carter replaces Floyd Kvamme, who has become manufacturing vice president, the post recently vacated by Pierre Lamond. Lamond, in turn, left National to become president and chief executive of Palo Alto-based Coherent Radiation.

### Textron may invest in Lockheed

Textron Inc. may help to overhaul Lockheed Aircraft Corp.'s shaky financial situation through a top-level management switch. If approved, Textron will invest \$85 million in Lockheed stock, and G. Wilson Miller, the lawyer who heads Textron, will also become chairman and chief executive of Lockheed. Lockheed's present chairman, Daniel J. Haughton, will become vice chairman. Textron and Lockheed have tentatively agreed on the deal.

### Second Westar launch delayed

Trouble in NASA's Delta launch vehicle has delayed the launch of Western Union's Westar II communications satellite, which had been scheduled for June 10. NASA said "anomalies" that appeared on recent Delta launches will delay the launch—perhaps until August—pending results of a review of the Delta launch program.

### Burroughs adds to Series L line

Burroughs has added higher-performance models to its L-Series business minicomputers. The new machines are the L 6000H series, which includes three accounting minis and a magnetic-record mini. Also added are the even more powerful L 8800H accounting mini and L 8900H magnetic record mini.

### Radar market to reach \$5.5 billion

Government spending on the total ground- and ship-based radar market is predicted to reach \$5.5 billion for fiscal years 1974 through 1978, says Frost and Sullivan Inc., New York City market researcher. In addition, says the firm, annual funding will be about \$1 billion.

### Trade with Taiwan rises

A new trade center in Taipei, Taiwan, is aiding a "substantial rise in U.S. sales" to the Republic of China, says the U.S. Department of Commerce. Upswings are expected particularly in electronic test equipment, nuclear-test instruments, analytical instruments, and industrial process instruments and controls. The Commerce Department attributes the boom to a growing economy in Taiwan, coupled with its government's recent decision to encourage a more equitable trade balance with the U.S.

# This is why...

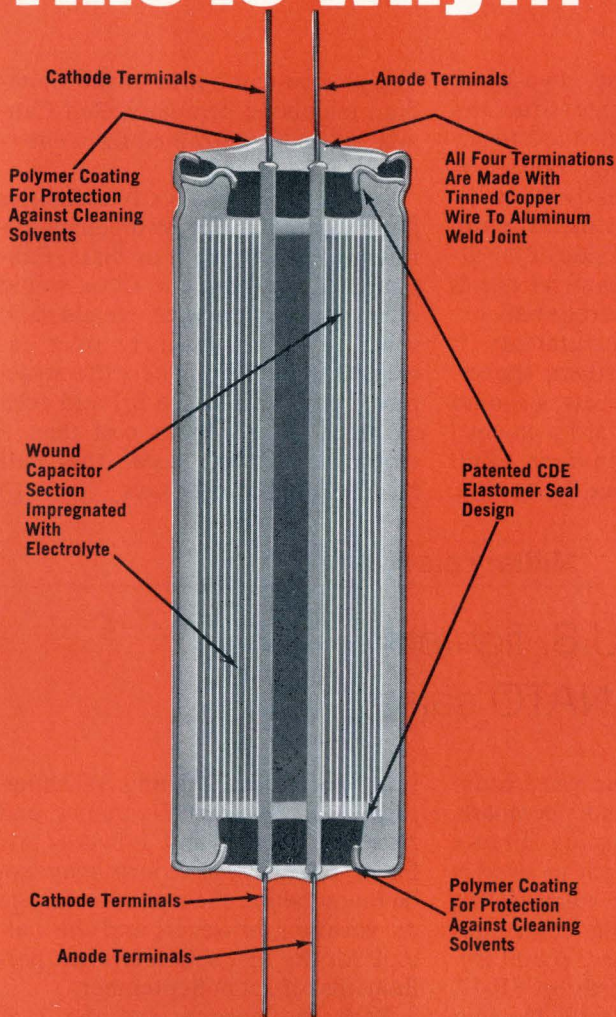

# this is Best...

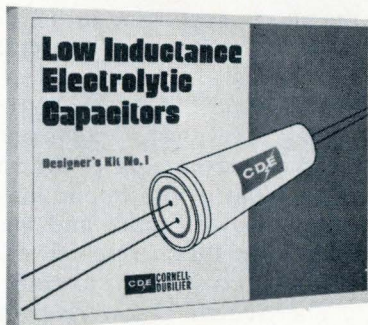
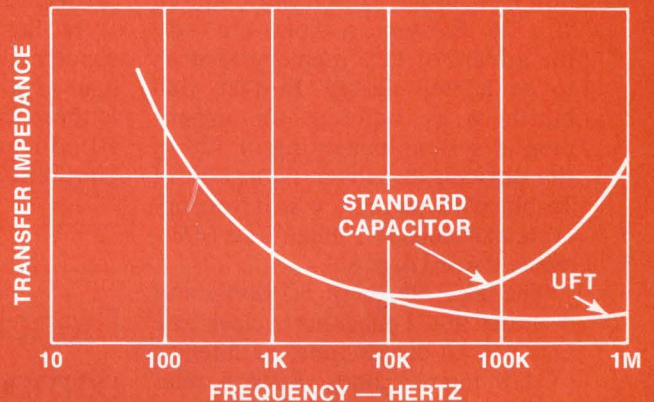

**DESIGNER'S KIT #1** — for those really serious about designing power supplies. Here's what you get: 12 pg. brochure, Designing Switching Regulators, giving theory of operation, detailed description, schematics, curves and component selection... Application and Designers notes... Engineering Inquiry and Sample Request Form... a Library of Article Reprints of recent technical articles describing power supply design... Construction features of the UFT... detailed specification brochure... and more!

**YOURS ON LETTERHEAD REQUEST ONLY!!!**

## FILTER NETWORK...

**Provided by Unique Construction Assures Low Inductance at high frequencies**

CDE leads the way again...with the development of the most advanced aluminum electrolytic capacitor, the UFT. This 4 leaded construction offers new design freedom...with low transfer impedance at high frequencies. Applications are growing. However, one of the most significant is switching regulators. These high efficiency power supplies have typically been plagued with noise problems. The UFT offers great isolation from ground loops, excellent noise filtering for both source and output voltage...with a transfer impedance that actually decreases above 10 KHz. There's an 8 page data sheet that details all the specs, yours by circling the reader service number. BUT, if you're really serious about designing power supplies, we'll send you our DESIGNER'S KIT #1...yours on letterhead request only.

**CDE** **CORNELL DUBILIER**

150 Avenue L, Newark, N. J. 07101

CDE — The People to People Company  
— the mark of quality is on everything we make.



Circle 47 on reader service card

could rival the performance of electromechanical disk memories.

The device has been operating satisfactorily in the laboratory at least since early February. And with the recent revelation that Signetics Corp., Sunnyvale, Calif., is readying a 16,000-bit CCD chip for introduction next winter [*Electronics*, March 7, p. 26, *Electronics*, April 4, p. 120] the advent of CCD memory appears to be a step nearer. In fact, Bell Northern is building an experimental system, consisting of 128 of the devices, to deliver 1 megabit of 16-bit-word storage, which will operate at speeds to 1 megahertz [*Electronics*, April 4, p. 35].

The Bell Northern 8,192-bit unit operates at a 1-megahertz clock rate and has an access time, or latency, of 128 microseconds. Such a relatively fast latency is achieved by organizing the array into 32 recirculating serial memory tracks of 256 bits each. Thus, the waiting time for access to data is shorter by a factor of 32 than with a conventional 8-kilobit shift register that has a single "track."

Moreover, when data is not being accessed, the CCD chip is designed to have a 10-kilohertz idle rate for refreshing data. This means that power dissipation, with 8-volt clocks, is only a milliwatt; during data transfer at 1 MHz, it is 15 mW on-chip, plus a capacitive drive power of 90 mW dissipated off the chip. Bell Northern has also operated the chip at rates above 2 MHz.

Random access to any track is provided by on-chip decoding of a five-digit address. Data is read out nondestructively, except while the input terminal is enabled, in which case each input data bit replaces the bit readout during the previous half-clock period.

Sequential read/write operation is achieved by including a 1-bit CCD register between the output and input nodes as part of each recirculating 256-bit track.

Over-all chip dimensions for the 8-kilobit array are 178 by 168 mils. This works out to 3.6 mil<sup>2</sup>/bit, including 1.2 mil<sup>2</sup>/bit for peripheral circuits, interconnections, and bonding pads. The CCD elements them-

selves are two-phase, two-level, overlapping, silicon-gate structures that permit a simplified CCD-electrode layout providing transfer in one direction only. End-of-row refresh amplifiers drive metal return lines back to the input side of the array. In-row or end-row refresh is carried out every 32 storage bits.

As far as manufacturability is concerned, a Bell-Northern spokesman says that the process is similar to those used for standard n-channel silicon-gate MOS devices. Bell Northern could produce the devices,

but, as a research arm of the Canadian telephone company, Bell Canada, is legally restrained from entering into manufacture.

In the long run, CCD memories have a good chance of replacing rotating memories such as disks. Fabricated in systems, the CCDs would offer savings in power, weight, and space, and would likely offer increased reliability. The CCD structure promises at least a 2:1 and even as much as 4:1 lower cost than a comparable MOS RAM, the Bell Northern spokesman says. □

## Military electronics

### French and U.S. fighters compete for NATO sales

Representatives of four NATO countries—Belgium, Holland, Denmark, and Norway—are visiting France and the U.S. this month to select a replacement for their aging F-104 Starfighters. The main contenders for the business are the General Dynamics YF-16, the Northrop YF-17, and the French Mirage 1E. The four countries will require about 350 to 400 aircraft—roughly a \$2 billion deal. About 40% of the total will go for electronic equipment.

In addition, there are prospects of overflow business with non-NATO nations, such as Iran, Spain, Greece, Turkey, the oil sheikhdoms, and certain South American countries. Total sales outside the U.S., including the four NATO partners, could run from 1,000 to 1,500 planes.

Representatives of the four NATO countries will be in the U.S. June 24

for three weeks, visiting Washington, D.C., General Dynamics and Northrop plants, and Edwards Air Force Base. Their reports may not be ready before their parliaments go on vacation, however, and the outlook for the first action is when parliaments return in September.

Both the French and the U.S. firms have offered a variety of deals to potential buyers that call for production of up to half the number of the planes now flying in their countries. Government representatives will primarily be looking at economic aspects of the arrangements, having previously examined the technical advantages of the various craft. What is also important is the willingness of France and the U.S. to pick up future research and development costs of the aircraft.

The General Dynamics plane has



**General Dynamics contender.** The YF16 is one of three fighters competing for NATO buys.



### ±0.02% WATTMETER ACCURACY

at 50 and 60 Hz plus 0.05% accuracy from 50 to 500 Hz even with distorted waveforms and low power factors. The YEW Model 2885 is the accepted standard in AC power measurements throughout the world.

Model 2885

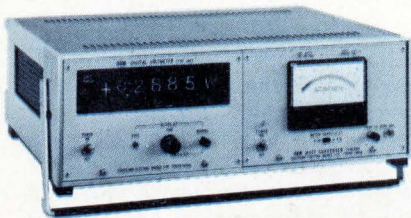

### TRUE RMS & 0.1% V-A-W ACCURACY

over a wide frequency range, with distorted waveforms and with low power factors. For both laboratory and field application without extraordinary set-up requirements. The 2503 combines exceptional accuracy, a True RMS capability, and ease of operation all in one extraordinary instrument.

Model 2503



### ±0.5% PRECISION PORTABLES

with rugged and precise tautband meter movements. Hundreds of models and ranges to choose from with accuracies traceable to N.B.S. Full one year replacement warranty, fast service and low cost (prices start at just \$95.00) combine to make these the world's best selling portables.

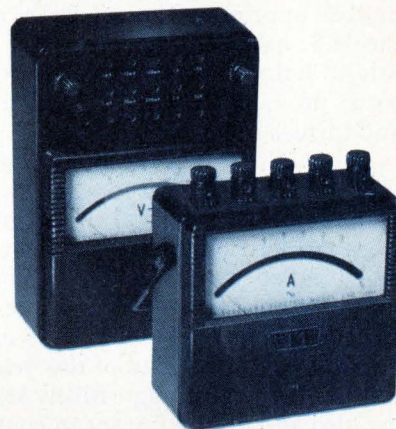

# PRECISION POWER

... from YEW, the world's largest manufacturer of precision power and True RMS measuring instrumentation!

YEW manufactures a complete line of precision power measuring instrumentation that meets the requirements of the most demanding instrumentation application. In fact, YEW's sophisticated APR-2 serves as a national standard in numerous countries of the world. YEW's precision portables are unexcelled in world-wide sales and have a reputation for being the most reliable and economical portable instrumentation available. Check some of our specs and we think you'll agree that YEW puts the "precision" in power instrumentation!

## YEWTEC CORPORATION

1995 Palmer Ave., Larchmont, N.Y. 10538  
Telephone: 914-834-3550

Yokogawa Electric



60 Years of Measuring and Recording Instrumentation

been flying since February, and the Northrop aircraft was to be flown for the first time this month. Testing on the two projects should be wound up by next spring, and then the U.S. Air Force is to consider the purchase of the planes, subject to budget approval. The selection by the U.S. might boost sales, since it might help to lower production costs, provide spare-parts back up, and furnish other support.

The U.S. has been touting the General Dynamics and Northrop planes on their technical superiority over the French Mirage, which is being called a redo of an existing plane. The Mirage, being redesigned around a new engine, is expected to fly by the end of this year. But the French are aggressively selling also and urging European countries to "buy Europe."

The Belgians and Dutch will probably be the first to decide on replacement of the Starfighter, probably this fall. With strong electronics capabilities, both countries will probably get a lion's share of the avionics business. □

## Defense outlays to rise past 1975

The Pentagon's fiscal 1975 spending request is now nearly halfway through the congressional mill, and the funding outlook for the country's largest spending agency and its electronics programs is good for the short term and even better for the years ahead. The congressional mill this year is grinding quickly and not very fine.

In the two-step process, an authorization bill fixing a spending ceiling is followed by an appropriation. The House has now passed a \$22.6 billion authorization for procurement, research, and development after its Armed Services Committee had cut the Department of Defense request by only \$500 million, a tiny 2% of the total. Procurement outlays represent approximately 27% of DOD's proposed expenditure total of \$85.8 billion in

## Congress favors defense spending

Although there are still critical cost overruns in some military programs, Congress doesn't appear to dislike any program very much. That is the opinion of one knowledgeable House military-appropriations analyst.

Even the Air Force's long-controversial Airborne Warning and Control System with its look-down radar is expected to be funded for production of at least six planes. This represents a cut by the House of half the number sought, but Senate tactical-air-power specialists are pushing for the full dozen. The USAF request for \$769.5 million in fiscal 1975 is for the Boeing/Westinghouse program, the service's third largest. It is exceeded only by the \$1,076 million sought for the McDonnell Douglas F-15 fighter and the \$918.5 million requested for Minuteman missiles, improvements, and site defense.

Although the Awacs procurement was chopped by the House, the \$219.7 million for R&D has been left intact by both chambers thus far. One new and still unresolved threat to Awacs is a recent General Accounting Office report to Congress that its radar is vulnerable to enemy jamming with relative ease. The Air Force denies this, yet the Senate wants Schlesinger to name a panel of "disinterested experts" to evaluate the charges.

Of two new tactical air programs for the 1980's—the Navy's VFX light-weight follow-on to the costly Grumman F-14 and the similar Air Force air-combat fighter, proposed successor to the F-15—both House and Senate are near agreement thus far on the \$30-odd million sought by USAF. The House, however, has scrubbed the \$36 million sought by the Navy. Some Navy money could be restored later, but Congressional sentiment is growing for a commonality study to see if one plane could do both jobs.

The Army's Advanced Attack Helicopter, follow-on to the cancelled Lockheed AH-56 Cheyenne, could be in trouble. The service acknowledges that unit costs for a buy of 472 aircraft would be \$4.2 million, or close to the \$5.1 million figure for Cheyenne at the time of cancellation.

fiscal 1975 [*Electronics*, Feb. 21, p. 69].

The Senate, known for making larger cuts than the lower chamber, has until now reduced the procurement and R&D money request by only \$1.3 billion to \$21.8 billion. If the House of Representatives and Senate decide to compromise as they have in the past by splitting the difference, Defense Secretary James Schlesinger will wind up with an authorization approximating \$22.2 billion, or only \$800 million less than he asked for.

This cut is only 3% compared with reductions in prior years of 5% or more. DOD would be authorized to spend about \$2 billion more than it got a year ago for hardware and studies in the new fiscal year that begins July 1.

**Reductions limited.** While legislative analysts in DOD, the Congress, and industry agree that somewhat bigger reductions may come in the more important appropriations bills later this year, they also concur that

these are unlikely to exceed a billion dollars, even though they may severely impact a few individual programs with high electronics content.

**The future.** In a new and detailed forecast of defense spending in fiscal 1975 and beyond, the Brookings Institution foresees a likely need for a supplemental defense appropriation in the coming year to counter \$1.4 billion in unanticipated inflation. It predicts that in five years, the nation will require nearly \$111 billion annually for defense to achieve Secretary Schlesinger's goal of a more efficient, combat-ready force [*Electronics*, Feb. 21, p. 12]. The Washington-based research institution predicts that figure could soar to as much as \$142 billion if its estimate, based on 1975 dollars, is inflated by 5% a year. In any event, the Brookings Institution analysis—"Setting National Priorities: The 1975 Budget"—forecasts that defense spending will break through the \$100 billion mark by fiscal 1978.

Schlesinger's approach to defense

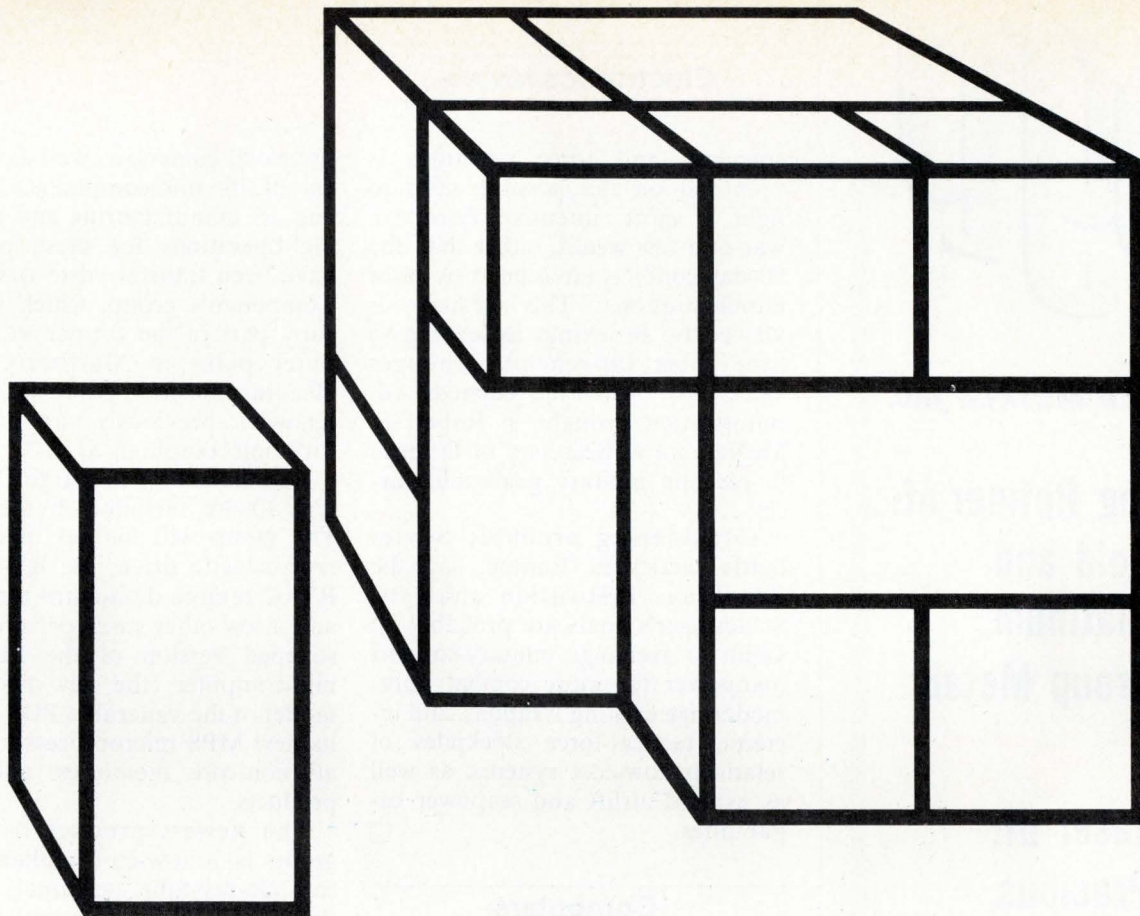

## E-H MODULES FOR SYSTEMS APPLICATIONS

### Building the solution to your measurement problems.

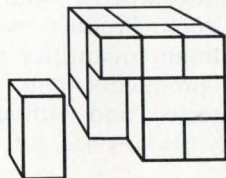

Whether you need one measurement instrument for your systems application or a complete turnkey systems installation—E-H can help. E-H has more experience in building modules for systems applications than any other instrument manufacturer.

E-H pioneered the development of modular, programmable systems elements in 1964 and began building complete test systems in 1967.

Need a programmable pulse generator for an in-house design system? We have eight to choose from, and we'll help you analyze which one is best for your application. E-H is known as the world's leading manufacturer of pulse generators.

Looking for single-shot measurement techniques? E-H opened a new era of single-shot time measurements in 1963 with their Model 142 switching time converter. It's the solution to the problem of making switching time measurements in the sub-nanosecond to one microsecond region in automatic test systems.

Our Model 153 strobing voltmeter makes voltage measurements on fast waveforms at precisely located points in time.

Among the programmable instruments E-H has developed and field-proven for systems use are lines of single-shot measurement modules, word generators, digitizing, and storage modules.

Send for the E-H brochure that has information about modules for systems applications. It will help give you a solution to your systems applications problems.

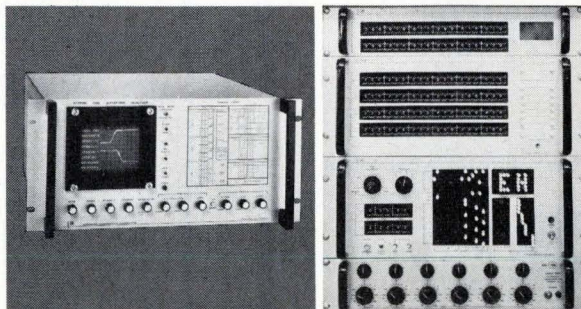

### E-H Research Laboratories, Inc.

515-11th Street, Box 1289  
Oakland, California 94604  
(415) 834-3030



European subsidiary:

P.O. Box 1018, Eindhoven, The Netherlands, (040) 433704

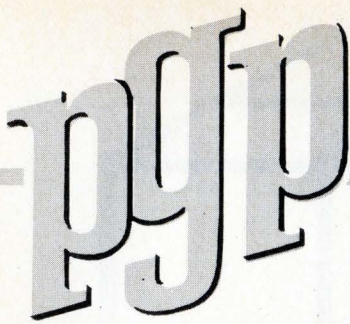

subsidiary of

**GERALD METALS Inc.**

### Leading Refiner of:

- Gold and Platinum Group Metals

### Purchaser of:

- Precious Metal Scrap
- Concentrates
- Solutions
- Catalysts

### Supplier of:

- Bullion
- Sponge

Member:

New York Mercantile Exchange



**industries, inc.**

subsidiary of GERALD METALS INC.

13429 Alondra Boulevard

Santa Fe Springs, California 90670

Tels: (213) 921-7464 (213) 773-7922

New York Office: One Battery Park Plaza  
New York, New York 10004

Tel: (212) 425-4160

## Electronics review

spending and force structures is premised on the possible need to fight a short, intensive European war of a few weeks, rather than the 90-day conflicts envisioned by prior administrations. This strategy is viewed by Brookings as leading to "the most far-reaching changes since 1961," when the Kennedy Administration brought in Robert S. McNamara as Secretary of Defense to reshape military goals and forces.

Considering probable Soviet battle tactics in Europe, say the Brookings Institution analysts, Schlesinger's goals are probably all valid: to exchange military-support manpower for more combat units, modernize existing weapons, and increase tactical-force stockpiles of relatively low-cost systems, as well as expand airlift and seapower capabilities. □

## Computers

### DEC forms group to market peripherals

In a major departure from its previous strategy for marketing small peripheral devices and some other relatively simple products, Digital Equipment Corp. has decided to sell this equipment in quan-

tity to all comers, as well as to buyers of its minicomputers. To this end, its manufacturing and marketing operations for these products have been transferred to DEC's new Components group, which will occupy part of the former RCA computer plant in Marlboro, Mass. Heading the new group is Andrew Knowles, previously vice president for small computers at DEC.

Peripherals for the large DECsystem 10 are included in the move. The group will market the TU-60 tape-cassette drive, the RT-01 and RT-02 remote data-entry terminals, and a few other small peripherals, a stripped version of the PDP-8/A minicomputer (the new two-board model of the venerable PDP-8 line), its new MPS microprocessor board, all non-core memories, and logic products.

The newest product from the group is a low-cost alphanumeric cathode-ray-tube terminal, called the VT-50 DECscope, with an optional printer for hard copy. DEC says the VT-50 will be the lowest-priced such terminal on the market at less than \$900 in quantities of 100 without the printer.

The key offering under the new marketing effort will be what DEC calls "pure iron." Products will be sold in minimum quantities of 50 right off the production line, unassembled, untested, and without inclusion at any field service, software, or training. □

### MOS 1974 sales are forecast to hit \$800 million

The most bullish forecast for 1974 MOS sales comes from Benjamin M. Rosen, of Coleman and Co., New York securities firm. Rosen surveyed 13 semiconductor manufacturers and came up with a projection of \$800 million, up from \$482 million in 1973. The total includes \$290 million in MOS-memory sales. Rosen predicts total semiconductor sales for the year at \$2.8 billion.

He also ranks semiconductor firms in MOS sales. Rosen's pro-

jected top five for 1974 are Intel, with an estimated \$120 million; Texas Instruments, \$90 million; American Microsystems, \$87 million; Rockwell Microelectronics, \$80 million, and Mostek, \$60 million.

In MOS-memory sales for 1974, Rosen projects Intel as the leader with \$118 million; Mostek, \$36 million; American Microsystems, \$26 million; National Semiconductor, \$20 million, and Advanced Memory Systems, \$12 million.

# BURROUGHS DISPLAYS

## CAN TAKE IT!

Burroughs gas discharge display panels are designed to stand up under the toughest operating conditions of shock, vibration, humidity, and temperature extremes ranging from  $-40^{\circ}$  to over  $+185^{\circ}$  F. Burroughs display panels are capable of withstanding the real-world conditions so often encountered in automotive, aircraft, instrumentation, consumer, and industrial applications.

SELF-SCAN<sup>®</sup>, PANAPLEX<sup>®</sup>, and SELF-SCAN BAR GRAPH displays have no moving parts, no internal welds, and require a minimum of external connections (only 8 connections for a dual SELF-SCAN BAR GRAPH, 16 connections for a 16- or 32-character SELF-SCAN display, and 17 connections for a full 9-digit PANAPLEX display). Gas-discharge technology has

proven long life through years of rugged use.

These bright, sharp, clear, high-contrast displays are a pleasing neon-orange color, making them a comfortable display to read, even for extended periods of time.

SELF-SCAN display panels are the ideal man-machine links for displaying 16 to 256 alphanumeric characters for information display systems.

PANAPLEX display panels are for 4 to 16 numeric character applications, and can include arithmetic symbols and alphanumeric characters for systems requiring constant or intermittent display of data, such as calculators, clocks, and recording instruments.

SELF-SCAN BAR GRAPH analog displays present information in analog form with digital accuracy for the measurement and display of speed, torque, temperature, pressure, force, acceleration, and other control or information parameters.

SELF-SCAN, PANAPLEX, and BAR GRAPH display components are attractive, easy to read, compact, versatile, and are ideally suited to the new generation of information display requirements.

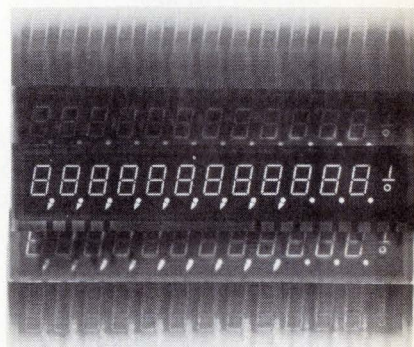

*For complete technical details and applications engineering recommendations, write or call Burroughs Corporation, Electronic Components Division, P.O. Box 1226, Plainfield, N.J. 07061 or call (201) 757-3400 or (714) 835-7335 in California.*

**Burroughs**



Circle 53 on reader service card

**Go slower** and make it simpler. This is the essence of the guidelines delivered by the director of Defense Research & Engineering earlier this year to Army's SAM-D program and its prime contractors, Raytheon Co. and Martin-Marietta. The policy follows a stinging criticism last year of the air-defense-missile system's rising costs and complex technology [July 19, 1973, p. 74]. Since the review by the General Accounting Office, economic watchdog for the Congress, SAM-D has been slowed, even though its R&D funds are about unchanged from Pentagon requests. Budgeted at \$194.4 million for fiscal 1974, which ends June 30, the project is expected to get about \$100 million of the \$111.2 million sought by the military for fiscal 1975. How much the program is altered and how quickly it resumes speed on its new course are to be determined by the Defense Systems Acquisition Review Council.

**Remember Viatron** Computer Systems Corp. and its \$40 terminal? The bankrupt Burlington, Mass., manufacturer, which bet heavily on MOS at a time when the technology was not yet mature [Oct. 14, 1968, p. 193], is still having financial problems. The latest turn of bad fortune came when Viatron's Chapter 10 bankruptcy trustee said he couldn't sell the company as a going concern after bids were sought in February. Proceeds of the sale were to be used to pay off Viatron's creditors, whose claims come close to \$20 million—\$15 million of that in convertible subordinated debentures. At the same time, a group of debenture holders presented their own reorganization plan in a Boston Federal court. The plan provides for nearly all creditors to receive a new issue of Viatron common stock as payment. "Priority" creditors—including the Government—would receive cash payments; "nonpriority" creditors—including the debenture holders—would receive one share of a new common stock at 1 cent par value for each \$10 of indebtedness.

**"Installed and growing"** is the way U.S. Customs Service officials describe the anti-smuggling computer network it calls TECS—for Treasury enforcement communications system [July 21, 1973, p. 36]. Now more than 400 terminals, made up of visual displays for baggage inspection at U.S. international airports and automatic send/receive teleprinters at U.S. entry points along the Canadian and Mexican borders, have been installed. They're linked by telephone lines to the TECS duplexed Burroughs 5500 computers at the Customs data-processing operation at San Diego, Calif.

**Two years ago**, semiconductor makers were digging in for the first laps of the great bipolar RAM race [July 3, 1972, p. 65]. There were almost as many processes designed to pack as many bits as possible on the smallest possible chip as there were contending manufacturers. However, there were two basic ways to handle the 1,024-bit TTL devices: oxide-isolation and the standard process. Of the companies announcing oxide-isolated devices, only Fairchild, with its Isoplanar technique, appears to be shipping in volume [Feb. 21, p. 114]—in fact, says the company, the 1,024-bit bipolar RAM is one of its best sellers. Another oxide-isolation version called V-ate, was announced by Raytheon. That company will say only that its process and run rates are the same as they were a year ago—but industry observers hint that Raytheon is experiencing problems with its V-ate process.

**With the People's** Republic of China now displaying a distinct coolness to almost anything American, last year's cautious assessment by the Electronic Industries Association's John Sodolski that new electronics trade with the Chinese would develop slowly seems to be borne out [July 5, 1973, p. 73]. Sources at the State Department acknowledge that the potential for trade in technology has not blossomed as they had hoped following President Nixon's historic visit to Peking. But, as the EIA staff vice-president observed after his mission last year to Kwangchow and the Canton Trade Fair, the Chinese, renowned for their patience, seemed even then to be in no great hurry to acquire American hardware, despite their potentially vast market.

**The big**, fast ECL computers developed by Gene Amdahl's Amdahl Corp. [March 29, 1973, p. 51] will be produced solely by Fujitsu Ltd. in Japan. The company has been one of the financial backers of Amdahl. Deliveries are expected to start in 1976. However, Fujitsu doesn't plan to sell any of the machines in Japan, because they will compete with Fujitsu's own (jointly with Hitachi Ltd.) top-of-the-line computer—roughly three times the speed of IBM's System 370/168. Meanwhile, in Sunnyvale, Calif., Amdahl maintains that a small number of computers will be produced domestically, as will parts that don't involve excessive labor or inventory cost. Fujitsu has already committed \$6 million to Amdahl, and may chip in as much as \$7 million more. Amdahl's other angel is Heizer Corp. of Chicago, whose share is roughly the same size as Fujitsu's.

—Howard Wolf

Intended to bring *Electronics* readers up to date on news stories of the past months.

# Here's a display breakthrough

# New plug-in display modules from Beckman ...buy the numbers



3 digit module

Easy to use

Ready for operation

— horizontally stackable to any length



2 digit module

In readability . . . size . . . and reliability — Beckman Displays lead the way. Now, Beckman pioneers with a brilliant new line of "plug-in" display modules designed for both high and **low** volume applications. And, top convenience.

Circuitry is built in. All you do is apply BCD and voltage inputs: the modules are ready to use. They feature the big 1/2" Beckman Displays that have an even centerline spacing of 0.531". The solid characters are visible at angles up to 130° in bright sunlight . . . easily readable up to 40 feet. Color? The same distinctive orange featured in all Beckman Displays (Red is available with filters).

The basic Beckman SM-850 Series modules include the display, a monolithic decoder/driver and a latch. A companion series even includes a counter. All you really

need to do is apply voltage and BCD input. And you can get the complete 2 digit unit, without counter, for only \$19.50 per digit in single unit quantity. If you order 100 the price is only \$14.25 per digit.

Beckman designed these modules to save you circuit design headaches and assembly time. Whether you use just a few displays or a million, you owe it to yourself to find out more about these neat little black boxes. Get the whole story today. Contact your local Beckman representative or stocking distributor.

**Beckman**<sup>®</sup>

INSTRUMENTS, INC.

INFORMATION DISPLAYS OPERATIONS  
Formerly Sperry Information Displays

P. O. Box 3579, Scottsdale, Arizona 85257. Telephone (602) 947-8371.

## There's more eye appeal in Beckman Displays!

FOR THE NAME OF YOUR BECKMAN DISPLAYS DISTRIBUTOR OR SALES OFFICE

# CALL TOLL-FREE 800-645-9200

(IN N.Y. STATE, CALL COLLECT, 516-294-0990)

# Centralab perspectives

FOR USERS OF ELECTRONIC COMPONENTS



CENTRALAB

Electronics Division  
GLOBE-UNION INC.

5757 NORTH GREEN BAY AVENUE  
MILWAUKEE, WISCONSIN 53201

## When Circuit designs shrink, EMI/RFI problems look bigger

**USCC/Centralab's monolithic ceramic filters have evolved in phase with solid state technology and use of ever higher frequencies.**

MSI and LSI technology have been shrinking the world of electronic instrumentation, test equipment, systems and computers — enabling (and dictating) the use of higher, faster frequencies/speeds. With active circuit elements in increasingly intimate relationship, electromagnetic and electric fields are straying into unwanted places; sharp filtering has to be an important design consideration.

U.S. Capacitor Corporation, the world's leading innovator of monolithic ceramic capacitors and filters, has tracked circuit speed developments with one set of filter parameters in mind: improved attenuation at increasingly higher frequencies, in state of the art sizes and at *affordable prices*. Ceramic Filter evolution has been accelerated at USCC/Centralab. We've made it happen by basic research in dielectric materials and production-engineering of new manufacturing techniques.

Today's products of this evolution are CERAMOLITHIC®

Circle 56 on reader service card

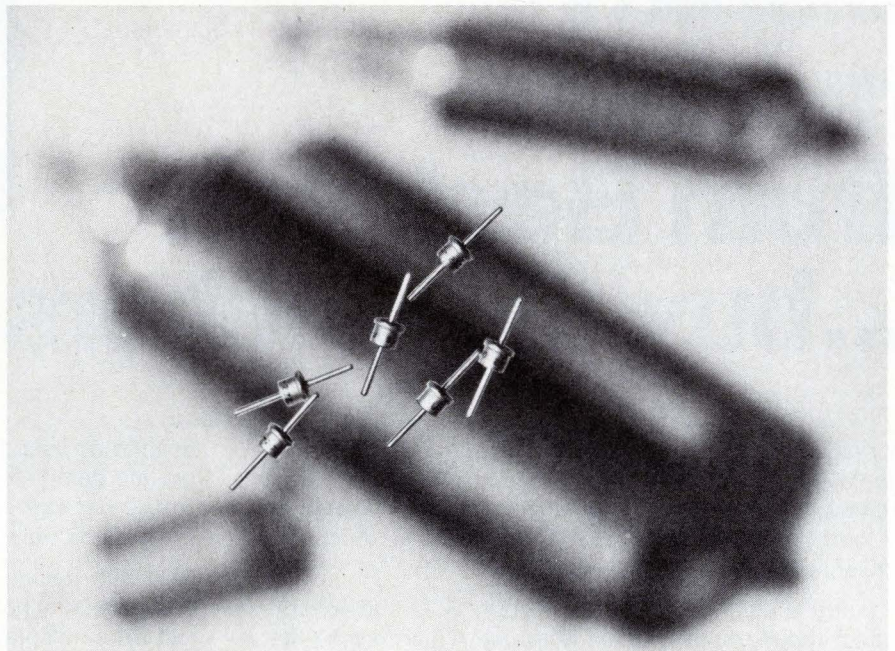

Above is USCC's smallest filter product — the 9900 series feed-thru pictured over larger more costly conventional types.

subminiature EMI/RFI filters like our 3112 — widely used in portable communications and in microwave applications. Or our 9900 series feed-thru's giving better than 70 db at 10GHz in only a .110" x .156" diameter case size — for use in medical electronics and CATV.

Where does filter evolution lead tomorrow? In these pages, in the next couple of months, USCC is going to introduce a whole new concept in ceramic filters — with reliability and pricing in mind.

Meanwhile, our new 1974 filter catalog may be useful. Write for one or call Don Thommen direct, (213) 843-4222 to discuss your filter applications.

At USCC Centralab, the filter evolution is tracking your design requirements; EMI/RFI problems just won't look very big.

USCC

USCC/Centralab



Electronics Division • Globe-Union, Inc.  
2151 North Lincoln Street • Burbank, California 91504  
(213) 843-4222 • TWX: 910-498-2222



## Centralab perspective:

### Pushbutton line switch.

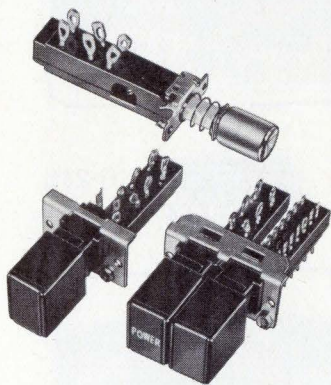

### Mounts in any station.

With Centralab pushbutton switches you can have a line switch that's the same size as a standard six pole module and is interchangeable with other modules in an assembly. For push-ON, push-OFF operation . . . rated 5 amp/125 VAC (CSA).

Other pushbutton switch features include:

- 10, 12.5, 15, 17.5 and 20 mm spacing options.
- Epoxy sealed terminals.
- Interlock/lockout variations.
- 25 button styles and 18 colors.

Write Centralab for  
Bulletin 1550.

\*Isostat licensed



Circle 122 on reader service card

## Centralab perspective:

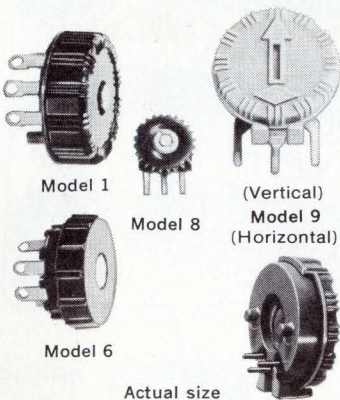

### Miniature pots at a mini-price.

Centralab gives you more to choose from in miniature potentiometers. Take the 1/8 watt, 45/64" dia. **Model 9** for example. Typical pricing, in production quantities of 1000, is 34¢. That's economy because you also get:

- Rotational life in excess of 25,000 cycles.
- Choice of mountings — perpendicular or parallel plug-in.
- Resistance Range—100 ohms to 10 megohms.
- Adjustability — Knob edge or screwdriver slot.
- Tolerance —  $\pm 20\%$

For quantities under 250 contact your local Centralab Distributor.

Three other miniature potentiometers in the Centralab line of standard controls are:

- **Model 1** — 5/8" dia. 1/8 watt (Available with switch)
- **Model 6** — 1/2" dia. 1/10 watt (Available with switch)
- **Model 8** — 9/32" dia. 1/10 watt

Get complete specifications on all four. Write Centralab for Bulletin No. EP2184.



Circle 123 on reader service card

## Centralab perspective:

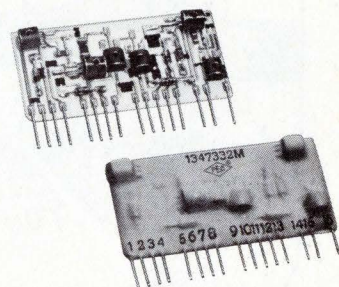

### Two thick film hybrid systems. PEC and MEC.

Centralab offers the flexibility to design and fabricate thick film modules to fit virtually any application and cost parameter.

Low-cost silver/carbon or  systems for consumer applications:

- Resistor Range . . . . . 10 ohms to 10 megohms
- Resistor Tolerance. . .  $\pm 10\%$  preferred minimum
- Ratio Matching . . . . .  $\pm 5\%$  minimum
- Capacitor Types. . . . . Ceramic and tantalum
- Active Devices. . . . . Diodes, transistors & IC's
- Operating Temp. Range. . .  $-55^\circ\text{C}$  to  $+85^\circ\text{C}$

Noble metal/cermet or MEC systems for commercial and industrial uses:

- Resistor Range . . . . . 3 ohms to 3 megohms
- Resistor Tolerance. . . . .  $\pm 5\%$  minimum
- Ratio Matching. . . . .  $\pm 1\%$  minimum
- Capacitor Types. . . . . Ceramic and tantalum
- Active Devices. . . . . Diodes, transistors & IC's
- Operating Temp. Range. . .  $-55^\circ\text{C}$  to  $+190^\circ\text{C}$

For Bulletin 1547 write A.R. Wartchow, Manager, Electroceramic Marketing, Outside U.S.A. contact J.H. Meunier, Manager, International Sales.

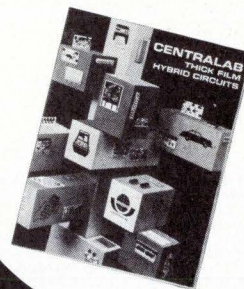

Circle 57 on reader service card

# YOU HUM THE TUNE, EXAR PLL WILL SING IT



XR-2567



XR-210

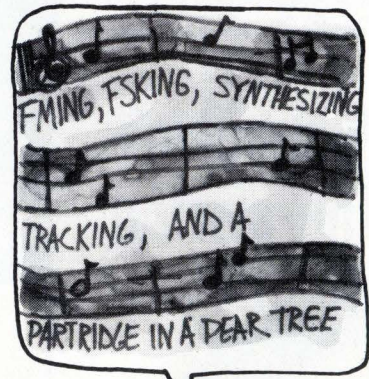

XR-215



XR-567

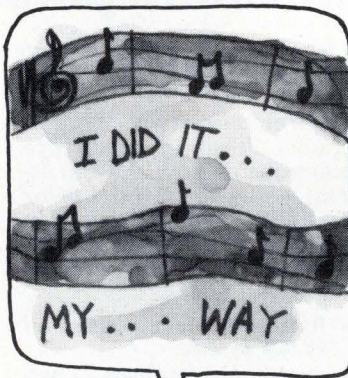

XR-S200



Exar PLL

We have the broadest chorus line of Phase Lock Loop circuits available today. Take a brief look at our ever-expanding PLL line:

The XR-210 is designed for FSK Modulation and Demodulation and features a self-contained output logic driver, compatible with RS-232C requirements.

Use the XR-215 for FM or FSK demodulation, frequency synthesis and filter tracking. It has a 5V to 26V supply range and 0.5 Hz to 35 MHz frequency bandwidth. What's more, it's bipolar logic compatible.

The XR-S200 is a do-it-yourself building block. With this you design your own PLL circuits by selecting external connections and components. You get instant pro-

totypes with minimum fuss and costs.

Moving right along . . . the XR-567 PLL is designed for tone and frequency decoding. It has a bandwidth adjustable from 0 to 14%, sinks up to 100 mA of load current and has a logic compatible output. Our dual version, the XR-2567, is a real hummer with even better temperature tracking and matching characteristics. Power supply rejection is improved by an order of magnitude over the single version. The dual outputs can switch up to 100 mA at 26 volts.

All together now. We would like to send you the complete musical score on our PLL products. Our data sheets are good and they're filled with applications data. Write now, write.

## EXAR SPEAKS YOUR LANGUAGE



### EXAR INTEGRATED SYSTEMS

A Subsidiary of R-ohm Corporation 16931 Milliken Ave., Irvine, CA. 92705 (714) 546-8780 TWX 910-595-1721

**EXAR SALES REPRESENTATIVES** Alabama, Georgia, Mississippi, North Carolina, South Carolina and Tennessee: K & E Associates, Kennesaw, Georgia (404) 974-4264 Arkansas, Louisiana, Oklahoma and Texas: Evans-McDowell, Dallas, Texas (214) 238-7157 California: De Angelo, Rothman and Co., Culver City (213) 398-6239, Logan Sales Co., Redwood City (415) 369-6726 Connecticut, Maine, Massachusetts, New Hampshire, Rhode Island and Vermont: Com-Sale, Waltham, Massachusetts (617) 890-0011, Meriden, Conn. (203) 634-0179 Indiana, Kentucky and Ohio: McFadden Sales, Columbus, Ohio (614) 221-3363 Idaho, Oregon and Washington: SD-R<sup>2</sup> Products & Sales, Bellevue, Washington (206) 747-9424 Illinois and Wisconsin: Mar-Con Associates, Inc., Skokie, Illinois (312) 675-6450 Maryland, Virginia and Washington, D.C.: Rep-tron, Inc., Silver Spring, Maryland (301) 593-4844 New Jersey (South) and Pennsylvania: Harry Nash Associates, Willow Grove, Pennsylvania (215) 657-2213 New Jersey (North) and New York: MOS Associates, Floral Park, New York (516) 694-5923 Canada: Harvard Electronic Sales, Laval, Quebec (514) 681-1400 **EXAR DISTRIBUTORS** California: EEP Corporation, Culver City (213) 838-1912, Intermark Electronics, San Carlos (415) 592-1641, San Diego (714) 279-5200, Santa Ana (714) 540-1322 Colorado: Intermark Electronics, Denver (303) 936-8284 Indiana: Graham Electronics, Indianapolis (317) 634-8202 Massachusetts: Gerber Electronics, Dedham (617) 329-2400 Washington: Intermark Electronics, Seattle (206) 767-3160

## Sea tests planned for laser weapon against missiles

In an apparent effort to develop a ship defense against attacks by such low-flying cruise missiles as the Soviet Styx, the U.S. Navy plans to take a high-energy laser weapon to sea in fiscal 1975 for development testing. Some details of the classified R&D program were disclosed in heavily censored Navy budget testimony published late last month by the House Armed Services Committee. **Assistant Navy Secretary for R&D David S. Potter and Navy R&D boss Vice Admiral W. J. Moran indicated some details in their testimony, however, including plans to test the laser aboard a 10,000-ton utility vessel.**

The requirement for ocean-testing, rather than in a laboratory simulator, was justified by a variety of reasons. These include the need to accurately determine the effects of shipboard motion, as well as the high humidity, dense atmosphere, and other weather conditions "right on the surface of the sea" that could produce "thermal blooming . . . all sorts of things that could distort the path" and break up the laser beam, Potter explained. **Industry sources estimate program cost to be about \$20 million in 1975. Most will go for ship operations if the project is approved in upcoming appropriations.**

## Saving claimed for electronic switch at ECC hearings

Federal Communications Commission hearings on Phase II of its AT&T investigation covering the company's performance are expected to continue into mid-July, say commission sources. Examination before Administrative Law Judge David Kraushaar is proceeding at a slow pace. **The phone company seems to have successfully rebutted FCC trial-staff claims in the latest hearings that Bell acted with undue haste and incurred unnecessary expense** by pushing ahead with installation of its electronic switching systems (ESS) in central offices without performing extensive field trials first.

**AT&T Long Lines president Richard Hough claimed that installations of ESS hardware, developed at a cost of \$400 million, are already producing direct annual savings of some \$220 million through automation of telephone traffic.** Moreover, Hough cited uncounted indirect economies from the elimination of construction costs that would have been incurred in building new space for the larger and older No. 5 crossbar equipment that ESS is replacing.

**FCC staff criticisms were developed "without standards or guideposts" and offered only *ex post facto*, observed Judge Kraushaar.** No denial of AT&T's development costs as part of its rate base is expected.

## Addenda

General Electric Co., engine supplier for the USAF B-1 bomber now being built at Rockwell International Inc., is disheartened by DOD's acknowledged \$1.7 billion overrun in the first R&D models: **GE planners are forecasting fewer B-1 engine sales than the 244 planes the service says it wants to buy**, even though the first B-1 flight has now slipped to late fall and the plane is still overweight. . . . **DOD's cost estimates say inflation in the last half of 1973 was responsible for \$2.5 billion of a \$7 billion increase** in 55 key weapons systems that pushed their total price up 5.5% to \$134.2 billion. Of 15 weapons individually identified in DOD's list of six-months' cost increases, the Army's SAM-D air-defense missile being developed by Raytheon Co. showed the biggest inflationary gain—more than double—to \$417 million.

## How industry views TV-set fires

*Reports of an increasing number of fires in television receivers caused the Consumer Product Safety Commission to put TV near the top of its priority list and schedule testimony on the issue late this spring. Manufacturers sought to rebut some of the reports with an analysis prepared by the Electronic Industries Association's Consumer Electronics Group. The industry position has some interesting points, so here are some excerpts from that report by EIA/CEG's special counsel, J. Edward Day.*

**—Ray Connolly**

There are approximately 117 million TV receivers in use in the United States at the present time. Of these, approximately 64.5 million are black and white and approximately 52.6 million are color. Statistics on numbers of fire or shock incidents claimed to be attributable to TV receivers [88 per million 1970-71 models sold, of which EIA verified 40; 56 per million 1971-72 models sold, of which EIA verified 26; 44 per million 1972-73 models sold, of which EIA verified 20] must be placed in context by relating them to total sets in use: 110 million in 1972; 100 million in 1971; 92 million in 1970. The number of color sets in use was only 10 million in 1966 and in 1972 was up to 45.4 million.

We do not claim that we have reached perfection. We have been ready ever since this commission was appointed to sit down and discuss any ideas this commission might have to still further improve television safety. We have never needed repeated waves of scare publicity and sensationalizing of this complex problem to make our industry concerned and active about safety on a priority basis.

### The events chain

When this commission issued its priority list last summer, TV receivers were well down the line and were not scheduled for early action. Then, two things happened: First, several fires took place, by coincidence all in northern New Jersey, where it was claimed that the source of the fire was a TV receiver. These tragic incidents gave rise to extensive and frequently repeated waves of publicity. The first of these fires took place in New Jersey Jan. 1, 1973. Here is what the report of this commission's staff said about that fire: "We established the exact identity of the set (it was not an 'instant-on' type); however, we were unable to determine the repair history or to prove that this TV set started the fire."

The second thing that happened in our situation was that, pursuant to the (Consumer

Product Safety) Act, various companies began filing with the commission reports of potential defects in particular models. In many of these cases, as a result of having time for more thorough investigation after the report was filed, the actual number of potentially defective sets turned out to be much lower than the larger number originally reported.

As a result of these developments, the commission put TV near the top of its priority list.

### The statistics

We realize the commission is still new and is still in the process of developing and improving its statistical and investigatory methods.

For example, in the Federal Register [hearing] notice you include a list of "17 consumer complaint letters on TV-related accidents." In one of the so-called "accidents," identified as happening in San Jose, Calif., all that happened was that a man from San Jose wrote to the Federal Communications Commission, said that he had seen an ad for a TV-tube tester, and questioned whether such a tester was safe.

As another example, the notice refers to a survey of TV-related fire reports by your field offices. We visited one of these offices to see how the survey was made. We found that in not even one of the cases reported by this particular field office could your investigators locate any information at all to indicate the TV set was the cause of the fire. The local fire department reports had merely said a fire "began near the TV," but said nothing as to the cause of the fire. But in the commission's notice this was escalated into a "TV-related fire."

In the notice you refer to data on what is labeled "TV-related accidents" collected through your National Electronic Injury Surveillance System. In the case of one of these incidents, here is what the commission's staff report shows: "Victim had placed a kitchen knife on top of TV set and cut his right arm on the knife while adjusting the antenna."

But aside from such questions about the statistics, the really important thing is to realize that in considering TV safety we are dealing with a dynamic, evolving technology. It is not a situation where absolute perfection can be easily and immediately achieved.

We have never objected to having a Federal mandatory standard for TV receivers. We have urged and do urge that procedures for formulating such a standard be started without delay. We also urge that such standard include uncomplicated procedures for revision to recognize the fact that achieving maximum safety for a complex product is not a static process.

# S-D's ATE system saves you **\$75,000/year\***

## But the best reason for buying it is **MUSDBASIC.**

What's MUSDBASIC? It's the **only** ATE software system in existence that allows you to write and de-bug programs while performing actual testing of PC boards and instruments. We call it Multi-User S-D BASIC. It's an English test language that took two years to perfect.

The beauty of all this is that only **one** 3600 series CATSystem is needed to write programs and test simultaneously. That's because S-D's multi-user BASIC provides two terminals for time-sharing the entire system, including the instruments. Also, up to 6 more terminals can be added with this time-sharing feature.

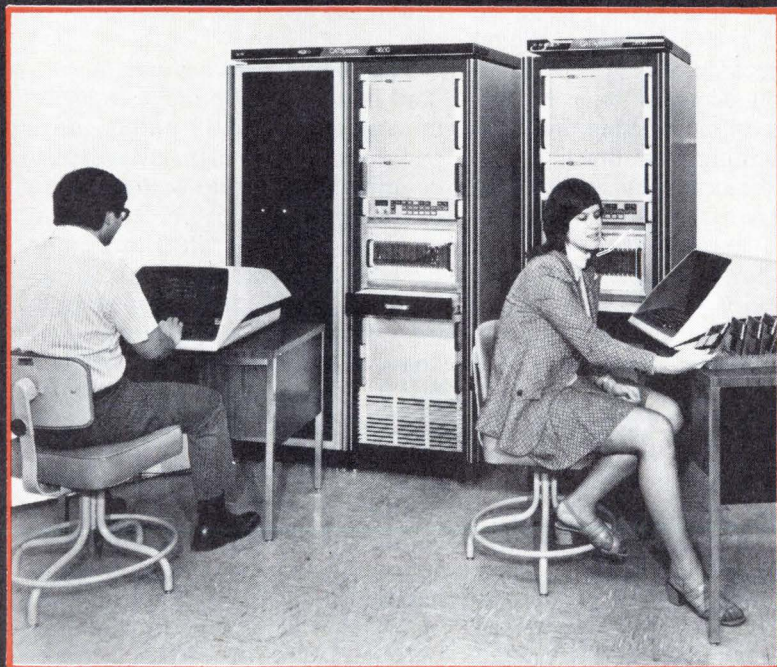

HE PROGRAMS WHILE SHE TESTS. ONLY WITH CATSystems.

It's no secret that many ATE systems take a year to put into operation because programs can't be written while testing goes on. Who wants to write programs at night or on weekends?

State-of-the-art S-D CATSystems feature off-the-shelf test instruments and the powerful PDP-11 computer for field-proven reliability. Every CATSystem has a wide bandwidth input adaptor system with quick, easy disconnect—and with zero force.

In fact, you'll save more than the \$75,000 we propose. The \$75,000 is just the amount you save on a CATSystem **without** MUSDBASIC!

For full details on CATSystems, contact your Scientific Devices office or Bob LaPointe at S-D, 10 Systron Drive, Concord, CA 94518. Phone (415) 676-5000. In Europe; Munich, W. Germany; Leamington Spa, U.K.; Paris (Le Port Marly) France. Australia: Melbourne.

\*Based on manual vs. CATS testing of 60,000 PC boards (200 types). Manual testing costs \$99,800. CATS \$25,000. Price of CATSystem used in this study (yours for the asking) \$97,500.

SYSTRON  DONNER

Circle 61 on reader service card

## SGS-Ates packs 20 watts into IC audio amplifier

**With the ease** of a soprano trilling up the scale towards high C at Milan's famed La Scala opera house, Italy's leading performer in semiconductors—SGS-Ates—keeps running up the power ratings for its audio integrated circuits.

SGS-Ates' latest audio IC package—which is, as far as the company's market watchers know, the power pacesetter at the moment—puts out 20 watts typically, with supply voltages of  $\pm 17$  volts and a load of 4 ohms. And it's not just raw power. At the 20-w output, harmonic distortion is only 1%. At 10 w, the distortion drops to 0.1%.

"We are trying to push power levels for low-cost hi-fi phonographs up from 5 w to between 10 and 15 w," says Raimondo Paletto, the company's technical director. SGS-Ates has set a quantity price of \$3 for the new package, designated the TDA 2020, and Paletto expects it will help open a new market—quality sound at 10 w or so from unit audio sets with manufacturers' price around \$100. The company has started pilot production of the IC and figures to get into full-scale production during the second half of 1975. Later, there'll be an industrial version, the LO 68, for such applications as small-motor drives.

To reach high IC power, SGS-Ates parlayed its plastic packaging expertise with a slick layout for elements on the chip. Crucial to the package concept is the technique used to solder the chip—100 by 70 mils—directly onto a copper-slug heat sink running the length of the package.

Paletto won't say what the composition of the solder is. But at the late-May Internepcon/Europa meeting in Brussels, the company's top packaging development man, Walter Fumagalli, said that gold-based solder preforms pointed the way to a "two-fold improvement" on the number of on/off thermal cycles that plastic packages for 20 w

or even 50 watts could withstand.

Other key considerations for the package are the copper for the lead frame and the encapsulating resin. It must have thermal expansion as close as possible to that of the chip-to-frame wire connections, withstand temperature to 150°C, and shrink enough when cured to leave the heat-sink slug's surface slightly

above the rest of the package.

It's the package, then, that let SGS-Ates boost power to a guaranteed rating of 15 w, with 20 w typical. The hi-fi-quality distortion characteristics, though, come from the chip layout—largely the work of Bruno Murari, head of linear IC design for the development department at SGS-Ates. □

### Great Britain

## BBC experiments with digital TV recording

The British Broadcasting Corp. is experimenting with digitizing another link in television broadcasting in what may become the digital revolution of the medium. Having recently developed its own analog-to-digital converter for video waveforms [*Electronics*, Jan. 24, p.53], the BBC now is developing a digital color-TV recorder to store program material on magnetic tape. Results are very good, but the big problems are determining how much digital data need be stored and storing it so that it requires the minimum amount of magnetic tape—all economically and without impairing picture quality.

However, even if these problems can't be solved satisfactorily the recorder experiment will have its benefits. BBC engineers will be able to apply the signal and information processing techniques they develop to eventual optical storage techniques, should these laser and holographic approaches prove competitive with analog tape storage and overtake the development of digital tape storage. And, it should lead to improved error detection and correction.

Among the advantages of digital recording are the use of reliable and

rugged machines that are self-monitoring, says A.H. Jones, head of the storage and recording section of the BBC's research department, Kingswood Warren, Surrey. Also the technique would facilitate copying of programs, aid in program editing, and make for better archival storage.

The digital recorder uses a standard instrumentation tape transport in sampling up to 13 million times per second, using eight-bit words to describe each signal sample while recording 16,000 bit per inch along each of 42 tracks on 1-inch tape. Backing up the transport is some sophisticated circuitry. Each parallel track has its own printed-circuit board to process its signal. Each 7-by-10-in. board carries 49 integrated circuits and six shift registers. The high sampling rate is necessary because of the UK's 5.5-megahertz bandwidth.

For comparison, it would take 400 compatible IBM tape decks to handle the machine's data rate, explains Alan Bellis, who designed the recorder. The recorder may be locked to an external clock, with automatic timing and slew correction. And, most of the disturbances caused by tape dropouts are de-

tected and concealed by processing circuitry.

In a sense, the recorder is two in one because it can replay the signal and then record back again on the same tape a little further on, Jones says, instead of playing from one recorder to another. However, "if something happens in between, you're lost, as you wouldn't have the master tape," he adds.

To achieve high-grade TV recording, the machine uses four times as much tape as an analog system, Jones explains. The big question is whether the digital packing densities can be brought down to where they're competitive with analog. Some improvements can be expected from manufacturers of heads and tapes, but "they may not be good enough," he says.

Another approach is to reduce the data rate in the signal, Jones explains. "We're trying to look for re-

dundancy in the signal itself." This way, a two-to-one reduction is conceivable, Jones estimates. □

---

## Japan

---

### Sony colors its TV gas-discharge panel

Japan's Sony Corp. has developed a prototype flat-screen color television set using gas-discharge matrix panels operating on direct current. When research is completed, the company envisions wall-hung 40-inch TV receivers incorporating circuitry that is simple enough to keep production costs below current levels.

The color prototype was developed after Sony succeeded in building two monochrome sets [*Electron-*

*ics*, Electronics International, Dec. 6, 1973]. The display panel is 0.25-inch thick and measures 7 in. diagonally. The front and rear sections of the panel are glass plates, and the inside surface of the front plate is coated with 60,000 phosphor elements.

The color prototype has a peak luminance of 5 foot-lamberts, a 20:1 contrast ratio, and 48 digitized brightness levels, while monochrome sets thus far developed have a peak luminance of 25 foot-lamberts, a contrast ratio of 40:1, and 32 brightness levels.

Yoshibumi Amano, who is heading the research, says that a number of approaches have been taken by various firms to develop flat panel displays, with most of them employing ac or dc plasma panels. Sony decided on a dc gas-discharge panel because, among other reasons, of the simplicity of the driving circuitry, ease in fabricating large-area displays, and development of a full color display through the use of phosphors.

The two glass plates of the display are separated with barrier ribs, which are formed by means of silk-screen printing techniques. The ribs, which provide a barrier to prevent crosstalk that could be caused by the diffusion of electrons and metastable ions, are made of a black dielectric material, in order to help increase contrast. The 282 anodes and barrier electrodes on the front panel are made by vacuum evaporation, followed by photo etching. The 212 cathodes on the base panel are made by silk-screen printing and electroplating. The space between the glass plates is filled with a gas mixture, predominant components of which are argon and mercury for the color display. Spacing of the two glass plates is 0.1 millimeter.

Display elements are 0.2 by 0.4 mm, and have a 0.5-mm center-to-center separation. There are, in all, 94 color trio stripes and 20,000 stripe elements in the prototype model. Circuitry volume is about twice as large as the monochrome sets, and power consumption is doubled, to 200 watts, with 15 w dissipated in the panel. □

## Around the world

### System speeds telephone ordering of medicine

Although the average German pharmacy has up to 25,000 drugs and medicines on hand, it still must order specific articles from pharmaceutical wholesalers. And all too often clerks make mistakes in noting down the complex terms of medicines, or misunderstandings occur when ordering drugs, especially those that have similar sounding names, over the telephone. Now, equipment that the ITT subsidiary Standard Elektrik Lorenz AG is offering pharmacists may ease those headaches. Tied to the telephone network, the equipment transmits the article's designation, the amount wanted and the pharmacist's address in coded form to the wholesaler. There, the information is punched out either on tape or cards, put into a computer for processing and used to prepare the shipment to the retailer.

The information originating at the retailer is contained on small punched cards that are inserted into the equipment. Information is transmitted, over regular telephone links, by a "two times one-out-of-four" code at 20 characters per second. The equipment, an information terminal no larger than a normal slide projector, was developed at SEL's private communications and data systems group in Stuttgart. The key unit in SEL's approach is the KKL 300 terminal, a card reader available as a non-automatic type at roughly \$1,130 or as an automatic version that costs about \$130 more. The terminal connects to the telephone network via a modem, which rents from the German post office for \$10.50 a month.

The ordering process is relatively simple and largely automated. Assigned to each article and package size are two small, differently colored punch cards, a yellow and a white one, for example. These item cards are kept with the stock of a particular article, the yellow card behind the white one. When the supply runs low, the clerk takes out the white card and puts it into the card reader's cassette. The yellow card alerts other clerks that the article is being ordered. The cards measure 1 by 2 inches and are 0.4 millimeter thick. Their punched-hole codes identify the article, its form, and the weight or amount per package. Up to 180 cards can be inserted into the cassette, which is about 10 in. in diameter and similar to those used in some slide projectors.

# Make the Switch

At the Eastern Division of GTE Sylvania, Make The Switch means becoming involved in the development of the most advanced Computer Controlled Circuit and Message Switching System ever conceived.

On April 16, 1974 the Eastern Division, because of its demonstrated superior technical expertise, was awarded a major communications contract to develop a tri-service computer controlled circuit and message switching system that will for the first time ever . . . permit the switching of digital voice communication.

This next generation system will utilize all applicable current, state-of-the-art technology . . . optimize existing design techniques and in fact will be an outstanding system design and integration achievement.

The selection of the Eastern Division to undertake this major long term program clearly establishes our engineering organization as the world leader in this technology, a technology that has practically unlimited future application.

At the Eastern Division "The Switch" represents the beginning of a new era in the field of major electronic systems programs.

We invite professionals of demonstrated ability in computer controlled circuit and message switching systems and data communications to investigate major career opportunities.

The Eastern Division is unquestionably "the place to be."

**Right now, the Eastern Division is seeking highly qualified professionals with experience in the following disciplines:**

**SYSTEM ENGINEERING  
ELECTRICAL ENGINEERING  
MECHANICAL ENGINEERING  
SOFTWARE ENGINEERING  
MATHEMATICS  
INDUSTRIAL ENGINEERING  
MANUFACTURING ENGINEERING**

Technical areas encompass tactical circuit and message switching systems; data and voice transmission and processing; systems engineering and design; real time systems integration; test planning; simulation; traffic analysis; secure digital voice switching; information processing; and LSI including MOS and CMOS.

**Please forward your resume outlining SALARY HISTORY to E. Paul Costello, GTE Sylvania, Eastern Division, 77 "A" Street, Needham, Mass. 02194.**

**Eastern Division**  
**GTE SYLVANIA**  
INCORPORATED

An Equal Opportunity Employer M/F



## **UK companies join scramble for Marisat market**

**Scrappy Redifon Telecommunications Ltd. and established Marconi are getting set to square off for the British share of the potential shipboard terminal market for Marisat**, the U.S. maritime communications satellite system to be launched by Communications Satellite Corp. in 1975 (see p. 78). Redifon has concluded an agreement to sell radio communications terminals made by AII Systems, Moorestown, N.J., which has performed terminal work for the U.S. Maritime Administration. Marconi is readying its own antenna system, called Arion, for entry when Marisat becomes operational. Both companies peg their prices in the \$50,000 region.

**But the British competitors could face European resistance.** The European Space Research Organization, developing its own Marots maritime satellite for 1977 launch, is highly displeased over the U.S. Marisat effort. It is grumbling over lack of U.S. interest in an internationally-based system, aside from long-standing U.S.-European bickering. However, the UK contributes a healthy share towards Marots, and London is the world's leading shipping center.

## **Scandinavian patrol-boat order spawns hefty sales for electronics firms**

Swedish and Norwegian military electronics firms will share orders totalling an estimated **\$40-50 million for fire control, navigation, and ship-to-ship missile systems that will go aboard 16 patrol boats being ordered by the Swedish navy.** The patrol boats, weighing 140 tons, will be built at Bergens Mekaniske Verksteder in Norway and will be equipped with the Norwegian-developed Penguin ship-to-ship missile system, made by Norway's Kongsberg. The patrol boats will also be equipped with a new 57-mm anti-aircraft cannon developed by Bofors of Sweden, and Swedish fire control systems will be used.

## **Japan's computer subsidies breed new machines**

New computers developed with government subsidies have been announced by two of Japan's three groups of computer manufacturers. The subsidies were offered by the Japanese government in 1971 to induce the six major computer companies to form groups **as part of a plan to permit liberalizing computer and integrated circuit imports, as well as their manufacture by foreign-capital companies, while maintaining competitiveness with IBM and other American manufacturers.**

Nippon Electric Co. and Tokyo Shibaura Electric Co. have announced a small computer and two medium computers, with first shipments scheduled for October. These computers are competitive with IBM's 370/115, 125, and 135. The group's large through ultralarge computers will be announced sometime in the future. The group's new computers feature virtual memory and ring protection. They also make extensive use of firmware. **Much of the software uses techniques developed by Honeywell, but the companies emphasize that the hardware was independently developed by the two Japanese firms.** The machines use TTL and 1-kilobit or 4-kilobit n-MOS devices in main memory.

The Mitsubishi Electric Corp.-Oki Electric Industry Co. group has announced its Cosmo-700 computer, with deliveries to start this December. The machine features virtual memory and set-associative memory with 512-word capacity. It is more a scientific and control computer rather than a general-purpose machine like the other group's.

## **Sonab takes over mobile-communications arm of Sweden's AGA**

Sonab, the Swedish state-owned company that got started in business with an omni-directional stereo loud-speaker for hi-fi systems, takes over the mobile-communications division of AGA on July 1, **paving the way for expanded activity in international markets.** The take-over will mean that Sonab will have about half the land-mobile communications market in Sweden, and will double Sonab's total sales. It will mean that Sonab will expand its product range in communications—today covering primarily land-mobile systems—to include aviation radio. AGA's communication radio equipment sales last year were about \$7 million, while Sonab's total sales—a majority of which is in entertainment electronics—were \$10 million. **Sonab has a well-established international sales operation with 11 sales and services subsidiaries abroad, the latest one being in U.S.** Along with the take-over, Sonab gets a new managing director, Staffan Haakansson, who has been managing director of the AGA mobile-communications subsidiary, AGA Mobilradio AB.

## **Siemens leads in microcomputer systems development**

Siemens AG apparently is the frontrunner among European electronics producers to develop microcomputer systems. **First samples of an eight-bit commercial version based on n-channel silicon-gate technology will become available towards the end of this year or early next,** says Erich Gelder, the company's marketing manager for integrated circuits. The system, from Siemens semiconductor facilities in Munich, is for applications in small office computers and includes read-only and random-access memories, latches, decoders, and a central processing unit similar to and compatible with the 8080 n-channel CPU from Intel Corp., the pioneer in the microprocessor field. Two more systems, a four-bit and another eight-bit version, are also in development, but these, Gelder says, **will be custom-tailored and are intended strictly for Siemens-made EDP and telephone communications equipment.**

## **Addenda**

The small Swiss company Laser Technik AG is off to a strong export start with its new numerically controlled machining laser. LT expects to deliver in June a first unit with a 50-watt carbon-dioxide laser to the French company Lignes Télégraphiques et Téléphoniques, an ITT subsidiary. The second NC laser is also destined for France. It will have a 50-watt YAG laser and go to LCC-CICE, a Thomson-CSF subsidiary. Both companies will use the machines for hybrid-circuit production. . . . Nippon Electric has received U.S. orders for 20 low-noise uncooled parametric amplifiers for communications satellite ground stations. Total price is in order of half a million dollars. Sixteen were ordered by Philco-Ford, and four by Comsat, with Comsat also taking options on additional amplifiers, which have noise temperature of only 55K without the maintenance problems of cooled amplifiers. Nippon Electric earlier exported amplifiers of this type to the Soviet Union. . . . The European Space Research Organization will award a \$226 million contract for the design and development of Spacelab, a reusable manned orbital laboratory, to a German group—ERNO-VFW-Fokker. The six-year contract calls for one Spacelab flight unit, fully qualified and ready for the installation of experiments, by April 1979. Spacelab is due to be launched by the U.S. space shuttle in the 1980s.

## Start with our new Blue Streak™ cable

... it's loaded with features designed to lower your installed costs. For instance, every fifth conductor is color coded for quick identification and the Blue Streak immediately identifies polarity. The unique cable construction permits clean conductor separation for breakouts and easy insertion into connector assemblies. Available in 50 conductors or less — solid or stranded wire — this U/L listed self-extinguishing cable is the perfect companion for the new one-piece connectors.

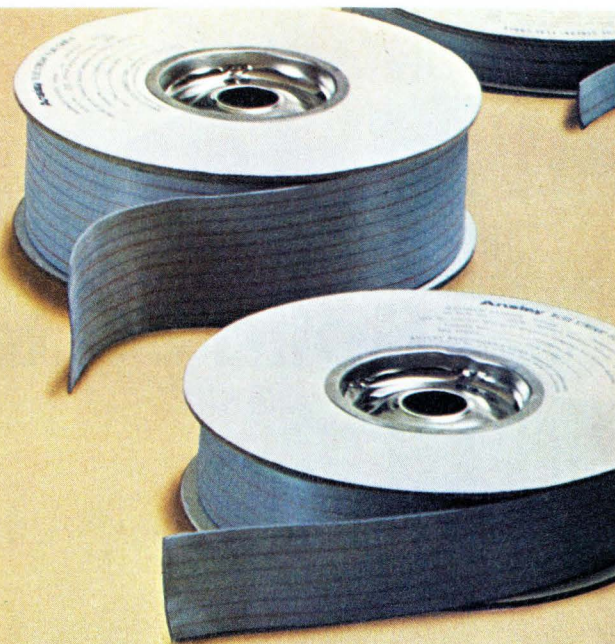

## New cable connector system...It's designed to lower your installed costs.

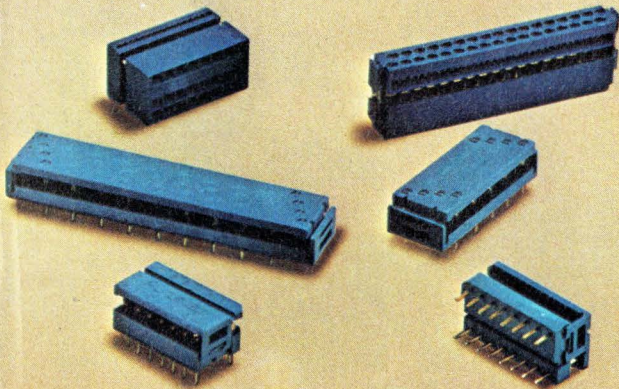

### A perfect crimp every time

... because our Blue Streak hand tools feature the Shure-Stake® principle which makes the tool responsible (not the installer) for the compression connection. Your installer must complete the set compression stroke before the connector can be removed. It's as fool proof and reliable as a compression connector tool can be. A full line of bench mounted tools with interchangeable dies are also available.

The Ansley Team — One Piece Connectors — Shure Stake® Hand Tools and Blue Streak™ Cable — all combine to offer you the most reliable connection package at the lowest installed cost.

# Ansley

ANSLEY ELECTRONICS CORP.  
Subsidiary of Thomas & Betts Corporation 

3208 Humboldt St., Los Angeles, Ca. 90031  
Tel. (213) 223-2331, TWX 910-321-3938

SOLD COAST TO COAST THROUGH AUTHORIZED ANSLEY DISTRIBUTORS.

Circle 67 on reader service card

### Our new insulation displacing flat cable connectors install in 1/3 the time

... simply because they come to you in *one* piece. Two benefits result; assembly of the connector itself is eliminated and the time consuming job of lining up the cable on the connector is no longer necessary.

To install — simply insert the cable end into the connector and crimp. It's that easy — fast — and reliable! Speaking of reliable — our new connectors feature an exclusive "tulip" contact design which provides 4 contact points per conductor. In addition, the front of the "tulip" contact is designed to act as a strain relief on the wire.

We'll be more than happy to send you a test report on contact reliability.



# P&B's reputation is important to you when you need Solid State Time Delay Relays.

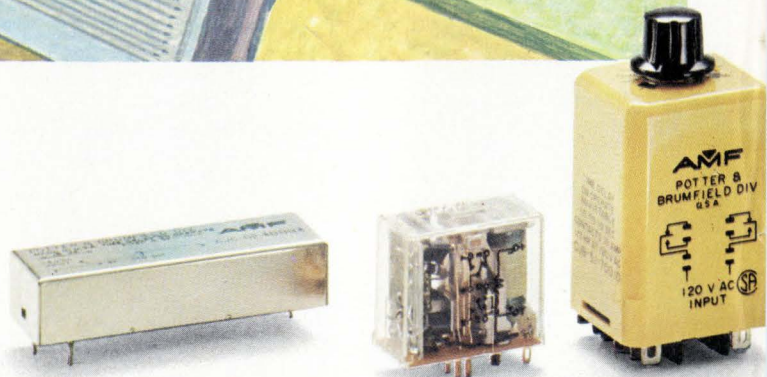

## It's built on quality, design variety, performance and economy.

P&B is the industry's largest producer of solid state/hybrid time delay relays. Types and styles range from low-cost economy models to sophisticated units with excellent performance characteristics.

For precision and versatility, P&B's CD Series is an obvious choice. Within the CD Series are models which feature 7 timing ranges from 0.1 second to 180 seconds, temperature range of  $-40^{\circ}\text{C}$  to  $+55^{\circ}\text{C}$ , recycle time of less than 60 ms and repeatability of  $\pm 1\%$ . And, some models can control up to 25 amperes when used with an external relay.

If economy and small size fit

your requirements, our compact R-13 Series costs less than \$7.00 in quantity. They operate with less than 240 milliwatts of DC power, and are available in 9 timing ranges from 1 to 300 seconds. Other features include fast recycle time, repeatability of  $\pm 3\%$  and contact ratings from dry circuit to 5 amperes.

In between are hundreds of other models and styles offering knob adjustable, external resistor adjustable, or factory pre-set timing cycles. Contact ratings range from dry-circuit to 10 amps, 120 volts AC resistive. They're all available from your authorized P&B distributor.

Should you need a specific solid state time delay relay that we don't offer from stock, we'll design one to meet your requirements. And you'll receive the benefit of our engineering skills and knowledge gained through producing the most reliable relays possible for over forty years.

Our solid state/hybrid time delay relays and all their variations are described in detail in our 226-page relay catalog. For a free copy, simply call your local P&B representative. Or write Potter & Brumfield Division of AMF Incorporated, Princeton, Indiana, 47670. Our telephone: 812 385 5251.



Solving switching problems is what we're all about.



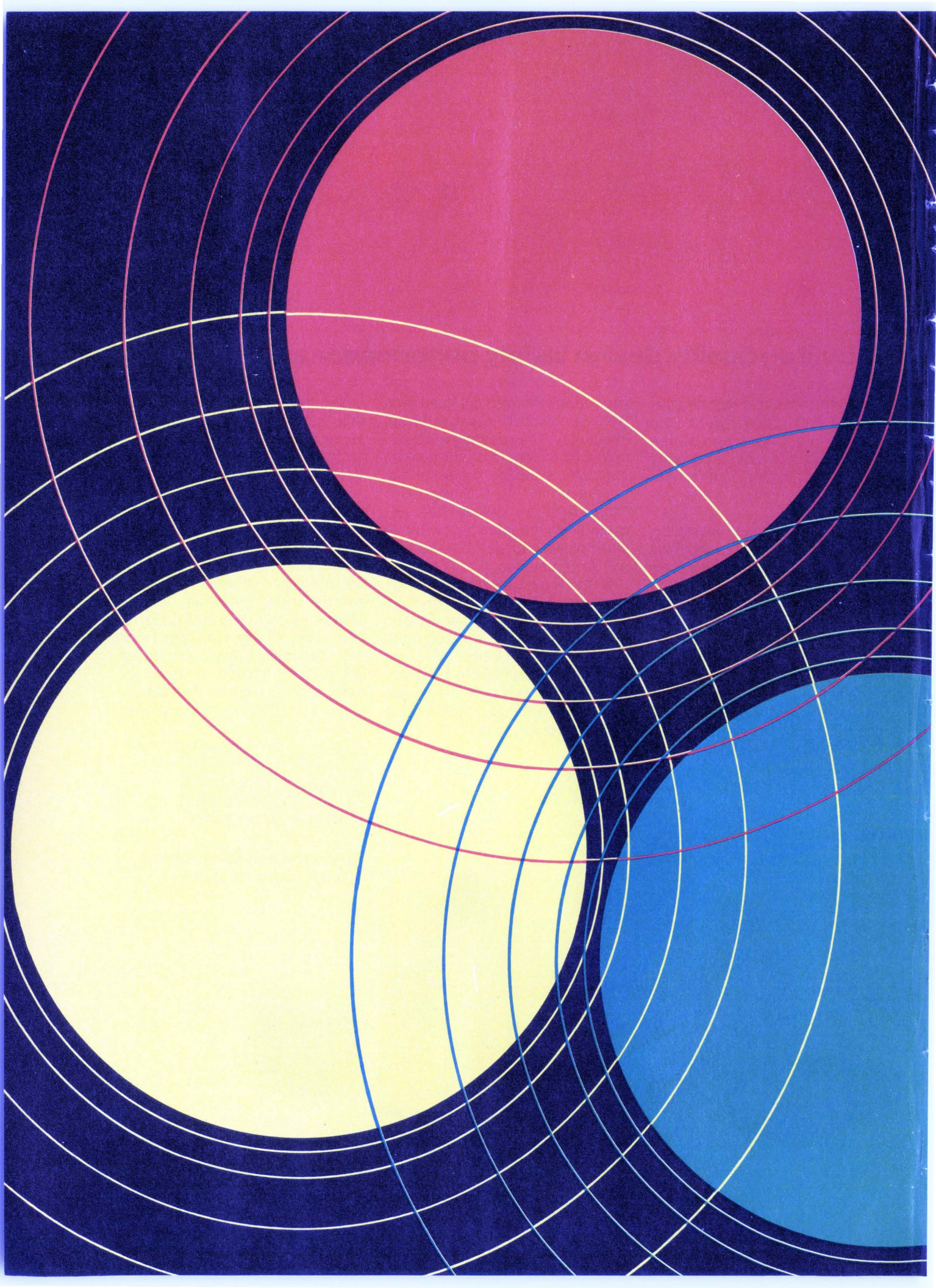

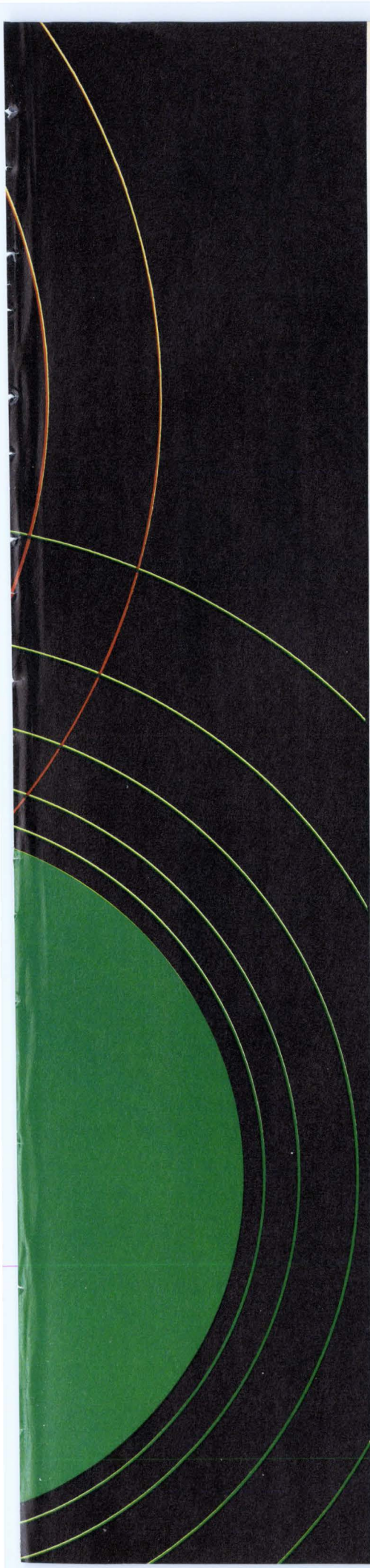

# We got the sun in the morning and volumes of red, green and yellow LEDs at night.

There are bright spots during these days of shortages, crunches and allocations.

LEDs, for instance.

Motorola has volumes of red, green and yellow LEDs in over a dozen different types in 15 different packages.

Enough to keep you supplied for virtually all your panel mount, fault-indicating, high-ambient-light, low-ambient-light, backlighting, instrumentation, industrial control and appliance needs for 1974 and beyond.

We've got volumes because we've got unmatched production capability to supply volumes. People, lines, engineering know-how, piece parts, etc.... all the things we've been noted for in so many other semiconductor successes.

We'd like to show you more. Write for the Motorola Optoelectronic Selector/Cross-Reference Guide. Box 20912, Phoenix, AZ 85036.

Contact your franchised Motorola distributor or factory representative for all the LEDs you need for all the designs you have.

A warm experience...

*obvious*  
**From Motorola, the LED producer.**

# BOURNS NEW LOW-COST DIGITAL DIAL

**COUNT ON IT...  
AND SAVE!**

**\$5.00**  
IN PRODUCTION  
QUANTITIES  
Prices are U.S. dollars, F.O.B., U.S.A.



Bourns new Model H-357 KNOBPOT® Dial is the lowest cost digital turns-counting dial we know of. It's designed for use with ¼-inch shaft (Dia.) precision potentiometers — or other rotating devices. The H-357 is ruggedly made, features exceptional readout accuracy . . . and pairs nicely with Bourns Model 3540 low-cost 10-turn wirewound potentiometer.

Best of all, the H-357 is a BOURNS product . . . and costs only \$5.00 each in production quantities.

**FEATURES INCLUDE:** Rugged, industrial grade construction • Large, easy-to-read numbers • Protective lens covers readout • Readability of 1 part in 2,000 • Readout accuracy of 0.1% • Size (7/8" Dia.) and appearance compatible with Bourns KNOBPOT potentiometer family • Brake available at no additional cost.

Delivery is off-the-shelf. For complete details, contact your local Bourns field office, representative or the Factory direct.



TRIMPOT PRODUCTS DIVISION • 1200 COLUMBIA AVE., RIVERSIDE, CALIF. 92507



CROSS MODULATION VS GAIN REDUCTION

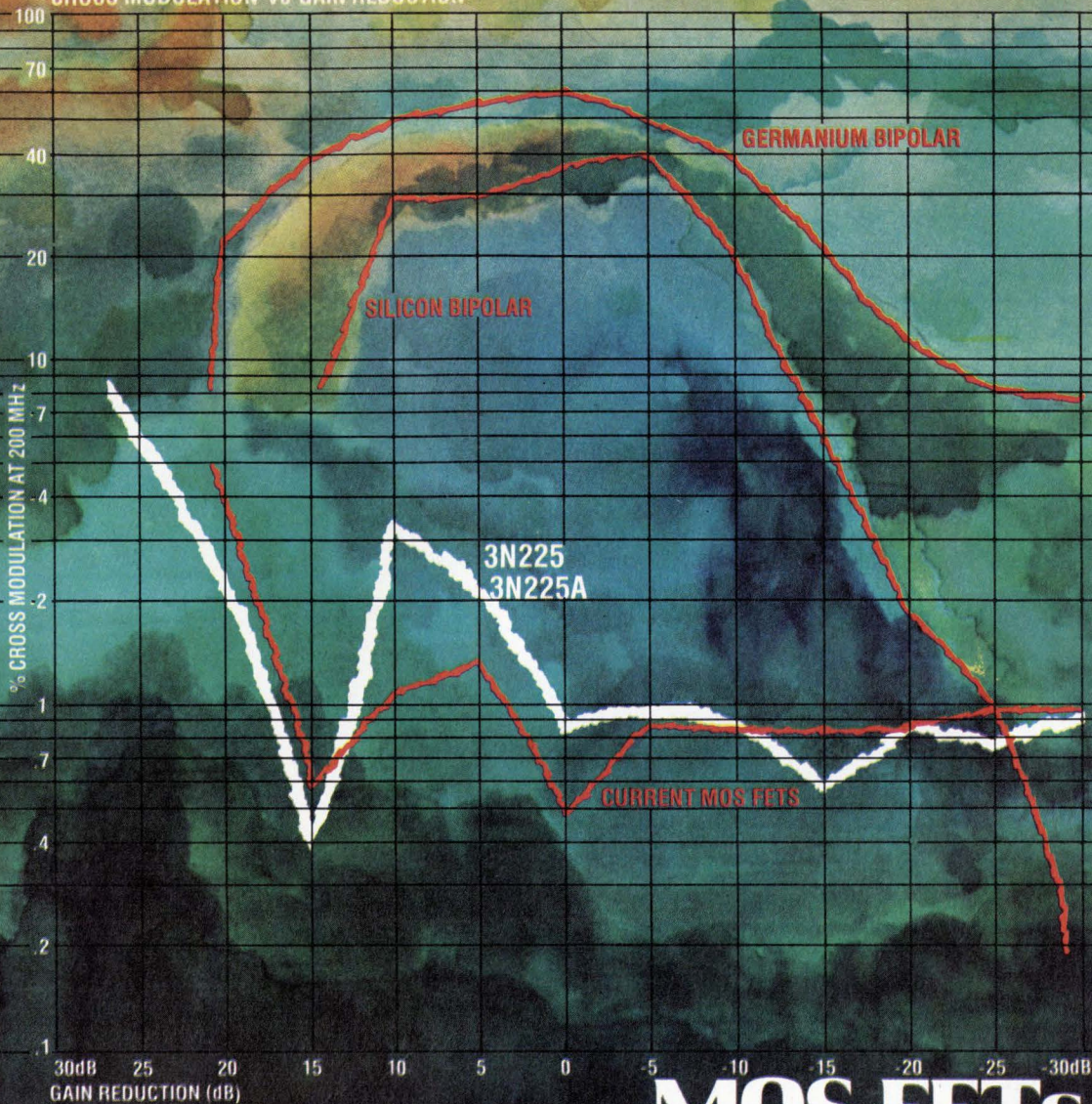

# MOS FETs

**It's like lightning striking twice.**

**TI's new 3N225 and 3N225A**

**...and there's lots more uses for them than just TV.**

900 MHz noise figure—4.5 dB typical. 900 MHz gain—15 dB typical. That's what the 3N225 and 3N225A deliver—consistently and reliably. Virtually nothing in the industry comes close to this capability.

The 3N225 and 3N225A need no special handling procedures either. Integrated back-to-back diodes between gates and source protect against excessive voltage.

And designers also get high stage gain and excellent stability without neutralization—because feedback capacity is so extremely low.

Right now, leading TV manufacturers are designing with 3N225

and 3N225A in a big way. Especially in tuners, IF strips and UHF pre-amplifiers where linear, low noise is really an important requirement. A requirement that includes more applications than just TV, however.

For instance 3N225 and 3N225A can be designed into CATV. Detection alarm systems. Medical electronic devices. Measuring instrumentation. Plate-wire memories. Video signal processors. And all types of mobile and fixed receivers.

Many applications that could only be realized by using vacuum tubes can now use MOS FETs like the 3N225 and 3N225A—often at significant cost savings.

For data sheet, write Texas Instruments Incorporated, P.O. Box 5012, M/S 308, Dallas, Texas 75222.

	Comparative Performance Data							
	45-MHz		200-MHz		450-MHz		900-MHz	
	Gain	Noise Figure	Gain	Noise Figure	Gain	Noise Figure	Gain	Noise Figure
3N201 series	25	1.8	24	2.7	—	—	—	—
3N204 series	30	1.8	24	2	18	3.2	—	—
3N211 series	33	1.8	28	2.2	21	5	—	—
3N225 series	32	1.8	28	2	21	3	15	4.5

**TEXAS INSTRUMENTS**  
INCORPORATED



# SIEMENS

## Brushless DC Motors: Make reliable products more reliable.

Because they're *brushless*, Siemens DC motors last as long as their bearings. Bearings last much longer, too, because there's no brush carbon dust.

Because they're *brushless*, Siemens DC motors can run for 20,000 hours and never cause any trouble. Even if the motors lay idle for a year, they'll start immediately, because no oxidation can take place. Periodic service and replacement is eliminated.

Because they're *brushless*, Siemens DC motors can be used in explosive atmospheres. There's no arcing or sparking.

Because they're *Siemens*, these brushless DC motors are the highest quality and come in the most complete range of power sizes available from stock. Siemens pioneered brushless DC motors. And Siemens will give you the benefit of years of application experience, by advising and assisting you with electronic circuit design for your individual needs.

Your high-quality electronic equipment will benefit from Siemens brushless DC motors. Siemens will show you how. Call or write Siemens Corporation, Power Engineering Division.

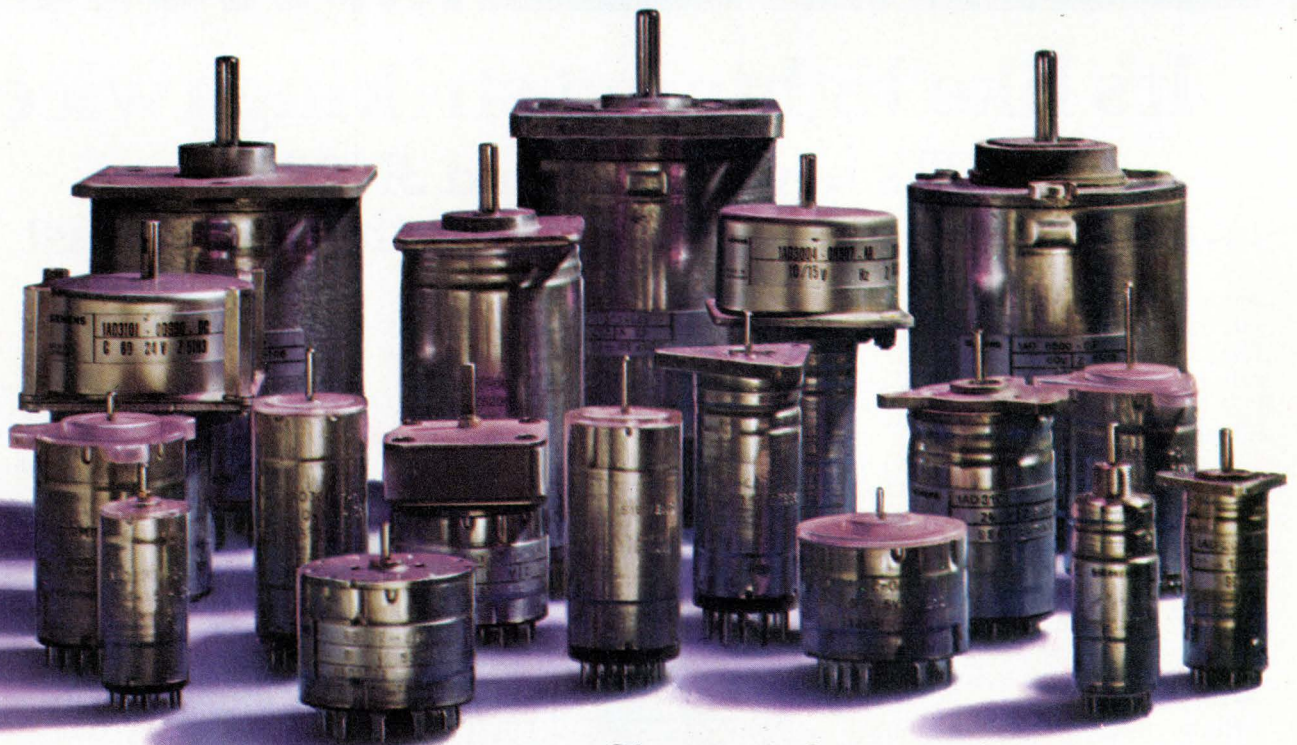

**Siemens Corporation**  
**Power Engineering Division**

186 Wood Avenue South, Iselin, New Jersey 08830 (201) 494-1000

Circle 74 on reader service card

# Probing the news

Analysis of technology and business developments

## Has checkless banking bounced?

Dream of total electronic funds transfer is coming true in bits and pieces, but the big investments in complete systems have yet to be made

by Gerald M. Walker, Consumer Editor

**A cashless society**—that dream of electronic funds-transfer systems (EFTS) so popular in the late 1960s—is still a long way off. Instead, the banking establishment has been nibbling away piecemeal at the task of installing electronic funds-transfer systems. The bankers' euphemism for this less-than-total approach, "evolution rather than revolution," is another way of saying that they're still unprepared to devise total EFTS plans.

Experiments are under way around the country, and some equipment is being installed in an effort to make a dent in the paperwork that accompanies banking transactions (see "That human touch," p.76). To date, those installations have involved mostly simple terminals for such services as:

■ **Direct pay.** Employees' net wages are paid directly by the employer to the bank by means of a single check for all employees banking with that institution. Social Security checks also will be paid in this manner. However, a certain amount of consumer resistance may develop over the practice, since many workers like to feel something tangible in a pay envelope before depositing it. In addition, many workers in the country still do not have bank accounts.

■ **Verification/authorization.** Direct links to retailers and branch institutions verify adequate balances or validity of charge purchases within the limits of credit authorizations. Being the easiest to implement, this service is probably the fastest growing "front-office" feature.

■ **Transfers.** Terminals at locations remote from the computer transmit funds-transfer directives entered by

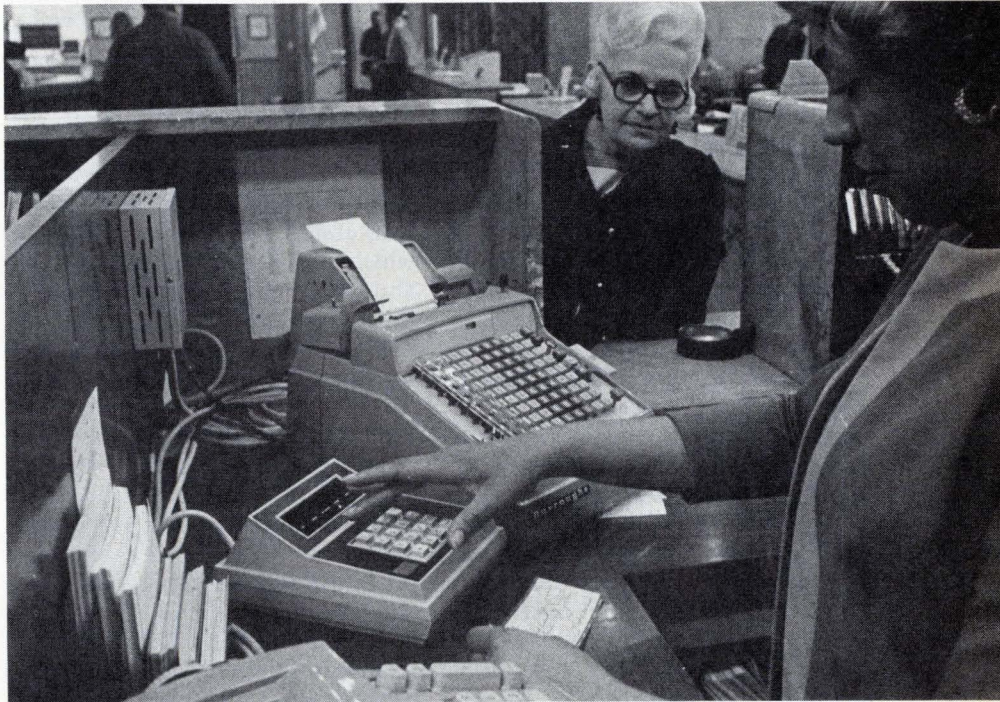

**Going slowly.** Banks are going electronic a little at a time. They are adding such equipment as credit-verification terminals, above, and self-service terminals, left.

## Probing the news

depositors and tellers. Unattended tellers are used for check deposits, savings deposits, cash-dispensing, and other transfers. The jury's still out on these. While the full-service banks have actively promoted remote terminals, there's some belief that consumers use them avidly for a brief time for the novelty, then revert to rather infrequent use.

■ **Bill-paying.** Mortgage, utilities, and other fixed-amount payments are made monthly by the bank, and checks are returned to each depositor after recipients endorse and return them. A variety of variable-amount bill-paying systems are being tested, as well, and all involve pre-authorization. In addition, there's still paper flying around, so some EFTS benefits are lost.

■ **Point-of-sale.** Customers of retail establishments give merchants debit cards (not credit cards) to be used in on-line terminals that record amount and nature of sale, transfer funds to merchants' accounts, and update merchants' inventories, purchasing, and sales accounting records. This is pretty much what's being evaluated in Lincoln, Neb., and is receiving considerable attention from different types of savings banks as they attempt to move in on services offered by full-service banks.

■ **Billing, collection.** Charge accounts, accounts receivable, and credit-card charge-collection systems already are in use in many banks. Eliminating the paperwork and check-processing by such systems would result from conversion of these to on-line, terminal-oriented systems. This, of course, was supposed to have happened some time ago because the paper generated by the credit-card system is about to smother the card issuers. As a result, both National Bank-AmeriCard and Interbank have set up new systems to help speed communications and reduce the lag between credit purchases and payments.

■ **Automated clearing houses.** Checks are processed totally on magnetic media. Magnetic tapes are then exchanged instead of paper. This is the most promising "back-of-

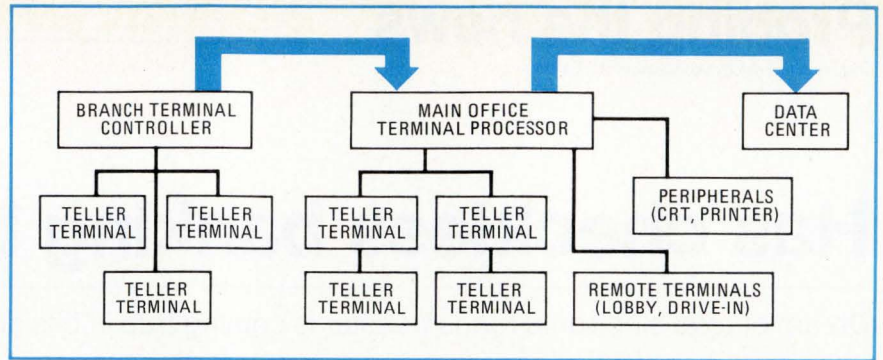

**Mainstream.** This diagram of a typical bank transaction-processing system is one envisioned by a Florida company, Financial Data Sciences Inc. of Orlando.

“fice” move into EFTS, although there have been problems.

**Alternatives.** All of these services are viable alternatives to the traditional means of funds-transfer, and yet they are not fully electronic systems. The reason for the piecemeal effort is essentially the high cost of conversion, and an industry in which full-service banks, savings and loan banks, and mutual savings institutions don't see eye to eye.

Nevertheless, a few simple facts about today's checking system alone foretell the inevitable shift to EFTS. For instance, from the time it is written until it is returned and filed, a check is handled at least 26 times—10 of these times in the bank. It travels by mail, and one man must deliver the check personally. What's more, this check then joins a stream of paper so enormous that, if placed in line with all other checks processed in a single year, the string would make 11 round trips to the

moon at about the same cost. In other words, the cost of the present system will soon outstrip the investment in the radical change.

To cash in on the conversion, several dozen hardware companies are vying for market positions with equipment ranging from plain credit-verification terminals (telephone-communications gear) and remote tellers to back-office computer centers. Few technical problems stand in the way of EFTS. Rather, it's a question of organizing the computers, communications networks, and terminals into workable systems.

In the meantime, the disunited banking industry needs to get some of the Federal regulations governing operations changed significantly in order to realize the ultimate EFTS. And before that happens, a lot more consumers will have to be convinced that electronic solutions are better than today's paper mess. □

## That human touch

When a new branch of a New York bank opened recently in Grand Central Station, large signs outside proclaimed “six live tellers to serve you.” The message was not lost on many of the thousands of commuters who can choose to patronize two electronic tellers at two other bank branches in the same railway station. It was a sort of anti-automation pitch that caused more chuckles than concern: to have a bank knock electronic tellers nowadays is about like having a publisher grouse about computerized typesetting or a garment manufacturer grumble about being forced to cut his cloth by laser.

A far more indicative sign of the times is what took place earlier this year in Lincoln, Neb., where a savings and loan association was granted temporary approval to experiment with cashless purchasing at two Hinky Dinky supermarkets. There, a “debit” card was used to transfer funds from the purchaser's account to the supermarket's account with no service charge for customer or merchant. Results of the experiment are being evaluated.

A similar experiment has been under way in Delaware, and, while participants evaluate the results, other banks across the country may soon follow suit.

# Why Parylene works where other microelectronic protection fails:

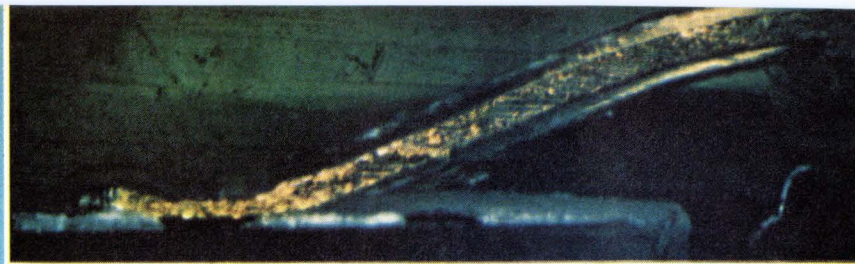

## Crevice penetration in hybrids

This beam lead has a 0.3 mil parylene coating all the way to the weld. Parylene penetrates deep within small crevices, maintaining clearance while putting a coherent coating under beam leaded chips and air bridges. No area is left unprotected, preventing shorts and allowing the designer great latitude in component spacing and sizing. And parylene secures loose debris while preventing breakoff of pigtailed during shock and vibration loadings.

## Controlled conformality

There's a uniform coating of parylene all the way around the half-mil tip of this phonograph needle. That's true conformality, and only parylene gives it, in precisely controlled thicknesses from .002 to 3 mils, in one step. Unlike spray or dip coatings, parylene won't bridge or puddle, or thin out at sharp edges, creating potential failure points. The parylene coating is completely uniform, no matter how dense or intricate the module. And because it's applied at room temperature, there's no component discomfort.

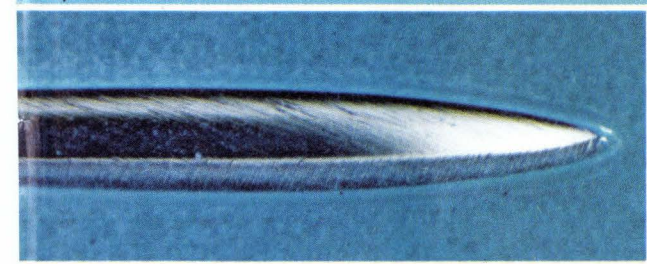

## Lead Strengthening

It took up to 75 grams pull to break these 1 mil wires. Bare 1 mil aluminum wires, for instance, exhibit bond strengths of 3-5.5 grams; coated with 1 mil of parylene, pull strength increases by 60-70 grams.

So wire and bond are stronger, and sideward shorts and loop collapse during extreme g-loads are prevented. Parylene coatings will penetrate the less than 1 mil clearance between beam lead bonded chips and the substrate, giving such strong coating coverage that the chip cannot be lifted without destroying it.

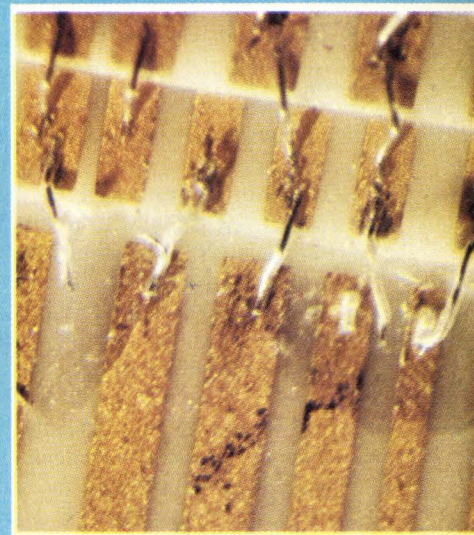

## △200°C thermal shock protection

This hybrid microelectronics relay has undergone 200 45-minute cycles from -120 to 80°C, simulating earth-orbiting conditions. This X-ray shows all leads remain intact. Parylene protection was at work, on the transformer core and then the whole assembly before packaging (TO-116). There was no appearance of corona up to 5000 V<sub>dc</sub>; leakage was reduced from 10μA to <.001μA at 1000V. RTV encapsulation suffered dimensional mismatch, straining and snapping leads, with 500 V/mil bulk breakdown.

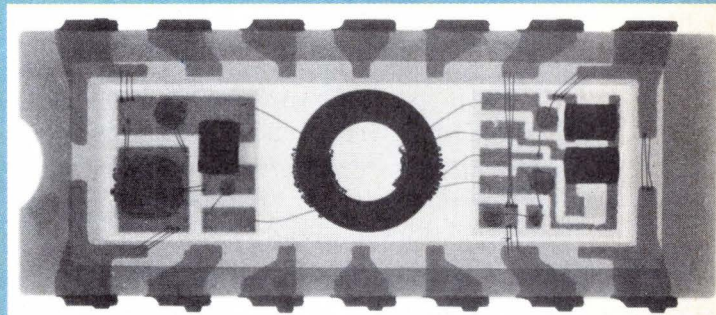

X-ray courtesy NASA Lewis Research Center and Sterer Eng. & Mfg. Co.

## Broad cost effectiveness

These are some of the circuit modules now being protected with a conformal coating of parylene. Because nothing else offers parylene's combined protection against thermal cycling, shock, vibration, humidity, solvents, radiation, ionic contamination. Better barrier protection than liquid coatings like silicones, epoxies, and urethanes. On hybrids you can combine parylene with a hermetic seal for optimum environmental protection . . . and parylene alone will often do the job, and at less cost than hermetic seals. Parylene is compatible with active devices, and meets the tough requirements of MIL-I-46058C. For long term reliability, parylene provides a cost-effective solution.

Union Carbide invented the parylene system. Various patents apply; commercial use of the patented technology is licensed. Write for our 16-page brochure: Union Carbide Corp., 270 Park Avenue, Dept. RFB-65, New York, N.Y. 10017. For instant communication, and information about a trial run at reasonable cost, call Bill Loeb at (212) 551-6071.



In Europe: Mr. H. Torre, Union Carbide Europe S.A., 5 Rue Pedro-Meylan, 1211 Geneva 17. In Japan: Mr. N. Fusada, Tomoe Engineering Co. Ltd., Shin Shin Kai Bldg., 14-1 Nihonbashi 3-Chome, Chuo-Ku, Tokyo.

Circle 77 on reader service card

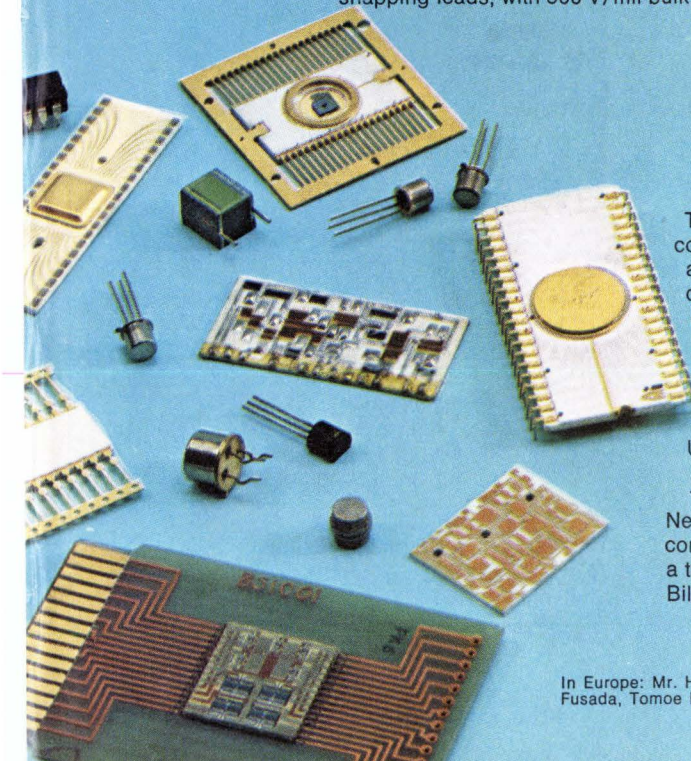

Communications

# Marisat partners seek accord

Commercial partners in maritime satellite disagree on plan for use of voice channel on each of two craft to be launched in six months

by Stephen E. Scrupski, Communications Editor

**The partners** in Marisat are squabbling. Marisat, which consists of two maritime satellites intended to provide reliable, high-quality communications to U.S. Navy and merchant ships, will be launched six weeks apart in a little more than six months—the first on Jan. 9, 1975.

But the consortium partners are still meeting weekly to decide how to divide the small portion of the satellite's facilities that initially will be available for commercial use. Despite their differences, they expect to work out an agreement shortly—even though they don't know if shippers will buy the service.

The controversy centers on access to the satellite's single voice channel. Will the majority (80.2%) owner, Comsat General, have exclu-

sive rights to offer it to users, or will the others—RCA Global Communications (12.5% ownership), Western Union International (4%), and ITT World Communications (3.3%)—have access to the voice channel for a percentage of time equal to their ownership interests? The FCC has issued an order that tends to back Comsat General's view, but the other partners can still suggest alternate plans.

At least one thing is settled: For the first two years, the U.S. Navy will use at least half, and possibly almost 90% of the satellites' facilities for ultrahigh frequency links to its ships. If the Navy does exercise its full option, the satellite's remaining 10%, which will operate in L band, will consist of about 99 full-duplex, 50-baud teletypewriter channels per

bird; it takes about 55 of these channels to make up one voice channel. Comsat General has said that the 99 channels will be allocated according to percentage of ownership. Thus, Comsat gets 79 channels; RCA, 13; WUI, 4; and ITT, 3. With this arrangement, only Comsat could assemble a voice channel; the others would be able to offer only teletypewriter service.

Understandably, the other partners are not enthralled by Comsat General's proposal. In fact, Robert Angliss, RCA Globcom executive vice president, has another plan. Noting that even the 99-channel figure may not be final, he says that RCA would prefer to apportion the total channel-hours by the month so that the minority owners would have access to the two voice chan-

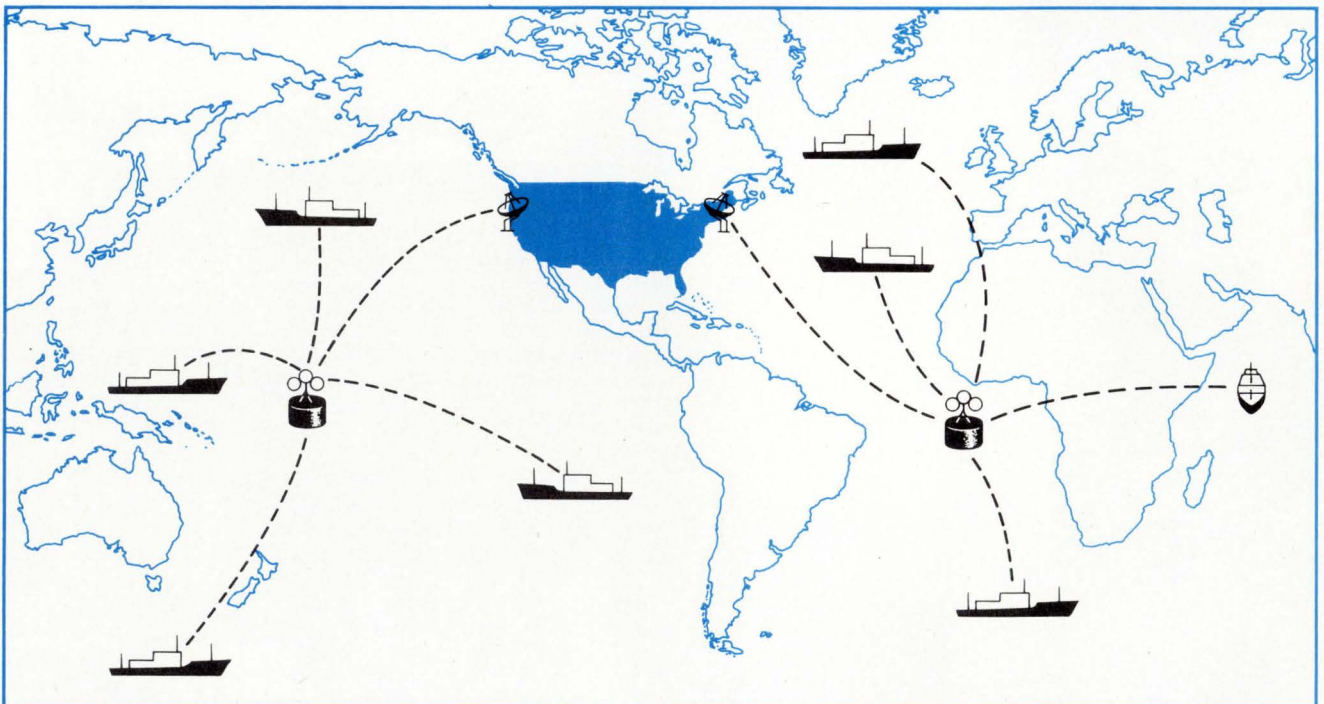

nels at least part of the time. And, if one partner sells more voice time than its allocation calls for, it would compensate the partner that had been short-changed that month.

WUI executive vice president Robert Conn characterizes his company as the "peacemaker" in the dispute, although he notes that he has tended to agree more frequently with ITT and RCA than with Comsat General. "The others are adamant," he says. Conn traces the history of the partnership this way: When the Tacsat and LES-6 satellites expired, the Navy needed a new one quickly and asked for bids from commercial carriers. Comsat General was awarded an exclusive contract. But the FCC stepped in, and, when WUI suggested that the commission order joint ownership, the FCC agreed and told the new partners to work out the details of the system management.

The FCC ruled in late April that capacity should be allocated according to investment and that Comsat General, as the majority owner, should be the system manager. But the agency told the partners to report back in six weeks on the results of their negotiations.

**Terminals ordered.** Meanwhile, a contract for 100 terminals at \$20,000 to \$30,000 each has been awarded to Scientific-Atlanta.

RCA's Angliss says that his company also requested bids on shipboard terminals and received five responses. However, RCA will not make awards until the system's operating philosophy has been settled—if then. The company is holding open its options and may go along with Comsat General's designs "if that proves to be the most cost-effective way," says Angliss.

All the partners agree on one thing, however—the controversy will not affect the Navy's use of the satellite. The Navy has its ground stations and shipboard terminals ready to go as soon as the satellite is up and checked out. The Navy also has the say as to where the first satellite is positioned—over the Atlantic or the Pacific. One satellite, over the Atlantic at 15° west longitude, will be able to cover an area ranging from the Persian Gulf to the eastern U.S. seaboard. The other, at 176° east longitude will cover from the

western U.S. to the straits of Malacca.

The Navy needs the satellites, but will the merchant shippers use the service after the satellite is launched? This is the next big question facing the partners. Comsat General's Keyes points out: "This is a completely new service, and there's a tremendous amount of risk capital involved here. We have \$70 million invested now, and we will

approach \$100 million with the ship terminals. And we haven't got a customer yet, except the Navy, who's in for \$29.6 million."

**Anticipation.** What confidence there is, says Keyes, is based on the belief that if good communications are available for merchant shippers, the market will develop itself. But, he says, if the satellite were only to replace the communications carried by present high-frequency radio,

## THERE'S A SIMPLE REASON WHY WE TRY TO HELP YOU USE LSI TO IMPROVE YOUR PRODUCT:

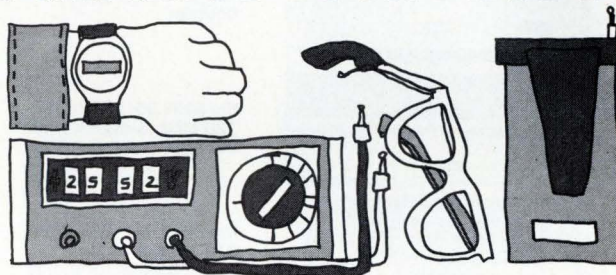

## YOU SELL OURS.

When we say we want to help you apply advanced semiconductor technologies to improve your product, we mean it. Because we're motivated.

The reason for our incentive is simple: If your product works better or costs less or becomes more competitive in the marketplace, it will succeed. And when you succeed, we succeed. Because you sell our product.

We've built our business by helping manufacturers use state-of-the-art LSI technologies and processes to extend their own design and manufacturing capabilities. And our people have the know-how and track record to do it for you if it can be done.

We've been involved in developing and producing some of the world's most sophisticated integrated circuits. Like High-Density CMOS, a technique using a silicon-gate system of multi-layer interconnect to optimize the utilization of silicon real estate. And precision Bipolar ICs incorporating high-value thin-film resistors.

We'd like you to think about your product in our terms. If what we know could be of benefit, you should know about it—now. Call, write, or circle reader service number 245 today. We both may have a lot to gain.

## WE CAN HELP, TOO.



## MICRO POWER SYSTEMS

3100 Alfred Street, Santa Clara, CA 95050, Phone: (408) 247-5350, TWX: 910-338-0154  
Japan: Yas Kanazashi, 21 Mori Bldg., 2-2-5 Roppongi, Minato-ku, Tokyo, Phone: 586-0471

# Heath is out to make the counter as commonplace as the VTVM



the \$169.95\*, IB-1100  
30 MHz, 5-digit kit-form  
counter

the \$225.00\*, SM-118A  
30 MHz, 6-digit  
assembled autoranging  
counter

the \$229.95\*, IB-1101  
100 MHz, 5-digit kit-form  
counter

the \$299.95\*, IB-1102  
120 MHz, 8-digit kit-form  
counter

the \$325.00\*, SM-128A  
110 MHz, 7-digit  
assembled autoranging  
counter

the \$379.95\*, IB-1103  
180 MHz, 8-digit kit-form  
counter

the \$395.00\*, SM-128B  
110 MHz, 7-digit,  
assembled high stability,  
autoranging counter

the \$495.00\*, SM-110A  
180 MHz, 7-digit,  
assembled counter

the \$625.00\*, SM-110B  
180 MHz, 7-digit,  
assembled high stability,  
programmable counter

the \$795.00\*, SM-110C  
600 MHz, 7-digit,  
assembled high stability,  
programmable counter

HEATH

**Schlumberger**

Heath Company  
Dept. 531-288  
Benton Harbor, MI 49022

- Please send latest Heathkit catalog.  
 Please send latest assembled instruments catalog.  
 Enclosed is \$\_\_\_\_\_ plus shipping.  
 Please send model(s)\_\_\_\_\_

Name \_\_\_\_\_

Address \_\_\_\_\_

City \_\_\_\_\_ State \_\_\_\_\_ Zip \_\_\_\_\_

Prices & specifications subject to change without notice. TE-307  
 \*Mail order prices; F.O.B. factory.

## Probing the news

"we would probably lose our shirt."

Keyes credits the Navy with being the key customer in getting the service started. "If the Navy thing hadn't happened, it would probably be 10 or 15 years before this got off the ground."

Angliss tends to agree with Keyes: "I suspect that any assessment made of the maritime-communications market itself would not have been such as to prompt anyone to launch a satellite for maritime-communications services. I don't think the economics are there, and this is borne out by our market assessments."

The economics of bad communications can be based on the cost of running a ship—\$1,000 to \$2,000 an hour. Any time lost in getting a message to a ship to tell it, say, to divert to another port, costs money. And since it now takes an average of 12 hours to get a message through and acknowledged, users are facing costs of \$12,000 to \$24,000 an hour for bad communications.

To demonstrate how valuable state-of-the-art communications could be for ships, Exxon Corp. and General Electric performed a series of experiments between July 1973 and February 1974, using NASA's ATS-1 and ATS-3 satellites for one hour each day. Teletypewriter, voice, facsimile, and slow-scan television were transmitted to the ship, and the satellites also were used for position-fixing with a General Electric system.

Teletypewriter turned out to be the most useful transmission vehicle for normal messages, but facsimile was found to be useful to send such information as layouts of ship facilities and equipment to help in making repairs. Teletypewriter-traffic quality was good—about 90% of the messages were received with error rate of less than 1 in 10<sup>4</sup>.

Position fixes were made to within an average of 1.3 nautical miles of actual positions, determined by radar and visual sightings. However, the frequencies used were in the vhf range, and the accuracy could be improved to within only 0.1 nautical mile at the L-band frequencies used in Marisat.



# The new Keithley Model 168 autoranging DMM... ...vive la différence!

There really is a difference in Digital Multimeters, and once you've experienced Keithley's 168 you'll know why we say *vive!* If you're tired of "general-purpose" promises that turn into run-of-the-mill

performances; if you want that bit extra that'll make your job easier, then *vive la différence*... here's the DMM for you! Send for our DMM Selector Guide or call us for demo now. **Phone (216) 248-0400.**

**AC VOLTS  
DC AMPS  
OHMS**

#### 5 functions

100  $\mu$ V to 1000 V dc  
100  $\mu$ V to 500 V ac  
0.1  $\mu$ A to 1 A dc  
0.1  $\mu$ A to 1 A ac  
100 m $\Omega$  to 20 M $\Omega$

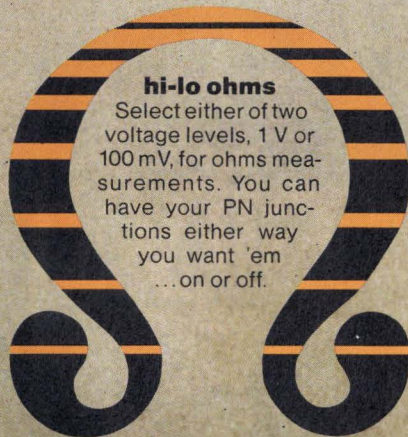

#### hi-lo ohms

Select either of two voltage levels, 1 V or 100 mV, for ohms measurements. You can have your PN junctions either way you want 'em ... on or off.

#### two-terminal input

Simple to connect. You can't get it wrong. Eliminates the word "whoops" from your vocabulary. Saves temper, too.

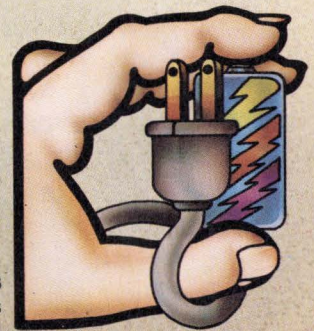

#### options & accessories

Rechargeable batteries that you can install anytime. An RF probe for high frequencies. Test leads. A 50-amp current shunt too.

#### price

Enough said? Order one... or two... or three now!

**\$299<sup>00</sup>**



#### automatic ranging

You just connect the signal and push the function. The decimal point pops into position automatically and the display is direct reading. That does save time!

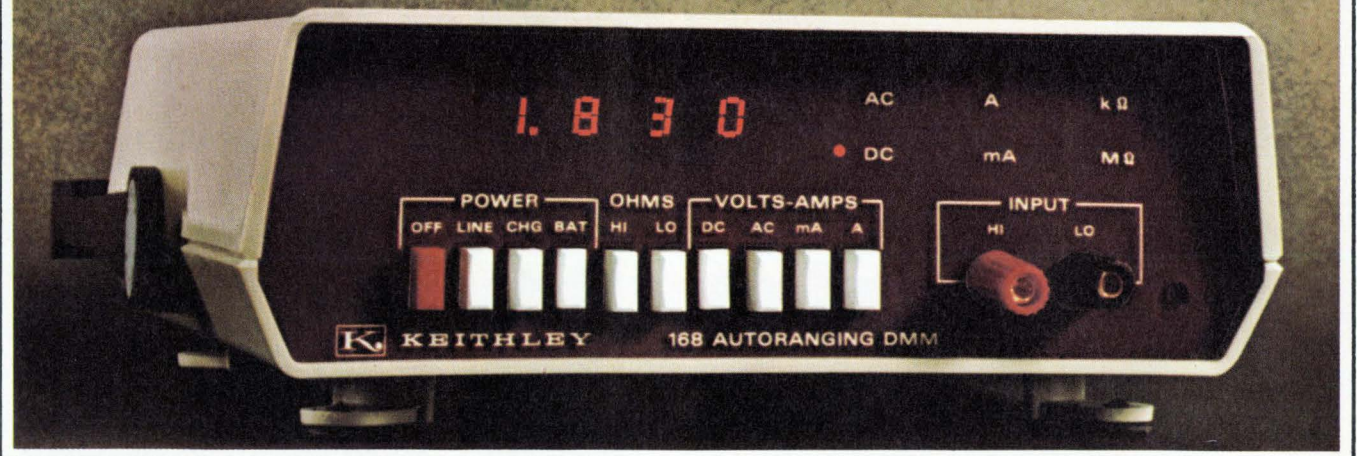

**KEITHLEY INSTRUMENTS**  
U.S.A.: 28775 AURORA ROAD, CLEVELAND, OHIO 44139  
EUROPE: 14, AVENUE VILLARDIN, 1009 PULLY, SUISSE

**Announcing  
the 21 most  
logical additions  
to the  
first family in  
CMOS.**

**From the industry's  
most logical  
source.**

**With a 30% increase in the industry's broadest line, the RCA CD4000 family now provides greater design flexibility for a wider range of applications.**

**21 NEW TYPES AVAILABLE NOW.**

Gates/Inverters	MSI	LSI
CD4066 Quad Bilateral Switch	CD4060 14-Stage Counter/Oscillator (Multiple Output)	CD4059 4-Decade Divide-By-N Counter
CD4069 Simple Hex Inverter	CD4518 Dual BCD Up Counter	CD4061 256-Bit Static RAM
CD4071 Quad 2-Input OR Gate	CD4520 Dual Binary Up Counter	CD4062 200-Bit Shift Register
CD4072 Dual 4-Input OR Gate	CD4063 4-Bit Magnitude Comparator	
CD4075 Triple 3-Input OR Gate	CD4514 4-to-16 Line Decoder (Outputs High)	
CD4081 Quad 2-Input AND Gate	CD4515 4-to-16 Line Decoder (Output Low)	
CD4082 Dual 4-Input AND Gate	CD4085 Dual 2-Wide 2-Input And-Or-Invert Gate	
CD4073 Triple 3-Input AND Gate	CD4086 Expandable 4-Wide 2-Input And-Or-Invert Gate	
CD4068 8-Input NAND Gate		
CD4078 8-Input NOR Gate		

**10 NEW TYPES AVAILABLE SOON.**

CD4070 Quad Exclusive OR Gate	CD4093 Quad NAND Schmitt Trigger	CD4510 BCD Up/Down Counter
CD4076 Quad D-Type Flip/Flop	CD4527 BCD Rate Multiplier	CD4516 Binary Up/Down Counter
CD4077 Quad Exclusive NOR Gate	CD4502 Strobed Hex Inverter	CD4528 Dual Retriggerable/ Resettable Monostable Multivibrator
CD4089 Binary Rate Multiplier		

We're adding 21 new types to the standard CMOS family that first brought you high noise immunity and low power consumption over a wide operating voltage range.

21 new types in the front-running CD4000 series the rest of the industry has chosen to second source.

21 new types you told us would give you wider vistas, and make possible more cost-effective designs.

21 new types from the people who developed more production capability and delivered more CMOS than anyone in the industry.

There's a 256 bit static RAM that requires no precharge or refreshing. What may be even more important to you is that it requires only micro-watts of standby power. Which makes it ideal when memory protection is important.

Typical access time is 250 nano-seconds. Operating range is from 3 to 15 volts.

Our four decade divide-by-N counter lets you divide by 3 to 15,999 in a single package.

Our CD4069 gives you a Hex inverter at gate prices. So you can save some money if you don't need high output drive current.

Spend what you save on our new CD4066 quad bilateral switch which offers a lot lower "on" resistance than our popular CD4016.

And now you have a series of AND and OR gates to complement our NAND and NOR gates.

There's more coming too. Ten of them, real soon.

All of which goes to prove two important points relative to RCA.

The continuing progress of the people who invented CMOS.

And a continuing commitment to the solid state technology that's come on strong and is here to stay.

With all this behind you, you can start plugging our new COS/MOS circuits into your plans. (COS/MOS is the RCA name for CMOS.) To order samples, contact your nearest RCA Solid State distributor, call your RCA field office, or write RCA Solid State, Section 70F13, Box 3200, Somerville, N.J. 08876. For information phone Pat Lindblad (201) 722-3200, Ext. 2355.

**RCA Solid State**  
The first house in CMOS

Solid state

## LSI testing: a three-way street

General-purpose, special, and combination systems all have place in checking memories, calculators, microprocessors

by Howard Wolff, Associate Editor

What kind of instrument is needed to test large-scale integrated circuits—the general-purpose tester, the specialized tester, or both? The answer is all of the above. It all depends on the application.

Some makers of test systems maintain that some of the requirements for LSI testing can be handled best by a big, general-purpose machine; others prefer specialized

ones. And still others like a combination, or modular, approach. A prime supporter of that last view is William C.W. Mow, president of Macrodata Corp. of Woodland Hills, Calif., a tester manufacturer, who says he can supply both types through his system of “cascading” testers.

Mow breaks the market into the system house, the large computer

company, and the semiconductor maker. The first, he says, needs a versatile large-scale tester because it must test memories, random logic, and microprocessors. Only if memory-testing requirements escalate considerably would such a house be forced to add dedicated memory testers, says Mow.

On the other hand, he adds, the computer manufacturer requires only a memory tester, while the semiconductor manufacturer has yet a different need: separate memory and microprocessor testers.

Another California tester maker, Teradyne's Digital Systems division in Chatsworth, believes that specialized testers are the answer for the needs of the memory, calculator chip, and microprocessor markets. Jack G. Salvador, vice president and general manager, says, “The ‘DME’—diagnose and measure everything—machines are too large, too complex, and too expensive to be justified at this time. They're not optimum for anything.” The big machines leave too much room for error, he adds. “The operator has enough complexity in the devices without having the complexity of the tester added to it.” So the answer, according to Teradyne, is to offer specialized testers in each area.

That's also the philosophy at Tektronix in Beaverton, Ore. James Fischer, marketing manager for automated test systems, is loathe to compare special with general-purpose testers because, he says, neither

**Ready.** Tester maker Tektronix is marketing the S-3400 series for semiconductors, left, for \$80,000 to \$150,000. Below is a test station, the 1803, also from Tek.

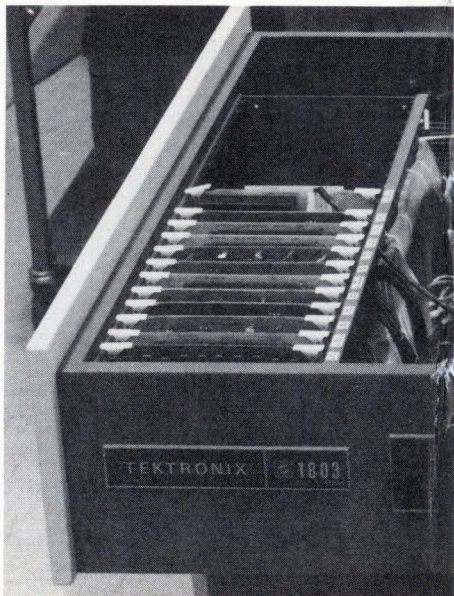
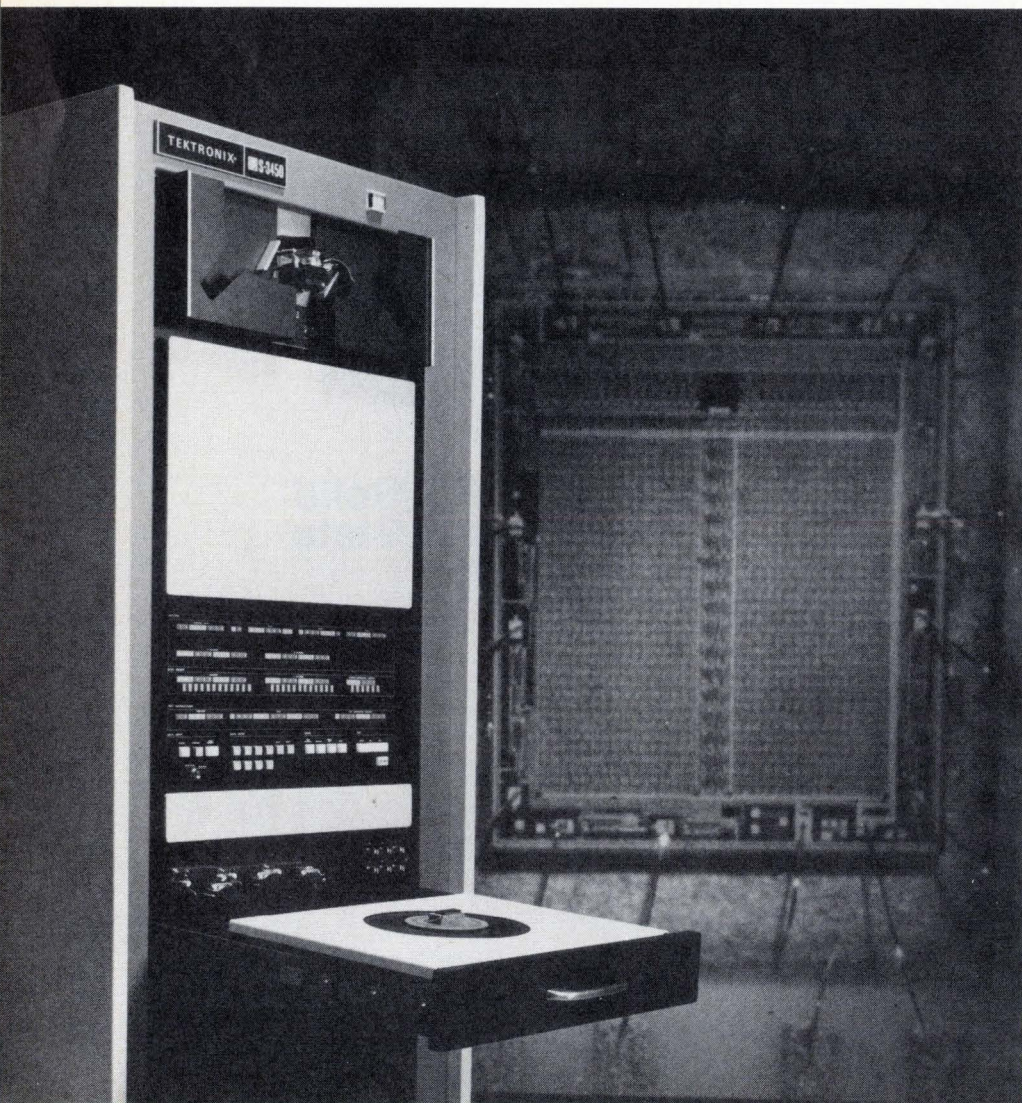

will do all the jobs, and neither will dominate the other. But in its marketing plans, which include both types, Tektronix will tilt slightly toward the general system because it is adaptable.

**Deciding factors.** "The determining factors in whether or not a specialized LSI tester will be used are volume, throughput time, and the kind of testing to be done," says Fischer. For example, he says: "In memory, the market is characterized by a volume in the millions of devices yearly. On the production line, this means short throughput time and getting them out the door as fast as possible. In this kind of environment, you test to determine whether the device works or not. It's not necessary or economical to try to characterize the failures. So you test to first failure."

A relatively new entry in the LSI-testing race is another Chatsworth company, Xincom Corp., which supplies a complete memory-test system that Tektronix markets as the 3400. Since Xincom's product line is modular, it's not surprising to find that the company's marketing vice president, John W. Coons, advocates assembling a test system for a specific job.

Xincom uses a "mother-daughter" arrangement for its 5500 series, a concept labeled by Macrodata's Mow as the wave of the future. This consists of an internal controller as the "daughter" that can be loaded from an external "mother" computer instead of with paper tape. With this arrangement, up to eight terminals (four testers, two stations per tester) can be slaved to one computer, which develops programs,

keeps track of results, does house-keeping, and so on.

**Versatility.** In a unique position is Western Digital Co. of Newport Beach, Calif., which makes both an MOS and a general-purpose test system called the Spartan. The system is used by other device makers, such as Burroughs, Microsystems International Ltd., American Microsystems Inc., and Solitron Devices. Ron Griffin, test-systems marketing manager, says that, while a specialized tester may look more economical than a general version, it sometimes doesn't work that way. "In engineering development," he says, "it's necessary to have a more versatile tool."

National Semiconductor's Tony Mandia disagrees. He thinks that specialization is the best thing that ever happened to LSI testing. Mandia, manager of MOS-test engineering, says, "Specialized testers make a lot of sense from the point of view of throughput, performance, and economics. If you have a dedicated tester, life is a lot simpler. For one thing, the logic in the tester can be designed for a specific job, which means you can take a lot of shortcuts on the production line that you couldn't take with a general-purpose tester."

Interestingly, though, Mandia also seems to agree with the module makers when he says, "What would be ideal would be to have dedicated testers doing a variety of jobs, each controlled by its own microprocessor and all tied together into a single system by a central computer that does all the book work." □

Reporting for this article were Bernard C. Cole and Paul Franson.

## Faster digital systems checkout with Kurz-Kasch Logic Probes

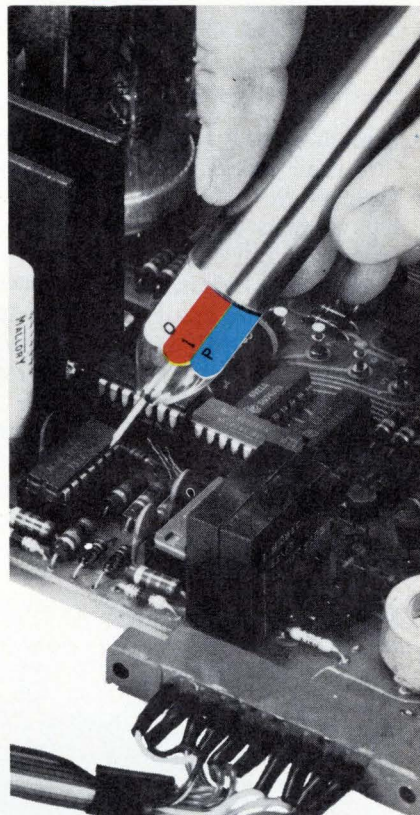

Kurz-Kasch's patented logic probes identify

- (1) logic low (TTL .0V to 0.8VDC) white light
- (2) logic high (2.4 to  $V_c$ ) red light
- (3) deadbands (0.8V to 2.4V) no light
- (4) pulses (any excursion) blue light
- (5) open circuits — no light

Logic probes are also available for MOS, HTL, RTL and discrete logic. Prices from \$6995 to \$9995. Send for free literature. For a 30 day free trial probe or special information, telephone Tom Barth, General Manager, Kurz-Kasch Electronics, 2876 Culver Ave., Dayton, Ohio 45429, Telephone: (513) 296-0330



**Kurz-Kasch, Inc.**  
ELECTRONICS DIVISION

Communications

# U.S. and Soviets ready space link

Hot Line, to avoid damage by humans, will use European and Soviet communications satellite; Moscow earth station causes delay

by Howard Wolff, Associate Editor

**Something had** to be done about the Hot Line linking Washington and Moscow. Soviet and American officials agreed—after a Danish bulldozer operator cut the line near Copenhagen, a Finnish farmer plowed it up, and a fire in a Baltimore manhole put it out of service—that the system had to be separated as far as possible from humans.

The answer is a new arrangement that provides for two parallel satellite-communications circuits—one utilizing the Russian Molniya, and the other the European Intelsat sat-

ellites. The hookup was to have been completed by the time President Nixon visits Moscow this summer, but the target date is now between August and the end of November. The delay, say American officials, is in getting the Soviet earth station on stream; the American one, operated by the Army Satellite Communications Agency at Ft. Detrick, Md., is already operating and is busily tracking the Russian birds.

The U.S. satellite portion is a leased full-duplex voice-bandwidth

circuit from a Comsat station at Etam, W. Va., through an Intelsat-4 to a Russian earth station being built by ITT some 10 miles from Moscow.

The Ft. Detrick Molniya earth station was supplied under a \$7.5 million contract by the Harris Electronic Systems division (formerly Radiation division) of the Harris Corp. It consists of identical communications systems that will be providing C-band signals through 60-foot tracking and communications antennas.

Tracking is a particular problem because, unlike the Intelsat and other synchronous satellites, which appear to remain in fixed position, the Molniya satellites travel in a highly eccentric and highly elliptical orbit. Their path will bring each of the three or four Molnyias forming the operational system over the Hot Line's U.S. earth station in a high looping arc once a day.

Both the antennas will track each satellite, ensuring uninterrupted operation in case one malfunctions. Then, just before the active satellite moves out of range, one of the antennas will swing away and lock in on the next Molniya coming into view in the sequence.

**Eccentric.** The Molnyias travel this way because the northern portions of the Soviet Union aren't visible to a satellite located over the equator. The Russians, therefore, have their satellites follow an ex-

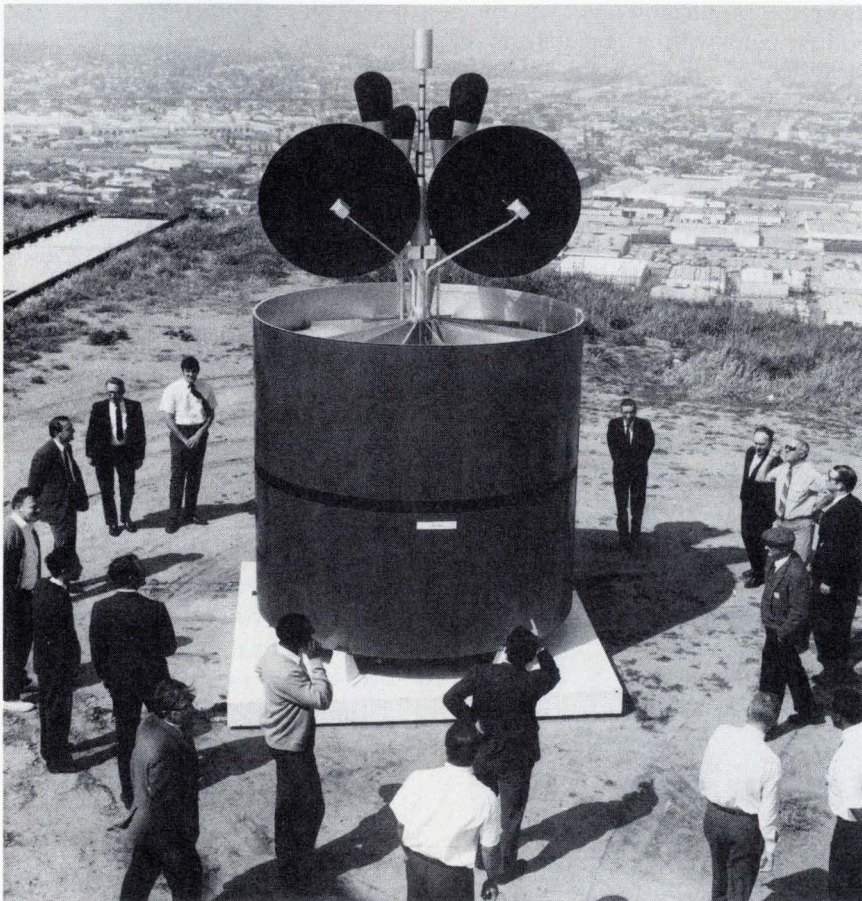

**Hot bird.** Intelsat 4 will be one satellite used in redundant spaceborne communications link between Kremlin and Washington. The other will be Soviet Molniya. The link is scheduled to be completed this autumn when the Soviet earth station turns on.

tremely elliptical orbit: the apogee is 25,000 miles and the perigee is 300 miles. Each craft makes two complete orbits around the earth each day, making two North American apogees. Each time it reaches this North American high point, each Molniya is visible to both the Russian and American earth stations for a period of about eight hours.

Redundancy is the watchword for the communications systems, as well as for the antennas. Dual uplink and downlink chains are provided in on-line/standby pairs so that single failures in either system will cause only a momentary loss of signal.

Each of the two baseband information channels frequency-modulates a carrier; each is up-converted and amplified within redundant transmitting chains. The output of one of the two power amplifiers is then selected for radiation to the Molniya satellite via the antenna subsystem.

Received signals are sent from the antenna subsystem to one of the two low-noise amplifier channels in the receiver subsystem. Four down-converter/demodulator channels then move the band signals to a signal processor. Two of the four channels normally provide redundant paths for the Moscow-link communications traffic. The other two, not directly in the communications path, give the signal processor auxiliary inputs for the earth frequency and power control and for automatic tracking.

Ironically, despite all the technology and expertise designed into the system way, it won't get much use. While ordinary communications between the Kremlin and Washington will continue to travel back and forth via closed-circuit Telex machines, the Hot Line is reserved for top-priority communications between the two governments in the event of crises such as last October's Middle East war and what William E. Naeher, deputy assistant secretary of state, refers to as "other emergencies."

In any event, Russian and American diplomatic communication officials no longer will have to worry about bulldozers, plows, and fires in Baltimore. □

## You say you want a

low-profile snap-in-mounting push button switch or matching indicator that is interchangeable with most 4-lamp displays... available in a full range of cap colors... with a choice of bezels with or without barriers in black, gray, dark gray or white.

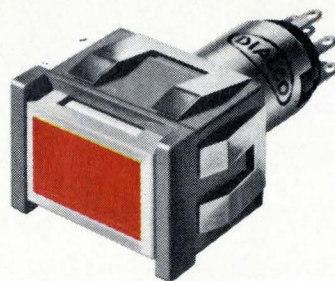

## and a

legend presentation that's positive (like this one) or negative (like the one below) or just plain (like the one above)... one that's white when "off" and red, green, yellow (amber), blue or light yellow when "on"... or colored both "on" and "off."



## and a

highly reliable switch proven in thousands of installations... available in momentary or alternate action... N.O., N.C. or two circuit (one N.O., one N.C.)... that accommodates a T-1 3/4 bulb with midget flanged base, incandescent, in a range of voltages from 6-28V.

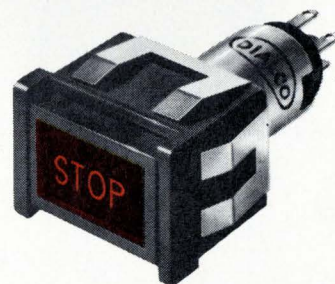

*etc.  
etc.  
etc.*

***Now, for the first time  
Dialight gives you  
custom panel designing  
with a standard line of  
push-button switches and  
matching indicators***

Dialight offers a broader range of switch and indicator possibilities than you'll find anywhere in a standard single-lamp line. Sizes: 3/4" x 1", 5/8" and 3/4" square and round. Send today for our new full-color catalog.

# **DIALIGHT**

A North American Phillips Company  
Dialight Corporation, 203 Harrison Place, Brooklyn, N.Y. 11237

# Today's Basic Tool

**COMSTRON'S Model 1013  
Frequency Synthesizer**  
0.1Hz to 13MHz at a Basic \$1595.

*A tool is the extension of man's hand and does his bidding easily... almost by itself. Functional, simple, beautiful... the 1013 is today's Signal Source that meets your every need... on the bench, in your lab, in your system.*

Performance with integrity... the 1013 has all the features and more. Features you'll wonder how you ever did without. A 5+ digit display at full crystal accuracy (no "accuracy stealing" verniers), low spurious and phase noise, high purity sine wave, TTL square wave, metered output, calibrated attenuator and full programmability.

The full 5+ digits are programmed either from the front panel or remotely via a bi-directional I/O bus... the LED display always shows the state of the instrument... accuracy is never compromised! Clean signals... levelled, displayed and settable... with real output power... the COMSTRON 1013—  
**Today's Basic Tool!**

*Ask for our new brochure or call COMSTRON for a demonstration... today.*

**COMSTRON**  
CORPORATION

120-30 Jamaica Avenue Richmond Hill, N.Y. 11418  
Tel: 212-441-3200

Circle 88 on reader service card

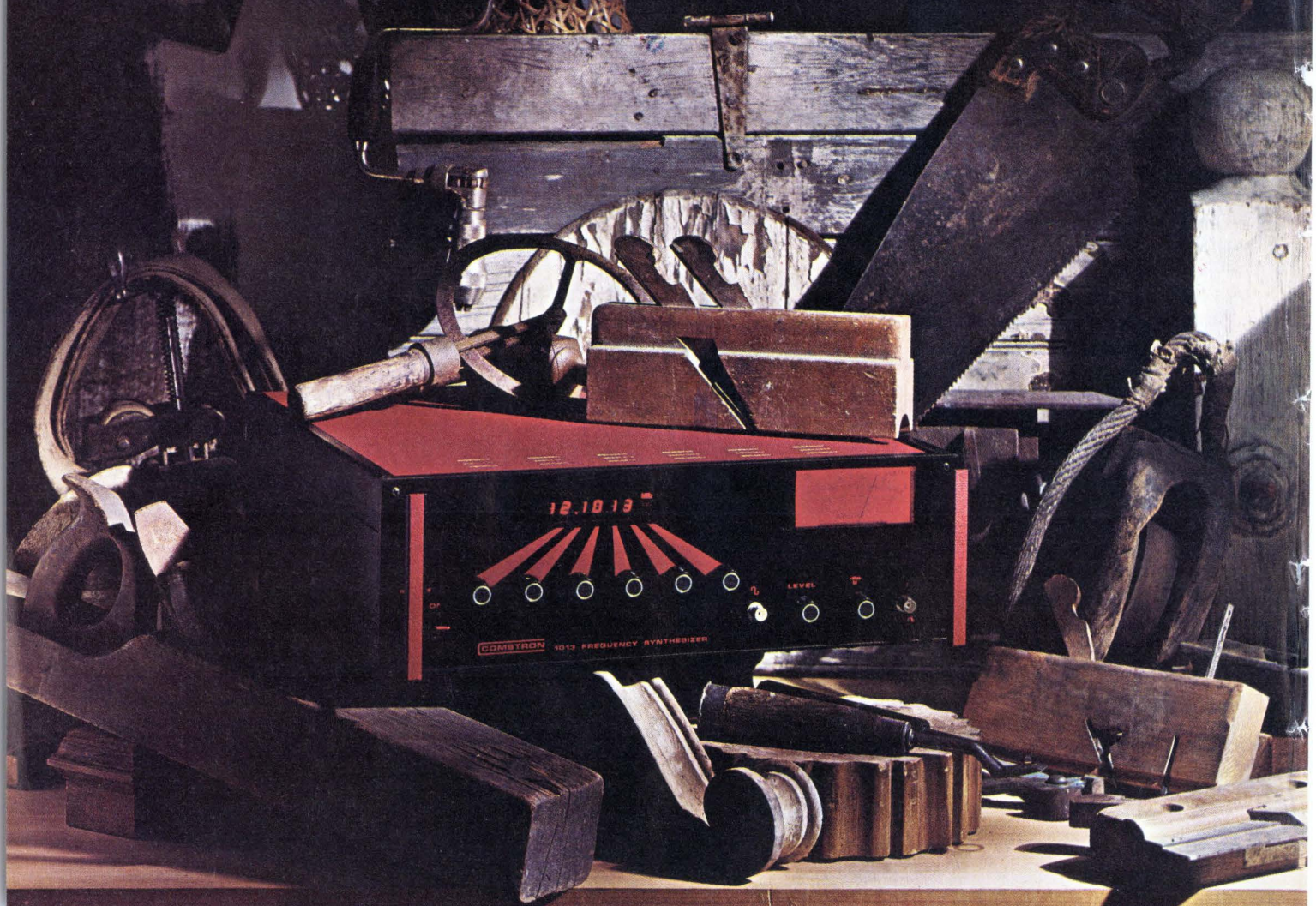



Patents

# Europe delays patent changes

New treaty would end right of holder to control trade in all Common Market countries, a provision used frequently by components manufacturers

by Richard Shepherd, McGraw-Hill World News

Some of the world's big component manufacturers are breathing a sigh of relief. The reason: a potentially troublesome piece of European patent legislation has been stalled just short of agreement. It would, among other things, remove the right of a patent holder to control trade of his product between countries in which he has obtained a patent. And that, say European patent experts, is a favorite marketing strategy of the electronic-components industry.

What saved the day was British refusal to participate only five days before delegates were due to arrive in Luxembourg last month to sign a European Common Market patent treaty. The stay may be only a short one, since the project was put off until the fall. But it may last longer because the British are supporting a protocol to the draft treaty that calls for a delay in application of the patent for five or even 10 years. Meanwhile, supporters of the treaty hope the Common Market's Court of Justice will hand down decisions that can get the whole project moving again.

The row is over the last of three big international patent agreements designed to speed and rationalize

the slow and often varied procedures for establishing an inventor's rights for his discovery in as many corners of the world as he chooses. The three agreements, though separately negotiated, go hand in hand.

The first, the Patent Cooperation Treaty, signed in Washington in 1970, provides a single patent-filing application to cover as many as 40 separate national patents. The second, the Munich Convention, signed last October, sets up a single patent-granting mechanism, including a joint patent-examination facility, previously only available to three or four countries.

The third would create a single Common Market patent. But the complicated diplomatic haggling over all three means that the failure of any one could foul up the others.

**One for all.** As it stands now, the draft Common Market patent treaty will insist that the patent-holder or his licensee no longer can intervene to protect his market in any member country after he has introduced his product in any one of the member states. In other words, once the product is launched in one country, it must be allowed equal access and treatment in any of the other eight.

At the same time, the draft treaty blocks another potential loophole by ruling that patents filed on a purely national basis in any one country will automatically have the same status and effect as the European version. Thus, the inventor cannot escape the free-trade principle by filing in one country alone.

International patent officials figure that the British government sees the new convention as yet another tool for European integration. And in its present hostility to that principle, the Wilson administration is in no mood to accept a tightened rein on British companies. Yet on the surface, these experts say, the British government is expected to disguise its basic motives with a demand for more time to study the draft treaty.

Right now, the British delegation to the EEC is talking about an October reply to its initial examination of the draft treaty, and there are still hopes that an agreement can be reached by the end of the year.

A more serious complaint, some European experts concede, is that, for many companies, the patent would be more expensive than their current national coverage in the European community. British patent agents figure that for 16-year coverage for all nine member countries, the European patent would cost \$7,200, compared with \$16,800 for each country separately covered.

But the agents point out that, in many cases, the company does not require complete coverage. For example, patent coverage on the same basis in Britain, Germany, and France alone would cost \$1,440 less than the European patent if calculated at current fees. □

## Too much too soon?

As the patent chief of one of Europe's largest electronics companies explains it, the Common Market patent, combined with the Munich Convention and the Patent Cooperation Treaty, would "put too much weight on our shoulders. I am very much in favor of the Munich Convention, but we need to gain experience with the European Patent Office and then tackle the EEC patent later on."

But even that opinion isn't unanimous. One official who's involved in patent work for a major semiconductor company says the problem is too complex to say whether or not a delay would help. However, for the moment, it appears that the people favoring delay are going to get their way.

# WE'RE HANDING YOU A LINE YOU CAN BELIEVE IN...

What you've been looking for in capacitor manufacturing equipment is high production, uncomplicated operation, and the kind of reliable performance you get from sound engineering. Isn't that right?

Well, you can stop looking. GTI-Dix Engineering has the line of capacitor equipment that delivers.

The DAP Sealer, for example, seals beaded leads, does solder-down operations, solder cladding, double-stud diode sealing and glass encapsulation of capacitor/resistor/thermistor chips — up to 16,000 parts an hour.

For high speed, precise component printing GTI's Print N Mark body coats, color bands, or prints legends or characters on axial-leaded devices at a rate of up to 10,000 parts an hour. Prints on glass, plastic, metal, epoxy or ceramic parts; handles a wide range of component diameters, too. With the addition of GTI's new Magnetic Feeder, one operator, in one single operation, feeds, marks and oven-dries your capacitors. GTI-Dix produces your printing plates or individual type characters — custom made to your specifications. We even provide a complete line of fast drying inks that meet MIL Spec's and EIA standards — especially formulated for Print N Mark.

For complete printing capability on your line, we've designed a new Radial Lead Print N Mark machine with a capacity of up to 40,000 disc capacitors an hour.

You also can have clean, crisp imprinting on LED's, DIP packages and even individual parts.

The latest in our line of capacitor equipment, the Capacitor Chip Sorter not only saves labor, but also glass and leads. Upwards of 20%. And when you're sorting about 24,000 chips an hour, that's a lot of glass and wire.

For your bottom line, get the straight line from:

**GTI** dix engineering  
A DIVISION OF GTI CORPORATION

1399 Logan Avenue / Costa Mesa,  
California 92626 / Phone (714) 546-0411  
Telex 678421



DAP Sealer



Capacitor Chip Sorter

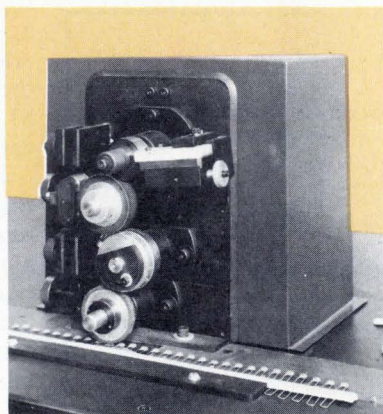

Radial Lead Print N Mark

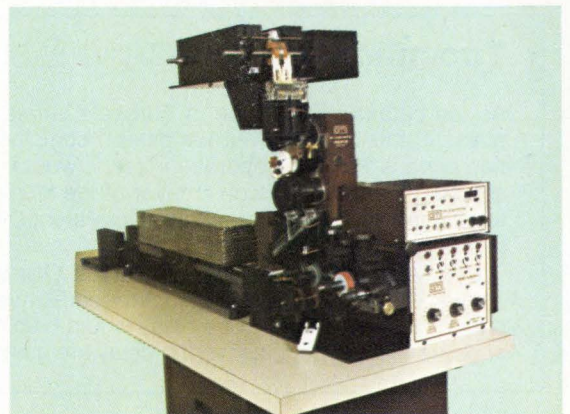

Print N Mark

# Laser becomes a component for mass-market applications

Helium-neon lasers priced below \$100 are being aimed at volume usage in supermarket point-of-sale systems, video-disk players, and other equipment that require safe, low-power scanning for operation.

by David L. Wright and Dale Crane,  
*Spectra-Physics Inc., Mountain View, Calif.*

□ The helium-neon laser, once relegated to the scientist's laboratory, is finally becoming inexpensive enough for use in supermarkets and homes. Not that supermarkets will sell lasers to housewives, but reading labels in stores and playing video records on television sets will probably soon become the two most widespread laser applications.

Moreover, the laser has become safe and reliable enough for extensive use in commercial and consumer products. It is now practical to mass produce a low-power laser with an operating life that exceeds the useful life of most electronic products, allowing the laser to be used as a component, rather than a subsystem that requires expert maintenance.

So even before label readers and video players become commonplace in the next five years, as often predicted, the laser will probably become a high-volume component for many other applications.

Indeed, a new laser has been developed specifically for mass production as a general-purpose component. This laser, the Spectra-Physics model 136, sells for less than \$100 now in volume and is expected to drop in price in the future. In the past, prices under \$100 generally applied only to unmounted plasma tubes—the part that generates the light beam—rather than assembled, fully operational lasers.

Tests indicate that a continuous operating life of more than 20,000 hours can be expected, or almost twice the reliability of older designs of comparable beam power (1 to 2 milliwatts). The expected life is

twice the MTBF (mean time between failures) of most electronic products and is equivalent to some 10 years of use at 40 hours a week. Also, power efficiency has been doubled and beam pointing accuracy increased some 5 to 10 times by the new design.

The cost reduction is a result of a novel plasma tube design that can be manufactured from easily fabricated piece parts by automated production equipment. Since conventional plasma tubes are largely handcrafted by highly skilled workmen, the new design sharply cuts labor costs. Major cost savings include:

- A 40% reduction in the number of parts-fabrication and assembly operations
- A 60% savings in materials costs through the use of readily available, lower-cost materials
- A 33% cut in the number of tube piece parts (from 60 in the conventional design to 40 in the new design).

Reducing tube costs made it possible to package the laser as a general-purpose subsystem and still keep below the \$100 figure that appears to be the cost threshold for volume applications. It is believed to be the only non-laboratory laser with a beam-power control. This control, with a range from less than 1 mW to more than 2 mW, allows the equipment manufacturer to set the beam level as needed to comply with eye-safety standards. The laser itself is designed to meet electrical safety codes.

The rise in performance is largely the result of a change in the optical mode that generates the beam in the plasma tube. The new mode has a diameter that is smaller than before, thereby raising the optimum gas pressure and reducing the required gas volume. In turn, tube diameter was reduced some 20%, to 1.2 inches, from the 1.5 in. of conventional designs. The net effects were a 60% reduction in required operating power, since the excited gas is utilized more efficiently, and minimal "gas-eating" (degradation caused by absorption of gas by tube elements).

### Assaulting the mass market

The public still views the laser as a laboratory instrument, although lasers have actually had many practical applications in the past decade. In fact, laser systems have become commonplace tools in the construction industry. The visible red beam of a low-power helium neon laser is used as a long, perfectly straight "string" to set ceiling and floor levels and to establish grade angles for sewer-pipe installation, bulldozing, and the like.

At present, such alignment and surveying systems constitute the only volume laser market—a few thousand systems a year. Some small-volume applications include spectrometers, eye-retina stitchers, silicon-wafer positioning, industrial-dimensioning controls, computer mass-memory recorders, interferometers, and metrology, as well as laboratory research.

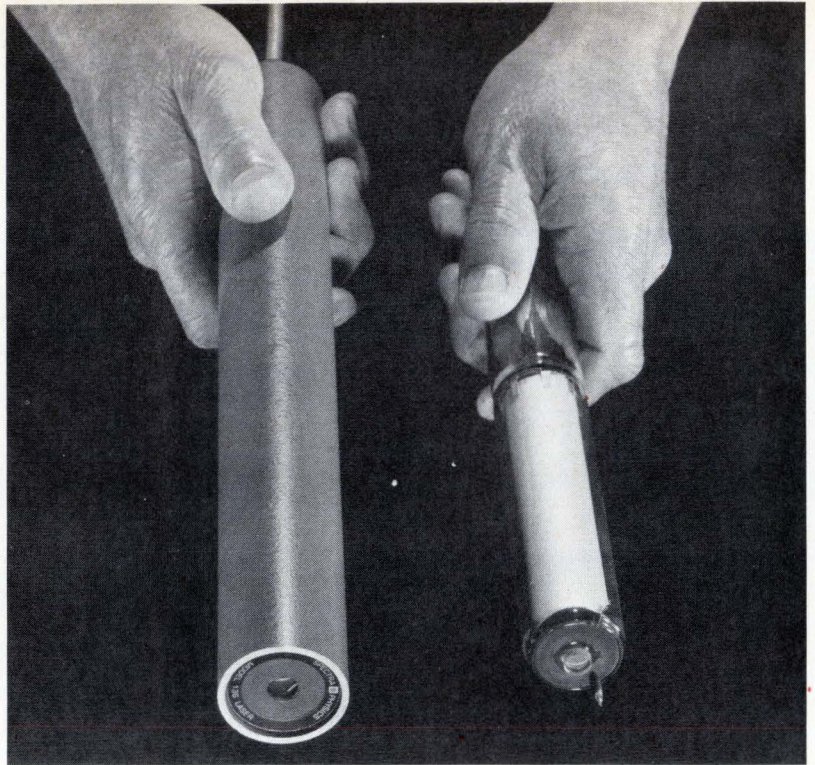

**1. Savings.** This new He-Ne laser tube requires 33% fewer parts, 40% fewer manufacturing operations, and 60% less money for materials than previous models.

In addition to label-readers and video-disk scanners, the emerging, potentially high-volume markets for low-cost lasers include pollution-monitors, copiers, optical memories, communications, facsimile, and target designation, such as gun sights. In fact, one of the first uses of the model 136 is in the Electronic Label Reader for supermarkets (see "Laser speeds checkout," p. 93).

All past uses have involved a few tens of thousands of lasers while the expected mass markets will probably require hundreds of thousands. In particular, video players and label readers must be mass-produced. Enough video players must be sold to create an attractive market for a variety of video disks, to encourage further purchases of players. Likewise, the use of label readers in many stores will make commonplace the use of optically readable labels on merchandise.

Simply reducing laser prices is not enough to open a mass market. Components of consumer and commercial products are expected to have average operating lives longer than the warranty period; otherwise, replacement costs become intolerable. And a system's primary and most expensive component, whether the laser in a video player or a picture tube in a TV set, should have a life much longer than the warranty period. If it does not, the manufacturer may be driven from the market by a reputation for "cheap," unreliable products.

Therefore, Spectra-Physics' basic objective at the outset of the tube development program in 1970 was to lower cost and improve performance. The plasma tube was the prime target, since it is the most expensive part of a laser to make. The other objective, making a generally applicable laser, could be achieved in the package-design phase. Luckily, no revolutionary changes in tube design were required. Instead, a combination of evolu-

tionary changes in conventional helium-neon tube technology proved suitable.

### Evolutions from lab to market

An evolutionary design was sought in order to make use of the hard-won advances of the 1960s. Although helium-neon lasers had started out as laboratory curiosities conceived and studied by physicists, their commercial production dates back to 1962. Spectra-Physics began marketing helium-neon lasers through the Perkin-Elmer Corp. at that time, and their practical use in instruments soon followed.

However, the early He-Ne tubes were expensive, had short lives, and were difficult to use. They required expertly assembled external optical cavities (the resonators in which the coherent, monochromatic beams are formed). A succession of developments from 1966 through 1969 largely corrected those problems.

The use of mirrors permanently assembled as parts of the tube, forming permanently aligned cavities, and semiautomatic alignment and sealing machines reduced laser prices from more than \$1,000 to several hundred dollars. Meanwhile, lifetimes were extended from hundreds of hours to several thousands of hours by development of cold aluminum cathodes, hard dielectric mirrors, and moisture-resistant seals.

The latter developments opened the construction-laser market, which supported the tooling developments.

But it became obvious by 1969 that the tubes of the day could not be produced at low cost in the huge volumes projected for potential consumer and commercial markets. Furthermore, refinements of conventional tube designs would not assure cost and reliability improvements as great as those in the past.

### Redeveloping the tube

Its origin as a product of the laboratory glassblower's art caused the conventional plasma tube to retain a complex, rather fragile shape with pin seals and many protrusions. In contrast, the geometry developed for the model 136 laser's tube is simple and suitable for mechanized production and rapid packaging (Fig. 2).

Besides the new glass-envelope geometry, which resulted in a clean cylinder, the major innovations in mechanical design are the stamped metal end plates and the use of a metal, rather than glass, pinch-off tube. The end plates replace the parts formerly used as mirror seats and electrical feedthroughs. They are hermetically sealed to the glass body. The pinch-off tube forms the final seal after the tube is evacuated and filled with the helium-neon gas mixture. Combined with other less notable redesign, these changes eliminated 20 tube parts.

Much of the development effort went into finding proprietary combinations of economical materials that were easy to fabricate and had compatible thermal-ex-

## Laser speeds checkout

Food canners and other suppliers of merchandise to supermarkets have started to print on labels and packages the Universal Product Code, a family of optoelectronically readable bar codes that identify each product and its manufacturer. The UPC was adopted recently as a Super Market Institute standard so that many store operations, from inventory-control to product-pricing and customer-checkout, could be automated with electronic point-of-sale systems.

When read and decoded by symbol-scanning peripherals in the checkout counters, the UPC makes it possible for the POS system's computer to look up prices and operate the store's electronic cash registers. The checker simply pulls the packages across a scanning window in the counter and puts them in a bag. And the POS computer also can replace manual price-marking, inventory-checking, accounting, and the like.

Spectra-Physics' Electronic Label Reader, one of the initial applications of the laser described in this article, is such a peripheral. The laser beam goes through focusing and routing optics to a high-speed scanner that projects a multibeam scanning pattern toward oncoming packages. In cross-section, the pattern is a horizontal line bisecting a series of vertical scans.

Projected upward and forward for several inches beyond the counter-top scanning window, the pattern allows UPC symbols printed on the sides of boxes, cans, and bottles to be read when most packages are upright. Conventional fan or X-shaped laser scans would require labels to be placed face-down on the scanning window. Also, since UPC code bars are usually printed horizontally or vertically, a conventional scan would cross the bars at a 45° angle.

The stitch-bar pattern is more efficient, since one of the orthogonal scan lines will usually cross the code bars at 90°, the crossing angle that represents the shortest scanning distance. That allows packages to be read while moving through the scan pattern at speeds to 500 inches per second. Maximum speed drops to 100 ips if a checker twists a package to a 45° orientation.

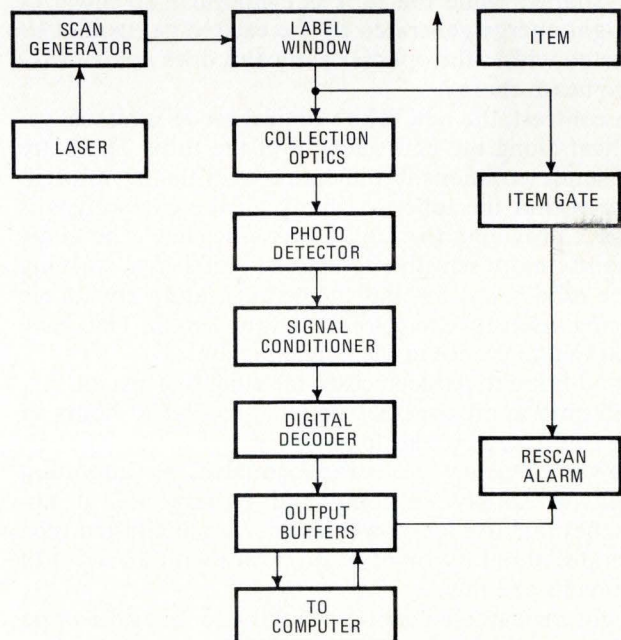

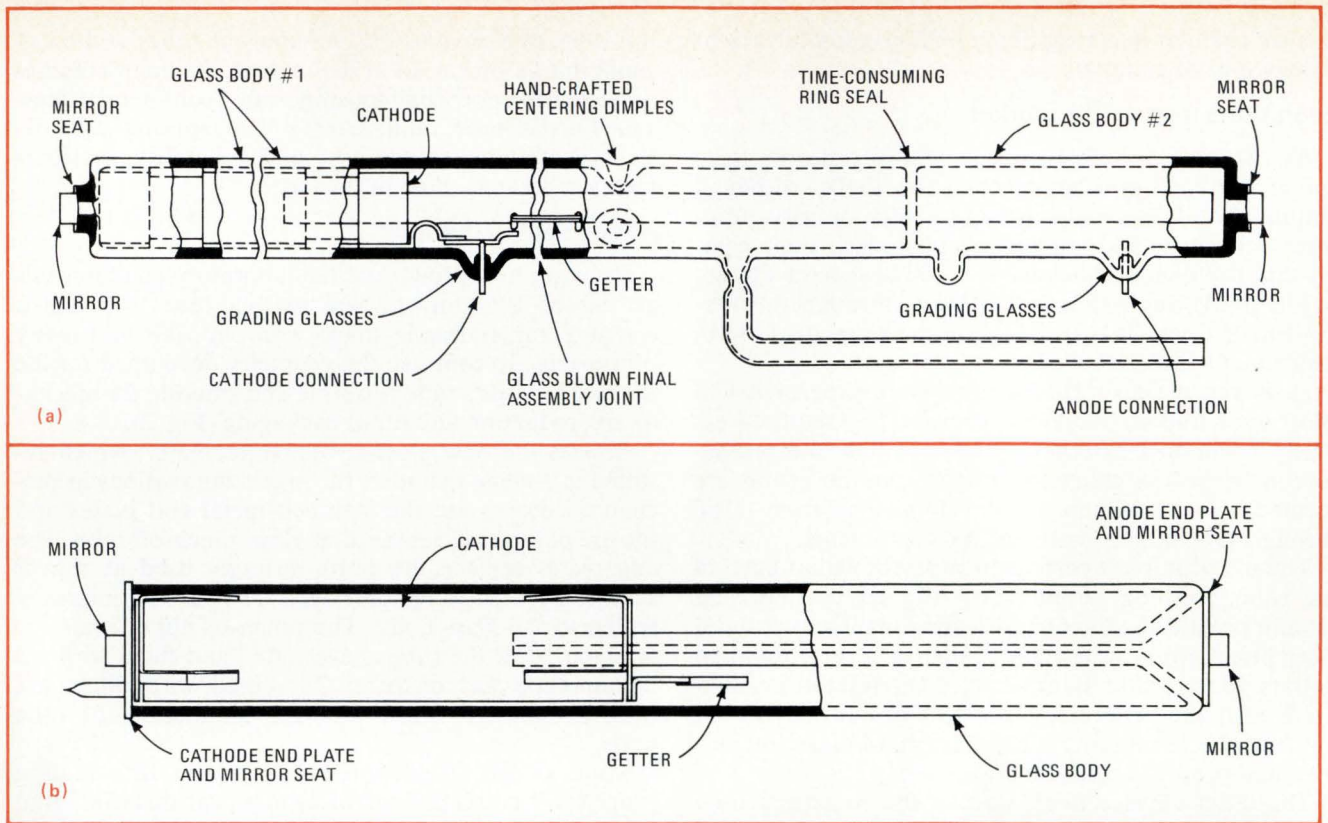

**2. Evolution.** The most important improvement on an older He-Ne laser (a) is the use in the new one (b) of stamped-metal end plates that serve as both electrical feedthroughs and mirror seats. The new model also eliminates protrusions and fragile pin seals of previous designs.

pansion coefficients at processing and operational temperatures.

The resonant optical cavity is formed by two spherical mirrors. Most other low-cost plasma tubes employ one spherical mirror and a flat mirror, an arrangement called a hemispherical resonator. The hemispherical design is generally used because the mirrors are relatively easy to align. However, that resonator's optical mode is cone-shaped while the tube is cylindrical, so much of the light energy generated by the excited gas cannot be collected within the optical cavity and does not contribute to beam energy.

In contrast, the new tube's optical mode is almost cylindrical along the entire length of the tube. There are only small variations in the diameter of the beam oscillating within the tube, so nearly all the excited gas is utilized, providing the high power efficiency. The mode is slightly more sensitive to angular shifts (e.g., warping of the tube body) but has the compensating advantage of being insensitive to changes in tube length. That gave additional tolerance in the long direction.

In addition to reduced costs, the chief benefits are:

- Lifetime approximately doubled to 20,000 hours or more (indicated by tests to date).
- Power efficiency more than doubled, an important factor for supply economy and battery life. It approaches that of high-power lasers. An unballasted tube generates about 3 mW of beam power with an input of 1,200 volts at 3 mW.
- Tight, repeatable beam-positioning so that little or no alignment is needed to mate the laser to system optics. When the tube is packaged, the beam is within  $\pm 0.05$

mm of the center line of package mounts, compared with the  $\pm 0.5$  mm typical for low-power He-Ne lasers.

- Small beam diameter—0.51 mm, compared with a normal range of 0.5 to 1.5 mm.
- Smaller, more readily assembled package. The final package is a hermetic cylindrical metal "can" 1.37 in. in diameter and 11.5 in. long, or 22% smaller than a conventional tube's package would be.

The tube is placed in mounts in the package. The beam is concentric with two precision system-alignment reference surfaces machined on the can. The package also contains stress reliefs that allow the tube to expand and contract without warping during temperature variations, as well as installation of shock mounts, power-supply ballast, safety-ground circuits, and the beam-power control.

### Using the laser

The package eliminates the difficulties normally encountered in applying laser tubes. It converts the tube to a component that can be installed without numerous auxiliary electrical and mechanical parts, protects the tube and its high-voltage components from adverse environments, makes the laser an electrically safe device.

A variable attenuator is built in as an output-power control to allow the laser to be stocked as a general-purpose device. Precise beam-power tolerances have always been difficult to meet in tube production, necessitating either tube selection or adjustments in using systems. The control allows the model 136 power to be specified "from less than 1 mW to more than 2 mW."

The equipment manufacturer simply adjusts to the

power desired by means of a fitting on the package, while observing beam power on a conventional optical power meter. To prevent end users from tampering with the setting, the fitting is hidden, requires a special tool, and can be sealed.

More power is required by the laser than the bare tube, primarily because the tube is ballasted by 62 kilohms. All He-Ne tubes must be ballasted with a positive resistance to compensate for the gas discharge's negative resistance. Unballasted tubes oscillate and drop out. They may operate beyond their drop-out point, but they will be inefficient and may be noisy.

The laser needs less than 7 kV starting voltage and about 6 W of operating power (1.5 kV at 4 mA). Two power supplies, also sealed, have been developed. One draws less than 8 W from a battery, and the other less than 12 W from an ac outlet. Both use the laser's ground circuit as part of a safety-monitor circuit that shuts off all high-voltage power unless all grounds are complete. Such circuits avoid subjecting personnel working with active lasers to potentially lethal high voltages and short-circuit currents that could reach 30 mA or more.

Mounting lasers requires a feel for the fine angles involved in beam positioning and familiarity with the effects of thermal and mechanical stress on positioning. A bare tube can be mounted in simple holders only when environments are benign and accuracy requirements low. But a packaged laser with internal stress reliefs and precision mounts can usually go into simple external mounts—compliant mounts (holders with rubber "O" rings around the "can") in less-critical applications, or rigid rings at each end of the can in precision uses.

The system-mounting structure's thermal warping or twisting should be considered. For example, 10 thermal W across a stainless-steel bar 1 by 1 by 20 cm creates a thermal gradient large enough to cause 2 milliradians of

angular shift—greater than the beam's diffraction-limited divergence. Pointing accuracy could be preserved better in poorly cooled systems by mounting on aluminum or other high-conductivity materials.

Eye safety depends on how much beam energy enters the eye in a given exposure time. If the beam is scanned, modulated or pulsed, greater beam power is allowable, since average power or exposure time is less than when a continuous-wave beam is seen. Pertinent standards are "American National Standard for Safe Use of Lasers," (Z136, 1-1973), American National Standards Institute, New York, and the proposed "Performance Standards for Laser Products," Bureau of Radiological Health, Bethesda, Md.

The model 136 is applicable to the three least-hazardous equipment classes defined in these documents: Class I (exempt products requiring no precautionary labeling), which expose the eye to up to 0.4 microwatts average power; Class II, 0.4  $\mu$ W to 1 mW; and Class III, 1 mW to 5 mW. Powers above 5 mW are considered definitely hazardous.

By itself, this cw laser is a Class II or III product, but beam modulation or scanning (or a light-tight housing) can exempt the end equipment. For example, the Electronic Label Reader qualifies for Class I because the beam is split into multiple beams that are scanned at very high speed. Even if a beam should reach the eye of a customer or checker, it would move too fast to be hazardous.

Electrical safety is also important. If the laser is used with a system power supply, safety circuits like those in the optional supplies are strongly recommended. Also, sealed packages avoid hazards from spills or high humidity, as well as protect the tube and its connectors. The laser and the supplies can operate even when submerged in water. □

**3. In action.** The laser must scan omnidirectionally the product-code symbol, shown on package labels (a). To do so, it's mounted inside an electronic label-reader (b) which focuses a cross-hatch scan pattern.

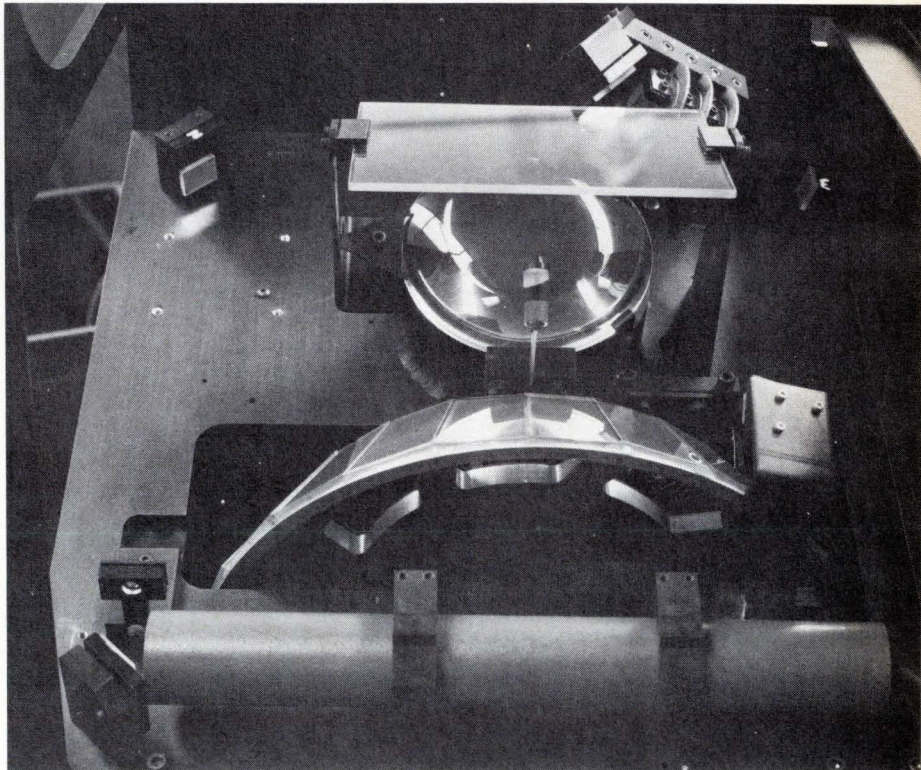

# The fast Fourier transform's errors are predictable, therefore manageable

By limiting itself to a digitized segment of a continuous waveform, the FFT makes waveform analysis practical at the cost of introducing aliasing and leakage errors; but these errors, once understood, are easy to counter

by Robert W. Ramirez, Tektronix Inc., Beaverton, Ore.

□ One's first brush with the fast Fourier transform (FFT) is often disconcerting because turning the classical Fourier transform into the FFT practically always introduces errors. Known as leakage and aliasing, these errors almost invariably occur when continuous time-domain waveforms are subjected to finite-time-windowing and sampling—both of them operations that are fundamental to the FFT.

But the engineer who understands why leakage and aliasing occur will fairly soon be able to spot many cases on sight. Also, several methods for combating them become very obvious.

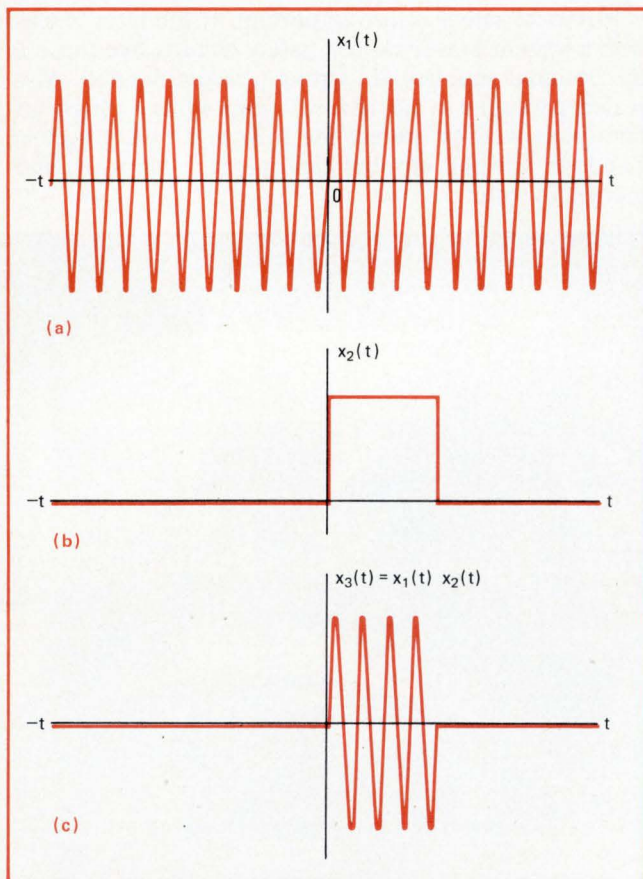

**1. Windowing.** Mathematically ideal sine wave extends over entire time domain (a). It must be multiplied by window of finite duration (b) to yield a signal that can be handled by a computer for processing into the frequency domain (c).

Let's first recall the integral Fourier transform:

$$X(f) = \int_{-\infty}^{\infty} x(t)e^{-j2\pi ft} dt$$

where  $x(t)$  is a continuous time-domain function, and  $X(f)$  is the corresponding frequency-domain function for which the integral transform is to be evaluated. To transform  $x(t)$  digitally, the Fourier transform must be

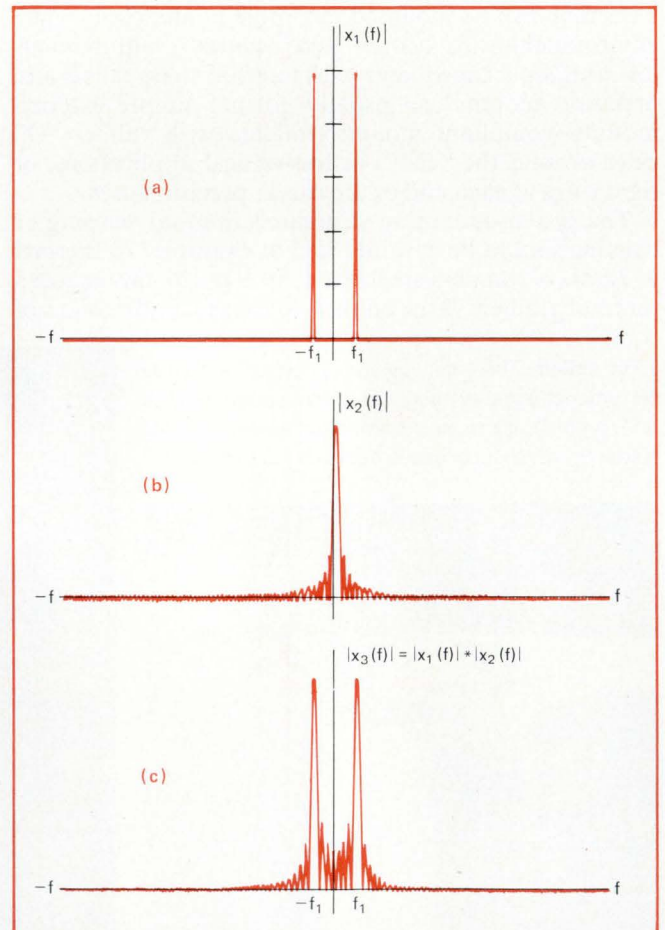

**2. Effect of windowing.** Fourier transform of an ideal sine wave is a pair of impulses in the frequency domain (a). Transform of a rectangular pulse is a  $(\sin x)/x$  function (b). Convolution of these two functions produces transform of a sine wave windowed by a rectangular pulse (c). Note the leakage. (All transforms shown here are magnitudes only; hence, negative values are shown as positive.)



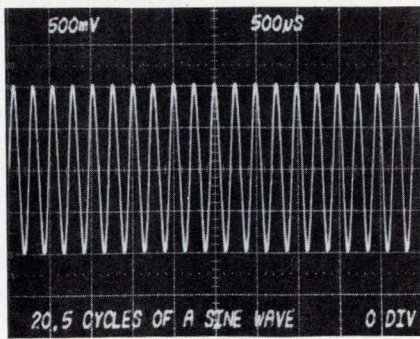

(a)

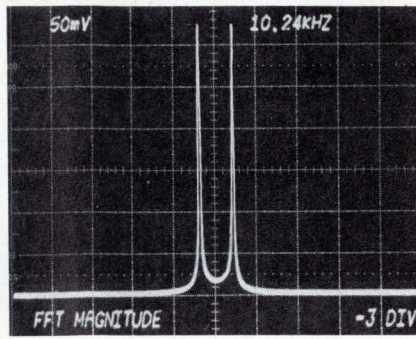

(b)

**3. Leakage.** CRT photos of sine wave (a) and its transform (b) show actual "leakage," due to windowing. Effect only fails to occur when frequency of sine wave and inverse of window duration happen to be harmonically related.

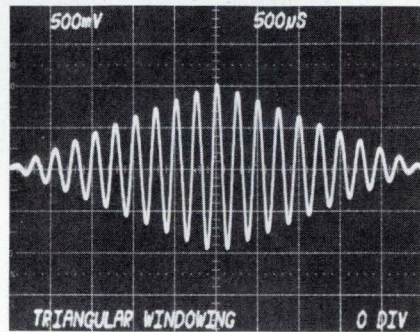

(a)

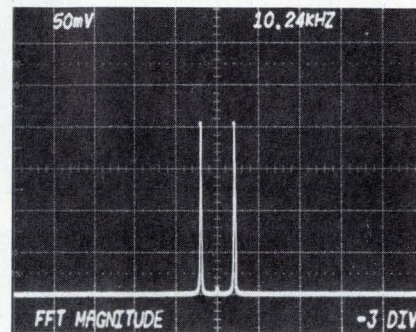

(b)

**4. Reducing leakage.** Using a triangular window (a) on the sine wave of Fig. 3 cuts frequency-domain leakage (b). Note, however, that it also cuts amplitude of the frequency-domain impulses.

restated as the discrete Fourier transform (DFT):

$$X_d(k\Delta f) = \Delta t \cdot \sum_{n=0}^{N-1} x(n\Delta t) e^{-j2\pi k\Delta f n\Delta t}$$

or, letting  $\Delta f = 1/N\Delta t$ ,

$$X_d(k\Delta f) = \Delta t \cdot \sum_{n=0}^{N-1} x(n\Delta t) e^{-j2\pi kn/N}$$

where  $k$  and  $n = 0, 1, \dots, N-1$ ;  $\Delta t$  is the time-domain sampling interval, and  $N$  is the number of samples taken over the interval of  $(N-1)\Delta t$ .

Now the FFT is nothing more than a time-saving computer algorithm for evaluating the DFT, so its mathematical properties are completely analogous to the DFT's. Similarly, the errors associated with the FFT derive from the DFT. Leakage arises from the fact that the waveform is studied over only a short period (or window) of time. Aliasing arises if the waveform is sampled at too slow a rate.

### The view through the window

In the integral transform, time is considered in its infinite totality. In the discrete transform, only the time interval covering the  $N$  discrete samples is considered (Fig. 1). In Fig. 1a, a continuous function of time—a sine wave—is assumed to exist over the time interval from  $-\infty$  to  $+\infty$ . When this sine wave is transformed into the frequency domain by an FFT algorithm, a data window (Fig. 1b) must be defined, and a segment of the wave-

## How to read the CRT photos

The many photographs in this article were taken from the CRT display of the Tektronix digital processing oscilloscope (DPO). To benefit fully from this article, therefore, the conventions used in the display for both time- and frequency-domain information must be understood.

The CRT display has eight vertical and 10 horizontal divisions. The scale factors giving quantity and units per division appear at the top of display, the vertical scale factor on the left, the horizontal on the right.

In the bottom right-hand corner of the display is information on the position of the zero reference for vertical information. A 0 DIV indicates the zero reference is on the center horizontal line of the graticule; a -3DIV indicates it is three divisions below that line.

Time-domain displays are distinguished from frequency-domain displays by the units associated with the horizontal scale factors. S is time in seconds, HZ is frequency. In time-domain displays, time zero coincides with the leftmost graticule line, and positive time proceeds to the right in accordance with the displayed horizontal scale factor. In frequency-domain displays, zero hertz coincides with the center vertical line of the graticule, negative frequency is on the left, and positive on the right.

Where it's needed to explain the display or add information, computer-generated text appears in the lower left area of the display.

**5. Other windows.** These eight pairs of photographs each show a windowed time-domain function and its corresponding frequency-domain magnitude spectrum. The various windowing functions have all been applied to the same signal—a low-pass-filtered square wave to which a low-amplitude sine wave has been added. The frequency of the added sine wave is very close to the fundamental of the square wave.

Included in the photos of the frequency-domain spectra is information on the more important characteristics of each windowing function. Specifically, the bandwidth figure (BW), indicates the theoretical bandwidth of the windowing function's major lobe at

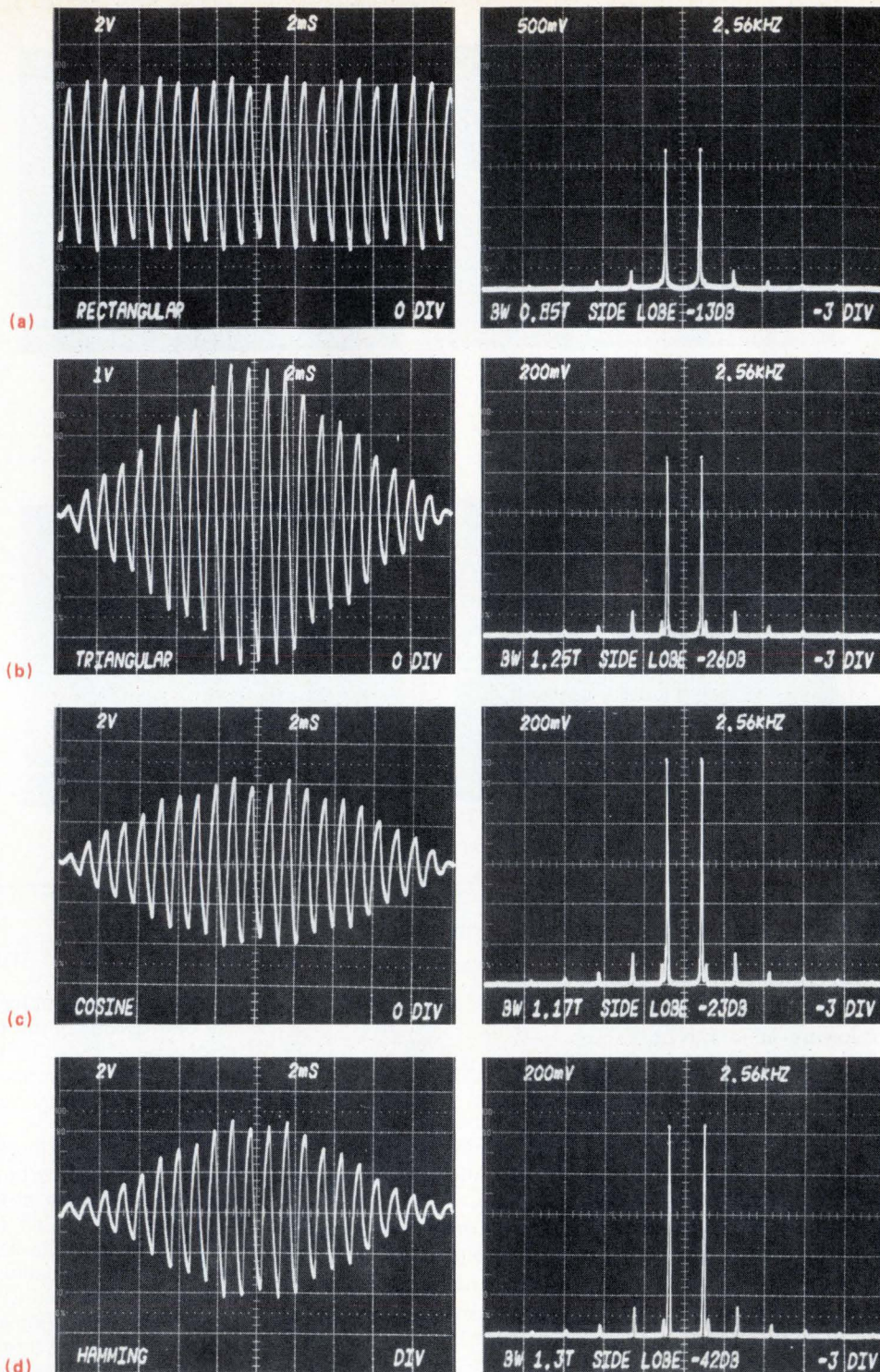

form viewed through the window. Thus, all knowledge of the waveform's behavior before and after the window is lost.

In effect, the window of Fig. 1b is a unity-amplitude pulse. The sine wave is "viewed through the window" when the two are multiplied together. The result of this time-domain multiplication of Figs. 1a and 1b is shown in Fig. 1c.

Obviously, the act of windowing in the time domain must also affect the signal in the frequency domain (Fig. 2). Figures 2a, 2b, and 2c are the magnitudes of

the Fourier transforms of the time-domain waveforms of Figs. 1a, 1b, and 1c, respectively. Since multiplication in the time domain corresponds to convolution in the frequency domain, Fig. 2c is produced by convolving the magnitude plots of Figs. 2a and 2b.

Figure 2 clearly shows the effect of windowing in the frequency domain. The original concentration of energy in the two impulses of Fig. 2a has been smeared or "leaked" into the major lobes and side lobes that appear in Fig. 2c. The same amount of energy is present in both cases, but it has been redistributed in Fig. 2c in

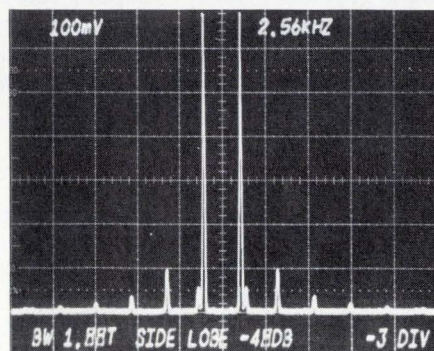
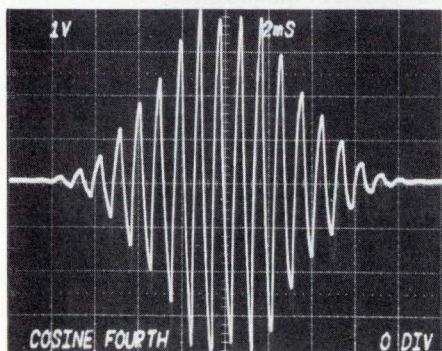
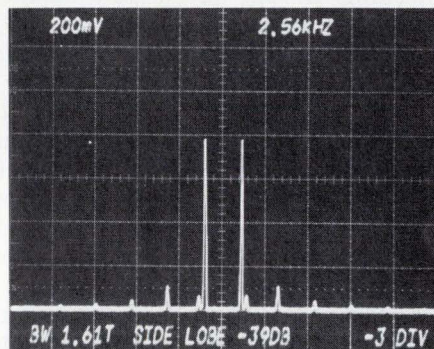
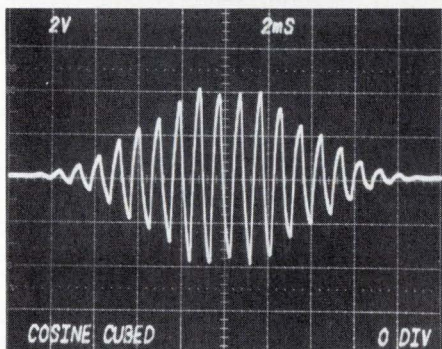
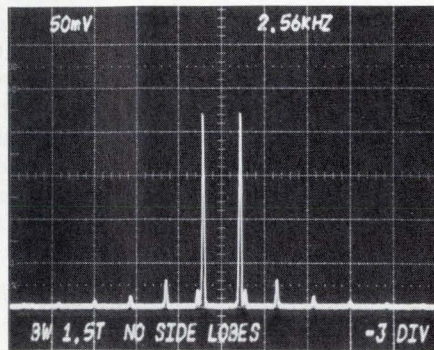
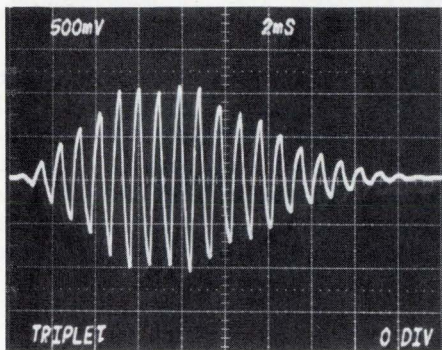
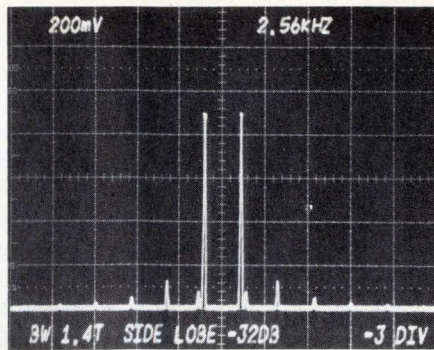
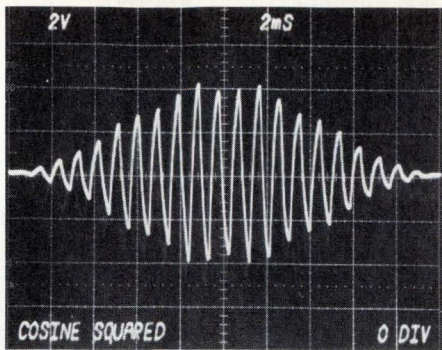

(e)

(f)

(g)

(h)

the 3-decibel point. The "T" factor appearing with these bandwidth figures is the reciprocal of the window length in the time domain. (For example, the window length of the triangular window shown in (b) is 10 divisions times 2 milliseconds, or 20 ms, and the resulting theoretical bandwidth of the triangular window's major lobe at the 3-dB point is  $1.25/20$  ms or 62.5 Hz.) Also given are theoretical figures showing the level of each window's highest side lobe relative to the major lobe.

The Hamming window of (d) is a cosine squared function on an 8% pedestal, and the triplet window of (f) is a cosine squared function multiplied by an exponential function. All the other windows are self-explanatory.

such a way as to decrease peak magnitude. This redistribution of energy is what's called "leakage" and is a direct result of data windowing.

In practice, the leakage may not be as pronounced as in Fig. 2c. In Fig. 3, for example, the major lobes represent the frequency-domain magnitude of the windowed 20.5 cycles of a sine wave, and they are so positioned that the frequency-domain sample points of the FFT algorithm occur on the peaks of the side lobes. Consequently, instead of individual side lobes, all that's visible is the exponentially decaying peaks of the side

lobes. This form of leakage looks like, and is often called, "skirts."

Very rarely, the number of cycles of a periodic waveform acquired within a rectangular data window is an integer, and then no leakage at all occurs. In this situation, the frequency of the time-domain signal is harmonically related to the inverse of the duration of the window, and the zero crossings of the  $(\sin x)/x$  function (which is the Fourier transform of a rectangular window) coincide with the frequency-domain sample points of the FFT algorithm. (In the case of nonrecurring

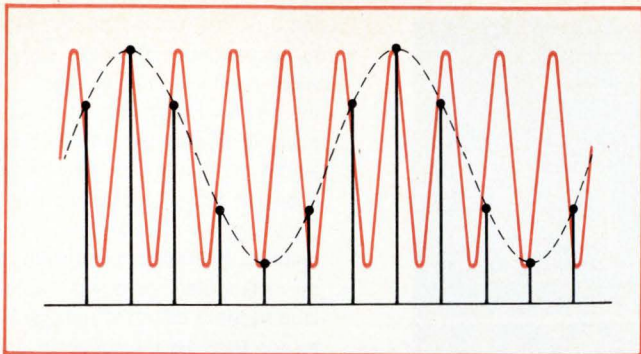

**6. Aliasing.** Insufficient sampling of high-frequency sine wave (solid line) leads to low-frequency aliasing (dashed line). To prevent it, sampling rate must be at least twice highest signal frequency.

pulses, too, leakage will not occur if the pulse rises from and returns to zero within the window's confines.)

Unfortunately, this harmonic relationship seldom happens. Leakage generally occurs and just has to be lived with—though it can be diminished if the window's shape does not exhibit as harsh a time truncation as the rectangular window.

### Reducing leakage

For example, take triangular windowing. In Fig. 4a, the same 20.5 cycles of sine wave as appear in Fig. 3a have been multiplied by a unity-amplitude triangular pulse. The spectrum of this triangularly windowed waveform (Fig. 4b) reveals significantly less leakage into the skirts than does the spectrum of the rectangularly windowed waveform of Fig. 3b. Amplitude is also lower, because a unity-amplitude triangle contains less energy than a unity-amplitude square pulse of the same duration.

Now, the windowing function is in essence a time-domain pulse of fixed energy, and any change in that pulse's shape must be reflected in a redistribution of the energy in the pulse's frequency domain. It follows that, if the shape of a windowing function is changed to reduce side-lobe size, the energy normally associated with those side lobes must go elsewhere. In general, the

energy is forced into and widens the major lobe.

Besides the rectangular and triangular windows so far mentioned, there are many more windowing functions available for preconditioning acquired signals. Also called weighting functions and convolution kernels, eight of the more common and useful windows are illustrated in Fig. 5.

Examination of all these windowing functions reveals a general trend of increasing bandwidth for decreasing side-lobe level. The implication here is that the resolution—the ability to distinguish adjacent frequencies of equal amplitude—decreases as bandwidth increases. On the other hand, the selectivity—ability to pick out adjacent frequencies of unequal amplitude—is increased as the side-lobe level is decreased. An extreme of the selectivity-resolution dilemma is shown in Fig. 5h, where a cosine fourth window has widened the fundamental lobe so much that it threatens to encroach upon the domain of the adjacent, low-level frequency component. Had this low-level component been closer to the fundamental, cosine fourth windowing would have caused the component to be absorbed in the widened lobe of the fundamental.

### Aliasing

To evaluate the FFT, the data viewed through a window must also be digitized. But the process of obtaining discrete samples of the windowed time-domain waveform may give rise to aliasing, or foldover, errors.

Digitizing an analog waveform requires that the waveform's amplitude be sampled often enough to define the waveform completely. The number of times that any waveform is sampled in a fixed period is referred to as the sampling rate. The well-established sampling theorem (Nyquist criterion) states that the sampling rate must be at least twice the highest frequency present in the wave form for the wave form to be defined completely. Failure to use a sufficiently high sampling rate is the source of aliasing errors.

Fig. 6 diagrams the impersonation of low-frequency waveforms by aliasing or foldover. Assume that the 10 cycles of sine wave shown by the solid line represent a

## Refresher on FFTs

The Fourier transform has been described as both one of the most useful and one of the most useless mathematical tools available to the electronics engineer. The usefulness of the tool is evident: it provides a method for calculating the frequency spectrum—both magnitude and angle—for any function of time. However, for almost all signals, except the very simple ones found in textbooks, the evaluation of the Fourier integral is so difficult and time-consuming as to have been impractical before computers were widely available.

Computers substitute brute-force number crunching for the elegance of analytic solutions. Any time-domain waveform that can be described as a sequence of discrete values can be transformed into the frequency domain by a computer. But even with a computer, the process was rather lengthy until James W. Cooley and John W. Tukey, deciding to exploit the various symmetries inherent in the definition of the Fourier transform, produced

"An algorithm for the machine computation of complex Fourier series" (Mathematics of Computation, April 1965, p. 297). This algorithm and its successors are what are known today as fast Fourier transforms (FFTs).

As reasonably priced, accurate, analog-to-digital converters, and low-cost minicomputers and microprocessors become more widely used, the examination of a signal's frequency spectrum may become as commonplace as the study of its time-domain behavior. Though communications engineers have traditionally thought in terms more of frequency bands than time functions, the advent of instruments like the digital processing oscilloscope [*Electronics*, March 15, 1973, pp. 98-103] is giving them the hardware to look at signals the way they've always wanted to. But engineers who have no experience of the FFT do need to be aware of the important differences between this practical tool and M. Fourier's mathematical abstraction.

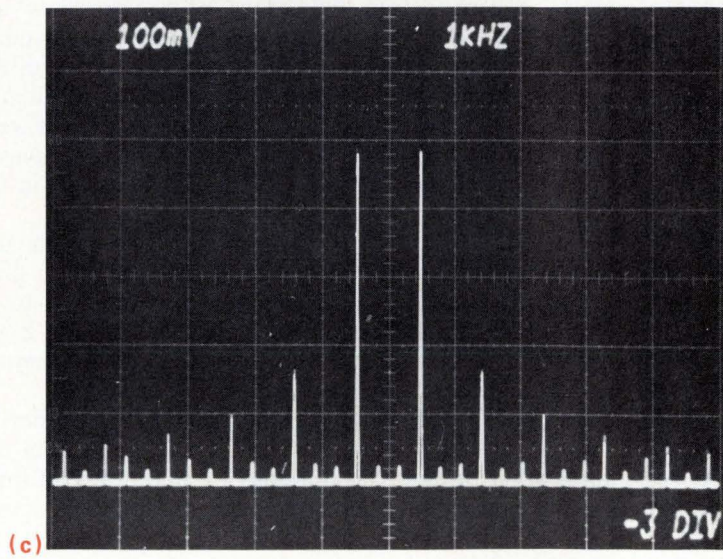
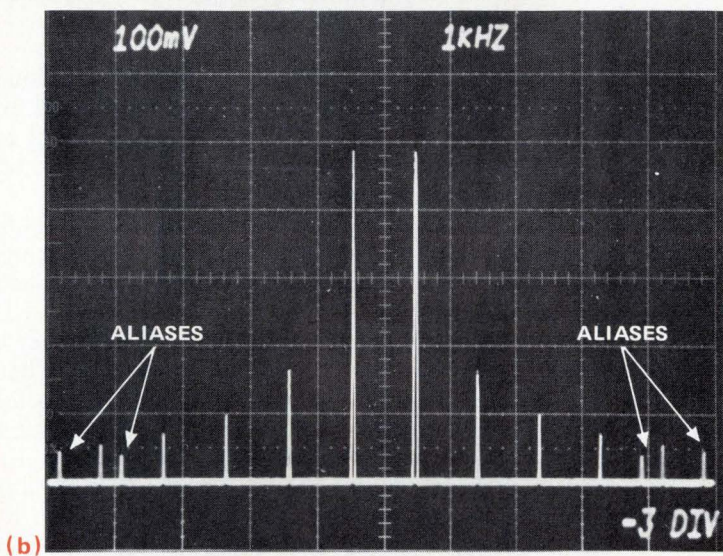
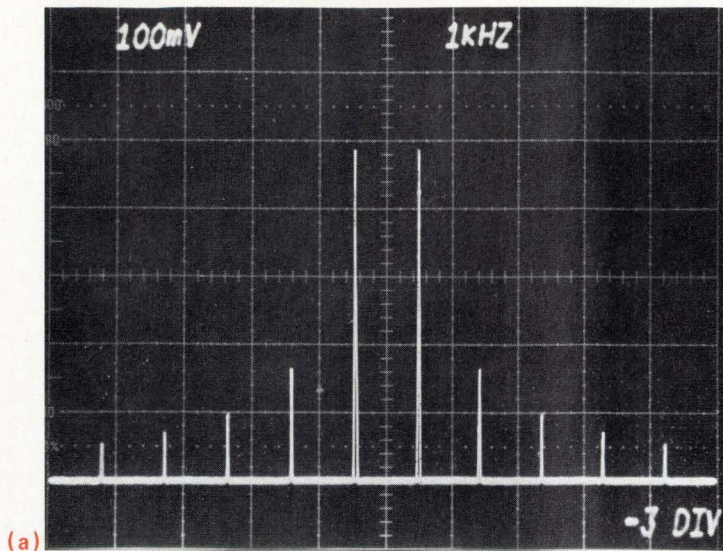

**7. Recognizing the impostors.** These three photos show the effect of adding high-frequency components to an input signal while keeping the sampling rate fixed. In (a), the sampling rate is more than twice the maximum input frequency, and all is well. As additional frequency components are added, foldover occurs around the edges of the screen and two low-frequency aliases appear (b). They are easy to recognize because they destroy the monotonicity of the spectrum. When many more components are added, the impostors reach the center of the screen, fold over there, and proceed out toward the edges again (c).

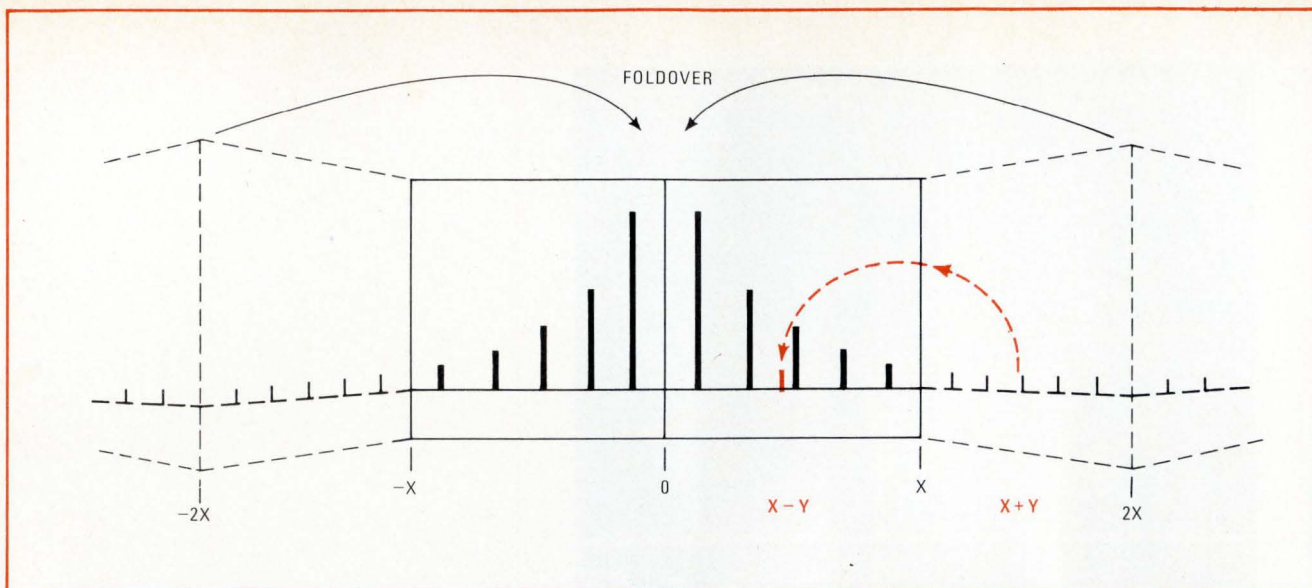

**8. Relation to foldover.** Aliasing occurs systematically as a result of foldover. If sampling rate is  $2X$ , then the foldover frequency is  $X$ —the limit set by the sampling theorem. Frequency components below  $X$  in the waveform being sampled will appear as they ought. A component  $Y$  hertz above  $X$  will actually appear as an alias  $Y$  hertz below it, hence the spectrum display is said to fold over at  $X$ .

high-frequency component, say 100 kilohertz, of a waveform that is being digitized, and that the heavy dots on the sine wave represent 12 digital amplitude samples. However, a 100-kHz sine wave sampled only 1.2 times per cycle yields a sampling frequency of only 120 kHz—too low for complete definition of the 100-kHz component. The frequency that corresponds to the Nyquist criterion is  $120 \text{ kHz}/2$  or 60 kHz—40 kHz below the 100-kHz component. The low-frequency impersonation or alias caused by insufficient sampling of the high-frequency component is shown in Fig. 6 as the dashed sine wave. Note that the alias has a frequency of 20 kHz—40 kHz below the 60 kHz defined by the Nyquist criterion. Since a frequency component 40 kHz above the 60 kHz frequency winds up as a component 40 kHz below it, the 60-kHz frequency is sometimes called the foldover frequency.

The spectra of Fig. 7 demonstrate how aliasing can sometimes be recognized by inspection. The square waves that were transformed for these frequency-domain displays were generated by a computer by the successive addition of odd harmonics. Thus, for the sake of the demonstration, the band limiting of the waveform was controlled very precisely.

In Fig. 7a, the waveform has been limited to components existing below the  $\pm 5$ -kHz folding frequency chosen for this case, and no aliasing is apparent. (The  $\pm 5$ -kHz folding frequency corresponds to the left and right edges of the display.)

If the next higher harmonics are added to the time-domain waveform, undersampling will occur. The aliasing that arises from the undersampling of frequency components above the folding frequency is shown in Fig. 7b, where the additional harmonics have folded about the left and right edges of the display to appear as low-frequency aliases. Their nonsymmetrical placement in the frequency domain and their lower-than-normal amplitudes are clues that aliasing has occurred.

As more and more harmonics are added in the time

domain, more and more frequency impostors are found, as shown in Fig. 7c. There, aliasing has progressed from the left and right edges of the display to fold about zero hertz in the center of the display and then work back out toward the edges again.

Figure 8 shows another way of looking at the folding action that characterizes aliasing. Note that aliasing is not limited to the bounds delineated here, but in theory goes on to infinity.

If components higher than the Nyquist frequency are known to exist in the time-domain waveform being sampled, then aliasing is bound to happen, and a fold-over of high-frequency components in the frequency domain should be expected. If the frequency components of a waveform are not known, then a simple test for aliasing is to sample the waveform, transform it to the frequency domain, and check to see if the frequency-domain function appears to go to zero and remain at zero before the edges of the window are reached. If it does not, aliasing has probably occurred.

Since aliasing arises from insufficient sampling of the original waveform, an obvious cure for the problem is to assure sufficient sampling. But unfortunately, a well-defined high-frequency limit is lacking in some waveforms, for instance, in those with fast rise times or in the responses from high-pass filters.

Here, aliasing can be prevented if the high frequencies are filtered out before the waveform is digitized. Filters used for this purpose are referred to as anti-aliasing filters and are designed to limit the high-frequency content of the filtered waveform to a known and acceptable cutoff frequency.

Probably the most important thing to remember in using the FFT is that certain errors are inherent in the application of digital techniques to analog waveforms. Once the errors and their sources are understood, action can usually be taken to reduce the error. Indeed, all that's needed with some measurements is the ability simply to recognize bad data and then ignore it.  $\square$

# WANTED

## for not impersonating an op amp

Unlike most other comparators, these MC3430-33 high-speed quads don't don the usual op amp spec disguise. We've combined a conglomeration of specs into one helpful parameter that treats the MC3430 series like digital devices rather than op amps. This revealing new spec is called "input sensitivity" ( $V_{IS}$ ).

Traditional comparator specs are a heritage from the early "op amp" development days of linear. But these parameters don't adequately describe comparators with their notably different applications. Like the MC3430-33 quads. They're at home as sense amps in 1103 type MOS memory systems, other computer interface applications, or even control systems. That's where input sensitivity comes to the rescue.

Input sensitivity blends the effects of voltage gain, input offset voltage and input offset current. This provides you with the comparator's differential input requirements to guarantee a given logic state at the output. In short, input sensitivity gives you your worst-case design at a glance.

And just so there are no unexpected surprises, we've even included some usually ignored influences in conventional specing. Like the effects of  $\pm 5\%$  power supply variations, a  $\pm 3.0$  V common-mode voltage range and temperature changes from  $0^\circ$  to  $70^\circ\text{C}$ .

It all adds up to a  $\pm 7$  mV or  $\pm 12$  mV total sensitivity, depending on how stringent your requirements. Both versions are available in either open-collector or three-state TTL compatible configurations. And prices for these 10 fan-out comparators start as low as \$4.00 (100-up) with off-the-shelf delivery.

So just how good is the MC3430-33 series compared with other popular industry standard comparators? The table tells all.

WORST CASE COMPARISONS

Type Number	$T_A = 0 \text{ to } 70^\circ\text{C}$					
	$V_{IO}$ mV Max	$A_{VOL}$ * V/V Typ	Differential Input Voltage Required for 3.0 V Output Change	$R_s = 200\Omega$ $I_{IO}$ $\mu\text{A}$ Max	Error Voltage Generated Into 200 $\Omega$ Source Resistors	Input Sensitivity mV
MC3430, MC3432	—	—	—	—	—	7.0
MC3431, MC3433	—	—	—	—	—	12
MC1711C	5.0	1000	3.0 mV	25	5.0 mV	13
MLM311	10	100 k	0.030 mV	70**	0.014 mV	10.04
MNE521	10	4000	0.75 mV	12	2.4 mV	13.15

\*Typical values given, as minimum gain not always specified.

\*\* $I_{IO}$  measured in nA.

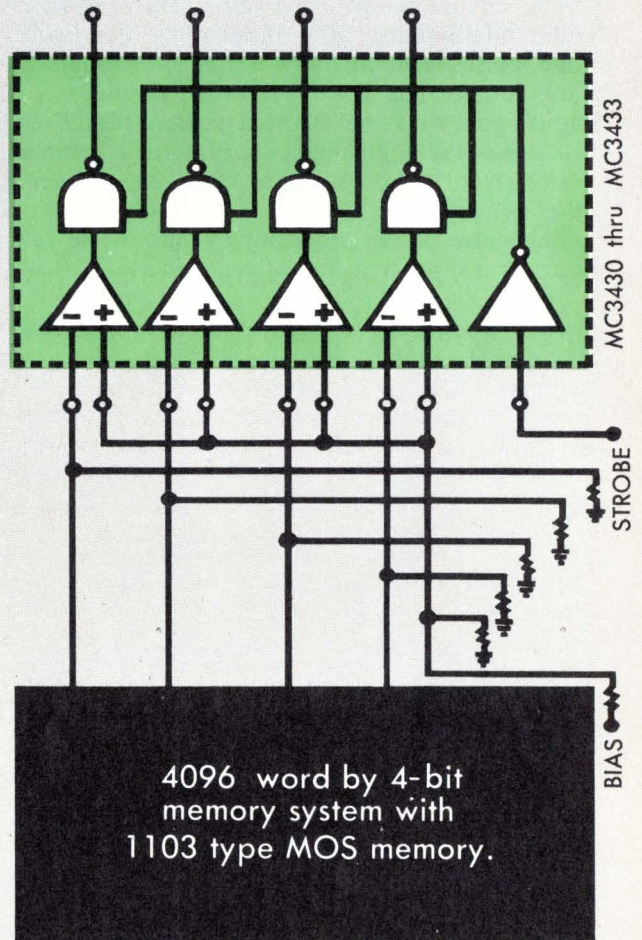

Hopefully, your curiosity is peaked. Satisfy it by capturing the MC3430-33 comparator data sheet which details our unique new parameter. Correspond to P.O. Box 20912, Phoenix, Arizona, 85036, or circle the reader service number below.

Now you've got their complete description.

And we've got the MC3430-33 high-speed quad comparators.

Seize them and reap the rewards.



**MOTOROLA LINEAR**

—practical innovations for systems design!

Circle 103 on reader service card

## Synchronous noise blanker cleans up audio signals

by M.J. Salvati  
Sony Corp. of America, Long Island City, N.Y.

Fluorescent lights, gas rectifiers, neon lamps, SCRs, and triacs all produce a substantial rf signal that often radiates through their power-line connections and interferes with nearby communications receivers. This type of radio interference desensitizes the receiver and makes the recovered audio signal very difficult to understand.

The circuit shown here significantly improves the audio intelligibility of a receiver by eliminating the noise pulses generated by a single dominant nearby noise source. The noise pulses are removed from the audio signal with only slight distortion. Moreover, since this noise-blanking circuit is not internally connected to the receiver, it can be moved from one receiver to another as needed.

The noise pulses produced by power-line radiation occur at a repetition rate of twice the local power-line

frequency. Since the noise-blanking circuit is driven by the same power utility as the noise source, the output signal from the bridge-rectifier section of the noise blanker will have the same rate as the noise pulses.

The source of the blanking pulses, therefore, is independent of the input audio signal. The blanking pulses cause the FET gate (transistor  $Q_1$ ) to conduct to silence the receiver. Since the blanking pulses are not derived from the input signal, their timing does not depend on the shape and rise time of the noise pulses, nor is it affected by the modulation characteristics of the desired signal.

The output from the bridge rectifier is shaped by a Schmitt trigger that drives a dual monostable multivibrator. The first monostable ( $MONO_1$ ) delays the blanking pulse, which is produced by the second monostable ( $MONO_2$ ), relative to the rectifier's output. The delay is variable so that the blanking pulse can be positioned to coincide with the noise pulse.

The width of the blanking pulse is determined by resistor  $R_1$  and capacitor  $C_1$ . The fast rise time of the blanking pulse (from  $MONO_2$ ) is slowed down by the low-pass filter formed by resistor  $R_2$  and capacitor  $C_2$ , thereby minimizing the distortion of the recovered audio signal. □

**Eliminating power-line noise.** Circuit for audio receivers generates blanking pulses to cancel power-line noise that produces unwanted rf interference. The blanking pulses are derived directly from the line, making them independent of the input audio signal. The noise pulses and the blanking pulses, therefore, occur at the same repetition rate, and the variable delay of  $MONO_1$  permits easy synchronization.

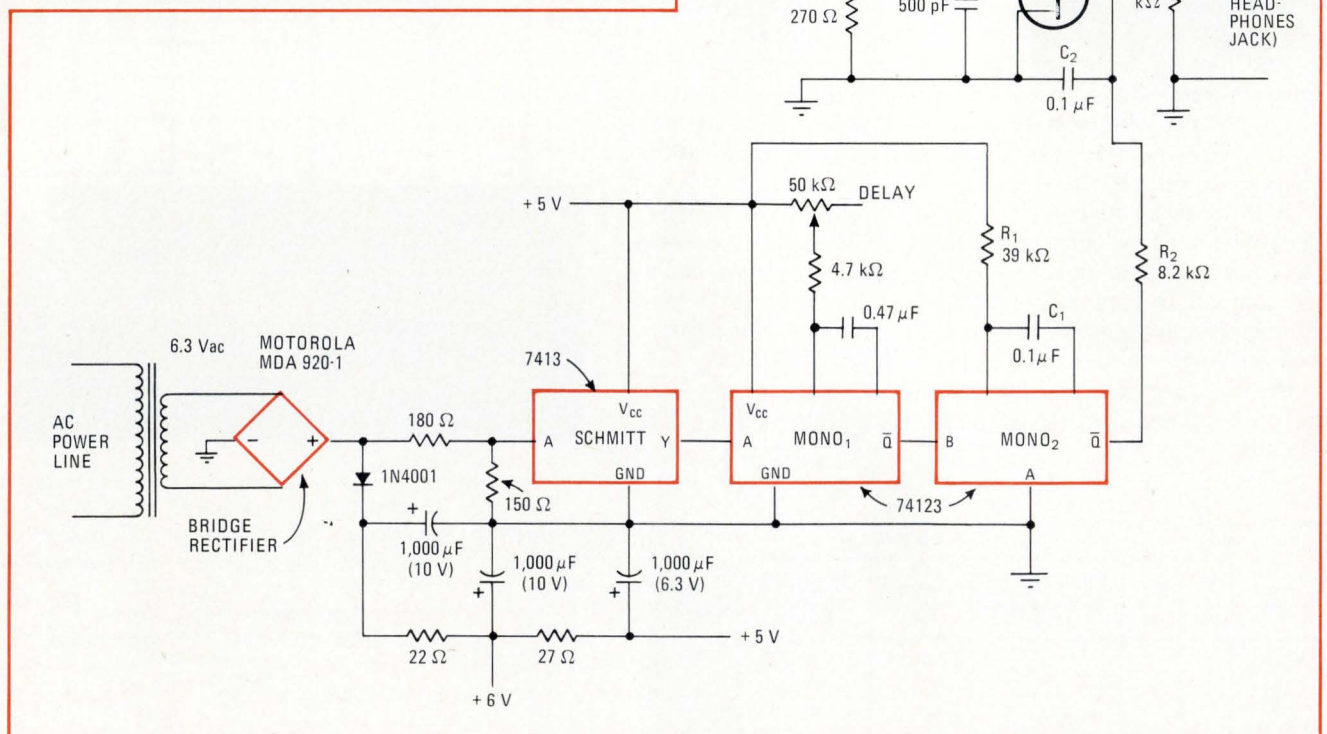



# Variable voltage source has independently adjustable TC

by Nathan O. Sokal  
Design Automation Inc., Lexington, Mass.

A reference voltage source, which is built around a suitably stable general-purpose operational amplifier, offers an adjustable output-voltage magnitude, as well as an adjustable output-voltage temperature coefficient. Both the voltage magnitude and the temperature coefficient may be varied independently of each other.

The output voltage can be positive or negative, and it is continuously variable from 0.7 to 13 v. The temperature coefficient is also continuously variable, from  $-0.3\%/^{\circ}\text{C}$  to  $+0.3\%/^{\circ}\text{C}$ . For the circuit shown in the figure, the output voltage is positive. To obtain a negative voltage, the polarities of all the diodes and the supply (except to the op amp) are simply reversed.

The temperature coefficients of the zener-diode voltage, the resistance values, the op-amp input offset voltage, the op-amp input bias and offset currents, and the power-supply voltage need not all be zero. Rather, their values as functions of temperature must be stable with time and retrace well with temperature cycling. This is also true of the V-I characteristics of diodes  $D_1$  and  $D_2$ . Moreover, these two diodes do not have to be matched.

If a narrower range of output voltage is adequate, part of resistance  $R_1$  should be a stable fixed resistor. Likewise, if a narrower temperature-coefficient range is satisfactory, part of resistance  $R_2$  should be a stable fixed resistor. Resistances  $R_1$ ,  $R_2$ , and  $R_3$  should be multi-turn potentiometers if both wide-range adjustment and high resolution are desired. Or they should be combinations of potentiometers and fixed resistors if a narrow adjustment range will do. Or they should be

only fixed resistors when the desired output voltage and temperature coefficient need not be adjusted.

The fixed resistors used in this circuit should be film or wire-wound types for good long-term stability. A reference-type zener diode, such as the 1N4894, will improve voltage stability still further. All the resistors and semiconductor devices should be thermally coupled to each other for a good transient response to changes in ambient temperature.

A simple procedure can be followed to adjust the circuit to desired operating conditions. First, set potentiometers  $R_1$  and  $R_2$  approximately at their mid-range positions. Then adjust potentiometer  $R_3$  until the voltage across  $R_2$  is zero at the reference temperature. This is the temperature at which it must be possible to adjust the temperature coefficient without changing the output voltage. Next, position potentiometer  $R_1$  to give the desired output voltage at the reference temperature.

The last step is to adjust potentiometer  $R_2$  for the desired temperature coefficient. This adjustment, which should not affect the output voltage at the reference temperature, can be made by heating or cooling the entire circuit to some temperature other than the reference temperature and then adjusting  $R_2$  to obtain the desired output voltage at that temperature.

As a precaution, the circuit's output voltage should be checked for changing temperature. If it is not within the desired tolerance, repeat all the adjustment steps but the first one. Usually no such repetition will be needed.

More output current can be obtained from this reference voltage source by adding an npn power transistor, wired as an emitter-follower, at the circuit's output. The output from the op amp goes to this transistor's base, and resistor  $R_1$  is then connected to the transistor's emitter, which becomes the circuit output. If the output voltage is negative, a pnp emitter-follower should be used. Without an emitter-follower, the output current can be as large as 10 milliamperes for most general-purpose op amps. □

**Stable voltage source.** The output voltage of this reference voltage source can be adjusted from 0.7 to 13 volts. And the circuit's output-voltage temperature coefficient is also adjustable, from  $-0.3\%/^{\circ}\text{C}$  to  $+0.3\%/^{\circ}\text{C}$ . These two adjustments are independent of each other. Potentiometer  $R_1$  sets the output voltage, potentiometer  $R_2$ , the temperature coefficient, and potentiometer  $R_3$ , the reference temperature.

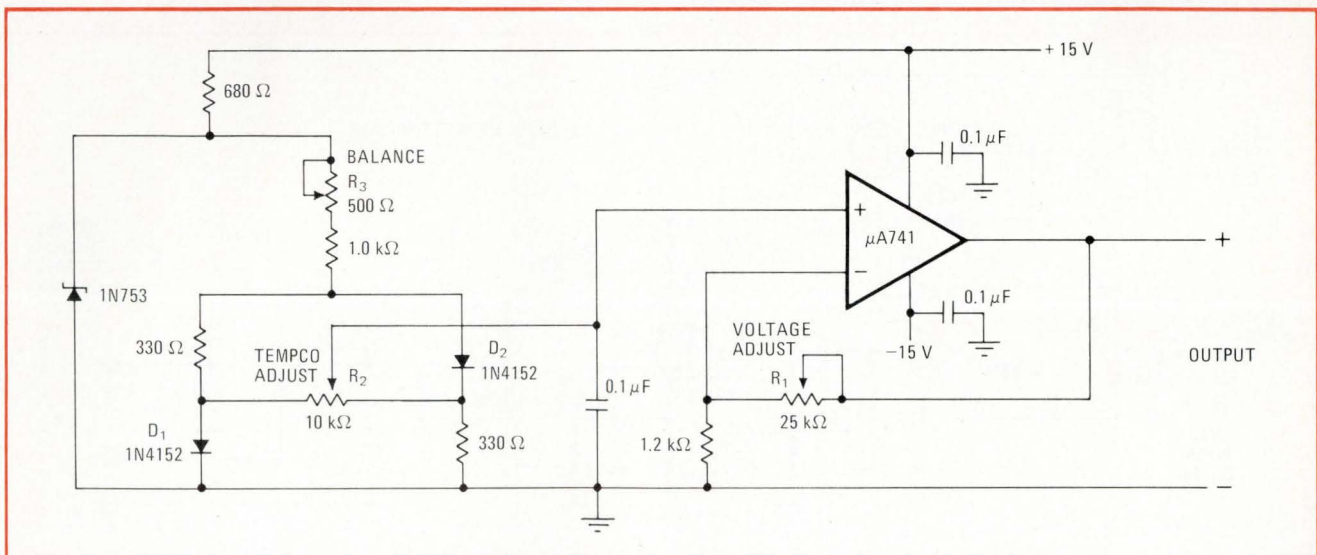

# Switched frequency doubler provides multiple outputs

by Michael F. Black  
Texas Instruments, Systems Analysis Section, Dallas, Texas

Frequency doublers that operate in the vhf/uhf range typically consist of complicated arrangements of saturated amplifiers, tuned circuits, and harmonic-suppression traps. With these circuits, a constant input impedance is usually difficult to sustain with changing temperature. Also, if the doubler must be switched, it is difficult to maintain circuit simplicity and high isolation ratios.

The switched frequency doubler shown here, however, provides high harmonic rejection, as well as constant input impedance, and it requires a minimum of adjustment. The circuit, which consists of a double-balanced mixer followed by a linear amplifier, accepts a 50-megahertz input of 5 dBm. In addition, it has provision for fast on/off switching and multiple 100-MHz outputs to 50-ohm loads.

The input power is split by the two-way power divider, HY1, and applied to the RF and LO ports of the mixer, M1. The mixer output, of course, is made up of several frequencies: twice the input frequency, the input frequency itself, the difference frequency (between the input and the local oscillator), and harmonics.

The difference frequency, which is dc, is shorted by the rf choke ( $L_1$ ), and the input-frequency component is attenuated by the LO/i-f and rf/i-f isolation of the mixer. Transistor  $Q_1$  is tuned to the doubled frequency, and the high-Q circuit in its collector loop further attenuates the unwanted frequencies to about 50-dB down. Through inductor  $L_2$ , the matching structure of this collector loop provides the only circuit adjustment.

Only three 50-ohm outputs are shown here, but more

can be added. For each output, two capacitors ( $C_1$  and  $C_2$ ) transform the 50-ohm load up to a resistance value that output transistor  $Q_1$  can drive satisfactorily. The reactance of inductor  $L_2$  then tunes out the capacitance to present a high-value real load to  $Q_1$ 's collector at the doubled frequency.

The value of  $L_2$ 's reactance is:

$$X_{L2} = (1/3)(R_P/Q)$$

where  $R_P$  is the load resistance that transistor  $Q_1$  sees, and  $Q$  is the circuit's figure of merit. The reactances of the transformation capacitors,  $C_1$  and  $C_2$ , are also dependent on  $R_P$  and  $Q$ . They can be expressed as:

$$X_{C1} = [R_P/(1 + Q^2)][Q - [(50/R_P)(1 + Q^2) - 1]^{1/2}]$$

$$X_{C2} = 50/[(50/R_P)(1 + Q^2) - 1]^{1/2}$$

Circuit  $Q$  is selected according to the harmonic rejection required. The higher the value of  $Q$  is, the higher the harmonic rejection will be, but the more difficult some component values may become to obtain. For the circuit given here:

$$Q = 6$$

$$R_P = 1.5 \text{ kilohms}$$

$$X_{L2} = 83 \text{ ohms at } 100 \text{ MHz} = 0.13 \text{ microhenry}$$

$$X_{C1} = 222 \text{ ohms at } 100 \text{ MHz} = 6 \text{ picofarads}$$

and:

$$X_{C2} = 104 \text{ ohms at } 100 \text{ MHz} = 15 \text{ pF}$$

Each output of the circuit supplies a power level of +3 dBm at a frequency of 100 MHz.

Transistor  $Q_2$  is a nonsaturating switch that is compatible with a TTL open-collector input. Together with its associated circuitry, transistor  $Q_2$  switches transistor  $Q_1$ , providing the multiple gated outputs. Switching times of well under 1 microsecond can be realized when an appropriate value is chosen for capacitor  $C_3$ . The circuit's on/off isolation is better than 50 dB. □

Designer's casebook is a regular feature in Electronics. We invite readers to submit original and unpublished circuit ideas and solutions to design problems. Explain briefly but thoroughly the circuit's operating principle and purpose. We'll pay \$50 for each item published.

**Rf frequency doubler.** From a 5-dBm input at 50 megahertz, this switched frequency doubler develops multiple 3-dBm outputs at 100 MHz, seen by output transistor  $Q_1$  so that the circuit can handle 50-ohm loads with relative ease. The doubler's only adjustment, inductor  $L_2$ , is used to tune out this added capacitance. Transistor  $Q_2$  is used to switch transistor  $Q_1$ .

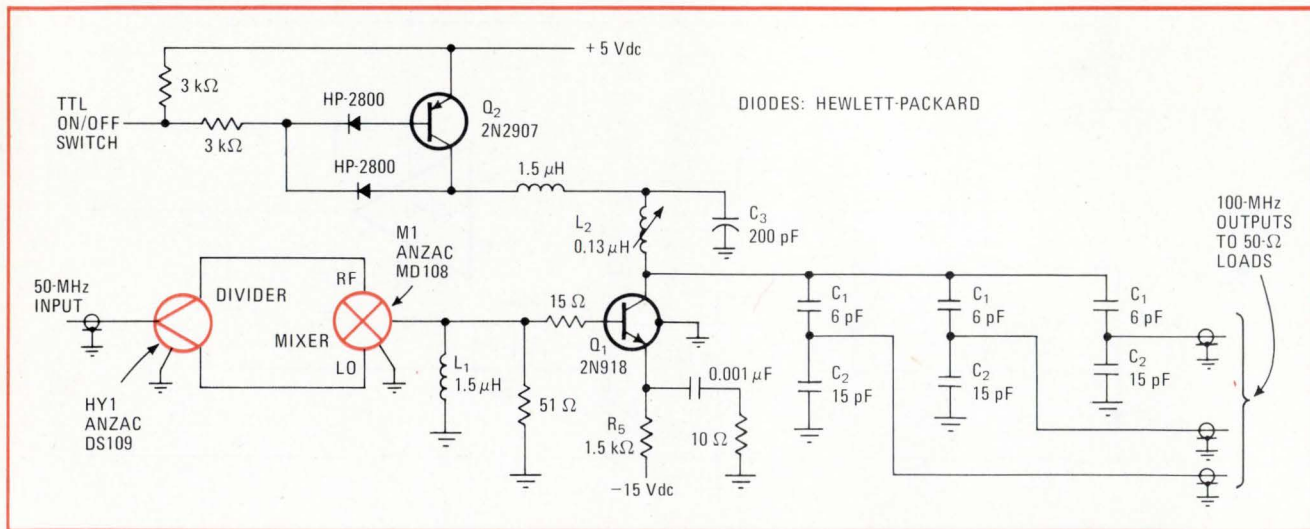

A New Standard For Accuracy!

# 3½ Digit A/D Converter

The LD110/LD111 A/D converter sets the pace for accuracy with a specification of 0.05% of reading,  $\pm 1$  digit. The set consists of two ICs, and with the addition of a reference voltage and clock becomes a full 3½-digit analog-to-digital conversion system. LD110/LD111 features and specifications make the converter set an ideal choice for digital display processors in

- DPMs
- Thermometers
- DVMs
- Scales
- Controllers
- Tachometers
- Instrumentation

#### Specifications

- Accuracy of 0.05% of reading,  $\pm 1$  count
- $Z_{IN} > 1000 \text{ M}\Omega$
- 4 pA typical input bias current (25°C)
- 100  $\mu\text{V}$  resolution (200.0 mV range)
- 40 dB NMRR @ 60 Hz

#### Features

- Auto-zero minimizes effect of offset, drift and temperature
- Auto-polarity
- Sampling rates from 1/3 to 12 samples/second
- Two voltage ranges: 2.000V and 200.0 mV
- TTL-compatible outputs
- \$28.60 per set (100-set price)

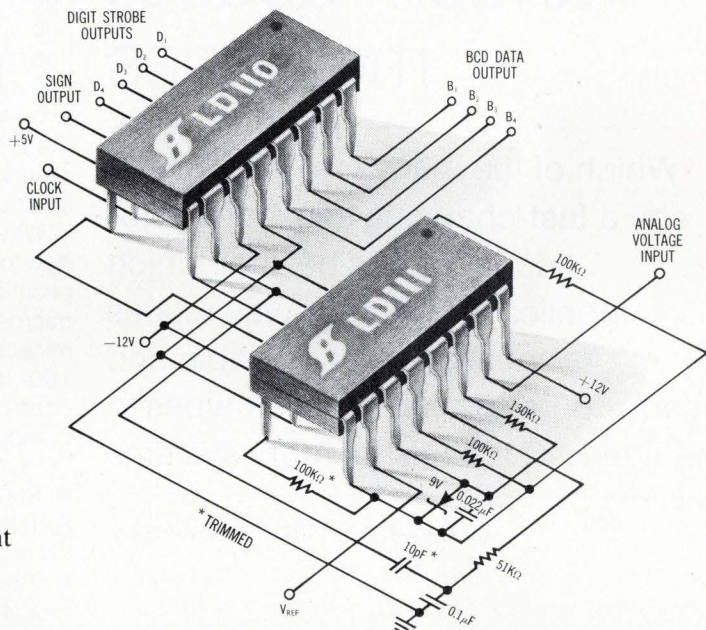

The unique conversion technique uses a single reference and a single full-scale adjustment to achieve a highly-accurate strobed 3½-digit output of up to 3100 counts plus sign. LD111 analog processor employs monolithic PMOS/bipolar construction and interfaces directly with the LD110 digital processor, which has a monolithic PMOS structure. For further information

## write for data

IC Applications: (408) 246-8000, Ext. 120



Siliconix incorporated

2201 Laurelwood Road, Santa Clara, California 95054

# Semiconductor random-access memories

Which of the many RAMs spawned by a fast-changing semiconductor technology is best for which application? This survey relates the capabilities of available and soon-to-be-available device types to the needs of today's memory systems

by Laurence Altman, *Solid State Editor*

□ No segment of the semiconductor market has grown faster in the last few years than semiconductor random-access memories.

For every RAM-on-a-chip being used in 1972, 50 are being used today. Consumption has gone from 3 million units to over 75 million, adding up to nearly 75 billion bipolar and metal-oxide-semiconductor bits.

Available device types have multiplied from just two—the 1,024-bit dynamic p-channel MOS RAM and the small (64-bit and 256-bit) bipolar array—to at least six distinct RAM types based on a dozen different bipolar and MOS techniques (see table).

Where core once reigned, 70% of new memories are now being designed with semiconductor devices. Applications span every kind of memory system, from the microsecond, micropower requirements of today's terminals and portable memory equipment, through the 100- to 500-nanosecond mainframe and peripheral controller applications, right down to the fastest 20-ns computer buffer and scratch-pad functions.

Figure 1 shows the three functional categories:

- Static bipolar and dynamic n-channel 1,024-bit RAMs for very fast scratch pads, buffers, and mainframe memories.
- The old 1,024-bit dynamic p-channel RAMs and the new 4,096-bit dynamic n-channel RAMs for low-cost, medium-speed main memories and as alternatives for peripheral, terminal, and microprocessor applications.
- The new static RAMs—easy-to-use 1,024-bit n-channel MOS and 256- and 1,024-bit complementary MOS arrays—for the small peripheral and terminal systems that often need low power dissipation but almost never high speed.

### Scratch pad, buffer, and cache

Only bipolar arrays have a short enough access time to handle the fastest (20 ns) scratch-pad requirement. Moreover, their read time cycle time equals their read access time and does not handicap system speed.

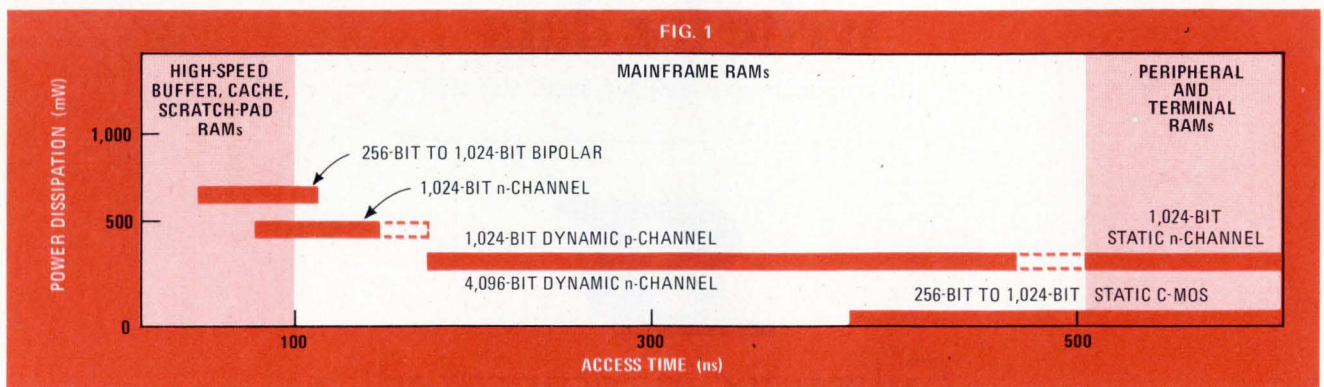

But for most buffer and cache memory, the 50- to 80-ns reach of n-channel dynamic MOS devices is good enough. Their problem is not access time, which may be as short as in some bipolar RAMs, but cycle time, which is three times as long as the access time and may slow up over-all system speed. Bipolars are therefore better for those cache memories that are cycle-time-limited, as well as for those scratch-pad memories that perform a read/modify/write cycle.

Also troublesome in n-channel RAM system designs is managing the large current transients of about 20 milliamperes caused by power and clock pulses during the memory cycle. These transients are absent in the static, clock-less bipolar devices, and their presence in the n-channel MOS RAMs may require a looser layout that uses up more board space and more design time.

High clock voltage is another n-channel system overhead, and so too are interface logic circuits, whereas bipolar RAMs, being TTL or ECL designs, are automatically compatible with logic. These factors, together with the increasing availability of Schottky TTL, oxide-isolated TTL, and ECL 1,024-bit RAMs, must be weighed against the generally lower power consumption and component costs of n-channel RAMs.

## Main memory

As the cheapest way of satisfying medium-speed mainframe and large peripheral controller needs, the new 4,096-bit n-channel RAMs far outdo the 1,024-bit

p-channel types. (The very fast mainframe will probably stay with the speedy 1,024-bit n-channel RAM.) Packing four times as much memory as the same size of chip and operating at about the same speed as the p-channel devices, the newer type potentially offers a 4:1 cost-per-bit advantage. The n-channel device also cuts system costs a lot, since its address and data lines interface directly with TTL, it has simple clocking, and it consumes no more power per chip.

Although availability is likely to be spotty till 1975, 4,096-bit chips have already been designed into microcomputers, minicomputers, and add-on systems. At present, the situation is changing almost daily, but three types are vying for industry dominance. To classify them by the company of their origin:

- Intel/TI's 22-pin package, announced by Intel and then modified by TI, uses TTL voltage levels for all address, data-in, and data-out lines; it requires only one high-voltage clock level but needs three power supplies.

- Motorola/AMI's 22-pin package differs in having an extra reset pin, which must be energized when power is first applied.

- Mostek's 16-pin package takes up less board space than the other two, at the cost of some added system complexity in clocking and interface logic, since the device must be multiplexed; it is also TTL-compatible at all inputs, including the clock input.

Perhaps the biggest surprise has been the static

THE RAM FAMILIES

Type	Typical speeds, access/cycle (ns)	Power per chip active/standby (mW)	Applications
Bipolar: 64-to-256-bit ECL / TTL 1,024-bit ECL / TTL	20 - 50 / 20 - 50 60 - 90 / 60 - 90	350 / 350 500 / 500	Computer scratch pads. Buffer memories. Accumulator registers. Control stores. Caches.
1,024-bit dynamic n-channel (7001 and 2205 types)	60 / 180	450 / 60	50-ns caches. Add-on mainframe memory. Buffer memories. In high-speed controllers.
1,024-bit p-channel (1103 or 6002)	300 / 600	450 / 60	Medium-speed mainframe. Add-on mainframe memory. Minicomputer memory. In terminals. In small controllers.
4,096-bit n-channel	200 - 350 / 400 - 700	350 / ≅ 30	Major core replacement. Computer mainframe memory (micro, mini, and 360 types). Also large mainframe, add-on, and fast peripheral memories.
1,024-bit static n-channel (2102 types dash versions)	1,000 / 1,000 500 / 500	350 / 90 350 / 90	Small memory systems. In peripherals. In terminals. Display memory.
C-MOS static 256-bit 1,024-bit	350 / 350 600 / 600	20 / 0.2 (μW) 30 / 0.3 (μW)	In peripherals. In point-of-sale units. In minicomputers, microcomputers, and calculators. In medical instruments, avionics, and portable equipment.

1,024-bit n-channel MOS RAM, sales of which are growing fastest of all RAMs. Introduced by Intel two years ago, it is now supplied by several other manufacturers, and 10 million units could well be sold this year.

**The static MOS RAM comes to life**

MOS memory designers originally switched to dynamic cells to escape the slowness and largeness of static memory. But silicon-gate n-channel processing raised speeds and reduced size enough to revive interest in simpler-to-use static designs.

That interest has swelled, because the 1,024-bit statics operate from single 5-volt supplies, are directly compatible with bipolar logic, and dissipate relatively little power when operating (though dc power drain is fairly high). Also, the latest designs are getting faster—down from 1 microsecond to 500 ns and below—and this will increase penetration into some small mainframes. Primarily, though, the static n-channel RAMs are for small (16-kilobyte) peripheral memories, where high speed is not needed but low system overhead is.

The newest RAMs are C-MOS devices, today generally at the 256-bit level of integration, by year's end possibly at the 1,024-bit level. Their chief attractions are low power dissipation (particularly their microwatt standby power), high noise immunity, and high power-supply tolerance, all of which makes them useful outside the traditional computer market in industrial and portable equipment. At 10 cents a bit, they're expensive, but cost will drop with experience and volume.

Moreover, many foresee the C-MOS RAMs proliferating throughout the computer memory hierarchy as they're improved by, for example, the use of insulating substrates like sapphire, which boost speed and increase chip packing density. And the prospect of power-supply-insensitive, noise-immune 1,024-bit and 4,096-bit static C-MOS-on-sapphire RAMs, operating off 5 V at speeds below 100 ns, is very appealing.

**What it all costs**

Finally, what's happening to that all-important parameter—cost? Figure 2 charts the trends in semiconductor memory costs (core cost is included for comparison). Clearly, today's semiconductor memory products are in the high-growth sharp-cost-reduction part of their cycle. Even so, the 1,024-bit n-channel statics and the just introduced 4,096-bit RAMs are already priced below core, and the 1,024-bit n-channel dynamic products should join them in 1975.

Indeed, the 4,096-bit devices are expected to approach 0.1 cent per bit in the next few years—an encouragement to designers, who have been watching the fraction of total system cost due to memory climb steadily and so far irreversibly to about 40%. □

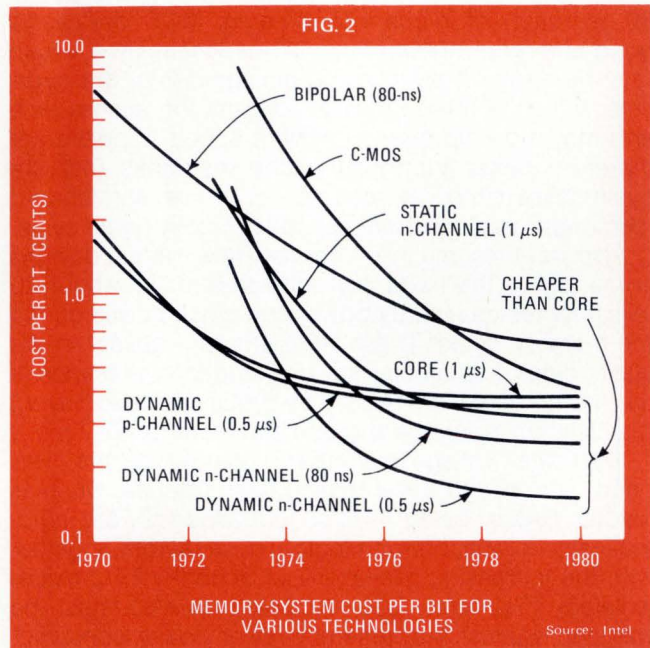

**Glossary**

A random-access memory, or *RAM*, is one in which any data word of information may be accessed in any order. Semiconductor RAMs are always *read/write*—you can enter or remove data in any cycle. Semiconductor read-only memories, or *ROMs*, on the other hand, may or may not be read/write, but they are always random-access. Both should be distinguished from *serial* memories, like shift registers, first-in first-outs, and so on, where bits can be accessed and recycled only serially. *Cycle time* is the time it takes to complete an operation. In a cycle you can *access* data (read), *enter* data (write), read and write, and *update* or *modify* the state of a memory location. While cycle times of *dynamic* MOS memories are always longer than access times, a bipolar memory's cycle time is about the same as its access time, because it is *static* and requires no *refresh*—a program is entered only once and can be updated but need not be refreshed. Static MOS memories have the same advantages but are much slower than dynamic MOS memories, which, however, must be refreshed about every 2 milliseconds and therefore need *refresh clocks*, as well as additional power supplies.

**SOME MORE READINGS**

For an in-depth look at where and how LSI RAMs are being used in systems, see two *Electronics* Special Reports by L. Altman, Solid State Editor (Aug. 28, 1972, p. 63) and W. B. Riley, Computers Editor (Aug. 2, 1973, p. 75). Economic advantages are analyzed in an IEEE Intercom '74 paper by Intel Corp.'s A. C. Markkula Jr., "Semiconductor Memory Costs: Present and Future," while the system designer is helped in another Intercom '74 paper, "Perspectives of Semiconductor Memory from the System Viewpoint," by Burroughs Corp.'s J. Reese Brown Jr. Finally, several chapters in "Large- and Medium-Scale Integration" deal with RAM processing and applications. Edited by *Electronics*' Executive Editor, S. Weber, the book has just been published by McGraw-Hill Book Co. for \$15.

# Digital introduces the GT44 Graphics System.

**For \$34,500 you get the price/performance leader in graphics computing.**

There's nothing comparable for the price.

Complete with hardware and software. Including our advanced 16-bit PDP-11/40 CPU, 16K words of 980 nano-second internal memory, two 1.2-million word removable cartridge disks, new 17-inch CRT display, display processor (complete with character and vector generation) and light pen, Digital's own 30 cps console

terminal, and our graphics-supported disk operating system with BASIC.

And it's a totally flexible system. Add peripherals. Develop new software using the CRT. Monitor and direct experiments, design interactively. In fact, do any of the things you wanted a graphic computer capability for and couldn't afford till now. But don't take our word. Come to

Digital and see for yourself. Draw your own conclusions.

Contact your local Digital office, or write: Digital Equipment Corporation, Maynard, Mass. 01754. European headquarters: 81 route de l'Aire, 1211 Geneva 26. Digital Equipment of Canada Ltd., P.O. Box 11500, Ottawa, Ontario K2H 8K8.

**digital**

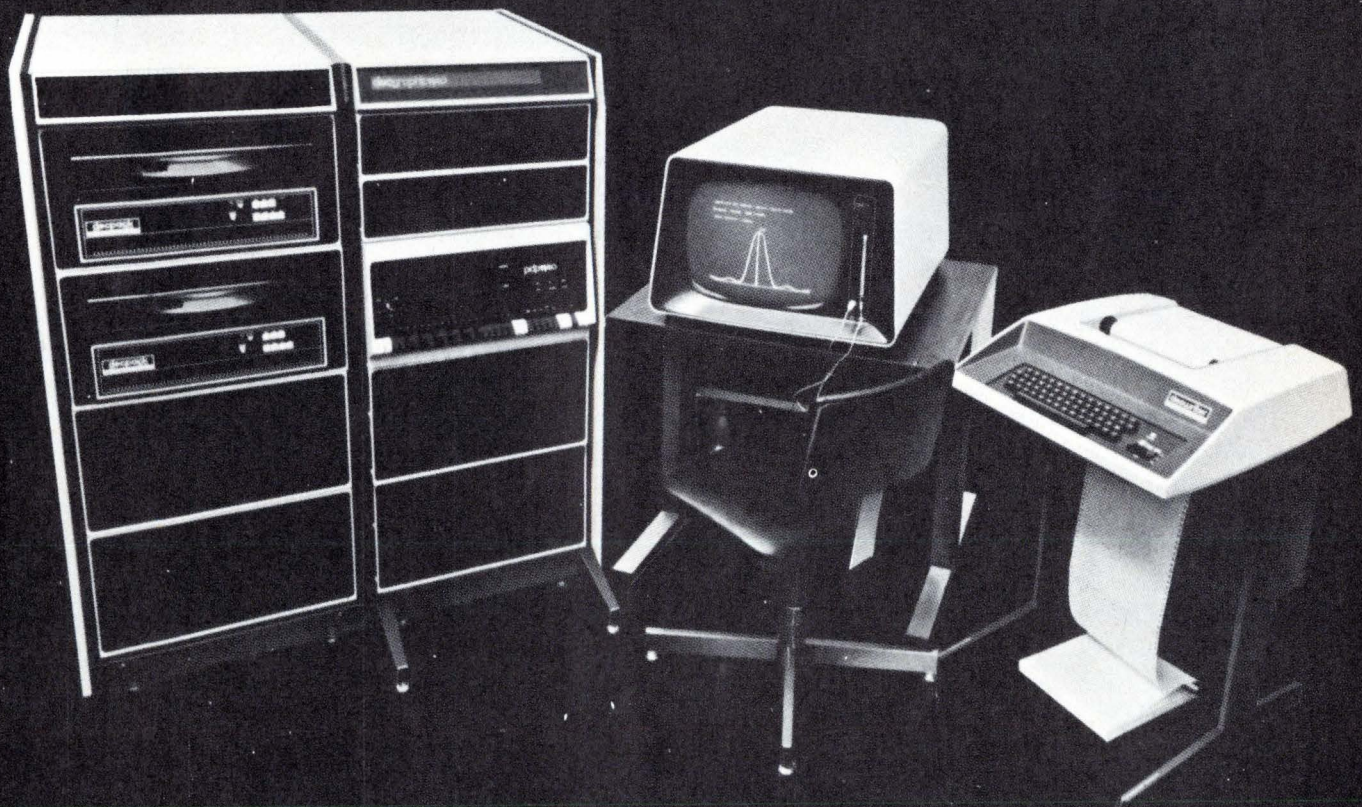

# The widest selection of analog CMOS switches and multiplexers.

## Available now.



Get them all from one source. And get them fast. 4-, 8- and 16-channel multiplexers. Quad and dual SPDT switches.

Some of our designs you've never seen before. They'll give you specs, functions, and package options you can't order anywhere else.

And we've got other designs you'll recognize right away. You probably ordered them from someone else a while ago — and you're still waiting for delivery.

Check them out. They'll give you the design benefits of CMOS — and the lowest power dissipation you can get.

### The multiplexers:

AD7501 8-channel  
AD7502 differential 4-channel.  
AD7503 8-channel.

AD7506 16-channel.  
AD7507 differential 8-channel.

### The switches:

AD7510/AD7511/AD7519 quads.  
AD7512 dual SPDT.  
AD7513 dual.  
AD7516 quad.

Get it only from us. Again, only from us.

A replacement for HI1818.  
Replaces DG506.  
Replaces DG507.

You can't get them anywhere else. Another that's ours alone. Use it instead of DG200. Instead of CD4016A.

### The price is right.

So give us a call — to order or to ask for our new catalog. It'll tell you everything you need to know about our entire line of analog CMOS switches and multiplexers.

East Coast: (617) 329-4700.

Midwest: (312) 297-8710.

West Coast: (213) 595-1783.

Our analog CMOS switches and multiplexers, like our AD7520 CMOS DAC, are more innovative uses of advanced technology — to keep you (and us) a step ahead of everyone else.

Analog Devices, Inc., Norwood, Mass. 02062.





# Air through hollow cards cools high-power LSI

Providing parallel flow through hollow-core cards and wafer-mounted heat exchanger can cut temperatures at no cost in space

by Lou Laermer, Singer Co., Kearfott Division, Wayne, N. J.

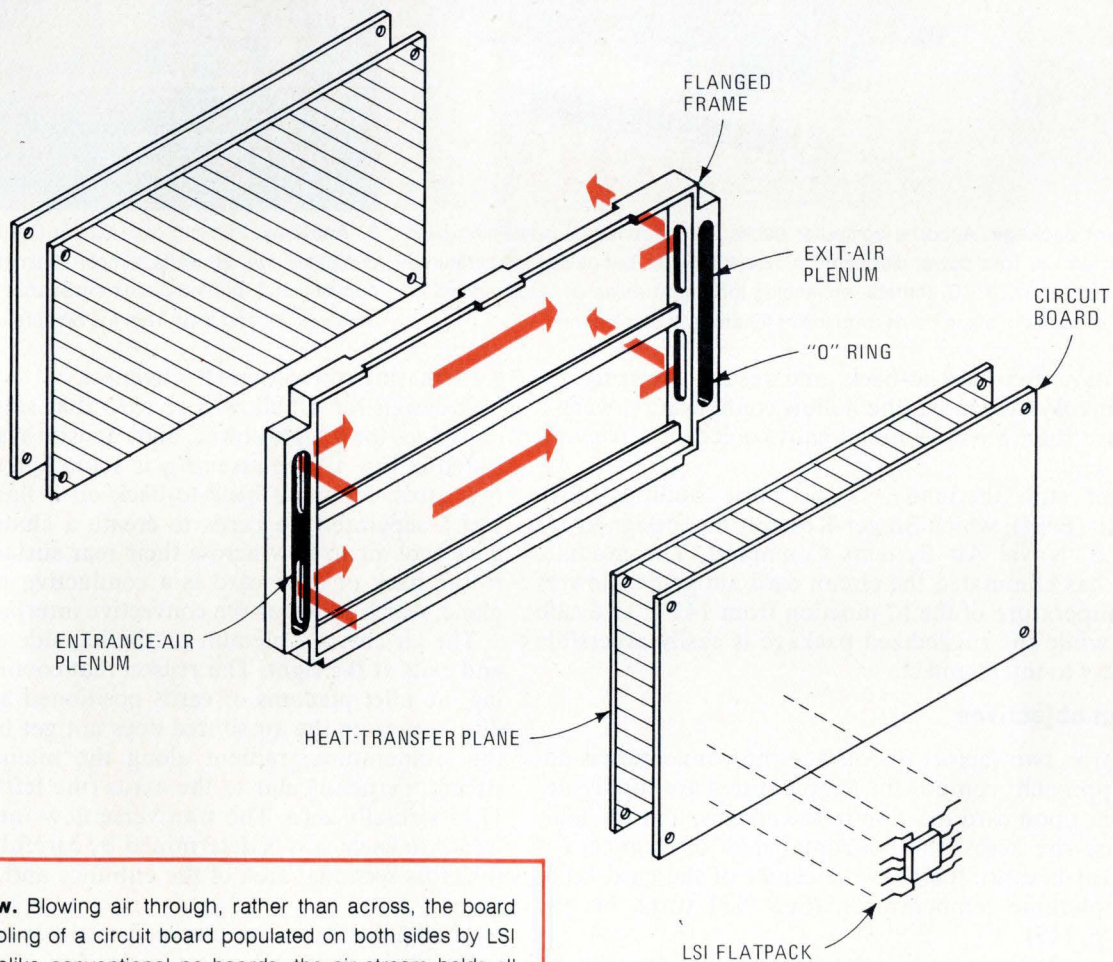

**1. It's hollow.** Blowing air through, rather than across, the board optimizes cooling of a circuit board populated on both sides by LSI packages. Unlike conventional pc boards, the air stream holds all components near the same temperature.

□ Circuit designers are excited about the tremendous functional capability of LSI, and they are constantly trying to increase the number they can pack on each printed-circuit board. However, dense packing of thousands of active, heat-producing devices on a square inch of circuit card places an awesome burden on the packaging engineer.

Traditional cooling methods are becoming increasingly inadequate, especially with densely packed high-power LSI devices, because power density, in watts per

cubic inch, is much higher, and thermal paths from the heat-producing devices to the cooling medium are too long. It's not unusual for a logic card of 25 square inches, which once dissipated 2.5 watts, to dissipate 20 w when mounting LSI and MSI devices.

However, thermal paths can be shortened and temperatures of device junctions held well below safe values by using a patented hollow card so that the heat exchanger becomes an integral part of the circuit card. Air circulates through a channel between the two circuit

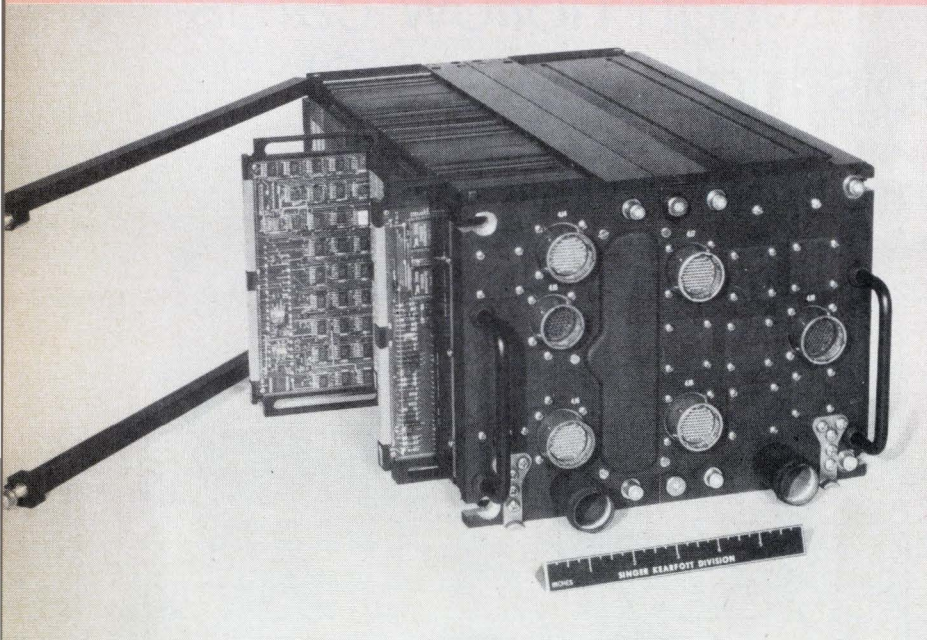

**2. Potent package.** Airborne computer packs 35 hollow cards containing over 2,500 flatpacs. Total power dissipated is over 400 watts, but device temperatures never climb above 75°C, thereby enhancing long-term reliability. Slots shown in the top and bottom of the cards form the entry and exit air plenums.

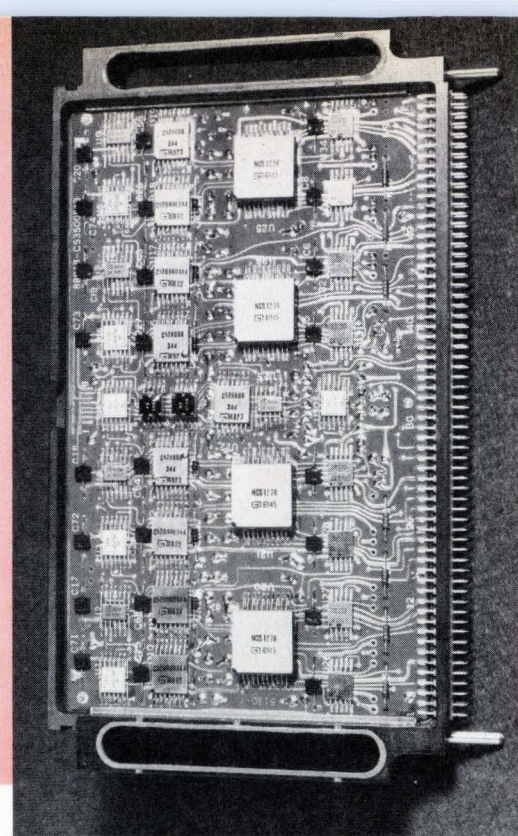

**3. Anatomy.** Packing over 60 LSI flatpacs, this card dissipates over 20 watts, almost 10 times more than its conventional printed-circuit-card ancestor. Cool air enters at left and exits through the plenum at right.

cards mounted back-to-back, and results are truly astounding. What's more, the hollow configuration weighs no more than a conventional card cooled in a conventional way.

Better still, thermally, is the basic building-block module (B<sup>3</sup>M), which Singer-Kearfott has designed for the U.S. Naval Air Systems Command. The module, which has eliminated the circuit card altogether, lowers the temperature of the IC junction from 141°C to a safe 68°C, while the ruggedized package is easily accessible and easy to interconnect.

### Design objectives

Clearly, two factors discourage the conventional design approach: component temperatures are highly dependent upon card location in the chassis, and the temperature rise across the horizontal span of each card is too great because ICs near the center of the card build up intolerable temperatures. (See "LSI turns up the heat," p. 115).

True, a designer could use heat pipes, but they are expensive. A better and cheaper solution is to introduce cooling air at a common temperature to each card and then circulate the air directly through each card. This can be done most effectively by circulating air through a hollow-core card.

The configuration of the hollow-core card provides improved cooling by:

- Eliminating the thermal conducting path across the breadth of the circuit card.
- Replacing series air distribution with parallel air distribution.
- Increasing convection area per circuit card.

### ■ Increasing convection effectiveness.

A design for a hollow-core card that satisfies design objectives for a high-power, high-density system is illustrated in Fig. 1. The assembly is actually a sandwich of two cards, mounted back-to-back on a flanged frame, which separates the cards to create a channel that allows cool air to flow across their rear surfaces. Bonded to the back of each card is a conductive heat-transfer plane, which serves as the convective interface.

The air enters a plenum on the left side of the frame and exits at the right. The reason that cooling air entering the inlet plenums of cards positioned at increasing distances from the air source does not get hotter is that the temperature gradient along the main air-cooling stream, perpendicular to the cards (the left side of Fig. 1), is virtually zero. The transverse flow rate at the entrance to each card is determined by careful selection of the cross-sectional area of the entrance and exit air plenums.

The hollow cards are clamped together by straps between their front and rear panels. The upper pair appears in Fig. 2. The lower straps (not shown) serve as a subchassis that supports the motherboard and the mating connectors for each card.

A close-up of a hollow-card assembly that mounts LSI flatpacs is shown in Fig. 3. Note that gaskets line the edges of the cooling-air entry and exit plenums to prevent air leakage. Besides assuring a uniform temperature at each card-inlet plenum, parallel cooling maintains a virtually constant air-pressure drop, regardless of the number of cards. In the traditional chassis-type heat exchanger, the card interface temperatures increase as cards are added so that the cooling effectiveness falls off

## LSI turns up the heat

When it was populated by discrete components, the card shown below cooled the circuits on it admirably. But when large-scale integration multiplied the power density to as much as 500 milliwatts per square inch, this configuration could no longer fill the bill. Originally designed for an airborne computer, the chassis contained 35 cards that dissipated a total of 85 watts. A power supply raised the burden of thermal dissipation by another 65 W.

Circuit cards, some built on aluminum cores, conduct heat left and right to the air-cooled heat exchangers, which double as chassis walls. The card guides also serve a vital secondary role—carrying heat from the card to the exchangers. When each card dissipated 2.5 W, the cooling air could keep temperatures below a safe 75°C. However, when each card is packed with 60 LSI flatpacks, each measuring 0.25-inch square, the power on each card is boosted to 20 W, which drastically increases the amount of heat that must be dissipated.

If cooling air at 20°C is forced through the exchangers at three pounds per kilowatt, the temperatures at various points in the chassis will reach the temperatures as-

signed to the node points in the illustration. There is a colossal rise of 49°C laterally across the card. Although the edge temperature is only 39°C, the center of the rear card is 98°C. The temperature of the last card at the rear, near the outgoing air, rises to 131°C—well above the tolerable levels for long-term IC reliability.

A designer could improve heat flow in the existing design by increasing the card-core thickness and by using a wedge-type card clamp, which would improve thermal conductivity. But this effort won't lower IC temperatures very much. Even a tripling of the card-core thickness fails to lower maximum IC temperatures below 92°C—too high for long-term reliable operation. Moreover, thickening the card is a costly tradeoff because it doubles the card weight and enlarges its volume by 30%.

Fortunately, the hollow-core card and the basic module with its integral exchanger are breakthroughs in thermal architecture. They both enable cooling air to circulate effectively and thereby provide the parallel air to hold densely packaged LSI devices at low operating temperatures.

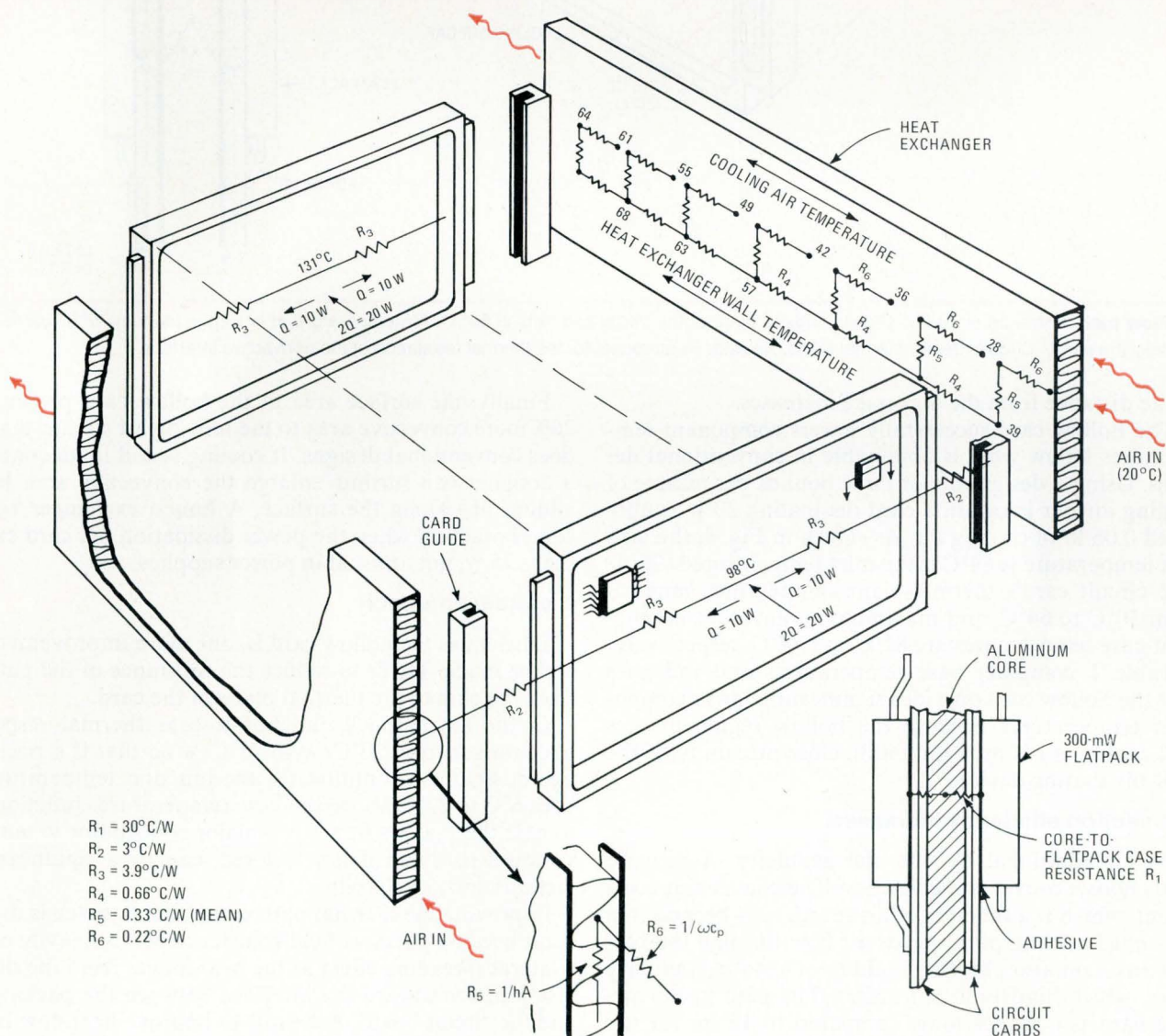

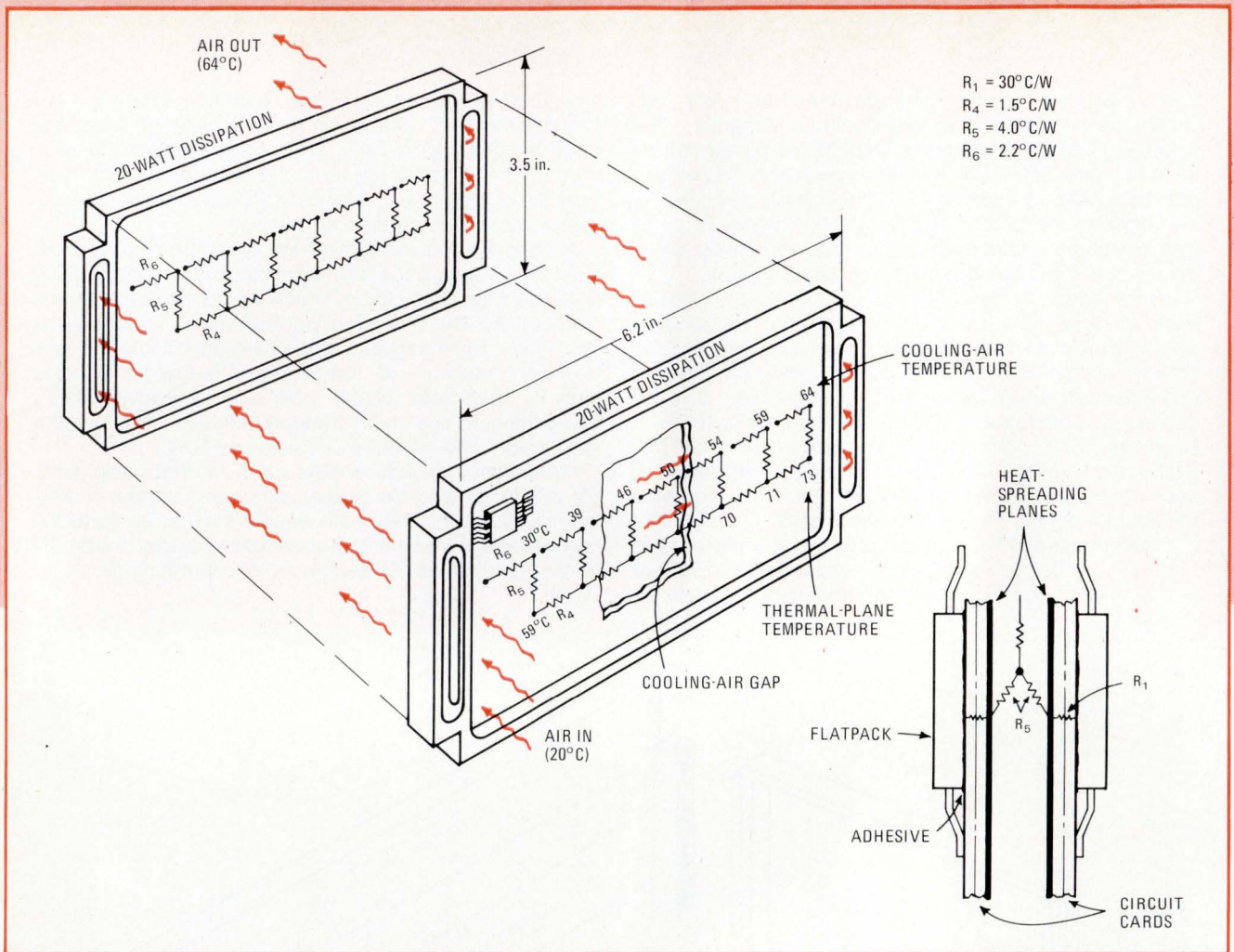

**4. Flow path.** Entrance air at  $20^\circ\text{C}$  distributes to each of the cards and exits at  $64^\circ\text{C}$ . Air temperature at entrance plenums of all cards is virtually the same. Circuits depict thermal paths. Resistor  $R_5$  accounts for the thermal resistance of the convective interface.

as the distance from the air intake increases.

The hollow card successfully lowers component temperatures below what is obtainable in conventional designs. Using a design rule of three pounds per minute of cooling air per kilowatt, a card dissipating 20 w is allocated 0.06 lb of cooling air. As shown in Fig. 4, the air's exit temperature is  $64^\circ\text{C}$  if the inlet temperature is  $20^\circ\text{C}$ . The circuit card's thermal-plane temperature range is from  $30^\circ\text{C}$  to  $64^\circ\text{C}$ , and maximum and average component-case temperatures are  $82^\circ\text{C}$  and  $74^\circ\text{C}$ , respectively.

Table 1 compares case temperatures and indicates that the hollow card provides significantly lower component temperatures because the hollow region assures that cooling air is brought within close proximity of the heat-dissipating devices.

### Convection efficiency increased

As an additional benefit, the geometry of air-core cards boosts convection efficiency. The convection coefficient, which is a function of air speed, rises because the shortened cooling path speeds air flow through the hollow card and also prevents buildup of a static boundary layer, which hinders heat transfer. The path in the air-core card is 6 inches long, compared to 15 in. for the conventional card.

Finally, the surface area of the hollow card presents 20% more convective area to the moving air stream than does conventional designs. If cooling is still inadequate, a designer can further enlarge the convective area by adding fins along the surface. A finned exchanger becomes practical when the power dissipation per card exceeds 25 w, not unusual in power supplies.

### A system approach

Efficient as the hollow card is, one more improvement can be made. That's to reduce the resistance of the path from the chip to the thermal plane of the card.

In the LSI flatpack, junction-to-case thermal resistance ranges from  $20^\circ\text{C/W}$  to  $75^\circ\text{C/W}$  so that if a package dissipates 300 milliwatts, the junction temperature rises  $6^\circ\text{C}$  to  $22^\circ\text{C}$  above the case temperature. Junction-to-case thermal resistance is a major contributor to temperature rise, and if not lowered, can be a significant factor in loss of reliability.

Improving the thermal path within the flatpack is difficult because effective heat transfer depends heavily on a lateral spreading effect as the heat moves from the device junction toward the interface between the package and the circuit board. Attempts to improve heat flow by selecting a better thermal conductor or a thinner sub-

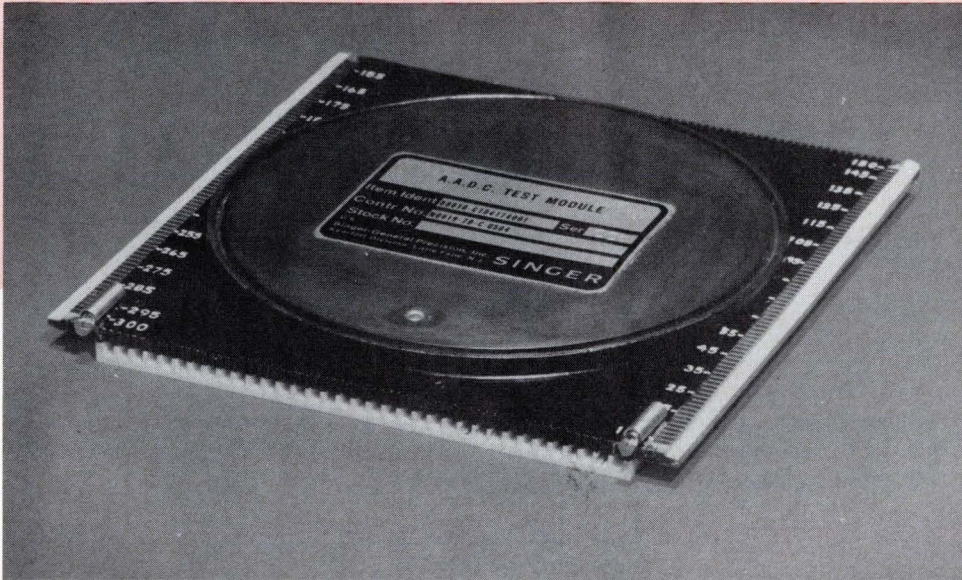

**5. A cool wafer.** Efficient thermal package houses a 3-inch LSI wafer (a). Component parts (b) include an alumina or beryllia heat exchanger that fastens directly to the base ceramic, optimizing cooling. Substituting more costly beryllia enhances thermal conductivity by a factor of 12.

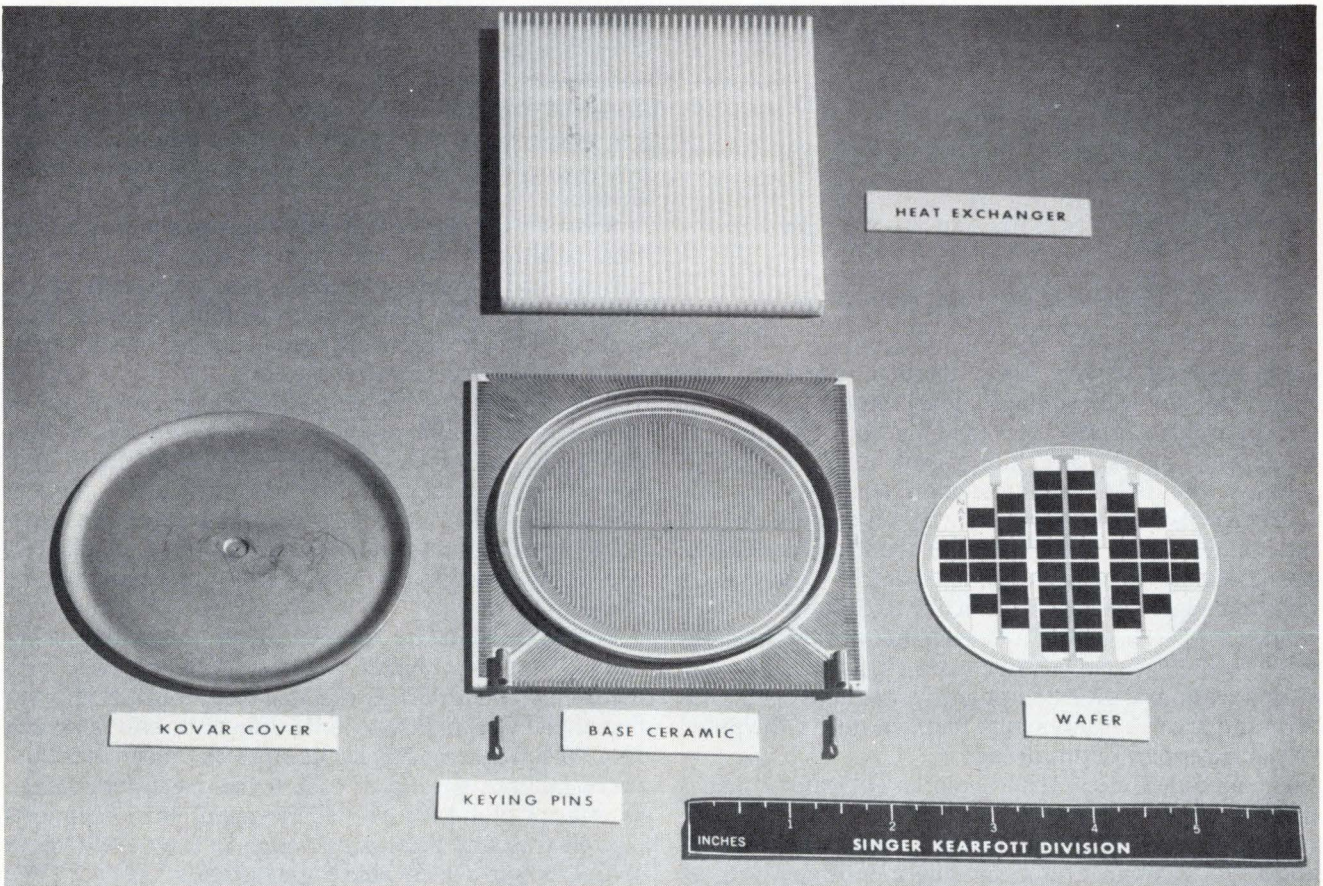

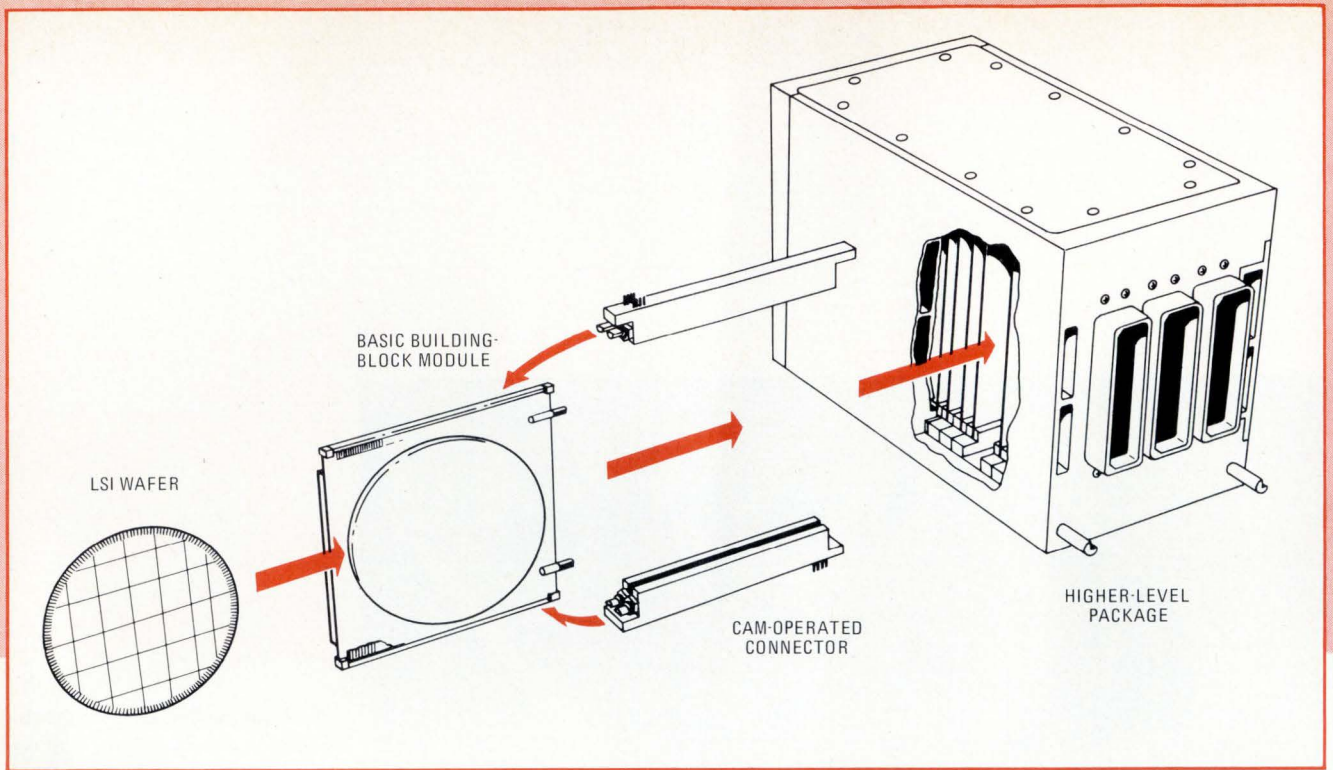

**6. Full-wafer packaging.** This airborne computer houses modules containing 3-inch wafers, doing away with the printed-circuit-card construction and holding device junctions below 68° C. Cam-operated connectors eliminate engagement force. At 400 W, higher-level package dissipates almost three times the power of an earlier computer—with no increase in package volume.

COMPONENT CASE TEMPERATURES — 20-WATT CARD		
	Hollow card (°C)	Conventional card (0.05-in. aluminum core) (°C)
Maximum IC case temperature	82	131
Average IC case temperature	73	115
Cooling-air temperature rise	44	44

Flow rate 3 lb/minute per kW — 20°C inlet air temperature

strate material seldom lower thermal resistance very much. The problem requires a novel solution.

Extraordinarily potent in its ability to lower junction temperatures is the structure shown in Fig. 5(a). This package, the B<sup>3</sup>M, offers junction temperatures 23% lower than even the hollow card, and it can dissipate as much as 50 W. What is so unusual about this package is that it does away with the circuit board by marrying a heat exchanger directly to the active IC devices.

The (B<sup>3</sup>M) stems from a development program sponsored by the U.S. Naval Air Systems Command for the all-applications digital computer, designed to fulfill military and space requirements that are now anticipated for the latter part of this decade.

The module is designed to hold an LSI wafer 3 inches in diameter that has a complexity equivalent to more than 5,000 gates. Alternately, it can house a hybrid substrate 3 in. in diameter that contains a multiplicity of LSI

chips and passive devices mounted on a multilayer thick-film substrate.

The key to the excellent thermal capability of this module is the ceramic heat exchanger shown in Fig. 5(b). The heat exchanger cements directly to the alumina-base ceramic, ensuring a very short thermal path from the chip to the cooling air stream. Interrupted fins can also be used to prevent static air boundaries from forming, and the reward is a high film-convection coefficient.

Substituting more-costly beryllia for alumina in the heat exchanger lowers thermal resistance still more—by a factor of 12—thereby lowering junction temperatures another 8°C. The combination alumina-beryllia heat exchanger lowers the lateral resistance so that hot spots are less likely to develop on the chip.

Singer-Kearfott's higher-level package, made up of basic building-block modules, is shown in Fig. 6. Air-flow paths are much like those shown in Fig. 1. Air flows from left to right through the heat exchanger channels on each module. Again, flow rates and inlet-air temperature are independent of card placement, offering the designer great flexibility in arranging the configuration.

The basic module circulates cooling air where it belongs—in intimate contact with the IC. Doing away with the circuit card lowers IC-junction temperatures approximately 20°C. If one applies the rule of thumb that each 10°C of lower temperature doubles the mean time between failures, the life of each IC has been lengthened by a factor of 4. Such an enhancement clearly supports the role of sound packaging design in the development of high-power-density electronic systems. □

# Datawest has done it again!!!

introducing the newest addition  
to an already complete line  
of computer controlled analog  
to digital conversion systems.

## 16 bits.....and then some\*!!!

\* Conversion time of 2½ micro seconds

\* System 4..... standard controllers

for • IBM SYSTEM 360/370

• PDP-11

• INTERDATA 7/32

• VARIAN 620 AND V73

• DATA GENERAL NOVA

• and COMPLETE MULTI-CHANNEL

FFT BASED REALTIME

SIGNAL PROCESSING SYSTEMS

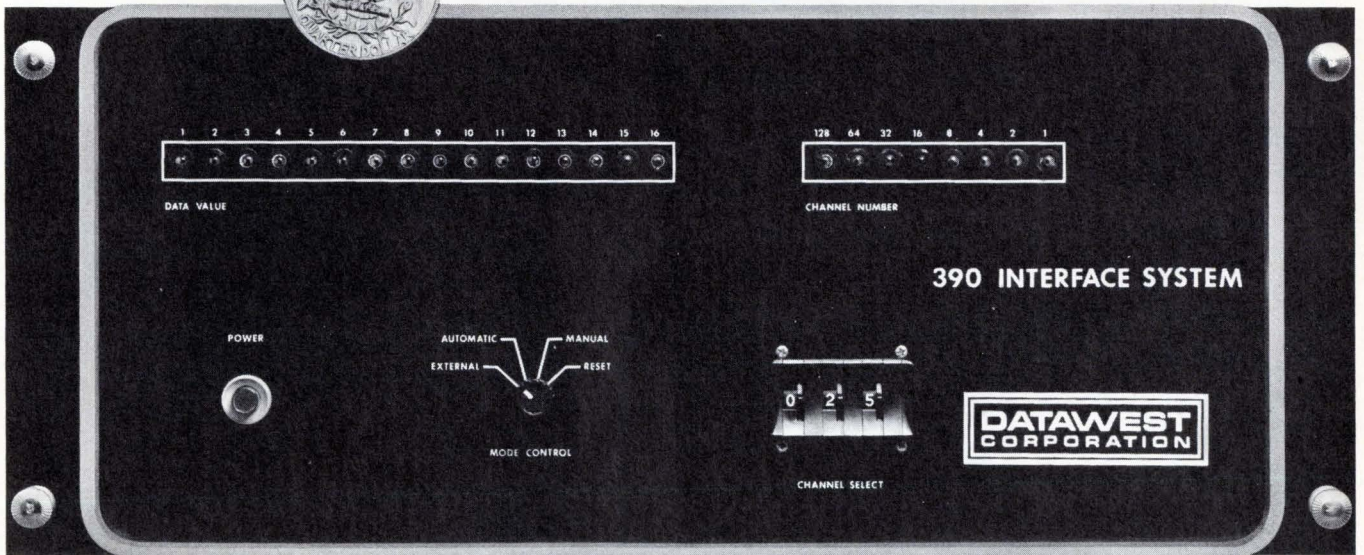
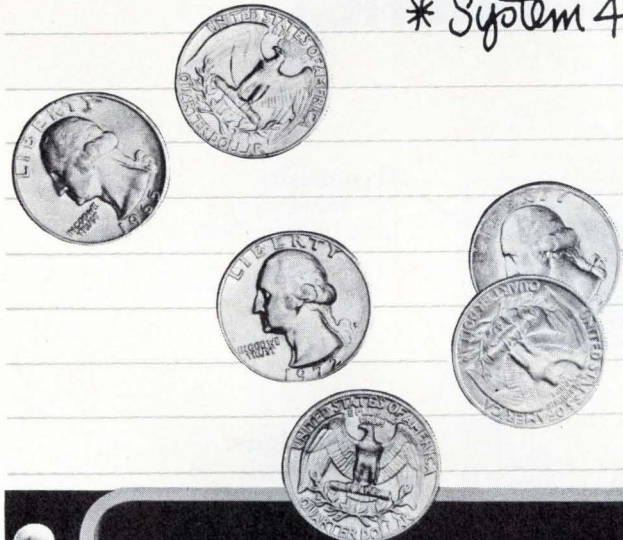

7333 E. HELM DRIVE • (602) 948-3280  
SCOTTSDALE, ARIZONA 85260

# The Sinclair Scientific.

## Logs, trig and arithmetic.

### \$99.95

(Now you can afford to get a little scientific.)

**Display:**  
5-digit mantissa  
2-digit exponent  
(both signable)

**Exponent:**  
200-decade range,  
from  $10^{-99}$  to  $10^{+99}$

**Functions:**  
4 arithmetic  
2 logarithmic  
6 trigonometric

**Logic:**  
Reverse Polish, with  
post-fixed operators  
for full flow chain  
calculations.

**Keyboard:**  
18 key format with  
4 "triple-action"  
function keys using  
standard, upper and  
lower case operation.

**Size:**  
4-3/8" high; 2" wide;  
11/16" thick.

**Weight:**  
3-3/4 oz.

**Warranty:**  
1 year.

**Power Source:**  
Battery operated  
with 4 inexpensive  
AAA penlight  
batteries, providing  
over 25 hours of use.

actual size



Scientific calculators are fast.

And convenient.

And, until recently, very expensive.

(A good one could cost as much as \$300.)

But now there's the Sinclair Scientific.

For an incredible \$99.95, this small scientific miracle not only performs logarithmic and trigonometric functions at the push of a button. It displays all calculations with scientific notation.

What's more, the Sinclair Scientific isn't just portable. It's pocketable.

Less than 3/4-inch thin. And 3 3/4-ounces light. It's the world's thinnest, lightest scientific calculator.

Just look at some of its essential functions, and you may never use your slide rule or log tables again:

**log and anti-log (base 10)  
sin and arcsin  
cos and arccos  
tan and arctan  
automatic squaring  
automatic doubling  
 $x^y$ , including square and other roots  
plus the four basic arithmetic functions**

Besides performing virtually all scientific, mathematical and financial operations, it can also carry out chain calculations of unlimited length.

### What makes a scientific calculator scientific?

There are a number of calculators that call themselves "scientific."

But most, quite frankly, don't measure up.

To be a really valuable tool for engineers, scientists, technicians and students, a calculator must provide *all* of the following:

Log functions.

Plus trig functions.

Plus scientific notation

( $10^{-99}$  to  $10^{+99}$ ).

Clearly, a scientific calculator without scientific notation severely limits the size of numbers with which you can work easily.

And scientific notation without transcendental functions is little more than window dressing on an arithmetic calculator.

Granted, there are two companies, other than Sinclair,

offering excellent units with all the essential ingredients.

But Hewlett-Packard's models start at well over \$200.

And Texas Instruments' SR-50, at about \$170, uses a mix of logics. Which we believe is less convenient than the reverse Polish logic with post-fixed operators used by Sinclair and Hewlett-Packard.

What it all adds up to is this:

Only Sinclair provides truly scientific capacity at a truly affordable price.

### What makes the Sinclair Scientific so inexpensive?

Two important technological breakthroughs.

First, the British-built Sinclair Scientific has a *single* integrated circuit. Engineered by Sinclair. And exclusive to Sinclair.

(Competitive units require more than one chip. Their chips are larger. And also more expensive.)

Second, Sinclair's exclusive keyboard has only four function keys. All of which provide "triple-action" by changing from standard to upper or lower case mode.

Competitive products have more than twice as many keys. Most of them are infrequently used. And non-essential.

For example:

The Sinclair Scientific hasn't a square root key. But squares — and other roots — are obtainable simply by using logarithms.

Finally, extra keys mean extra cost. (Not to mention size and weight.) And fewer keys mean a simpler format to memorize — for increased speed and fewer entry errors.

### Old hands at small miracles.

Sinclair has been an innovator

in calculator miniaturization right from the start. And it's now Europe's largest manufacturer of pocket calculators.

In the last two years Sinclair brought to America the world's thinnest, lightest calculators — the Sinclair Executive and Executive Memory — as well as the Cambridge, a moderately priced 4-function unit.

Naturally, Sinclair maintains a service-by-return mail operation in the U.S. (and everywhere else in the world) to handle any product problems, should they develop.

And, the Sinclair Scientific is backed by an unconditional one-year replacement warranty.

### How to get your Sinclair Scientific.

Whether it's for yourself, your company, or as a welcome gift for any science or engineering student, the Sinclair Scientific may be ordered immediately — by mail or phone.

And, of course, you may charge it on *mail or phone* orders to your American Express, Diners Club, Master Charge or BankAmericard account.

If you're not completely satisfied, you may return the unit within 2 weeks of receipt for prompt refund.

Just use the coupon below, or call (800) 223-5764, toll free.

The Sinclair Scientific.

It's the logical choice for people who want the answers in their pockets. At a price that's easy on their wallets.

**sinclair™**  
**SCIENTIFIC**  
**The logical choice.**

### ORDER FORM

For credit card phone orders call (800) 223-5764, toll free. (New York residents call (212) 688-6623.)

To: Sinclair Radionics, Inc. 375 Park Avenue, New York, New York 10022

3-A

Please send me \_\_\_\_\_ Sinclair Scientific(s) at \$99.95 (plus \$3.50 per unit, shipping and handling) including batteries, carrying case, instruction booklet and warranty. (New York residents add sales tax.)

Signature \_\_\_\_\_

Name \_\_\_\_\_

Company \_\_\_\_\_

Address \_\_\_\_\_

City \_\_\_\_\_

State \_\_\_\_\_ Zip Code \_\_\_\_\_

Enclosed is my check for \_\_\_\_\_.

Please charge my credit card account.

Credit Card \_\_\_\_\_

Account No. \_\_\_\_\_

Expires \_\_\_\_\_

Master Charge Code # (4 digits) \_\_\_\_\_

All Sinclair pocket calculators, including the Executive (\$79.95), Executive Memory (\$99.95) and Cambridge (\$44.95), are available at better stores everywhere.

## Probing system noise from hertz to megahertz

By Clarence Lundy  
California Institute of Technology, Jet Propulsion Laboratory, Pasadena, Calif.

Since an electronic system is often an assembly of interconnected subassemblies, unplanned noise-coupling paths that degrade the performance of the system are frequently created. The engineer who tries to trace these unwanted noise paths needs some way to measure unbalanced currents in signal cables.

Three probes make it easy to measure the wide frequency range of noise signals that may plague the operation of an installation. One probe is useful from 30 hertz to about 400 kilohertz, another probe discriminates against power frequencies and operates from a few kilohertz to about 400 kHz, and the last probe is sensitive in the megahertz region. None of these probes responds to balanced currents, which generally do not cause any noise.

The low-frequency probe is a modified clip-on ammeter—in this case, the Amprobe RS-1, which is a direct-reading ammeter for measuring currents from about

2 to 100 amperes. Auxiliary scales enable the unit to read voltage when a pair of test leads is added, but these scales are not used after the modification. The modified ammeter gives a satisfactory oscilloscope display of any current from 1 milliampere to 100 A, and its own current scales can still be used when the ammeter is employed for normal service.

Figure 1 shows the modified ammeter. First, remove the back of the unit by taking out the two deeply countersunk plastic screws. These may be removed by cutting a screwdriver slot in each or making a thin-walled deep socket wrench by forming a piece of tin around a quarter-inch Allen wrench, fastening it with a twist of wire, and sliding it down to project a quarter-inch beyond the end of the wrench.

Next, add a 100-ohm 1/8-watt resistor to the instrument's printed-circuit board. This resistor is used only as a fuse; it will burn out and save the instrument from damage if someone tries to use the meter to read voltage. If this precaution is not considered necessary, a wire can be run directly from the upper right-hand pad of the pc board to the lower-left-hand pad on the pc board. Now, the cover can be put back on. But be sure to mark the instrument plainly to show that it can no longer be used to read voltage.

The ammeter comes with a pair of voltage-test leads that are terminated with connectors. Remove the fe-

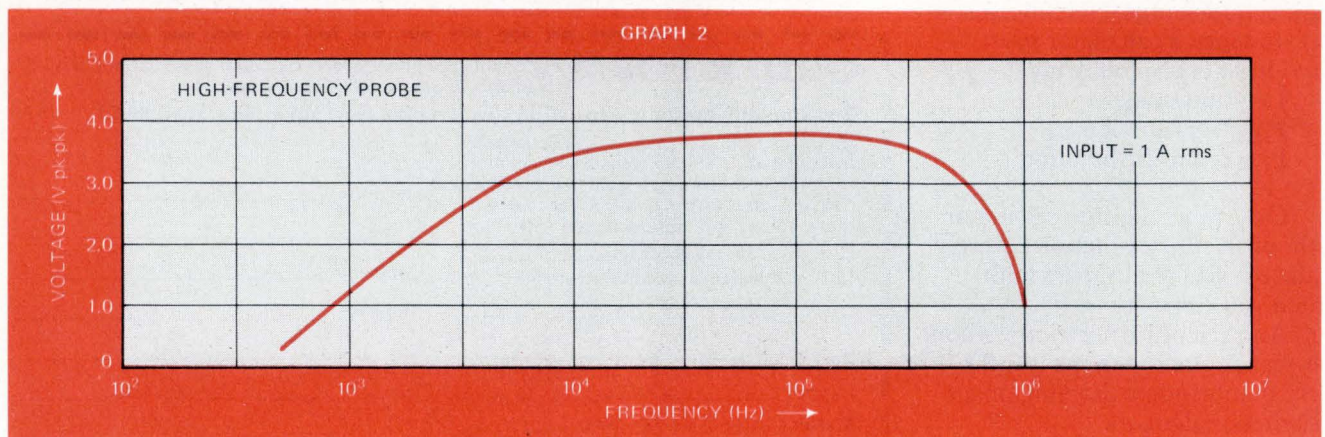
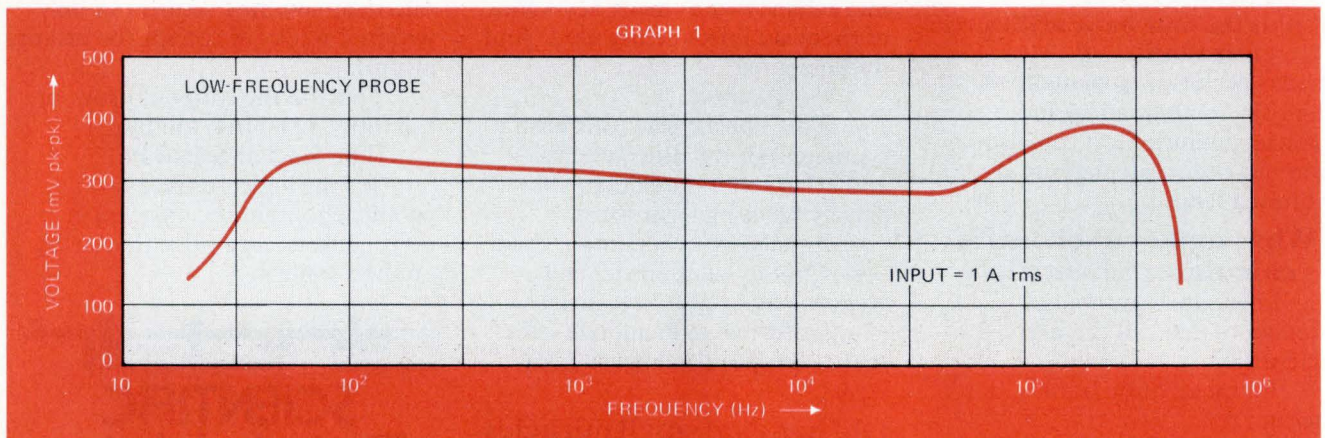

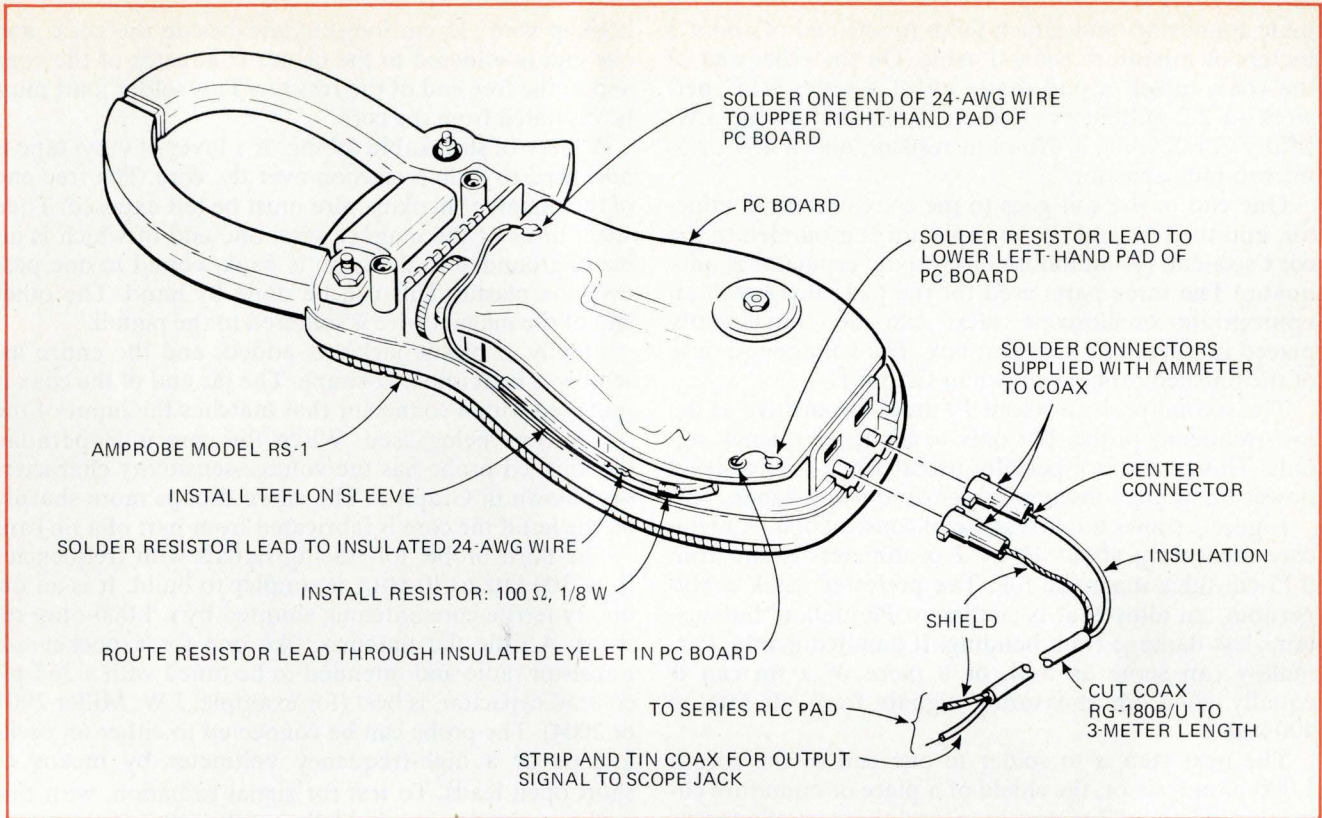

**1. Low-frequency probe.** When set on its voltage scale, a modified direct-reading ammeter makes an excellent probe for tracing noise signals occurring at frequencies from about 30 hertz to 400 kilohertz. The voltage response curve of this unit is shown in Graph 1.

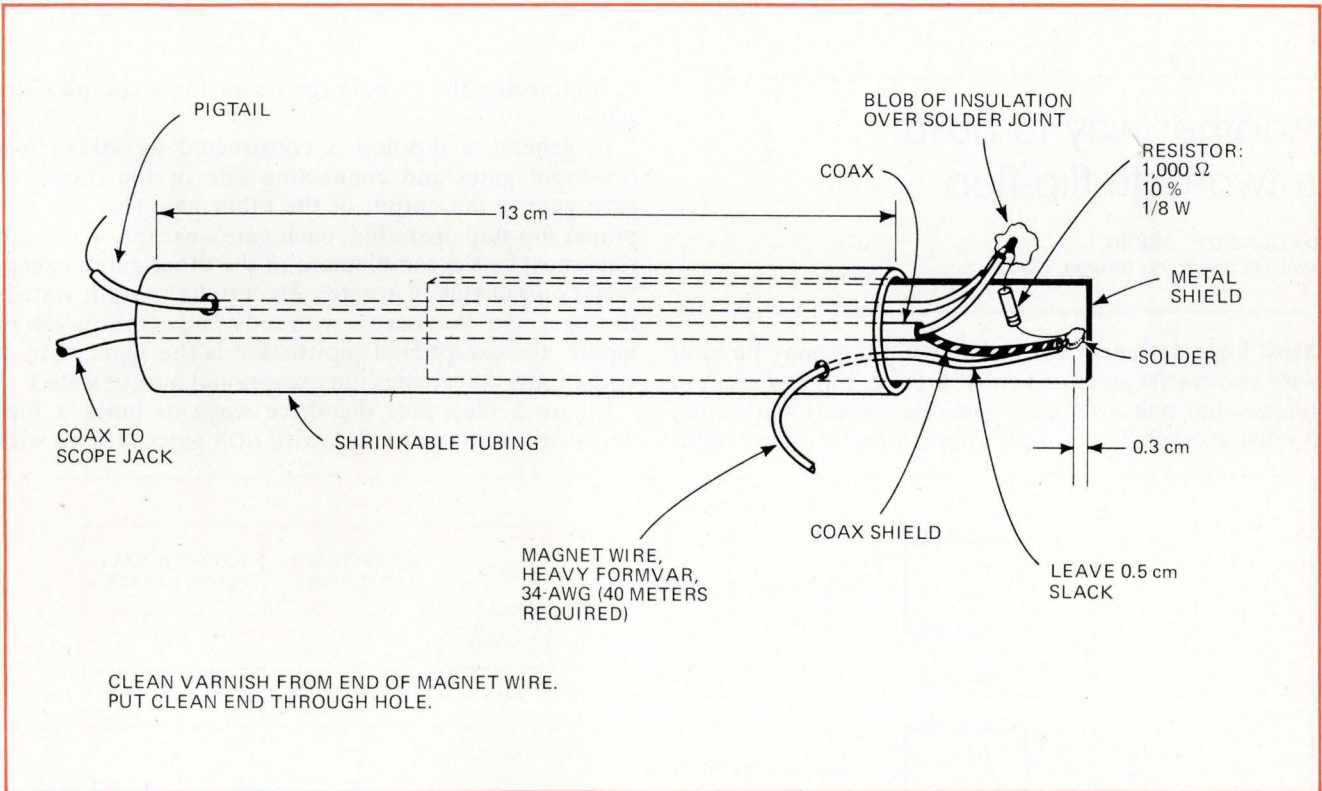

**2. High-frequency probe.** Operating from a few kilohertz to around 400 kHz, this probe is particularly good for sensing high-frequency noise, even if it is buried amid large-level power frequencies. The probe consists of a long 1,000-turn coil wound on a thin soft-iron core. A damping resistor spoils resonances, and a coaxial cable brings the signal to an oscilloscope. The final assembly is bent into a U-shape. Graph 2 shows this probe's voltage sensitivity. For noise signals having even higher frequencies—from approximately 300 kHz to 10 megahertz—an ordinary flat ferrite-core radio antenna can be modified slightly for use as a noise probe.

male connectors and attach them to one end of about 3 meters of miniature coaxial cable. On the other end of the coax, attach a pad made up of a series RLC network—a 2.2-millihenry inductor coil (such as the J.W. Miller 70F223A1), a 470-ohm resistor, and a 4.7- or 5-microfarad capacitor.

One end of the coil goes to the coax's center conductor, and the free end of the capacitor is grounded to the coax's shield. (A miniature electrolytic capacitor is adequate.) The three parts used for the pad, along with an appropriate oscilloscope jack, can be conveniently placed in a separate compact box. The voltage response of the finished probe is shown in Graph 1.

The second probe is about 10 times as sensitive as the low-frequency probe, but only to higher-frequency signals. This probe is especially useful when a large-level power-line signal obscures a high-frequency signal.

Figure 2 shows the first stage of construction. A metal core measuring about 12 by 2 centimeters is cut from 0.15-cm-thick magnetic foil. The preferred stock is Hypernom, an alloy that is similar to Permalloy, but sustains less damage from bending. If handled gently, Permalloy can serve as well, or a piece of a tin can is equally good for measuring signals from 10 kHz to 400 kHz.

The next step is to solder to one end of the core a 1,000-ohm resistor, the shield of a piece of miniature coaxial cable about 3 meters long, and the start of approximately a 40-meter length of magnet wire. A pigtail of

hookup wire (15 cm long) is laid beside the coax, and one end is soldered to the center conductor of the coax and to the free end of the resistor. This solder joint must be insulated from the core.

A piece of shrinkable tubing or a layer of vinyl tape is now used to form a cushion over the core. The free end of the pigtail of hookup wire must be left exposed. Then 1,000 turns of the magnet wire, one end of which is already grounded to the core, is bank-wound in one pass over the plastic. This can be done by hand. The other end of the magnet wire is soldered to the pigtail.

Finally, a plastic jacket is added, and the entire assembly is bent into a U-shape. The far end of the coax is provided with a connector that matches the input of the oscilloscope being used. When the core is Hypernom, the finished probe has the voltage-sensitivity characteristic shown in Graph 2. The curve droops more sharply on the left if the core is fabricated from part of a tin can.

The third probe, for tracing signals with frequencies from 300 kHz to 10 MHz, is simpler to build. It is an ordinary ferrite-core antenna, shunted by a 1,000-ohm resistor. A little flat antenna, like one for a pocket-size transistor radio and intended to be tuned with a 365-picofarad capacitor, is best (for example, J.W. Miller 2001 or 2004). The probe can be connected to either an oscilloscope or a high-frequency voltmeter by means of short open leads. To test for signal radiation, with this probe is simple—just hold the probe against the cable being checked. □

## Another way to build a two-gate flip-flop

by Donald P. Martin  
Martin Research Ltd., Chicago, Ill.

Most logic designers know that a flip-flop may be built with two NAND gates or two NOR gates, but few seem to realize that one AND gate plus one OR gate may often do just as well. This simple substitution can be helpful

in minimizing the IC package count for a complex design.

In general, a flip-flop is constructed by taking two two-input gates and connecting one of the inputs of each gate to the output of the other gate (Fig. 1). For proper flip-flop operation, each gate's exceptional input state must be the complement of the other gate's exceptional output state. (A gate's exceptional output state is the logic state that occurs with only one combination of inputs; the exceptional input state is the logic state at both inputs that creates the exceptional output state.)

Figure 2 illustrates the three ways to build a flip-flop—with NAND gates (2a), with NOR gates (2b), or with

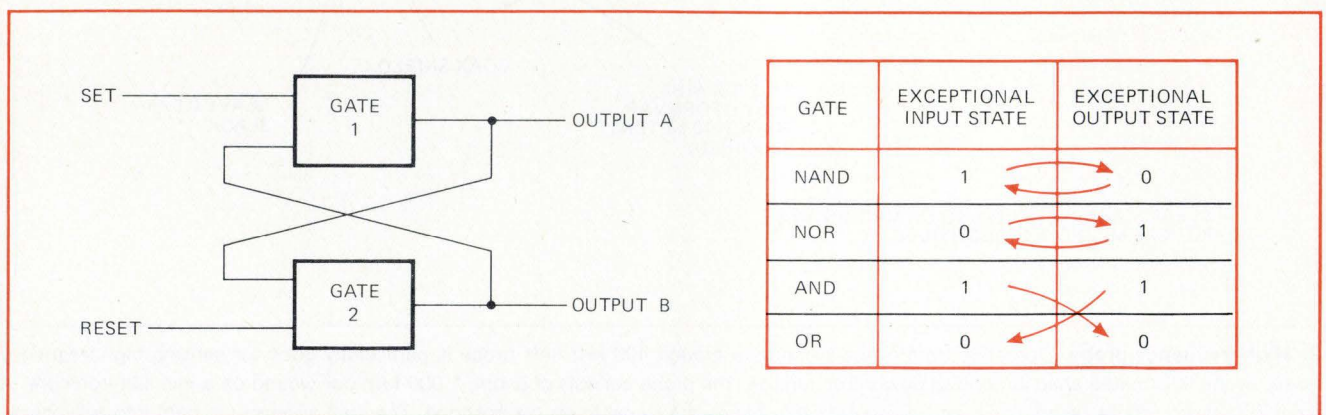

**1. By definition.** For the two-gate flip-flop, one gate's exceptional input state must be the complement of the other gate's exceptional output state. A gate's exceptional output state is that logic state produced by only a certain combination of (exceptional) inputs.

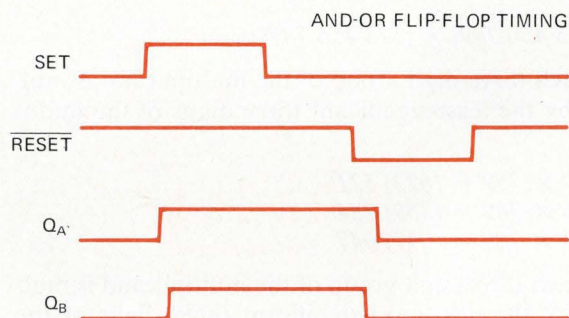
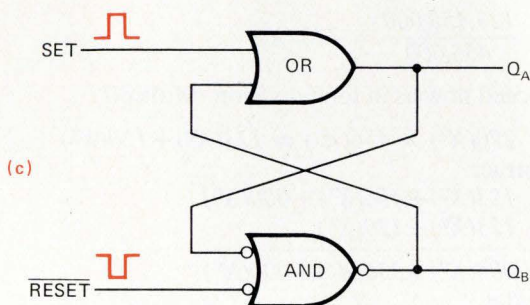
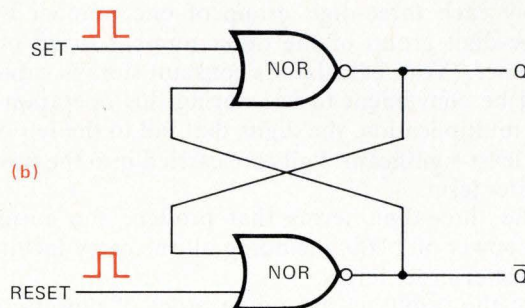
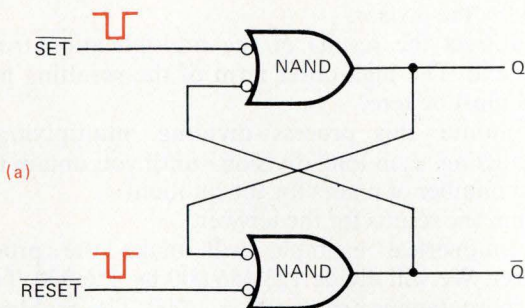

**2. Three choices.** A flip-flop can be made from two NAND gates, as in (a), or from two NOR gates, as in (b). A third alternative—one that is particularly handy if you're trying to use leftover gates—is to wire up an AND gate and an OR gate. The resulting flip-flop does not have complementary outputs, nor same-polarity set and reset inputs, but it can help avoid undesirable race-prone situations.

AND and OR gates (2c). (The AND gate is drawn here as an equivalent negative NOR gate so that the operation of the AND-OR flip-flop will be clearer.)

The NAND flip-flop requires negative set and reset inputs, while the NOR flip-flop needs positive set and reset inputs. Each of these flip-flops provides complementary (Q and Q) outputs. Needless to say, the designer who is trying to use leftover gates can employ an AND gate, followed by an inverter to get a NAND gate, or he can put together an OR gate and an inverter for a NOR gate.

Unlike in the NAND and NOR flip-flops, the set and reset inputs of the AND-OR device have opposite polarities—often very conveniently—and the outputs of this flip-flop are not complementary—sometimes quite inconveniently. Of course, an inverter can be added at one of the outputs to change its polarity.

It should be noted that the AND-OR flip-flop can be particularly useful in race-prone applications. During the set pulse of this flip-flop, the Q<sub>A</sub> output rises to logic 1 before the Q<sub>B</sub> output even starts to rise. □

## Polynomial expansion beats calculator display limits

by Charles Lotterman  
Northrop Corp., Electronics Div., Hawthorne, Calif.

Occasionally, when you're multiplying or dividing two large numbers, you will exceed the display capacity of

your calculator—even if you have a machine as sophisticated as Hewlett-Packard's HP-45, which rounds off the answer. But, by taking advantage of the way polynomials are multiplied or divided, you can get around this problem.

Any number can be expanded as a polynomial whose base is 1,000. For example, the number 123,456,789 can be written as:

$$123 \times 1,000^2 + 456 \times 1,000^1 + 789 \times 1,000^0$$

Now this number can be manipulated as a polynomial,

with the three-digit significant figures of the number being treated as the coefficients of the polynomial.

To multiply two such polynomials:

- Multiply each three-digit group of one number by each three-digit group of the other number in an orderly manner. (Your calculator's constant storage capability will be convenient to use during this operation.) For each multiplication, the digits that fall to the left of the three least-significant digits are carried into the next higher-order term.
- Sum the three-digit terms that produce the corresponding power of 1,000, including all the carry factors from the lower-order terms.
- Arrange the results in ascending order of powers of 1,000 to obtain the answers.

As an illustration of this technique, let's multiply 123,456,789 by itself. The carry terms will be enclosed by parentheses. The problem is:

$$[123\ 456\ 789] \times [123\ 456\ 789]$$

First, each three-digit group of the multiplicand is multiplied by the least-significant three digits of the multiplier:

$$\begin{aligned} 789 \times 789 &= (622)\ 521 \\ 456 \times 789 &= (359)\ 784 \\ 123 \times 789 &= (097)\ 047 \end{aligned}$$

Then, each three-digit group of the multiplicand is multiplied by the next-most-significant three digits of the multiplier:

$$\begin{aligned} 789 \times 456 &= (359)\ 784 \\ 456 \times 456 &= (207)\ 936 \\ 123 \times 456 &= (056)\ 088 \end{aligned}$$

Finally, each three-digit group of the multiplicand is multiplied by the most-significant three digits of the multiplier:

$$\begin{aligned} 789 \times 123 &= (097)\ 047 \\ 456 \times 123 &= (056)\ 088 \\ 123 \times 123 &= (015)\ 129 \end{aligned}$$

The results of each of these multiplications are arranged so that the three-digit groups belonging to the same power of 1,000 can be added together:

		123	456	789	
	×	123	456	789	
			(622)	521	
			(359)	784	
	(097)		047		
			(359)	784	
	(207)		936		
	(056)		088		
	(097)		047		
	(056)		088		
	(015)		129		
		(1)	(2)		
		15	241	578	750
				190	521

The answer, therefore, is: 15,241,578,750,190,521.

A similar technique can be used for division:

- Set up the numbers in the format used for long division.

- Perform a trial division using your calculator's divide function.
- Round the results to a three-digit integer and multiply by the divisor.
- Subtract the results of the multiplication from the dividend. The high-order term of the resulting polynomial must be zero.
- Continue this process—dividing, multiplying, and subtracting, as in long division—until you obtain the desired number of places for the quotient.
- Sum the results for the answer.

A numerical example will make the procedure clearer. We will divide 123,456,000 by 456,000. To keep the computations neat, let  $X = 1,000$ . The problem is:

$$\frac{123(X^2) + 456(X^1) + 000(X^0) + 000(X^{-1})}{456(X^1)}$$

The trial division produces:

$$\frac{123,456,000}{456,000} = 270(X^0)$$

Proceed now as in long division. Multiply:

$$270(X^0) \times 456(X^1) = 123(X^2) + 120(X^1)$$

Subtract:

$$\begin{array}{r} 123(X^2) + 456(X^1) + 000(X^0) \\ - 123(X^2) + 120(X^1) \\ \hline \end{array}$$

$$000(X^2) + 336(X^1) + 000(X^0)$$

Divide:

$$\frac{336(X^1) + 000(X^0)}{456(X^1)} = 737(X^{-1})$$

Multiply:

$$737(X^{-1}) \times 456(X^1) = 336(X^1) + 072(X^0)$$

Subtract:

$$\begin{array}{r} 336(X^1) + 000(X^0) + 000(X^{-1}) \\ - 336(X^1) + 072(X^0) \\ \hline \end{array}$$

$$000(X^1) - 072(X^0) + 000(X^{-1})$$

Divide:

$$\frac{-072(X^0) + 000(X^{-1})}{456(X^1)} = -158(X^{-2})$$

Continue in this way until you obtain the accuracy desired. The complete long-division array looks like this:

$$\begin{array}{r} 270(X^0) + 737(X^{-1}) - 158(X^{-2}) \\ 456(X^1) \overline{) 123(X^2) + 456(X^1) + 000(X^0) + 000(X^{-1}) + 000(X^{-2})} \\ \underline{123(X^2) + 120(X^1)} \phantom{+ 000(X^0) + 000(X^{-1}) + 000(X^{-2})} \\ \phantom{123(X^2) + } 336(X^1) + 000(X^0) \\ \phantom{123(X^2) + } \underline{- 336(X^1) + 072(X^0)} \phantom{+ 000(X^{-1}) + 000(X^{-2})} \\ \phantom{123(X^2) + } \phantom{336(X^1) + } - 072(X^0) + 000(X^{-1}) \\ \phantom{123(X^2) + } \phantom{336(X^1) + } \underline{- 072(X^0) - 048(X^{-1})} \phantom{+ 000(X^{-2})} \\ \phantom{123(X^2) + } \phantom{336(X^1) + } \phantom{- 072(X^0) + } + 048(X^{-1}) + 000(X^{-2}) \end{array}$$

The answer is found from the quotient:

$$(270 \times 1,000^0) + (737 \times 1,000^{-1}) - (158 \times 1,000^{-2}) + (106 \times 1,000^{-3})$$

or, 270.736 842 106, with a small negative remainder. □

Engineer's Notebook is a regular feature in Electronics. We invite readers to submit original design shortcuts, calculation aids, measurement and test techniques, and other ideas for saving engineering time or cost. We'll pay \$50 for each item published.

# A BETTER METER.

Data Precision's newest multimeter — the 5½ digit MODEL 3500 — is a second generation instrument that combines the best of both worlds.

More features.  
For less money.

MODEL 3500 incorporates all of the proven circuitry advances that made our 2500 Series the internationally accepted price/performance leader.

Tri-phasic™ auto-zero, Ratiohmic™ 2- and 4-wire resistance, and Isopolar™ high stability referencing.

With a 6 month basic DC accuracy of  $\pm 0.007\%$  of reading  $\pm 0.001\%$  of full scale  $\pm 1$  LSD, full autoranging from 1 microvolt to 1000V (DC or AC peak) and 1 milliohm through 12 megohms resistance, 20% overranging, DC Ratio, isolated BCD output, remote triggering and remote ranging, it represents the most sophisticated laboratory quality multimeter you can buy for less than \$1000.

**\$995.**  
**complete**

MODEL 3500 features the industry's most reliable, field proven circuit technology packaged behind a big, bright and easy-to-read ½ inch planar gaseous display. And none of the bugs of an unproven design.

MODEL 3500 measures DCV, 1 microvolt to 1000 Volts; ACV, 1 microvolt to 700V RMS, 30 Hz to 100KHz; Resistance, 1 milliohm to 12 megohms; and Ratio.

## AVAILABLE NOW

Contact your local Data Precision representative to arrange for a demonstration.

AL	(205) 533-5896	MA	(617) 273-0198	NY (S)	(516) 482-3500
AZ	(602) 994-9519	MD	(301) 552-2200	OH (N)	(216) 725-4560
CA (N)	(408) 733-9000	MI	(313) 482-1229	OH (S)	(513) 298-3033
CA (S)	(714) 540-7160	MN	(612) 781-1611	OR	(503) 238-0001
CO	(303) 449-5294	MO (W)	(816) 737-0066	TX (N)	(214) 234-4137
CT	(203) 525-7647	MO (E)	(314) 731-2331	TX (S)	(713) 461-4487
FL	(813) 294-5815	NC	(919) 787-5818	UT	(801) 268-3181
GA	(404) 457-7117	NJ (S)	(215) 925-8711	WA	(206) 763-2210
HI	(808) 262-6286	NJ (N)	(201) 863-5660	CAN (W)	(416) 787-1208
IL	(312) 593-0282	NM	(505) 265-6471	CAN (W)	(613) 772-5874
IN	(317) 293-9827	NY (N)	(315) 446-0220	CAN (E)	(514) 731-9328

Data Precision Corporation  
Audubon Road, Wakefield, MA 01880  
(617) 246-1600

 **DATA PRECISION**  
...years ahead

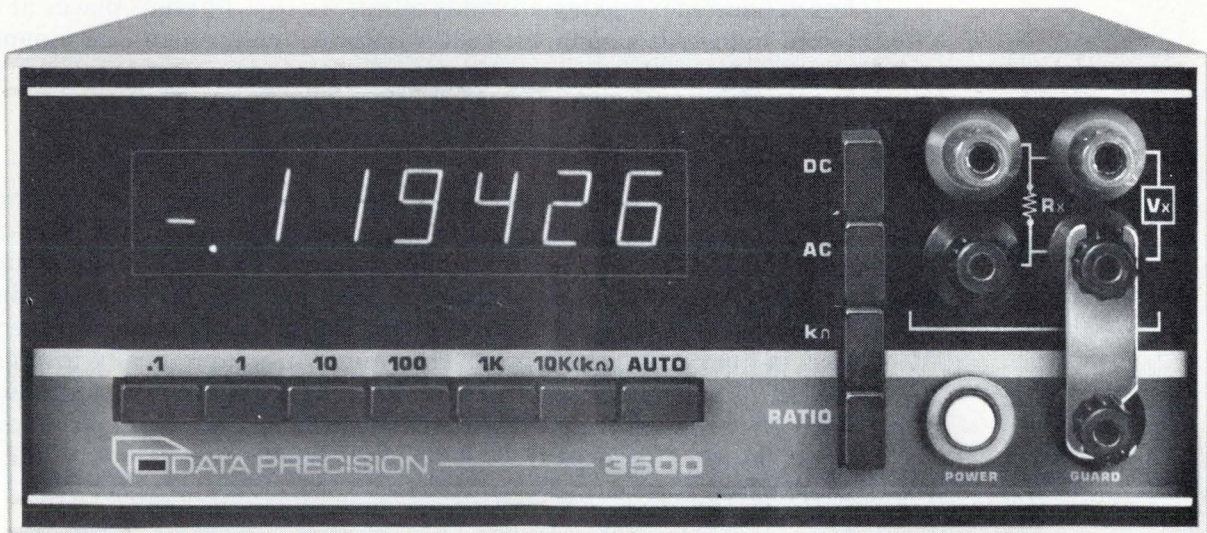

## Microprocessor designs demand tighter logic

Besides cost-saving benefits, microprocessor-based designs have another, less obvious, advantage over equivalent systems built with hard-wire logic. Because they need software control, microprocessor designs require the whole system to be analyzed before any portion of the design can be attacked. **The old hardware cut-and-try piecemeal logic design tricks won't work any more. This forces a designer into more rigorous, iterative methods, with their attendant flowcharts and optimization techniques,** which in the end results in a tighter logic design. The only problem: **you must learn to implement software.**

## Etch process pinpoints pinholes

Gaining currency is a chemical etch process for increasing the visibility of pinholes—those tough-to-detect IC yield killers that cause electrical shorts in MOS structures. The wafer's first bathed in a metalization and oxide etch, **then left to soak for 20 seconds or so in a silicon etchant,** basically until the silicon at the bottom of the pinhole is quite clean and will **contrast clearly with the color of its surroundings when viewed under an optical microscope. But some silicon etchants work better than others,** and, according to M. Narayanan, a fabrication specialist at GI's Microelectronics Laboratory, the best he's developed consists of **40 parts nitric acid, 13 parts acetic acid, and 4 parts hydrofluoric acid.**

## Keep your printed-circuit boards dry

Having unexplained failures with circuits built on glass-epoxy circuit boards? Beware of air-borne moisture, cautions Dale Hileman of Sphymetrics Inc. in Woodland Hills, Calif. **Moisture is drawn to the matte surface of a glass-epoxy board, where it gives rise to stray conductive paths that can disable any high-impedance circuit.** This not-so-apparent fault can be especially insidious because the equipment may operate normally for months until the weather turns humid and everything suddenly stops working. On a damp day, leakage between adjacent conductors is typically 500 kilohms. Virtual shorts can be created even by condensation produced, say, when a board is brought into a warm room from outside.

**A protective coating of rosin, or better yet, of polyurethane will help, but remember to heat the board first to ensure it's dry.** Otherwise, moisture trapped between the board and the coating will migrate about the board's surface, making all kinds of mischief in different places at different times. **Also, apply the coating after the components are mounted,** so that adjustable mechanical parts like potentiometers won't become clogged.

## New SIPs can be assembled automatically

The newer dual in-line package, because it can be inserted automatically, has long overshadowed the single in-line component for off-chip assemblies. Well, the SIP is making a comeback. **New manufacturing techniques are producing a closer dimensional control over the single in-line package tolerances by allowing the SIP to be molded (like the dual in-line) instead of dipped.** The result: an automatically insertable SIP. In fact, if they hadn't needed hand assembly, SIPs would always have been better than DIPs for most pc board applications—they've **twice the packing density, half the lead length, and take up half the board space.**





## Just arrived! Our 12-bit CMOS DAC.

Our new baby's a beauty. With 12-bit resolution and *guaranteed* linearity of  $\pm\frac{1}{2}$  LSB in 10 bits over  $-55^{\circ}$  to  $+125^{\circ}\text{C}$ .

We've christened it Model 872, and it's a *complete* DAC. CMOS input logic, R-2R ladder, micropower output amp, internal reference—even preset zero offset and gain—are all inside.

And all of this comes in one neat package just 1" by 1.5". Price is \$49.50 to \$66 in 200-piece quantity, depending on linearity and internal reference specs.

You might have expected it, considering that we're one of the country's major suppliers of DACs...and among the leading hybrid manufacturers, too. We make a lot of standard hybrids, but we're also great problem-solvers in custom situations.

If you need immediate technical literature or the telephone number of your local Beckman/Helipot representative, call toll-free (800) 437-4677.

**Beckman®**  
HELIPOT DIVISION

# What price Zeiss?

The small Epi-Microscope is the best buy anywhere...

... and, for the other five microscopes shown here, too, the price depends entirely on your needs. Whether production line, industrial research, or quality control, Zeiss quality and features always add up to true economy. Zeiss microscopes do more now, can be expanded to do more later, never become obsolete. The Zeiss range of optics and accessories is unequalled.

**1. Epi-Microscope.** A small and versatile upright incident-light microscope for production, QC and R/D. Rugged and sturdy. Can be mounted on various stands, or attached to machinery in the shop. Switches instantly from brightfield (for regular surface examination) to darkfield (to detect scratches, dirt, small de-

fects). Nomarski interference contrast makes minutest elevation differences stand out. Accepts cameras and TV attachments. Best buy on the market. **Reader service number 90.**

**2. Standard KK-08**—the Semi-Conductor Microscope. Features Epi-Nomarski optics at production-line cost. Makes it easy to spot pinholes, stacking faults, alignment errors, etching problems, bonding defects, mechanical damages, and many minute irregularities not detectable with any other light microscope technique. 3 x 3" stage with stainless steel plate makes loading and unloading rapid and easy. Can be expanded for research with wide range of accessories, also for photomicrography. **Reader service number 91.**

**3. Invertoscope M.** The smallest, most compact metallographic microscope. Ideal for fast, routine examinations. Yet has great optical features found in our larger microscopes. Excellent for brightfield and microscopy in polarized light and Nomarski interference contrast, even with Glarex projection screen. Great stability, low price. **Reader service number 92.**

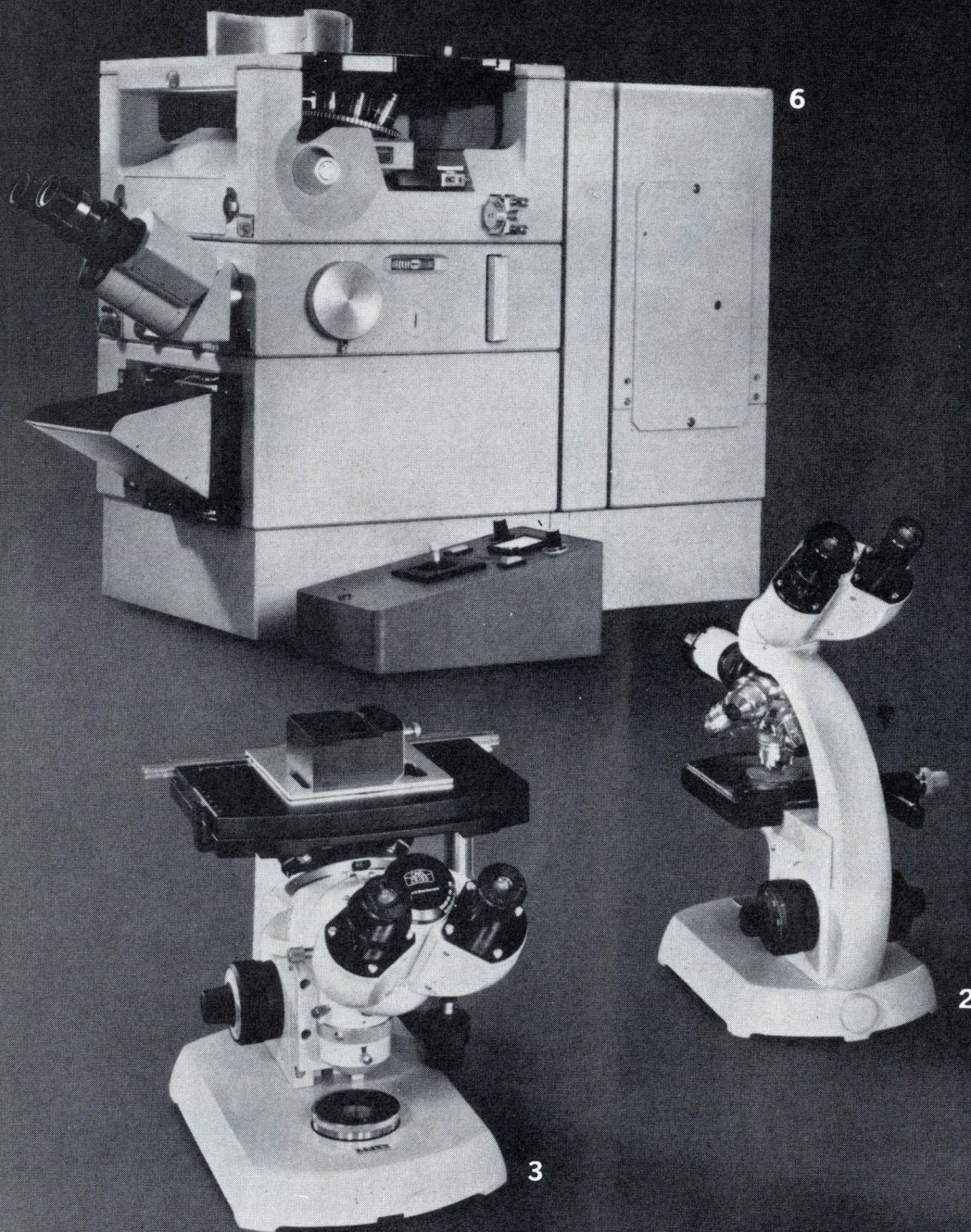

**4. Universal Microscope.** Recognized as the most universal microscope. With fully interchangeable optics and components for all microscope techniques in reflected and transmitted light, including UV. Accepts all accessories and camera formats, including TV and projection screen. With automatic scanning stage, ideal for photometry and quantitative stereometric image analysis. **Reader service number 93.**

**5. Ultraphot IIIB** with fully integrated, fully automatic camera systems for 4 x 5" and 35mm, and correct exposure reading from the center of the image field. For all microscope techniques in transmitted and reflected light. Continuous magnification from 2.5x to the limits of light microscopy. Holds 3 lamp housings simultaneously; the flip of a lever selects the illumination source and mode. Ideal for grain-size determinations by either micrometer eyepieces or projector. **Reader service number 94.**

**6. Axiomat—a revolutionary modular microscope system.** The finest, most stable metallograph ever made. Newly com-

puted optics, topped by a new Epiplanapochromat 125/1.6 with highest resolution ever achieved. Extreme widefield, and built-in zoom system for easy magnification change to the limits of light microscopy. All standard ASTM magnifications. Exceptionally large stage (8 x 17"). Stages remain stationary for utmost stability while focusing is done by moving the objectives — also remote-controlled. Two fully integrated, fully automatic camera systems. Quantitative image analysis by photometer or TV. Modular concept permits different assembly of modules, also for upright microscopy. **Reader service number 95.**

For details write Carl Zeiss Inc., 444 5th Avenue, New York, N. Y. 10018. Or phone (212) 736-6070.

In Canada: 45 Valleybrook Drive, Don Mills, Ont., M3B 2S6. Or phone (416) 449-4660.

**Nationwide service**

BRANCH OFFICES: BOSTON, CHICAGO, COLUMBUS, HOUSTON, LOS ANGELES, SAN FRANCISCO, WASHINGTON, D. C.

**ZEISS**

THE GREAT NAME IN OPTICS



WEST GERMANY

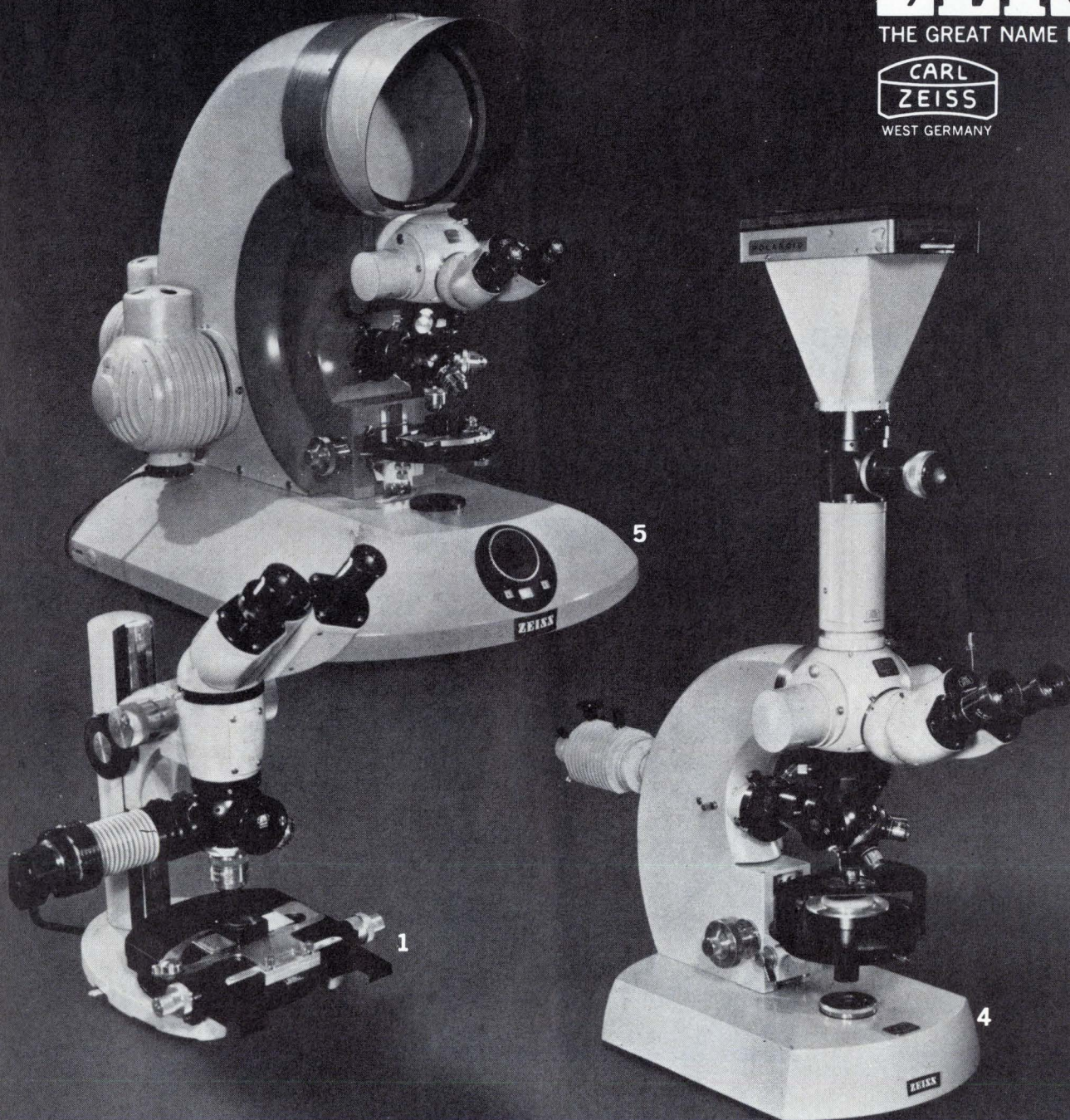

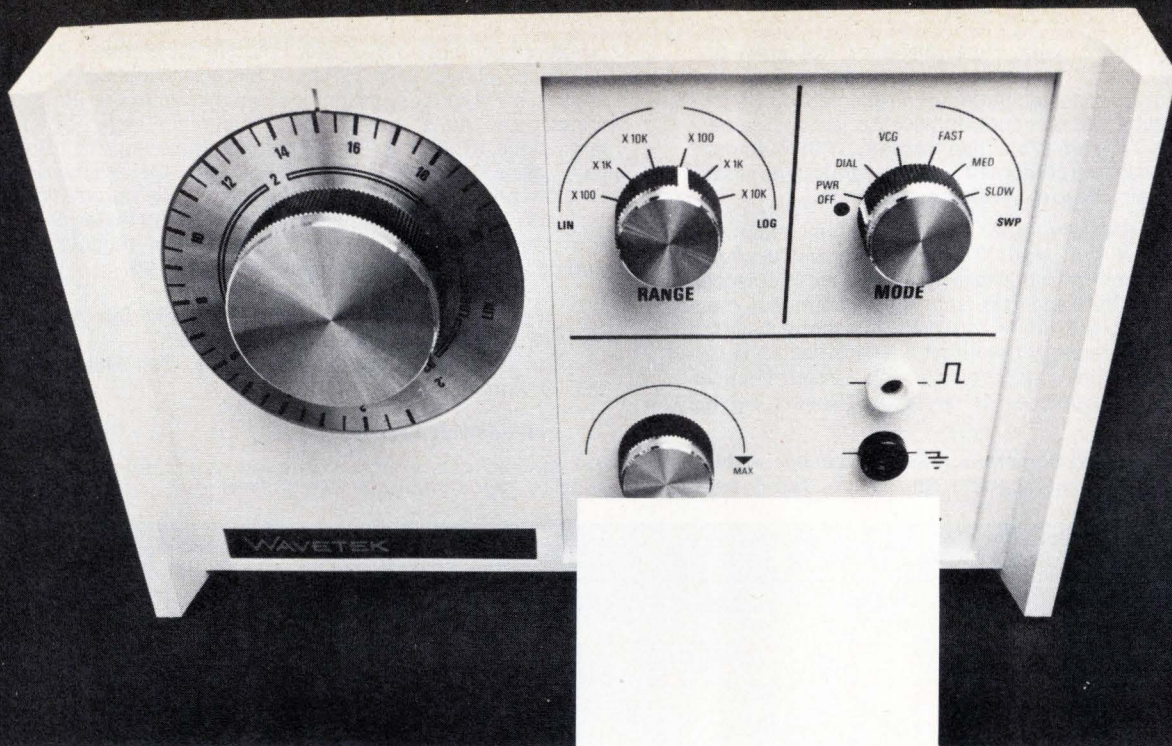

**This Model 30  
portable function generator  
goes from  
2 Hz to 200 kHz with  
sines, squares, triangles,  
and linear  
or log sweeps.**

**And it goes for  
\$149.<sup>95</sup>**



**WAVETEK®**

P.O. Box 651, San Diego, Calif. 92112  
TWX 910-335-2007, Tel. (714) 279-2200

# Multimeter rides piggyback on scope

It not only adds digital measurement capability, but enhances time-interval measurements between points on displayed waveform

by Stephen E. Grossman, Instrumentation Editor

**By combining** digital and analog functions in highly innovative ways, manufacturers are significantly enlarging the capabilities and the power of instrumentation systems. An instance is one of the latest Tektronix developments. The company has connected a low-profile (1.1 inch high) digital multimeter to its line of portable dual-trace oscilloscopes and thereby added the accuracy and resolution of a DMM to the scope's waveform-display capability.

The 3½-digit (2,000-count) multimeter comes in two versions—with and without temperature-measuring capability—and is offered as a built-in option on the 200-megahertz model 475 and the widely used 100-MHz model 465, as well as on the newer 464 and 466 scopes.

Just as a navigator uses a pair of dividers to measure distances on a chart, the engineer can put the Tektronix piggyback digital multimeter to work measuring time across the screen between selected points on a displayed waveform. Accuracy is within 1%, and resolution is substantially better than that of the bare scope, which provides an excellent technique for measuring critical timing in digital circuits.

To perform a time-span measurement, the

user advances the delay-time control until the intensified spot coincides with the beginning of the time interval on the waveform he wants to measure. Then he presses the zero button on the DMM and again advances the control to the end of the desired point on the waveform. The time interval appears on the 3½-digit light-emitting-diode display. Accuracy is the same as that of the scope plus or minus one count. Either the millisecond or microsecond lamp lights up.

The combined instrument also measures temperature, a frequently ignored parameter that is a vital indicator of circuit performance. This adds an important capability to the engineer's kit of diagnostic tools. While the scope is displaying a signal for visual study, the temperature probe, which covers the range from -55 to +150°C and is connected to the DMM, can be monitoring the

temperature of critical devices. Maximum error is  $\pm 1.1^\circ\text{C}$  up to  $125^\circ\text{C}$ , and is  $\pm 2.1^\circ\text{C}$  from  $125^\circ$  to  $150^\circ\text{C}$ . As an example, an engineer can monitor the case temperature of a device for various signal levels.

The instrument package enables engineers to add normal temperature ranges to schematics—not only of transistors, but also of transformers and motors. Among other benefits, specification of case temperature on schematics would help in trouble-shooting in the field.

Equipped with its own power supply and test leads, the DMM has a stand-alone capability for measuring dc voltage in five ranges from 200 millivolts to 1,200 volts. The common terminal may be floated 500 v dc above ground. Six resistance scales range from 200 ohms to 20 megohms.

The multimeter adds 1 inch to the height of the portable scope and a

little less than 4 pounds to its weight. Price of the DM43 multimeter, which has the temperature-measurement capability, is \$475, plus the price of the scope. Model DM40, which does not include the temperature-measurement capability is priced at \$390 plus the cost of the scope.

Tektronix Inc., P.O. Box 500, Beaverton, Ore. 97005 [338]

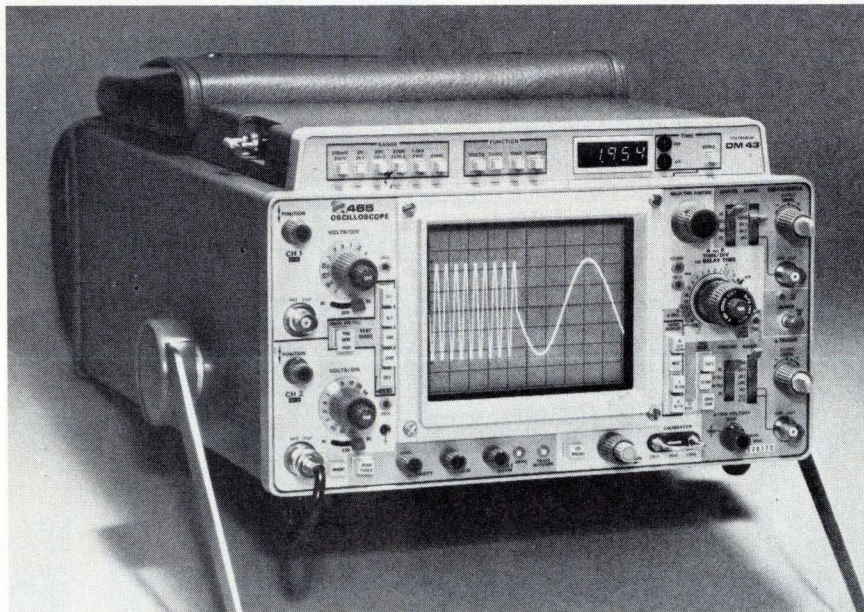



# PDP-8/A

# Computers for \$572.

# Fresh from

# The OEM Factory.

A lot of people needing computers are stopped cold by the price. But here's a start-up computer that's easy to warm up to. Digital's mini-processor. The PDP-8/A. It's 1.5 microseconds fast. Has 1024 words of memory included in the basic processor. And is expandable to 32K.

The OEM Factory rolls out this minicomputer at micro-processor prices — just \$572 in quantities of 100 for the two-board version. And in quantities of 100, you can get the packaged system for only \$1117.

Suddenly there's a lot more you can do with a computer economically.

Whether you use it as a control module, or the brain behind an intelligent terminal, or the computer power for a host of new applications, the PDP-8/A has a lot to offer.

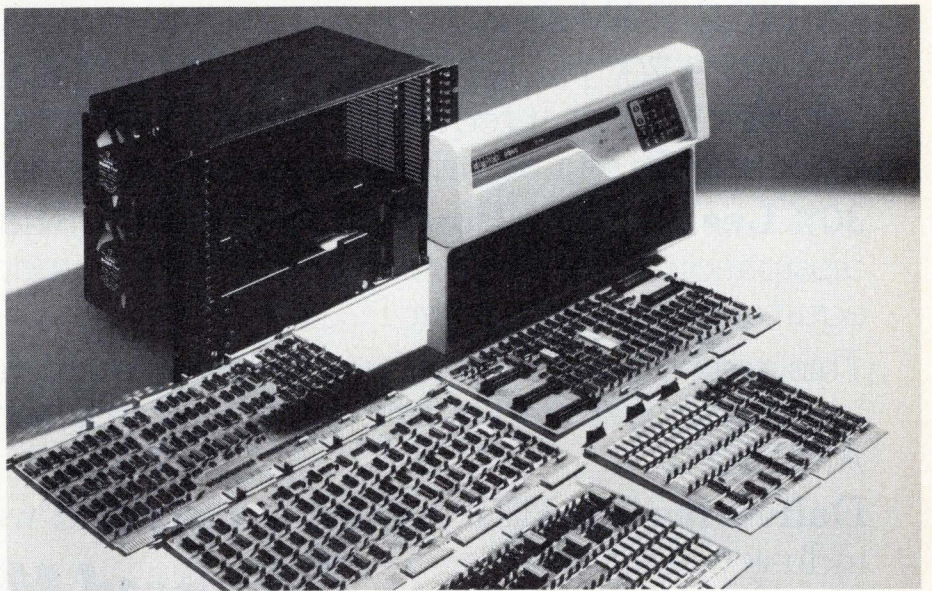

It's completely compatible with all the software and peripherals of the famous PDP-8 family encompassing over 25,000 installations.

And for systems planning, integration, and maintenance, there's Digital's unsurpassed support and service.

Just what you'd expect from the world's largest supplier of minicomputers and

modules. A worldly \$572 computer.

Digital Equipment Corporation, Maynard, Mass. 01754 (617) 897-5111, Ext. 3356. European headquarters: 81 route de l'Aire, 1211 Geneva 26. Tel: 42 79 50. Digital Equipment of Canada Ltd., P.O. Box 11500, Ottawa, Ontario K2H 8K8. (613) 592-5111.

**digital**

# The Fastest 1K RAM Runs Cooler than Bipolar

PRODUCT	ACCESS TIME	STANDBY POWER PER BIT	PRICE VOLUME QUANTITIES
AMS 7001	60 nsec (0°-70°C)	60 microwatts	≅ 1¢ per bit
Bi-Polar	45 nsec typical at 25°C	600 microwatts	> 1¢ per bit (aver.)
Other Fast 1K RAM's	80 nsec (0°-70°C)	100 microwatts	≅ 1¢ per bit

**The 7001, a 1024 x 1 Bit Static N-MOS RAM** The 7001 RAM is 20% faster over

the commercial temperature range than bipolar and other fast 1K MOS RAM's.

The AMS 7001 is easy to use since it is static, eliminating the need for refresh circuitry. It requires only one high level input clock, and all other inputs can be driven by TTL gates with a pull-up.

**30% Less System Power Consumption** The 60  $\mu$ W/Bit standby power dissipation of the 7001 is an order of magnitude lower than that of equivalent speed bipolar RAM's.

This results in a 30% power savings which has already been demonstrated in both memory cards and systems built with the AMS 7001.

**Deliveries** The 7001 has already received wide acceptance and is an industry standard.

There are over 200,000 7001's installed and operating to date. The 7001 is multiple sourced and distributors have it in stock.

(213) 986-3895 Los Angeles, Ca.  
(617) 828-2181 Boston, Ma.  
(408) 734-4330 Ext. 300 Sunnyvale, Ca.

Our name is our business. We build advanced memories—devices, subsystems and systems.

## Advanced Memory Systems®

**AMS** 1276 Hammerwood Avenue, Sunnyvale, CA 94086

Name: \_\_\_\_\_

Title: \_\_\_\_\_

Company: \_\_\_\_\_

Address: \_\_\_\_\_

City: \_\_\_\_\_ State: \_\_\_\_\_ Zip: \_\_\_\_\_

Phone: \_\_\_\_\_

Have salesman call

Send Data Sheet



# Optical waveguide spans 500 meters

Electrical-to-optical signal converter uses input data to modulate LED source in system marketed for prototype and developmental work

**The promise** of fiber-optic waveguides in various telecommunications applications [*Electronics*, March 21, p. 89] comes a step closer to fruition with marketing of a complete optical data link, including a low-loss multimode optical waveguide bundle, by Corning Glass Works.

Although the system is available off the shelf, the relatively high price is likely to restrict its use in the immediate future to prototype and developmental applications.

The optical data link consists of the 19-fiber bundle with an electrical-to-optical signal converter at one end and a reconversion unit at the other. To enhance compatibility with existing hookups, the input and output signal connections are provided by BNC connectors. Power is externally supplied via receptacles included in the transmitter and detector package. Links are available in lengths up to a maximum of 500 meters.

The electrical-to-optical signal converter uses the input data to modulate a light-emitting-diode source. The reconverter at the output uses an avalanche photodiode and amplifier electronics to produce a replica of the input electrical data. The LED source and avalanche photodiode detector are specially packaged by Texas Instruments to be compatible with the waveguide-bundle terminations and connector bulkheads jointly developed by Corning and the Deutsch Company.

The optical fiber bundles consist of 19 multimode step-refractive index optical waveguides jacketed in polyvinyl chloride. They have maximum signal attenuation of 30 decibels per kilometer at a wavelength

of 820 nanometers. The choice of 19 fibers per bundle was made, according to Corning, to allow the waveguide bundle to be compatible with commercially available LEDs.

Terminations for the waveguide bundle without the transmitter-receiver modules are either a closely packed hexagonal-array termination that is compatible with the source and detector of the data link or a general-purpose glass ferrule.

The waveguide bundle has a numerical aperture of 0.14 and therefore accepts light rays incident on the waveguide fiber cores at angles of 8° or less. The attenuation in the fiber bundles is minimum between wavelengths of 800 to 900 nm, which corresponds to gallium-arsenide diodes and around 1060 nm, which is the primary wavelength of the neodymium-YAG glass laser.

The usable bandwidth is determined by a complex set of factors involving the LED source, the fiber

length, and the avalanche photodiode detector and its associated electronics. Currently usable bandwidth is about 30 MHz. Initial applications will include process control and communications.

The key advantages of waveguide links lie in high dielectric isolation, extremely high immunity to electromagnetic interference, and lighter weight than comparable wire bundles.

Waveguide bundles are available in maximum lengths of 500 meters. Cost is \$57 per meter for orders of less than five kilometers and \$28.50 per meter for orders of five or more kilometers. A minimum order of \$1,000 is required.

The price of the entire link consists of the cost of the connecting waveguide plus \$1,000 for the transmitter and receiver modules.

Telecommunication Products Department, Corning Glass Works, Corning, N. Y. 14830 [339]

**Telecommunications system.** Optical-waveguide link includes 19-fiber bundle and, in foreground, input and output units. Chart shows performance curves of prototype system.

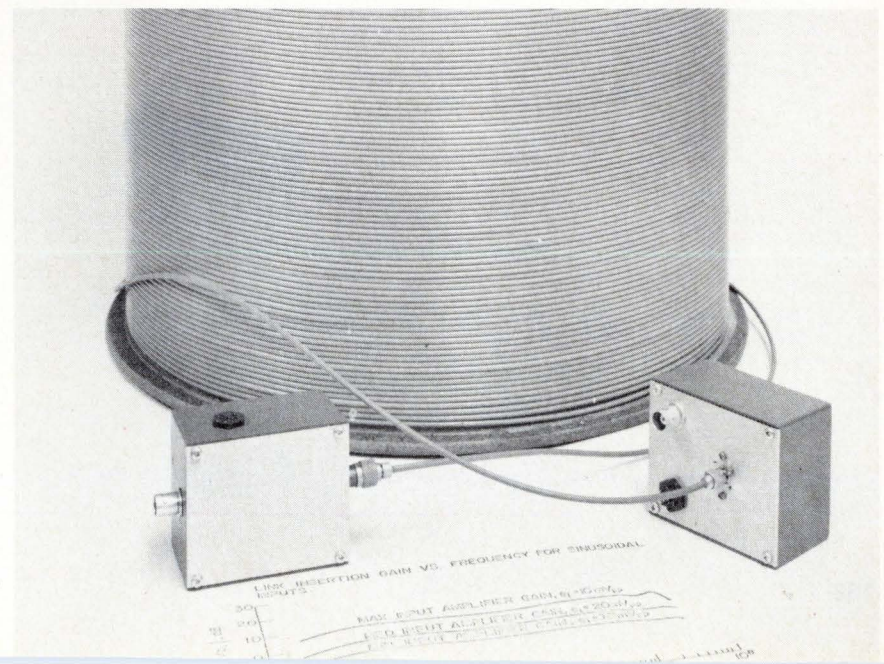

**All those little  
wires have been  
pushed around  
long enough.**



Until now, all those wires have been at the mercy of packaging materials that expand when things get hot.

So we developed new Dow Corning® 480 semiconductor molding compound.

Dow Corning 480 has a low coefficient of thermal expansion.

So it virtually eliminates the hot intermittent open. And moisture penetration.

Which means that an integrated circuit stays integrated. Through all sorts of temperature and atmospheric extremes.

But that's not all that's different about 480 molding compound.

Its resistance to salt spray is excellent.

And it reduces your packaging costs because it saves time. Molding times are short—less than one minute for some components. Post curing is unnecessary.

Of course, Dow Corning 480 molding compound also has the advantages of our other silicones. Consistency. Long shelf life. Less cleaning downtime because there's no buildup. Non-flammability. And, because it doesn't irritate skin, there's no need for special handling.

Dow Corning 480 semiconductor molding compound is the kind of improved product you can expect to keep getting from Dow Corning. Our Technical Service and Development Department has more manpower and greater technical facilities than any other in the industry.

If you want to know more about 480, call us at 517 636-8000, or write Dow Corning Corporation, Dept. B-4334, Midland, Michigan 48640.

**DOW CORNING**

DOW CORNING

## Components

**Switches aimed at metric design**

---

Applications for rocker units seen in new and redesigned test, data-handling equipment

---

As more and more equipment manufacturers begin to convert to metric dimensions in the design phase of their product cycles, component manufacturers can be expected to

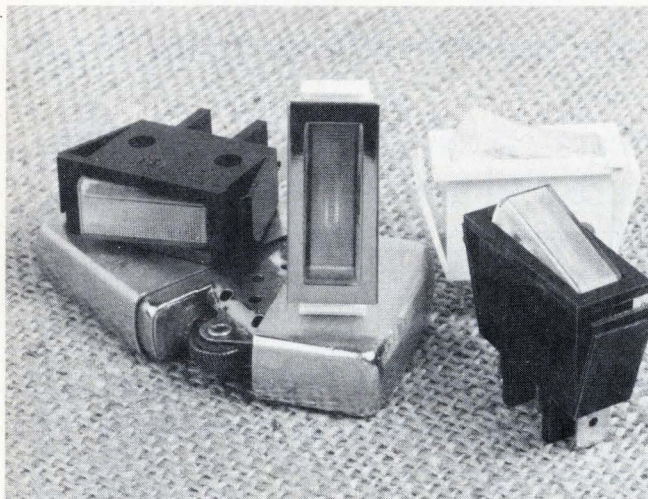

follow suit. They will begin supplying standard product lines in "hard metric" specifications instead of English units with metric dimensions added parenthetically.

Oak Industries' Switch division is introducing a line of all-metric rocker switches, said to be the first available from a domestic manufacturer.

"By designing for the metric market, we realize that we're bypassing opportunities in the retrofit market," says product manager Dean Bach, so we're aiming at new products and totally redesigned products."

The rocker switches, representing a new market for Oak, are designed for test and measurements, as well as computer and peripheral-equipment markets, although Bach expects to see some applications by

appliance manufacturers.

The line consists of single-pole, single-throw and single-pole, double throw snap-action switches with silver contacts, an illuminated SPST type with snap action, and unlighted momentary SPST and SPDT models, normally closed. All are rated at maximums of 16 amperes at 120 volts or 8 A at 240 V ac (inductive). They use a common black or white housing that measures 33.4 by 33 by 15 millimeters. The switches, which accommodate a maximum panel thickness of 1.42 mm, are available in versions with or without chromium trim.

Actuators are either flat or concave, and the lighted versions have red, amber, or clear lenses. Price of the unilluminated switches is about 50 cents each in production quantities, and delivery time is eight to 10 weeks.

Small off-the-shelf quantities will be available from stock in July.

Oak Industries Inc., Switch Division, Crystal Lake, Ill. 60014 [341]

---

**Time-delay relay works**

from 0.1 s to 10 minutes

A solid-state time-delay relay that allows independent adjustment of off-on and on-off time intervals is offered in seven combinations that include: factory-fixed, dual concentric knobs on top, and remotely adjustable. The series FDR, available with eight-pin or 11-pin plug-in sockets, also provides five time ranges from 0.1 second to 10 minutes in  $\pm 5\%$ ,  $\pm 10\%$  and  $\pm 20\%$  time tolerances. Repeat accuracy is to within  $\pm 2\%$ . The relay has a built-in transient protector and a life of more than 1 million operations un-

der load and 100 million mechanical operations. Price ranges from \$35.11 to \$49.50 each, depending on tolerance and quantity.

Omnetics Inc., Box 113, Syracuse, N.Y. 13211 [343]

---

**Slide switches aimed at calculators, test equipment**

Using a ball-and-spring detent mechanism and contacts with wiping action for low resistance, a line of subminiature slide switches is designed for calculators, test instruments, communications equipment, and sound systems. The basic switch measures 0.433 inches long, 0.213 in. wide, and 0.197 in. high. Rating is 0.3 ampere at 125 volts ac.

Alco Electronic Products Inc., 1551 Osgood St., Andover, Mass. 01845 [363]

---

**Optically coupled relay can handle 20 amperes**

An optically coupled, 20-ampere solid-state relay with zero-crossover switching is designated the model EOT. Because of zero crossover, the single-pole, single-throw, normally open switch has minimal electromagnetic interference, and its expected life is in excess of 100 million operations.

The EOT comes with two basic control circuits: constant current and constant impedance, with inputs from 3 to 32 volts dc. Each type offers output-current ratings of 2, 4, 5, or 7 amperes, 120 V ac, 50 to 60 hertz, at 25°C. With factory-recommended heat-sinking, these ratings increase to 4, 8, 12, and 20 A, respec-

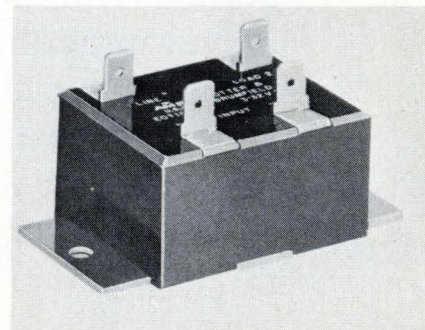

tively, the company reports.

A  $dv/dt$  network across the switch provides protection against false triggering by all but the fastest voltage transients. A metal-oxide varistor, available on one model, prevents false triggering by transients that exceed the switch blocking voltage. Operating ambient temperature is from  $-10^{\circ}\text{C}$  to  $+55^{\circ}\text{C}$ . Isolation is 1,500 v rms at 60 Hz.

Potter & Brumfield Division, AMF Inc., Princeton, Ind. 47670 [345]

Solid-state relays feature zero-crossover switching

Solid-state relays, which provide zero-crossover switching of high-power ac reactive loads, are available with either of two input voltage

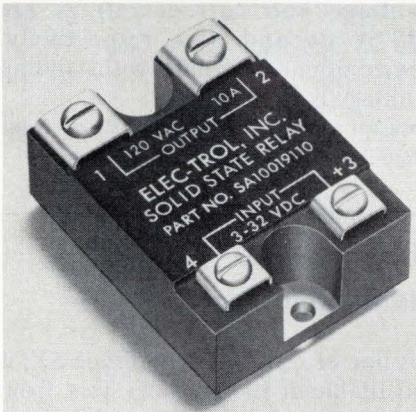

ranges and with 6- or 10-ampere outputs at 140 to 280 v rms. The zero-crossover function applies to the load ac voltage that is free of electrical noise and transient surges that cause radio-frequency interference. Photo isolation between input and output is 1,500 v rms.

Elec-Trol Inc., 26477 N. Golden Valley Rd., Saugus, Calif. 91360 [344]

Resistor provides overload protection

A positive-temperature-coefficient resistor that can sense case temperature of a high-power semiconductor and reduce power dissipation when dangerous current or power limits

# There's a world of difference between Dow Corning and the other semiconductor packaging-materials suppliers.

The difference is that only Dow Corning has available worldwide a complete line of silicone molding compounds, an accomplished technical service and development team, the advantage of a completely compatible product line, and the convenience of worldwide delivery and service. If you want to give your packaging operation a competitive advantage, just call or write. One of our representatives is nearby.

J. Guillot  
DOW CORNING S.A.R.L.  
140, Avenue Paul Doumer  
92500 Rueil Malmaison  
France  
Telephone: 977.00.40

M. Tedone  
DOW CORNING SpA  
Viale Restelli 3/7  
20124 Milan, Italy  
Telephone: 688.2458

## ASIA

H. Takahashi  
DOW CORNING ASIA LTD.  
P&O Building, 9th Floor  
21 Des Voeux Road, C.  
Hong Kong  
Telephone: 5-258035

H. Hotta  
DOW CORNING ASIA LTD.  
Room 803, Cathay Building  
Mount Sophia  
Singapore - 9  
Republic of Singapore  
Telephone: 321213-5

## AUSTRALASIA

H. Tuynman  
DOW CORNING AUSTRALIA PTY. LTD.  
36 O'Dea Avenue  
Waterloo, N.S.W. 2017  
Sydney  
Telephone: 699 8055

P. Winter  
DOW CORNING AUSTRALIA PTY. LTD.  
103 High Street  
Pahran, Vic. 3181  
Telephone: 51 5450

Dow Corning semiconductor molding compounds...quality and dependability worldwide.

B-4335

## NORTH & SOUTH AMERICA

Resins and Chemicals Marketing  
DOW CORNING CORPORATION  
Midland, MI 48640  
Telephone: 517 636-8682

## EUROPE

R. Hediger  
DOW CORNING INTERNATIONAL LTD.  
Chaussée de La Hulpe 177  
1170 Brussels, Belgium  
Telephone: 73.80.60

B. Sneddon  
DOW CORNING LTD.  
Reading Bridge House  
Reading RG1 8PW  
Berkshire, England  
Telephone: Reading 57251

R. Jones  
DOW CORNING GmbH  
1150 Vienna  
Mariahilferstrasse 180/4  
Austria  
Telephone: 83.85.38

S. Haberer  
DOW CORNING GmbH  
8000 Munchen 50  
Pelkovenstrasse 152  
West Germany  
Telephone: 14.861

# DOW CORNING

DOW CORNING

# adam

## UP YOUR ACCOUNTABILITY!

A student trained on the same equipment utilized in the electronics industry is better prepared to get, and keep, a good job in electronics.

Now, E&L Instruments introduces a new "hands-on" electronics training package incorporating the industry-proven ADAM modular circuit design system. The ADAM educational system is a complete teaching package including self-programmed individualized lab manuals (with 20 basic IC experiments), teacher's guide, all necessary IC's and components, and, of course, the ADAM modular circuit design system with 5 power supplies, function and pulse generators, read-outs, and solderless component sockets.

It all adds up to the best program for learning now, and earning later. Write today for full details.

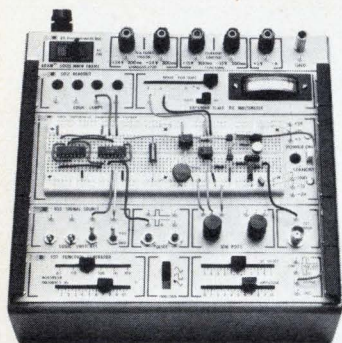

### MAN, WHAT A BEGINNING FOR YOUR CIRCUIT DESIGN LAB!



**E&L INSTRUMENTS, INC.**  
61 First Street, Derby, Conn. 06418  
Phone (203) 735-8774 Telex No. 963536

Circle 142 on reader service card

## The Real Time Spectrum Analyzer you've needed...



### is now within your budget!

If you've been "making do" with sound level meters, tracking filters, wave analyzers or other limited frequency analysis techniques — we've got exciting news for you.

For only \$5000 you can now buy all the advantages of real time narrow band spectrum analysis with our 200-line Saicor 51B Real Time Analyzer/Digital Integrator . . . and get built-in spectrum averaging and linear, peak hold and exponential averaging modes. A superior frequency analysis technique for thousands of dollars less than ever before. Can you afford not to find out more? Call for a demonstration or write today for our free "25 Ideas" brochure.



## Honeywell

Signal Analysis Operation/Test Instruments Division  
595 Old Willets Path/Hauppauge, New York 11787/(516) 234-5700

142 Circle 218 on reader service card

## New products

are approached is called the Posistor, model PTH 487A. In a typical application, the resistor is mechanically affixed to the semiconductor case and electrically connected in series with the base-biasing circuit. The resistance of the unit is nominally 500 ohms at normal operating temperatures. This resistance increases rapidly when the protective temperature threshold is reached.

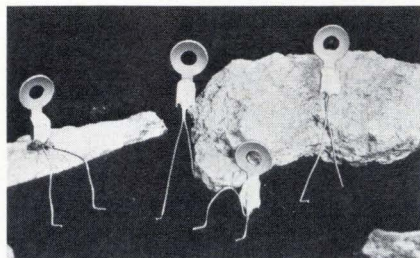

This is 2,000 ohms at 176°F and 3,000 ohms at 194°F. Maximum voltage and current ratings are 12.5V dc and 0.1A respectively. Maximum external withstanding voltage is 15V dc.

Murata Corp., 2 Westchester Plaza, Elmsford, N.Y. 10523 [346]

Resistors are rated from 40 mW to 5 W

A line of resistors, called type SX, is available in 100 physical sizes, from 40 mW through 5 watts, and in thousands of variations in resistance values and tolerances to fit particular applications. All type SX resis-

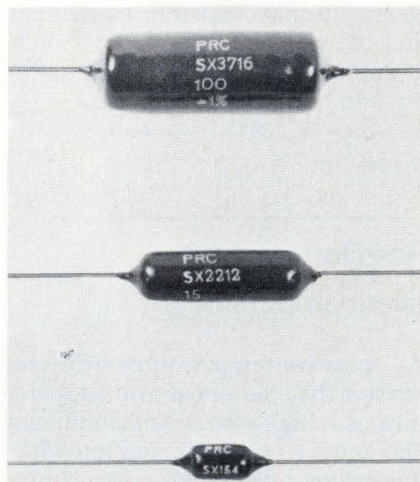

Electronics/June 13, 1974

# We spot a way to save you up to 60% in gold costs.

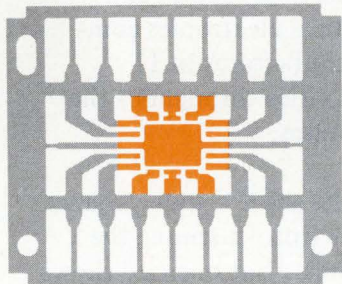

Apply gold precisely—and only—in places where it's absolutely needed. That's the Plessey difference in spot-plating. And it makes one enormous difference in your operating costs—considering the price of gold today.

Our application system is golden. It allows us to have extremely accurate control of size, shape and registration. So you never end up paying for gold applied to the base metal when it's not required.

We've earned our stripes in gold and silver plating, too. With control of the width, thickness and location on metal strip stock and stamped metal down to a gnat's eyebrow. To save you a bundle in precious metal costs. And give you unheard of cross-sectional plating profiles.

Tell us where you want it. Center stripe? On one edge? On both edges? Any combination you like—you get. We can stripe-on-stripe process

continuous metal strip to give you all kinds of nifty configurations. Like bare metal on one side, with overlapping or superimposed stripes of different plating on the other.

Plessey can do a quality job for you in ribbon and wire plating, too. We've got the people, the goods, and 14 solid years experience to tailor our plating to your environmental, temperature and solderability requirements. Including "on-line" testing while your material is being plated.

And in this business, that's as close to a gold-plated guarantee as you can get.

Plessey Chatsworth  
20245 Sunburst Street  
Chatsworth, California 91311

Lay it on me, Plessey. If you can show me how to make my gold go further, your gold plating brochure may even earn you some orders.

Name \_\_\_\_\_

Title \_\_\_\_\_

Company \_\_\_\_\_

Street \_\_\_\_\_

City \_\_\_\_\_

State \_\_\_\_\_ Zip \_\_\_\_\_

Phone \_\_\_\_\_



**PLESSEY INCORPORATED**  
**PLESSEY CHATSWORTH**

20245 Sunburst St., Chatsworth, Calif. 91311  
(213) 341-7770

# Would you consider another plant location if you could increase net income by 10%?

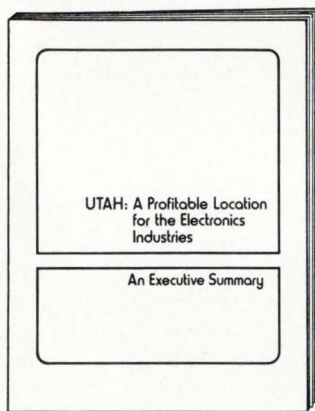

A new research study examines the critical cost factors of a hypothetical electronics computer manufacturer in 11 different cities throughout the United States.

The results show a wide variance in total net profit among the various areas, but one city shows a profit potential 10% higher than the average for all the others. (In dollars, the after-tax profit range is from \$5.5 thousand to more than \$1 million annually.)

The complete report runs 125-pages with well documented tables, charts and background information. But an easy-to-read 24-page Executive Summary is available to you for the asking. Just drop your business card in an envelope and mail to:

**John Rencher, Director  
Utah Industrial Promotion  
Division  
No. 2 Arrow Press Square,  
Dept. E-613-4  
Salt Lake City, Utah 84101**

## New products

tors are encapsulated in a solvent-resistant, silicone protective coating that withstands high temperature for wave-soldering processes.

Precision Resistor Co., 109 Rte. 22, Hillside, N.J. 07205 [347]

Switch is activated  
by very little pressure

For applications in copy machines, programers, paper sensors and timers, a miniature switch, the V3, needs very little pressure for activation. The low-force device offers fine silver or gold-alloy crosspoint contacts and accepts pin plunger operating forces as high as 15 and 25 grams. Solder, screw, and quick-connect terminals are also available. Versions in the line handle 3 or 5 amperes at 125 v through 250 v ac from -65 to +185°F.

Micro Switch, 11 W. Spring St., Freeport, Ill. 61032 [348]

Cermet trimmer designed  
to eliminate springback

A new single-turn,  $\frac{3}{8}$ -inch-square, cermet trimmer, the model 63, has been designed to almost eliminate springback problems and provide reliable setability. Offered in both top-adjust and side-adjust configurations, the trimmer plugs into models 362, 3389, and 72 sockets. The model 63 is priced at 60 cents in quantities of 100.

Spectrol Electronics Corp., 17070 E. Gale Ave., City of Industry, Calif. 91745 [349]

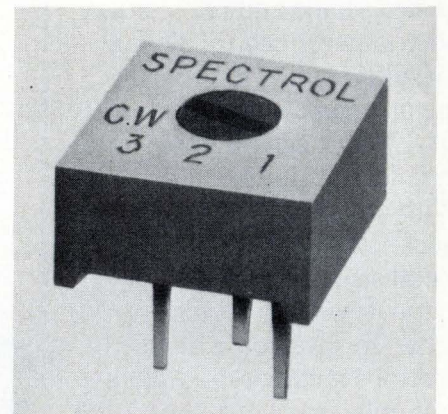



# Dramatic new product opportunities ... yours with new 3C8 ferrites

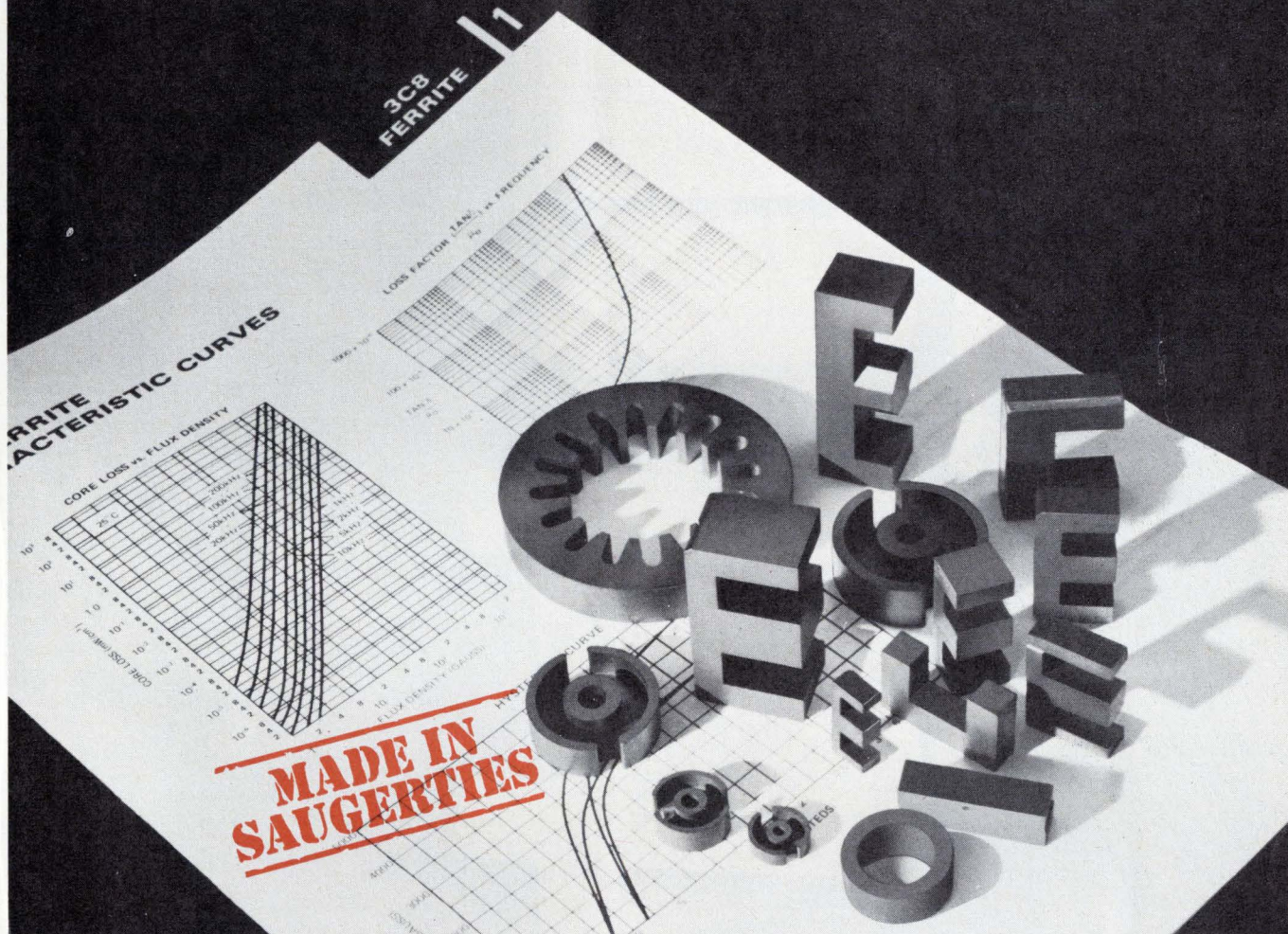

The market is ripe for product breakthroughs. Just look, for example, at the growth of such items as the hand-held calculator, small camera flashguns, ultra-mini portable radios and recorders. The key to these tremendous sales successes is high frequency power conversion circuits.

And the key to still *more* efficient, high-frequency power conversion is Ferroxcube's new 3C8!

This important new ferrite material gives significantly higher flux densities at higher temperatures, and lower losses at high excitation levels than any other magnetic core material. It is available in practical size cores for use up to kilowatt power levels.

3C8 is already being used with great success in: inverters, battery chargers, fluorescent lamp ballasts,

strobe light devices for highway markers and harbor buoys, power oscillators, power amplifiers, ultrasonic generators.

In all of these circuits Ferroxcube's 3C8 material has led to greater efficiency, lower cost, less weight, and smaller sized units. In one power supply, for example, the size of the core was reduced from 13 lbs. at 60Hz to 4 lbs. at 20,000 Hz and the volume from 35 to 9 cu. inches—savings of 70 to 75%!

Can 3C8 improve your present products or suggest new products and markets for your company? If you've got the imagination, we've got the core! Call 914•246-2811, TWX 510-247-5410 or write today.

Ferroxcube linear ferrites—made in Saugerties, N.Y. and stocked in seven U. S. locations.



**FERROXCUBE** CORPORATION, SAUGERTIES, N. Y. 12477

A NORTH AMERICAN PHILIPS COMPANY

TM Distributed through North American Philips Electronic Components Corporation with warehouses in Boston, 617-899-7100; New York, 516-538-2300; Saugerties, 914-246-5861; Philadelphia, 215-836-1616; Chicago, 312-593-8220; San Diego, 714-453-9250

16404

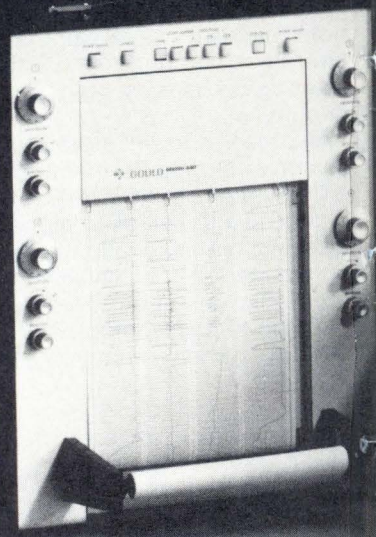
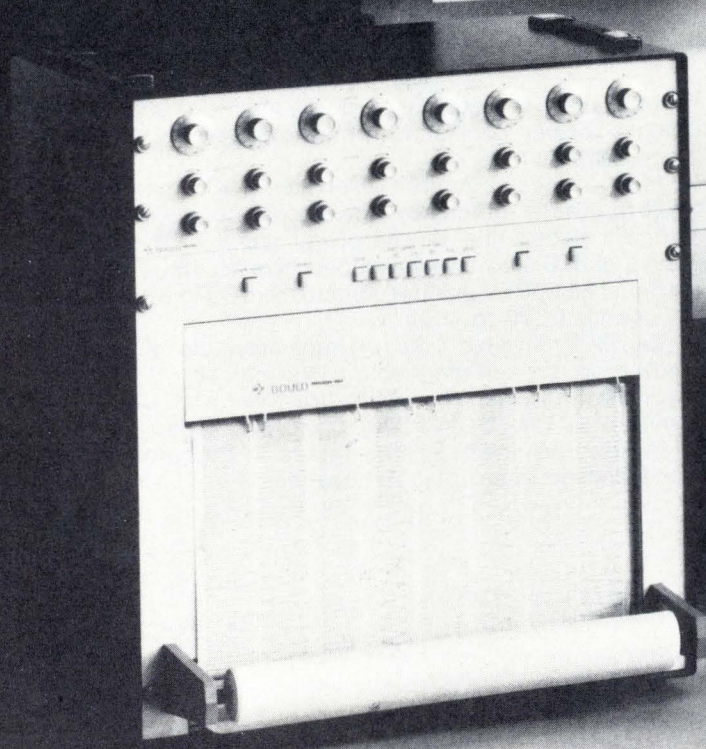
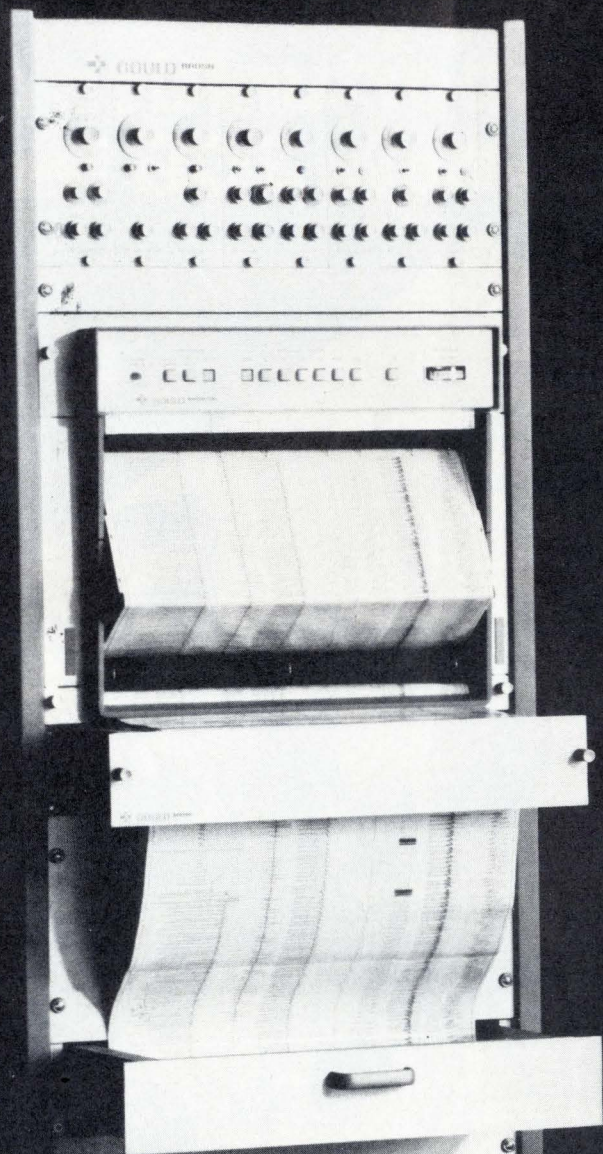

# Six good reasons why Brush recording systems are your best buy.

**1.** Brush has the broadest line in the industry.

We make a recorder/signal conditioner to meet just about any industrial or scientific application.

Choose from 1 to 8 channel direct writing recorders with or without built-in preamps; full scale frequency responses from 35 Hz to 55 Hz; 40 mm, 80 mm and 4½" wide channels; portable and rack mounted models.

**2.** Brush guarantees better than 99.5% linearity.

There are two reasons why we can guarantee such a high degree of accuracy. First, our Metrisite non-contact servo-loop feedback device. Second, our recorders have a rectilinear presentation which eliminates geometric errors.

**3.** The Brush pressurized inking system gives you the highest quality traces.

For twelve years, Brush traces have been the standard of the industry. Our pressurized inking system writes dry. It eliminates smudges, smears, skips and puddles. The record you get is crisp, clear and permanent.

**4.** Brush recording systems give you trouble-free operation.

All of our instruments require minimal maintenance. For example, our disposable ink supply usually lasts more than a year. And all of our electronics are solid state.

**5.** A Brush system is easy to operate.

All of our systems are self-calibrating. Controls are conveniently placed to give you maximum flexibility. Chart

paper can be replaced in seconds. Switching signal conditioners is a snap.

**6.** Brush is a single source for everything you need.

We offer custom financing and leasing plans. Our installation, training, and maintenance programs are geared to your needs. And our warranty and replacement parts packages are two of the best in the industry.

If you'd like to find out more, contact your nearest Gould Sales Engineer or Representative. Or write for detailed performance information and specifications. Gould Inc., Instrument Systems Division, 3631 Perkins Avenue, Cleveland, Ohio 44114. Or Kouterveldstraat Z/N, B 1920 Diegem, Belgium.

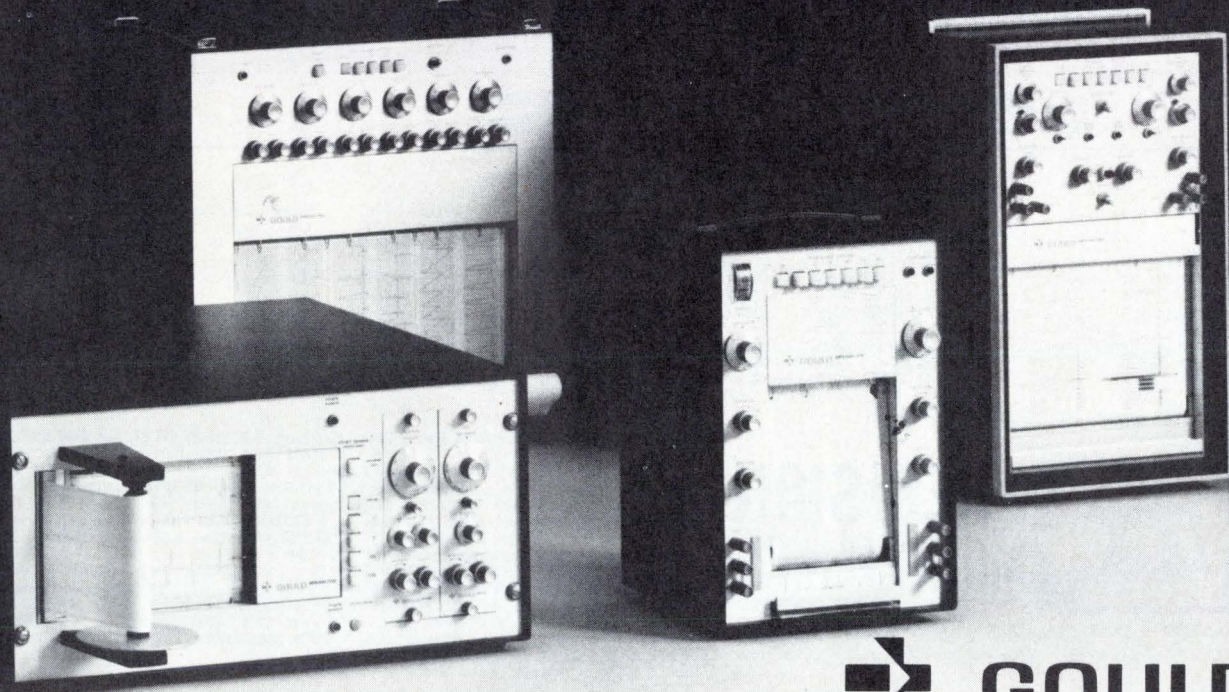

 **GOULD**

Circle 147 on reader service card

# CONVERT 8 BITS IN 6 MICROSECONDS FOR \$25.....

*it's easy!*

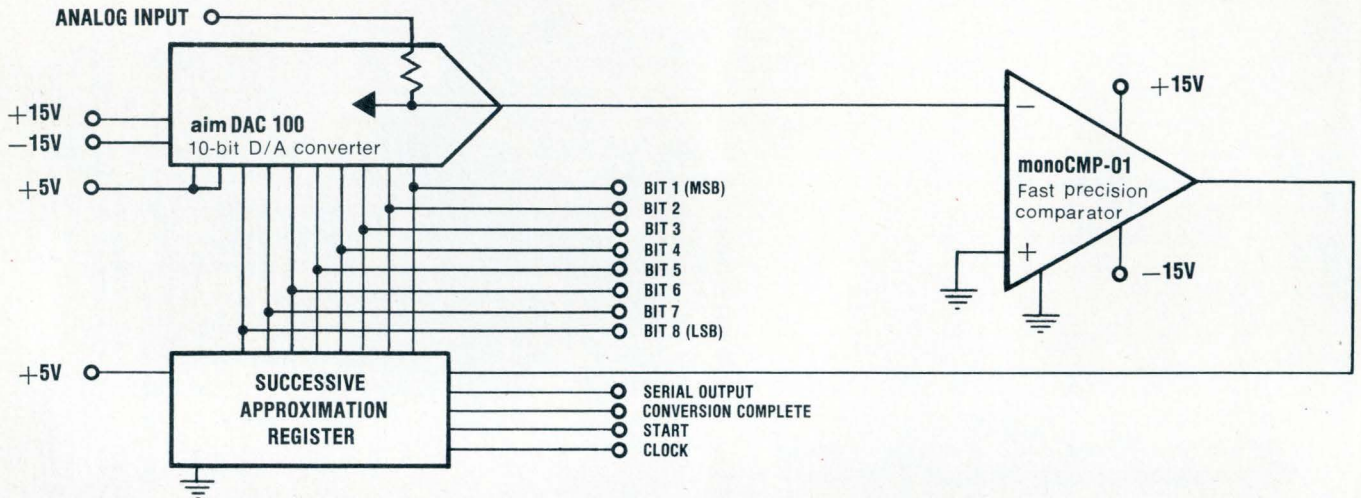

## THREE IC'S BUILD A FAST A/D CONVERTER - FOR UNDER \$25!

It's easy with high performance analog components from Precision Monolithics—start with PMI's aimDAC100 Low Cost D/A Converter—with its internal precision reference voltage, 10-bit resolution, choice of linearities and high speed current output, it's ideal for all D/A and A/D applications. Next, add the PMI monoCMP-01 Precision Comparator with its fast 90ns response, low Vos, drift and superior stability—complete your converter with a

successive approximation logic chip and that's it! Sound easy? You bet—and 10-bit versions can be built for under \$40! Circuit construction and performance are fully detailed in our new Application Note: pre-drilled demonstration circuit cards are available free by contacting your local PMI rep or stocking distributor—call him today and find out how easy A/D conversion can be!

SPECIFICATIONS		PRICES
aimDAC 100 DDT1*	0.30% Linearity Max-0/70°C	\$ 9.95 @ 100 pcs.
aimDAC 100 CCT1*	0.20% Linearity Max-0/70°C	\$12.00 @ 100 pcs.
aimDAC 100 BCT1*	0.10% Linearity Max-0/70°C	\$17.00 @ 100 pcs.
aimDAC 100 ACT1*	0.05% Linearity Max-0/70°C	\$26.00 @ 100 pcs.
*Specify T1 for 0 to 10 Volt usage; T2 for 0 to 5 Volt usage.		
monoCMP-01CJ	Vos 2.8 mV Max	\$3.25 @ 100 pcs.
monoCMP-01EJ	Vos 0.8 mV Max	\$7.50 @ 100 pcs.

### PRECISION MONOLITHICS REPRESENTATIVES

Alabama ..... (205) 539-4411  
 Arizona ..... (602) 992-9884  
 California, North ..... (415) 948-6533  
 California, Los Angeles ..... (213) 340-1745  
 California, South ..... (714) 830-3939  
 Colorado ..... (303) 771-4920  
 Connecticut ..... (203) 634-0179  
 Florida, Ft. Lauderdale ..... (305) 776-4800  
 Florida, Orlando ..... (305) 425-5505  
 Illinois, North ..... (312) 774-3535  
 Indiana ..... (513) 252-9981

Maryland ..... (301) 944-8262  
 Massachusetts ..... (617) 890-0011  
 Michigan ..... (313) 557-1934  
 Minnesota ..... (612) 646-7217  
 Missouri, St. Louis ..... (314) 731-5799  
 Missouri, Kansas City ..... (816) 761-6543  
 New Jersey, North ..... (516) 567-5900  
 New Jersey, South ..... (609) 966-4070  
 New Mexico ..... (505) 265-5655  
 New York, New York City ..... (516) 567-5900  
 New York, Upstate ..... (716) 464-8636

North Carolina ..... (919) 725-5384  
 Ohio, North ..... (216) 461-8333  
 Ohio, South ..... (513) 293-3145  
 Pennsylvania, East ..... (215) 644-3477  
 Texas ..... (214) 363-8591  
 Virginia ..... (703) 548-7818  
 Washington ..... (206) 624-9020  
 Wisconsin ..... (414) 933-2733  
 Canada, Toronto ..... (516) 864-2666  
 Canada, Vancouver ..... (714) 979-4894

### AUTHORIZED DISTRIBUTORS

NEW YORK METROPOLITAN AREA Harvey Radio, Woodbury, N.Y.: (516) 921-8700 • NEW ENGLAND AREA Gerber Electronics, Dedham, Mass.: (617) 329-2400 • UPSTATE NEW YORK Harvey Federal Electronics, Binghamton, N.Y.: (607) 748-8211 • NORTHEAST Newark Electronics, Woburn, Mass.: (617) 935-8350 • BALTIMORE-WASHINGTON Whitney Distributors, Baltimore, Md.: (301) 944-8080 • PHILADELPHIA Hallmark Electronics, Huntingdon Valley, Pa.: (215) 355-7300 • MICHIGAN RS Electronics, Detroit, Mich.: (313) 491-1000 • SOUTHEAST Kirkman Electronics, Winston-Salem, N.C.: (919) 724-0541 • EAST CENTRAL Pioneer/Cleveland, Cleveland, Ohio: (216) 587-3600 • Pioneer/Dayton, Dayton, Ohio: (513) 236-9900 • CENTRAL Hallmark Electronics, Elk Grove Village, Ill.: (312) 437-8800 • Minneapolis, Minn.: (612) 925-2944 • St. Louis, Mo.: (314) 521-3800 • TEXAS-OKLAHOMA Sterling Electronics, Houston, Texas: (713) 623-6600 • Dallas, Texas: (214) 357-9131 • SOUTHWEST Sterling Electronics, Albuquerque, N.M.: (505) 345-6601 • Phoenix, Ariz.: (602) 258-4531 • WEST Westates Electronics Corp., Chatsworth, Calif.: (213) 341-4411 • Sterling Electronics, San Carlos, Calif.: (415) 592-2353 • Intermark Electronics, Sunnyvale, Calif.: (408) 738-1111 • Denver, Colo.: (303) 936-8284 • Salt Lake City, Utah: (801) 359-0531 • San Diego, Calif.: (714) 279-5200 • Santa Ana, Calif.: (714) 540-1322 • Almac-Stroum, Seattle, Wash.: (206) 763-2300 • Portland, Ore.: (503) 292-3534.



1500 SPACE PARK DRIVE, SANTA CLARA, CALIFORNIA 95050  
 TEL. (408) 246-9225 • TWX 910-338-0528 • CABLE MONO

## New products

Industrial

# Panel meters cover wide range

Digital process indicators read out temperature, voltage, current, resistance

The variety of sensors used in industrial processes today, and the accuracy required in many systems, create a need for a wide range of digital panel instruments. Voltage, current, resistance, thermocouple and resistance-temperature-detector indicators are used for process and quality control in conjunction with strain gauges, thermocouples, analytic instruments with bridge detectors, and nonlinear sensors, to cite just a few examples.

The LFE Corp.'s Process Control division has introduced a line of panel meters, the 4358 series, designed specifically to work in these applications.

The highly sensitive voltage/current indicator, is available in 11 ranges—five voltage and six current. The voltage ranges go from 39.99 mV full scale to 399.9 V, with an input resistance of 100 megohms on the lower three ranges and 10 megohms on the top two. The current scales go from 3.999  $\mu$ A full

scale to 399.9 mA, with an input resistance of 10 kilohms on the two most sensitive ranges, dropping to 1 ohm on the top range. Significant overload protection is provided, especially for the more sensitive ranges. For example, the 40-mV range can tolerate 250 V, and the 4- $\mu$ A range can withstand 5 mA.

Long-term accuracy is within either 0.1 or 0.25% full scale, depending on range. Temperature coefficient is 0.008% full scale/ $^{\circ}$ C in all but two cases where it is 0.02% full scale/ $^{\circ}$ C. Each unit costs \$225.

The four-terminal resistance indicator, which provides resolution to 0.1 ohm, is designed for sorting, adjustment and inspection tasks, such as resistance trimming. It covers four ranges from 0 to 399.9 ohms to 0 to 399.9 kilohms, with sample currents ranging from 1 mA to 10  $\mu$ A. In all ranges, long-term accuracy is within 0.1% of reading  $\pm$ 0.2% full scale. Temperature coefficient is 0.01% full scale/ $^{\circ}$ C. Price of the instrument is \$245.

Curve-fitting 10-segment linearization is standard on the thermocouple indicator, and the linearization points can be rearranged for special applications. High input impedance permits the instrument to tolerate source resistances up to 2,000 ohms with no reduction in accuracy. The unit includes internal cold-junction compensation and flashing indication of thermo-

couple burnout. It can accommodate copper-constantan, chromel-constantan, iron-constantan, and chromel-alumel thermocouples, and in each case has input impedance of 100 megohms, maximum bias current of 1 nanoampere, and maximum voltage of 250 volts. Eight temperature ranges are

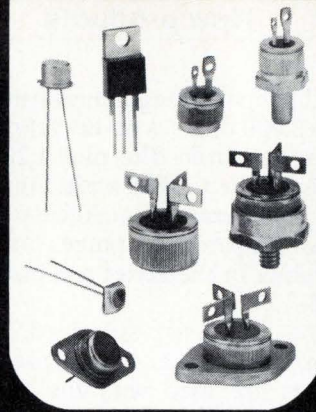
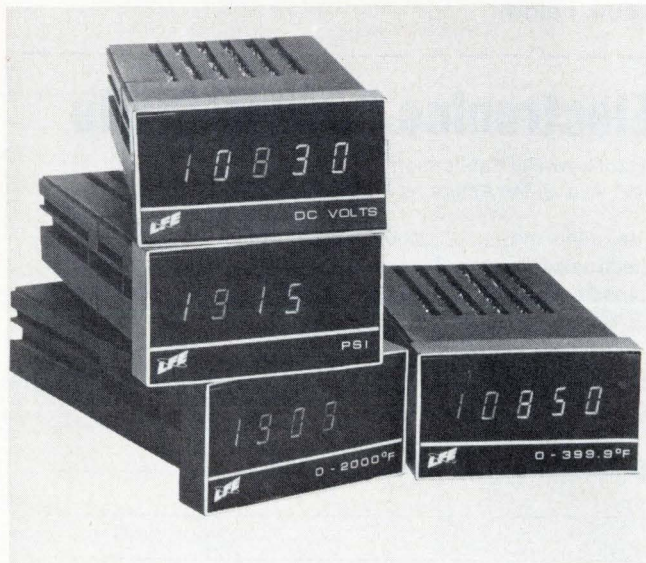

## SENSITIVE GATE TRIAC's

3mA, 4mA, 5mA, 10mA and 25 mA (IGT) All quadrant grating 50V to 600V ( $V_{DROM}$ )

Hutson TRIAC's and SCR's are ideally suited for solid state switches, motor speed controls, lighting, heating and air conditioning controls.

Patented Di-Mesa™ construction is designed to assure you of reliability and superior performance. Hutson's complete line of TRIAC's and SCR's are available as void-free, glass-passivated chips or in all standard package configurations.

Call on Hutson's state-of-the-art thyristor technology when you need reliability and economy.



Box 34235 • 2019 W. Valley View  
Dallas, Tex. 75234 (214) 241-3511  
TWX 910-860-5537

### Representatives:

New York City Area 201/399-4350.  
Seattle 206/454-0300. Los Angeles  
213/240-3151. Dallas 214/231-6181.  
Baltimore 301/944-8262. Denver 303/  
757-7679. Ft. Lauderdale 305/772-  
5100. Chicago 312/286-1500. Detroit  
313/499-0188. Syracuse 315/699-  
2671. Indianapolis 317/888-2260. At-  
lanta 404/427-0241. Canada 416/638-  
1322. Beaverton 503/643-1644. Dayton  
513/433-2511. Phoenix 602/968-9037.  
Minneapolis 612/866-3035. Boston  
617/890-8040. Kansas City 816/765-  
2998.

### Distributors:

Elizabeth 201/345-2420. Los Angeles  
213/240-3151. Denver 303/934-5505.  
Chicago 312/323-9670. Canada 416/  
635-9880. Rochester 716/454-7800.  
Salt Lake City 801/486-7227. Belgium  
02362135. Brussels 02352135. Den-  
mark (01) 295622. England (09924)  
67161. Norway 472702272. Spain 234-  
62-62. Sweden 08-28-5940. Switzer-  
land 051-852201.

## New products

available, spanning a range from -80 to +2,000 degrees on the Fahrenheit scale, and from 0 to plus 1,200 degrees on the Celsius scale. Accuracy and temperature coefficient vary with temperature range, and all the units in the series are priced at \$345.

The industry-standard 100-ohm/3,850-ppm/4-wire platinum probes are used with the RTD indicator, which provides 0.1° resolution. Temperature ranges vary from -80 to +399.9°F to 0 to 750°C. Probe current is 1 mA, and maximum input voltage is ±10 volts. Long-term accuracy is within 0.1% of reading ±0.2% full scale. Temperature coefficient varies from 0.0099% full scale/°C to 0.01% full scale/°C. Price is \$295. The unit can accommodate other types of probes as well because the 10-point linearization gives it flexibility, according to the company.

All four versions of the 4358

series have a 4½-digit display, with an optional hardwired zero digit in the least significant place to provide readout ranges to 39990. The curve-fitting linearization, standard on all temperature indicators, is optional on voltage, current, and resistance meters.

Price of the 4358 voltage/current indicator is \$225, the resistance indicator costs \$245, the thermocouple indicator is priced at \$345, and the RTD indicator is \$295. Delivery time is 8-12 weeks.

LFE Corp., 1601 Trapelo Rd., Waltham, Mass. 02154 [351]

### Gas, smoke detectors have high output sink current

Consisting of a gas-sensing semiconductor, an operational amplifier, a stable trigger circuit, and a high-output-current final stage, the mod-

els MXE 50812A, N & S and 70812 A, N & S gas and smoke detectors handle a wide variety of gases. The units also contain gold-plated connector strips spaced 0.1 inch apart, which allow them to be mounted horizontally or vertically. The models N and S feature high-output-current final stages, while the A model has an analog-output stage.

Metronix B.V., Box 74, Harderwijk, Holland [353]

### Infrared thermal imaging system is portable

The model 510 portable thermal imaging system scans the naturally emitted infrared radiation of objects, converting the radiation into an electronically displayed heat picture. Temperature differences of the picture can also be seen and measured. Frame rate is 30 frames per

# Energy Saver

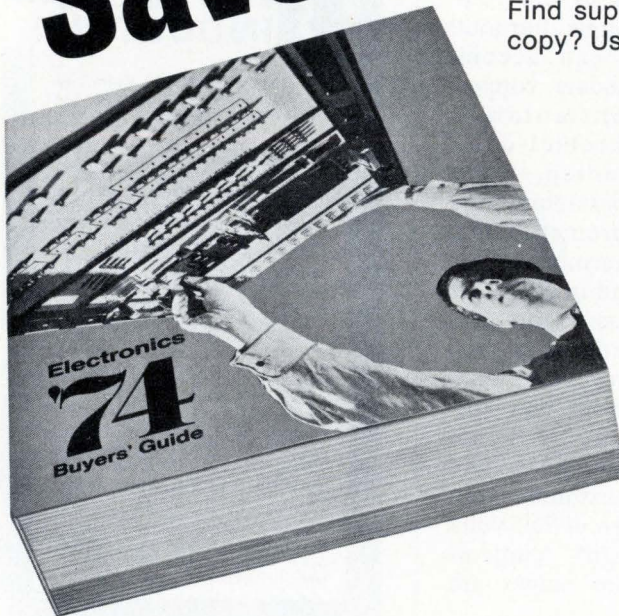

## NEW Electronics Buyers' Guide Easy-to-use, single volume source for:

- Information on over 4,000 products
- Over 6,000 company listings and phone numbers—both home and field offices
- **EBG EXCLUSIVE:** quick access to over 800 helpful catalogs through a timesaving Direct Inquiry Service.
- More than 1,400 pages of data

Here is the international world of electronics at your fingertips. Find suppliers...fast...accurately...and locally! Don't have a copy? Use coupon, below.

### Electronics Buyers' Guide

A McGraw-Hill Publication  
1221 Ave. of the Americas • New York, N.Y. 10020

Yes, send me \_\_\_\_\_ copies (copy) of the energy saving Electronics Buyers' Guide. I've enclosed \$15.00 (USA and Canada only; elsewhere send \$25.00). Full money back guarantee if not satisfied.

NAME \_\_\_\_\_

COMPANY \_\_\_\_\_

STREET \_\_\_\_\_

CITY \_\_\_\_\_

STATE \_\_\_\_\_ ZIP \_\_\_\_\_

# it takes more

than a spark gap to solve surge voltage problems like these...

## COMM GAPS PROTECT COMMUNICATIONS EQUIPMENT

Voltage surges from lightning and its secondary effects have very fast rise times which are hazardous to equipment and personnel. Signalite COMM GAPS are used in telephone, CATV, telegraph and other communications lines to protect against these hazards.

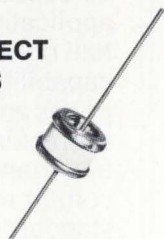

## POWER SUPPLY PROTECTION

Supply transformers are subject to line surges. Signalite COMM GAPS are used across transformer secondaries to prevent these surges from affecting power supply components or load circuits. COMM GAPS protect both laboratory and modular types.



## ELECTRICAL ENERGY TRANSFER

In circuits using capacitors and flash tubes, such as photoflash and strobe applications, it is necessary to dissipate large amounts of energy in a short time period. Low cost, miniature Signalite COMM GAPS provide increased speed of circuit function and improved reliability.



It takes application help from a group of surge protection specialists...  
...yours for the asking.



**SIGNALITE TRANSIENT VOLTAGE PROTECTION KIT**—includes 28 page illustrated technical manual on the applications of gas discharge devices in transient protection and energy transfer. Also detailed specifications bulletins and an applications engineering worksheet. Available from your Signalite representative or by contacting Signalite, 1933 Heck Ave., Neptune, New Jersey 07753, (201) 775-2490.

**SIGNALITE DIVISION  
GENERAL INSTRUMENT CORP.**



Circle 151 on reader service card

# Hi-Vacuum Feedthrus with Standard Connectors



**COAX  
TRIAx  
BSHV  
MHV  
BNC  
UHF  
MS  
N**

- Bakeable to 450°C\*
- Provide quick disconnect of shielded leads
- Hi-alumina ceramic-metal construction
- Single or multiple units supplied in weldable adapters or standard vacuum flanges

\*With lead disconnected



Request Cat. 7110 CC with details, drawings, ordering info.

**Ceramaseal, Inc.**

A SUBSIDIARY OF **INTERPACE CORPORATION**

NEW LEBANON CENTER, NEW YORK 12126  
518 794-6101 • TELEX 145442

## New products

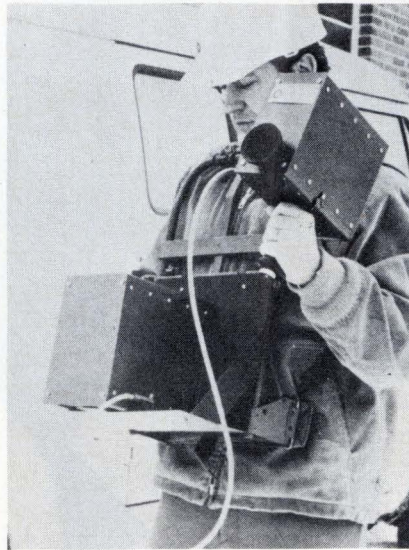

second, which provides a flicker-free cathode-ray-tube display of continuous real-time action. A detachable optical module is also offered. Price is less than \$10,000.

Dynarad Inc., 19 Strathmore Rd., Natick Industrial Park, Natick, Mass. 01760 [355]

Low-voltage monitor reduces damage, downtime

Priced at \$30, a low-voltage monitor, called the type LVS, is available in adjustable or nonadjustable 3- or 10-ampere versions. The unit helps prevent equipment damage and reduces downtime caused by low voltage. In operation, a relay de-energizes and automatically shuts down equipment when voltage drops to a dangerous level. After voltage returns to normal, the unit reconnects power to the system. A built-in 5-

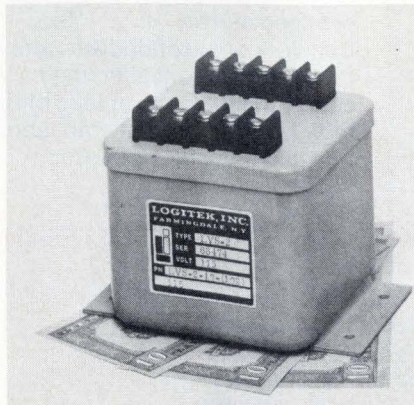

# The Crystal Filter with a Pedigree



Every crystal filter created by Damon is 100% performance tested. Ten to twelve critical parameters (including temperature performance) are measured and recorded. You get a certified performance report, parameter by parameter, with each Damon filter. No extra charge.

You may think of Damon filters as high-reliability, high-quality, high-price for aerospace and defense applications. You're only half right. New production capabilities, competitive prices and prompt delivery are making us a lot of industrial friends too—without compromising our high standards.

Damon: The economical crystal filter with aerospace blood lines.

Damon also manufactures a full line of VCXO's.

To receive a complete new Crystal Filter Catalog, write or call Ed Doherty, ext. 666.

**DAMON**

ELECTRONICS DIVISION

80 WILSON WAY, WESTWOOD, MASS. 02090 TEL: (617) 449-0800



# Sweep from 1 to 18.5 GHz this easy

**select  
and  
read  
with  
six  
choices**

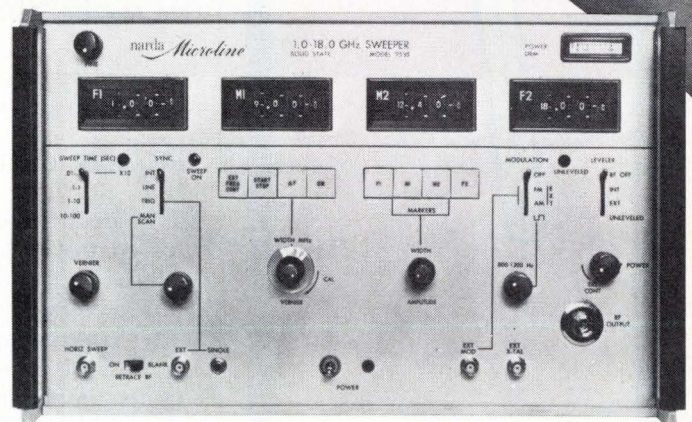
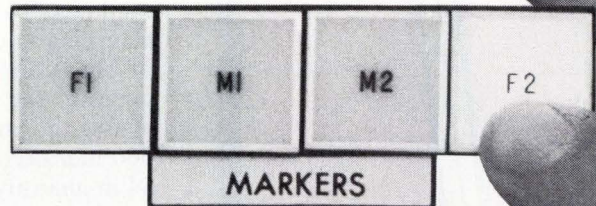
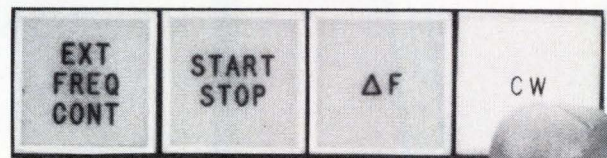
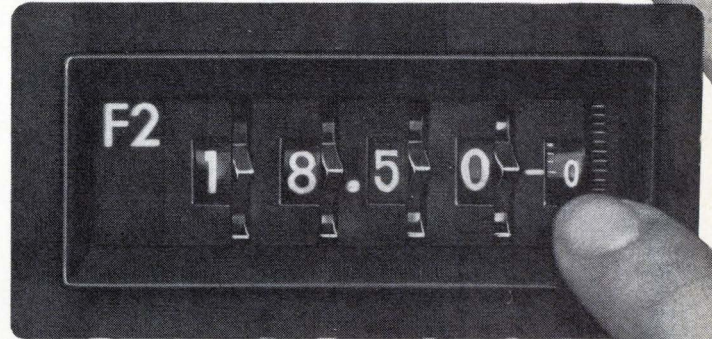
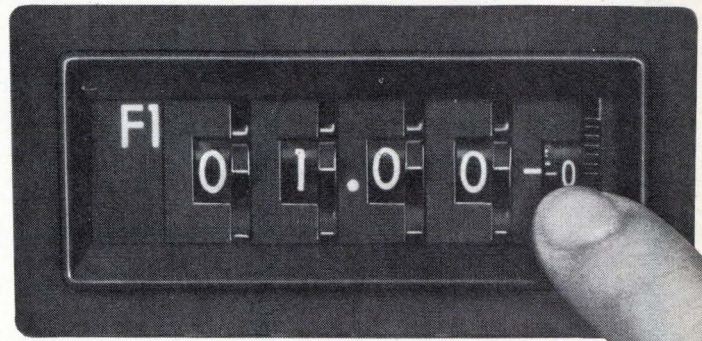

## Replace 6 Klystron Signal Generators with one Model 9535 — from 1 to 18.5 GHz.

Narda's newest generator/sweeper, Model 9535, is easy and quick to use —

- 0.5% accurate frequency digi-wheels — calibrated output power
- Provide 200 KHz resolution with excellent reset-ability
- Calibrated internal power meter
- Distance viewing provided—no mistaking frequency
- Push-button functions are illuminated for optimum visibility
- Calibrated controls with human engineering benefits

It eliminates the octave-band limit and the associated cost and accuracy of ordinary sweepers and signal generators. It is possible to test at all points in the 1.0-18.5 GHz. Because of its accuracy, it is used for military and aerospace applications. Its frequency range of interest spans a wide changing range.

Save man hours and warm-up time. Lower maintenance budgets, provide phase-lock capability.

Write for the full details. There are a lot more benefits to know about.

**NOW-**

- Guaranteed 5mW Minimum Power
- Faster Sweep Speed
- Flicker-Free Display

wherever microwaves go... **narda**

THE NARDA MICROWAVE CORPORATION • PLAINVIEW, L.I., NEW YORK 11803  
516-433-9000 • TWX: 510-221-1867 • CABLE: NARDACORP PLAINVIEW NEW YORK

235

Circle 153 on reader service card

PRECISION MADE

# PINS

MANUFACTURERS OF JACKS,  
PINS AND TERMINALS.

HUNDREDS OF  
CONFIGURATIONS IN STOCK



**SEND FOR  
CATALOG!**

## CONCORD

**ELECTRONICS  
CORPORATION**

37 GREAT JONES STREET  
NEW YORK, N. Y. 10012

(212) 777-6571 · TWX 710-581-4930

## New products

second delay prevents turnoff due to momentary voltage surges.

Logitek Inc., 42 Central Ave., Farmingdale, N.Y. 11735 [356]

Module protects against transients and overvoltages

An overvoltage/transient protector features a high-speed transient suppressor for continued operation of loads during short-term low-energy transients, plus an overvoltage protector for long-term high-energy overvoltages. This dual feature helps eliminate both tripping and the unexplained circuit failures associated with slower protection



methods. The suppressor works by clamping and absorbing the energy of the transients. If the transient persists, the overvoltage protector shunts the line to a safe level within 500 nanoseconds. Price starts under \$4 in quantity.

Transtector Systems, 532 Monterey Pass Rd., Monterey Park, Calif. 91754 [357]

Quality-control monitor includes digital display

The new series 5 digital monitor/control instrument packages are available for discrete-part inspection or quality-control applications. These instruments use the model SCA-5 strain-gage signal-conditioner amplifier power supply and the model TPST-5 logic function card with additional set-up adjustments per application. The logic function card performs a programmed inspection sequence through "hi," "lo," or accept level comparisons

# Leader in Capacitor Dielectrics since 1948!



All Films — All Gages

- Polyester
- Polypropylene
- Polysulfone
- Polycarbonate

Metalized — All Modes

- Duomet™ (both sides)
- Heavy Edge
- Heavy Metal
- Series Pattern
- Single Side

Write or phone for Free Samples and Literature



**ATLAN-TOL INDUSTRIES, INC.**

Am-Met Division  
29 Knight Street  
Norwalk, Conn. 06852, U.S.A.  
(203) 853-9494

# Only one of these synchronous motors

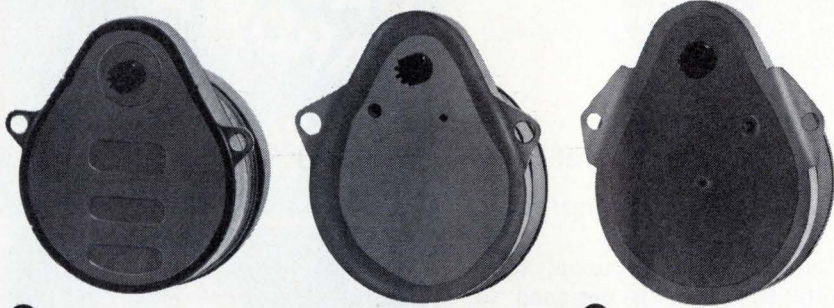

## is a genuine Synchron<sup>®</sup> Motor.

Synchron motors are made in five major styles. Speeds from 900 rpms to one revolution per week. Torque from 8 through 98 oz-in at one rpm. Hundreds of output options.



### Look alike aren't perform-alikes.

Not by a mile. And once a motor is installed in your product, who cares what it looks like? As long as it does its job, is trouble-free and lasts a specified time.

But how do you know which of the three will perform the best? Do you gamble and just pick one, assuming they're all about the same? Hardly. You specify the one that's made by a company that's just as interested in how well the motor performs as you are . . . who will stand by it 100% . . . who will deliver it when you need it . . . at a fair price.

But most of all, from a company dedicated to helping you solve your problems with the best product made. The motor on the left is the one we're talking about. It's the genuine Synchron.

**Call or write for complete Synchron motor specifications and the name of your Hansen representative.**

**MALLORY**



HANSEN MANUFACTURING CO.  
a division of P. R. MALLORY & CO. INC.  
Princeton, Indiana 47670

We make every Synchron motor as if *our* name were on *your* product.

# MINIATURE CERAMIC Trimmer Capacitors

FOR PRINTED  
CIRCUIT BOARDS



These new miniature trimmer capacitors are a snap fit on printed wiring boards, and are low cost for industrial and commercial applications!

Their compact form factor conserves mounting space, and they are available in a variety of mounting configurations.

Straight line capacitance curve for easy circuit trimming.

Available in capacitance ranges from 2.0 - 6.0 pF to 6.0 - 70.0 pF in 31 standard ratings with temperature coefficient of capacitance ranging from NPO to -1400 ppm/°C.

Engineering Bulletin 301 gives complete information, including a cross reference table. Write for it today!

**SPRAGUE  
GOODMAN**

**Sprague-Goodman  
Electronics, Inc.**

(An Affiliate of the Sprague Electric Company)

371 Willis Ave., Mineola, N.Y. 11501  
516/746-1385

## New products

with output logic and an auto-reset for unattended operation. Production information in logic form is available for computer interface. The digital display holds the last inspection value until a new cycle is initiated. Price is \$1,400.

Sensotec Inc., 1400 Holly Ave., Columbus, Ohio, 43212 [358]

Controller sets temperature to within  $\pm 0.001^\circ$  centigrade

The model 72 proportional temperature controller is designed to maintain temperature as closely as  $\pm 0.001^\circ\text{C}$  over a range of  $0^\circ$  to  $120^\circ\text{C}$ . Three dials are provided to set the control point. As temperature drops below this point, a triac continuously varies power applied to a heat source from 0 to full load, according to need. The heaters receive only the amount of power required to maintain exact temperature. Price is \$390.

Yellow Springs Instrument Co., Box 279, Yellow Springs, Ohio 45387 [359]

Temperature controller handles up to 200 watts

A 1,200-watt dc time-proportioning temperature controller is designated the model 4C4-200. This on-off unit, which has a factory-set bandwidth

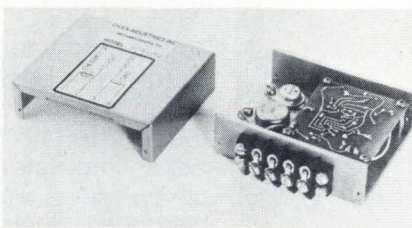

of approximately  $0.25^\circ\text{C}$ , also has a set-point stability of  $+0.025^\circ\text{C}/^\circ\text{C}$  for ambient changes from  $-20^\circ$  to  $+70^\circ\text{C}$  and  $+0.01^\circ\text{C}/\text{volt}$  for an input voltage change from 24 v dc to 30 v dc. TP series sensor probes are used for control over temperature ranges from  $-20^\circ$  to  $+250^\circ\text{C}$ .

Oven Industries Inc., Box 229, Mechanicsburg, Pa. 17055 [360]

**FROM  
BREADBOARD  
TO FINAL  
PACKAGING  
HARDWARE...**

**ALL AVAILABLE  
FROM ONE SOURCE**

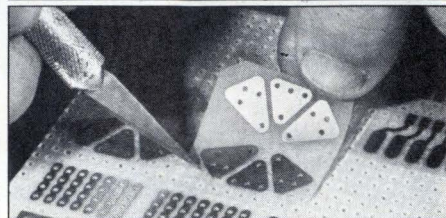

★ **ADHESIVE BACKED  
CIRCUIT SUB-ELEMENTS**  
(Over 200 Pre-Drilled component mounting patterns available "off-the-shelf.")

★ **EPOXY GLASS BOARD  
MATERIALS**

- 76 Standard "Off-the-Shelf" Boards.
- Including Unclad, Copper Clad, Cut & Peel Copper Clad, Pre-etched "X-Y" Pattern and Plated thru Hole Copper Clad.
- .100" Grid Hole Pattern or Undrilled.

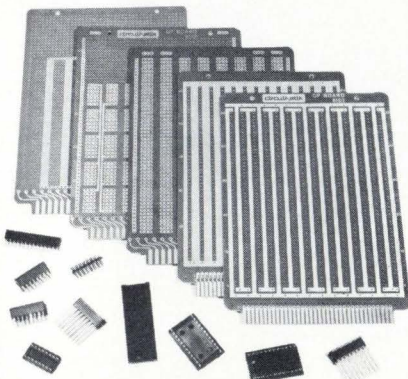

★ **GP CIRCUIT BOARDS and ACCESSORIES**

- Highest Quality — Choose from 74 "Off-the-Shelf" Boards.
- Sockets — Low & Standard Profile, P.C. and Wire Wrap. • Highest Quality Gold Contacts.
- Adapter plugs • Connectors
- Card Pull Handles.

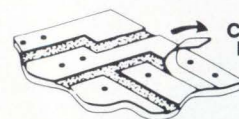

**CIRCUIT-STIK'S  
NEW CUT &  
PEEL BOARDS**

SEND FOR OUR NEW CATALOGS #502 & #801

**circuit-stik**®

P.O. BOX 3396 • Torrance, California 90510  
Phone (213) 530-5530

# BOURNS® SPACE SAVER CERMET CONTROLS



ARE—

**INTERCHANGEABLE WITH CTS 550 and 600** — Series 3852 is an exact CTS 550 replacement with less space required; Series 3859, ordered with a plastic bushing, also is interchangeable and costs even less. Series 3862 is interchangeable with the CTS 600 and is a better 1/2 inch diameter control.

**THIN** — Cut the bulk out of your new design... try the controls with the thinnest back-panel profiles in the industry — 1/4".

**QUIET** — CRV is conservatively specified at 3% of total resistance. Actually it's substantially less on most units.

**CERMET** — This provides the designer with BETTER STABILITY, HIGHER POWER-RATING, AND A  $\pm 150$  ppm/°C TEMPCO.

## COMPETITIVELY PRICED

SERIES	100 piece quantity*	2000 piece quantity*
3852	\$1.56	\$ .81
3859	1.27	.66
3862	2.20	1.18

**AVAILABLE** — All three Series, including their various shaft, bushing, and shaft-end styles, are stocked in-depth at each of 73 Bourns distributor locations. Delivery on standards is 24 hours.

## LOOK AT THE SIGNIFICANT SPECS —

	MODEL 3852/3859	MODEL 3862
Power Rating	2 watts at 70°C	1 watt at 125°C
Temperature Coefficient	$\pm 150$ ppm/°C	$\pm 150$ ppm/°C
Diameter	3/4"	1/2"
Depth Behind Panel	1/4"	1/2"
Resistance Range	50 $\Omega$ to 5 megohms	100 $\Omega$ to 5 megohms
Resistance Tolerance	$\pm 10\%$	$\pm 10\%$
Bushing	metal and plastic, locking and non-locking, plus snap-in	metal; locking and non-locking

\* Prices are U.S. Dollars, F.O.B., U.S.A.

**FOR A COPY OF OUR COMPREHENSIVE 22-PAGE BROCHURE, OR TO ENTER YOUR ORDER, CONTACT YOUR LOCAL BOURNS SALES OFFICE, DISTRIBUTOR, OR THE FACTORY-DIRECT.**



TRIMPOT PRODUCTS DIVISION • 1200 COLUMBIA AVE., RIVERSIDE, CALIF. 92507

# We're doing everything we can to keep on top of your needs.

Shortages. Crises. Delays. At times like these they're a fact of life.

At Brand-Rex we're doing something about them. We've instituted a company-wide program to foster a "Yes We Can" attitude to supply problems. And we've taken dozens of steps to make our problems less burdensome to our wire and cable customers.

Here's a sampling of what we're up to:

**Production.** We're minimizing waste and scrap by grouping orders using the same materials. We're modifying existing equipment to make it operate more efficiently. And we're keeping tabs on critical customer needs, giving them preference as far as possible.

**Purchasing.** To get maximum utilization from available resin and plasticizer, we've eliminated special purpose and low usage PVC compounds. We've raised our sights to include the world — we're searching out new supply sources overseas. At the same time, we're working with our long-term vendors to coordinate their production schedules with ours.

**Product Engineering.** Our engineers have come up with acceptable substitutes for hard-to-get PVC compounds — without compromising performance or service life. They're constantly evaluating new available insulations and developing new manufacturing techniques for those showing promise.

**Shipping.** We're using new packaging methods that virtually eliminate damage in transit. And where possible, we're consolidating shipments for better delivery service.

**Sales and Marketing.** We've given our salesmen an additional responsibility: calling on our vendors in



their territories to keep materials moving. We're using computers to keep track of customers' behind-schedule orders and giving them the extra attention needed to get them out on time.

**What you can do.** We're asking our customers to call us before new wire and cable specifications are finalized so that "tight" materials can be avoided or alternates provided for. And doing everything else that will help us help you.

We're not deluding ourselves. None of these steps is going to bring an end to the problems we all face. But they can make a difference — if we all work at it. After years of providing the best possible wire and cable service, we're not about to quit now.

## Brand-Rex

Willimantic, Conn. 06226

**Yes  
we can.**

## New products

Subassemblies

### D-a converter uses C-MOS

12-bit unit for military, industrial jobs also has low-power op amp

Increasing use of low power C-MOS circuitry in industrial equipment has led to the need for compatible ancillary equipment. Beckman Instruments is providing one example in a standard hybrid 12-bit digital-to-

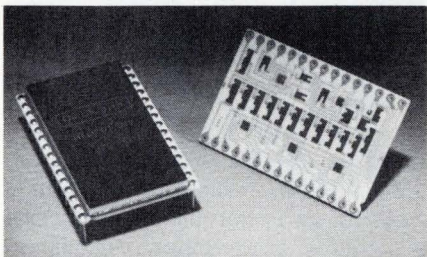

analog converter using C-MOS digital circuitry and a low-power operational amplifier. The series 872 is designed for demanding industrial and military applications, says Lyle F. Pittroff, product manager for standard microcircuits at Beckman's Helipot division. The d-a converters are specified for linearity as good as  $\pm 4.88$  millivolts over  $-55$  to  $+125^\circ\text{C}$ , the military temperature range, with  $\frac{1}{2}$ -bit resolution.

The 1- by  $1\frac{1}{2}$ -inch parts include the 4000 series C-MOS switches (also compatible with 74C C-MOS), precision R-2R cermet thick-film ladder networks, micropower 4250 output buffer amplifier, and internal precision voltage reference. The ceramic package is sealed with a polymer that Pittroff says meets military specifications. The part is a 28-pin, dual in-line package with 0.9-inch pin-row spacing, three times that of common IC packages, for convenience in laying out circuit boards.

Power drain of the circuit is 4.5 milliwatts for the converter and 40 mW for the reference source. The  $+10$ -volt reference is normally con-

nected externally to the converter's reference input, but can be used separately or disconnected. For applications requiring minimum power drain and numerous converters, the reference can be supplied from a common source. Voltage required is  $\pm 15$  volts at 130 microamperes for the converter and  $+15$  volts at 2.5 mA for the reference.

The converter can be used in either unipolar or bipolar operation. For unipolar, the output is 0 to  $+10$  volts in response to a 12-bit binary input word. For bipolar use, the offset resistor (available at a pin) is connected to the reference output instead of to the converter output. In this configuration, an input of all 0s will provide an output of  $-10\text{V}$ , and an all-1 input will provide an output of  $+10$  volts minus one least-significant bit, or approximately 9.9976 v.

The 872, which is not intended for high-speed applications, has a typical settling time of 35 microseconds, but Pittroff feels this is adequate for many uses where the low power consumption is needed.

Offset voltage is reset to zero internally, but can be further adjusted externally with a 100,000-ohm trimmer potentiometer giving an offset range of 200 millivolts. Likewise, quiescent output amplifier gain is preset, but can be reduced below 130 microamperes with an external resistor. However, this will affect slew rate and current capability (normally  $\pm 1$  mA).

The 872-D1, with  $\pm 2.44$  mV nonlinearity at  $25^\circ$ , is priced at \$88 in single quantity, dropping to \$66 for more than 200. The lower-accuracy 872-D2 (4.88 mV) is priced at \$66 in single quantity.

Beckman Instruments, Helipot Division, 2250 Harbor Blvd., Fullerton, Calif., [381]

### Power supplies intended for minicomputers, terminals

A line of 30-watt series-regulated dc power supplies is available off the shelf for OEM use in minicomputers, point-of-sale terminal systems, office equipment, and other IC-type

## Pro-Log brings intelligence to ROM Programmers



Intelligent because it's controlled by a Pro-Log microcomputer. It cuts programming time substantially, makes operation easy, and is able to interface as a conversational terminal with people, TTY, and other computers. All of this for around \$2000.

The Series 81 ROM Programmers from Pro-Log are fully portable units designed for use in engineering, quality assurance, production, or out in the field.

**Model 810: Programs 1702A ROMs**

**Model 811: Programs 1702 ROMs**

**Model 812: Programs National 5203 ROMs**

**Model 813: Programs 3601 Fusible Link ROMs**

#### Features:

- Programs, Lists, Duplicates, and Verifies
- Automatic erase check
- Duplicates with advance substitution
- Duplicates typical 1702A in less than 30 seconds — 1702 or 5203 in less than 5 minutes
- Hexadecimal keyboard for address and data entry
- Binary data display
- Quick load, zero insertion force ROM sockets

## ROM Programming Systems from Pro-Log



"Microcomputers, Programmers and Education"  
852 Airport Blvd. Monterey, Calif. 93940  
(408) 372-4593

## Another fine OEM product from C. Itoh.

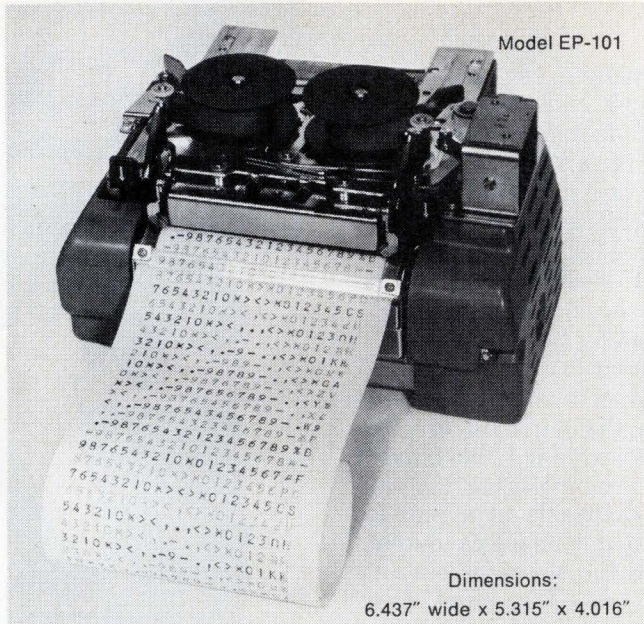

## Printing Mechanism for digital devices.

The EP-101 model simplifies the parallel entry printing mechanism by using a much smaller number of component parts. The result is a top-quality printing mechanism with a high degree of reliability and durability. As small as it is, the EP-101 still produces a fast 21-column print-out at a speed of three lines per second.

Other features include low electrical power consumption (150 mA at 15V-DC) and a long-life transistorized motor.

It is designed for the widest possible applications—everything from cash registers and measuring devices to computers—and provides you with a hard copy.

There are other models available for many specific applications, each ready for immediate delivery at a most attractive C. Itoh price.

Send in the coupon for more information.

### C. Itoh Electronics Inc.

5301 Beethoven St., Los Angeles, Calif. 90066. (213) 390-7778

East Coast Office: 270 Park Avenue, New York, N.Y. 10017.  
(212) 953-5452/5447

New Jersey office: (201) 347-7997 Ohio office: (513) 492-1159

### C. Itoh Electronics Inc.

270 Park Avenue, New York, N.Y. 10017

Please send me more information on your Alpha-Numeric Printing Mechanism.

Name \_\_\_\_\_ Title \_\_\_\_\_

Company \_\_\_\_\_ Telephone No. \_\_\_\_\_

Street \_\_\_\_\_

City \_\_\_\_\_ State \_\_\_\_\_ Zip \_\_\_\_\_

Specific Application \_\_\_\_\_

EM6-EP

## New products

logic systems. The line consists of four models in the most widely used ratings: 5 volts at 3 amperes, 12 V at 1.8 A, 15 V at 1.6 A, and 24 V at 1.2 A. Input voltage for all models ranges from 108 to 132 V, or 216 to 264 V, with output regulation main-

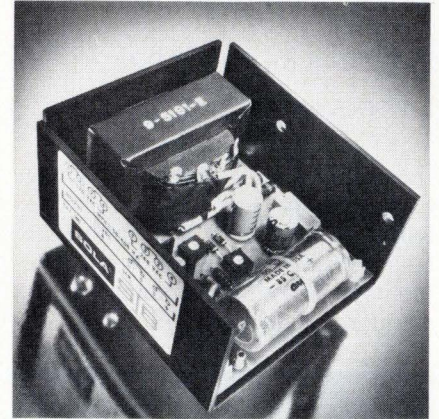

tained at  $\pm 1\%$ . Input frequency range is 50–400 hertz, with load derated to 75% for 400-Hz operation. Automatic short-circuit protection is built in, and overvoltage protection is available as an option. Price is approximately \$30.

Sola Electric Co., 1717 Busse Rd., Elk Grove Village, Ill. 60007 [401]

Data-acquisition system has  
16 channels, uses 100 mW

A gated power supply, by turning on only when a conversion is requested, permits a 16-channel data acquisition system to operate with only 100 milliwatts of power. In the standby state, less than 120 microwatts is required. The system, called the DAS-16-LP, includes a 16-channel analog multiplexer, a sample-and-hold module, an 8- or 12-bit analog-to-digital converter, and the control logic for random and sequential channel-selection. The 16 single-ended analog input channels can accept either +5 or  $\pm 5$ -volt swings while presenting  $10^9$  ohms of input impedance. Data conversion time is 450 microseconds, so maximum system throughput rate is 2.2 kilohertz. Since the DAS-16-LP can be operated from a 12-volt battery, drawing only 8 milliamperes while



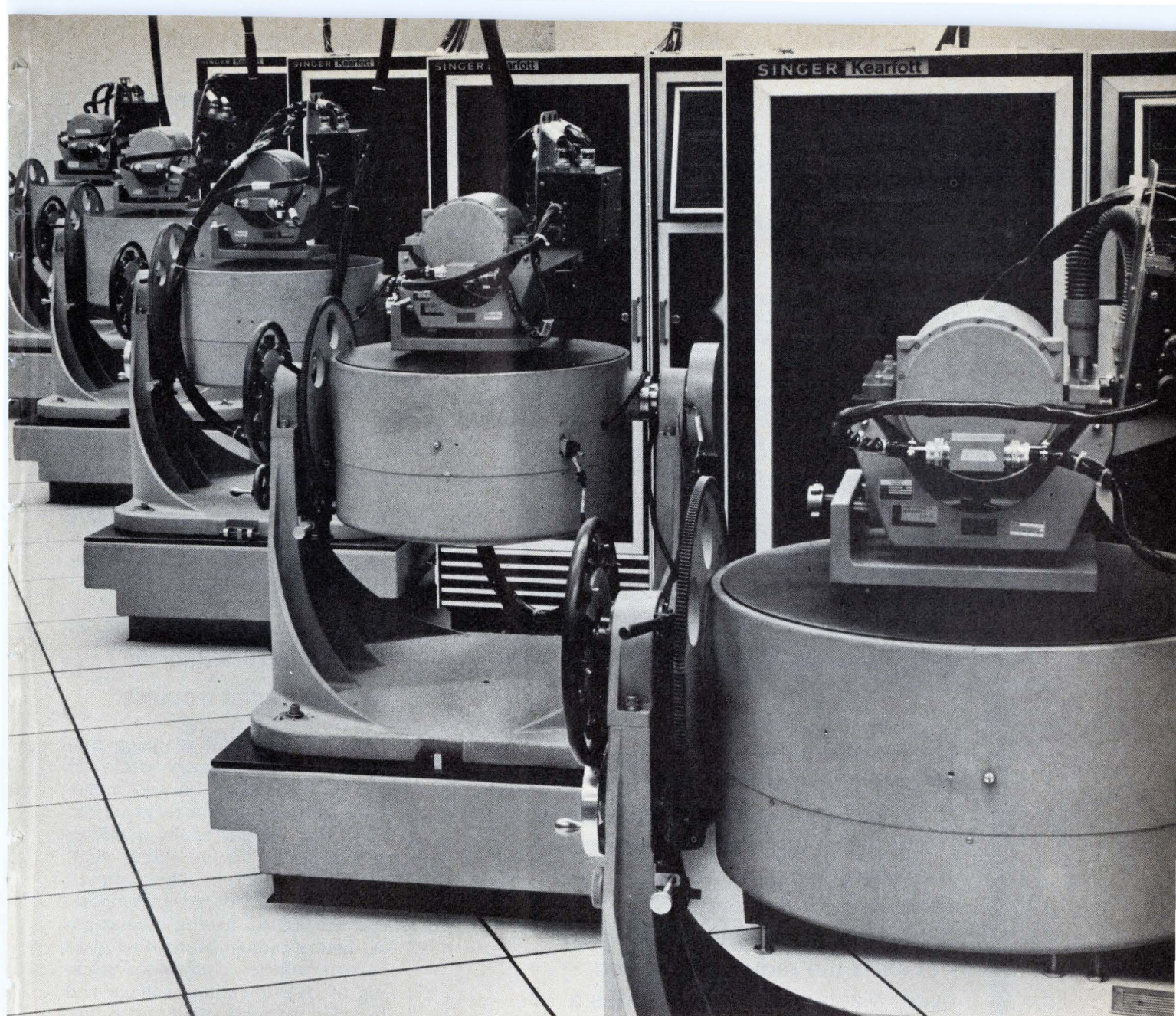

## These Missile Guidance Systems have 3,745 excellent references.

Singer's Kearfott Division has produced over 3,746 Missile Guidance Systems for use in TALOS, BOMARC, MMRBM, SUBROC and SRAM Missiles and Cannon Launched Guided Projectiles.

We've also furnished gyro reference units for Atlas, Nimbus, Mariner, Lunar Orbiter, Surveyor, Orbiting Astronomical Observatory, Lunar Landing Module, Apollo Telescope Mount and the Viking Program.

And recently our inertial mea-

surement units were selected by Rockwell for NASA's Space Shuttle Orbiter and by Martin for the Army's Pershing II guidance. There are even some very advanced new applications we can't talk about.

A record like that can only be based on consistent performance—equipment performance that assures mission success, and management performance that assures on-target delivery and on-target cost.

Behind it all lies our out-front

technologies and the talented people who have made our Missile Guidance capability possible. A capability we can bring to bear on your project too. Just check our references. The Singer Company, Kearfott Division, 1150 McBride Avenue, Little Falls, N.J. 07424.

**SINGER**  
AEROSPACE & MARINE SYSTEMS

Circle 161 on reader service card

**Flameless Compressed-Air Heat Torches** — Lightweight and portable for pinpoint intense heat performance.

**Heat Blowers** — Built for continuous 24-hour duty.

**Master-Mite™ Gun** — Lightweight versatility with three interchangeable nozzles and heat ranges. U.L. listed

**Standard Heat Gun** — Compact and economical, die-cast aluminum housing.

**Chrome Heat Gun** — Designed for labs, R & D, and professional use.

250° to 1,000° F.  
U.L. listed

## We're full of hot air.

Master offers the world's most complete line of flameless heat tools. Heat tools for **all** applications — shrinking tubing, desoldering, forming plastics, bonding, deburring, drying, setting adhesives, or anything else where hot air is the requirement. And every Master heat tool features a complete line of attachments for **every** production need. It's true. We really are full of hot air.

Heat Guns and Blowers are available in U.L. and L.A. listed models. CSA listed in Canada. In Canada, contact Martin Industrial Sales, P.O. Box 576, 4445 Harvest Road, Burlington, Ontario.

Send for your free full line catalog page and price sheet on the world's most complete line of flameless heat tools.

**MASTER** appliance corporation  
RACINE, WISCONSIN 53403

CJ-4

## New products

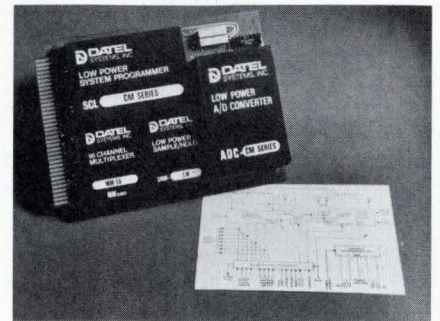

converting and a mere 10  $\mu$ A in standby, it can be used in remote areas where line power is unavailable, as well as in the laboratory. Price is \$750. Delivery time is stock to four weeks.

Datel Systems Inc., 1020 Turnpike St., Canton, Mass. 02021 [403]

14-bit d-a converters  
housed in small modules

Three 14-bit digital-to-analog converters provide linearity within  $\pm 1/2$  the least significant bit and monotonic operation over a range of 0 to 50°C. One, designated the AD355, is a high-speed current-output unit; the other two have voltage outputs, with the ZD365 coded for unipolar and the ZD375 having bipolar-offset binary coding. Monolithic quad current switches assure good tracking of base-to-emitter voltage and beta for the most significant 8 bits, and bit weights are determined by a thick-film resistor network. In addition to providing high differential linearity, the combination of current switches and the thick-film network permits the converters to be packaged in modules that measure only 1.76 by 1.96 by 0.4 inches. In quantities of one to nine, price of the ZD355 is \$299; of the ZD365, \$310;

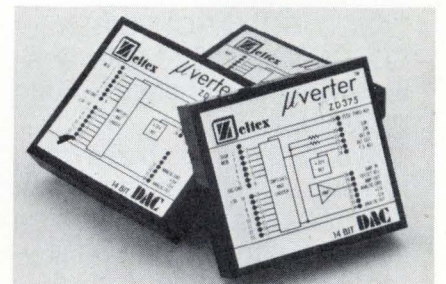

# "Packaging for FOX 2 process computer systems had to be fast, flexible, reliable and low in overall cost.

## "Only one company met all our requirements. Augat."

John Hatch, Packaging Engineer,  
The Foxboro Company

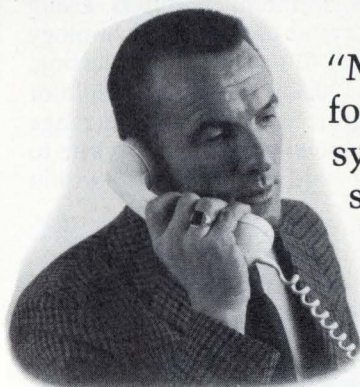

John Hatch

"My responsibility for the new FOX 2 systems was to help select the packaging and connection system providing top reliability plus the fastest possible development time.

On top of that, we wanted maximum density for the system.

"We chose the Augat Company for a variety of reasons. They were willing to work with us in developing new plug-in panels to meet our special requirements. Also, Augat offered the broadest range of I.C. interconnection products (from panels to frames to tools). This combination enabled us to design our packaging to meet our density needs. In fact, with Augat we succeeded in saving almost 90% in space. And access to both front and back planes was easier.

"I was most impressed with Augat's reliability and quality. Because Augat precision-machines the sockets used in their panels, we found our components and D.I.P.'s were easier to insert,

had greater positive contact retention and better corrosion resistance.

"True, Augat panels were probably a little more expensive initially. But from an overall systems standpoint, Augat's superior quality more than offset this small difference. We're sold on the Augat packaging system."

More and more companies like Foxboro are discovering that the name Augat is synonymous with quality, reliability, and service. With good reason. Augat pioneered the wire-wrapped socket panel concept. So Augat has more experience than anyone else in the business.

We'd like to show you how we can provide your company with a better interconnection system at a lower overall cost. Call or write us today. We'll send a free catalogue and complete product information. Augat, Inc., 33 Perry Ave., Attleboro, Mass. 02703. Phone (617) 222-2202

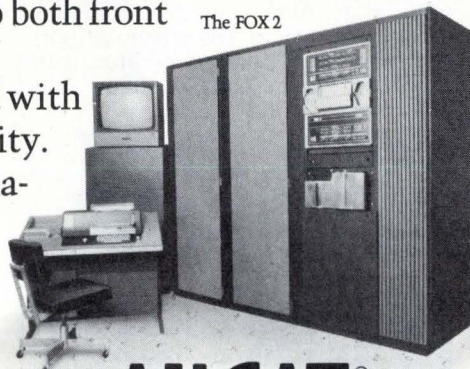
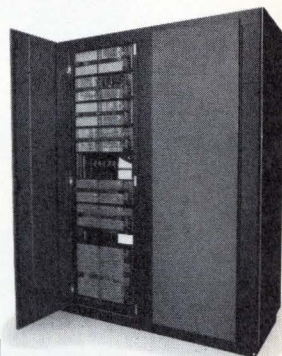

# AUGAT®

Europe - Augat International, Inc., Boulevard A. Reyers, 103, 1040 Brussels, Belgium, Tel. (02) 36-93-99.  
Japan - Kyokuto Boeki Kaisha Ltd., New Otemachi Bldg., 2-1, 2-Chome Otemachi, Chiyoda-Ku, Tokyo 100-91, Japan, Tel. (03) 244-3788.

Circle 163 on reader service card

# automatic helpers

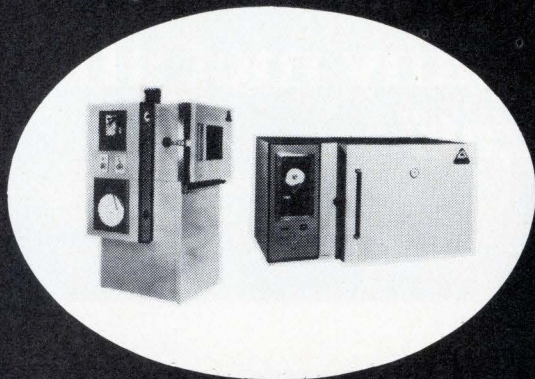

Want flexibility at low cost? All Associated chambers are economical to operate and are fully automatic with the addition of one of our various programmers. They become your second shift helping hands.

For information on the broadest line of environmental simulation equipment available contact:



**Associated Environmental Systems**  
Division of Craig Systems Corp.  
360 Merrimack Street  
Lawrence, Mass. 01842  
617-683-9501

Circle 108 on reader service card

# \$500\*

## BALANCED

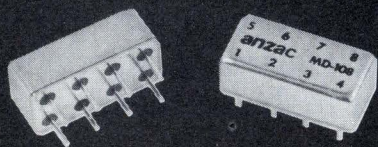

## MIXER

MODEL MD-108

- DC - 500 MHz
- 7dB Conversion Loss
- 30dB Isolation
- 8 - Pin Relay Header

\* 500 piece qty. 1-49 pieces (\$7.00)  
50-499 pieces (\$6.00).

**anzac**  
ELECTRONICS



39 Green Street, Waltham, Mass.  
(617) 899-1900 • TWX 710-324-6484

# SWEEP

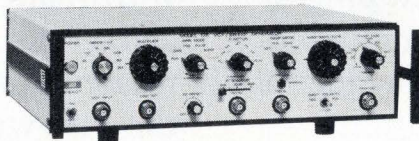

A 2-in-1 function generator, the Model 126 produces sine, square, triangle, ramp, pulse and sync waveforms over a 0.1 Hz-to-3 MHz frequency range, plus has a separate ramp generator to sweep the main generator over a 1000:1 (three decade) range. Also has gate and trigger modes, VCF input, DC offset, V:f output. And it's a pulse generator, with individual width and repetition rate controls, all for just . . .

# \$495

f.o.b. Hillsboro, Oregon



**EXACT**  
electronics, inc.

(A Subsidiary of Danalab, Inc.)

BOX 160, HILLSBORO, OREGON 97123  
(503) 648-6661 TWX 910-460-8811

Circle 109 on reader service card

## New products

and of the ZD375, \$320. Delivery time is six weeks.

Zeltex Inc., 940 Detroit Ave., Concord, Calif. 94518 [404]

## Hybrid clock oscillator spans 250 kHz to 20 MHz

An oscillator, model K-1100A, is suitable for commercial applications, including microprocessors, modems, and minicomputers. Using quartz-crystal-oscillator technology and thick-film hybrid processing, the K-1100A is a rugged oscillator with high reliability. Its wide range of frequencies goes from 250 kHz to 20 MHz and is stable to within

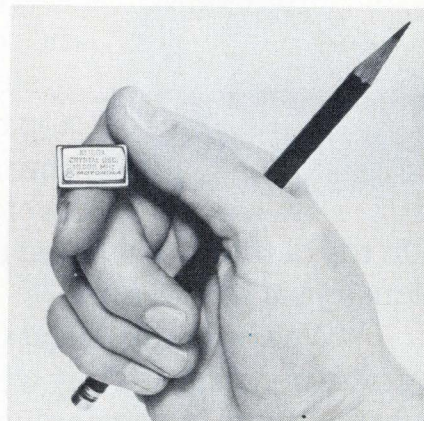

$\pm 0.01\%$  over the 0-70°C range. The oscillator occupies only 0.083 cubic inch and is 0.200 in. high, permitting high-density packaging on standard logic boards with normal board spacing.

Motorola Inc., Component Products Division, 2553 N. Edgington St., Franklin Park, Ill. 60131 [387]

## Industrial servo units snap into circuits

Customized servo electronics for applications such as process control and vehicle speed control are provided by modules that snap into a circuit and thus eliminate the need for inter-module cables and connectors. As control requirements expand, more modules can be added to the system. Three power modules are offered, plus one servoamplifier

# The most efficient combination for 200-watt TV translators

## CAVITIES

TH 18122 175.225 MHz

TH 18152 470.860 MHz

+

## TRIODE TH 338

THOMSON-CSF offers a complete range of tubes and cavities from 20W up to 2 kW for TV equipment with common amplification of video and sound signals.

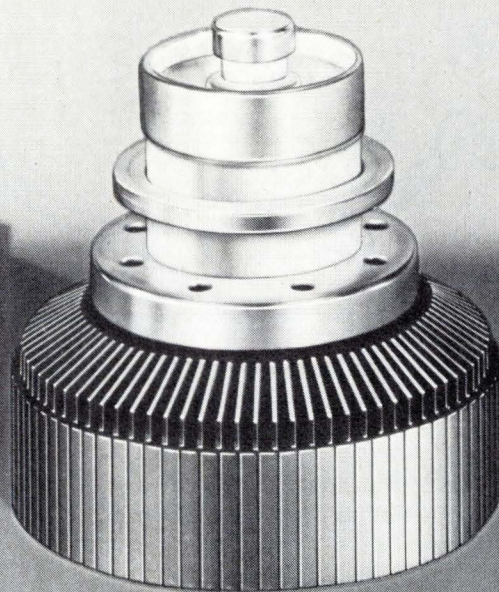

**THOMSON-CSF**

THOMSON-CSF ELECTRON TUBES, INC. / 50 ROCKEFELLER PLAZA / NEW YORK, N.Y. 10020 / TEL. (212) 489.0400

France - THOMSON-CSF Groupement Tubes Electroniques / 8, rue Chasseloup-Laubat / 75737 PARIS CEDEX 15 / Tél. 566 70.04

Germany - THOMSON-CSF Elektronenröhren GmbH / Am Leonhardsbrunn 10 / 6 FRANKFURT/MAIN / Tél. 70 20.99

Italy - THOMSON-CSF Tubi Elettronici SRL / Viale degli Ammiragli 71 / ROMA / Tél. 638 14.58

Japan - THOMSON-CSF Japan K.K. / Kyosho Building / 1-9-3 Hirakawa-cho / Chiyoda-ku / TOKYO / 〒 102 / Tel. (03) 264.6341

Sweden - THOMSON-CSF Elektronrör AB / Box 27080 / S 10251 STOCKHOLM 27 / Tél. (08) 22 58.15

United Kingdom - THOMSON-CSF Electronic Tubes Ltd / Bilton House, Uxbridge Road, Ealing / LONDON W 5 2TT / Tel. (01) 579 55.11 / Telex : 25 659

Circle 165 on reader service card

# You need a prototype mini motor from a very fast guy who can make 200,000 when your design's final. Now what do you do?

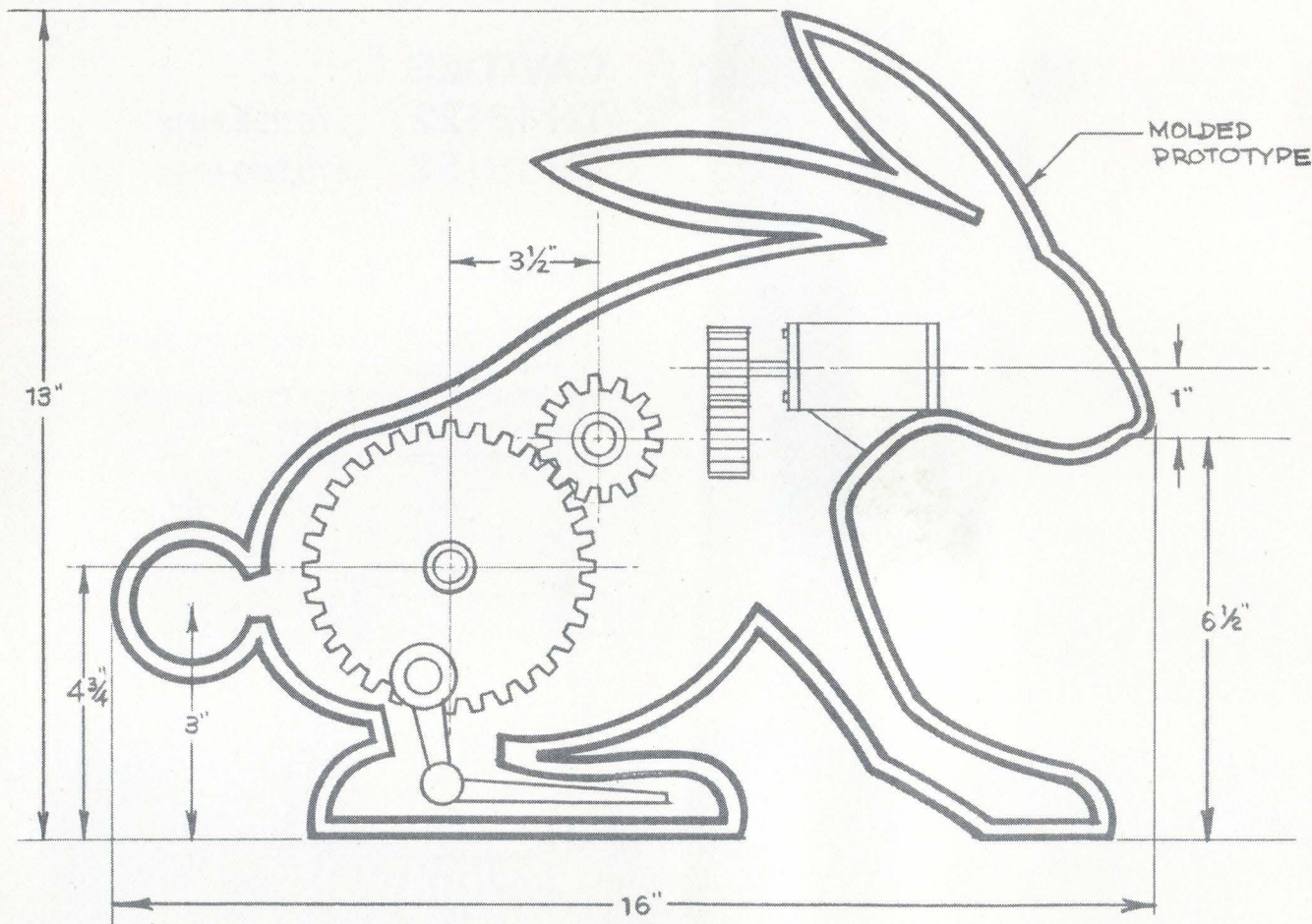

**Good time to call TRW/Globe.** Our Small Order department is hopped up to build and deliver prototype precision miniature motors quick like a rabbit.

Then, when you're ready to multiply that prototype into thousands, we have 191,000 square feet of plant and equipment to handle volume production.

Our new plant in Dothan, Alabama, is designed and

equipped specially for production runs of commercial and industrial precision miniature motors.

So whether you need one motor or a million, you'll find us the fastest thumpers in the briar patch.

For more information on this uncommon capability, **write for our free booklet: "The Multipliers."** TRW/Globe Motors, an Electronic Components Division of TRW Inc., Dayton, Ohio 45404 (513-228-3171)

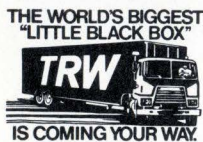

## TRW® GLOBE MOTORS

## New products

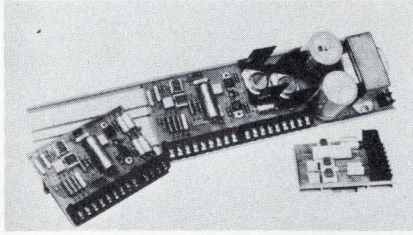

and various auxiliary-function modules. Appropriate electrical power conversion and voltage regulation are provided. The power supply in each servoamplifier has enough capacity to power several more servoamplifiers.

Moog Inc., Controls Division, East Aurora, N.Y. 14052 [385]

## Buffer amplifier drives large reactive loads

The A-403 unity-gain buffer amplifier has an output voltage of  $\pm 120$  V, output current of a minimum 100 mA, a minimum slew rate of 100 V/ $\mu$ s, and an input range of  $\pm 50$  to  $\pm 120$  V. The unit can drive a capacitive load, like a long coaxial cable, of up to 10,000 pF. In addition, an input impedance of greater than 10 kilohms permits the unit to be used with a wide variety of low-power operational amplifiers. The output is short-circuit-protected with fold-back current-limiting. The A-403 has a guaranteed operating temperature range of  $-25^{\circ}\text{C}$  to  $+85^{\circ}\text{C}$ . It is packaged in a 1.6-by-3-by-1-in. plug-in module, and its heat sink permits operation without special cooling. Price is \$50 in 1-9 quantities.

Intech Inc., 1220 Coleman Ave., Santa Clara, Calif. 95050 [388]

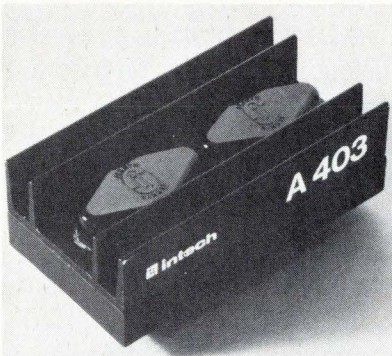

## Power Line Disturbance Monitor

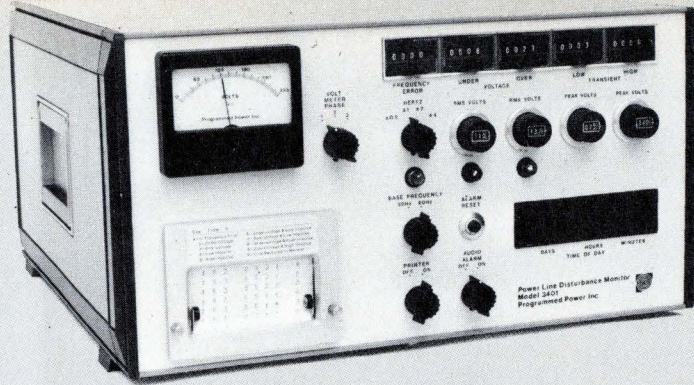

## You may not need U.P.S. Monitor and evaluate. Then decide.

Wide voltage range: 100-480 VAC  
Monitors single or three phase power  
Transient risetime response: 0.2  $\mu$ s  
Transient amplitudes  $\pm 50$  to 1000 volts  
50 Hz, switch-selectable  
Event registers:  
undervoltage and overvoltage  
under/overfrequency  
low-magnitude transients  
high-magnitude transients

Audio and visual alarms  
Time and event recorder  
Quartz crystal clock  
Solid state circuitry  
Portable and lightweight  
Easy to operate: no attendant necessary  
Virtually maintenance-free

**Programmed Power Inc.**  
141 Jefferson Drive  
Menlo Park, CA 94025  
(415) 323-8454

Subsidiary of Franklin Electric



Circle 167 on reader service card

## Bridge Rectifiers

**IBR<sup>®</sup>**

**SILICON CONTROLLED AVALANCHE INTEGRATED BRIDGE RECTIFIERS**

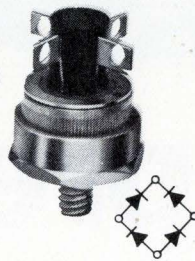

For designers who need

**Small size  
Maximum efficiency  
Greater versatility**

Look to the IBR if you have a design problem that requires an efficient 10 A or 25 A full-wave bridge with 100 V, 200 V, 400 V, 600 V or 800 V ( $V_{RRM}$ ) ratings, and 250 V, 450 V, 650 V and 850 V minimum avalanche voltages. Also in 15A or 36A three phase.

Low thermal resistance,  $\leq 1^{\circ}\text{C/W}$  ( $R_{\theta JC}$ ) for full rated load operation at  $100^{\circ}\text{C}$ ,  $T_c$ . IBR cases are hermetically sealed and electrically isolated.

When you design-in an IBR, the controlled avalanche characteristics permit you to use lower PRV safety factors, and if you need it, the IBR series offers you fast recovery versions (200 nanosec,  $t_r$ ). The IBR is available in press-fit, TO-3 outline mounting flange and stud mount.

Only **\$2<sup>50</sup>** ea (10 A, 200 V, TO-3 mounting 1000 qty.).



Design us in — We'll stay there

**VARO SEMICONDUCTOR, INC.**

P.O. BOX 676, 1000 N. SHILOH, GARLAND, TEX. 75040, 214/272-4551, TWX 910-860-5178

Distributed by:

**ALLIED ELECTRONICS**, Chicago, Ill. 312/421-2400. **THE ALTAIR CO.**, Houston, Tex. 731/781-5300; Richardson, Tex. 214/231-5166. **BELL INDUSTRIES**, Menlo Park, Cal. 415/323-9431; Skokie, Ill. 312/965-7500; Bellevue, Wash. 206/747-1515. **CRAMER ELECTRONICS**, Nationwide, Newton, Mass. 617/969-7700; **MILGRAY ELECTRONICS**, Freeport, N. Y. 516/546-6000; Hyattsville, Md. 301/864-1111; Cherry Hill, N. J. 609/424-1300. **WESTATES ELECTRONICS**, Chatsworth, Calif. 213/341-4411.

In Canada:

**ELECTRO SONIC**, Toronto, Ont. 416/924-9301. **R.A.E. ELECTRONICS**, Vancouver, B. C. 604/687-2621.

Free.

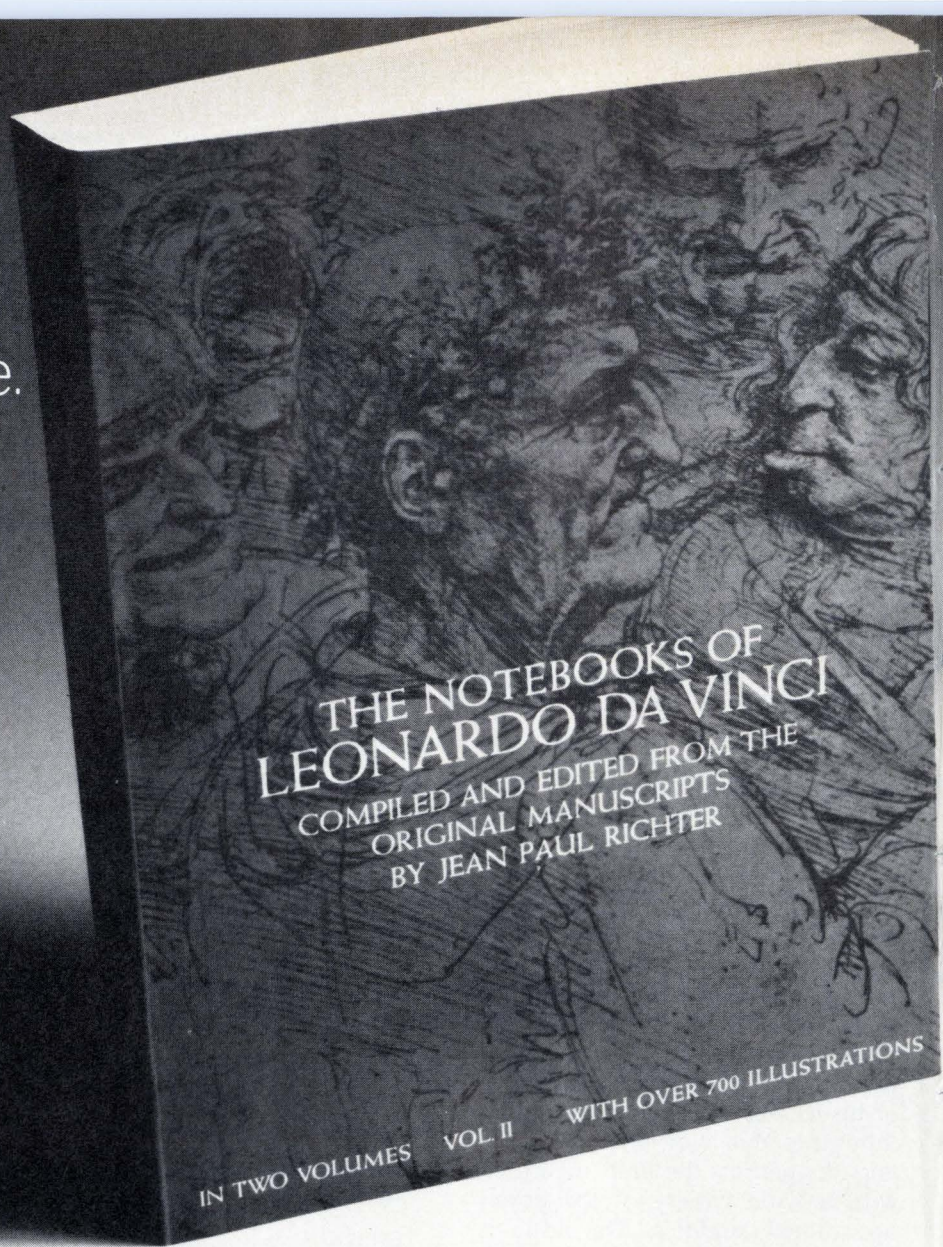

# Monroe presents 500 for 30 minutes of

Introducing the totally new 1920.

In order to introduce a scientific and engineering electronic calculator so new and different that it defies description, we've come up with a unique kind of offer. One of the most fascinating printed works of the century. A 500 page volume of the long lost notes of Leonardo da Vinci.

Long available only to serious scholars and meticulously penned in a mysterious mirror writing, this newly translated volume contains a wealth of information. Leonardo's voluminous notes on sculpture, architecture, astronomy, anatomy, physical geography, engineering, and mechanics showing him to be centuries ahead of his time. Sold in fine bookstores for five dollars. And it's yours absolutely free.

In return for this gift, we want to show you a new electronic computing device so unique that it must be tried to be believed.

A device that allows you to work in algebraic form. And that's only the beginning. With the 1920 you work with the simplest keyboard, so comfortable that it can become second-nature.

Simpler than any you've ever tried, but with all the power you'll ever need. Plus a display you can read even from across a room.

And in 30 minutes we can show you what we mean.

And for your time, with no further obligation, we will present you with a card you return to us. As soon as we receive it, we'll send your Leonardo Volume by return mail.





New.

# pages of DaVinci your time.

Monroe, The Calculator Company  
550 Central Avenue, Orange, New Jersey 07051

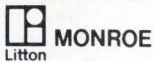

- Yes, I'd like to see the 1920. Please call for an appointment.
- Yes, I'm interested, but send further information on your offer by return mail.

Name \_\_\_\_\_

Title \_\_\_\_\_

Company \_\_\_\_\_

Address \_\_\_\_\_

Phone \_\_\_\_\_

City \_\_\_\_\_ State \_\_\_\_\_ Zip \_\_\_\_\_

Our supply of the Notebooks is limited. So to be sure to get yours early, act now.

To reserve your copy, and schedule a demonstration please return the coupon or call your local Monroe office. We're sure that both our product and the Leonardo Notebook will amaze you. And provide for time well spent.

**MONROE**  
**The Calculator Company.**

Circle 169 on reader service card

**TREAT THIS 300 NSEC,  
NMOS MEMORY  
LIKE A COMPONENT**

# **JUST PLUG IT IN**

You're looking at the new MICRORAM 3000N, a complete NMOS semiconductor memory on a single printed circuit card assembly. Just plug in a power supply ( $\pm 15\text{VDC}$ ,  $+5\text{VDC}$ ) and you have a fully functional memory system that cycles at 300 nsec, and accesses at 180. (A high speed version that cycles at 180 nsec. is available, too.)

The MICRORAM 3000N is available for delivery to meet your production schedules. It mounts on a printed circuit card 11.74" by 15.4", and is basically compatible with our MICROMEMORY 3000 core memories. The standard 16K by 20 configuration is alterable to 32K by 10. Numerous other capacities and word lengths are also available.

Like all members of the MICROMEMORY 3000 Family, the MICRORAM 3000N is available either as a single card memory or as a multi-card system in a chassis containing up to 16 memory cards, power supply, self-test and interface cards and various other options.

Get the full story on the MICRORAM 3000N from your local EMM office or call Commercial Memory Products Marketing Department at (213) 644-9881.

**EMM** ELECTRONIC  
MEMORIES  
**COMMERCIAL MEMORY PRODUCTS**

A Division of Electronic Memories & Magnetics Corporation  
12621 Chadron Ave., Hawthorne, Calif. 90250

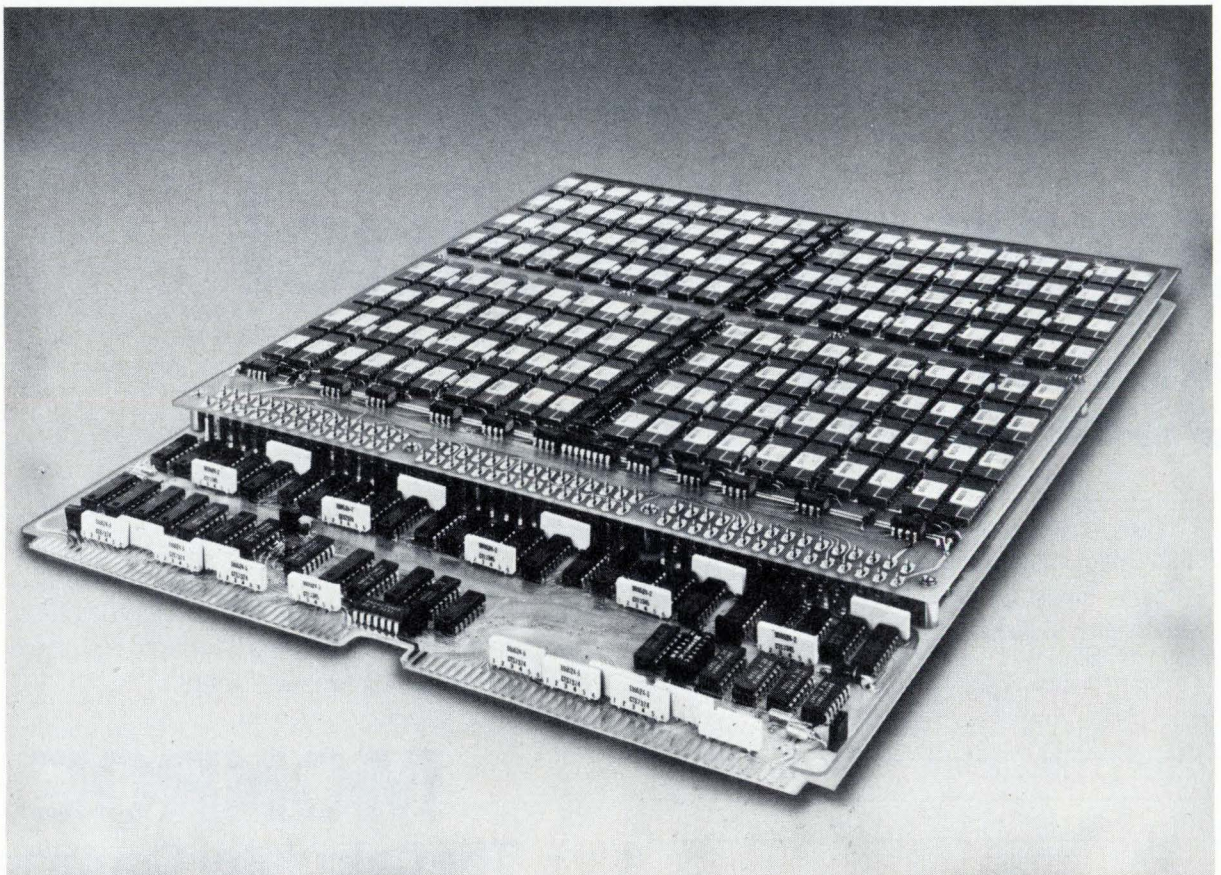

## New products

Communications

# Receiver can test propagation path

Unit covers 10 kHz–30 MHz, receives telephony, SSB, and narrow-band fm

Originally designed for military search, surveillance, and monitoring applications, a 10-kilohertz to 30-megahertz radio receiver has now been introduced by Rohde & Schwarz in a commercial version. One expected application is the testing of propagation-path characteristics between proposed transmitter and receiver sites. Since the input level is converted to a dc voltage and is available at a jack at the rear of the receiver, a strip recorder could be connected and propagation characteristics recorded.

The fully transistorized unit, priced at \$24,000, receives telephony, telegraphy, single-sideband, and narrow-band frequency-modulated transmissions. Frequencies are switch-selected in 1-MHz and 100-kHz steps, and a single knob tunes the receiver within the step intervals. A new method of frequency conversion allows the slopes on the frequency-response skirts of all 20 different bandwidths (from 150 hertz to 12 kHz) to be the same and to be independent of the received frequency. The receiver's dynamic range is greater than 80 decibels. Designated the model EK 56, the unit's resetting accuracy is within  $\pm 50$  Hz for 100-kHz tuning and  $\pm 500$  Hz for 1-MHz tuning. Stability is within 5 Hz/day.

The input first passes through a low-pass filter, which suppresses signals above 31MHz (and especially signals in the fm band between 80 and 110 MHz). An automatic-gain-control circuit, consisting of negative- and positive-temperature-coefficient thermistors, then passes the signal on to a push-pull rf amplifier which reduces second-order intermodulation distortion; the amplifier

drives a double-balanced mixer, which reduces both second- and third-order distortion. The mixer converts the signal to a 40.525-MHz intermediate frequency. A crystal filter rejects the second image frequency (39.475 MHz), and a second i-f at 525 kHz is derived in a second mixer. The signal then goes to the main selectivity section, where the bandwidth is determined.

A new double-mixing technique in the selectivity section is what keeps the slopes of the frequency-response skirts constant. The 525-kHz i-f is first translated to between 52 and 64 kHz by one of a pair of "complementary" oscillators, and then a low-pass filter with a steep cutoff sets one edge of the final bandpass response. The signal is next converted back up to 525 kHz, and the second "complementary" oscillator, which is on the opposite side of the i-f, "flops" the signal over in the 52–64-kHz range. A second low-pass filter provides the other cutoff skirt of the bandpass response. The bandwidth is varied by adjusting the frequency difference between the two complementary oscillators, while the bandpass-cutoff skirts are determined only by the low-pass filters.

The signal then is passed through further i-f amplifiers and an agc circuit before being applied to the audio section for output on a built-in loudspeaker or phone jack. A front-panel microvoltmeter with a linear scale is connected in the agc loop to display input voltage.

The receiver uses no mechanically tuned components in the radio-frequency section—front-panel tuning is done only on the 2.75–3.75-MHz master oscillator of the receiver/monitor.

Rohde & Schwarz, 111 Lexington Ave., Passaic, N.J. 07055 [362]

Tester checks data sent at 70 megabits/second

A bit-error rate analyzer, designated the model 3200, is a modular test set capable of analyzing data-communications systems operating up to 70

## There's an EMM office near you.

### WESTERN REGION

*Regional Office*

**SAN FRANCISCO**  
(408) 247-9711

**LOS ANGELES AREA**  
(213) 644-9881

**ORANGE COUNTY AREA**  
(714) 639-5811

**MINNEAPOLIS AREA**  
(612) 941-2404

**PHOENIX AREA**  
(602) 968-2492

**DALLAS AREA**  
(214) 231-7207

### EASTERN REGION

*Regional Office*

**BOSTON**  
(617) 861-9650

**CHICAGO AREA**  
(312) 297-7090

**WASHINGTON, D.C. AREA**  
(703) 941-2100

**NEW YORK AREA**  
(516) 423-5800

**CLEVELAND AREA**  
(216) 842-8920

### International OFFICES

*European Headquarters*

**BELGIUM**  
(03) 76.69.75

**UNITED KINGDOM**  
(01) 751-1213

**WEST GERMANY**  
(0811) 74.30.40

*Far East Headquarters*

**JAPAN**  
(03) 404-8520

**EMM** ELECTRONIC MEMORIES & MAGNETICS CORPORATION.

12621 Chadron Avenue  
Hawthorne, Calif. 90250  
(213) 644-9881

# IEE-TITAN

## PROJECTION READOUT DISPLAYS

- World's most extensively used message displays • Completely versatile — displays any image, color, message, type style reproducible on film
- Bright, easily legible, single plane, 160° wide angle viewing with variable brilliance
- Displays from 12 to 48 messages per module • Easily combined into multi-module, integral assemblies for added information capacity • 14 different models — character heights from 3/8" to 3 3/8"; Mil-Spec option • Ultra-reliable, non-mechanical, passive operation; easy unitized installation; long life, low power, subminiature incandescent lamps



For your every man/machine interface requirement, IEE has a solution. From "the Olympus of Displays," the world's most diversified selection of display products, technologies, and design expertise, IEE offers you your choice of:

- Multiple Message Displays — rear projection; status indicator/annunciators; mini-CRT's
- Dynamic Message Displays — 64 & 256 character dot matrix panels
- Numeric & A/N Displays — line filament; neon; transilluminated;



LED's (with integrated electronics); liquid crystals; gas discharge; fibre-optics

- Subminiature Lamps — LED & incandescent
- Low Profile Switches — completely sealed, illuminated, custom arrays
- Peripheral Accessories — universal mounting hardware; bezels; interface circuitry
- Customized Products & Multi-Function Systems. Never has so much been available to so many from a single source. Hadn't you better write or call today for your copy of IEE's Product Selector?

**the Olympus**  
Industrial Electronics  
Engineers, Inc.  
7740 Lemona Ave., Van Nuys, Calif. 91405  
Phone: (213) 787-0311

European Office: 6707 Schifferstadt, Eichendorff-Allee 19, Germany.  
Circle 172 on readers service card

## New products

megabits per second. The basic test set consists of three modules: a generator, an analyzer and an interface. Standard interfaces are ECL, TTL, T1, T2, and V.35, with special interfaces supplied upon request. The generator module produces a repeating 1,048,575-bit pseudo-random bit sequence at a rate determined by the interface module, and the bit pattern is applied to the interface module where the signal conversion takes place. The analyzer module accepts a repeating bit stream and a timing signal from the active interface and compares this received data with an error-free replica on a bit-by-bit basis. Bit errors and bit-error rates are shown on a 4-digit LED display. Price for the basic test set is \$6,500. Delivery time is 90 days.

International Data Sciences Inc., 100 Nashua St., Providence, R.I. 02904 [372]

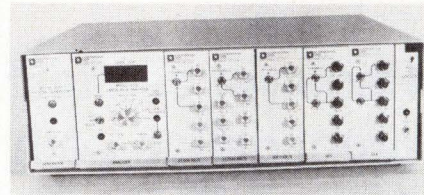

Low-frequency receiver has two-octave tuning range

A tunable low-frequency receiver for applications in sonar, acoustics, and radio-frequency monitoring covers 40 to 200 kilohertz with a sensitivity of 0.1 microvolt. Designated the model LF-24, the unit offers a choice of 1.2 or 4 kHz intermediate-frequency bandwidth, more than 40 hours of operation from an internal rechargeable battery, external operation from 12 volts dc or an optional 110 v ac adapter, dual input for an acoustic hydrophone and rf signal generator, and automatic gain control.

Bayshore Systems Corp., 5406A Port Royal Rd., Springfield, Va. 22151 [373]

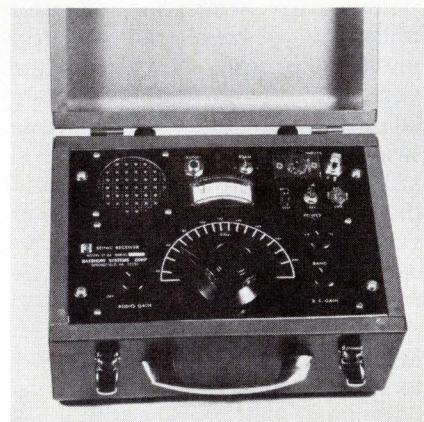

Phone hybrid transformer converts 4-wire to 2-wire

Designed to meet telephone requirements for data and voice access, the model 51084 transformer contains a hybrid pair for converting a four-wire terminal into a

## New products

two-wire voice path or the reverse. Isolation, balancing/matching networks, and retarding coils are internal. Frequency response over the range from 100 hertz to 4 kilohertz is within 0.2 dB, over levels from -30 dBm to +10 dBm. Longitudinal balance is 60 dB minimum, and return loss is 26 dB minimum. The trans-hybrid loss exceeds 50 dB. All specifications are met with 150 milliamperes dc of either polarity. The standard unit operates with impedance of 600 or 900 ohms, but any impedance or combination desired by a user can be supplied by minor variations. The unit is potted for rugged service and

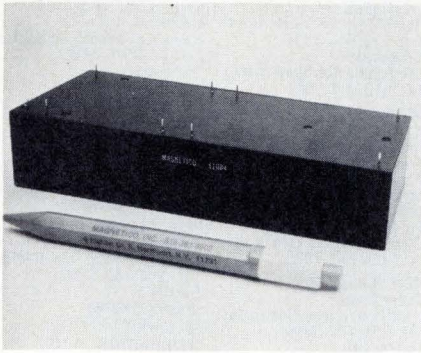

long life in any environment. Price of the 51084 is \$69 each in quantities of 1,000. Delivery time is stock to four weeks.

Magneto Inc., 6 Richter Court, East Northport, N.Y. 11731 [374]

## Three modems tailored to different data systems

A series of three 2,400-bits-per-second data modems is fully on-line-compatible with the Bell System 201B dataset and is intended for operation over the direct-distance-dial network, series 3002 C2, or unconditioned transmission facilities. The model 2400B1-A, lowest-priced model in the series, operates over dedicated lines or the direct-dial network, using a manual data-access arrangement. It offers instant synchronization, instant carrier recovery, and rapid ready-to-send/clear-to-send response. The model also features analog-loopback and local-digital-loopback diagnostic capabilities. The model 2400B1-B is identical to the A version with the exception that it can provide automatic-answering capabilities. The model 2400B1-C has a diagnostic capability that enables the operator at a central site to select one of up to 41 remote modems for testing of the modem and the transmission link.

Penril Data Communications Inc., 5520 Randolph Rd., Rockville, Md. 20852 [376]

## Amplifiers put out 50 watts, cover 500 kHz to 32 MHz

Four linear wideband rf power amplifiers are capable of 50 watts minimum output over a bandwidth from 500 kilohertz to 32 megahertz. The units, designated the series FK30-50, include calibrated wattmeters and

# IEE-SYSTEMS

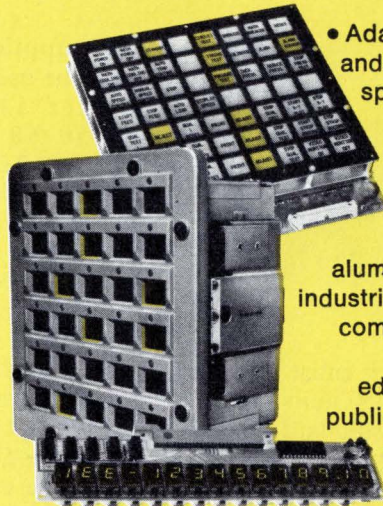

- Adaptable to all applications and environments
- Airborne, space, surface, subsurface, field and military command center applications
- Process control, petrochemical, hydroelectric, paper, textile, aluminum, and manufacturing industrial usages
- Point-of-Sale, communications, accounting, computer, public health, educational, transportation, public services, governmental, medical & hotel facilities, and service industry commercial installations
- Multi-functional capabilities: information display; status indication; switching; automatic control; operator cueing & decision assistance; POS customer data
- The ideal solution to the system designer's display requirements

From the very beginnings of information display, IEE has been a leader in the innovative design, successful introduction, reliable manufacture, condensed packaging, and effective application of high quality, display devices and integrated systems for commercial, industrial and military use. Based on two decades of experience, and a dedication to quality, IEE today offers: • the world's most diversified selection of display products • the design, human factors, and

systems integration expertise to fulfill your most sophisticated requirements. • the pricing, product availability, and productive capacity to meet your most demanding schedules • and the ingenuity and sincere desire to help solve your most complex display



problems. Information Display is OUR business; why not contact the experts for YOUR solutions? Call or write today for information regarding introductory offers on prototype evaluation quantities of many of IEE's display products.

**the Olympus**  
Industrial Electronics  
Engineers, Inc. **of displays**

7740 Lemona Ave., Van Nuys, Calif. 91405  
Phone: (213) 787-0311

European Office: 6707 Schifferstadt, Eichendorff-Allee 19, Germany.  
Circle 173 on reader service card

## New products



power supplies that can be used at either 110 volts/50-60 hertz or 220 V/50-60 Hz. The amplifiers will accept inputs of a-m, fm, single-sideband, and other complex

modulations over their entire frequency ranges. The 42-dB gain of the FK30-50 units permit them to be driven to full power by any standard signal or sweep generator capable of supplying a +5-dBm signal level into a 50-ohm input. The models require no tuning and are capable of useful power outputs at up to 40 MHz with reduced gain. Saturated power is as high as 85 watts. The four models range in price from \$1,375 to \$2,085.

Rf Power Labs Inc., 11013 118th Place N.E., Kirkland, Wash. [375]

## Printed-circuit card

answers phone data calls

Compatible with the Bell System data-access arrangement (DAA) 1001A-CBS and with DTL/TTL circuitry on the user's end, an automatic answer card indicates and controls the transmission circuit during incoming phone calls. Electronic circuits are housed on the printed-circuit card, measuring 4½ by 5¼ by ½ inches and using a 22-pin card-edge connector. All controls are positioned on the outside edge of the card, designated the model 4301, for ease of adjustment in a rack-mounted environment. In operation, indication of an incoming call at the DAA activates the 4301 card which, in turn, performs the "off-hook" function. After a brief period, the 4301 transmits a signal to the customer's equipment in the form of a logic level indicating that the data path is complete and that information exchange may begin. If the mode switch is in "automatic," the telephone line will be dropped after a predetermined interval, indicating that information exchange may begin. When operating in the "manual" mode, a logic signal from equipment at the end of the transmission will place the telephone line "on hook."

OPT Industries Inc.,  
300 Red School  
Lane, Phillipsburg,  
N.J. 08865 [377]

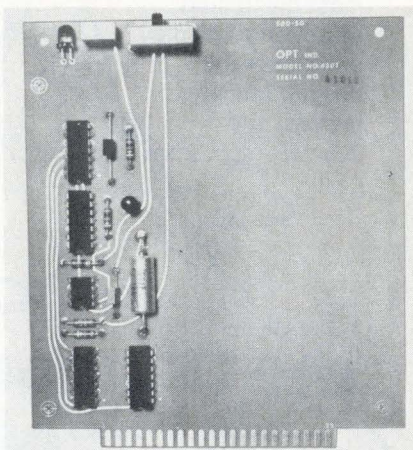

# ITT STOCKING DISTRIBUTORS

- ALABAMA**  
Birmingham  
ACK Radio Supply Co.  
Tel: 205-322-0588  
Huntsville  
Cramer/EW Huntsville, Inc.  
Tel: 205-539-5722
- ARIZONA**  
Phoenix  
Cramer/Arizona  
Tel: 602-263-1112  
Hamilton/Avnet Electronics  
Tel: 602-275-8751
- CALIFORNIA**  
Chatsworth  
Westates Electronics Corp.  
Tel: 213-341-4411  
Culver City  
Avnet Electronics  
Tel: 213-836-7200  
Tel: 714-522-8220  
Hamilton Electro Sales  
Tel: 213-870-7171  
Tel: 714-522-8200  
Irvine  
Cramer/Los Angeles  
Tel: 714-979-3000  
& 213-771-8300  
Los Angeles  
Radio Products Sales, Inc.  
Tel: 213-748-1271  
Menlo Park  
Bell Electronic Corp.  
Tel: 415-323-9431  
Mountain View  
Hamilton/Avnet Electronics  
Tel: 415-961-7000  
San Diego  
Cramer/San Diego  
Tel: 714-565-1881  
Hamilton/Avnet Electronics  
Tel: 714-279-2421  
Sunnyvale  
Cramer Electronics  
Tel: 408-739-3011
- COLORADO**  
Denver  
Cramer Electronics  
Tel: 303-758-2100  
Hamilton/Avnet Electronics  
Tel: 303-534-1212
- CONNECTICUT**  
Georgetown  
Hamilton/Avnet Electronics  
Tel: 203-762-0361  
North Haven  
Cramer Electronics  
Tel: 203-239-5641
- FLORIDA**  
Hollywood  
Cramer/EW  
Tel: 305-923-8181  
Hamilton/Avnet Sales  
Tel: 305-925-5401  
Orlando  
Cramer/EW Orlando  
Tel: 305-894-1511
- GEORGIA**  
Atlanta  
Cramer Electronics  
Tel: 404-448-9050  
Norcross  
Hamilton/Avnet Electronics  
Tel: 404-448-0800
- ILLINOIS**  
Des Plaines  
Edmar Electronics Co.  
Tel: 312-298-8580  
Elmhurst  
Semiconductor Specialists  
Tel: 312-279-1000  
Mt. Prospect  
Cramer/Chicago  
Tel: 312-593-8230  
Schiller Park  
Hamilton/Avnet Electronics  
Tel: 312-678-6310
- INDIANA**  
Indianapolis  
Semiconductor Specialists  
Tel: 317-243-8271
- KANSAS**  
Lenexa  
Hamilton/Avnet Electronics  
Tel: 913-888-8900
- MARYLAND**  
Baltimore  
Arrow Electronics, Inc.  
Tel: 301-247-5200  
Gaithersburg  
Cramer/EW Washington  
Tel: 301-948-0110  
Hanover  
Cramer/EW Baltimore  
Tel: 301-796-5790  
Hamilton/Avnet Electronics  
Tel: 301-796-5000
- MASSACHUSETTS**  
Burlington  
Hamilton/Avnet Electronics  
Tel: 617-273-2120  
Newton  
Cramer Electronics  
Tel: 617-969-7700  
Cramer/International  
Tel: 617-969-7700  
Greene-Shaw Co., Inc.  
Tel: 617-969-8900
- MICHIGAN**  
Detroit  
Semiconductor Specialists  
Tel: 313-255-0300  
Livonia  
Cramer/Detroit  
Tel: 313-425-7000  
Hamilton/Avnet Electronics  
Tel: 313-522-4700
- MINNESOTA**  
Edina  
Cramer/Bonn  
Tel: 612-835-7811  
Hamilton/Avnet Electronics  
Tel: 612-941-3801  
Minneapolis  
Semiconductor Specialists  
Tel: 612-854-8841
- MISSOURI**  
Hazelwood  
Hamilton/Avnet Electronics  
Tel: 314-731-1144  
Kansas City  
Semiconductor Specialists  
Tel: 816-452-3900  
St. Louis  
Olive Industrial Electronics  
Tel: 314-863-7800
- NEW JERSEY**  
Cedar Grove  
Hamilton/Avnet Electronics  
Tel: 201-239-0800  
Cherry Hill  
Cramer/Pennsylvania, Inc.  
Tel: 609-424-5993  
Clifton  
Wilshire Electronics/N.J.  
Tel: 201-365-1150  
Moonachie  
Cramer/New Jersey  
Tel: 201-935-5600  
Mt. Laurel  
Hamilton/Avnet Electronics  
Tel: 609-234-2133  
Pennsauken  
Resco Electronics  
A Div. of Astrex, Inc.  
Tel: 609-662-4000
- NEW MEXICO**  
Albuquerque  
Cramer/New Mexico  
Tel: 505-265-5767  
Hamilton/Avnet Electronics  
Tel: 505-765-1500
- NEW YORK**  
East Syracuse  
Cramer Electronics  
Tel: 315-437-6671  
Hamilton/Avnet Electronics  
Tel: 315-437-2642  
Endwell  
Cramer Electronics  
Tel: 607-754-6661  
Freeport  
Milgray Electronics  
Tel: 516-546-6000  
Hauppauge, L. I.  
Cramer/Long Island  
Tel: 516-231-5600  
Rochester  
Cramer Electronics  
Tel: 716-275-0300  
Westbury L.I.  
Hamilton/Avnet Electronics  
Tel: 516-333-5800
- NORTH CAROLINA**  
Winston-Salem  
Cramer/EW Winston-Salem  
Tel: 919-725-8711
- OHIO**  
Cincinnati  
Cramer/Tri-States  
Tel: 513-771-6441  
Cleveland  
Cramer/Cleveland  
Tel: 216-248-8400
- Dayton**  
Hamilton/Avnet Electronics  
Tel: 513-433-0610  
Dayton-Cleveland  
Hamilton/Avnet Electronics  
Tel: 216-289-0550
- OREGON**  
Seattle-Portland  
Hamilton/Avnet Electronics  
Tel: 503-224-9450
- PENNSYLVANIA**  
Philadelphia-Mt. Laurel  
Hamilton/Avnet Electronics  
Tel: 215-831-1300
- TEXAS**  
Dallas  
Cramer/Texas  
Tel: 214-350-1355  
Texas WATTS 800-492-6940  
Hamilton/Avnet Electronics  
Tel: 214-661-8661  
Dallas-Ft. Worth  
Hamilton/Avnet Electronics  
Tel: 817-275-6561  
Houston  
Hamilton/Avnet Electronics  
Tel: 713-526-4661  
Richardson  
Altair Co., Inc.  
Tel: 214-231-5166
- UTAH**  
Salt Lake City  
Cramer/Utah  
Tel: 801-487-4131  
Hamilton/Avnet Electronics  
Tel: 801-262-8451
- WASHINGTON**  
Bellevue  
Hamilton/Avnet Electronics  
Tel: 206-746-8750  
Seattle  
Cramer/Seattle  
Tel: 206-762-5755
- WASHINGTON, D. C.**  
Baltimore  
Hamilton/Avnet Electronics  
Tel: 301-953-7010
- WISCONSIN**  
Oak Creek  
Cramer/Wisconsin  
Tel: 414-764-1700
- CANADA**  
Downsview, Ontario  
Cramer/Canada, Ltd.  
Tel: 416-661-9222  
Halifax, Nova Scotia  
Consolidated Supply Co. Ltd.  
Tel: 902-454-8581  
Mississauga, Ont.  
Hamilton/Avnet Electronics  
Tel: 416-677-7432  
Montreal, Quebec  
Hamilton/Avnet Electronics  
Tel: 514-735-6393  
Ottawa  
Hamilton/Avnet Electronics  
Tel: 613-725-3071  
Vancouver, B. C.  
Cam Gard Supply, Ltd.  
Tel: 604-291-1441  
Winnipeg, Manitoba  
Cam Gard Supply, Ltd.  
Tel: 204-786-8401
- ITALY**  
Roma  
Cramer/Italia  
Tel: 51-393-87  
and 51-393-90
- PUERTO RICO**  
De San German  
Cramer/Puerto Rico  
Tel: 809-892-1130  
San Juan  
ITT Caribbean  
Sales & Service  
(P.R.) Inc.  
Tel: 809-767-5050  
809-766-2408

**ITT**  
SEMICONDUCTORS Worldwide

# Who's tuned in on consumer electronics?

Rate ITT by its accomplishments. Take a look at our 3701 — it's a complete monolithic 2-watt FM sound system for TV, radio and other FM sound communications. It is packaged in a 14-pin power DIP. It eliminates shielded volume control cables and is impervious to output short circuits. It drastically reduces your total component requirement while providing limiting with less than 100  $\mu$ V input. It's only one in a line of ITT devices that includes the popular 1330, 1352, 3064, 3065 (plus several proprietary circuits), as well as double-plug diodes, glass rectifiers, zeners and other consumer-oriented components. Tune in to ITT now!

## ITT...Logically

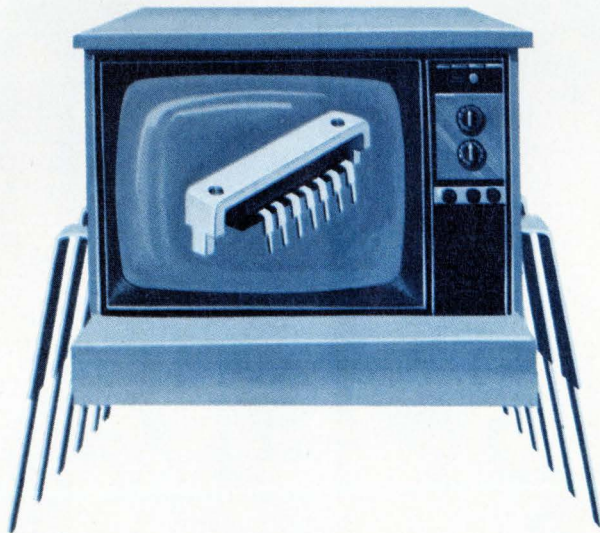

# semiconductors

ITT Semiconductors is a division of International Telephone and Telegraph Corporation, 3301 Electronics Way, West Palm Beach, Florida 33407. Phone 305/842-2411. Factories in West Palm Beach, Florida • Lawrence, Massachusetts • Footscray, England • Colmar, France • Freiburg, Germany • Cascais, Portugal • Taipei, Taiwan • Sydney, Australia.

# ITT

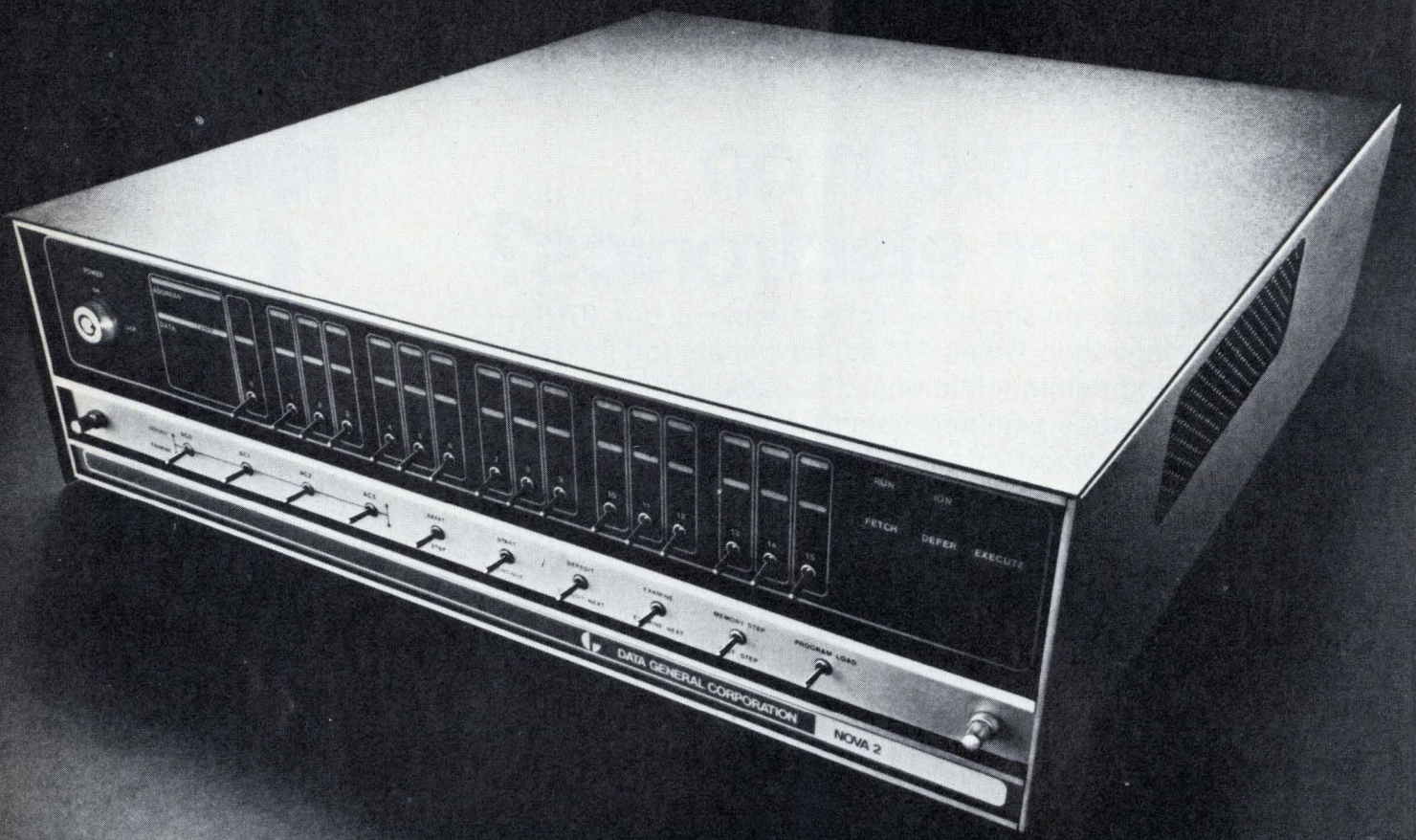

Now, nobody needs to wait for the computer everybody wants.



Not long ago, you couldn't get a Nova 2 for love or money.

Now all you need is money.

If you're willing to buy five Nova 2's at a time with 16K or 32K memory in each, you can get them in any quantity, within 60 days.

And for those who only want one, we've come up with five different Nova 2 systems you can buy one at a time.

The smallest is built around our RTOS operating system. Which makes it a great little real-time data acquisition satellite.

Next up the line is our SOS system. A small single-user computation system for people who don't need a disc.

Then there's the medium-sized RDOS system you can use to develop software and hardware interfaces, or to build your own medium-sized computation system.

Which is followed by a big RDOS system with more storage and faster output for higher throughput.

And finally, for the people who need a system with a built-in backup computer, there's the Dual Nova 2.

Now, everybody who wants Nova 2's can get them.

And 60 days after our factory gets your order, you'll get your system.

# DataGeneral

The computer company you can understand.

• Data General Corporation Southboro, Massachusetts 01772, (617) 485-9100.  
Datagen of Canada Ltd., Hull, Quebec (819) 770-2030/Data General Europe, Paris, France 504-23-44.

Circle 177 on reader service card

Materials

## Elastomer has sensor quality

Resistance of conductive material varies with pressure over wide range

The resistance of a new conductive elastomer varies linearly with pressure over a range wide enough to make it suitable for a host of sensor applications, say its developers. The material, called Dynacon, was developed by a chemist and a chemical engineer who formed Dynacon Industries Inc. in Leonia, N.J., to make and market it. Dynacon is cast in sheets of treated metal particles suspended in a rubber or plastic that resemble the conducting elastomers being used for such things as electromagnetic shielding and electrical connectors.

However, unlike these conventional materials, which rely on the conduction of electrons by suspended metal particles in contact, Dynacon has an intermediary semi-conducting zone—referred to as a charge-transfer complex by Dynacon president Harold Charles—which conducts electricity under pressure only along the direction in which the pressure is applied. The

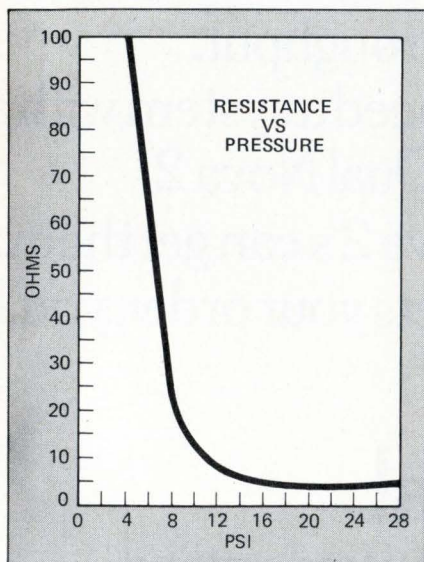

metal particles need not be in contact for conduction to take place, Charles emphasizes. Its resistance can be as high as 10 megohms and as low as 0.1 ohm.

Charles points out that the material can be produced in a variety of ways—to conduct very well, or only barely; to resist pressure or yield readily; or almost any combination of these features. It can be either cast or molded and die-cut from cast sheets into various forms. Current rating is 0.5 ampere per square inch, although intermittent currents of up to 5 A per square inch can be tolerated, says Charles. Voltage range is 6 to 13 v, with intermittent voltages considerably higher.

Right now, the Dynacon is a material in search of an application. And, accordingly, it is being made available in a sample kit containing 50 square inches of 25-mil-thick Dynacon in a silicone-rubber base.

Potential applications for what Charles calls Dynacon C include pressure, torque, and tension gages, potentiometers, small-motor controls, weight scales, and leveling devices. At least one company is considering it as a pressure sensor in the "hand" of a robot, Charles says.

Another version of the material is Dynacon A, a highly conductive plastic for low-current switch elements, electromagnetic shields, strain-gage elements, and bin-level sensors. A third variation, Dynacon B, switches on when pressed.

Price of the sample kit is \$10.

Dynacon Industries Inc., 117 Fort Lee Rd., Leonia, N.J. 07605 [340]

### High-temperature parts available in ceramics

Precision high-temperature components and fixtures are available in ceramics such as aluminum oxide, aluminum silicate, boron nitride, and silicon nitride. If they are machined in both the green and fired states, complex geometries can be produced. Accuracy can be held to within +1%, but finer tolerances of +0.001 inch are also possible. Heat sinks, crucibles, and insulators are

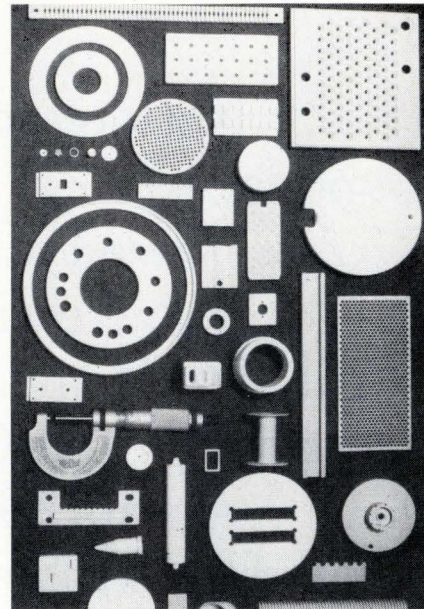

among the wide variety of components available.

Duramic Products Inc., 426 Commercial Ave., Palisades Park, N.J. 07650 [477]

### Polishing powder made for gallium phosphide wafers

A low-cost polishing compound, specifically designed for gallium phosphide (GaP) wafer production, is designated Gaapol A. The material generates highly specular, damage-free surfaces with considerable stability and few pits or hillocks. Producing high-quality polishes in less than 30 minutes, Gaapol A is packaged as a powder in individual vials. Each vial is mixed with de-ionized water to make 500 cubic centimeters of noncorrosive, non-hazardous solution. The polish is available from stock at \$5 per vial or \$30 per box of 12 vials.

Geos Corp., Stamford, Conn. 06902 [480]

### Stamped heat sink made for TO-3 cases

The model 351 is an aluminum two-piece (base and retainer) stamped heat sink for the TO-3 cases used in pc-board applications. Said to require minimum board space and offer optimum heat transfer, the 351

# SIEMENS

## Cost Effective Solutions to Semiconductor Test Problems

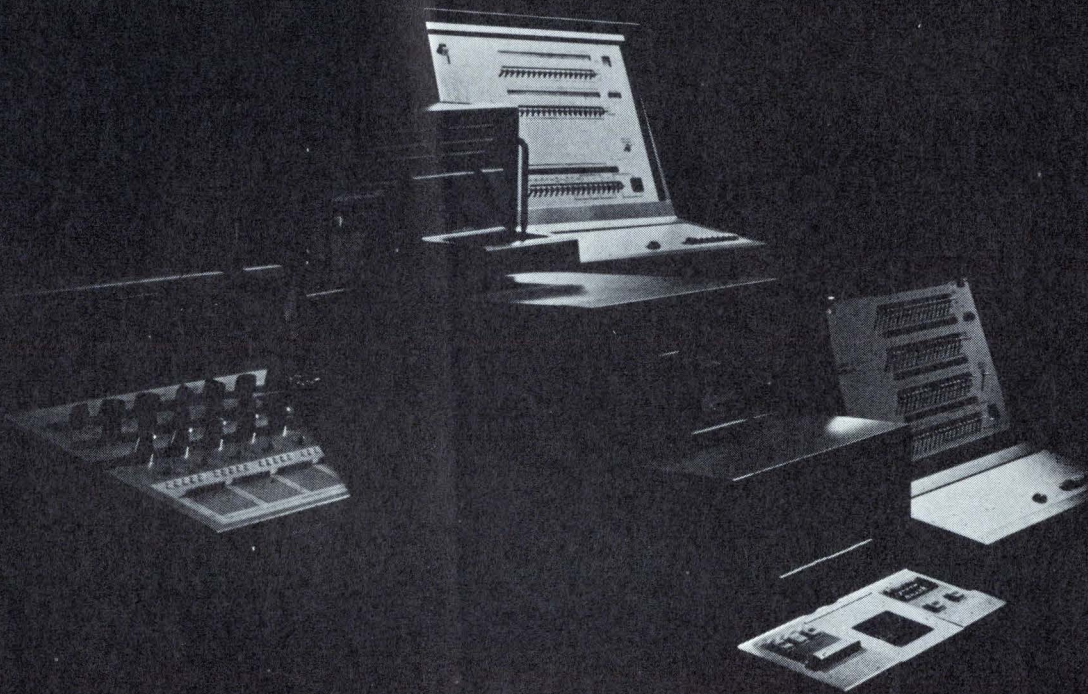

### GENERAL PURPOSE IC TESTER COMPUTEST 716A

Low-cost parametric and functional tester for digital and linear circuits

### DIGITAL CIRCUIT TESTERS COMPUTEST 720 SERIES

Provides complete DC parametric and functional verification of digital IC's

### LINEAR CIRCUIT TESTER COMPUTEST 735

Tests operational amplifiers, regulators, comparators, sense amplifiers and custom linear circuits

### BENCH-TOP MEMORY TESTERS COMPUTEST 901 SERIES

Provides real-time verification of semiconductor memory performance from the device to the complete memory systems level

**FREE!**

Send for the Computest catalog of Semiconductor Test Equipment and our Semiconductor Program Library

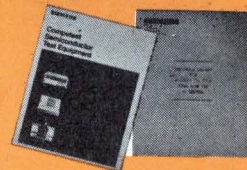

NAME \_\_\_\_\_  
COMPANY \_\_\_\_\_  
ADDRESS \_\_\_\_\_  
CITY \_\_\_\_\_  
STATE \_\_\_\_\_ ZIP \_\_\_\_\_

**FOR APPLICATIONS ASSISTANCE . . .  
CALL US!**

**Siemens Corporation**  
Electronic Systems Division  
Computest Products

3 Computer Drive, Cherry Hill, N.J. 08002 (609) 424-2400

## HERMES LOOP ANTENNA

THREE SAMPLE SITES  
ON THE NORTH AMERICAN  
CONTINENT —

DIFFERENT LATITUDES  
DIFFERENT CLIMATE

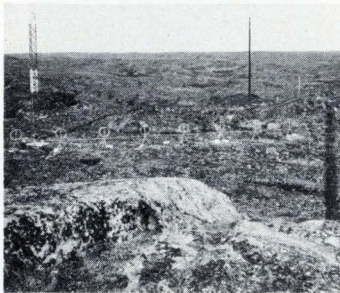

FROBISHER BAY, CANADA

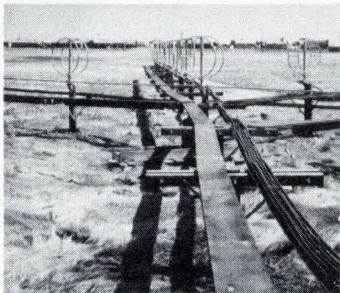

MARSHFIELD, MASS.

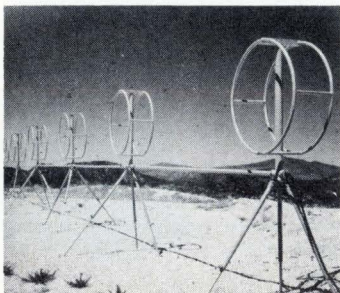

NEAR SAN DIEGO, CALIF.

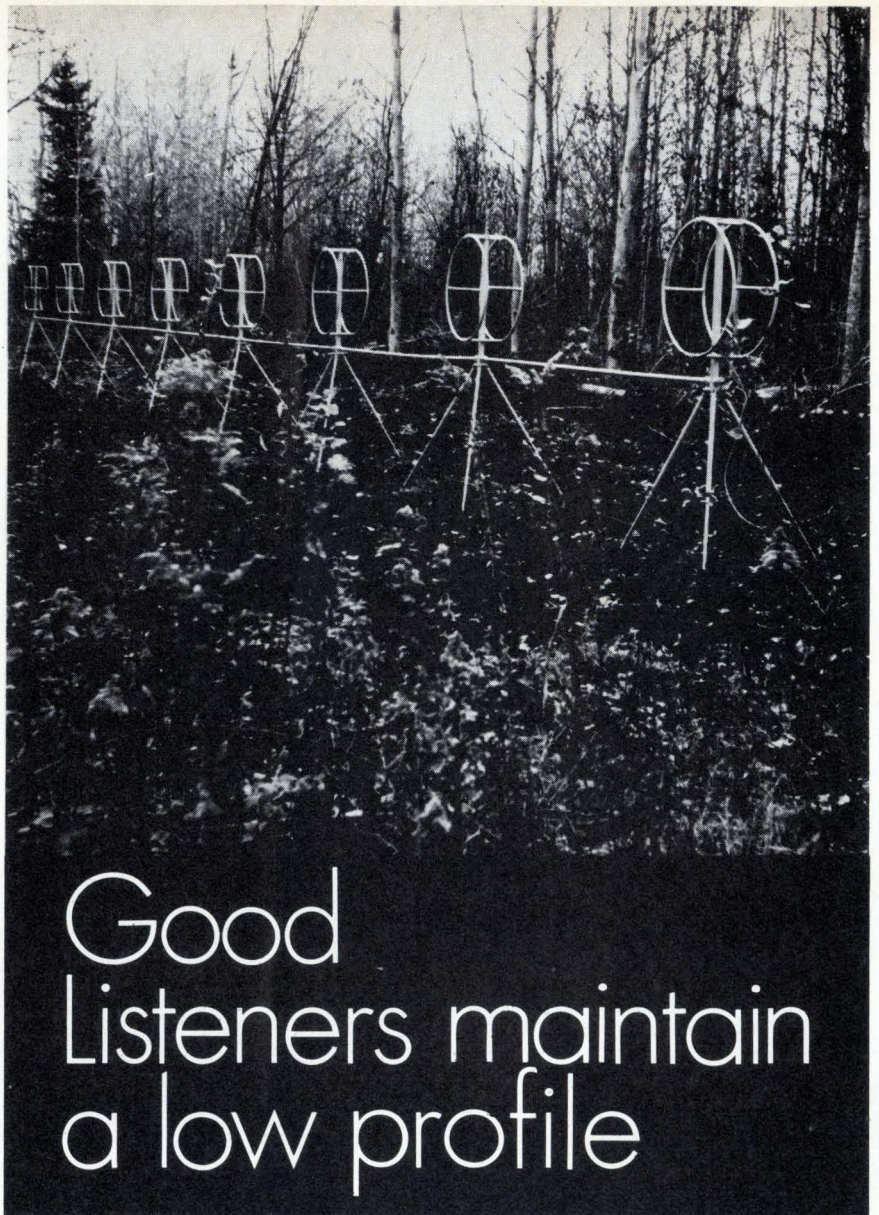

# Good Listeners maintain a low profile

Even in the solitude of the forest depths, from rooftops, arctic tundra, swamps to sweltering tropics, 'neath snow, sand or ice,

the Hermes Loop antenna keeps an ear to the sky. The amazing aperiodic antenna does away with vast log periodic and rhombic arrays - those towering antenna farms.

Excellent directional characteristics in rosette configuration, the Hermes loop antenna provides an omnidirectional broadband receiving array in space merely 1/100th that of the traditional antenna farm. More than 53 government agencies around the world have pressed the loop antenna into service.

A new, even more compact version is available. Only Hermes Electronics makes it.

**2-32MHz  
BROADBAND**

**ASK US Send for our Brochure**

Hermes Electronics Limited  
Suite 315  
2020 F Street NW  
Washington, DC 20006 USA  
202-296 2978  
TWX 710 822 1106



# 1%

AMERICAN MADE

## Tolerance **SCHAUER** 1-Watt **ZENERS**

**Immediate Shipment  
Low Prices**

ANY voltage from 2.0 to 16.0

Quantity	Price each
1-99	\$1.07
100-499	.97
500-999	.91
1000-4999	.86
5000 up	.82

All welded and  
brazed assembly

No fragile  
nail heads

Gold  
plated  
leads

Write for complete  
rating data and other  
tolerance prices.

## Buy the kit- Save a lot



Kit contains a 51-piece assortment of SCHAUER 1% tolerance 1-watt zeners covering the voltage range of 2.7 to 16.0. Three diodes of each voltage packaged in reusable poly bags. Stored in a handy file box. Contact your distributor or order direct.

A \$54.57 value for  
**ONLY \$24<sup>50</sup>**

Semiconductor Division

## **SCHAUER**

Manufacturing Corp.

4514 Alpine Ave. Cincinnati, Ohio 45242  
Telephone: 513/791-3030

### New products

utilizes a lanced fin configuration in the base piece for maximum surface exposure. Also, the incorporation of a stamped spring-type retainer in the mounting of the device ensures a positive surface alignment between the device and base, taking little or

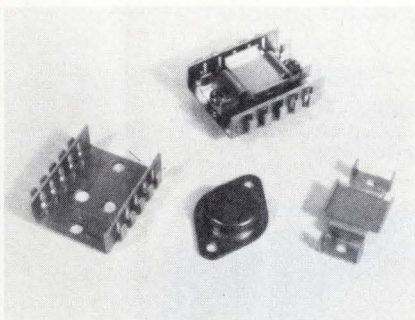

no space above the device while offering extra heat dissipation. Available from stock with no finish, price of the base is 15 cents; of the retainer, 10 cents.

Aham, 968 W. Foothill Blvd., Box 909,  
Azusa, Calif. 91702 [479]

Acid gold strike solution  
produces 24-karat plating

An acid gold strike solution, called E-100, which produces a dense 24-karat gold electroplate, is specifically designed to promote adhesion of subsequent precious-metal electroplates, particularly over base metals that tend toward passivity. These include steel, nickel, and Kovar. The E-100 strike solution is also recommended as a preplate for the company's E-70 bright gold-plating solution, which is suitable for the processing of printed circuits, connectors, contacts, diodes, switches and relays.

Engelhard Industries, 430 Mountain Ave.,  
Murray Hill, N.J. 07974 [405]

Conformal coating protects,  
stabilizes resistor networks

Hybrisil is the name of a set of conformal coatings that have been specifically designed to protect and stabilize thick- and thin-film resistor

## NEW LOW-COST THERMALFILM II

### Easy-to-handle insulating washers cost less than mica

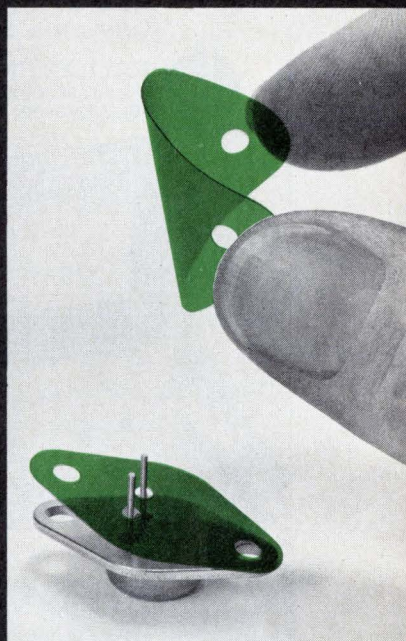

- No chipping
- No peeling
- No breaking
- Bright green color identification
- Interface thermal resistance .6°C/W
- 1000 V/mil dielectric strength
- For case temperatures to 125°C

Now available from Thermalloy:  
New, low-cost Thermalfilm II with the superior electrical properties of original Thermalfilm. Helps you reduce rework and rejects, improve product reliability.

### MOUNTING KITS

Also available in convenient, low-cost mounting kits for TO-3 and TO-66 packages.

## FREE SAMPLES

Circle reader service number



**Thermalloy Inc.**  
NUMBER ONE IN SEMICONDUCTOR ACCESSORIES  
P.O. BOX 34829

2021 VALLEY VIEW LANE/DALLAS, TEXAS 75234  
TELEPHONE (214) 243-4321/TWX 910-860-5542

# Ballantine, 3 to 1 in your favor!

New 15MHz Precision Voltmeter  
replaces three old designs  
100  $\mu$ V sensitivity  
unmatchable performance  
from \$365  
Call your local Ballantine field engineer.



**BALLANTINE LABORATORIES, INC.**  
P.O. Box 97, Boonton, New Jersey 07005  
201-335-0900, TWX 710-987-8380

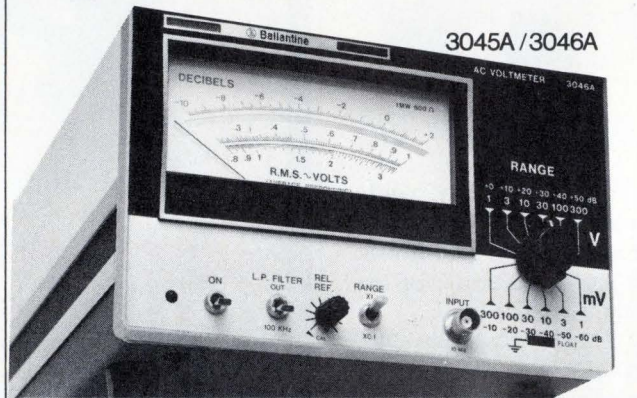

Circle 182 on reader service card

## RUGGED, LOW COST THERMOPILE DETECTORS

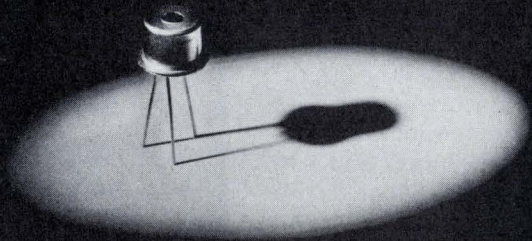

- Exhaust gas analysis
- Intrusion sensing
- Spectrophotometry
- Non-contact temperature sensing
- Military and space sensing systems

High performance, low cost Thermopile Detectors incorporating the latest thin-film technology in a TO-5 package. Designed and produced to exacting standards of quality control at Sensors, for reliable service in extreme operating environments.

Standard models available for most requirements. Experienced applications engineering assistance for your special problems.



3908 Varsity Dr. • Ann Arbor, Mich. 48104 • (313) 973-1400

## New products

networks. The materials, which are one-part systems, silicone-based and easily applied, are said to provide a low-cost yet reliable process for resistor encapsulation. In addition, the need for high-temperature firings with cermet encapsulations is avoided. Several Hybrisil compositions are offered. Hybrisil-100 cures to a flexible translastic material in normal room humidity. Hybrisil-200 is a silicone-mica-filled system that cures at an elevated temperature. Hybrisil-300 also cures at an elevated temperature to produce a coating that will withstand very high voltage. Hybrisil preparations are available in pint, quart, gallon and 5-gallon sizes. The quart size is priced at \$20.

Transene Co. Inc., Rte. 1, Rowley, Mass. 01969 [406]

## Thick-film pastes available in a kit

Evaluation kits of a thick-film paste system for electro-optics consist of four conductor materials and two dielectric materials, including high- and low-temperature-firing nickel conductors, copper and silver conductors, an opaque dielectric, and a clear dielectric. These pastes, and others in the system, are designed for a variety of electro-optics applications, including the production of LED, liquid-crystal, and plasma displays, channel multipliers, fiber optics and ultraviolet-transmitting faceplates. The paste systems are said to raise throughput and yields, and also to improve both performance and reliability.

Cermalloy, 14 Fayette St., Conshohocken, Pa. 19428 [407]



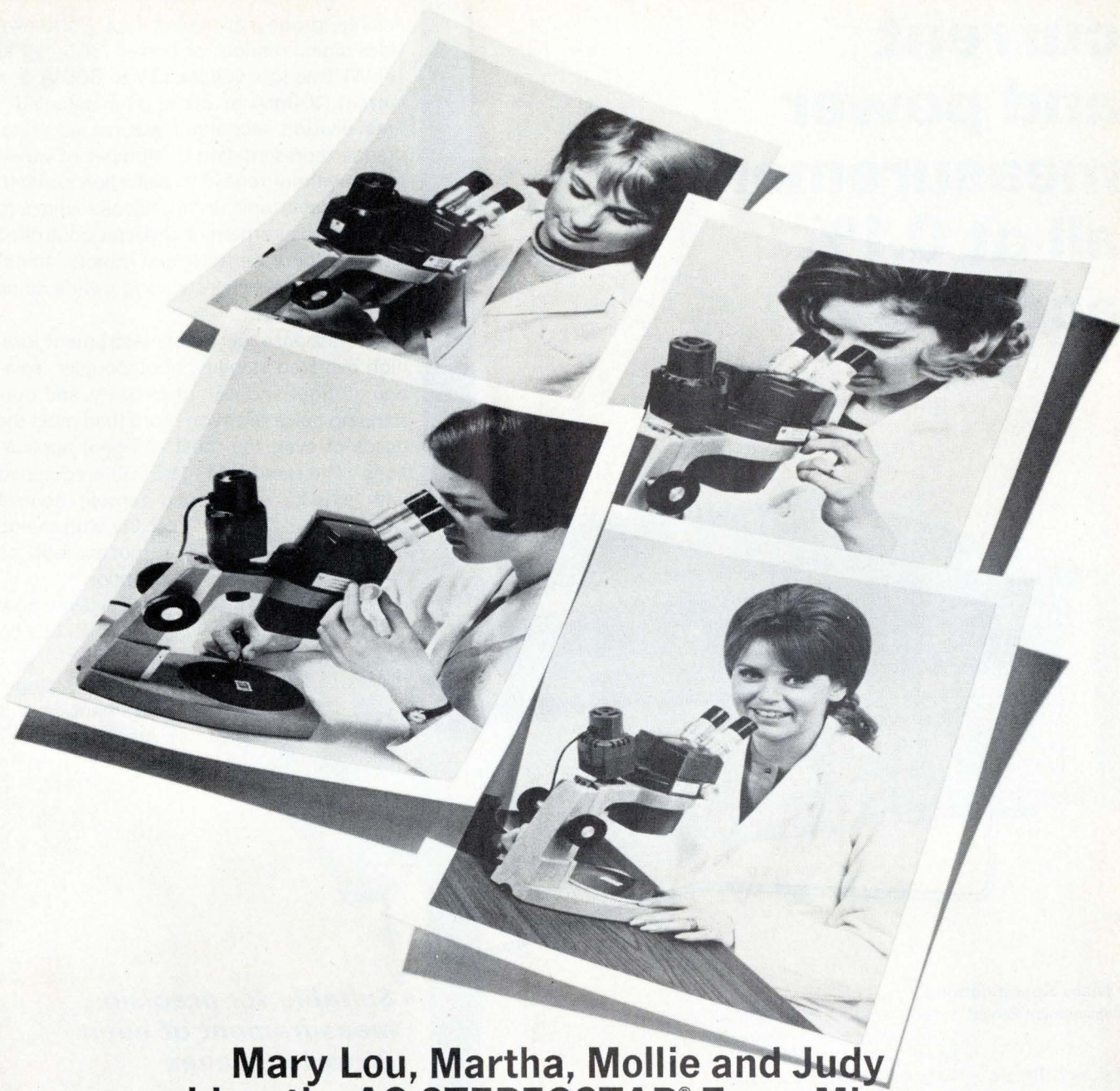

**Mary Lou, Martha, Mollie and Judy  
are sold on the AO STEREOSTAR® Zoom Microscope.**

## Here's why.

The AO STEREOSTAR Zoom stereoscopic microscope was specifically designed for convenience, working ease and optical performance.

Zoom controls are located on both sides for convenience. It eliminates awkward reaching when changing magnification. The high resolution optical power pack may be rotated 360° to accommodate most any assembly or inspection situation. Full optical equipment offers a magnification range of 3.5x through 210x.

Working distance of 4.0 inches is maintained at all magnifications in basic models, and if that's not enough, add a 0.5x

auxiliary lens to make it 5.7 inches.

STEREOSTAR Zoom microscope assures a wide field of view, up to 2.25 inches with the 10x high eyepoint eyepieces. It also features an extremely efficient illuminator that stays cool even after long hours of continuous use.

See for yourself. Contact your AO dealer or sales representative for a convincing demonstration.



**AMERICAN OPTICAL  
CORPORATION**

SCIENTIFIC INSTRUMENT DIVISION • BUFFALO, N.Y. 14215

# True rms voltage, current and power measurements all at 0.1% accuracy

## YEW INSTRUMENTS FOR PERFECTION

A three-in-one instrument, Type 2503 provides digital readout of power (300mW to 18kW), true rms voltage (3V to 600V) and current (100mA to 30A). Our patented time division technique assures accurate, precise representation of all types of waveforms without regard to distortion content. This versatile unit is thus ideally suited to power measurement of thyristor-controlled circuits, fluorescent lamps, motors, transformers, magnetic circuits and a wide range of other devices.

Quick response, negligible instrument loss, high overload stability, photocoupler isolation of input and output circuitry, and outstanding noise rejection more than meet the needs of even the most stringent applications. The standard Type 2503 is equipped with a BCD output and remote control

facility, with analog output available as an option.

Let us tell you how Type 2503 can be put to work for you as either a single instrument or in a systems application.



### • Main Specifications

Measurement Ranges: Voltage; 3/10/30/100/300/600V  
 Current; 0.1/0.3/1/3/6/10/30A  
 Power; 300mW to 18kW

Frequency Ranges: Voltage; DC and 25Hz to 2kHz  
 Current; 25Hz to 2kHz  
 Power; 40Hz to 1.2kHz

Accuracy: Voltage;  $\pm(0.1\%$  of rdg + 0.05% FS) from 50Hz to 400Hz,  
 $\pm(0.2\%$  of rdg + 0.07% FS) for DC, 25Hz to 50Hz  
 and 400Hz to 2kHz  
 Current;  $\pm(0.1\%$  of rdg + 0.05% FS) from 50Hz to 400Hz,  
 $\pm(0.2\%$  of rdg + 0.07% FS) from 25Hz to 50Hz  
 and 400Hz to 2kHz  
 Power;  $\pm(0.1\%$  of rdg + 0.05% FS) from 50Hz to 400Hz,  
 $\pm(0.2\%$  of rdg + 0.07% FS) from 40Hz to 50Hz  
 and 400Hz to 1.2kHz

Resolution: 1mV/digit, 10 $\mu$ A/digit, 0.1mW/digit

• **Suitable for precision measurement of even distorted waves**

• **Protected to withstand 2,200V AC**

# YEW

• For Electronic Measuring, Recording Instruments:  
**YOKOGAWA ELECTRIC WORKS, LTD.**

Yaesu-Mitsui Bldg., 5-7 Yaesu, Chuo-ku, Tokyo 104, Japan Phone: 274-6511 Telex: J28544 YEW TOK

Overseas Offices: • YEWTEC CORPORATION, 1995, Palmer Ave., Larchmont, New York, 10538, U.S.A. Phone: 914-834-3550, Telex: 710-566-1104 • YEW EUROPÄISCHES VERBINDUNGSBÜRO, 2000 Hamburg 26, Hammer Landstrasse, 76 I.O.G., Germany. Phone: Hamburg 2191310, Telex: 41211435 YEW D (for domestic call, omit "41")

Representatives in Europe: • Belgium: COMPTOIR COMMERCIAL INTERNATIONAL S.A., (03) 32.78.64 • France: TEKELEC AIRTRONIC, 626-0235 • Finland: FINN METRIC OY, 460 844 • West Germany: NBN ELEKTRONIK, (08151) 13036 • Italy: VIANELLO S.P.A., 5483811 • Norway: AS MAXETA, 53090 • The Netherlands: TECHMATION NV, 020-456955 • Spain: ATAIO INGENIEROS, 215-35-43 • Sweden: TELEINSTRUMENT A.B., 87-03-45 • Switzerland: OMNI RAY AG, 01-340355 • United Kingdom: MARTRON ASSOCIATES LTD., Marlow (06284) 5071.



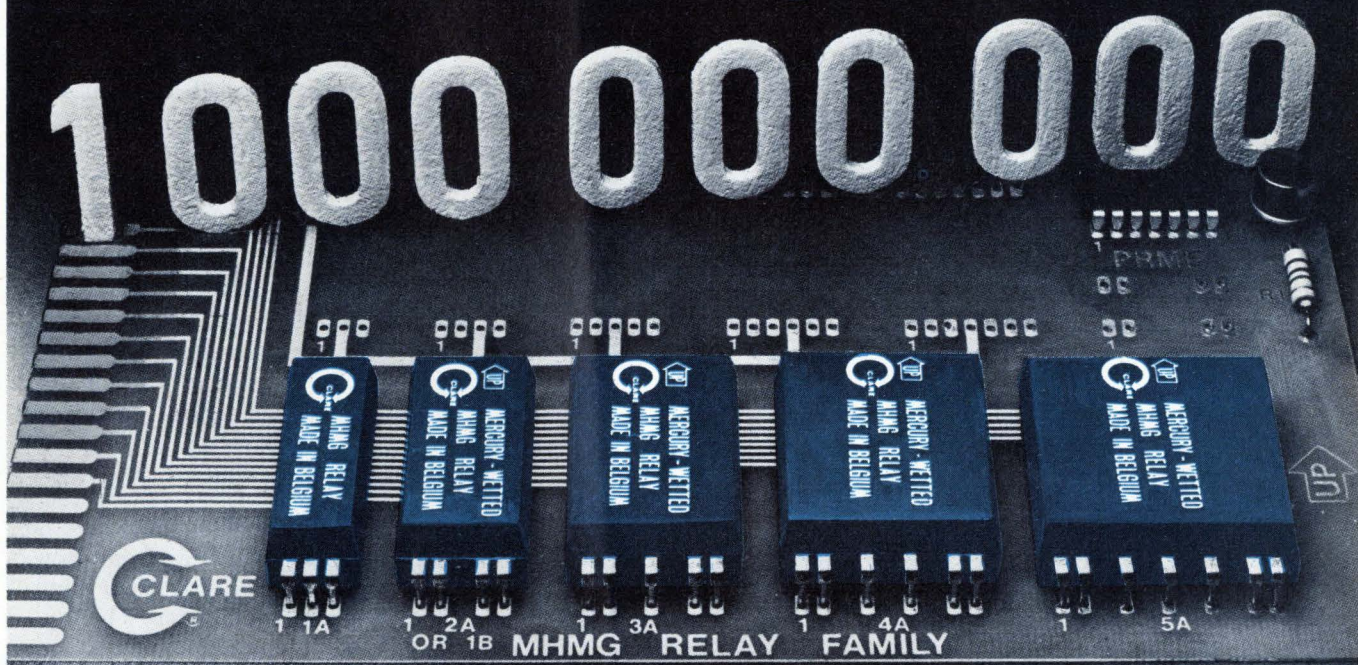

**BILLIONS OF SWITCHING OPERATIONS  
AT A PRICE YOU CAN AFFORD**

# CLARE MHHMG

**A new family of epoxy molded mercury-wetted relays.**

MHHMG relays offer billion ( $10^9$ ) operation-bounce free mercury-wetted switching performance, load handling capability from signal-level to 50 VA, multipole flexibility from one to five contacts, epoxy molded packaging for PCB mounting, and at a cost approaching dry reed relays.

Like all Clare mercury-wetted relays, the heart of the MHHMG is a Clare manufactured hermetically sealed glass capsule. Contact switching is mercury-to-mercury. So there's no contact wear, no contact bounce, constant

ON and OFF impedances - every operation. Maximum switching ratings for MHHMG relays are 350 Vdc, 1 Amp. The MHHMG family are high quality components for telecommunications, business machines, industrial data logging and control, and other electronic instrument applications.

For more information contact :  
C.P. Clare & Co. 3101 West Pratt Blvd., Chicago, Illinois 60645.  
Telephone (312) 262-7700 - Telex 25-3775



**C. P. CLARE & COMPANY** a subsidiary of  
**GENERAL INSTRUMENT CORPORATION**

MarkCom

# UP YIELDS

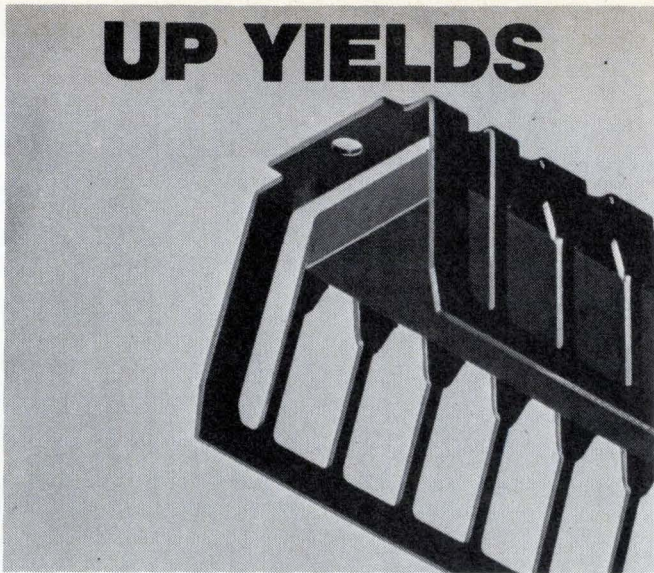

Up electrical yields with low-temperature hermetic sealing.

The Diacon 8 to 36 lead package systems for surface-sensitive devices saves assembly time and other packaging costs.

For information, call or write...

## DIACON, INC.

4812 Kearny Mesa Road  
San Diego, California 92111  
(714) 279-6992

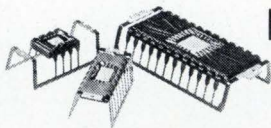

Circle 186 on reader service card

# The Quick Way

New Electronics Buyers' Guide  
Easy-to-use, single volume source for:

- Information on 4,000 products
- Over 6,000 company listings and phone numbers
- **EBG EXCLUSIVE:** quick access to over 800 catalogs through a Direct Inquiry Service

Here is the international world of electronics at your fingertips. Find suppliers . . . fast . . . accurately . . . and locally! If you don't have your own copy, send \$15.00 (USA and Canada only; elsewhere send \$25.00) to address shown below.

## Electronics Buyers' Guide

A McGraw-Hill Publication • 1221 Ave. of the Americas • New York, N.Y. 10020

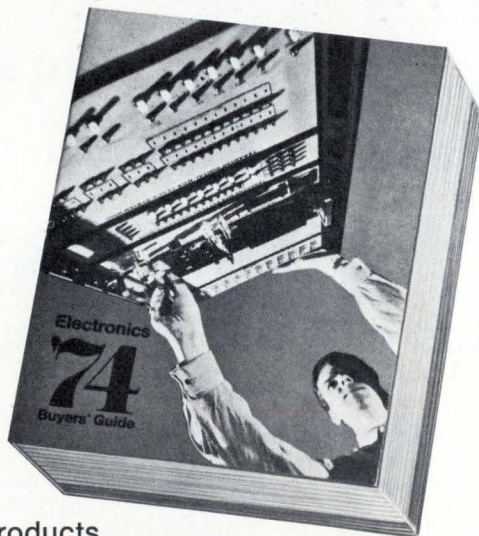

## New literature

**Resistors.** A two-page data sheet from Elliot Industries, 23987 Craftsman Rd., Calabasas, Calif. 91302, describes the series G line of noninductive precision wire-wound resistors. The devices feature small size and stable high-temperature operation. Circle 421 on reader service card.

**Product news.** Milertronics News, a publication of Milertronics, 525-A Airport Rd., Greenville, S.C., is printed every other month and highlights the company's products, as well as providing applications notes and other information. [422]

**Keyboards.** A pair of brochures on keyboards is available from Bowmar Instrument Corp., 8000 Bluffton Rd., Fort Wayne, Ind. The four-



page and six-page publications respectively provide applications and product information. [423]

**Interconnections.** Amphenol Industrial division, Bunker Ramo Corp., 1830 S. 54th Ave., Chicago, Ill. Integrated-circuit interconnections are described in a 16-page catalog, which provides specifications and line drawings. [424]

**Annunciators.** A 16-page brochure from TEC Inc., 9800 N. Oracle Rd., Tucson, Ariz. 85704, describes the Data Monitor series 7700 annunciators, which provide high-density alarm displays by integrating solid-state logic into the company's Data Panel display systems. [425]

**Fuse resistors.** The effective use of fuse resistors is discussed in a bro-

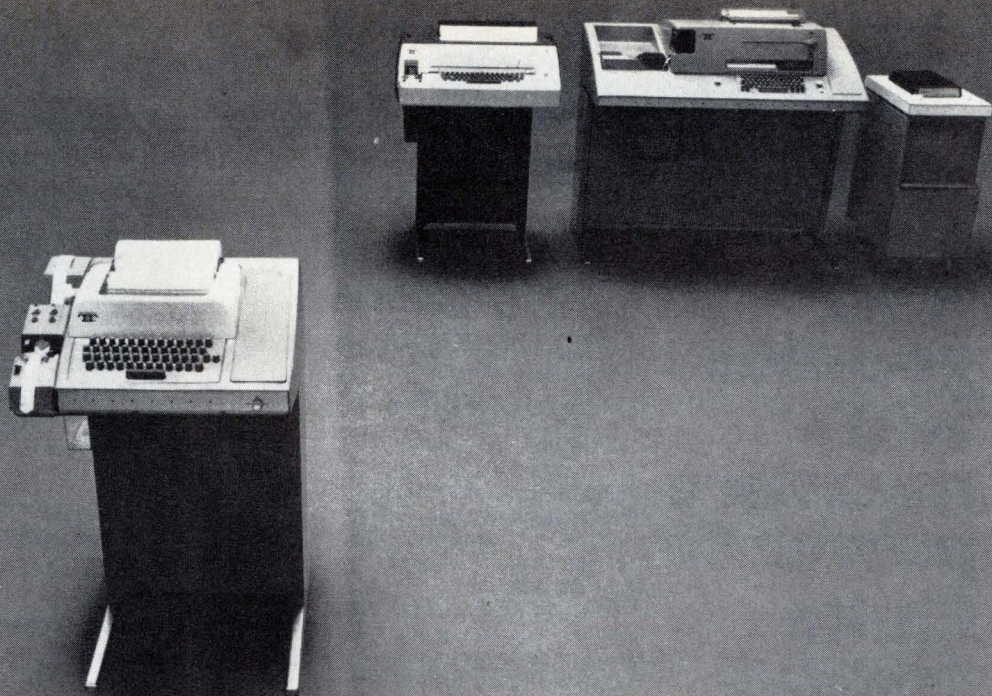

**As good as the model 33 is, we're aware that for some people it's not enough.**

Our model 33 is the standard of the data communications business for three very good reasons. Economy, reliability and versatility.

Yet we realize some applications require a little more. That's why the model 33 isn't an orphan.

Some of our customers want everything the model 33 offers, but they want it in a wide-platen configuration to accept standard computer fan-folded forms. For them, we make the model 38.

Some customers may have applications requiring an extremely rugged terminal. A

machine that can operate day and night for months on end with little maintenance. For them, we make our heavy-duty model 35.

Still others need a unit that can give them greater speed. For them we build our 4210 magnetic tape terminal. The 4210 is compatible with all our other terminals and can move data on-line at speeds up to 2400 wpm.

Our data terminals are offered in various configurations: models 33, 35 and 38 can be ordered as ASR, KSR and RO units.

It takes more than manufacturing facilities to build the terminals Teletype® Corporation offers. It also takes commitment. From people who think service is as important as sales. In terminals for computers and point-to-point communications.



**The computercations people.**

For more information about any Teletype product, write or call: TERMINAL CENTRAL, Teletype Corporation, Dept. 53R, 5555 Touhy Avenue, Skokie, Illinois 60076. Phone 312/982-2500. Teletype is a trademark registered in the United States Patent Office.



## New goodies add measure power to Fluke 8000A

Best selling 3½ digit DMM even better with new options and accessories

For data out today, dial our toll-free hotline, 800-426-0361

Circle 188 on reader service card

New ac/dc high current option lets you measure 10 A. continuously or up to 20 A. momentarily. New low 2 and 20  $\Omega$  scales give 0.001  $\Omega$  resolution. Low cost RF probe offers new capability.

Other options include rechargeable battery pack, digital printer output, deluxe test leads, 40 kV high voltage probe, 600 A. ac current probe, carrying cases, dust cover and rack mount.

Basic "best buy" \$299 DMM feature dc accuracy of 0.1%. Measure ac/dc volts from 100  $\mu$ V to 1200 V, current from 100 nanoamperes to 2 A. and resistance from 100 milliohms to 20 megohms. Guaranteed 20,000 hour MTBF.

**FLUKE**®

John Fluke Mfg. Co., Inc., P.O. Box 7428, Seattle, WA 98133

## New literature

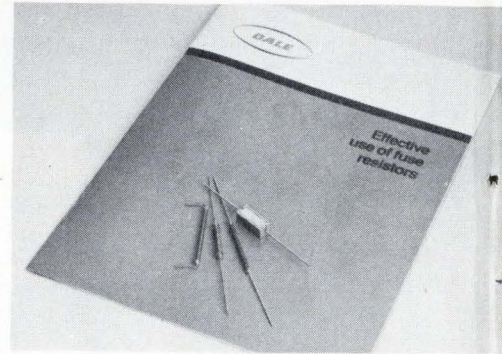

chure issued by Dale Electronics Inc., Box 609, Columbus, Neb. 68601. [426]

**Dc-to-dc conversion.** A brochure filled with specifications and performance data on miniature dc-dc conversion power-supply ICs and modules is being offered by LRC Inc., 11 Hazelwood Rd., Hudson, N.H. 03051 [427]

**Page reader.** A set of four data sheets is available from Data Recognition Ltd., Loverock Rd., Battlefarm Estate, Reading, Berks., England, covering the company's Dataterm 3 optical-mark page reader, DT311 full document buffer unit, system 8300 off-line document-reading system, and the system 8301 communications optical-mark-reader computer terminal. [428]

**Base-metal contacts.** Engelhard Industries, 430 Mountain Ave, Murray Hill, N.J. 07974. A product brochure is being offered to describe precious- and base-metal contacts, clad materials, thick films, plating solutions, brazing metals, and refining services. [429]

**Thermistors.** Bulletin L-8 describes the Hi Temp series 10,000-ohm thermistor unit manufactured by Fenwal Electronics, 63 Fountain St.,

## PINPOINT HEAT

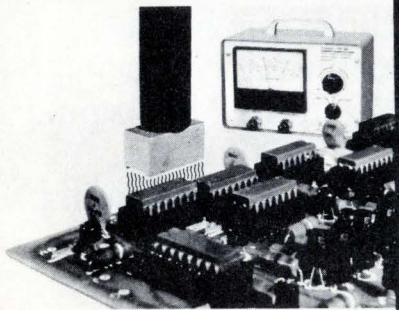

Heat any I. C. or semiconductor component to its rated temperature with a heat probe. Accuracy  $\pm 1/2^\circ\text{C}$ . Or check the component's temperature with a thermocouple probe. Accuracy  $\pm 1^\circ\text{C}$ . Model 810 Thermo-Probe does both. Reads out directly in  $^\circ\text{C}$  and  $^\circ\text{F}$  on a large 4½-inch meter. Temp. Range  $+25^\circ\text{C}$  to  $+250^\circ\text{C}$ .

PRICE \$272.50 F.O.B. South Laguna

Models with other temperature ranges available. For details write to:

**MTI MICRO-TECHNICAL INDUSTRIES**

P.O. Box 287 South Laguna, CA 92677  
(714) 545-3734

188 Circle 225 on reader service card

## Primo



**UD-876M**  
Uni-directional  
Dynamic Microphone

The UD-876M microphone is a unidirectional cardioid dynamic microphone intended for the most demanding needs of professional musicians. The dynamic cartridge used in this microphone has been designed with the needs of the performer on stage in mind.

The wind screen provides exceptional rejection of both breath blast and wind sounds.

• For catalog, write to:

**PRIMO MICROPHONE INC.**

SUITE 2207  
111 EAST WACKER DRIVE, CHICAGO, ILLINOIS  
60601, U.S.A.

TEL: (312) 565-0220, 0221  
TELEX: 25-4225 PRIMO MUS CGO

**PRIMO COMPANY LIMITED**  
6-25-1MURE, MITAKA-SHI, TOKYO, JAPAN  
TEL: 0422-43-3121~9  
TELEX: 2822-326 PRIMO J

Circle 226 on reader service card

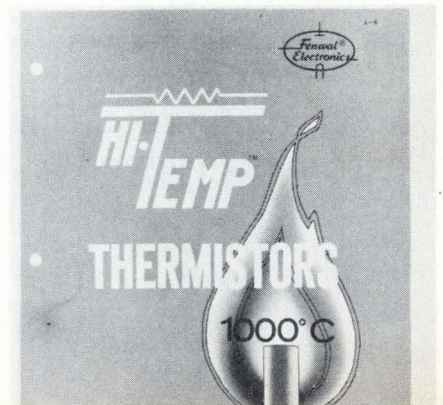

# Micaply<sup>®</sup> Substrates and Circuits

## For Thick/Thin Film Applications

### Thick/thin film resistor-conductor circuits utilizing Micaply Ohmega<sup>™</sup> Resistor-Conductor Laminates

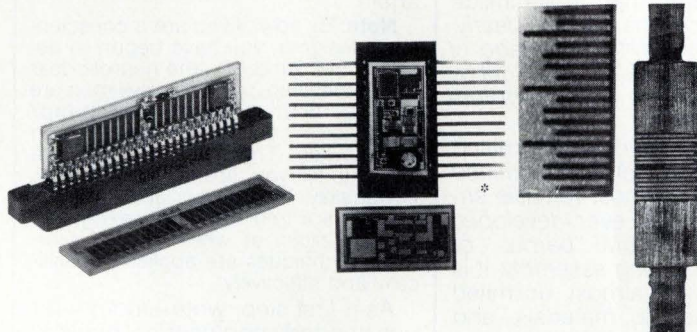

Circuits of Micaply Ohmega<sup>™</sup> offer designers a proven epoxy glass substrate with both the resistor and conductor layers completely covering the substrate on one or both sides. **Selective etching produces conductors complete with integral thin film type resistors as shown at the right.** The circuits shown above are examples of its use to replace more expensive thick/thin film resistor circuits and discrete resistor circuits.

Complete design assistance and circuit production are available. Contact us for an evaluation of your requirement and comprehensive technical literature. Find out how Micaply Ohmega<sup>™</sup> can reduce your circuitry cost.

- Much lower cost than conventional materials and processing.
- 25 or 100 ohms-per-square sheet resistivity.
- Line widths consistent with thin film microelectronic techniques.
- Subtractive etching process — no screening, firing, or vacuum equipment required.
- 10" x 36" sheets for processing economy.
- Can be easily drilled and cut.
- Can be multilayered for higher density.
- Resistors can be laser trimmed.

\*Circuits courtesy Micro Telemetry Systems

### Hybrid microcircuits utilizing Micro-Thin Copper Clad Laminates (a low cost ceramic substrate alternative)

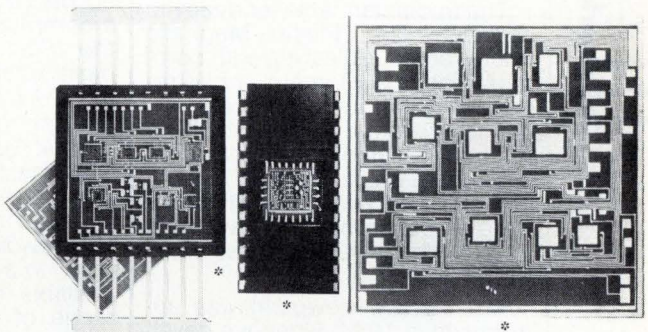

Micaply<sup>®</sup> Micro-Thin Copper Clad Laminates make possible lower cost hybrid microcircuits. Epoxy glass microcircuits like the ones shown above eliminate the cost and costly processing of ceramic in many applications. Micro-Thin is an epoxy glass laminate completely clad on one or both sides with 100 microinches of copper. Using conventional etching techniques conductors with line widths as fine as two mils can be produced.

Complete design assistance and prototype service is available. Contact us for an evaluation of your requirement and for comprehensive technical literature. Find out how Micaply<sup>®</sup> Micro-Thin can reduce your microcircuit costs.

- Much lower cost than metal coated ceramic substrates.
- 100 microinch copper clad epoxy glass.
- Can be easily drilled and cut.
- 10" x 12" sheets for processing economy.
- Etched line widths as fine as two mils.
- Can be multilayered for higher density.
- Active and passive chips are easily bonded.
- No screening, firing, or vacuum equipment required.

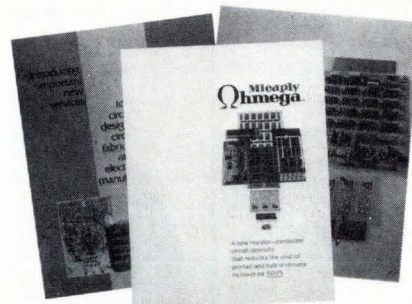
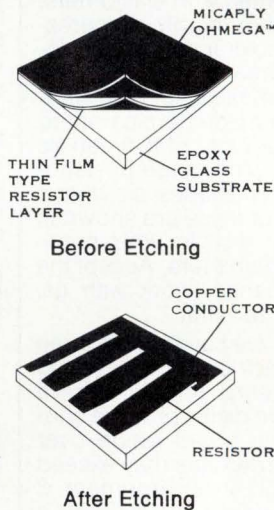

**Request complete literature on Micaply Ohmega<sup>™</sup> and Micro-thin Copper Clad Laminate materials and production services.**

The **Mica** Corporation

10900 Washington Boulevard, Culver City, California 90230, (213) 839-5282, TWX: 910-340-6365, Telex: 674999

**Micaply International, Ltd.** Silloth, Cumberland, England, Silloth 571, Telex: 64120, Cable: Micaply Silloth

# THE CREATIVE CHALLENGE:

## exploring the universe of design possibilities of engineered metallic mesh, mazes and matrices.

NO. 2

### EMI & INTERACTION SHIELDING in Computers, Process Controls, & Instruments

The understandable tendency to associate EMI (Electro-Magnetic Interference) exclusively with communications equipment—radio receivers, telephones, radar, etc., is a hangover from the days when the term "RFI" (Radio-Frequency Interference) was used; and, indeed, the earliest applications of shielding were all concerned with attempts to exclude unwanted noise from RF Circuits.

That narrow viewpoint was appropriate in 1944, when we developed the electronics industry's very first RFI gasket, but now, thirty years later, we find ourselves shielding such "high-level" devices as digital logic circuits in computers, process controls, and instruments of all kinds. *In fact, it is difficult to find a single class of electronic devices that does not require effective shielding, in some environments.*

True, the sub-microvolt front end of a communications receiver cannot function in *any* environment (except a "shielded room") without effective EMI attenuation. But anyone who has developed or applied high-density digital circuitry knows that *high-level circuitry, too, can be plagued by EMI, despite the fact that its minimum signal/noise tolerance is at least 100 times (40 dB) higher than that of communications equipment.*

It's all a matter of *environment*. The EMI source from which a communications receiver must be shielded may be a sparking commutator 8 feet away; but the backplane wiring of a digital minicomputer may be only 8 inches away from the switching regulator in its own power supply! What is more, broadband digital circuits are sensitive to noise over a much wider spectrum than tuned receiver circuits. And digital circuits are very often used in *close proximity* to other high-speed (fast-pulse) digital devices—printers, teletype-

writers, etc. In industrial environments, it is not uncommon to find broadband noise fields that are 50-60 dB stronger than those inside a communications center. *Clearly, the 100:1 sensitivity advantage of digital circuitry can be wiped out by a 1000:1 increase in environmental noise level.*

What has all this to do with knitted wire mesh? Simply this: *knitted wire mesh is the most versatile engineered material ever developed for providing the EMI "barrier," or "seal" in a shielding assembly.* It is available in an almost unlimited range of metallic materials, and can be combined with elastomers, to form resilient, highly compressible, close-tolerance, easily installed EMI seals. Mesh can be made air-permeable, for dust filtration. It can be made transparent to light—yet *opaque* to EMI. It can be supplied in a wide range of standard and custom shapes, sizes, and forms. A few of these are shown in Figure 1—but don't let your imagination bog down there. Accept the creative challenge, work with us, and the sky's the limit.

In Figure 2, we have shown three Fourier Spectra of EMI generated by environmental and interactive EMI sources in digital process controls. Note the broad range over which the interference may exceed 1 Volt. In such an environment, *it often takes weeks to "debug" a system that worked perfectly in the lab!*

And any system may, even after costly debugging, encounter a *new source* of EMI, and go sour all over again...

**Note:** By now, if you are a conscientious designer, you have begun to develop "EMI Anxiety"—the neurotic fear that somewhere out there, evil men are waiting, with megawatt/gigaband/white-noise sources, all focused on your device. These feelings, we are happy to tell you, are far from fantasy. Fortunately, help is available. METEX maintains a free EMI counselling and therapy clinic, at which knitted-wire-mesh techniques are applied—analytically and effectively.

As a first step, write—*today*—for our quarterly engineering publication, "**The Creative Challenge**"—free to engineers and designers whose responsibility includes outwitting today's troubled electromagnetic environment. You'll begin to feel better immediately... and, when our free Design Kit arrives, you will find new courage to apply the samples, photos, and data it contains.

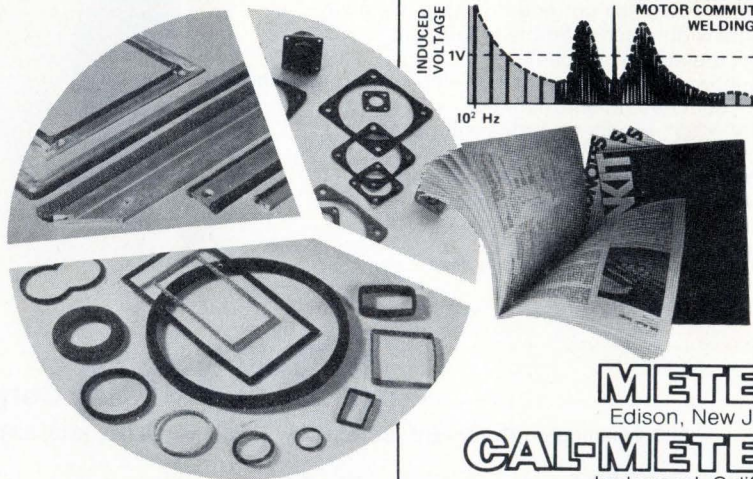
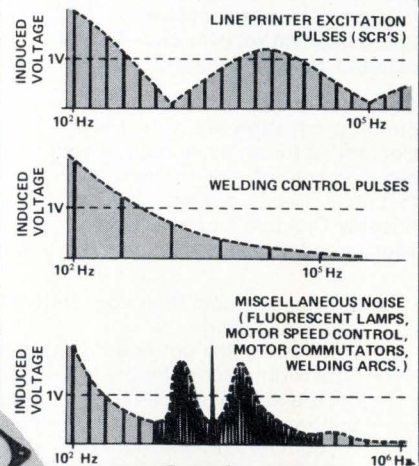

**METEX**  
Edison, New Jersey  
**CAL-METEX**  
Inglewood, California

Engineering and Production Facilities on both coasts.

## New literature

Framingham, Mass. 01701. The unit has a referenced temperature of 750°C and a tolerance on resistance of  $\pm 30\%$ . [430]

**Overvoltage.** A four-page bulletin from Heinemann Electric Co., Trenton, N.J. 08602, provides technical information on over- and under-voltage-protection devices. [431]

**Switching power supplies.** An eight-page article from RO Associates Inc., 3705 Haven Ave., Menlo Park, Calif. 94025, is entitled "Principles and Facts About Switching Power Supplies." Applications and general information are provided. [432]

**Direction-finding.** The first in a series of applications notes from American Electronic Laboratories Inc., Box 552, Lansdale, Pa. 19446, is entitled "Broadband Direction-Finding Application of Video Detectors from 500 MHz to 20 GHz." Antenna selection and signal processing are discussed, as well as general systems information. [433]

**Transistor guide.** A 24-page guide to bipolar transistors and FETs is available from Intersil, 10800 N. Tantau Ave., Cupertino, Calif. 95014. The cross-reference lists 1,162 part numbers in alphanumeric order, showing Jedec registration, and house numbers of the major suppliers. In addition, a brief description and indication of applications are given. [434]

**Data logger.** Monitor Labs Inc., 4202 Sorrento Valley Blvd., San Diego, Calif. 92121. A 16-page brochure describes the system 9400 data logger, which can also be configured for computerized data-acquisition networks. [435]

**Irradiated PVC.** Brand-Rex Co., Willimantic, Conn. 06226. A revised 12-page specification sheet is available on irradiated polyvinyl chloride, suitable for internal wiring of meters, panels, and electronic equipment, where minimum size and weight are desired. [436]

**Soldering.** Pure Alloys Inc., 69

# We chose to call our new Real-Time Spectrum Analyzer Omniscient\* and we'll continue to!

With a name like that you have to measure up, and the EMR Model 1510 does. It goes anywhere, does any job ... It's a Fourier Analyzer, a Spectrum Averager and a Display in one convenient, portable package. And most important, it performs its tasks digitally ... no interactive controls to fumble with ... no complicated computer interface problems.

**But to be Omniscient there must be more ... and there is!**

- Switch it on, it's ready to operate without calibration
- Analyze a signal repeatedly and get repeatable answers ... over and over again
- 60 dB dynamic range at the input and no gimmickry
- Foolproof LED display of signal amplitude, frequency and averaging time
- Control setting status appears on graticule of CRT for permanent photographic record
- Availability of many options ... Peak Hold, 3-D Display, Computer Interface, Low Frequency Sync, Any Window, etc.

\*Possessed of universal or complete knowledge —

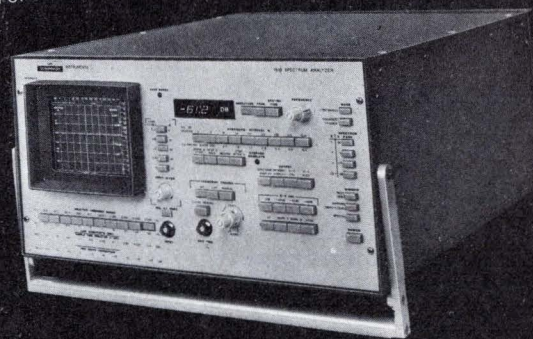

**Well... What else could we call it?**  
Write today for a comprehensive technical brochure or call for a demonstration.

**EMR** EMR  
Schlumberger

EMR Telemetry  
Weston Instruments, Inc.  
Box 3041, Sarasota, Florida 33578  
813-958-0811

Circle 191 on reader service card



**Ever Since the  
One-Tube RF-Amplifier/Detector  
Was the Hottest New Idea  
in Communications...**

If it's experience that counts in ability to design and build antenna insulators, nobody can touch Lapp! Solving problems—both electrical and mechanical—with insulators has been our business for more than 50 years.

Structural guy insulators . . . antenna strain insulators . . . base insulators for both self-supporting towers and guyed masts with strength ratings up to 9,000,000 lbs. ultimate. In fact, the bigger they are, the better off you are when you rely on Lapp's know-how.

Write for new catalog of  
Lapp RF Insulators and Assemblies:

LAPP INSULATOR DIVISION  
INTERPACE CORPORATION  
LE ROY, N. Y. 14482

Heavy-duty tower base insulators featuring triple "compression-cone" insulators

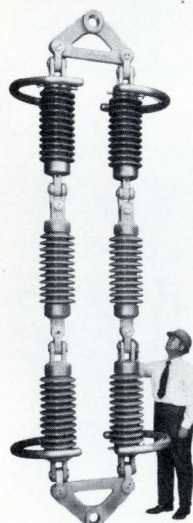

Double strain insulator assembly for radials of top-loaded vertical radiators

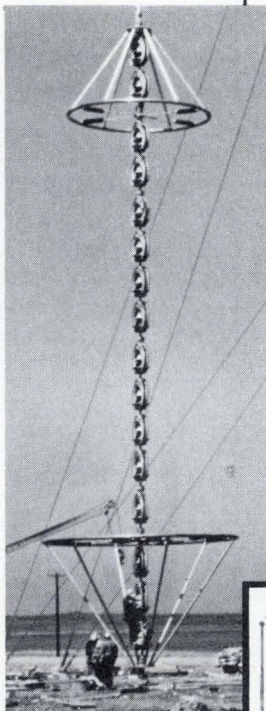

Large structural-guy insulator assembly with grading rings

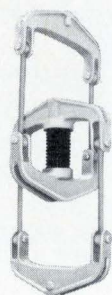

New design fail-safe structural guy insulator featuring compression post insulator, increased leakage and flashover ratings



Moderate-duty mast base insulator

**Antenna Tower  
Insulators** by

**Lapp**



**New literature**

Kinkle St., Westbury, N.Y. 11590. A four-page bulletin discusses soldering problems and solutions to overcome them. [437]

**Logic.** A 12-page booklet, number four in a series, contains information on custom integration. Included are a description of the company's integration program, secrecy procedures to protect circuit designs, logic schemes for custom ICs, and a discussion of the reliability of ICs. The booklet is available from Interdesign Inc., 1255 Reamwood Ave., Sunnyvale, Calif. 94086 [438]

**Power supplies.** Systron-Donner Corp., 1200 Shames Dr., Westbury, N.Y. 11590, has published a 52-page catalog providing specifica-

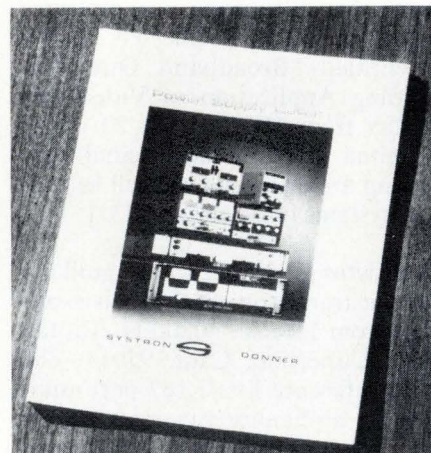

tions on more than 200 precision dc power supplies and power modules. A glossary is included. [439]

**Bulk core storage.** Fabri-Tek Inc., 5901 S. Country Rd. 18, Minneapolis, Minn. 55436. The models 4510 and 4852 bulk core storage systems, which are plug-compatible with GE-PAC 4010, 4020 and 4400 series computers and replace or augment drum systems, are described in a four-page brochure. [440]

**Portable phones.** Rf Communications, 1680 University Ave., Rochester, N.Y. 14610. The series 2810 portable telephones are described in a two-page data sheet. The brochure gives information on multichannel capabilities, power-supply selection, and frequency ranges. [361]



# A new concept in packaged power circuits as convenient as the TV dinner.



The International Rectifier PACE/pak™ is the device behind this new concept.

They are power integrated circuits, made up of SCRs, diodes, triacs, etc. which give you a complete control circuit function in a single package. And like the TV dinner, they take most of the shopping and assembly times out of the job.

But that's just the beginning of the benefits they offer.

**Smaller size.** PACE/paks (Passivated Assembled Circuit Elements) are electrically isolated up to 2.5 kV. There's no need for a separate isolated heat-sink, so you get up to 60% reduction in space requirements.

**A better designed system.** With the smaller size of these power hybrid control circuits you get more design and packaging flexibility. And since you don't have to spend time designing with discrete components, you have more time to make other improvements.

**One-fifth the assembly time.** No more do you have to assemble five to seven devices for single and 3-phase functions. With the PACE/pak there is just one part to mount, one part to interconnect with push-on or screw terminals. Your system reliability is higher, too.

Just think of the other savings you can make in testing, inspection and field servicing.

**Lower inventory costs.** We estimate a 7-to-1 reduction in inventory, plus savings in procurement time and costs. Standard PACE/pak circuits now cover 90% of single-phase power circuit requirements, with more in development for 3-phase applications.

They are available as standards with 25 or 42.5 Amp current ratings, in either 120 or 230 Volt RMS versions.

Find out how PACE/paks will revolutionize your designs like dc motor controls, inverters, chopper drives, generator exciters, solid-state circuit breakers, battery chargers and variable dc power supplies.

Call your local IR sales office for details or contact the factory: *International Rectifier* • 233 Kansas Street, El Segundo, CA 90245 • (213) 678-6281 • TELEX: 67-4666.

## International Rectifier

... the innovative power people



Circle 193 on reader service card

# Energy Saver



## **NEW** ELECTRONICS BUYERS' GUIDE... EASY-TO-USE, SINGLE VOLUME SOURCE FOR:

- Information on over 4,000 products.
- Over 6,000 company listings and phone numbers — both home and field offices.
- **EBG EXCLUSIVE:** quick access to over 800 helpful catalogs through a timesaving Direct Inquiry service.
- More than 1,400 pages of data.

Here is the international world of electronics at your fingertips. Find suppliers... fast... accurately... and locally! Don't have a copy? Use coupon below, today.

### **Electronics Buyers' Guide**

A McGraw-Hill Publication  
1221 Ave. of the Americas, New York, N. Y. 10020

Yes, send me \_\_\_\_\_ copies (copy) of the energy saving Electronics Buyers' Guide. I've enclosed \$15.00 (USA and Canada only; elsewhere send \$25.00). Full money back guarantee if not satisfied.

NAME \_\_\_\_\_  
COMPANY \_\_\_\_\_  
STREET \_\_\_\_\_  
CITY \_\_\_\_\_  
STATE \_\_\_\_\_ ZIP \_\_\_\_\_

## **New Books**

**Electronics in the Life Sciences**, Stephen Young, Halsted Press, John Wiley & Sons, 198 pp., \$11.50.

As its title indicates, this is a book for engineers interested in the biological or medical aspects of engineering. A major problem often encountered in developing electronic systems in such new fields is the level of sophistication to be used. This arises because there is a lack of intuition concerning which parameters are important, which require close control, and what the state of the measurement art is. The tendency is to apply electronic overkill to a particular problem, which, in addition to adding time and expense to a particular project, often doesn't do the job.

Stephen Young's little monograph can give the engineer an insight into how biologists think about electronics and what types of measurements and measurement problems they encounter. The level of electronics is relatively simple. The author spends almost half the book describing such basic laboratory instruments as the oscilloscope, the power supply, and the multimeter. The last half of the book is spent describing data-logging, controlling stimuli and measuring response with available transducers, automated experiments, and digital electronics.

It is the final chapters of the book that are of significant value. Here Young suggests modifications and ways of increasing the sophistication of experiments, and he explains the means of making and interpreting biological measurements.

The value of this work is as much in what isn't said as what is. The book isn't very detailed, yet it describes relatively sophisticated experimental setups. The text is well written, and it is of more value to a person getting started in the field than to one working in it. In brief, it provides an introduction to electronics in biology which allows an engineer to get to work before becoming benumbed by the sophisticated treatises one reads to become an expert in one area of the field.

—Joel DuBow  
Components Editor

# ZENER DIODE

# WALL CHART from DICKSON

When it comes to Zeners, Dickson has your number and then some. And, they are all included on this handy wall chart selection guide.

From low-cost commercial to highly sophisticated, ultra-reliable applications, Dickson has the exact voltage regulating (Zener) or reference (TC) diode you need. And, even if it's one of our .11¢ devices, you have the assurance that every Dickson zener has the quality that can only come from the leader in hi-rel devices.

Dickson offers 48 popular JEDEC series, plus thousands of custom or

proprietary devices in one of the most extensive lines of commercial and military zeners available. With this product versatility, it's no wonder Dickson is looked upon as the preferred Zener House by a continually growing number of major equipment and systems manufacturers. If you use Zeners, consider the extra quality and fast-service benefits you'll receive from "the specialists"...Dickson.

#### ZENER WALL CHART

For your copy, simply drop us a note on your letterhead.

"The Specialists"



**DICKSON**  
ELECTRONICS CORPORATION

*a member of the Siemens group*

P.O. BOX 1390 • 8700 EAST THOMAS ROAD  
SCOTTSDALE, ARIZONA 85252  
PHONE 602-947-2231 • TWX 910-950-1292

# SEARCHLIGHT SECTION

- CLASSIFIED ADVERTISING
- BUSINESS OPPORTUNITIES
- USED OR SURPLUS EQUIPMENT

## AUTOTRACK MOUNT

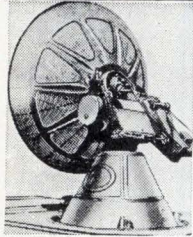

### AUTOTRACK SCR-584 RADARS

360 degree azimuth, 210 degree elevation sweep with better than 1 mil. accuracy. Missile velocity acceleration and slewing rates. Amplidyne and servo control. Will handle up to 20 ft. dish. Supplied complete with control chassis. **ALSO** in stock 10 cm. van mounted radar system. Conical scan. PPI. 6 ft. dish. Ideal for S band telemetry, weather, balloon trk.

missile trk, rocket trk, ECM range. Write for complete data. 600 pg. instr. bk. avail. at \$25 ea.

### 1 MEV LINEAR ACCELERATOR

Dual Mode, Ion or Electron. RF Drive, 300 KHZ at 45 KW. Includes control console, RF unit, accelerator, etc.

### MOD IV HIGH RESOLUTION TRACKER

Instrumentation radar; freq. 8.5-9.6 GHz, Pwr: 250 KW. .1 mil tracking accuracy. 6' Fresnel lens antenna with 4 horn monopulse feed. Tracking range 50 or 200 miles. Formerly used as range safety radar at Cape Kennedy.

### PULSE MODULATORS

245 KW LINE PULSER Output 16 KV at 16 amp. .25  $\mu$ s at 4000 PPS.

405 KW FLOATING DECK PULSER Output 20 KV at 20 amp. 1  $\mu$ s to 10 millsec pulse.

500 KW LINE PULSER Output 22 KV at 28 amp. 4/1.75/2.25  $\mu$ s at 2500/550/300 PPS.

1 MW HARDTUBE MIT MODEL 9 Output 25 KV at 40 amp. .25-2  $\mu$ s at .002 D.C.

2.0 MW LINE PULSER Output 30 KV at 70 amp. 1/2  $\mu$ s at 600/300 PPS.

3 MW LINE PULSER Output 39 KV at 75 amp. 25/1  $\mu$ s at 500 PPS.

10 MW LINE PULSER Output 76 KV at 135 amp. 2.5  $\mu$ s at 350 PPS.

17 MW LINE PULSER Output 17 KV at 1000 amp. 2-5  $\mu$ s at 150-2600 PPS.

### HV POWER SUPPLIES

6.3 KV @ 5 Amp; 20KV @ 1.3 Amps; 35KV @ 1.5 Amps; 28KV, 70MA; 12KV @ 800MA

18KV @ 2.25 Amps; 17.5KV @ 1.8 Amps.

HUNDREDS MORE IN STOCK  
LARGEST RADAR  
INVENTORY  
IN WORLD.  
WRITE  
FOR  
CATALOG  
ON YOUR  
LETTERHEAD

## RECON DRONE CONTROL RADARS

X Band systems autotrack and search complete with plotting boards. Fully mobile van mounted. Gives PPI, slant range, altitude data. Ground to air control links and beacons also in stock. AN/MPQ-29 & AN/UPW-1

### RADAR DATA MICROWAVE LINK

Freq. 7.1-7.9 GHz, Pwr. 100 mw., 4 channels. Transmits video, pulse, synchro, and voice information. Mfr: Motorola.

### SPARE PARTS IN STOCK

Nike Ajax, Nike Hercules, M-33, MPS-19, TPS-ID, TPS-10D, FPS-6, SPS8, SCR-584, HIPAR.

### RADAR & RF PKGS.

34ghz 40kw Pulse RF pkg

24ghz 40kw Pulse bomb toss system

16ghz 130 kw Pulse B-58 search radar system

X BAND SEARCH 40 KW PULSE WEATHER RADAR

X BAND AUTOTRACK 250KW PULSE M-33

compl w / plot boards

X BAND BEACON 400 W PULSE AN/DPN-62

X BAND AUTOTRACK 50KW PULSE B-47

fire control complete

C BAND WEATHER RADAR 250 KW PULSE

C BAND HEIGHT FINDER

AN/FPS-26 5 megawatt output.

AN/TPS-37, 1 megawatt output.

C BAND 1 MEGAWATT AUTOTRACK

10ft dish mortar locator MPQ-21

C BAND 285KW PULSE Search AN / SPS-5

S BAND AUTOTRACK 500 KW PULSE 10' DISH

S BAND 1 MEGAWATT COHERENT AN / FPS-18

S BAND 1 MEGAWATT PULSE NIKE ACQ.

S BAND 5 MEGAWATT HEIGHTFINDER AN/FPS-6

S BAND BEACON 1 KW PULSE

L BAND 500KW PULSE AN / TPS-ID / E

L BAND 5 to 20KW PULSE

400mhz 1KW CW AN / FPS-23

225mhz 1 MEGAWATT PULSE AN/TPS 28

2-30mhz 100KW PULSE

CW 950-5ghz 150 WATTS

CW 1.5mhz-10.5ghz 5 WATTS

CW 7.4 GHZ 2 KW

AN / GPG-1 SKYSWEEP TRACKER

3 cm. auto. tracking radar system. Comp. pkg. w / indicator sys. Full target acquisition & auto. tracking. Input 115v 60 cy. new.

In stock for immed. del. Entire sys. 6'x 3' x 10'. Ideal for infrared tracker, drone tracker, missile tracker. R & D.

## free catalog

### POTTING APPLICATORS MANUAL OR AIR OPERATED

2 1/2cc 6cc 12cc 30cc  
FOR POTTING, ENCAPSULATING ETC.

**PHILIP FISHMAN CO., INC.**  
7 CAMERON ST. WELLESLEY, MASS. 02181

CIRCLE 956 ON READER SERVICE CARD

## EMPLOYMENT OPPORTUNITIES

Send New Ads to:  
Electronics  
Class. Adv. Dept.  
P.O. Box 900, N.Y., N.Y. 10020

## POSITIONS VACANT

Positions Available-Electrical & Electronic Eng's. Over 1000 US client co's pay our fees for selected technical referrals. Est. 1959. Send resume with pres. sal. Atomic Personnel, Inc., Box L, 1518 Walnut St., Phila., Pa. 19102.

## EMPLOYMENT SERVICES

Growth Positions, \$14-30,000. Fees Paid. Nationwide. Longberry of Pittsburgh. Suite 962-G, Two Gateway Center, Pittsburgh, Pa. 15222.

## SAME DAY SHIPMENT Minis & Peripherals

### PDP SPECIALISTS 8, 8I, 8L & 11

### NEW 300 LPM PRINTERS

### PDI CARD READERS

### BRPE PUNCHES

\$750 Minis

### TELETYPE 35 & 37 DEC & HONEYWELL Modules 617/261-1100

Send for Free Report "Maintenance of Computers"

**AMERICAN USED COMPUTER CORP.**  
P.O. Box 68, Kenmore Sta., Boston, MA 02215  
member COMPUTER DEALERS ASSOCIATION

CIRCLE 952 ON READER SERVICE CARD

## 1974 BOOK CATALOGUE

Over 2500 titles. A wide range of authors writing on every conceivable subject from Abbott: *Flatland* to Zwicker: *Advanced Geometry of Plane Curves*. List includes more than 500 Scientific and Technical paperbacks at prices you can afford.

H. SHPRENTZ CO., Box 83EB, Irvington, NY 10533

CIRCLE 953 ON READER SERVICE CARD

## HERMETIC SEALING

GLASS/CERAMIC TO METAL  
CONNECTORS • HEADERS  
CUSTOM SEALS

1 C FLAT PACKS • RELAY BASE  
FEED THRU TERMINALS  
TESTING SERVICES

Hermetic Sealing Since 1959

### DETRONICS Corporation

10660 E. Rush, S. El Monte, CA. 91733  
(213) 579-7130—TWX 910 587-3436

## FREE CATALOG

### HARD-TO-FIND PRECISION TOOLS

Lists more than 2000 items—pliers, tweezers, wire strippers, vacuum systems, relay tools, optical equipment, tool kits and cases. Also includes ten pages of useful "Tool Tips" to aid in tool selection.

**JENSEN TOOLS**  
4117 N. 44th Street, Phoenix, Ariz. 85018

CIRCLE 954 ON READER SERVICE CARD

## FREE ALARM CATALOG

Full line of professional burglar and fire alarm systems and supplies. 96 pages, 450 items. Off the shelf delivery, quantity prices.



mountain west alarm  
4215 n. 16th st., phoenix, az. 85016

Q. Whom do I contact or call to renew my classified ad or make corrections?

A. Write Electronics, Class. Adv. Dept., P.O. Box 900, NY, NY 10020 or call: (212) 997-6585 or 6586. Give full company name, size of ad, & date or dates it is scheduled to appear.

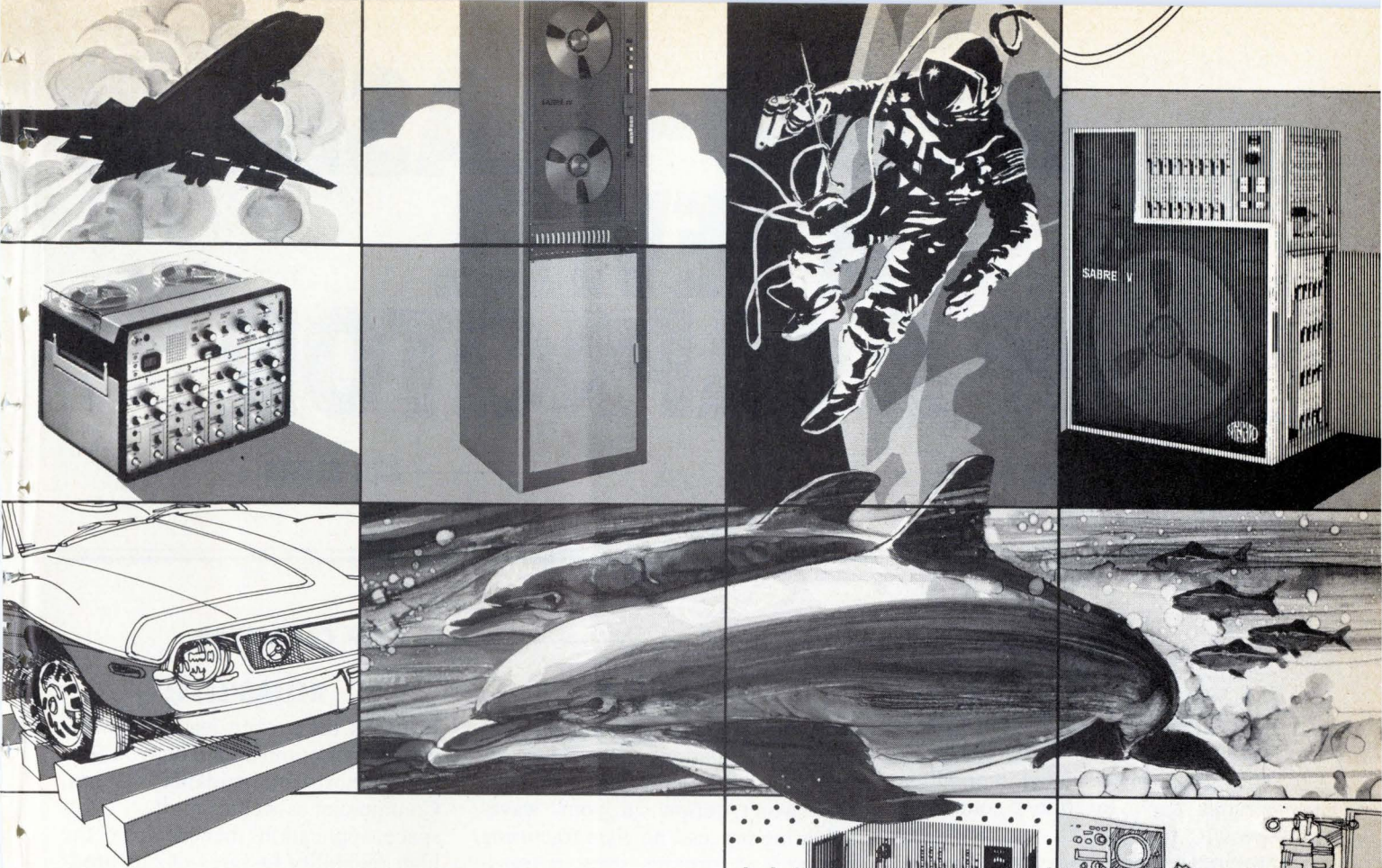

# Sangamo makes recorders with enough channels for space science and enough economy for hospital labs.

If you need 48 channels of data, we build the only IRIG all-band tape recorder on the market—the Sabre IV.

If you are in the life sciences and need an efficient economical recorder for less than \$5,000, you can buy a Sangamo/Tandberg TIR model that does almost everything a \$16,000 recorder can do. And it's no bigger than a breadbox.

Between the two extremes are the Sabre III, the all-band 7 and 14 channel portable, featuring laboratory quality, and the Sabre V, the most advanced portable 28 or 32 channel recorder/reproducer available.

That's a wide range of capabilities. An even wider range of prices. The one thing that never varies is the quality. Sangamo recorders do the best job on every job. Including yours.

For details write: Sangamo Electric Company, Data Systems, P.O. Box 3347, Springfield, Illinois 62714, or call (217) 544-6411/Telex 406-421. Sales and Service Representatives World Wide.

**SANGAMO RECORDERS**  
THE INNOVATORS IN TAPE INSTRUMENTATION

# MONO-GLASS... A JEWEL OF A CAPACITOR

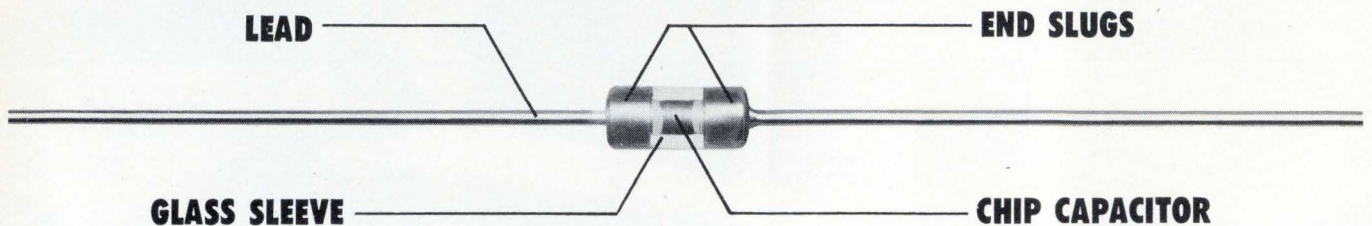

U.S. Capacitor Corp. has done something elegant for high volume capacitor users . . . MONO-GLASS.

This glass encapsulated monolithic ceramic capacitor offers something special: for the Design Engineer looking for cost reduction and dependability; for the purchasing agent looking for low price with fast delivery; for the incoming Q.C. inspector who is looking for reliability.

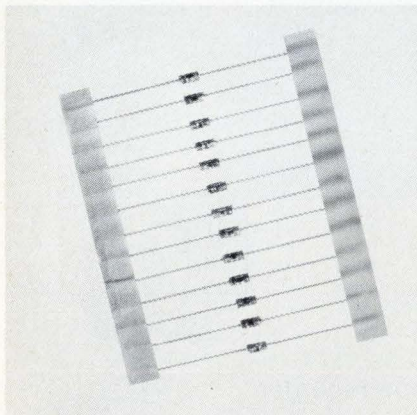

## AUTOMATIC INSERTION:

If you use it, you know the substantial savings in time and cost. MONO-GLASS is designed for automatic insertion with the same equipment used for diodes and resistors. Reel packed and ready for your machines.

## DURABILITY:

Our hermetically sealed, glass-to-metal construction offers these advantages: solderless internal contacts that won't reflow in your wave-soldering process; no glass fracturing during lead forming—stress is transferred to the end slugs rather than the glass sleeve.

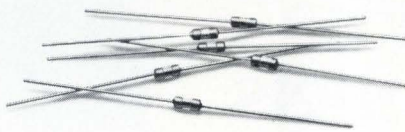

## HIGH VOLUME; LOW PRICE

USCC's production capability for chip capacitors is second to none. MONO-GLASS is produced by a simple assembly technique. Combine these two and you get the best possible delivery for high quantity requirements, at a budget price.

## WIDE SELECTION:

Four case sizes are available . . . .200 x .100; .250 x .100; .300 x .150 and .400 x .150. The 50 and 100 WVDC units offer up to .01 mfd in COG dielectric, to .18 in X7R and up to 1.0 mfd in the Y5V dielectric.

## RELIABILITY:

USCC is the proven leader in state-of-the-art, demonstrated on N.A.S.A. life support and guidance systems. Commercial as well as military aerospace applications benefit from the high reliability features of our products—the best available.

MONO-GLASS is our lowest priced ceramic axial lead capacitor, offering a new quality capability for communications, navigation and guidance, computer business machines or anywhere that high volume, low price is required.

Write or call for an evaluation sample, more technical data or applications help for your special requirements. Remember, USCC-Centralab.



**USCC/Centralab**

Electronics Division ■ Globe-Union, Inc.

2151 North Lincoln Street ■ Burbank, California 91504  
(213) 843-4222 ■ TWX: 910-498-2222



# Electronics advertisers

June 13, 1974

<b>Abbott Transistor Labs, Inc.</b> Technical Adv. Agency	6	<b>Dickson Electronics Corporation</b> N. A. Winter Advertising Agency	195	<b>LH Research, Inc.</b> Van Der Boom, McCarron, Inc., Advertising	2
* <b>Adret Electronique</b> Psycho Publicite	2E	<b>Digital Equipment Corporation</b> Creamer, Trowbridge, Case & Basford, Inc.	111,134-135	* <b>LTT</b>	10E
<b>Advanced Memory Systems, Inc.</b> Robert A. Schlottfeldt	136	<b>Dow Corning Industrial</b> Ketchum, MacLeod & Grove, Inc.	141,138-139	<b>Master Appliance</b> Jack Crowe Studio Advertising	162
<b>Advanced Micro Devices</b> Keys/Donna/Pearlstein	10-11	‡ <b>Eastman Kodak Company, Business Division, Engineering Data System, Micrographics Business Systems Markets Div.</b> J. Walter Thompson Co.	15	■ <b>Metex Corp.</b> Sommer Agency, Inc.	190
<b>Alco Electronic Products, Inc.</b> Marketronics Advertising	202	<b>E-H Research Laboratories, Inc.</b> Hal Lawrence, Inc.	51	<b>The Mica Corporation</b> Robert A. White Advertising	189
<b>Allen Bradley Company</b> Hoffman, York, Baker & Johnson, Inc.	34	<b>Electronic Memories and Magnetics Corporation</b> S. Michelson Advertising	170-171	<b>Micro Power Systems</b> Associated Ad Ventures, Inc.	79
<b>American Optical Scientific Instrument Division</b> Wilson, Haight & Welch, Inc.	183	■ <b>EL Instruments, Inc.</b> Langeler-Stevens, Incorporated	142	<b>Micro Technical Industries</b> R.E. Sylvester Advertising Agency	188
<b>AMF/Potter &amp; Brumfield Division</b> Fuller & Smith & Ross, Inc.	68-69	<b>Emr-Telemetry</b> Carol Marketing Associates	191	<b>Monroe, The Calculator Company Division of Litton Industries</b> Hartel, Catliano & Assoc., Inc.	168-169
<b>Amperex Electronic Corp.</b> Sam Broden, Incorporated	28	* <b>English Electric Valve Co., Ltd.</b> The London Advertising Partnership	8E-9E	<b>MOS Technology, Inc.</b> Henry S. Goodsett Advertising, Inc.	5
<b>Analog Devices, Inc.</b> Schneider Parker, Inc.	112	<b>Exact Electronics</b> Hugh Dwight Advertising	164	■ <b>Motorola Semiconductor</b> Graham & Gillies Limited	145
‡ <b>Anslay Electronics Corp.</b> S. Michelson Advertising	67	<b>Exar Integrated Systems</b> Diversified Corporate Services, Inc.	58	<b>Motorola Semiconductor Products, Inc.</b> E.B. Lane & Associates, Inc.	70-71,103
<b>Anzac Electronics</b> Ken Puleo Advertising	164	‡ <b>Ferrocube</b> Black-Russell-Morris	145	■ <b>Narda Microwave</b> McCarthy, Scelba, DeBiasi Advertising Agency, Inc.	153
<b>Associated Environmental Systems, Inc.</b> A. D. Adams Advertising, Inc.	164	■ <b>Fluke Manufacturing Co., John Bonfield Associates</b>	188	■ <b>Nelson Ross Electronics, Div. Polarad Electronics</b> McCarthy, Scelba, DeBiasi Advertising Agency, Inc.	202
<b>Atlan-Tol Industries, Inc. AM-MET Division</b> Michael London Associates	154	<b>Fluke Trendar</b> Lincoln Associates, Inc.	27	* <b>Oscilloquartz SA, Neuchatel</b> M.R. Hofer Werbeagentur BSR/EAAA Bern	24E
■ <b>Augat</b> Creamer, Trowbridge, Case & Basford, Inc.	163	<b>General Instrument Corporation, Microelectronics Div.</b> Norman Allen Associates, Inc.	9	<b>PGP Industries, Inc.</b> Centormedia, Inc.	52
<b>Ballantine Laboratories, Inc.</b> MLF Graphics	182	* <b>General Instrument Europe S.P.A.</b> Studio Sigismondi	12E	* <b>Philips Elcoma</b> Intermarco nederland	55
‡ <b>Beckman Instruments, Inc., Helipot Div.</b> N. W. Ayer/Jorgensen/MacDonald, Inc.	129	<b>General Magnetics</b> McCarthy/Scelba/DeBiasi Adv. Agy., Inc.	3rd Cover	* <b>Philips N.V. Pit/T &amp; M Division</b> Broekies Communications Systems SA	64
‡ <b>Beckman Instruments, Inc. Information Displays Operations</b> N. A. Winter Advertising Agency	55	* <b>General Radio</b> Grad Associates	5E	<b>Plessey Chatsworth</b> Hall Butler Blatherwick, Inc.	143
‡ <b>Bourns, Inc.</b> Marlborough Assoc., Inc.	72,157	■ <b>Gould, Inc./Instrument Systems Div.</b> Carr Liggett Adv., Inc.	146-147	* <b>Plessey Semiconductors</b> Creative Workshop Ltd.	11E,13E
<b>Brand-Rex</b> Creamer, Trowbridge, Case & Basford, Inc.	158	‡ <b>GET Sylvania-Eastern Division</b> Allied Advertising Agency, Inc.	64	‡ <b>Precision Monolithics, Inc.</b> Marlborough Associates, Inc.	148
<b>Burroughs Corp.</b> Conti Advertising Agency, Inc.	53	<b>GTI-Dix Engineering</b> Market Finders	90	<b>Primo Co., Ltd.</b> General Advertising Agency, Inc.	188
* <b>Cambridge Thermionic Corporation</b> Chirug and Cairns, Inc.	67	<b>Hansen Mfg. Co.</b> Keller-Crescent Co.	155	<b>Programmed Power Inc.</b> Moser & Associates	167
‡ <b>Centralab Electronics Div., Globe-Union, Inc.</b> Action Communicators	56-57	‡ <b>Harris Semiconductor</b> Tucker Wayne & Company	12-13	<b>Pro-Log Corporation</b> Kassler Noble Advertising	159
* <b>Centre Engineering</b> Williams & Associates	22E	■ <b>Heath/Schlumberger Scientific Instruments</b> Advance Advertising Services	192	* <b>Radiometer Copenhagen</b>	129
<b>CERAMASEAL, INCORPORATED</b> Winard Advertising Agency, Inc.	152	<b>Hermes Electronics, Ltd.</b> Public & Industrial Relations Limited	180	* <b>RCA Electronic Components</b> Al Paul Lefton Company, Inc.	15
<b>Circuit-Stik, Inc.</b> Haaga Advertising	156	■ <b>Hewlett-Packard</b> Corporate Marketing Communications	17-26	<b>RCA-Solid State Division</b> Marsteller, Inc.	82-83
■ <b>Clairex Corporation</b> Black-Russell-Morris	4th Cover	■ <b>Honeywell Test Instrument Division</b> Campbell Mithun, Inc.	142	■ <b>RCL Electronics, Inc.</b> Morvay Advertising Agency	14
<b>Clare Electronics</b> Markcom	185	<b>Hughes Aircraft Company</b> Foote, Cone & Belding	38	* <b>Rifa</b> MK Marknadskommunikation AB	17E
<b>Comstron Corporation</b> Reinish Advertising & Marketing Associates, Inc.	88	<b>Hutson Industries</b> Greene, Webb Associates, Inc.	149	<b>Rochester Gas &amp; Electric Corp.—Ad Group</b> Hutchins/Darcy, Inc.	202
■ <b>Concord Electronics Corp.</b> Sound Advertising	154	<b>Industrial Electronic Engineers</b> Olympus Agency	172-173	* <b>Rohde &amp; Schwarz</b>	1E
■ <b>Cornell-Dubilier Electronics</b> McCarthy, Scelba, DeBiasi Advertising Agency, Inc.	45,47	<b>Intel Corp.</b> Regis McKenna, Inc.	32-33	<b>Sangamo Electric Co.</b> Batz-Hodgson-Neuwoehner, Inc.	197
■ <b>Curtis Instruments, Inc.</b> Marc Dorian, Inc.	30	<b>International Rectifier Corp., Semiconductor Division</b> William E. Wilson Company	193	<b>Schauer Manufacturing Corp.</b> Nolan, Keelor & Stites	181
* <b>Dale Electronics, Inc.</b> Swanson, Sinkey, Ellis, Inc.	130-131	<b>C. Itoh &amp; Co. (America) Inc.</b> AC & R Advertising Inc.	160	<b>Sensors, Inc.</b> Industrial Marketing Studios	182
<b>Damon/Electronics Division</b> Giardini/Russell, Inc.	152	<b>ITT Semiconductors</b> Hall & McKenzie Advertising	174-175	* <b>Sescosem</b> Bazaine Publicite	57,62
<b>Data General Corporation</b> Scali, McCabe, Sloves, Inc.	176-177	<b>Keithley Instruments, Inc.</b> Chagrin Valley Marketing Associates	81	* <b>SGS-ATES</b> McCann-EricksonPeyg	19E-20E
■ <b>Data Precision</b> Allied Advertising Agency, Inc.	127	■ <b>Kepeco Inc.</b> Weiss Advertising	1	* <b>Showa Musen Kogyo Co. Ltd.</b> General Advertising Agency, Inc.	18E
<b>Datawest Corporation</b> Kounter Graphics	119	* <b>Kistler Instruments AG</b> Atelier fur Werbung	21E	<b>Siemens AG</b> Linder Presse Union GmbH	201
<b>Diacon</b> Rogondino Advertising and Marketing	186	<b>Kurz-Kasch, Inc.</b> David K. Burnap Advertising	85	<b>Siemens Corporation</b> Stiefel/Raymond Advertising Inc.	74
■ <b>Dialight Corporation</b> Michel-Cather, Inc.	87	■ <b>Lapp Insulator Div., Interpace Corp.</b> Wolff Associates, Inc.	80	<b>Siemens Corp.—Electronics Systems Division, Computest Products</b> JL Associates	179
				<b>Signalite, Inc.</b> McCarthy, Scelba, DeBiasi Advertising Agency, Inc.	151

# THERMISTORS BY THERMOMETRICS

**BEADS  
PROBES  
FLAKES  
RODS  
ASSEMBLIES**

obtain state-of-the-art performance at costs lower than your present commercial products

**SPECIAL CURVE MATCHES  
HIGHEST STABILITY  
0.05% TOLERANCES &  
INTERCHANGEABILITY  
PRECISION CALIBRATION  
FAST RESPONSE  
ASSEMBLIES (TO 3MS)**



**THERMOMETRICS INC.**

15 JEAN PLACE  
EDISON, N.J. 08817  
(201) 548-2299

Circle 200 on reader service card

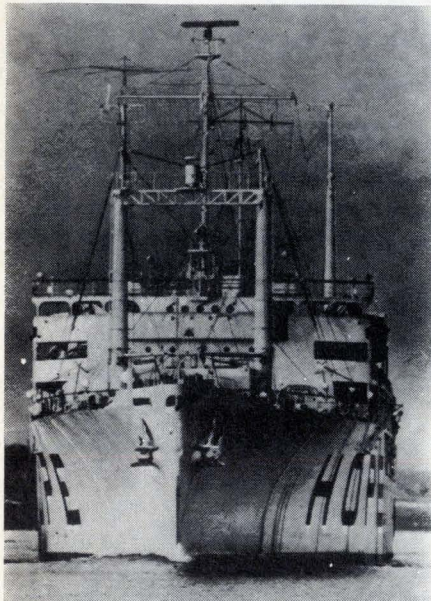

## S.S. HOPE, M.D.

Doctor . . . teacher . . . friend to millions on four continents—this floating hospital is a symbol of America's concern for the world's disadvantaged. Keep HOPE sailing.

**PROJECT  
HOPE**

Dept. A, Washington, D.C. 20007

<b>Signetics Corp., Sub. of Corning Glass Works</b> Hall Butler Blatherwick, Inc.	30-31
<b>Siliconix</b> Robertson West, Inc.	107
<b>Sinclair Radionics</b> David, Oksner & Mitchneck, Inc.	120-121
<b>Singer Company, Kearfott Div.</b> Gaynor & Ducas, Inc.	161
* <b>SMK Europe</b>	24E
* <b>Sodeco-SAIA</b> PR Service	49
* <b>Spectrol Reliance Limited</b> J M R Advertising	6E-7E
* <b>Sprague</b> Perez Publicite	14E-15E
<b>Sprague Electric Company</b> Harry P. Bridge Company	8
<b>Sprague-Goodman Electronics, Inc.</b> Herbert Lindaur Associates	156
<b>Systron-Donner Computer Systems Division</b> Fred Schott Associates	61
■ <b>Tektronix Inc.</b> McCann Erickson, Inc.	29
<b>Teledyne Philbrick</b> Ingalls Associates, Inc. Advertising	2nd Cover
<b>Teletype</b> N.W. Ayer & Son, Inc.	187
* <b>C. Tennant Sons &amp; Co.</b> A.D. Adams Advertising Inc.	4E
<b>Texas Instruments Incorporated, Semiconductor Group</b> Tracy-Locke Advertising Inc.	73
<b>Thermalloy</b> Warren-Guild	181
<b>Thermometrics, Inc.</b> H. & M. Associates, Inc.	200
<b>Thomson CSF</b> Bazaine Publicite	165
■ <b>TRW / Globe Motors</b> Odiome Industrial Advertising, Inc.	166
■ <b>TRW Electronics, Semiconductor Division</b> The Bowes Company	7
* <b>Ultra</b> Dennis Dolling Limited	23E
■ <b>Union Carbide Corp.</b> J.J. Lane, Inc.	77
<b>United Systems Corp., A Sub. of Monsanto Co.</b> Advertising & Merchandising, Inc.	43
■ <b>Unitrode Corporation</b> Culver Advertising	37
<b>U.S. Capacitor Corp.</b> S. Michelson Advertising	198
<b>Utah Industrial Promotion Division</b> Harris & Love, Inc. / Advertising	144
<b>Varo Semiconductor, Inc.</b> Warren-Guild	167
* <b>Wandel und Goltermann</b> Werbeagentur	12-13
<b>Wavetek San Diego</b> Chapman Michetti Advertising	132
<b>Wima, Westermann</b> Oliver-Beckmann GmbH	16
‡ <b>Yewtec Corporation</b> Kenmarc Advertising, Inc.	49
<b>Yokogawa Electric Works, Ltd.</b> General Advertising Agency, Inc.	184
‡ <b>Carl Zeiss, Inc.-Micro</b> Michel Cather	130-131

### Classified & Employment Advertising

F.J. Eberle, Manager 212-997-2557

<b>EQUIPMENT (Used or Surplus New) For Sale</b>	
American Used Computer Corp. ....	196
Deterionics Corp. ....	196
P. Fishman Co., Inc. ....	196
Jensen Tools and Allehs ....	196
Mountain West Alarm Supply Co. ....	196
Radio Research Instrument Co. ....	196
H. Shprentz Co. ....	196

■ For more information on complete product line see advertisement in the latest Electronics Buyer's Guide  
\* Advertisers in Electronics International  
‡ Advertisers in Electronics domestic-only edition

### Advertising Sales Staff

**Pierre J. Braudé** New York [212] 997-3468  
London 01-493-1451  
Director of Marketing

**Atlanta, Ga. 30309:** Joseph Lane  
100 Colony Square, 1175 Peachtree St., N.E.  
[404] 892-2868

**Boston, Mass. 02116:** James R. Pierce  
607 Boylston St. [617] 262-1160

**Chicago, Ill. 60611:**  
645 North Michigan Avenue  
Robert W. Bartlett (312) 751-3739  
Paul W. Reiss (312) 751-3738

**Cleveland, Ohio 44113:** William J. Boyle  
[716] 586-5040

**Dallas, Texas 75201:** Charles G. Hubbard  
2001 Bryant Tower, Suite 1070  
[214] 742-1747

**Denver, Colo. 80202:** Harry B. Doyle, Jr.  
Tower Bldg., 1700 Broadway  
[303] 266-3863

**Detroit, Michigan 48202:** Robert W. Bartlett  
1400 Fisher Bldg.  
[313] 873-7410

**Houston, Texas 77002:** Charles G. Hubbard  
2270 Humble Bldg. [713] CA 4-8381

**Los Angeles, Calif. 90010:** Robert J. Rielly  
Bradley K. Jones, 3200 Wilshire Blvd., South Tower  
[213] 487-1160

**New York, N.Y. 10020**  
1221 Avenue of the Americas  
Warren H. Gardner [212] 997-3617  
Michael J. Stoller [212] 997-3616

**Philadelphia, Pa. 19102:** Warren H. Gardner  
Three Parkway,  
[212] 997-3617

**Pittsburgh, Pa. 15222:** Warren H. Gardner  
4 Gateway Center, [212] 997-3617

**Rochester, N.Y. 14534:** William J. Boyle  
9 Greylock Ridge, Pittsford, N.Y.  
[716] 586-5040

**San Francisco, Calif. 94111:** Don Farris  
Robert J. Rielly, 425 Battery Street,  
[415] 362-4600

**Paris:** Alain Offergeld  
17 Rue-Georges Bizet, 75 Paris 16, France  
Tel: 720-73-01

**Geneva:** Alain Offergeld  
1 rue du Temple, Geneva, Switzerland  
Tel: 32-35-63

**United Kingdom & Scandinavia:** Keith Mantle  
Tel: 01-493-1451, 34 Dover Street, London W1

**Milan:** Robert Saidel  
1 via Baracchini, Italy Phone 87-90-656

**Brussels:** Alain Offergeld  
23 Chaussee de Wavre  
Brussels 1040, Belgium  
Tel: 13-73-95

**Frankfurt/Main:** Fritz Krusebecker  
Liebigstrasse 27c, Germany  
Phone 72 01 81

**Tokyo:** Tatsumi Katagiri, McGraw-Hill  
Publications Overseas Corporation,  
Kasumigaseki Building 2-5, 3-chome,  
Kasumigaseki, Chiyoda-Ku, Tokyo, Japan  
[581] 9811

**Osaka:** Ryji Kobayashi, McGraw-Hill  
Publications Overseas Corporation, Kondo  
Bldg., 163, Umegae-cho Kita-ku, Japan [362] 8771

**Australasia:** Warren E. Ball, IPO Box 5106,  
Tokyo, Japan

### Business Department

**Stephen R. Weils, Manager**  
[212] 997-2044

**Thomas M. Egan,**  
Production Manager [212] 997-3140

**Carol Gallagher**  
Assistant Production Manager [212] 997-2045

**Dorothy Carter,** Contracts and Billings  
[212] 997-2908

**Frances Vallone,** Reader Service Manager  
[212] 997-6057

### Electronics Buyers' Guide

**George F. Werner,** Associate Publisher  
[212] 997-3139

**Regina Hera,** Directory Manager  
[212] 997-2544



# SIEMENS

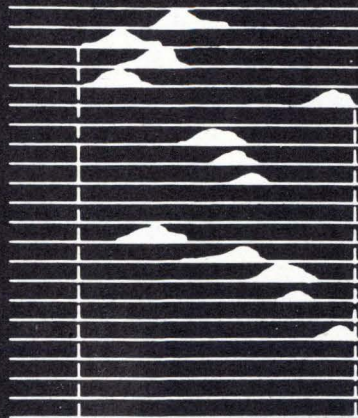

## Seizure of Nominal Value Deviations – considering previous events

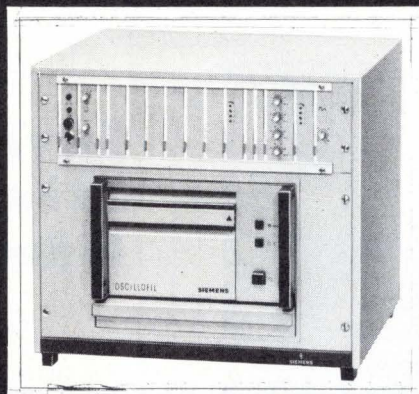
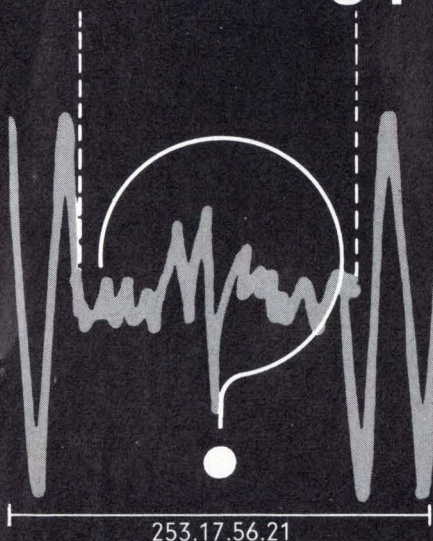

What caused the anomaly? Which variable quantities are effected? How long does the nominal value deviation last? What eliminated it eventually? – Questions, needing answers to make an exact fault analysis possible. OSCILLOSTORE® helps you to answer such questions. Because OSCILLOSTORE can monitor all continuous processes which can be represented through electrical signals up to 10 kHz. OSCILLOSTORE simultaneously registers, depending on task, up to 32 measurement values for milliseconds or minutes.

OSCILLOSTORE reacts as soon as the monitored measurement value exceeds its limits: A connected recording device is switched on to record the delayed measurement value – a few undisturbed periods, then the process of the entire disturbed measurement value and finally the recurrence of the nominal value.

Would you like to know more about OSCILLOSTORE? Where this modular system has been applied successfully in electrical power stations or processing systems?

Please write to:  
Siemens Aktiengesellschaft,  
ZVW 133,  
7500 Karlsruhe 21,  
Postfach 21 1080.

in USA to:  
Siemens Corporation,  
186 Wood Avenue South, Iselin,  
New Jersey 08830

in Canada to:  
Siemens Canada Limited,  
7300 Trans-Canada-Highway,  
Point Claire 730, Québec

## with the OSCILLOSTORE by Siemens

Circle 201 on reader service card

# Workhorse Spectrum Analyzer... **100Hz to 25MHz**

The new Nelson Ross Model 236 is a multi-purpose, easy to use, workhorse Spectrum Analyzer with outstanding performance features and an exceptionally low price of \$3275.

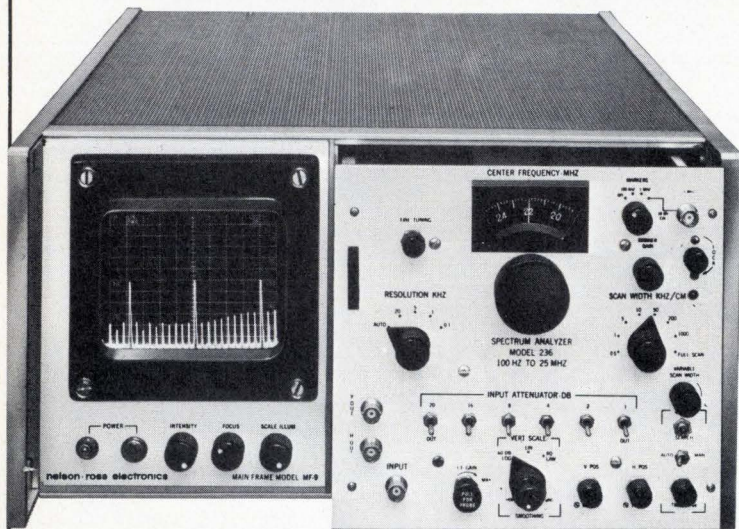

- Preset 0-25MHz quick-look scan and 0-10MHz adjustable scan widths
- 100Hz resolution, automatic and adjustable modes
- -105 dbm (1.25 $\mu$ V) sensitivity
- >60 db dynamic range for IM and Harmonic Distortion analysis
- Self-checking: Crystal frequency marker combs at 1MHz and 100KHz intervals. Absolute level reference

Numerous other versatile NR Spectrum Analyzers are available from sub-audio through microwave, 0.5Hz to 6.5GHz; complete free standing analyzers with interchangeable plug-ins, or just the plug-in analyzers for your TEK and HP scopes.

Call or write to the "Specialists"; complete specifications are yours for the asking; or, circle the reader service number.

**nelson • ross  
electronics**

A DIVISION OF POLARAD ELECTRONICS CORP.  
5 Delaware Drive, Lake Success, N.Y. 11040  
516-328-1100 • TWX: 510-223-0414

Circle 202 on reader service card

ALCOSWITCH®

Our miniature **PUSHBUTTON** switches have a "snap-action". They handle higher currents, perform better and last longer than most conventional pushbutton switches. There are many types to choose from to fit your applications.

Compare ours with competition before you buy — you'll be glad you did!

Call (617) 685-4371 for samples, technical information and prices.

**ALCO ELECTRONIC PRODUCTS, INC.**  
1551 Osgood St., No. Andover, Mass. 01845

ALCOSWITCH®

Circle 203 on reader service card

ALCOSWITCH®

Our subminiature **TOGGLE SWITCHES** are different . . . and better! This is because of the high degree of engineering expertise which went into their design. We offer many **ALCO Exclusive Features** at no hidden or additional costs.

Call us now to see what we mean. Our number is (617) 685-4371. Ask for a free sample, technical info and cost savings!

**ALCO ELECTRONIC PRODUCTS, INC.**  
1551 Osgood St., No. Andover, Mass. 01845

ALCOSWITCH®

202 Circle 116 on reader service card

## Easy Access At Newest Plant Site In Rochester, New York

The Outer Loop Industrial Park is right next to a freeway system that connects you with the New York State Thruway and the World. Expressways also lead you straight to the profitable Rochester market.

Neighboring companies know the benefits of this fine location on Rochester's west side. Some of them are Eastman Kodak, Bendix Corporation, 3M Company, General Motors, and Ragu Foods.

Railroad service is available on-site and an airport served by three major airlines is minutes away via the freeways. The Port of Rochester, a few miles to the north, has deep water accommodation for ocean-going vessels.

For more information, contact Robert J. Hall, Director of Area Development, Rochester Gas and Electric Corporation, 89 East Avenue, Rochester, New York 14649 or call (716) 546-2700, ext. 2466.

We know more about sites in our nine-county area than just about anyone else. Contact us for information on available facilities from 10,000 to 800,000 square feet.

**RGE** ROCHESTER GAS AND ELECTRIC  
89 EAST AVENUE, ROCHESTER, N.Y. 14649 • 546 2700

Circle 204 on reader service card