

Low-cost transistor testing with op amps 84

The key to successful cost estimating 90

Three-way battle shapes up for uhf-tv tuners 95

LIBRARY  
STATE TECHNICAL INSTITUTE  
AT MEMPHIS

# Electronics®

**SPECIAL REPORT**

**BUCKET BRIGADES:  
NEW TECHNOLOGY  
FOR IMAGE SENSING**



1420 TCH598 MCSAT FEB72  
ST TECHNICAL INST  
LIBRY  
5983 MACON COVE  
MEMPHIS TN  
38128

in the spirit of progress...  
**MOS MOVES INTO PRODUCTION  
 TO MAKE FOR YOU...  
 THE ADVANTAGEOUS AND  
 ECONOMICAL MCS 1507, A  
 KEYBOARD ENCODER ARRAY**

**FEATURING:**

- N-KEY ROLLOVER (without support electronics)
- FOUR LEVEL ENCODING (shift, shift lock, 2 control, modes)
- OPERATION WITH 64 DATA KEYS STANDARD
- LATCHED OUTPUTS (8 bits plus parity)
- TTL INTERFACE CAPABILITY
- SWITCH BOUNCE IMMUNITY
- 40 PIN DIP

**AND THESE OPTIONS:**

- ERROR SIGNAL (validation logic signals operator error)
- BUFFER RESET (data and parity reset)
- PARITY SELECT (odd or even)
- REPEAT (repeat selected data key code and strobe)
- DATA IDLE (no key depressed)
- DATA ACKNOWLEDGE (strobe and error reset)
- STROBE SELECT (pulse/level)
- EXPANDER ('TO' package compatible with 1507 expands operation to 92 keys)

...be spirited and progressive enough to inquire now!

We've Turned  
 A Technology  
 Into A Company

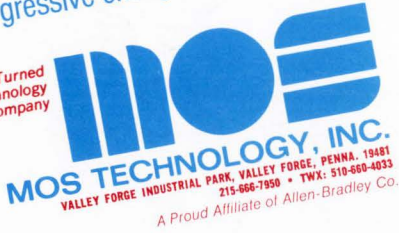

**EASTERN REGIONAL OFFICE**

Regional Sales Director — Mr. William Whitehead, MOS TECHNOLOGY, INCORPORATED, 88 Sunnyside Blvd., Suite 307, Plainview, New York 11803 • Phone: (516) 822-4240 • Alabama, Florida, Georgia, N. Carolina, S. Carolina, Tennessee, Mississippi — Currie Aerospace Associates, P.O. Box 1424, Huntsville, Alabama 35807 • Phone: (205) 536-5650 • 2907 McCoy Road, P.O. Box 13229, Orlando, Florida 32809 • Phone: (305) 855-0843 • P.O. Box 5568, Greensboro, North Carolina 27403 • Phone: (919) 273-3040 • New England States — Victor Associates, 179 Union Ave., Framingham, Massachusetts 01701 • Phone: (617) 879-5710 • Northern New Jersey, New York (Westchester County, Long Island) — Falk Baker Associates, 383 Franklin Avenue, Nutley, New Jersey 07110 • Phone: (201) 561-2430 • E. Pennsylvania, Southern New Jersey — Rivco, P.O. Box 338, King of Prussia, Pennsylvania 19406 • Phone: (215) 265-5211 • Delaware, Maryland, Washington, D.C., Virginia, West Virginia — Bernard

White & Company, Inc., 7 Church Lane, Baltimore, Maryland 21208 • Phone: (301) 484-5400.

**CENTRAL REGIONAL OFFICE**

Regional Sales Director — Mr. Alan Mattal, MOS TECHNOLOGY, INCORPORATED, 10400 W. Higgins Rd., Suite 631, Rosemont, Illinois 60018 • Phone: (312) 298-2035 • TX: 910-233-4595 • Illinois, Indiana, Wisconsin — L-TEC, Incorporated, 5808 West Higgins Rd., Chicago, Illinois 60630 • Phone: (312) 286-1500 • Ohio, Kentucky, W. Pennsylvania — McShane, Inc., P.O. Box 523, 123 W. Washington, Medina, Ohio 44256 • Phone: (216) 725-4568 • Michigan — R. C. Merchant & Co., 18411 W. McNichols Road, Detroit, Michigan 48219 • Phone: (313) 535-6000 • Missouri, Kansas, Nebraska, Iowa — Harlan J. Weisler & Assoc., Inc., 2050 Woodson Road, St. Louis, Missouri 63114 • Phone: (314) 428-3934 • Texas, Oklahoma, Arkansas, Louisiana — Norvell Associates, 10210 Monroe Drive, Dallas, Texas 75220 • Phone: (214) 357-6451.

**WESTERN REGIONAL OFFICE**

Regional Sales Director — Mr. Jack Turk, MOS TECHNOLOGY, INCORPORATED, 2172 Dupont Drive, Patio Bldg., Suite 221, Newport Beach, California 92660 • Phone: (714) 833-1600 • TX: 910-595-1573 • Arizona, New Mexico — Toward Engineering Assoc., P.O. Box 15258, Arcadia Station, Phoenix, Arizona 85018 • Phone: (602) 955-3193 • California, Nevada — Bertrand & Zoolalian, Inc., 7340 Florence Avenue, Suite 205, Downey, California 90241 • Phone: (213) 927-4406 • Hunter Associates, 1208 Fox Plaza, San Francisco, California 94102 • Phone: (415) 626-8576 • Colorado, Utah, Wyoming — R. G. Enterprises, 1107 South Pearl Street, Denver, Colorado 80210 • Phone: (303) 744-2464 • Washington, Oregon, Idaho, Montana — J. A. Tudor & Assoc. Inc., 2605 Western Avenue, Seattle, Washington 98121 • Phone: (206) 682-7444.

**INTERNATIONAL SALES REPRESENTATIVES**

Argentina — T. R. C. Electronica, S.A.C.I. S.R.L., Cangallo 4450, Buenos Aires, Argentina • Phone: 88-4044/5/6;

Mr. M. Lissin • England, Wales, Scotland, Ireland — Impetron Limited, Impetron House, 21-31 King Street, London W3 9LH, England • Phone: 01-992-5388 • France — Bureau de Liaison, 113 Rue de L'Universite, Paris Vile, France • Phone: 551-9920 • Germany, Netherlands — International Micro Electronics, Inc., Arabella-haus 1838, Arabellastr. 5, 8000 Munich 81, Germany • Phone: 92-321 • India — Electronic Enterprises, 46 Karani Building, New Charni Road, Bombay 4, India • Phone: 375375 • Israel — Eastronics, Ltd., 75 Haifa Road, P.O. Box 21029, Tel-Aviv, Israel • Phone: 38352 • Italy — Special-Ind. Corporation, Piazza Spotorno, 20159 Milano, Italy • Phone: 632-435 • Japan, Hong Kong, Korea, Taiwan — Takachiho Koheki Company Ltd., 1-7, Chome Kohjimachi, Chiyoda-Ku, Tokyo 102, Japan • Phone: 263-3211 • Sweden, Denmark, Finland, Norway — Thru F. Forsberg, Forsbergsgatan 58, P.O. Box 79, Farsta 1, Sweden • Phone: 647040 • Switzerland — Ernst M. Egli, Ingenieur — Bureau Ag, Wittikonstrasse 295, Zurich (CH 8053), Switzerland • Phone: 53.38.11.

Circle 900 on Reader service card

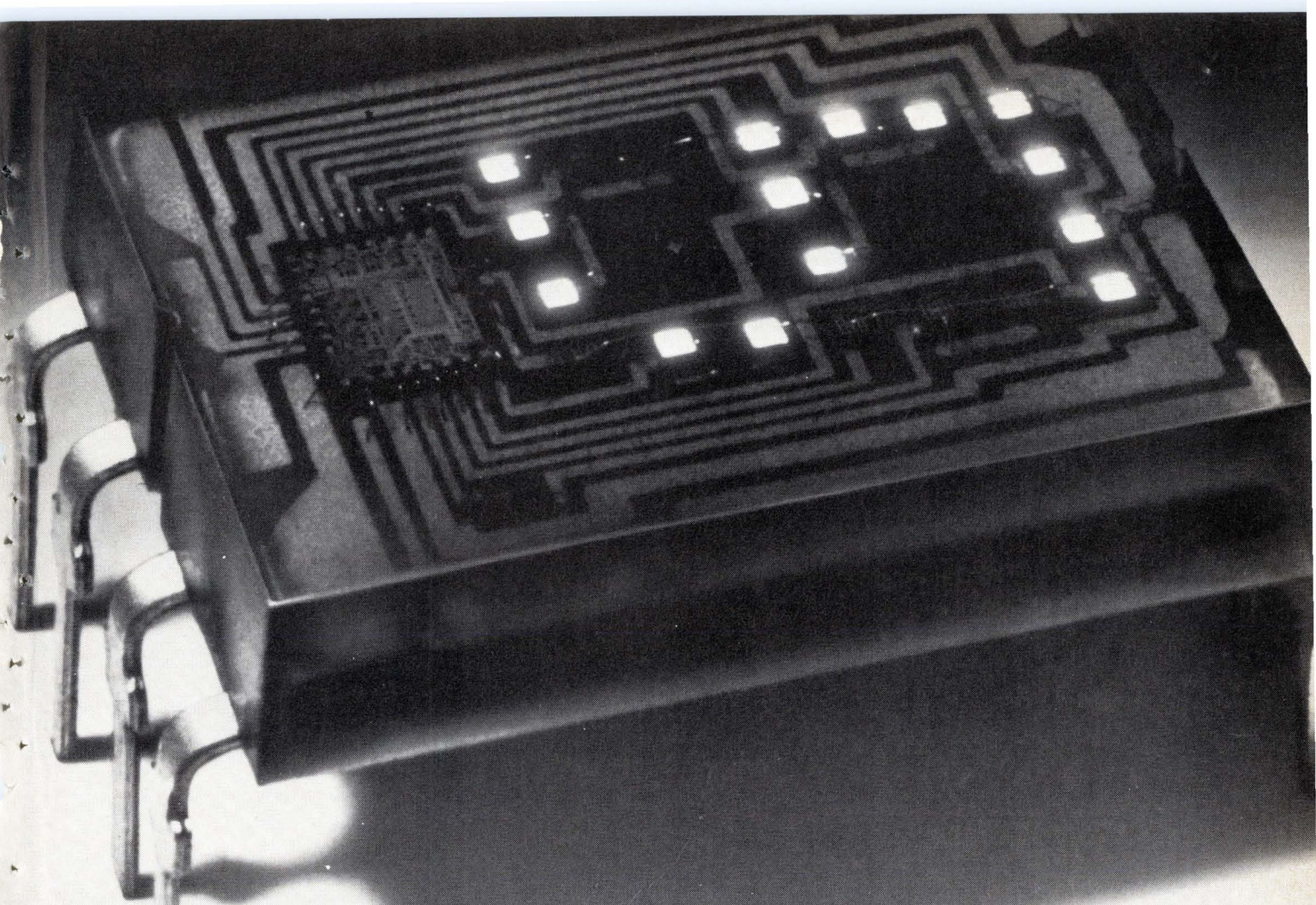

# We built in the decoder/driver so you don't have to.

Not only the decoder/driver but the memory too! Now available for *immediate* delivery is the HP 5082-7300 series solid state display.

It's completely TTL compatible. All you do is address it directly with four-line BCD input. The on-board IC allows for either the storage of input data or real-time display. You save design time, space, and money, and get a completely reliable integrated display system.

A bright .290 inch high, shaped character gives

excellent readability over a wide viewing angle in a compact .600 inch by .400 inch package.

Best of all is the price: \$10.00 each in 1K quantities. So why wait? Order now! For *immediate* delivery on the HP 5082-7300 call your local HP sales office, or Hewlett-Packard, Palo Alto, Calif. 94304. In Europe: 1217 Meyrin-Geneva, Switzerland.

01202

HEWLETT  PACKARD

COMPONENTS

Circle 1 on reader service card

# 0.25 pA $I_b$ (max)

## AD523. This one has the lowest bias current of all high performance I.C. operational amplifiers. Even ours. Especially theirs.

The AD523 is our new series of J-FET input operational amplifiers. It's the first linear I.C. to guarantee 0.25 pico-amp of bias current under operating conditions. At either input terminal. And in a low leakage case.

And you know what that means.

This amplifier is more charge-sensitive and an

order of magnitude more current-sensitive than other linear I.C.'s. And with  $15 \mu\text{V}/^\circ\text{C}$  of offset voltage drift, 90 dB of CMR, and a slew rate of  $5 \text{ V}/\mu\text{sec}$ .

We did a number of important things to give you this performance.

Like combining matched small geometry FET chips with a

specially designed monolithic thin-film chip. And mounting them in TO-99 can with high resistivity glass insulation and a guard pin connected to it. So you can minimize surface leakage currents, power supply induced input noise, and capacitive pickup.

You can evaluate a package of five AD523's at the hundred piece

price if you order right now.

You can see all the things we make to solve more of your problems better than anyone else by sending for our 1972 Product Guide.

Analog Devices, Inc.,  
Norwood, Mass. 02062.  
Tel. (617) 329-4700.

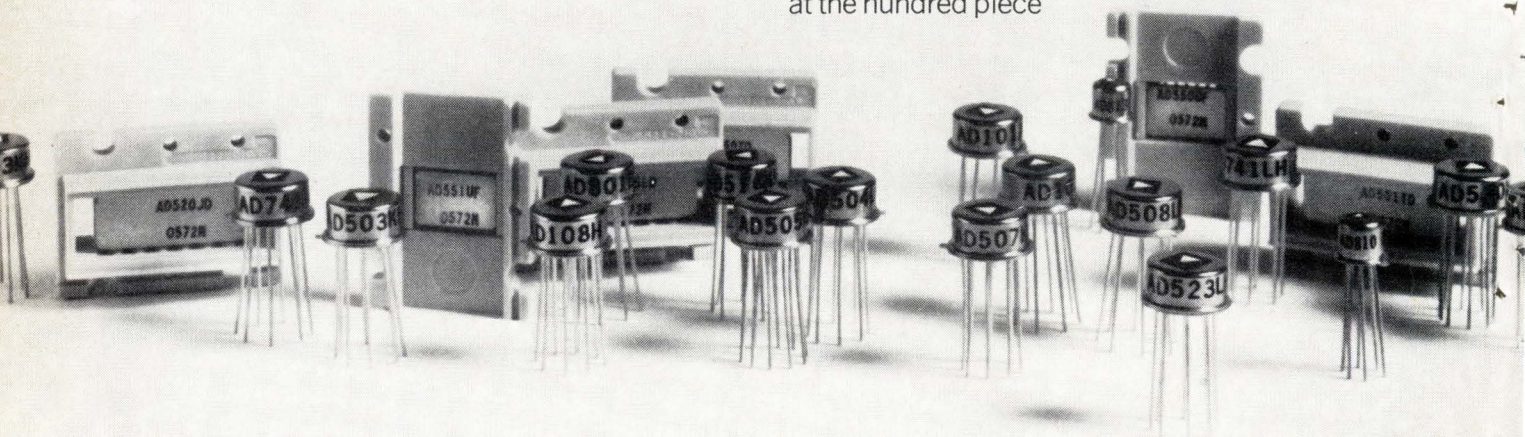

---

## 31 Electronics Review

MEMORIES: IBM unveils first working CCD memory system, 31; GE uses charge transfer, 31; Gate circuits trim power demand, 32  
SOLID STATE: Fast circuit for a-d conversion, 32; High-speed optical isolator, 33  
CONTRACTS: FAA looks for new ways to stop skyjacking, 34  
INTEGRATED ELECTRONICS: Analog delay line makes it into IC world, 34  
MILITARY ELECTRONICS: Pentagon reorganizes purchasing, telecommunications, 36  
SATELLITES: OTP rewrites aerosat book, 38  
COMPUTERS: Control processor eases microprogramming tasks, 41  
EDUCATION: Fewer EEs on campus could spell industry shortage, 42  
FOR THE RECORD: 44

---

## 61 Technical Articles

COMPONENTS: Bucket brigade devices pass from principle to prototype, 62;  
Analog functions fit neatly onto charge transport chips, 64;  
Solid state imaging emerges from charge transport, 72  
CIRCUIT DESIGN: Designer's casebook, 80  
TESTING: Accurate transistor tests can be made inexpensively, 84  
COST ESTIMATION: Estimating project costs—what the textbooks don't tell, 62

---

## 95 Probing the News

CONSUMER ELECTRONICS: Uhf tuner makers vie for profits, 95  
INDUSTRIAL: Automation boosts plant power, 98  
COMMUNICATIONS: Spade system to shrink world, 102  
COMMUNICATIONS: FCC gets advice on digital data transmission, 105

---

## 109 New Products

IN THE SPOTLIGHT: Medium-speed printers for minicomputer systems, 109; Tester handles 120-megabit rate, 111  
INSTRUMENTS: Low-cost scope covers 15 MHz, 113; Synthesizers keep 0.1-Hz resolution up to 13 MHz, 113  
DATA HANDLING: Flexible-disk recorder challenges cassettes, 119; Conversing with a calculator, 119  
SEMICONDUCTORS: And now—a DVM on a chip, 125

---

## 135 Electronics International

JAPAN: Color TV makers rush to 110° tube, 135  
FRANCE: Toward a trillion-bit memory, 135  
FRANCE: Using capacitance to measure microdistances, 136  
GREAT BRITAIN: Spotting pinholes in ICs with liquid crystals, 136  
JAPAN: Analog device serves as memory and multiplier, 137  
JAPAN: Versatile MAS ROM comes to market, 138

---

## Departments

Publisher's letter, 4  
Readers comment, 6  
40 years ago, 8  
People, 14  
Meetings, 22  
Electronics Newsletter, 25  
Washington Newsletter, 51  
Washington Commentary, 52  
New Books, 128  
New Literature, 130  
Personal Business, PBI  
International Newsletter, 133

# Electronics

EDITOR-IN-CHIEF: Kemp Anderson

EXECUTIVE EDITOR: Samuel Weber

MANAGING EDITORS: Lawrence Curran, *News*;  
Arthur Erikson, *International*

SENIOR EDITORS: John Johnsrud,  
H. Thomas Maguire, Stephen E. Scrupski

ART DIRECTOR: Fred Sklenar

ASSOCIATE EDITORS: Richard Gundlach,  
John N. Kessler, Howard Wolff

DEPARTMENT EDITORS

*Aerospace*: William F. Arnold  
*Circuit Design*: Lucinda Mattern  
*Communications & Microwave*:  
Lyman J. Hardeman

*Computers*: Wallace B. Riley  
*Consumer*: Gerald M. Walker  
*Industrial*: Alfred Rosenblatt

*Instrumentation*: Michael J. Riezenman  
*Military*: Ray Connolly

*New Products*: H. Thomas Maguire  
*Packaging & Production*:  
Stephen E. Scrupski

*Solid State*: Laurence Altman  
*Special Issues*: Harry R. Karp

COPY EDITORS: Margaret Eastman,  
Everett C. Terry

ART: Charles D. Ciatto, *Associate Director*

PRODUCTION EDITORS:  
Patricia Cybulski, Arthur C. Miller

EDITORIAL ASSISTANT: Marilyn Offenheiser

EDITORIAL SECRETARIES: Vickie Green,  
Nancy Baldasare, Julie Gorgoglione

FIELD EDITORS

*Boston*: James Brinton (Mgr.), Gail Farrell

*Dallas*: Larry Armstrong (Mgr.)

*Los Angeles*: Paul Franson (Mgr.)

*New York*: Alfred Rosenblatt (Mgr.)

*San Francisco*: Stephen Wm. Fields (Mgr.),  
Roberta Schwartz

*Washington*: Ray Connolly (Mgr.),  
William F. Arnold

*Frankfurt*: John Gosch

*London*: Michael Payne

*Paris*: Arthur Erikson

*Tokyo*: Charles Cohen

McGRAW-HILL WORLD NEWS

*Director*: Walter A. Stanbury; *Atlanta*: Stan  
Fisher; *Chicago*: Mike Sheldrick; *Cleveland*:  
Arthur Zimmerman; *Detroit*: James Wargo;

*Houston*: Robert E. Lee; *Los Angeles*: Michael  
Murphy; *Gerald Parkinson*; *San Francisco*:

Margaret Drossel; *Seattle*: Ray Bloomberg;

*Washington*: James Canan, Herbert W.

Cheshire, Seth Payne, Warren Burkett, William  
D. Hickman; *Bonn*: Robert Ingersoll; *Brussels*:

James Smith; *London*: Marvin Petal; *Milan*:

Peter Hoffmann, Andrew Heath; *Moscow*: Axel  
Krause; *Paris*: Stewart Toy, Michael Johnson;

*Stockholm*: Robert Skole; *Tokyo*: Mike Mealey

PUBLISHER: Dan McMillan

ADVERTISING SALES MANAGER: Pierre J. Braude

ADVERTISING SALES SERVICE MANAGER:  
Wallis Clarke

BUSINESS MANAGER: Stephen R. Weiss

CIRCULATION MANAGER: George F. Werner

RESEARCH MANAGER: David Strassler

MARKETING SERVICES MANAGER:

Tomlinson Howland

## Publisher's letter

**I**t's no surprise that electronics technology is speeding ahead, but every once in a while it does come as a jolt to realize just how fast it is going. And how fast the textbooks have to be updated.

Take bucket brigades as an example. Two years ago, many labs were looking into the concept (see special report on page 62), but there wasn't much talk about charge transfer devices, the family to which bucket brigades and their cousins, charge coupled devices, belong. Then, says our solid state editor, Larry Altman, there was a brief mention of CCDs at the 1970 IEEE convention. "We were the first to spot the work and to print the story, and we have continued to give a major amount of space to it."

"As a gauge of how far it has grown, note that this year the IEEE meeting devotes a whole session to the technology, plus an evening seminar. Their big advantage is that with them, as with no other semiconductor technology, you can handle both complex analog and digital functions."

**T**ake op amps as another example. Our instrumentation editor, Mike Riezenman, says that when he earned his engineering BS a half dozen years ago, operational amplifiers were hardly mentioned in MIT's classrooms. Now they have crept into a wide range of products from computers to satellites. Indeed, so common have they become that they make possible inexpensive, off-the-shelf answers to some sophisticated design problems, such as transistor testing (see page 84).

Mike, who edited the article, first

worked with op amps when he was with ITT Defense Communications division. His group was designing space communications equipment for point-to-point ground links. The op amps available then were expensive, but they worked well in an auto-correlator needed in the system. "Now," says Mike, "op amps are available in a variety of types, not just the rudimentary pre-IC forms we had to work with."

**O**r take TV tuners as an example. The lead story in our Probing the News section this issue covers the fast-moving technological—and economic—battle being waged over which of three tuners—one of which wasn't even in the running until November—will do the job of bringing in uhf TV (see p. 95).

Marilyn Offenheiser of our New York staff put the story together based on interviews with the leading tuner and set makers and inputs from our domestic and foreign field bureaus. For part of the story, Marilyn went to see companies in the Chicago area. Flying back into O'Hare after visiting tuner maker Sarkes Tarzian in Bloomington, Ind., Marilyn learned of a communications problem to which the textbooks will probably never have an answer. The crew of her Beechcraft pointed out a new motel rising at O'Hare, a building many airport personnel fear will badly interfere with the field's radio navigational aids. Says Marilyn, "after hearing what the pilot said might happen, I was glad we landed before the motel was finished."

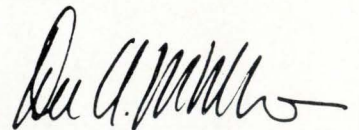

February 28, 1972 Volume 45, Number 5  
89,771 copies of this issue printed

Published every other Monday by McGraw-Hill, Inc. Founder: James H. McGraw, 1860-1948. Publication office: 330 West 42nd Street, N.Y., N.Y. 10036; second class postage paid at New York, N.Y., and additional mailing offices.

Executive, editorial, circulation and advertising addresses: Electronics, McGraw-Hill Building, 330 West 42nd Street, New York, N.Y. 10036. Telephone (212) 971-3333. Teletype TWX N.Y. 710-581-4235. Cable address: MCGRAW HILL N.Y.

Subscriptions limited to persons with active, professional, functional responsibility in electronics technology. Publisher reserves the right to reject non-qualified requests. No subscriptions accepted without complete identification of subscriber name, title, or job function, company or organization, including product manufactured or services performed. Subscription rates: qualified subscribers in the United States and possessions and Canada, \$8.00 one year, \$12.00 two years, \$16.00 three years; all other countries \$25.00 one year except Japan \$50.00 per year including air freight. Limited quota of subscriptions available at higher-than-basic rate for persons outside of field served, as follows: U.S. and possessions and Canada, \$25.00 one year, all other countries \$50.00. Single copies: United States and possessions and Canada, \$1.00; all other countries, \$1.75.

Officers of the McGraw-Hill Publications Company: John R. Emery, President; J. Elton Tuohig, Senior Vice President—Services; Donald B. Gridley, Group Vice President; Vice Presidents: Ralph Blackburn, Circulation; John R. Callahan, Editorial; David G. Jensen, Manufacturing; Jerome D. Luntz, Planning & Development; Joseph C. Page, Marketing; Robert M. Wilhelmy, Finance.

Officers of the Corporation: Shelton Fisher, President; Joseph H. Allen, President, Publications and Business Services Group; John J. Cooke, Senior Vice President and Secretary; Ralph J. Webb, Treasurer.

Title registered in U.S. Patent Office, Copyright 1972 by McGraw-Hill, Inc. All rights reserved. The contents of this publication may not be reproduced either in whole or in part without the consent of copyright owner.

Subscribers: The publisher, upon written request to our New York office from any subscriber, agrees to refund that part of the subscription price applying to copies not yet mailed. Please send change of address notices or complaints to Fulfillment Manager, subscription orders to Circulation Manager, Electronics, at address below. Change of address notices should provide old as well as new address, including postal zip code number, if possible, attach address label from recent issue. Allow one month for change to become effective.

Postmaster: Please send form 3579 to Fulfillment Manager, Electronics, P.O. Box 430, Hightstown, N.J. 08520.

# A more functional generator for \$495.

The new Krohn-Hite Model 5200 linear sweep/function generator gives you more versatility and performance for your money. If that's a sweeping statement, we stand ready to prove it! Model 5200 generates basic sine, square, triangle and ramp waveforms that you can manipulate with sweeps and triggers from 0.00003Hz to 3MHz. For even more versatility, the new Model 5300 adds an exponential ramp for logarithmic sweeping at only \$695. For fast action, call the Wavemakers at (617) 491-3211, TWX 710-320-6583, Krohn-Hite Corporation, 580 Massachusetts Ave., Cambridge, Mass. 02139.

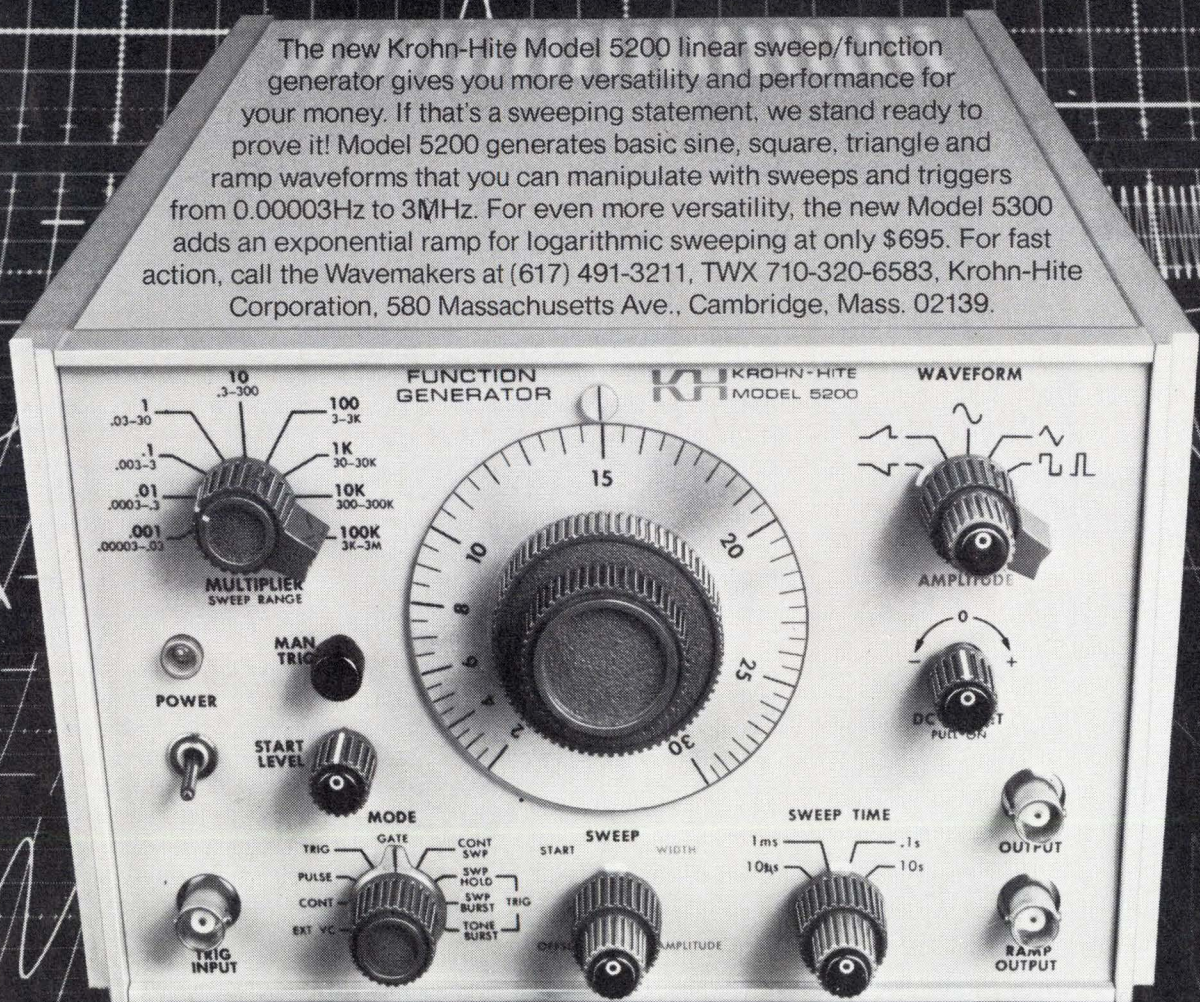

**KH KROHN-HITE CORPORATION**

OVERSEAS SALES OFFICES: AUSTRIA, Universal Elektronik Import; AUSTRALIA, Warburton O'Donnell Limited; BELGIUM, C. N. Rood s. a.; DENMARK, SC Metric A/S; ENGLAND, Allied International Limited; FINLAND, INTO O.Y.; FRANCE, Antares; GERMANY, Nucletron Vertriebs-GmbH; HOLLAND, C. N. Rood n. v.; INDIA, Bali International Agencies; ISRAEL, R.D.T. Electronics Engineering, Ltd.; ITALY, Vianello S.P.A.; JAPAN, Shoshin Shoji Kaisha, Ltd.; NEW ZEALAND, H.M.Z. Ltd.; SOUTH AFRICA, Protea Physical; SPAIN, Rema Leo Haro S.A.; SWEDEN, Teleinstrument; SWITZERLAND, H. Meyer & Co. SA.

# If you've just bought somebody else's 60 MHz scope read this ad and weep.

This is Dumont's new 60 MHz dual trace oscilloscope. For a few dollars less, it gives you features you simply can't get from our major competition. At any price. Consider our unique, new triggering system, for example. It lets you re-position the traces without re-adjusting the trigger. With our scope, once in the morning does it. Your trigger is set all day. A real bonus for your overworked fingers.

For your overworked eyes, there's our CRT screen. It's a big 5" (compared to the competition's 4"), and features full centimeter divisions instead of 0.8 centimeter divisions. In effect, you get over 50% more viewing area.

And that's not all. Other 60 MHz scopes degrade to 40 MHz at 5 mV/division. Ours gives you full 60 MHz at 5 mV/division. Other scopes use gain switching. Ours uses a passive attenuator. And that means you don't have to trade bandwidth for gain, or make additional D.C. balance adjustments.

Now, imagine the highly improbable. Something goes wrong with this paragon of sophistication. Fear not. For every component in our 1062 scopes, there's another one just like it. Here at Dumont or sitting on your local distributor's shelf. Ready to be put into place. Compare that to the selected, potted, home-made and special parts that our competition uses.

If you're in the market for a great 60 MHz scope, write for our literature. If you just bought one from somebody else, write anyway. May it serve as a reminder. Next time.

DUMONT OSCILLOSCOPE  
LABORATORIES, INC.  
40 Fairfield Place, W. Caldwell, N.J. 07006  
(201) 575-8666 TWX (710) 734-4308

**DUMONT**  
OSCILLOSCOPE LABORATORIES, INC.



6 Circle 6 on reader service card

## Readers comment

### Pioneer Hall-effect heads

**To the Editor:** This is with regard to the item on Pioneer Hall-effect [*Electronics*, Nov. 22, 1971, p. 25]. It is risky to accept anything as a first in the technology today. The Hall effect has, in fact, been applied to read heads since at least 1959, and the Siemens catalog has offered one or two models for nearly as long. Acceptance has been limited because designers find it possible to avoid the complexity and instability of flux-responsive heads in general, and Hall generators tend to be even less stable than the magnetic modulator tapes.

The principal virtue of flux-responsive heads is that their output is independent of tape speed and so can operate at very low speed. The recorder for Mariner 4 is an example of a system in which a conventional head read video data from tape moving at only 0.01 inches per second to allow reliable transmission at 8 1/3 bits per second over the long path leading from Mars to Earth.

Charles B. Pear  
Potter Instrument Co.  
Plainview, N.Y.

### More on GaP

**To the Editor:** In company with Messrs. Hart and Fletcher, I too must correct George Smith on the availability and dimensions of gallium phosphide wafers [*Electronics*, Oct. 25, 1971, p.74, and Jan. 3, p.6].

My company has for the past year manufactured and marketed through A.I.C., New York City, gallium phosphide crystals exceeding 25 mm in diameter. Over and above materials produced against orders, our current inventory lists 12 such ingots totalling a near kilo in weight, which we would be very happy to supply at prices well below the "exorbitant" \$144 per in.<sup>2</sup> that has been quoted by George Smith.

Hot from the puller is a 2-in. diameter crystal. Any offers from your readers?

B. J. Wray  
Manager, Intermetallics Division  
M.C.P. Electronics Limited  
Alperton, Wembley, Middx.  
England

**To the Editor:** Mr. George Smith [*Electronics*, Jan. 3, p.6] has still got it wrong. My company is happy to supply 23- to 27-mm gallium phosphide substrates in quantity prices around half the \$144 per in.<sup>2</sup> that he quotes.

P. B. Hart  
The Plessey Co. Ltd.  
Caswell Towcester, Northants.  
England

### Premature Baby Monitors

**To the Editor:** The product developed by Romuald Plaszczyński and mentioned in the article, "Three simple sensors monitor premature babies," [*Electronics*, Jan. 3] is apparently identical to the one we have marketed for many years. The Beckman Vital Signs Monitor, VSM-100, monitors infant heart rate, respiration rate, and temperature, as does the "new" product described in your article. The VSM-100 uses an impedance pneumograph operating at 50 kilohertz and approximately 0.1 milliamperes, also as described. The technique of simultaneous heart-rate and respiration monitoring with the same pair of electrodes is also well established, having been introduced by Dr. Geddes and his colleagues at Baylor University in 1962.

Please refer Mr. Plaszczyński to French Patent 1,575,190 and U. S. Patent 3,606,542, invented by the undersigned and owned by Beckman Instruments, which fully describe this method.

Allan F. Pacela  
Beckman Instruments Inc.  
Fullerton, Calif.

■ *Mr. Plaszczyński replies: We well know the excellent work of Mr. Pacela. We, too, have been working many years in this field, and our standard versions of this equipment are well known. But the originality of the machine described in the Jan. 3 issue is its extreme miniaturization and the fact that it is nearly totally automatic. Moreover, we believe we are the first to introduce the super-imposed display of respiration and electrocardiogram parameters, which permits the two phenomena to be easily correlated.*



# ANOTHER MYTH DESTROYED.

**Myth:** National doesn't make FET op amps. And, even if they did, they probably wouldn't be as good as bipolar devices. And, besides, everybody knows that FET op amps have lousy offset voltage and drift specs. And, FET op amps are too expensive. And, anyway, why not just go to a module house in the first place...

**Fact:** National does make FET op amps. A "family" of five devices, to be exact. Including the super precise new LH0052 (with an offset voltage of 0.1mV, an offset voltage drift of just  $5\mu\text{V}/^\circ\text{C}$ , and bias current of less than 1pA); the LH0022 (high performance good general purpose FET op amp); the LH0042 (lowest cost FET op amp on the market with even better performance than cheap module designs); the LH0033 (at  $1500\text{V}/\mu\text{S}$ , the fastest voltage follower available anywhere); the LH0032 (a  $500\text{V}/\mu\text{S}$  device); and coming soon: The precise-and-speedy new LH0062 (slew rate,  $80\text{V}/\mu\text{S}$ ; bandwidth, 15MHz; settling rate, 800nS). Significantly, each of the above was designed and manufactured completely in-house using a special chip construction technique combining the best of J-FET and bipolar technologies. All of which goes to show that FET op amps are, indeed, alive and well at National Semiconductor Corporation, 2900 Semiconductor Drive, Santa Clara, California 95051. Phone (408) 732-5000. TWX: (910) 339-9240. Cable: NATSEMICON.

## NATIONAL.

# VOICE YOUR CHOICE

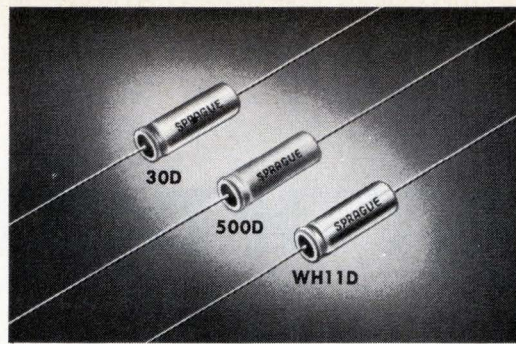

... Sprague makes three!

## SMALL ALUMINUM 'LYTIC CAPACITORS

### TYPE 30D FOR INDUSTRIAL APPLICATIONS

Will withstand 2000 hr. life test at 85°C. Excellent stability, dissipation factor, leakage current. Designed for business machines, instrumentation equipment, etc. Write for Engineering Bulletin 3150A or; CIRCLE 157 ON SERVICE CARD.

### TYPE 500D FOR MODERATE-COST APPLICATIONS

Good operating life characteristics, including stability, ESR, leakage current. Will withstand 1000 hr. life test at 85°C. Ideal for radio, TV, and other entertainment applications. Write for Engineering Bulletin 3149 or; CIRCLE 158 ON SERVICE CARD.

### TYPE WH11D FOR ECONOMY APPLICATIONS

Welded construction, similar to higher-priced capacitors. Widely used in solid-state equipment where cost is of prime importance. Made by Sprague World Trade Corp. in Hong Kong. Write for Engineering Bulletin 3148C or; CIRCLE 159 ON SERVICE CARD.

## MORE FROM SPRAGUE ... THE BROAD-LINE PRODUCER OF ELECTRONIC PARTS

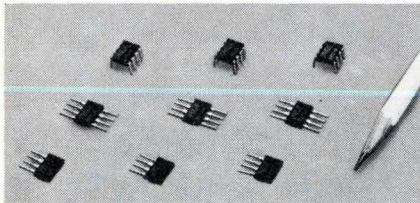

**HALL EFFECT SWITCH ICs.** Actuated magnetically, not mechanically or optically. Hall generator trigger circuit and signal amplification circuit on single silicon chip. Reliable (no moving parts). Easy interfacing with DTL/TTL/MOS logic. High speed. Low cost. Write for Engineering Bulletin 27,402A or; CIRCLE 160 ON READER SERVICE CARD.



**U.L. LISTED FILTERS.** Series JX5000 for EDP equipment and general-purpose use. Rated 125/250 VAC, 0-60 Hz, 1 thru 50 amps. 60 db @ 150 kHz, 80 db from .5 MHz thru 1 GHz. Special designs and rectangular multi-circuit units also available. Write for Engineering Bulletin 8210 or; CIRCLE 161 ON READER SERVICE CARD.



**TYPE 36D POWERLYTIC® CAPACITORS.** For use in computer power supplies, control equipment, energy storage, etc. Low impedance construction. Up to 650,000  $\mu$ F at 3 V. Ratings from 3 to 450 V. Can be operated at 85°C. Tapped 10-32 terminals simplify filter bank assembly. Write for Engineering Bulletin 3431C or; CIRCLE 162 ON READER SERVICE CARD.

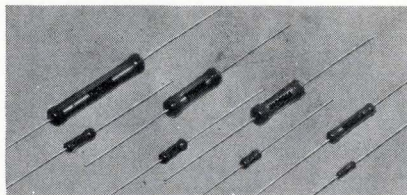

**BLUE JACKET® RESISTORS.** Vitreous-enamel power wirewound. Unique all-welded end-cap construction eliminates moisture paths along leads, anchors leads securely to resistor body. Expansion coefficients of vitreous enamel, ceramic body, and end caps are closely matched. Write for Engineering Bulletin 7410E or; CIRCLE 163 ON READER SERVICE CARD.



TECHNICAL LITERATURE SERVICE, SPRAGUE ELECTRIC CO., 35 MARSHALL ST., NORTH ADAMS, MASS. 01247

45-1117

## 40 years ago

From the pages of Electronics, February 1932

All during February the Patents Committee of the House of Representatives will hold hearings at Washington looking to fundamental revision of the patent laws. Chairman Sirovich has invited all persons interested to appear before the committee and give testimony.

In the conflict of self-interested opinion that has surrounded the patent law, its primary object, that of obtaining disclosure of inventions for the benefit of the public, is almost lost to sight. "Pat Pending" is sure to get a sound tongue-lashing when the hearings open.

The life of a patent from date of issue is 17 years but many applicants, after filing their claims, permit them to hang fire, thus obtaining a large measure of protection for a long period before patent is actually granted. In general, this practice would be suppressed by limiting protection accorded by a patent to 20 years from date that application is filed.

**Radio industry leaders** appeared before the Ways and Means Committee of the House of Representatives in opposition to the proposed 5% sales tax on radio and accessories, declaring that such a tax would cause increased prices to the public, reduce sales, increase unemployment, and yet raise negligible additional taxes for the Government.

**Under a plan** to provide employment for engineers, authorization has been received for the appointment of six special research assistants for the spring term in the College of Engineering of Rutgers University. These assistantships will carry a stipend of \$150 and exemption from all tuition fees.

**Dr. Leopold Stokowski**, director of the Philadelphia Philharmonic Orchestra, has been experimenting with electric-oscillator music for several years, using the deep sonorous tones of electrical vibrations to enrich the volume output of his musicians. As a further supplement, Dr. Stokowski has recently added a special form of keyboard theremin.

# IMPROVED TRIAC RELIABILITY WITH GE **POWER-GLAS**<sup>™</sup> PASSIVATION

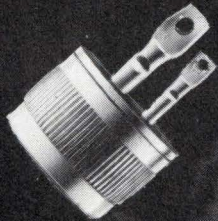

Press-Pac

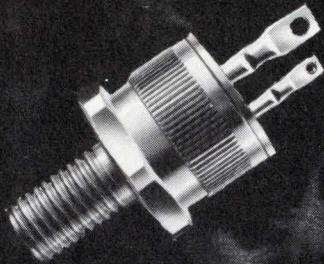

Stud

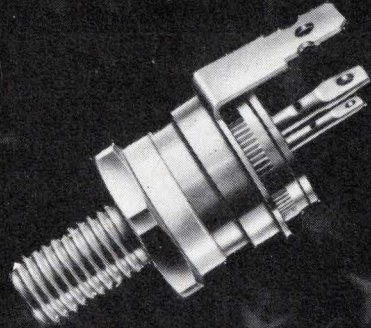

Isolated Stud

General Electric 6, 10, 15 and 25 amp triacs now incorporate **POWER-GLAS**<sup>™</sup> passivation . . . a proprietary glass formulation and deposition process that creates an intimate void-free bond between the silicon chip and the matched glass.

For the user this means significant reductions in "off-state" current (typically less than 100  $\mu$ A) and new reliability standards for stability under conditions of AC blocking life. Additionally all General Electric triacs are transient voltage immune.

**POWER-GLAS**<sup>™</sup> passivation available now in the SC240, SC245, SC250 and SC260 series, 6, 10, 15 and 25 amps respectively up to 500 volts, and in three package configurations . . . press fit, stud, and isolated stud.

Interested . . . contact any authorized General Electric Electronic Component Sales Office, authorized General Electric Distributor, or write for a copy of "Improved Triac Reliability thru **POWER-GLAS**<sup>™</sup>."

**GENERAL**  **ELECTRIC**

Semiconductor Products Department  
Electronics Park, Syracuse, New York  
13201

**With all the digital  
panel meters around,  
you have to be pretty small  
or inexpensive  
to attract any attention.**

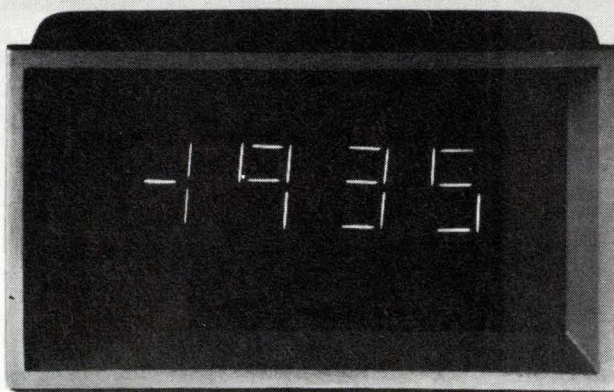

(actual size)

## attention.

You're looking at the world's smallest and least expensive 3½-digit panel meter.

Ours. Our AD2001. The DPM that's a component.

It's just under 8 cubic inches in volume. \$89 in 100's. And we're delivering it now.

This simple, reliable meter has a few other things going for it too.

We made it with fewer components. Eliminated multi-level power supplies. Used long-life RCA Numitron display tubes. And built in over voltage protection.

It provides 0.05% accuracy. Has a temperature coefficient of  $\pm 50$ ppm/ $^{\circ}$ C. And all the interfacing signals are standard.

The two critical analog components are made by us. Analog Devices. Which is an interesting point.

We're the world's largest maker of analog to digital converters.

That's why our digital panel meter is something else. We put a little experience into it before we made it.

Each meter is burned-in for 7 days prior to shipment and war-

ranted for one full year. You can send for our complete brochure and order an evaluation sample right now.

Watch for the appearance of our 2½ and 4½ digit DPM's. With the same performance and reliability as this one. At a size and price worth more of your attention.

Analog Devices, Inc., Norwood, Mass. 02062. Tel. (617) 329-4700.



AD2001 DIGITAL PANEL METER. SIZE: 3" wide, 1¾" high, 1½" deep. Overall volume just under 8 cubic in. DISPLAY: Auto Polarity, Overrange, Out-of-Scale indication, Automatic zero, Programmable decimal points. DATA PROCESSING SIGNALS: External Trigger and External Hold, 3-digit BCD outputs, Overrange, Out-of-Scale, and Polarity signals are all standard. INPUT: Bias Current less than 1nA. Impedance—1000M $\Omega$ . Over Voltage Protection. ACCURACY: 0.05% reading, Temperature Range—0 $^{\circ}$ C to 60 $^{\circ}$ C operating, Temperature Coefficient— $\pm 50$ ppm/ $^{\circ}$ C. POWER: Single power source, +5VDC input.

Circle 11 on reader service card

**... In Space-Limited Applications**

*Hammer Driver Darlington*s are now available in compact, TO-66 packaging! The new, 2 and 4 A types offer 3,000 typical gain for space-critical switching applications such as hammer drivers. This design provides one-stage interface between MHTL logic drive and printout in minimum space.

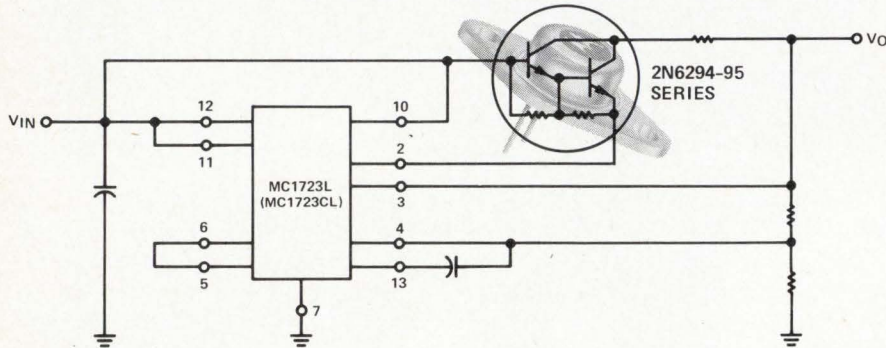
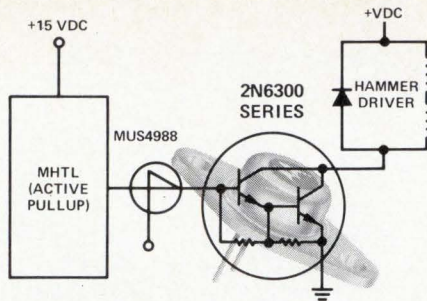

**... In IC-Driven Applications**

*High-Performance Series Pass Regulator*-Better than 0.03% performance is realized with this 2 A Darlington/MC1723 hookup. The capacitor between pins 4 and 13 provides frequency compensation for

the MC1723. The new 2N6294-95 series Darlington, with typical gain specs of 3,000 at 2 A  $I_C$ , greatly boost load current since the regulator will only source up to 150 mA. Go from milliamperes to amperes directly, compatibly, easily.

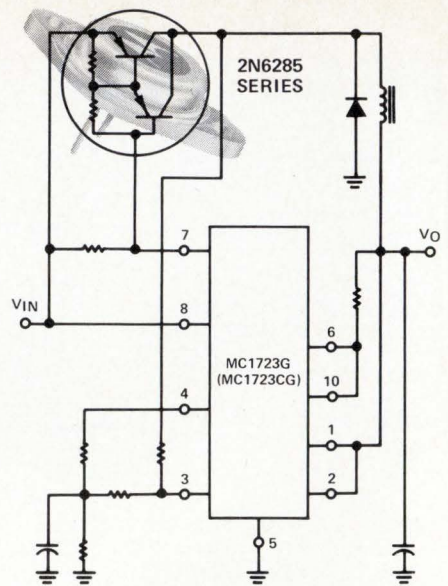

**... In High-Power Applications**

*High-Performance Switching Regulator*-The new 2N6282/6284 Darlington can be used in this regulator to furnish 2,400 typical gain at 10 A. Switching regulators are especially useful in reducing power dissipation in a circuit requiring a large input voltage and producing a small output voltage. Darlington simplifies!

# Gain Command With

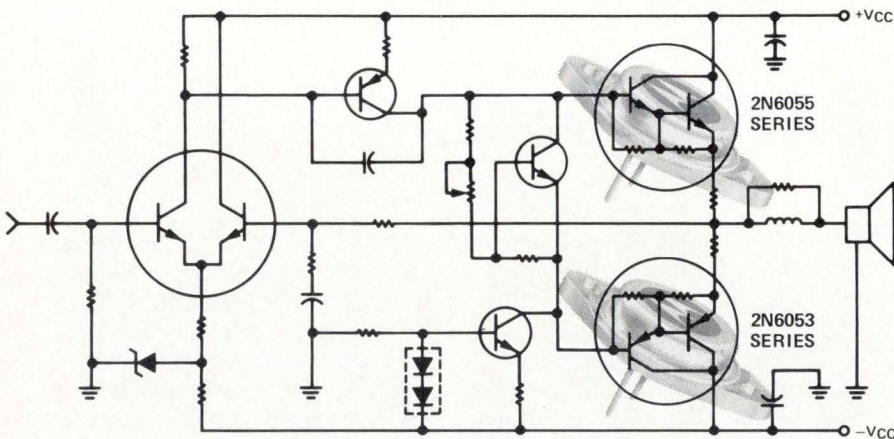

**... In Complementary Applications**

*15 to 60 W Power Amplifier*-Typical gain of 3,000 at 4 A with the new 2N6053-55 NPN/PNP Darlington complements ensures significant simplification and cost savings in complementary power amps. The

circuit features zero center voltage for maximum signal swing, 100% dc feedback, automatic offset voltage correction and noise and hum filtering. Amplify your gain specs with Darlington.

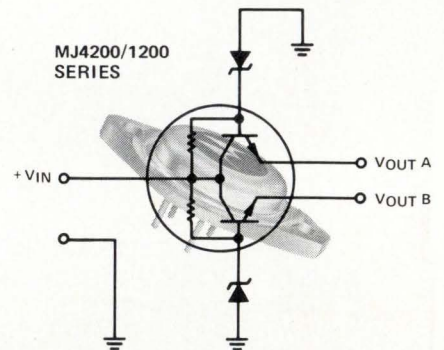

**... In Dual Applications**

*Split Voltage Power Supply*-Simpler, lower-cost, split power supplies using just one 4-lead discrete power package containing two drivers, two output devices and emitter-base resistors are easy with the new 2 and 4 A MJ4200/1200 Darlington. Providing 3,000 typical gain, the units are common-collector-connected to give 2 separate output voltages.

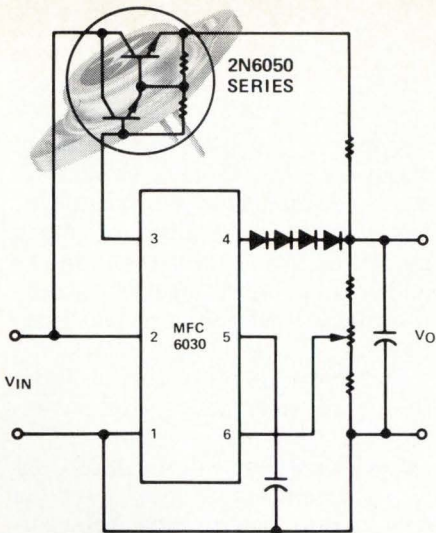

**... In General-Purpose, "2N3055" Applications**

**Short-Circuit Protected Power Supply**—For this economical functional circuit supply, load regulation is 0.08% when used as a 5 V regulator. The 4 and 6 A 2N6057/6059 series Darlington provide 4,000 typical gain figures and include the new 2N6055 Darlington — a direct, plug-in replacement for the industry-standard, general-purpose 2N3055 and its driver!

**New Darlingtons . . .**

NPN	PNP	Package	$V_{CEO(sus)}$ V Max.	$P_D$ W	$h_{FE}$ @ $I_C$ Min	Price Range 100-999	
						NPN	PNP
2N6294-95	2N6296-97	TO-66	60-80	50	750 @ 2 A	\$1.30-\$1.65	\$1.80-\$2.25
MJ4200-01 Dual	MJ4210-11 Dual	4-Lead TO-3	60-80	50	750 @ 2 A	3.50- 4.30	3.90- 4.80
MJ1200-01 Dual	MJ920-21 Dual	4-Lead TO-3	60-80	90	750 @ 4 A	4.90- 5.80	5.90- 6.80
2N6055-56	2N6053-54	TO-3	60-80	100	750 @ 4 A	1.72- 2.07	2.43- 2.88
2N6300-01	2N6298-99	TO-66	60-80	75	750 @ 4 A	1.67- 2.02	2.38- 2.83
2N6057-9	2N6050-52	TO-3	60-100	150	750 @ 6 A	2.54- 3.54	3.25- 4.36
2N6282-84	2N6285-87	TO-3	60-100	160	750 @ 10 A	4.30- 5.20	4.55- 5.65

**Darlington Introduced . . .**

Complementary Series	Package	$h_{FE}$ @ $I_C$ Min.	Pair Price (60 V) 100-999
MJE700/800	Plastic THERMOPAD	750 @ 1.5, 2 A	\$2.62
MJ4000/4001	TO-3	1,000 @ 1.5	3.20
MJ900/1000	TO-3	1,000 @ 3 A	3.85
MJE1090/1100	Plastic THERMOPAD	750 @ 3, 4 A	3.45
MJ2500/3000	TO-3	1,000 @ 5 A	5.40
MJ4030/4033	TO-3	1,000 @ 10 A	8.50

# More Power Darlingtons

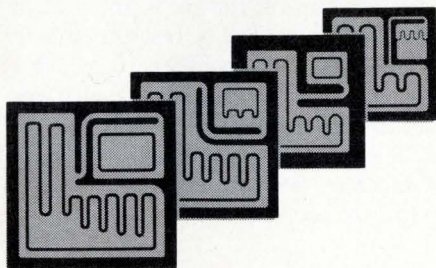

**EpiBase\* Makes It Possible . . .**

Only EpiBase technology possesses inherent capability to yield complementary Darlingtons — all possessing higher gain with better linearity, more chip sizes, higher frequency, lower saturation voltages and lower

cost than other processes.

Select from 33 complementary, metal and plastic, Motorola Darlington pairs now. And write us at Box 20912, Phoenix, AZ 85036 for complete Darlington data.

**Special Offer!**

Get a \$1.72 2N6055 NPN Darlington for \$1.05 . . . the same 100-up price as a 2N3055! Get 750 minimum gain at 4 A . . . plus all the space, time and money-saving advantages inherent in Darlington design for your prototype relay and solenoid drivers, audio/servo amplifiers, power supply and series pass regulators. Fill in and send the coupon to your Motorola distributor . . . he'll respond with your 2N6055 Darlington in a hurry!

To: (distributor) \_\_\_\_\_

I want to gain Darlington command in my power circuits — send me a 2N6055 for the price of a 2N3055 today . . . only \$1.05!

Name \_\_\_\_\_ Title \_\_\_\_\_

Company \_\_\_\_\_

Address \_\_\_\_\_

City \_\_\_\_\_ State \_\_\_\_\_ Zip \_\_\_\_\_

(Offer expires April 30, 1972)



**MOTOROLA POWER**  
— Complements Of A Friend

\*Trademark of Motorola Inc.

# More power to you!

In fact, our model 320L delivers the most power and widest bandwidth of any solid state instrument amplifier available. Easily mated with a wide variety of signal sources, it amplifies AM, FM, SSB, TV, Pulse and other complex modulations with minimum distortion. Constant forward power is continuously available regardless of load match (from an open to a short). The 320L provides over 20 watts of power from 100 KHz to 125 MHz with useful output all the way to 160 MHz . . . and there's no tuning.

Applications include:

- RFI/EMI testing
- NMR Spectroscopy
- Transmitter applications
- Laser modulation
- Signal distribution
- Test equipment calibration
- Cable isolation

For complete information write or call  
Electronic Navigation Industries,  
3000 Winton Road South,  
Rochester, New York 14623.  
(716) 473-6900

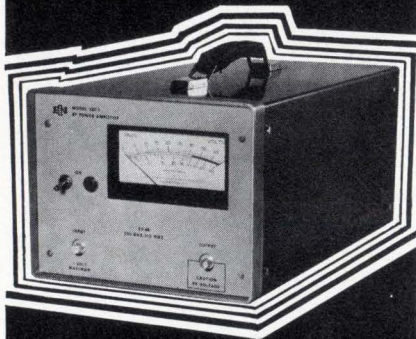

**EN** ELECTRONIC  
NAVIGATION  
INDUSTRIES

## People

Connors: look out, world,  
here comes Motorola

"I think Motorola has been a dull company. Not static; just dull, plodding, and inbred—but still a very successful company. The divisions haven't necessarily been like that, but the corporate entity has."

Those are strong words from a newly appointed manager of a division, but no one who knows Thomas J. Connors, 42, new general manager and vice president of Motorola's Semiconductor Products division, has ever accused him of being dull in word or deed.

Connors says that Motorola's major management shuffle "is the beginning of the outside world seeing the new Motorola. Motorola hasn't been known for its creative and aggressive approach, but that's going to change."

**Going slowly.** However he feels about a new day in the corporation, Connors believes that the changes themselves won't mean too much in the semiconductor operation for now. "There are no major problems here. I just need to get on board without screwing things up. And John Welty, the assistant general manager for the past few years, provides continuity of management."

"But," Connors adds, "I'm sure that there will be changes, since my style is different." That's surely an understatement; for Connors is quite an individualist. With his Western shirt, string tie, and high-heeled boots up on the table, the 6-ft.-3-in. Irishman appears, at first glance, to be the archetypal cowboy. But his accent is undeniably Boston Irish, and the dusty pickup he drives back and forth from his ranch to work is green. And then there's the ranch. Located in Scottsdale, it's home for his wife and nine children, five horses, and "at least one of everything that breathes" for children's pets.

Connors is a little more reticent about his cattle, though. "You don't ask a cowman how many cattle he has. It's just like asking how much money he has in the bank." But he adds, "Sometimes I feel like I only work here at Motorola so that I can buy hay."

In reality, Connors obviously derives great satisfaction from working—and from doing it right.

**Levy's mission.** But much of Connors' present enthusiasm is for the new venture activity now being organized by his predecessor, Steve

Levy. Connors sees in this the opportunity to work more closely with the rest of Motorola's present and future activities. He expects much of the new venture activity to involve semiconductors.

His enthusiasm for new ventures may result partly from his involve-

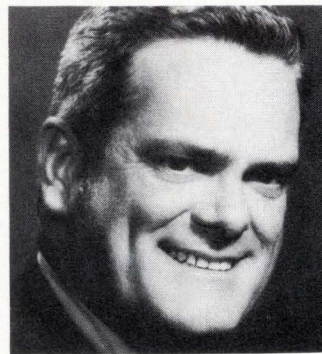

Putting an end to the dullness.

ment in some new activities during his three-year tenure in corporate marketing. Before that, he was marketing manager for the semiconductor division for six years, and in marketing at Texas Instruments in Dallas. Many observers were surprised when a marketing man was appointed head of the division, but Connors points out that he was in charge of Motorola's Control Systems division for a time.

Davis style helps Congress  
get technology watcher

"Being a judge is a very lonely job," says John Davis. That appraisal probably had some bearing on his resignation as judge of Georgia's Lookout Mountain Judicial Circuit in 1960 after five years of service to be elected to the U.S. House of Representatives.

Now, at 56, Davis describes himself as "a monomaniac with many manias." But Davis is best known as chairman of the Subcommittee on



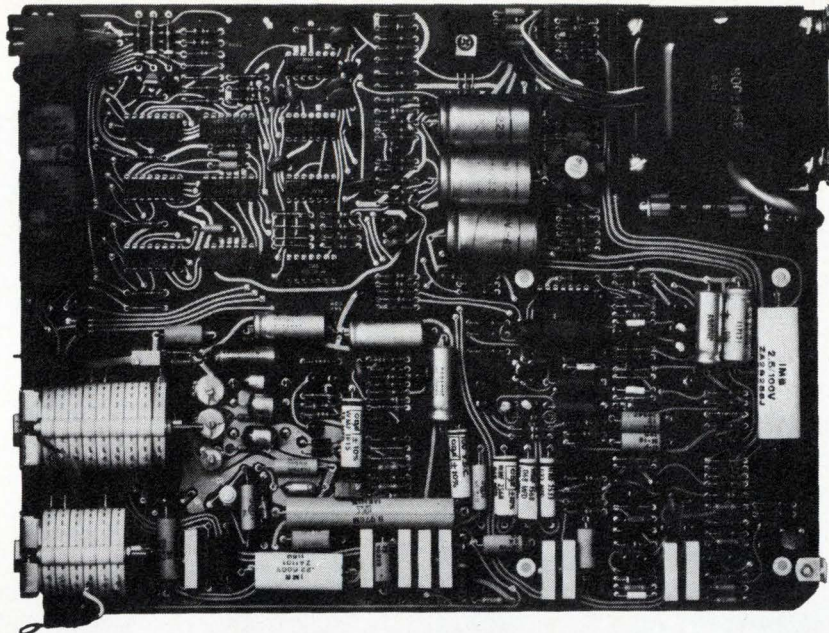

**This board contains over  
250 components.**

**Compatible FREON can  
economically clean the assembled  
board...residue-free.**

Put an end to costly piecemeal cleaning. FREON cleaning agents are compatible with most materials of construction, including polycarbonates. You can clean completely assembled boards without damage to substrates, components or markings. Remove all rosin-based flux and other contaminants at the same time. Get clean, dry, residue-free boards.

**Flux Removal.** A typical cycle for cleaning p.c. boards in a four-stage vapor defluxer is (1) gross removal of flux and contaminants in boiling FREON (below 118° F), (2) liquid rinse in FREON, (3) spray rinse, (4) final vapor-rinse in vapors of freshly distilled FREON.

**Low Solvent Replacement Cost.** FREON cleaning agents are constantly

recovered and purified for reuse. In a properly designed and operated defluxer, solvent losses are minimal.

**Purity.** FREON cleaning agents are electronic grade materials and chemically stable. No stabilizers or inhibitors are required.

**Safety.** FREON cleaning agents have a low order of toxicity. They are nonflammable and nonexplosive and do not require any special safety equipment.

**See what a difference a properly designed FREON cleaning system can make in your cleaning costs. Write for more information about FREON and cleaning and defluxing systems. Du Pont Company, Room 22448Q, Wilmington, Del. 19898.**



**FREON**  
cleaning agents

FREON is Du Pont's registered trademark for its fluorocarbon cleaning agents.



Davis: Georgian watches technology.

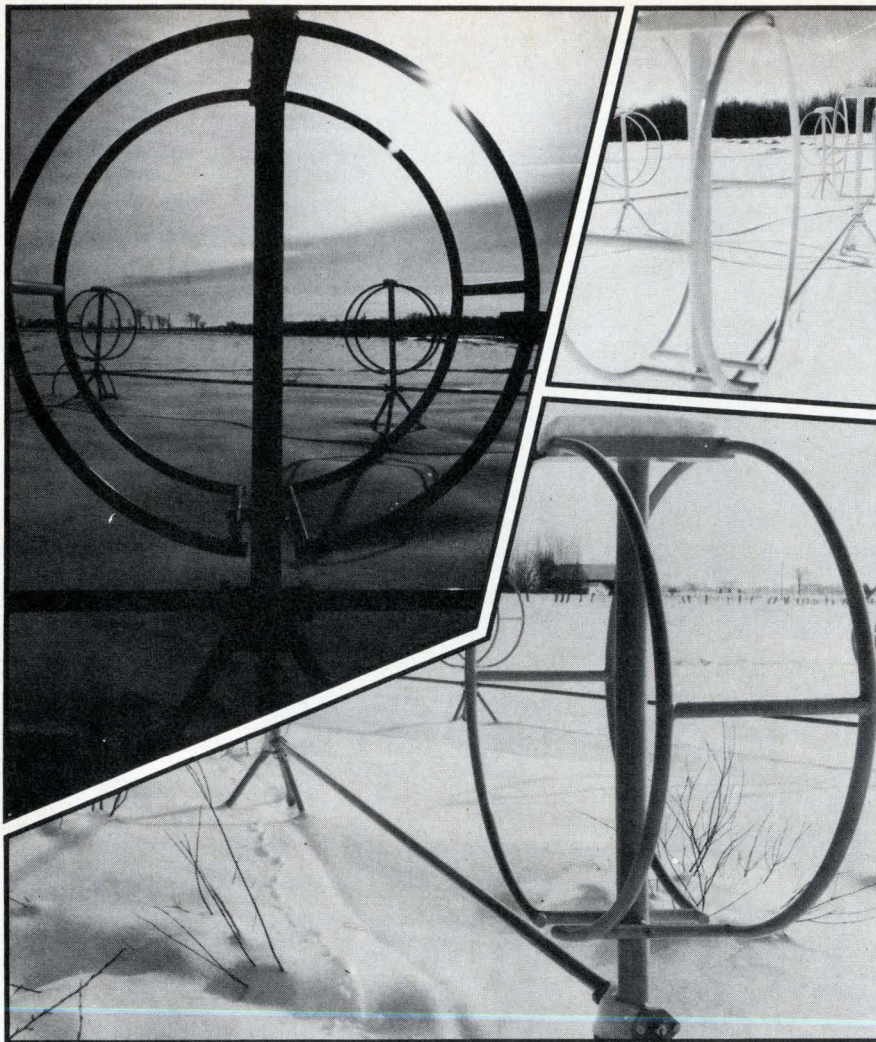

# Communications Men Think Big Small

The Canadian Broadcasting Corporation uses aperiodic loop antenna above .... and that's big and small.

Big ... at Britannia Heights, near the nation's Capital at Ottawa, Canadians listen to the world.

Small ... CBC listens on the aperiodic loop antenna which is only 50 meters in diameter in Rosette array.

Big ... Its omni-directional, point-to-point, broad band, long and short range receive capability is big enough to replace vast rhombic or log-periodic antenna farms.

That's why, whenever communications men think big and small, Hermes Electronics Ltd. supplies the aperiodic loop antenna to government agencies and military forces around the world.

Roof mountable, fast set up, small spaces, big jobs, or just below ground level *it snows a lot at Canada's Britannia Heights.*

ASK US

**Hermes Electronics Limited**

Suite 315  
2020 F Street N.W.  
WASHINGTON  
D.C., 20006  
Telephone 202 296-2978  
TWX 710-822-1106

Science, Research, and Development, who successfully guided through House passage earlier this month the bill to create an Office of Technology Assessment for the Congress. With good prospects for Senate passage, the OTA will give life and breath to an idea advanced six years ago by Davis's predecessor as chairman, Connecticut Democrat Emilio Q. Daddario.

Though Davis is first to credit the OTA concept to Daddario, there are others on Capitol Hill who suggest that only Davis, as a practitioner of politics as the art of the possible, could have achieved passage.

**Slick.** What Davis did with the 92nd Congress is take Daddario's bill introduced in 1970 and introduce it for himself with 24 other members as cosponsors. That was in February 1971. Subsequently, as the record shows, a companion bill was offered by 10 other new members of the committee. With this increased support, the subcommittee reported the bill "with no dissenting vote" to the full Committee on Science and Astronautics.

It approved the bill with several minor amendments and then reported "a clean bill containing the amendments" to the full House. Thus did Davis demonstrate a first rule of success in the Congress: do your work in committee, where no problem is insoluble.

What Davis has helped produce with OTA is an organization certain to have extensive impact on the future of technology in society. For the agency will give the Congress its first independent assessment of technological priorities. As one OTA backer put it, "the staff will owe primary loyalty to Congress and to the national welfare, not to any special interest group."

# our OEM power supply is very big in computers

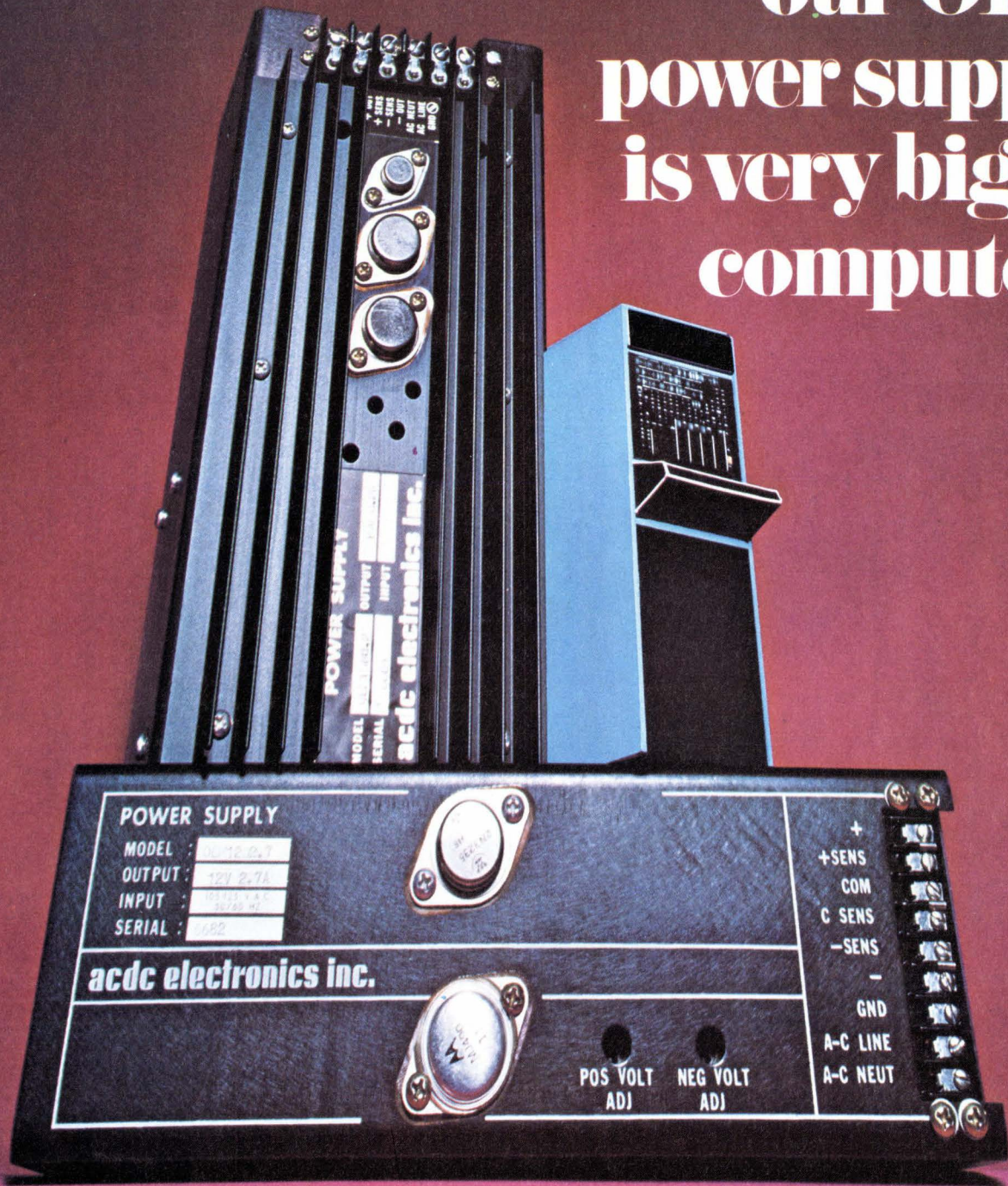

About a year ago, we introduced our new OEM power supply, a low-cost, off-the-shelf, 4-32 volt, 0.9-36 amp series. We sold a lot of them, especially for computer applications: 5v supplies for IC logic and  $\pm 12v$  and  $\pm 15v$  dual supplies for associated op amp circuitry. The price was right — starting at \$57 — and they had the features the industry needed: remote sensing, 0.1% regulation, overcurrent and overvoltage protection, remote programmability, UL approval, 50-60 Hz inputs, modular or rack-mounting capability, and ACDC's "guaranteed forever" performance.

Of course, there were some applications that the OEM series just couldn't handle. But it did open the doors for our specials. Specials with overtemperature or under-voltage protection; with locking fault indicators and interface logic signals for absolute protection of stored data; with dc energy storage for memory retention, on-off sequencing, etc. The point? . . . We make a quality line of standard power supplies — and specials too. So, if you're big in computers, why not talk to the company that's big in computer power supplies?

**acdc electronics inc.**

Oceanside Industrial Center, Oceanside, California 92054, (714) 757-1880

Circle 17 on reader service card

# Westinghouse Breaks Through!

## A big gain in high-power semiconductor technology

A true technological advance occurs when every obstacle is met head on. No sidestepping. And when you have what it takes—breakthrough!

We've done just this with a revolutionary breakthrough in high-power semiconductors.

We seal and stabilize the semiconductor element by passivating it with a unique Westinghouse process. This prevents degradation, even in assembly, and permits element stocking indefinitely.

We also use special and exclusive test devices and procedures like the concurrent tester, spreading resistance probe, HV test lab, and computer models to predict characteristics.

Then we assemble the element into a package with our exclusive compression-bonded encapsulation (CBE) process. This prevents thermal fatigue by eliminating the need for solder.

And our pace-conveyor assembly system enables us to assemble high-power rectifiers and thyristors (and special assemblies) faster than anyone else in the industry.

Advantages: For a start, a prearranged delivery schedule of more than 1500 different types of high-power semiconductors in our catalog. This includes customizing the package to your form factor and voltage rating. You can forget costly power semiconductor inventory, excessive lead time on orders, and plant downtime.

We'll also stock *your* power semiconductor elements for you. With your order, we'll give you your own storage area and maintain your inventory. In case of an emergency, we'll deliver on a guaranteed shipment basis.

Our "breakthrough" in high-power semiconductors is just the start. Ask about the benefits of Westinghouse research and development leadership in high-power semiconductors. For more information about "breakthrough," phone 412 925-7272 or write Paul E. Lego, General Manager, Westinghouse Semiconductor Division, Youngwood, Pa. 15697.

SC-1-72



You can be sure...if it's Westinghouse





# Think Twice:

## How will you choose your next portable scope ...on faith, or on fact?

Forget everything you ever knew about portable scopes; today's portables are something else entirely. In the last year, both major scope manufacturers have brought out completely new lines. So, choosing a new portable on "blind faith" in your old make is about as sensible as marrying a girl you've never met, just because her second cousin was Miss America in 1967.

The only rational way to choose a new portable today is to make a head-on comparison between our scopes and our competitor's. And this means more than just a quick look at price tags and specs. It means a thorough investigation of total acquisition cost. Be sure you check these specific points:

*Initial purchase price.* Are you getting the best price available? HP's Portables are priced as much as \$200 below the competition, with special purchase agreements available.

*Ease of Use.* Are the controls simple and logical? Or are they a jungle of tightly packed knobs. Ten minutes a day, spent in needless tinkering, can add up to hundreds of

dollars a year in wasted man-hours.

*Fieldworthiness.* Some scopes have such high power requirements that battery operation is impossible. HP feels that a portable scope should have "go-anywhere" capabilities, so our Portables all use low-power-requirement designs which permit battery operation. Low power requirements also mean lower heat, which prolongs component life. As a result, only HP's Portables eliminate the need for fans, or dust-admitting vent holes.

*Calibration and Service.* Have you considered how much your scope will cost you *after* you've purchased it? For example, HP Portables are quickly calibrated — requiring approximately half the time required to calibrate our competitor's portable scope. This could save you hundreds of dollars over the life of your scope. And are you going to have to deal with one manufacturer for scope service, and another for your voltmeters, signal sources, etc.? Or can you save time and money by limiting your dealings to one company? And don't forget training aids; HP offers live

demonstrations, video tapes and literature to simplify conversion problems.

Look into all these points, and we think you'll find that you'll save a lot of time, effort, and money — and avoid a lot of frustration — by choosing HP's Portables. But don't take our word for it; make the comparisons yourself.

For a revealing package of information on HP's new Portables, send for a free copy of our "No-Nonsense Guide to Oscilloscope Selection." Or contact your local HP field engineer for a demonstration. Check before you choose. Hewlett-Packard, Palo Alto, California 94304. In Europe: 1217 Meyrin-Geneva, Switzerland.

**Scopes Are Changing;  
Think Twice.**

082/2

HEWLETT  PACKARD

O S C I L L O S C O P E S

This?

or This?

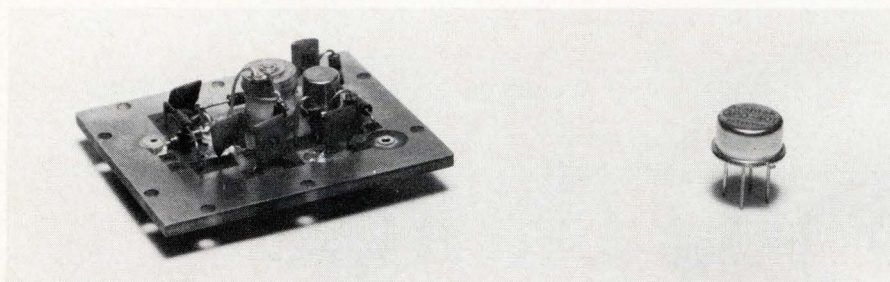

**Avantek's GPD replaces up to 15 different components (and as many as 50 engineering manhours) at any frequency from 5 to 400 MHz... and it's cascadable.\***

Avantek's inexpensive GPD (General Purpose Device) is packaged in a miniature TO-12 transistor can and serves as a completely cascadable thin film amplifier without bandwidth shrinkage.

The GPD consolidates all the functions of multiple resistors, capacitors, RF coils and a silicon transistor chip into a highly reliable unit of gain that minimizes assembly time as well as inventory requirements.

Avantek offers a series of three GPD models, featuring either 9 or 13 dB minimum gain and typical power outputs ranging from -2 to +15 dBm. Send for full performance specifications or, better yet, fill in the coupon below to order a sample set of three GPD's at more than 1/3 off the list price.

\*U.S. Patent No. 3493882

## Avantek ... Years Ahead Today

2981 Copper Road, Santa Clara, CA 95051

- Send full information on your new GPD amplifier series.
- Rush a sample set of your three GPD amplifier models for only \$99.95 (list price \$160.00).

NAME \_\_\_\_\_

TITLE \_\_\_\_\_

COMPANY \_\_\_\_\_ P.O.# \_\_\_\_\_

ADDRESS \_\_\_\_\_ ZIP \_\_\_\_\_

## Meetings

**International Electronic Components Exhibition:** FNIE, Parc des Expositions, Porte de Versailles, Paris, April 6-11.

**International Geoscience Electronics Symposium:** IEEE, Marriott Twin Bridges Motor Hotel, Washington, D.C., April 9-14.

**International Conf. on Magnetics (INTERMAG):** IEE, Kyoto International Conference Hall, Kyoto, Japan, April 19-21.

**International Symposium on Circuit Theory:** IEEE, Sheraton-University Hotel, Universal City, Calif., April 19-21.

**Southwestern IEEE Conf. & Exhibition (SWIEECCO):** IEEE, Baker Hotel & Dallas Mem. Aud., Dallas, Texas, April 19-21.

**Conf. on Computer Aided Design:** IEEE, IEE, University of Southampton, Southampton, England, April 25-28.

**National Telemetry Conf.:** IEEE, Houston Shamrock Hilton Hotel, Houston, Texas, May 1-5.

**Electrochemical Society Spring Meeting:** Electrochem. Soc., Shamrock Hilton, Houston, Texas, May 5-12.

**Quantum Electronics:** IEEE, AIP, OSA, APA, Queen Elizabeth Hotel, Montreal, Canada, May 7-11.

**International Semiconductor Power Converter Conf.:** IEEE, Baltimore Hilton Hotel, Baltimore, Md., May 7-10.

**Spring Joint Computer Conf.:** IEEE, Convention Center, Atlantic City, N.J., May 15-18.

**Aerospace Electronics Conf.:** IEEE, Sheraton Dayton Hotel, Dayton, Ohio, May 15-17.

**Microwave Power Symposium:** Microwave Power Institute, Chateau Laurier Hotel, Ottawa, Canada, May 23-25.



# PTM. First in the series of new modulars from Sorensen

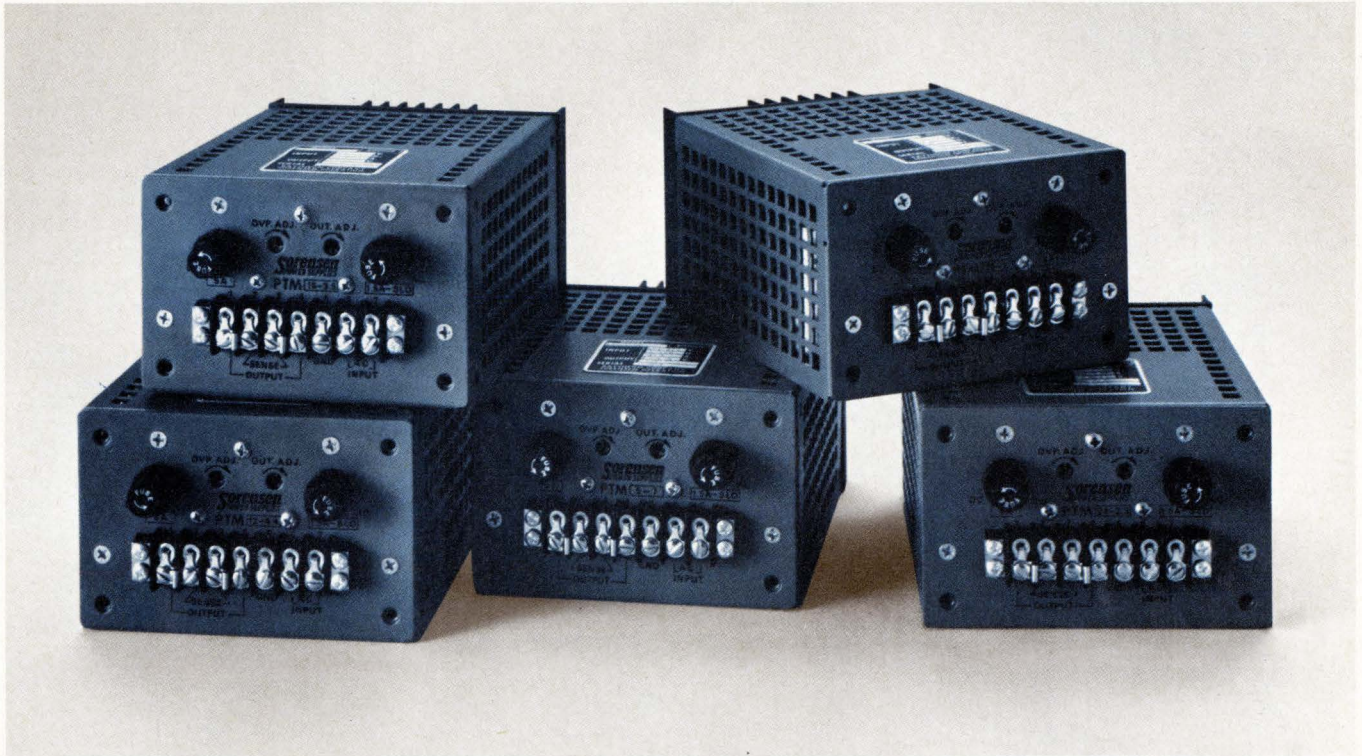

Our new PTM modular line is tailored to be more than just another black box. For one thing, it's blue. For another, it has state-of-the-art power density. Built-in overvoltage protection on every model.

Adjustable automatic current limiting. Regulation of 0.05% + 5mV. Ripple and noise of 1 mV RMS, 5mV pk-pk. Operating temperature range from 0 to 71°C. □ PTM. The first part of our new modular line. There's a lot more coming. For more data, write Sorensen Power Supplies, Raytheon Company, 676 Island Pond Road, Manchester, N.H. 03103. Telephone (603) 668-1600. Or TWX 710-220-1339.

Package size II: 3 3/8 x 5 1/8 x 6 1/2								
Model	Adjust. Range (VDC)		Current Rating (A)				Price*	
	Min.	Max.	40°C	50°C	60°C	71°C		
PTM3-7	2.8	3.5	7.0	6.3	4.9	2.8	\$119	
PTM5-7	4.8	5.5	7.0	6.3	4.9	2.8	\$119	
PTM12-4.4	11.4	12.6	4.4	4.0	3.1	1.8	\$119	
PTM15-3.5	14.25	15.75	3.5	3.1	2.5	1.6	\$119	
PTM24-2.3	23	25	2.3	2.1	1.7	1.1	\$119	
PTM28-2	27	29	2.0	1.8	1.5	1.0	\$119	
Package size III: 3 3/8 x 5 1/8 x 9 1/2								
PTM3-11	2.8	3.5	11.0	9.6	7.8	4.4	\$139	
PTM5-11	4.8	5.5	11.0	9.6	7.8	4.4	\$139	
PTM12-6.5	11.4	12.6	6.5	5.7	4.6	2.7	\$139	
PTM15-5.5	14.25	15.75	5.5	4.9	3.9	2.5	\$139	
PTM24-4	23	25	4.0	3.6	2.9	1.9	\$139	
PTM28-3.5	27	29	3.5	3.1	2.6	1.8	\$139	

**Sorensen**  
POWER SUPPLIES

\*USA List

# As a Brand Decider\* for power supplies, you need all the help you can get, right?

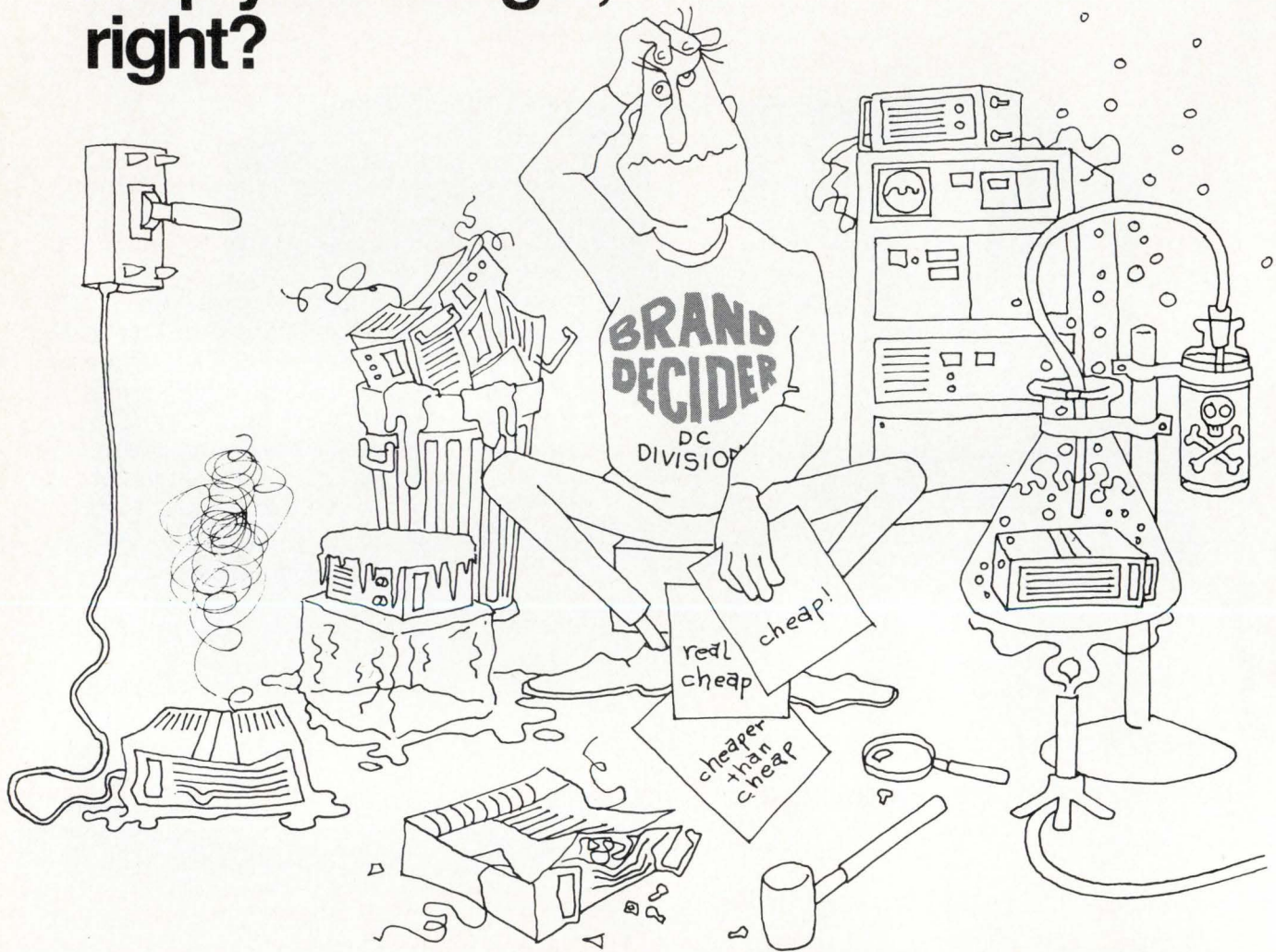

NJE wants to help you, the Brand Decider. Help you get a fresh perspective on the quality, price, performance and interchangeability of more than 100 high-performance DC system supplies. Frankly, they are our new RS series of OEM/modular supplies. To be candid about it, these modular supplies compete with the Lambda LM/LX series, as well as North Electric and other modular supplies—in every way, from price right down to hole-mountings.

For example, our model RSB-5/OVP meets or exceeds the Lambda equivalents in the LM or LX series

in specifications and price (e.g. RSB-5/OVP vs. LXSB-5-OV:  $\pm 10\%$  voltage adjustment vs.  $\pm 5\%$ ; .01% load and line regulation vs. .1%; 6A vs. 5.8A at 40°C; \$104 vs. \$125).

NJE prices are low, but we didn't compromise on quality, or performance, or reliability—we just designed carefully and manufactured smartly.

For complete details, we'll send you our 1972 "Power Supplies Unlimited". Twenty pages of specifications and details cunningly calculated to give you an easy time in selecting your power supplies. For your copy, write or call NJE

Corporation, P.O. Box 50, Culver Road, Dayton, N.J. 08810. Phone (201) 329-4616. TWX: Consult new directory.

*\*A Brand Decider, according to the definition developed by John Morrill Company, marketing research group, is the person who has major influence in recommending or switching a manufacturer's brand.*

**ALL NJE POWER SUPPLIES GUARANTEED FOR FIVE YEARS.**

# NJE

---

# Electronics Newsletter

---

[*Electronics*, May 15, 1967, p. 141]. It was to have been four times its present size and completed in 1969. Conceived and headed by Daniel L. Slotnick, a professor at the University of Illinois (hence the name Illiac), **the project has been through an almost unprecedented series of financial and technical difficulties** [*Electronics*, April 14, 1969, p. 47]. Now, however, the machine has survived these tribulations and is scheduled for installation at the NASA-Ames Research Center near Mountain View, Calif. There, it will be accessible to the University of Illinois and other major computation centers across the nation through the Advanced Research Projects Agency's computer network.

## Westinghouse puts MNOS memory into meter-reader

A recently developed metal-nitride-oxide counter/memory has been incorporated by Westinghouse Electric in a remote meter-reading system. **The device is used in the system, which is being tested at several locations, to store meter inputs.**

Like others similar to it in concept, the system is designed to transmit data over standard phone lines to central billing offices. **And there's the rub: AT&T hasn't been greeting prospective users of its lines with open arms.** But Westinghouse might be in a strong position because of its long-established relationship with public utilities as a supplier of meter equipment, a relationship that the company also believes makes the remote-reading market a natural. Westinghouse sees **the most promising locations for remote readers as large-user installations**, such as apartment houses, where reading individual meters is difficult and expensive, and occasionally perilous.

**The MNOS memory itself does not lose data when the power is removed**, a key condition of remote systems: they would be uneconomical if power were required at all times. The Westinghouse system would be powered only when the meter is interrogated. The system is equipped with a 10-stage counter, with memory. It can count up to 1,000 input bits, store the data, and then, on command, provide serial output data that includes the metered count, externally programable identification bits, and a parity equiizer.

## Expand or shrink, warns TI's Bucy

If U.S. electronics industries are to avoid the stagnation of the electrical utility and agricultural industries, **they must channel technology into nontraditional markets**, warns J. Fred Bucy, corporate group vice president of Texas Instruments. In a panel session at the International Solid State Circuits Conference in Philadelphia earlier this month, Bucy pointed out that electronics production, expressed as a percentage of the Gross National Product, **has declined over the last three years**, a sign of maturity that bodes ill unless new growth in a variety of directions can be stimulated.

Bucy says that electronics must be diffused to pervade our entire industrial and social structure. If only the traditional equipment market is addressed, he said, **by 1980 electronics will grow only moderately to \$80 billion, or 1.7% of the GNP.** But if a major effort is made to penetrate new markets with electronics, **the potential is for a world market of \$110 billion or 2.3% of the GNP.**

Bucy called for a reordering of priorities to assure the required pervasiveness. "The time has come to tackle problems that are not now being solved," he said. "We should ask ourselves if we really need new and better computers, radios, TVs, and stereos."

---

# Electronics Newsletter

---

February 28, 1972

## **Bipolar logic offers 1,000 gates on 130-mil<sup>2</sup> chip**

Workers in IBM's Boeblingen, West Germany, laboratory have developed an LSI logic concept that promises **gate densities of better than 100 gates per square millimeter, or 1,000 on a 130-by-130-mil chip.**

The novel bipolar logic concept, **based on the principle of direct injection of minority carriers into the switching transistor**, eliminates the problem of device isolation and reduces the process complexity to that of a single planar transistor requiring only four mask steps. This, and the elimination of ohmic resistors, results in the greatly reduced device size and low-cost prospects. Significantly, despite the simple technology, **excellent power delay products are obtained**—better than 0.35 picojoules for delays above 100 nanoseconds, according to Siegfried Wiedmann, one of the IBM engineers responsible for the development [*Electronics*, Feb. 14, p. 84].

## **Intersil becomes second source for dielectric isolation**

Harris Semiconductor is no longer alone in fighting the battle for dielectric isolation in linear integrated circuits. Beginning next month, **Intersil Inc., Cupertino, Calif., will begin delivering the Harris series 2500 dielectrically isolated high-slew-rate operational amplifiers.** These will be followed by the 2600 series of high-input-impedance op amps and the 2700 series of low-power op amps.

For about a year, Harris has been expounding the virtues of dielectric isolation, while the rest of the semiconductor industry has been saying that the process is too complex and too costly. **Intersil, however, agrees with Harris that the improvement in specifications, such as a slew rate of 120 volts per millisecond without positive feedback compensation, are well worth the trouble.** Intersil chose to design the 2500 series first because it's the most difficult part to build—not only requiring dielectric isolation processing, but also precision thin-film resistors on the chip.

## **Integrated Gunn, Impatt amplifier for X band**

**The traveling-wave-tube amplifier, which has had a stranglehold on X-band communications links, is facing competition.** Hewlett-Packard has developed a two-stage device consisting of a varactor-tuned Gunn diode first stage and a fixed-tuned Impatt diode second stage. It features thin-film circuit design and has 30 decibels of gain and 1-watt output.

An injection-locked oscillator design is used, according to D.C. Hanson, product manager, "to allow higher efficiency, less temperature sensitivity, and lower costs."

**Hewlett-Packard hopes that with a price around \$800 it will be able to penetrate the microwave relay market** for communication bands in the 10.7-to-13.2-gigahertz region.

## **Illiac 4 almost ready for shipment**

The giant Illiac 4 parallel processor is nearing completion at the Burroughs Corp.'s laboratories in Paoli, Pa., **and should be ready for shipment in April.** All 64 processors in the system have been installed and debugged. They are running as a system in maintenance mode, and engineers at the lab are now working on the input-output interface.

Burroughs has been working on the machine for almost five years

Somewhere  
sometime  
someone  
will unveil the total  
semiconductor test system.  
A system that can swing from MOS to bipolar.  
A system for discretes, IC's or LSI.  
A system for production or engineering.  
With software compatible to all.

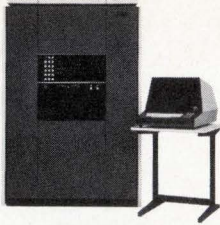

Sentry 100

Optimized for low-cost high throughput, MSI bipolar production testing.

Low cost and fast throughput make the Sentry 100 the perfect MSI bipolar production testing system for semiconductor users and producers. The Sentry 100 tests bipolar devices faster than any other system. And it costs less to buy. The 100 carries an entry cost lower than any other Sentry or any comparable testing system.

Average cost per good unit delivered can be less than 1/10 of a cent. This includes labor and amortization of capital cost (3 year amortization) of a four way multiplexed system with four wafer probers.

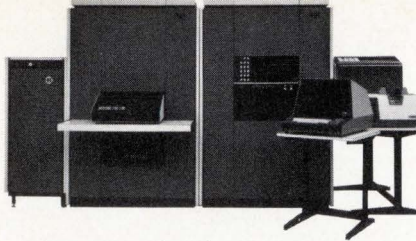

Sentry 300

Optimized for printed circuit board testing.

The Sentry 300 has the hardware configuration, massive memory, and powerful software necessary for printed circuit board testing. Relatively unskilled workers can test and isolate board faults. Multiplexing provides separate stations for go/no go testing and the fault isolation. Fault isolation software diagnoses bad cards without the need for standard card. Computer aided program generation of printed circuit board test programs is available.

The 300 has the capacity and versatility necessary to meet the requirements of equipment manufacturers, test centers, and repair depots.



Sentry 500

Optimized for MOS/LSI production testing.

The Sentry 500 tests MOS/LSI faster than any other system.

Yet it costs less to buy. This is possible because the 500 is a throughput-oriented system. Non-essential analytical hardware has been eliminated to give the producer more throughput per dollar.

High speed test stations deliver complete functional testing capability at 5 MHz data rate /20 MHz nominal four phase clock rate in both finished package and wafer probe environment. Data/clock input and output comparator strobe can be precisely and independently timed. Any pin of the tester can be programmed as data input driver, clock driver, input bias, or output detector without "pin swap" boxes. Any pin can be switched from input to output at real time rates under software control. Device response time at wafer and final test can be determined in only one test period.

# The

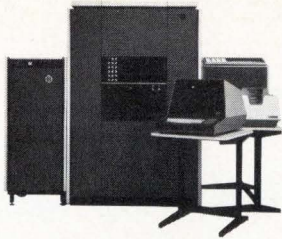

Sentry 200



Sentry 400

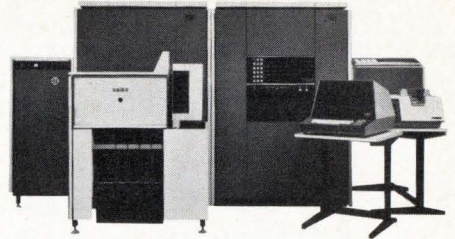

Sentry 600

Optimized for MSI bipolar engineering, QA and test center operations.

The Sentry 200 produces maximum device characterization per dollar of investment. An extremely versatile analytical tool, the 200 manipulates massive data, handles arithmetic computation, datalogs every desired parameter of every device tested, reports statistical distributions, and provides the capacity to study in depth the effect of environmental and electrical stress.

Combining versatile device characterization with low entry cost, the 200 is the right system for bipolar, quality assurance, and reliability testing.

Optimized for large manufacturers and military buyers.

The Sentry 400, the base system for the Sentry series, continues as a general purpose circuit testing system. With a greater than order of magnitude improvement in capability, Sentry 400 can test at as many as four stations with up to 120 terminals each at rates some 30 times faster than previous systems. Sentry 400 remains an excellent investment for large manufacturers and military users.

Optimized for MOS/LSI, engineering, sophisticated production needs, QA and test center operations.

Sentry 600 offers the most sophisticated analytical tool available for MOS/LSI engineering and production. It performs the widest range of tests for the broadest range of components.

At user option, the 600 can perform high speed MOS/LSI and bipolar tests simultaneously. It offers complete testing at wafer level and in automatic handlers at 5 MHz data rate /20 MHz nominal four phase clock rate.

The widest choice of peripherals give the system massive data handling capacity. Manipulate. Analyze. Compute. Sentry 600 is the system for MOS/LSI analysis.

# System

*Fairchild's Sentry System is six systems in one. An innovation in test systems. Each individual system component is a system all its own. Optimized to a specific testing function, but fully capable of handling all others.*

*Each component uses the same software. FACTOR. A proprietary language similar to ALGOL or FORTRAN. It's already written. Ready to use.*

*The Sentry System carries no up-grade or down-grade penalties. Start with any component, build either way. No loss of capability. No additional costs.*

*The Sentry System is fast too. Fast enough to give you the lowest throughput costs in the industry.*

*For complete details write or call. We have a free literature packet waiting.*

*Fairchild Systems Technology. A division of Fairchild Camera and Instrument Corporation. 974 East Arques Avenue, Sunnyvale, California 94086 (408) 735-5011.*



# MOSTEK MOS

## ion-implanted for high performance!

## easy to use...now easier than ever to buy!

### RAMS

#### MK 4002 P

64 x 4 static TTL/DTL compatible RAM.

#### MK 4006 P, MK 4008 P

1024 x 1 TTL/DTL compatible RAM; dynamic storage but no clocks required; 400 ns access times available; 16-pin package.

#### MK 4007 P

256 x 1, pin-for-pin replacement for 1101 but with less than 250 mW of power and wide -6.5 to -15 V negative supply range.

(RS 110)

### ROMS

#### MK 2002 P, MK 2101 P, MK 2302 P, MK 2408 P, MK 3101

Character generators; 64 characters, 5 x 7 dot matrix.

#### MK 2400 P

256 x 10 TTL/DTL compatible ROM with 550 ns cycle times.

(RS 111)

### CALCULATORS

#### MK 5010 P

Single IC, four function (+ × - ÷) 10-digit calculator with display decoder, multiplexing circuitry, leading-zero blanking.

#### MK 5012 P

12-digit version of MK 5010 P.

#### MK 5013/5014 P

IC pair; four function 12-digit calculator with display circuitry, 1 memory, automatic constant, selectable 5/4 roundoff or truncate, leading-zero blanking. Printer interface chip to be available.

(RS 112)

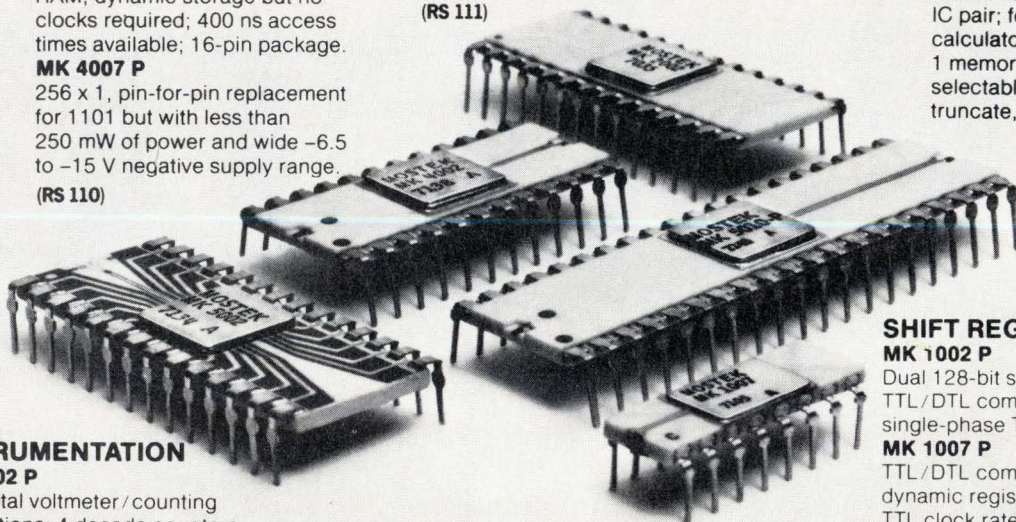

### INSTRUMENTATION

#### MK 5002 P

For digital voltmeter / counting applications: 4 decade counters; storage; display; multiplexing; single + 5 to 20 V supply; power under 25 mW.

(RS 114)

MOSTEK has made MOS easy to use and added unique MOS/LSI performance capabilities through its ion-implantation techniques. Now MOSTEK has made its standard

Circle appropriate Reader Service (RS) numbers.

products more available than ever before thanks to a new network of distributors and representatives. Call the one nearest you *today* for information and off-the-shelf delivery.

**MOSTEK**  
CORPORATION

1400 Upfield Drive  
Carrollton, Texas 75006

**Regional Sales Offices:** West: 11222 La Cienega Boulevard, Inglewood, Calif. 90304 (213) 649-2600. East: 60 Turner Street, Waltham, Mass. 02154 (617) 899-9107. Midwest/Southeast: 515 S. W. Avenue, Jackson, Michigan 49203 (517) 787-0508.

**Representatives:** HMR Inc., Minneapolis, Minn. (612) 920-8200. W. J. Purdy Co., Burlingame, Calif. (415) 347-7701. Littleton, Colo. (303) 794-4225. KCE Corp., San Diego, Calif. (714) 278-7640. Los Angeles, Calif. (213) 391-0586. Sheridan Associates, Inc., Cincinnati, Ohio (513) 761-5432. Florissant, Missouri (314) 837-5200. Cleveland, Ohio (216) 524-8120. Dayton, Ohio (513) 277-8911. Lathrup Village, Mich. (313) 358-3333. Pittsburgh, Pa. (412) 243-6655. FM Associates Ltd., Greensboro, N. Carolina (919) 294-2754. Huntsville, Ala. (205) 536-9990. Orlando, Fla. (305) 851-5710. Sprague Electric Co., Wayne, New Jersey (201) 696-8200. Schiller Park, Ill. (312) 678-2262. Richardson, Texas (214) 235-1256. Tempe, Arizona (602) 966-7233. N. Seattle, Wash. (206) 632-7761. Precision Electronics, Inc., Glenside, Pa. (215) M6-8383. The Addeem Group, Huntington Station, N.Y. (516) 567-5900.

**Distributors:** Cramer Electronics Inc.,—Alabama: Huntsville (205) 539-5772. Arizona: Phoenix (602) 263-1112. California: San Diego (714) 279-6300. Colorado: Denver (303) 758-2100; Connecticut: North Haven (203) 239-5641. Florida: Hollywood (305) 923-8181. Orlando (305) 841-1550. Georgia: Atlanta (404) 451-5421. Illinois: Mt. Prospect (312) 593-0230. Maryland: Baltimore (301) 354-0100. Gaithersburg (301) 354-0100. Massachusetts: Newton (617) 969-7700. Minnesota: Bloomington (612) 881-8678. New Jersey: Union, (201) 687-7870. Pennsauken (215) 923-5950. New Mexico: Albuquerque (515) 265-5767. New York: Hauppauge, L.I. (516) 231-5600. Endwell (607) 754-6661. Rochester (716) 275-0300. East Syracuse (315) 437-6671. North Carolina: Raleigh (919) 876-2371. Winston-Salem (919) 725-8711. Ohio: Cleveland (216) 248-7740. Cincinnati (513) 771-6441. Oklahoma: Tulsa (918) 836-3371. Texas: Dallas (214) 350-1355. Utah: Salt Lake City (801) 487-3681. Wisconsin: Milwaukee (414) 462-8300. Canada: Ontario (416) 630-5023. Brill Electronics, Oakland, Calif. (415) 834-5888. Elmar Electronics, Mt. View, Calif. (415) 961-3611. Liberty Electronics, Inglewood, Calif. (213) 776-6252. Wesco Electronics, Los Angeles, Calif. (213) 685-9533. Merquip Electronics, Skokie, Ill. (312) 965-7500. Stark Electronics Supply, Minneapolis, Minn. (612) 333-3361. Sheridan Sales Co., Cincinnati, Ohio (513) 761-5432.

**International:** MOSTEK GmbH, 7 Stuttgart 80, Waldburgstrasse 79, West Germany 0711-731305, System Marketing Inc., Center News Bldg., 1-3-11 Sotokanda, Chiyoda-ku, Tokyo, Japan; W. G. Booth Pty., Ltd., 39 Church Street, Hawthorn, Victoria 3122, Australia.

Circle 30 on reader service card



## IBM unveils first charge-transfer memory system

A new technology leaps out of the laboratory and into the real world with IBM's 5,760-bit buffer

IBM has built the first operating semiconductor memory system using charge-coupled devices. The achievement by the giant computer maker, though labeled "experimental," gets CCD technology out of the lab and into a potential working machine environment, and could mark the beginning of the charge-transfer era in computers.

The major advantage of charge-transfer devices is that they require no connections through the silicon, making them easier and cheaper to build than bipolar or MOS versions. Moreover, packing density is an order of magnitude greater per chip. As for what's immediately ahead,

### Making waves

IBM's presentation of a working charge-transfer memory will spur the interest of computer and instrument makers that traditionally look to IBM for technical direction. And researchers in the area are impressed by the advanced nature of IBM's charge-coupled devices. For example, it has built shift registers with extremely small cell sizes—down to 0.32 mil<sup>2</sup>, accommodating 3 million bits per square inch. Also, IBM has shift registers that can transfer data in lengths up to 256 bits without refreshing.

IBM has a well-earned reputation for being close-mouthed about its plans. But it has an equally well-earned reputation for announcing new developments only when they are tested and ready to be used.

The system, described at the International Solid State Circuits Conference in Philadelphia, is a 5,760-bit buffer memory. It's made up of two chips, each containing two 480-bit CCD shift registers connected in series. Each shift register consists of 10 CCD channels with a FET refresh amplifier every 48 bits. Six shift registers in series form each 2,880-bit buffer; two buffers make up a system.

**Fast and dense.** The structures are built with double-level metalization using both aluminum and polysilicon gates—construction that affords the transfer speed and bit-packing density required for computer systems. And, though 5,760-bit systems are small by computer standards, the CCD memory certainly can be expected to be scaled to larger memories.

The silicon-gate structure, similar to one developed by RCA, enables IBM to build memory cells with areas of only 2.08 square mils per bit, giving a total active area of 30 by 90 mils for the entire storage.

The complete memory is mounted on a 3.5-by-4.5-in. card along with logic and support circuitry, an arrangement electrically identical to that of IBM memory cards now in use. Its four-phase drive system transfers charge at a rate of 0.5 megahertz. The basic shift registers can be driven directly from standard diode-transistor logic—6 volts for a logic 1 and ground for logic 0. All told, the

### ISSCC coverage

IBM memory	31
GE memory	31
Gate circuits	32
A-d conversion	32
Optical isolator	33
Analog delay line	34

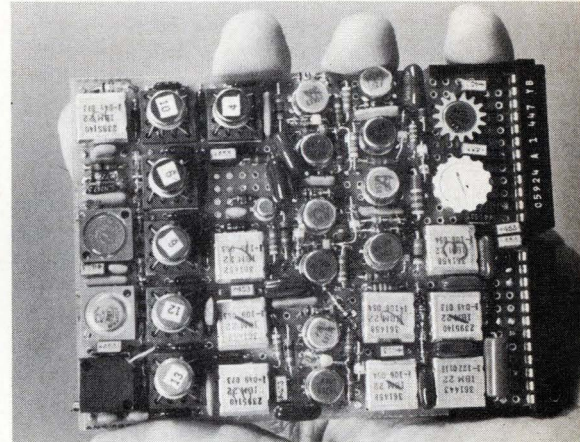

**Card trick.** Six 960-bit CCD memory modules with support circuitry are packaged on this 3.5-by-4.5-in. multilayer plug-in card to provide 5,760 bits of memory for IBM.

memory dissipates only 3.5 watts per card, about on a par with current shift register techniques. Card voltages are +6 V and -10 V.

### Memories

GE models surface charge for proposed RAM

Not to be outdone by IBM's charge-coupled memory system, General Electric has come up with a surface-charge dynamic random-access memory—the only charge-transfer device to date that isn't basically a shift register.

The device, developed at GE's Research and Technology Center in Schenectady, N.Y., is a 4-by-8-bit array and apparently is a model for a 4,096-bit memory. The area of each storage region is only 2.5 mils<sup>2</sup> per bit; and with an access time of 150 nanoseconds and a cycle time of

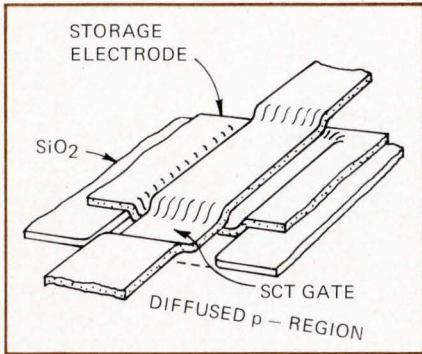

**Dynamic.** GE's surface-charge RAM offers an access time of 150 nanoseconds and a cycle time of only 250 nanoseconds.

250 ns, such memories would be appreciably faster than any MOS RAM now available.

GE's RAM is built with refractory metal MOS technology. The aim was to come up with a cell structure as simple as the single-transistor structure in recent MOS RAMs.

Richard Boertsch, one of the scientists who developed the GE device, points out that a common problem with these single transistor cells is that the capacitance of the bit line is very high, compared to that of a single cell, and leads to losses in logic signal levels.

This problem is overcome in the GE approach by transferring the charge from the storage region in the bit line, and then from the bit line to a low-capacitance detector node. In operation, the stored charge, represented as a binary 1, is transferred from the selected word to the bit line. When the potential of the word line is lowered, this charge flows along the bit line and spills over into the sense node. The difference between a one and a zero is sensed by a MOS FET connected to the sense node, which drives the output while refreshing stored data. It was described at the International Solid State Circuits Conference.

Gate circuits for memory trim total power demand

As power requirements of the new bipolar dynamic memories plunge to the microwatt-per-bit range, the peripheral on-chip selection circuits

have come to dominate chip power requirements. Indeed, many of these overhead circuits—for example, word and digit line selection—have become so power hungry that they can consume 80% of the needs of the chip, limiting packing density. To put a brake on such demands, Bell Telephone Laboratories in Murray Hill, N.J., has developed a gate-switching cell constructed like the dynamic memory itself, and described it at the International Solid State Circuits Conference. As a result, the cell dissipates less than 100 microwatts, reducing power 10 to 100 times from conventional transistor-transistor logic gates.

Like dynamic memory cells, the Bell gates draw power only when they are in operation—and in the static mode, none whatsoever. Since gates are typically on for only a few nanoseconds, requirements are a fraction of these of the TTL gates that draw power even when off.

**Use charge storage.** According to Bell's Jerry Mar, one of the principal researchers developing the gates, the cells utilize charge storage to place them in the proper state of operation. A narrow pulse is applied to the gate to turn it on so that it can pass desired signal. A second pulse turns the gate off. The gate is on only during the interval between the pair of pulse so significantly, the gate can be on for as long as 1 millisecond, enough for any conceivable

memory requirement.

A feature of the operation is that the two pulses can be extremely short—even 1 ns—and no power is drawn between pulses. Regardless of how long the gate is on, only the same amount is drawn—that is, only enough energy to turn it on and then off. It can be as low as 5 picjoules, compared with 100 picjoules drawn by ordinary TTL gates.

A gate consists of a transistor and two diodes—very similar to basic TTL gates. The difference is in the fabrication; since the Bell gate uses charge storage, it generally needs higher-quality pn junctions to hold the charge, plus ion implants to control breakdown. However, because the gate is only on for short intervals, typically a few hundred nanoseconds, the junction requirements are not as severe as they are with dynamic memories. But because they are less likely to leak, they are better than TTL gate junctions, which do.

Solid state

Fast circuit overcomes a-d conversion difficulties

A new comparator circuit for fast analog-to-digital conversion promises to eliminate the "dead zone" that prevents conventional com-

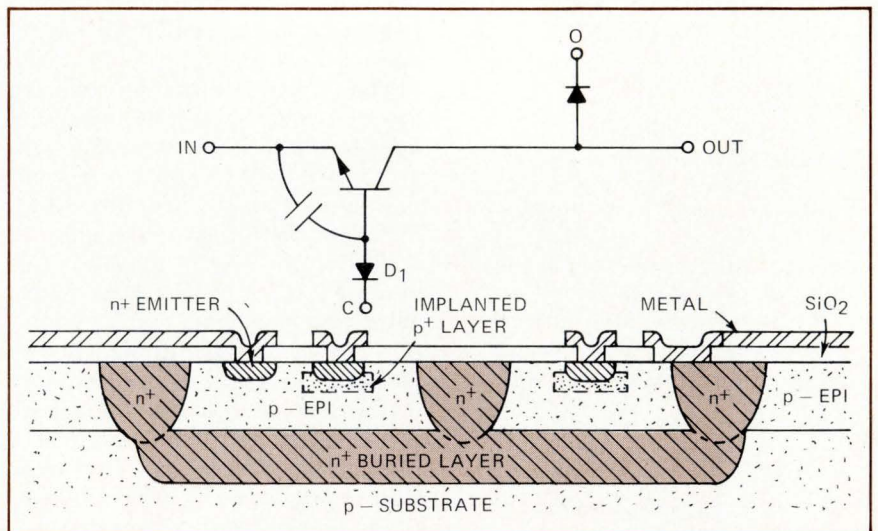

**Less power.** Bell's gate-switching cell is built like the dynamic memory itself and dissipates less than 100 microwatts, 10 to 100 times less than ordinary TTL.

parators from responding to signal variations smaller than 20 to 40 millivolts.

In the fastest analog-to-digital converters around today, a string of series resistances divides a reference voltage linearly into a number of separate levels. Each of these levels becomes the reference for its own comparator, which simultaneously compares its level with the analog input and produces a one-bit binary output if the analog signal is higher. Finally, an encoder translates the comparator outputs into a binary or other code.

With this approach, an  $n$ -bit output requires  $2^n - 1$  comparators—an uncomfortably large number for any but the grossest resolution. Not only is there a lot of hardware but, since the analog input must drive all the comparators in parallel, the input capacitance is high and presents a drive problem. Furthermore, conventional comparator circuits use continuous positive feedback for speed—and that results in the villainous dead zone.

**Feedback.** The new comparator circuit, designed at the Microelectronics Center of TRW Systems Group, combines continuous negative feedback and switched positive feedback to eliminate the zone. Up to 15 of the new comparators can go on one IC chip, where they will convert an analog signal of up to +2 volts into a four-bit binary number with a strobe rate of at least 100 megahertz. With all these comparators on one chip the accumulated input capacitance thus becomes less of a problem.

At the comparator's input is a pair of emitter followers, for a high-input impedance. Two pairs of transistors provide an input amplifier stage with negative feedback. When the strobe pulse signal arrives from an external source, it switches this current from the input amplifier to another transistor pair with positive feedback. Simultaneously, at the first stage of the input amplifier, it creates a change of only 250 mV—even in the presence of the largest input signals.

The amplifier thus stops following the signal, and holds its output at

the level it had reached when the strobe began.

Finally, an output stage translates the second amplifier's level to one compatible with emitter-coupled logic and provides additional gain

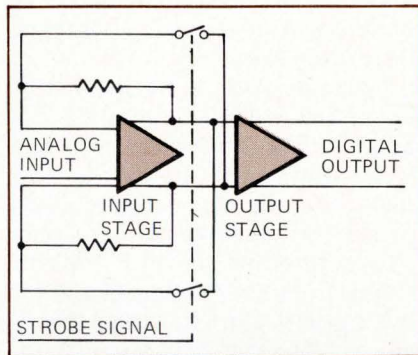

**Alive, alive-o.** TRW's a-d conversion circuit eliminates the usual dead zone.

between strobe pulses.

The circuit's total delay is only 6 to 8 nanoseconds, and it responds to input variations of less than 1 mV.

David R. Breuer described the circuit at the International Solid State Circuits Conference.

### High-speed optical isolator mates with TTL circuits

Optical devices are gaining popularity with system designers who want to couple high-frequency signals while maintaining a high degree of isolation between input and output. The trouble is that for high-speed digital systems, the conventional optical isolator, which usually pairs a gallium-arsenide infrared emitter with a silicon phototransistor, is too slow.

The hangup has been that at 900 nanometers, where GaAs emitters operate, the silicon detector surface has to be made comparatively thick—in the area of 70 micrometers—to provide the depth needed to collect all the photons absorbed by the silicon. But such depth also leads to a large feedback capacitance in the gain transistor that can't be effectively separated from the already large detector capacitance. Consequently, the typical rise and fall time of conventional

isolators is in the range of 10 microseconds.

**Enter ICs.** Now researchers Roland H. Haitz and Paul G. Sedlewicz of HP Associates in Palo Alto, Calif., have judiciously juggled materials so that integrated circuit techniques can be used to overcome the capacitance problem. As a result, they've produced a new isolator with rise and fall times of 150 ns—faster by two orders of magnitude than conventional isolators. Furthermore, the new device's input-output isolation voltage is more than 6 kilovolts—four times higher than previously available.

Essentially, Haitz and Sedlewicz traded off current-transfer efficiency and speed. First, they shifted from a GaAs emitter to one based on gallium arsenide phosphide. This reduced the radiation wavelength to 700 nm, a wavelength at which a good match between emitter and detector could be attained with a photon-collection depth of only  $8\mu$ . Although this reduces the current-conversion efficiency of the detector, these smaller dimensions are also consistent with monolithic IC isolation techniques.

With such techniques, the researchers designed a new photodetector comprising a monolithically integrated transistor and a photodiode to drive it. The transistor's collector is electrically isolated from the cathode of the photodiode, separating the diode capacitance from the collector-base feedback capacitance. The separation reduces the feedback capacitance from 20 picofarads to less than 1.0 pF, resulting in a larger gain and bandwidth. Despite the reduction in current-transfer efficiency, the isolator is still compatible with transistor-transistor logic interfaces without additional amplification.

**Two products.** The development, which was described at the International Solid State Circuits Conference, has led to two products that HP Associates hopes to introduce this spring. One is a high-speed optically coupled isolator consisting of the emitter and monolithic diode-transistor detector in a dual in-line package. The other will carry the

concept to a higher level of integration. It will be an optically isolated gate, consisting of the photodiode-transistor pair integrated with a temperature-compensated linear amplifier, and a Schottky-clamped TTL driver on the output.

The circuits should be attractive as replacements for line drivers and receivers in high-speed peripheral and computer mainframe applications, says a company spokesman.

### Contracts

#### FAA looks for new ways to stop skyjacking

Except for D.B. Cooper, who bailed out over the Northwest last fall to become a legend in his own time, skyjackers are rarely successful these days because of a combination of factors. Among them are increased use of magnetometers and other electronics to detect weapons and bombs, more security guards, and the long-range snipers of the FBI. But, as useful as these methods are, they are less than perfect, as they rely on a chancy combination of extreme vigilance, spot checking, and intimidation.

Consequently, the Federal Aviation Administration is going to start several new R&D programs to find better methods of detecting weapons and explosives in baggage and on people. Requests for proposals will go out next month. William C. Richardson, chief of the Airport Systems Development branch, says, "Electronics is the key to the problem."

The replies will be due back by the end of April; the agency then will choose no more than two for a six-month concept design effort and select one for a 12-month prototype development. Richardson declines to say how much the agency may spend, but notes that the total air security budget is \$350,000.

**Promising.** One approach that might be pursued, Richardson says, is a computerized, non-imaging X-ray machine to check baggage and people automatically. A "picture en-

velope [computer signature] of a gun or an explosive" could find weapons among the spray deodorants, cigarette lighters, and other metal objects people carry aboard planes. The advantage of this device would be that everything could be checked instead of merely sampled, Richardson says.

Dynamite also can be detected by the gamma radiation from deterioration of the constituent nitrogen, Richardson says. Following this track, the agency recently contracted for development of a neutron activation detector by the Atomic Energy Commission and the Livermore (Calif.) Radiation Laboratories. The detector uses a scintillator, photomultiplier tube, neutron generator, and a computer to count neutron emissions. With results due in June, the detector is expected to be able to differentiate between the similar signatures of nitrogen and copper, Richardson says.

**Developer.** As for the FAA role, Richardson points out that it seeks to develop devices that airline and airports can then buy. The agency, for example, is "not pursuing any development work in X-ray devices because the technology is there, and there's no need to push it," he says. Overall, Richardson doesn't foresee a big market in detection devices unless "the environment changes—that is, skyjacking gets out of control."

### Integrated electronics

#### Analog delay line built with IC techniques

Complex analog devices have at last entered the airy world of integrated circuitry. Using charge-coupled techniques, engineers at Bell Laboratories have built and tested a 500-element analog delay line that can delay video signals for upwards of 100 microseconds.

This accomplishment—which means the entire range of analog functions now can be fabricated with IC techniques—could have far-reaching effects throughout the

world of communications. For delay lines in particular, it brings performance advantages, together with space and cost savings.

Significantly, all the major semiconductor laboratories are actively engaged in developing charge-transfer devices for analog, as well as imaging, applications [see p. 36].

**Big and costly.** Analog delay functions usually are obtained with relatively bulky and expensive devices—such as coaxial cable, and glass or quartz rods or rings. All of these are incompatible with today's IC fabrication techniques. But technology aside—considering that analog delay-line applications cut across the spectrum of communications, radar, and display equipment—it's easy to imagine the market impact that the new IC devices could have.

For example, European color TV

**Wait.** CCD delays Picturephone signal. From top: image viewed direct, delayed 43 nanoseconds, delayed 11 ns. Bell has built and tested a 500-element integrated device.

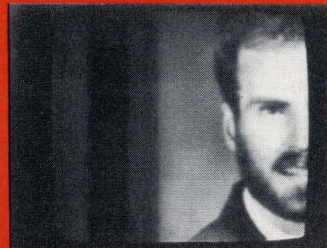
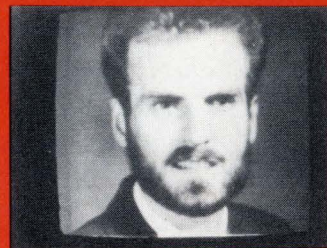

# C-LINE MICROWAVE PIN DIODES

**Choose the best  
and still pay less for your  
microwave switching needs**

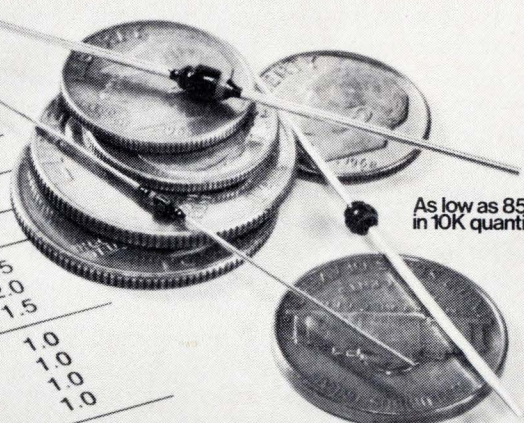

As low as 85¢ in 10K quantities

C-LINE MICROWAVE PIN DIODES — SPECIFICATIONS			
Type	Maximum Total Capacitance (0V, 1GHz)	Maximum Series Resistance (100mA, 1GHz)	Minimum Carrier Lifetime ( $I_f = 10\text{mA}$ )
	$C_T$	$R_S$	$\tau$
	pF	$\Omega$	us
UM4001B	3.0	0.5	5.0
UM7001B	0.9	1.0	2.5
UM7101B	1.2	0.6	2.0
UM7201B	2.2	0.2	1.5
UM6001B	0.5	1.7	1.0
UM6101B	0.7	1.0	1.0
UM6201B	1.1	0.4	1.0
UM6601B	0.4	2.5	1.0

You can now select capacitance, resistance and carrier lifetime and get circuit optimization at the industry's lowest prices. These new 100V PIN diodes from Unitrode all feature low distortion and low insertion loss for microwave applications such as TR switches, antenna selectors, receiver channel selectors, switching matrices and attenuators in AGC circuits. They're available off the shelf at your local Unitrode distributor. Samples on request.

For fast action, call Sales Engineering collect at (617) 926-0404, Unitrode Corporation, Dept. 2Y, 580 Pleasant Street, Watertown, Mass. 02172



**UNITRODE** quality takes the worry out of paying less.

(the PAL system) uses glass delay lines in transmission stabilization circuits and delay line equalization networks in each set; telephone companies have transversal delay line filters for equalizing just about every telephone line around the world; and there are specialized audio delay systems, like the one used in the delay networks of the Lincompex radio-telephone system [see p. 66] for equalizing speech transmission. Then there are audio applications such as equalizing the echo effects in multiple-loudspeaker systems, scrambling speech in mobile police transceivers, and use in artificial reverberation systems.

**Faster version.** Bell has built a faster 64-element line in addition to its 500-element delay line. Both delay signals up to several hundred microseconds. The smaller device can be operated in the 10-to-20-megahertz range, and both offer bandwidths of 1 to 10 MHz, sufficient for most video applications.

Both of the Bell delay lines are standard three-phase devices. To fabricate the 500-element line, Bell used a minimum strip geometry of 3-micrometer-wide electrodes with 3- $\mu\text{m}$  gaps—the smaller delay line has a 10- $\mu\text{m}$  geometry. It's thought that the 500-element array is about

the largest that can be built with standard three-phase device construction. Some form of overlapped silicon-gate construction will be necessary for larger arrays.

Besides cost and elegance, charge-transfer analog delay lines automatically offer variable delays—impossible with ordinary lines, which must be carefully factory-set. Michael Tompsett, one of the developers of the CCD delay line at Bell's Murray Hill, N.J., laboratories, points out, "The CCD device is actually an analog shift register and so the delay time can be changed simply by varying the shift clock rate." Rates vary from an upper frequency of 10 to 20 MHz (or higher with advanced devices) down to less than a kilohertz—yielding delays from 100 milliseconds to a few microseconds. The length of the delay is limited only by the generation-recombination time (a function of the dark current in the device) which can be as long as a second, says Tompsett.

In operation, a video signal from a television transmitter or Picturephone terminal is applied to the input diode of the delay line. When the voltage is put on the first transfer electrode, a virtual drain is dug under that electrode; carriers flow from the input diode into it. This

charge becomes the charge packet that is transferred through the device. The packet's magnitude is roughly proportional to the amplitude of the video signal at each input step.

Again the delay is determined by the speed at which the signal is transferred and the number of stages present. There are tradeoffs, depending on applications. For example, the maximum bandwidth is approximately one-half the transfer frequency so that the higher the frequency, the greater the bandwidth, and the lower the frequency, the longer the delay.

## Military electronics

Pentagon restructures  
buying, telecommunications

The Pentagon is shuffling jobs and budgets again in separate efforts to "bring order out of chaos" in its weapons purchasing and to consolidate and strengthen its telecommunications program. This was disclosed by Secretary Melvin Laird in a 204-page annual assessment for Congress on America's defense posture. With characteristic shrewdness and uncommon candor, Laird moved to blunt rising Congressional criticism of rising weapons costs and declining performance by detailing proposals to control both.

Heaping great praise on former Deputy Defense Secretary David Packard as originator of both plans to improve the procurement process and restructure telecommunications functions, Laird outlined these problems and his solutions:

**Telecommunications.** Laird said telecommunications under the new assistant secretary, Eberhardt Rehtin, is now "for the first time considered as a single package" in DOD planning and programing. Pentagon telecommunications functions, Laird disclosed, involve a worldwide capital investment of about \$5.6 billion and annual appropriations of \$2.6 billion.

Elsewhere, where "the initial decision was wrong, resulting in proj-

## Analog CCD roll call

Not only has Bell Laboratories built a charge-transfer analog delay line, but other semiconductor makers are digging away in that direction.

At General Electric, a key device under development is a multitap delay line. Researchers there believe the line can be made economically by laying an electrode—charged to a high potential and floated free—over selected storage regions, which the electrode's voltage then drops in proportion to the total surface charge transferred into these selected regions. This voltage swing can be amplified by MOS FETs on the same chip as the transport structure.

Philips in the Netherlands, with a bucket brigade structure, adds the possibility of variably weighted taps. The detector for a specific stage is divided into two portions, only one of which is coupled to the output sensor. In this case, the output is sensed as a variable load on the clock driver.

Researchers at Texas Instruments have built an MOS bucket brigade transverse filter that they've matched to a standard 13-bit Barker code—commonly used in radar systems. The TI delay lines were processed on 5-ohm-centimeter silicon using a silicon-oxide/silicon-nitride gate structure—a new one for charge-transfer device processing. At a 10-kilohertz transfer rate, signal-to-noise ratio was an impressive 10.6 decibels. The best devices exhibited transfer efficiencies approaching 99.5%. Texas Instruments expects a signal-to-noise ratio of about 19 dB in filters that are matched to 100-bit codes.

# OUR ANGLE: angle position indicators that do more and cost less

## SHOULDN'T YOU TAKE A NEW READING ON THIS COST-PERFORMANCE ANGLE?

For better ways to measure synchro and resolver data, North Atlantic offers the best of both worlds: budget prices for the popular API-8025; superior performance and increased capability of the new 8525. • Both are interchangeable without any mechanical or wiring modifications. North Atlantic's solid-state 8525 offers an accuracy of  $0.05^\circ$  (3 minutes). Following a  $180^\circ$  step input, it synchronizes a five-digit NIXIE readout in  $\frac{1}{2}$  second flat. And it tracks at up to  $1000^\circ$  per second. Where cost can be traded against performance, the proven electromechanical API-8025 . . . a recognized indus-

MODEL 8525



MODEL 8025

try workhorse . . . is available with its 6 minute accuracy,  $25^\circ$ /second slew speed, and many options. • Input of the 8525 is any 60 or 400Hz resolver/synchro data from control instrumentation. The patented servo design eliminates all inertia and improves dynamic performance many times over. Its digital outputs are especially suited to the computer-oriented requirements of today's automatic test systems. The 8525 . . . priced at \$1885 . . . and the API-8025 priced at \$995 actually cost less because they perform more functions per dollar. And with greater reliability. ®

*For complete information on the cost-performance angle, please write or phone now.*

**NORTH ATLANTIC**  
*industries, inc.*

200 TERMINAL DRIVE, PLAINVIEW, NEW YORK 11803  
cable: noatlantic / twx: 510-221-1879 / phone: (516) 681-8600

## Electronics review

ects that were too ambitious or unrealistic" such as Westinghouse Electric's Mark-48 torpedo and Lockheed's C-5A supertransport, Laird is pressing for net assessments of both enemy threats and available technology. A director of net assessments in Laird's office will correlate information on both aspects from the assistant secretary for intelligence and the director of defense research and engineering, respectively, before new programs are undertaken. And once a go-ahead is given, projects will stress Packard's concept of prototyping hardware [*Electronics*, Aug. 30, 1971, p. 65].

Where Pentagon "management was not as effective as it should have been," Laird believes the solution lies with the Defense Systems Management School [*Electronics*, May 10, 1971, p. 58] and the longer duty tours and increased authority of project managers.

Where "cost estimates were unrealistic and accepted even when we could have known better," Laird says DOD economists will employ new, but not yet specified, techniques that can indicate final actual cost "within 10% or 20% compared to the contractor's bid and final cost" which have differed by up to 200% and, in one or two cases, by 1,000%. New and, hopefully, uniform estimating procedures will be developed by a Cost Analysis Improvement Group in Laird's office which will be made up of representatives of DDRE, and the Office of the Assistant Secretaries for Installations and Logistics, Systems Analysis, and the comptroller, who will report to the Defense Systems Acquisition Review Council.

## Satellites

OTP rewrites the aerosat story

Satellites for transoceanic aeronautical services are likely to be part of a larger, multipurpose communications system and are sure to be privately owned and operated. At least that's the way it will be if the

Office of Telecommunications Policy has its way. And signs now indicate that OTP will have its way following its successful drive to have President Nixon veto the controversial aerosat proposed by the Federal Aviation Administration and the State Department.

OTP has momentarily grabbed center stage to direct the aerosat program and is establishing a stronger role for itself in Government telecommunications policy. And, importantly for industry, the young White House office reaffirmed its free enterprise position that all U.S. communications satellite, domestic or international, should be built, owned, and operated by those private companies that can raise the venture capital and compete effectively.

**Changes.** In taking the lead, OTP threw out the old script quietly written by the FAA and the European Space Research Organization last year, which called for the two government organizations to jointly develop, own, and operate a four-satellite system over the Atlantic and Pacific. Although a final aerosat program has to be decided on a renegotiated with the Europeans, OTP officials are talking about these broad changes:

■ First, OTP wants to renegotiate the aerosat agreement with "the Europeans," implying that the other partner might not be ESRO but private Continental industry or one country's government. OTP stresses that this is subject to talks, to be held shortly, with European governments.

■ Secondly, although OTP says that it wants to cooperate with Europe, officials say privately that "you certainly can't make both sides happy." Should Europe decide to pull out and build its own aerosat—and it is both capable and impatient with what it sees as U.S. foot dragging—OTP seems perfectly willing to back a totally U.S. system in competition with Europe. One official describes the situation as "no holds barred."

■ Thirdly, the policy office sees aerosat in a wider context. "Everyone thinks we are saying that there should be just an aerosat," says one

## Raytheon Semiconductor Regional Sales Offices

**CALIFORNIA**  
INGLEWOOD, (213) 757-0251  
MOUNTAIN VIEW, (415) 968-9211  
**FLORIDA**  
LAKE PARK, (305) 844-4333  
**ILLINOIS**  
DES PLAINES, (312) 297-5540  
**MASSACHUSETTS**  
BURLINGTON, (617) 272-6400  
**MINNESOTA**  
MINNEAPOLIS, (612) 920-8710  
**NEW JERSEY**  
ENGLEWOOD, (201) 567-4911  
**NEW YORK**  
ROME, (315) 337-2540  
**VIRGINIA**  
ARLINGTON, (703) 979-6100  
**U. S. A. & Canada Sales Representatives**  
**ALABAMA**  
HUNTSVILLE, Rep. Inc., (205) 881-9270  
**ARIZONA**  
SCOTTSDALE, Mercury Eng. Sales (602) 945-1907  
**CALIFORNIA**  
SAN DIEGO, Fred Nagle Co., (714) 296-4850  
SAN MATEO, Jack Fyle Co., (415) 347-1401  
**CONNECTICUT**  
TRUMBULL, Ray Perron Co., (203) 268-9631  
FARMINGTON, Ray Perron Co., (203) 673-4825  
**FLORIDA**  
ORLANDO, Perrott Assoc., Inc., (305) 275-1132  
**GEORGIA**  
ATLANTA, Rep. Inc., (404) 876-1591  
**INDIANA**  
FORT WAYNE, Scott Elec., Inc., (219) 743-1586  
INDIANAPOLIS, Scott Elec., Inc. (317) 535-8951  
**KANSAS**  
OVERLAND PARK, Dy-Tronix, (816) 931-3030  
**KENTUCKY**  
LOUISVILLE, Scott Elec., Inc., (502) 583-3220  
**MASSACHUSETTS**  
NORWOOD, Ray Perron Co., (617) 762-8114  
**MISSOURI**  
HAZELWOOD, Dy-Tronix, (314) 731-5799  
**NEW HAMPSHIRE**  
DOVER, Ray Perron Co., (603) 742-2321  
**NEW MEXICO**  
ALBUQUERQUE, Electronic Marketing, Inc. (505) 265-7837  
**NEW YORK**  
ALBANY, COMPAR, (518) 489-7408  
BINGHAMTON, COMPAR, (607) 723-8743  
MANHASSET, Win-cor Electronic Sales (516) 627-9474  
ROCHESTER, COMPAR, (716) 271-2230  
SYRACUSE, COMPAR, (315) 471-3356  
**OHIO**  
CINCINNATI, Scott Elec., Inc., (513) 791-2513  
CLEVELAND, Scott Elec., Inc., (216) 291-2600  
COLUMBUS, Scott Elec., Inc., (614) 236-8619  
DAYTON, Scott Elec., Inc., (513) 223-2652  
**PENNSYLVANIA**  
PITTSBURGH, Scott Elec., Inc., (412) 781-3112  
**TEXAS**  
DALLAS, J. B. Guenther, Inc., (214) 528-6286  
HOUSTON, J. B. Guenther, Inc., (713) 486-0232  
**VIRGINIA**  
FAIRFAX, Schibley Assoc., (703) 591-3008  
**WASHINGTON**  
SEATTLE, Underwood & Underwood (206) 243-2133  
**CANADA**  
**ONTARIO**  
REXDALE, Aero Sales Eng. Co., (416) 249-9139  
**U. S. A. & Canada Franchised Distributors**  
**ALABAMA**  
HUNTSVILLE, Cramer, (205) 536-4493  
HUNTSVILLE, Hallmark, (205) 539-0691  
**ARIZONA**  
PHOENIX, Kieruff Elec., (602) 273-7331  
TEMPE, Intermark, (602) 968-3469  
**CALIFORNIA**  
CULVER CITY, Avnet Elec., (213) 836-7200  
GLENDALE, Cramer, (213) 245-7121  
LOS ANGELES, Kieruff Elec., (213) 685-5511  
MENLO PARK, Bell Elec. Corp., (415) 323-9431  
REDWOOD CITY, Cramer, (415) 365-4000  
SAN CARLOS, Intermark Elec., (415) 592-1641  
SAN DIEGO, Intermark Elec., (714) 279-5200  
SAN DIEGO, Kieruff Elec., (714) 278-2110  
SANTA ANA, Intermark Elec., (714) 540-1322  
VAN NUYS, Intermark Elec., (213) 782-0362  
**COLORADO**  
DENVER, Cramer, (303) 758-2100  
DENVER, Intermark Elec., (303) 936-8284  
**CONNECTICUT**  
NORTH HAVEN, Cramer, (203) 239-5641  
**FLORIDA**  
HOLLYWOOD, Cramer, (305) 923-8181  
ORLANDO, Cramer, (305) 841-1550  
PALM BEACH GARDENS, Industrial Electronics Associates, (305) 622-2626  
**GEORGIA**  
ATLANTA, Cramer, (404) 451-5421  
**ILLINOIS**  
ELK GROVE VILLAGE, Hallmark Electronics (312) 437-8900  
MT. PROSPECT, Cramer, (312) 593-0230  
**INDIANA**  
INDIANAPOLIS, Graham Elec., (317) 635-5453  
**MARYLAND**  
BALTIMORE, Cramer, (301) 354-0100  
BALTIMORE, Radio Electric Service Co. (301) 823-0070  
GAITHERSBURG, Cramer, (301) 948-0110  
ROCKVILLE, Pioneer Washington Electronics (301) 427-3300  
**MASSACHUSETTS**  
NEWTON, Cramer, (617) 969-7700  
**MICHIGAN**  
FARMINGTON, Northland Elec., (313) 477-3200  
**MINNESOTA**  
BLOOMINGTON, Cramer, (612) 881-8678  
MINNEAPOLIS, Hallmark Elec., (612) 925-2944  
**MISSOURI**  
ST. LOUIS, Hallmark Elec., (314) 521-3800  
**NEW JERSEY**  
PENNSAUKEN, Cramer, (215) 923-5950  
UNION, Cramer, (201) 687-7870  
**NEW MEXICO**  
ALBUQUERQUE, Century Elec., (505) 265-7839  
ALBUQUERQUE, Cramer, (505) 265-5767  
**NEW YORK**  
ENDWELL, Cramer, (607) 754-6661  
HAUPPAUGE, Cramer, (516) 231-5600  
HAUPPAUGE, Time Elec. Sales, (516) 273-0100  
NEW YORK CITY, Terminal-Hudson Electronics, (212) 243-5200  
PLAINVIEW, A.C.I. Elec. Corp., (516) 293-6630  
ROCHESTER, Cramer, (716) 275-0300  
SYRACUSE, Cramer, (315) 437-6671  
**NORTH CAROLINA**  
RALEIGH, Cramer, (919) 876-2371  
WINSTON/SALEM, Cramer, (919) 725-8711  
**OHIO**  
CINCINNATI, Cramer, (513) 771-6444  
CLEVELAND, Cramer, (216) 248-7740  
**OKLAHOMA**  
TULSA, Cramer, (918) 836-3371  
**PENNSYLVANIA**  
PITTSBURGH, Cameradio Co., (412) 391-4000  
**TEXAS**  
DALLAS, Cramer, (214) 350-1355  
**UTAH**  
SALT LAKE CITY, Cramer, (801) 487-3681  
**WASHINGTON**  
SEATTLE, Intermark Elec., (206) 767-3160  
**WISCONSIN**  
MILWAUKEE, Cramer, (414) 462-8300  
MILWAUKEE, Hallmark Elec., (414) 476-1270  
**CANADA**  
MONTREAL, Preico Electronics, (514) 389-8051  
OTTAWA, Wackid Radio & TV Lab Ltd. (613) 728-1821  
TORONTO, Cramer, (416) 781-6631



# BEYOND SUPER BETA.

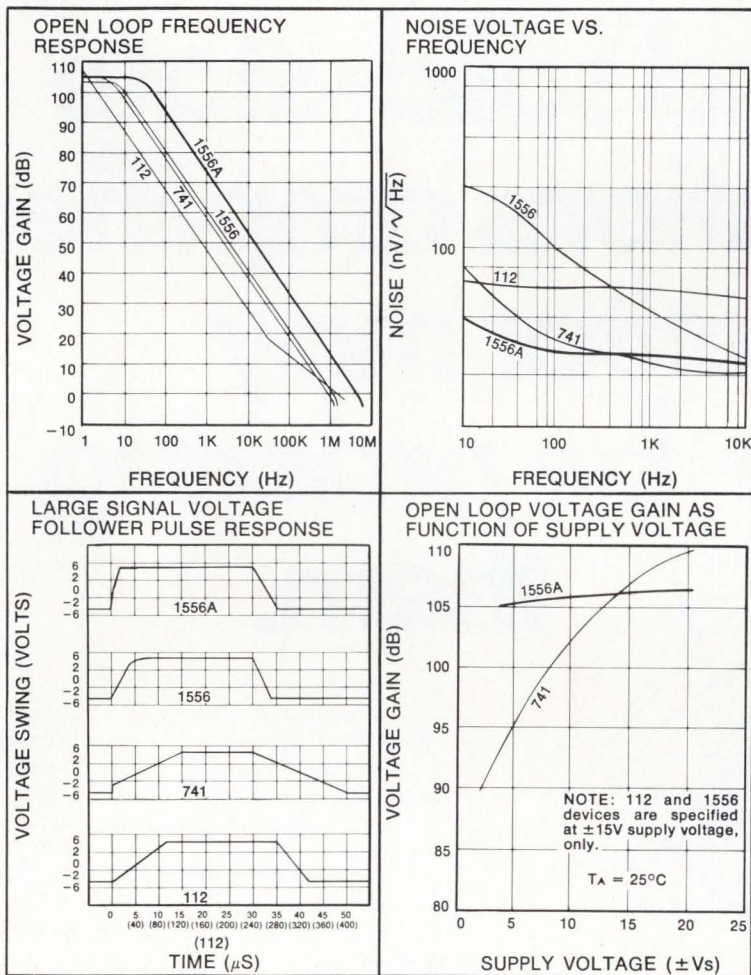

**Raytheon Semiconductor introduces the new RM/RC1556A op amp — Beyond Super Beta.**

The 1556A does things the standard 1556, 112, and 741 op amps can't do. The input offset voltage is improved by a factor of two — down to only 2mV maximum — so you don't have to worry about external balancing. And the offset voltage drift with temperature is only 5μV/°C.

Bandwidth is improved by a factor of four up to 4MHz — so you get 12dB more feedback between 10Hz and the closed loop bandwidth frequency. With an unbeatable slew rate of 2V/μs.

Noise characteristics are improved by a factor of three. Typical input noise is only 25nV/√Hz at 1kHz. So you can work with lower level signals without degradation.

Beyond Super Beta is a new circuit designed specifically to improve performance of Super Beta op amps without sacrificing yield.

Study the comparative performance curves at the left. And then get your hands on a 1556A and try it yourself. That's the only way you'll ever really know just how far beyond Beyond Super Beta is.

Contact your nearest Raytheon Semiconductor sales office, representative, or franchised distributor. Or stop by Raytheon Semiconductor, 350 Ellis Street, Mountain View, Calif. 94040. (415) 968-9211.



Circle 39 on reader service card

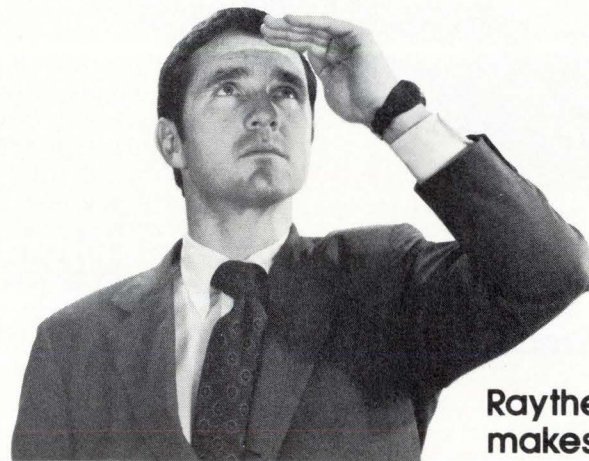

**Raytheon Semiconductor makes tough linears.**

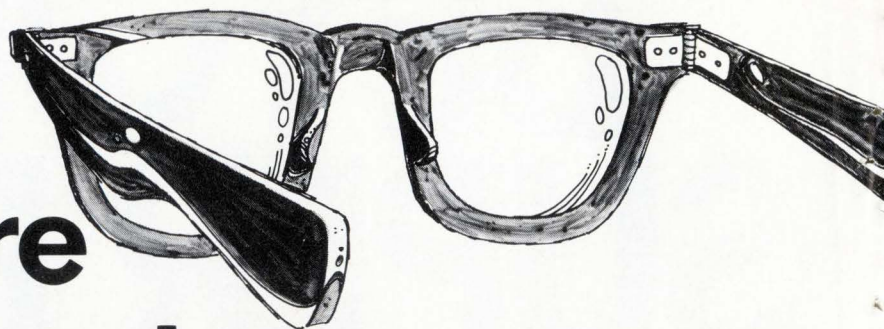

# While you're reading about our new X-band solid-state communications amplifiers, your competitor may be ordering them.



Quick reactions have never hurt anybody. Especially in the microwave amplifier field, where there's a crying need for advanced designs. Because until now, all that's been available has been tubes.

And tubes, you know, can burn out. And they're expensive.

So now, Hughes announces its new solid-state avalanche diode amplifiers.

System-proven in the F-14, F-15, and Phoenix programs.

Superior quality. Low voltage power supply. Less system down time for your customer.

And very, very inexpensive.

Right now, we're delivering our solid-state ADAs for 1W systems in C, X, and Ku bands. And for millimeter-wave systems through V-band.

All you have to do is stop reading and write us at: Electron Dynamics Division, 3100 W. Lomita Blvd., Torrance, CA 90509.

Or better still, in case your competition has ordered some, call: (213) 534-2121.

**HUGHES**

HUGHES AIRCRAFT COMPANY  
ELECTRON DYNAMICS DIVISION

Hughes Industrial Electronic Products

## Electronics review

Administration source, "but we envision a multipurpose satellite" not only for navigation but "down the line, telephone traffic as well."

■ Fourthly, OTP's "views are firm about private ownership and incentives for private sector investment and private sector ownership," says another spokesman. The office sees the Government's role as minimal.

And, OTP, true to the free enterprise ideal, can even see a single U.S. company building aerosat jointly with ESRO, if that works out.

**Alarming.** Three provisions of the FAA-ESRO agreement alarmed Administration figures: Europe would have a fixed share in production, government ownership of the satellite, and a veto power, especially over the Pacific satellite.

OTP seems to have answered the latter two objections; one spokesman says "we're not opposed to sharing production with the Europeans, providing the private sector is protected."

Except for the Department of Transportation, the FAA, and the State Department, which are seen as losers, other interests were pleased with the veto. They saw it as good for Comsat and a victory for industry.

## Computers

### Controls processor eases microprogramming tasks

Microprogramed and programable processors both have their disadvantages. With the first, users must know exactly what routines the processor is to follow, while with the others the user is forced to write his programs around an inflexible instruction set, which may be too large and costly for him.

Digital Equipment Corp. will introduce at the IEEE Show in March a 16-bit processor combining advantages of both approaches. By using a programable read-only memory—perhaps for the first time in a large commercial application—DEC's PDP-16/M allows the user to cut-and-try his way to a suitable microprogram

and at the same time to mold the size and capability of the instruction set to his need.

The 16/M will be priced from \$1,995 for one unit to \$895 in quantities of 200. It was designed to fill a gap between simple hard-wired machine controllers or relay-replacement units and the lowest-priced minicomputers.

"Some tasks are too simple for the smallest mini to be cost-effective, yet critical enough to demand digital control," explains Robert Van Naarden, PDP-16 marketer. DEC supplies a manual listing each of about 2,000 microinstructions, and the user puts them into the appropriate locations on tape and loads them into the PROM, erasing mistakes with intense bursts of ultraviolet light until reaching a final microprogram.

Although limited by available read-write memory, the 16/M appears to be a fairly powerful machine, though not quite so powerful as a true minicomputer. Each of its PROMs can hold up to 192 "evoke micros"—for example, "add A to B"—as well as 60 test or branching instructions, two subroutine calls, and two subroutine return instructions.

To users planning to fit the machine to pilot operations, the PROM approach allows cutting the microprogram to fit on the spot. Once the microprogram is satisfactory, DEC offers either fused-link or masked ROMs at less than cost. While the PROM is \$225, a fused-link ROM is \$100 less and, if the customer buys 30 or more machines, the masked ROMs cost only \$75 each.

The 16/M is aimed at those processes that are continually changing their parameters, some yearly, like auto manufacture, and others, like chemical production, much more frequently. With the PROM-equipped 16/M a user gets the reliable response and low costs of microprogramed control, but retains the option of changing the ground rules by erasing the PROM and feeding in a new program tape.

**Gear.** A standard PDP-16/M comes equipped with a 256-word PROM, a four-word data ROM, a one-

# Hughes is more than electronic equipment and systems.

## It's components, too.



Microwave diodes (RS 220)

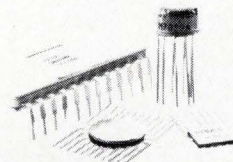

Bipolar and hybrid circuits (RS 221) and MOS integrated circuits (RS 222)

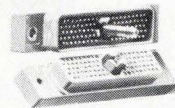

Electrical connectors (RS 223)

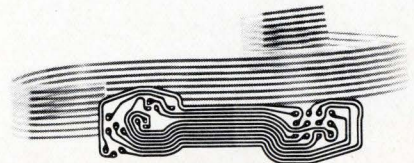

Flat flexible cable and circuit assemblies (RS 224)

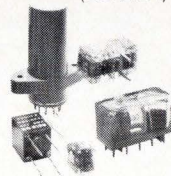

Special assemblies (RS 225)



Direct view and scan converter storage tubes (RS 226)

For complete information, write Bldg. 100, Mail Station C-512, Culver City, CA 90230. Or request by Reader Service (RS) numbers.

# HUGHES

HUGHES AIRCRAFT COMPANY

## Industrial Electronic Products

# New AO II-80 Illuminator sheds intense, "cold" light on your subject.



This is the illuminator with 1001 uses. You can use it to provide bright, shadowless light for microscopy. To equally illuminate samples under stereo comparison microscopes. To illuminate miniature components under assembly. Illuminate hazardous areas. And in many other applications.

The AO II-80 uses a quartz iodine light source. Fan-cooled lamp has 50- to 500-hr. life. A 4-level switch controls settings. Unit weighs only 4¾ lbs.

The flexible two-branch gooseneck light guides transmit intense cold light—measure 24". (Other light guides also available.)

**AO II-80 Illuminator**  
price: only \$129.50  
**Gooseneck Light Guide**  
(shown) \$75.00

 **AMERICAN OPTICAL**  
CORPORATION  
Fiber Optics • Southbridge, Massachusetts 01550

## Electronics review

word read-write memory, decoding for 96 instructions, a simple arithmetic unit and a 16-bit parallel I/O channel. Options include a serial interface, extra parallel I/O capabilities, constant generators, transfer and byte registers, and three sizes of scratchpad memory.

## Education

### Fewer EEs on campus may mean industry shortage

Latest figures from engineering schools across the country indicate that the roller coaster cycle of EE enrollment for undergraduate and graduate courses is on another downhill dip. According to statistics just compiled by the Engineering Manpower Commission of the Engineers Joint Council, 1971 totals by class are all significantly lower than in 1970 with the exception of the seniors, which dropped by only one student.

Most disturbing to engineering educators is the heavy decline in freshmen, down 18% from 12,085 to 9,958 this year [see table on p. 44]. In addition, there are fewer undergrads per class from senior down to freshman, so that while 14,131 fourth-year students carried on in EE studies this year, 4,173 fewer entered the pipeline as freshmen.

**All down.** Though some engineering schools do not identify electrical engineering candidates until the junior year, this fact does not completely explain the small size of the freshman class, because total engineering enrollments for all specialties are down 18.3% as well.

There are fewer master's and doctoral candidates, either fulltime or parttime, with the bigger percentage dips occurring among parttimers. Yet there are slightly more fulltime 1971 graduate students, than there were in 1969. This was not the case for undergrads. Enrollments for total fulltime bachelor candidates this year are down over 7% from 1969.

All of which leads to questions from engineering academics on why the drop, what can be done to re-

verse it, and what short-term impact the decline will have on industry's needs by 1975. The situation is clouded by the fact that not all electrical engineering departments have shrunk. A sampling of department heads across the country provided these opinions:

- The declines are the result of a mixture of factors—anti-technology attitudes, a soft job market, and slipshod guidance in high schools.

- Recruiting efforts making EE departments attractive to students interested in the environment and bio-engineering can help reverse the trend.

- Placement officers over-reacted to the job situation. Actually all graduates can find employment, though the choices are not as great as before.

- There is no clear indication that the poorer students are dropping out of engineering, so that, while there will be fewer EEs, they may not necessarily be better.

- There's no immediate cure for the out-of-phase swings of supply and demand of EEs.

The irregularity of enrollments from school to school appears to be independent of location, or of private versus public financing. On the whole, state-run institutions seem to be experiencing the bulk of the drops; this will lead to budget cuts in states whose financial support is geared to numbers of students. Schools that have held their own or increased registration have usually done so by finding new sources of students, such as the increasing numbers of candidates for bachelor of electronic technology.

**MIT solid.** At Massachusetts Institute of Technology, graduate school enrollment has risen from 416 to 460 and undergrad levels have remained constant. According to Prof. Louis D. Braid, distribution within the department has changed to the point that about a third are enrolled in computer science.

Agreeing, William T. Peria, EE department head at the University of Minnesota, suggests that education has been "reoriented within electrical engineering." Students at Minnesota can study biology, the

# Be in command of your time-series analyzer

Time/Data saves you valuable time with single, pre-programmed pushbuttons for all widely used functions. No program. No keyboard. No human error. Just a button.

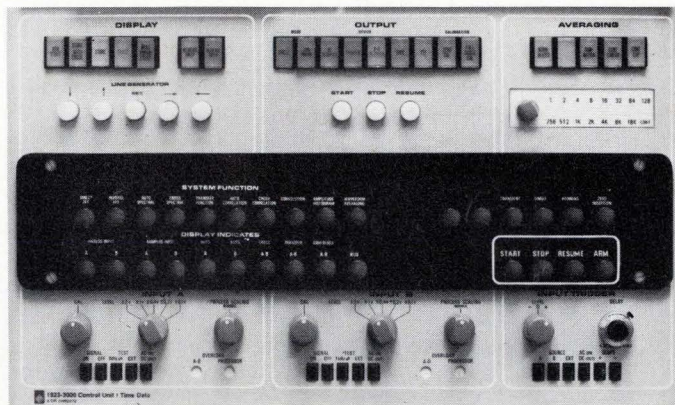

Single, pre-programmed pushbuttons for all these functions:

Direct Fourier Transform	Auto Spectral Cross Spectral	Waveform Averaging	Spectral Averaging
Inverse Fourier Transform	Transfer Function Coherence Function	Auto Correlation Cross Correlation	Linear Exponential Normalized
		Hanning	

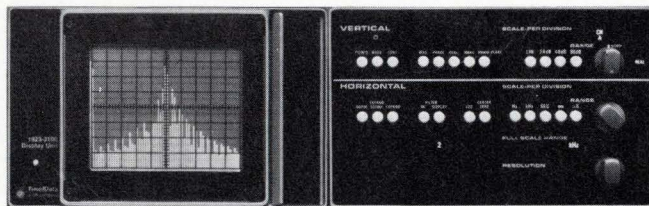

Full, calibrated 24, 48, or 96 dB display (pushbutton selectable)

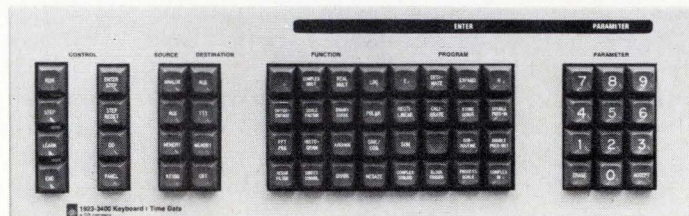

Of course, if you wish to construct additional functions or a program of your own, use our plug-in keyboard. It utilizes a high-level language for time-series functions, arithmetic functions, and digital processing. It can even call the pre-programmed control panel functions for added speed and simplicity.

There are still more convenience features in every TIME/DATA 1923 system. See them in action. Write or call your nearest General Radio sales engineer, or GR Concord, Mass. 01742, or Time/Data, 490 San Antonio Road, Palo Alto, Calif. 94306; Europe, write General Radio, Postfach CH 8034, Zurich, Switzerland.



490 SAN ANTONIO RD., PALO ALTO, CALIFORNIA 94306 • 415 327-8322  
 BOSTON 617 646-0550 / CHICAGO 312 992-0800 / LOS ANGELES 714 540-9830  
 NEW YORK (N.Y.) 212 964-2722 (N.J.) 201 791-8990 / WASHINGTON, D.C. 301 881-5333  
 TORONTO 416 252-3395 / ZURICH (051) 47 70 20

EE ENROLLMENTS COMPARED WITH TOTAL ENGINEERING						
	1970		1971		% change	
	All	EE	All	EE	All	EE
Freshman	71,661	12,085	58,566	9,958	-18.3	-18
Sophomore	53,419	12,877	47,948	11,764	-10.2	-9
Junior	49,855	13,847	48,543	13,026	-2.6	-6
Senior	51,983	14,132	51,377	14,131	-1.2	0
Fifth	4,812	1,290	4,391	1,224	-8.7	-5
Total (full time)	231,730	54,231	210,825	50,103	-9	-7.6
Total (part time)	18,445	6,440	18,222	6,314	-1.2	-2
MS (full time)	23,216	5,516	22,405	5,249	-3.5	-5
MS (part time)	25,853	7,587	22,692	7,080	-12.2	-7
PhD (full time)	14,802	3,643	14,100	3,390	-4.7	-7
PhD (part time)	4,949	1,334	4,610	1,203	-6.8	-9
Total (full time)	38,018	9,159	36,505	8,639	-4	-5.7
Total (part time)	30,802	8,921	27,203	8,283	-11.7	-7.2

Source: Fall Enrollments Surveys, Engineering Manpower Commission of Engineers Joint Council, New York.

environment, and urban affairs without leaving the EE department, even so, Minnesota reports a fall in freshman enrollment from 188 to 105 this year. Also, the number of full-time graduate students went from 148 to 97.

On the West Coast, Stanford University reports little change in graduate (529 compared to 565 last year) and undergraduate candidates, but UCLA experienced 8% and 12% declines, respectively. The average undergraduate drop of all departments in the engineering school was 30% at UCLA. Unrattled, Frederick Allen, chairman of the electrical science and engineering department, comments, "the effects we're feeling are largely due to aerospace cutbacks and are relatively small and transient. In a few years the demand will have picked up again."

**For the record**

**Fast and cheap.** A serial printer mechanism capable of 30 characters per second—twice the rate of IBM's Selectric and three times that of the standard Teletype—has been announced, selling in OEM quantities

for only \$1,000. Selectrics equipped for use as computer output printers go for \$1,400, while the workhorse Model 35 Teletype is \$900. The new machine is manufactured by Diablo Systems Inc. of Hayward, Calif.

Not only does it have an impressive printing speed and a low price, but it can do graphics under computer control. Printing a series of periods, moving the print carriage both forward and backward and rolling the paper both up and down, the machine draws curves, bar charts, or what have you, with its maximum resolution visible only on lines that are almost horizontal or almost vertical.

The machine is very quiet. Performance and noiselessness are due primarily to extensive substitution of electronic circuitry for the mechanical parts found in conventional printers—the machine has only nine moving parts, and the print mechanism has only one, the hammer. The type face is on a rotating nylon "daisy," with one character on each of 96 petals.

**TI patents.** Texas Instruments has won two major MOS patents, in-

cluding one describing the structural configuration used in more than 99% of all MOS/LSI circuits, reports Edward O'Neill, special circuits department manager.

The first describes an IC in which circuit elements are formed partially in the silicon wafer and partially by insulators and conductors layered onto the wafer, such as insulated-gate field effect transistors and silicon oxide capacitors. Originally filed with the U.S. Patent Office in 1959 as part of Jack S. Kilby's application for the basic IC patent, the descriptions of MOS integrated circuits were later broken out and refiled separately, apparently to facilitate the early issuance of the Kilby patent on miniaturized electronic circuits, awarded in 1964.

The second patent describes crossover manufacturing techniques "in wide-scale use throughout the industry," O'Neill says, "affecting some 40% of all devices."

**China sale.** While Hughes Aircraft and Western Union International were busy setting up a temporary communications satellite earth station in Peking for President Nixon's China visit [*Electronics*, Jan. 31, p. 41], RCA Global Communications Inc. was busy making a sale in Shanghai—a \$2.9 million earth station package contracted with the China National Machinery Import and Export Corp. Designed initially for coverage of the Nixon visit to Shanghai and Hangchow, the Globcom station is expected to be used later to bring China into the International Telecommunications Satellite Consortium.

RCA says the agreement, negotiated secretly in January, calls for 20 units of its trademarked Video-voice system plus microwave terminals to relay TV, telephone and telegraph signals between Shanghai and the station site. The station consists of a 33-foot parabolic antenna, a power generation system, and test equipment to provide an initial capability for transmission of signals for television, 23 two-way voice, and 12 two-way teleprinter channels. The station will be upgraded later to 60 voice-grade circuits.

# World's longest monolithic shift register

Now Intel introduces a dual 1024-bit shift register on one MOS chip, with a single 1024-bit alternative for those who can't use all the capacity.

Both shift registers are fully specified under worst case operating conditions from 0° to 70°C and over power supply variations of  $\pm 5\%$ . Speed is guaranteed to 1 MHz with a 100 pF load. Power dissipation averages only 120  $\mu$ W per bit at top speed.

Low clock capacitance of 7 pF eliminates need for clock drivers. And to eliminate other external circuitry, write/recirculate controls and chip-select logic have been incorporated on the chip.

## Runs on one +5v supply

This N-channel MOS shift register accepts standard TTL inputs, generates standard TTL outputs, runs on a TTL clock, and operates on one TTL power supply, +5v  $\pm 5\%$ . You don't need level shifters, clock drivers, pull-up resistors, or any other interfacing circuitry.

The key to this unprecedented compatibility is Intel's N-channel silicon-gate process, a process that combines the interfacing ease of bipolar with the economy of MOS. This shift register is the first of a family of 5-volt N-channel devices that Intel will introduce in 1972.

Price in 100-piece quantities is \$24.00 for the dual 1024-bit Type 2401 and \$11.00 for the single 1024-bit Type 2405.

For immediate delivery phone your local Intel distributor: Cramer Electronics, Hamilton Electro Sales, Industrial Components, or Electronic Marketing. In Europe contact Intel at Avenue Louise 216, B 1050 Bruxelles, Belgium. Phone 492003. In Japan contact Intel Japan, Han-ei 2nd Bldg., No. 1-1, Shinjuku, Shinjuku-ku, Tokyo 160. Phone 03-354-8251.

Intel produces memory systems as well as memory devices at 3065 Bowers Avenue, Santa Clara, Calif. 95051. Phone (408) 246-7501.

**intel<sup>®</sup>  
delivers.**

**EIA DRIVER  
HAS INTERNAL  
INHIBIT AND  
SLEW RATE  
CONTROL.**

---



**Our new 9616 EIA triple line driver provides simple, low-cost solutions to EIA applications. Our new 9617 EIA triple line receiver completes the set.**

Our new 9616 Driver and 9617 Receiver meet all EIA-232-C/CCITT V.24 specs. And more. Together they provide the simplest low-cost solution to problems at the interface in data terminal equipment and data communications.

Unlike conventional EIA drivers, which are implemented by a positive NAND function, our 9616 is implemented by an And/Or/Invert function. With this logic configuration, you can perform the inhibit function without any external gating.

In addition, the 9616 incorporates internal slew rate control. No need for an external capacitor for each driver. Result: significant savings on board space, components, assembly.

In meeting RS-232-C recommendations our 9616/9617 feature:

**9616 EIA Line Driver**

- All inputs TTL compatible
- Each driver is output protected

- Symmetrical driver output voltage levels and current limits
- Supplies are +12V and -12V @ ±10% regulation

**9617 EIA Line Receiver**

- 3 to 7K Ω input resistance
- Inputs protected to ±25V
- Each Receiver operates in fail-safe mode
- Controllable slicing or hysteresis operation
- Individual response pins to increase AC noise immunity
- Outputs TTL/DTL compatible
- +5V supply operation, ±5% regulation

Both the 9616 Driver and the 9617 Receiver are available from distributor stock. Design-in quantities available now; production quantities in late March. The 9616 @ \$4.50 and the 9617 @ \$3.50 in quantities of 100-999.

**Other Fairchild Drivers & Receivers**

- 9614 Dual Differential Line Driver
- 9615 Dual Differential Line Receiver
- 9620 Dual Differential Line Receiver
- 9621 Dual Line Driver
- 9622 Dual Differential Line Receiver
- SN75107-108 Dual Line Receivers
- SN75109-110 Dual Line Drivers

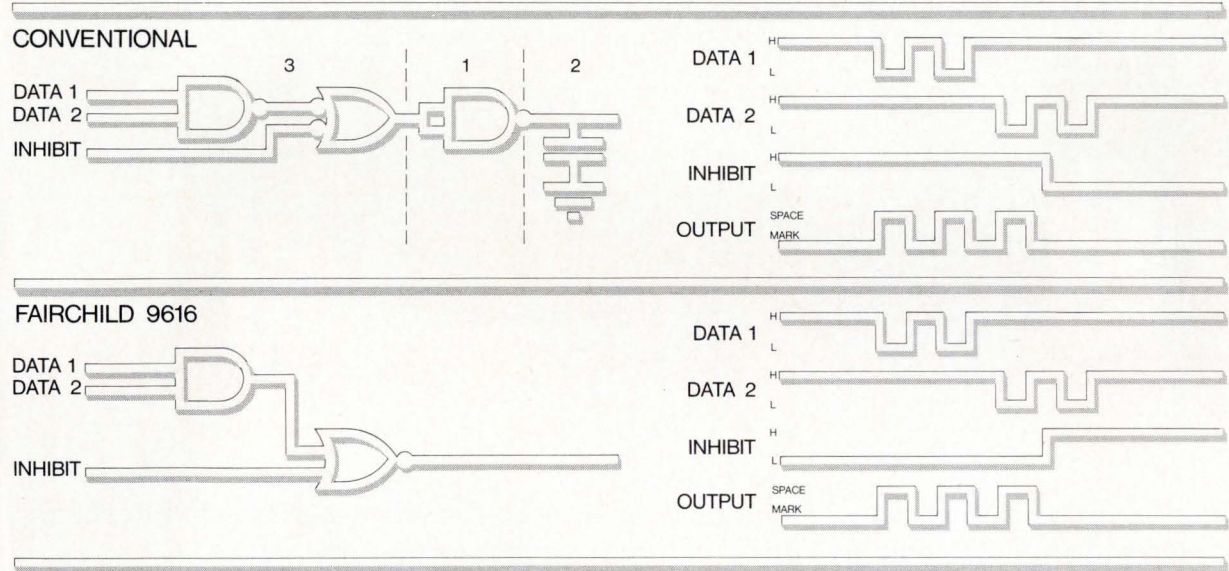

**COMPARISON OF CONVENTIONAL AND 9616 EIA DRIVERS**  
 Conventional EIA Driver (1) requires external slew rate control capacitor (2) and external gating for inhibit function (3). Fairchild 9616 EIA Driver requires neither.



# Your new computer's If it's not one of ours,

On what should be one of the most exciting days in your life, you wind up in a lurch.

Left there, sitting on your new computer with no idea, no way and nobody to help you hook it up.

In the business we call hooking up "interfacing".

And if you bought your computer from us in the first place, we'd have one of the engineers from our Logic Products Group

over there, face to face, ready to interface, when it arrives on time.

And he'd have all the smarts, parts and pieces that it takes to hook your computer up properly, to properly do what you want it to.

Like genuine Digital Equipment Corporation modules (including special modules) plus labs, wire wrap service, engineers, designers, logic people, seminars we set up for you in your area, cabinets, cables, hardware,

**The reason most small computer companies can't give you big**

# on your shipping dock. we know how you feel.

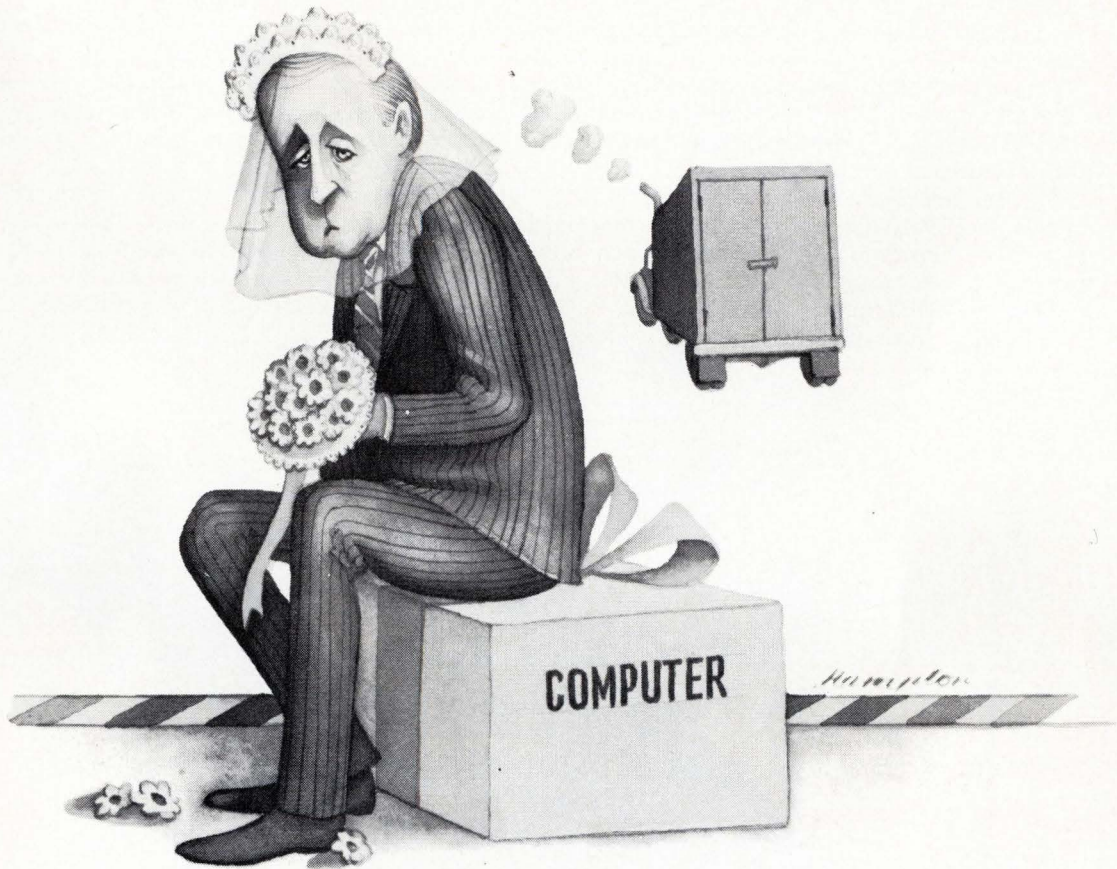

assembled logic arrays, terminals, etc.

We'd be happier if everybody in the world bought all their computers from us (we make and market more kinds, big, middle and small, than any other computer company in the world).

But, if you don't, and you don't know how to hook their's up when it does finally arrive, and they don't have anybody to run over and help you, we do.

And we will.

You see, we're big enough that it's no big deal to do it.

And we're bright enough to know that if we hook your computer up properly even if it isn't ours, you'll think we're nice guys and come to us first when it comes time to buy your second. (617) 897-5111 (Ext. 2785).

Digital Equipment Corporation,  
Maynard, Massachusetts 01754

**digital**

**computer support is because they're small computer companies.**

# SUE: THE FIRST GIRL MINICOMPUTER.

**It's a woman's right to change her mind.**

SUE is as different from other minicomputers as women are from men. And for the same reason. It's the way she's built.

SUE is the System User Engineered minicomputer.

From the beginning, the first principle in her make up was flexibility. In that she's unmatched.

Look at her main frame. The wideband width Infibus you see there has plugs for up to 24 cards. Memory cards. Logic cards. Arithmetic cards. Input/Output cards. Special interface cards. Even multiprocessors on a common Infibus. So there are literally hundreds of SUEs. What she can do depends on the number and combination of cards chosen for a particular application.

In short,

whatever kind of minicomputer you want her to be, she is. And that's all you pay for. Exactly the minicomputer you need.

As your needs change, you can change SUE. Simply by changing cards. You can expand her memory to 32K. You can mix core and semiconductor memories, and memories of different speeds, in the same system. She'll give you a thruput of 80 million words a second.

If you've got a system that's looking for a minicomputer, have we got a beauty for you.

Call SUE for her vital statistics. (213)

722-6810 or write: 6201 E.

Randolph St., Los Angeles,  
California 90040.



**Lockheed Electronics**

Data Products Division.

A Subsidiary of Lockheed Aircraft Corporation.

Visit SUE on the COMPUTER CARAVAN in a city near you.

---

# Washington Newsletter

---

February 28, 1972

## Will White House exempt joint R&D from antitrust laws?

The Nixon administration's plans to enhance the U.S. competitive position in world markets include **a proposal to relax antitrust statutes in order to permit cooperative research and development between companies**, say high Federal officials. Industry pressure on the White House to permit more cooperative efforts has increased since America last year recorded its first negative trade balance in this century.

**Since the issue has great inflammatory potential, particularly in an election year, the White House is reportedly sounding out the Congressional leaders** on acceptable proposals—including one disclosed by former Deputy Defense Secretary David Packard at the recent IEEE Winter Convention on Aerospace and Electronics Systems at Los Angeles. That plan would permit joint R&D efforts **on condition that results be fully and freely disclosed to all industry**. The subject was a major topic of conversation in a series of private meetings with science and industry leaders in Washington called by Edward David, science adviser to the President.

## RCA's Secant gains with Navy support in CAS race . . .

RCA Corp.'s aircraft collision avoidance system called Secant is back in competition with the older time-frequency systems such as McDonnell Douglas's EROS, following a favorable evaluation by the Naval Air Systems Command. **Navair reportedly told RCA that Secant is more accurate than time-frequency systems "by as much as five-to-one and 10-to-one in range and range rate, respectively" and "less susceptible to false alarms."** Moreover, RCA says Navair's assessment says "Secant has potential for an effective universal civil/military" system, a market estimated at upwards of \$300 million.

## . . . despite criticisms from McDonnell Douglas

As the Senate Commerce Committee continues to push the Government for adoption of a national collision avoidance system standard by 1974, the dispute between RCA and McDonnell Douglas appears to be generating more heat than light. The Air Transport Association, which has opted for time-frequency, is also right in the middle. McDonnell Douglas, says one Federal official close to the program, "is running a little scared"—and a recent company briefing in Washington, for representatives of the industry including RCA, did **blast Secant as unable to handle even existing air traffic volume**.

Despite the dispute, one Government source believes **RCA may have bought the time it needs and is now close to what it has long sought: a full-dress competitive flyoff** between time-frequency and Secant, under rules now being drafted by an interdepartmental committee of the FAA, DOD, and NASA.

## Addenda

Electronic cryptology equipment makers are getting **a new customer with DOD's creation of the Central Security Service** under direction of the head of the National Security Agency—but manufacturers will also lose four others as CSS absorbs individual military service functions. . . . **Final laser standards probably won't be ready until 1973** under the U.S. Bureau of Radiological Health's current timetable. A draft now being scrutinized by industry is due back to the bureau in April.

---

# Washington Commentary

---

**Congress to create  
own technology  
arm—at last . . .**

With the coming of March the Senate will move toward passing a bill critical to the future of electronics and other technologies that draw on Federal funds for support. **The bill calls for creation of an Office of Technology Assessment as a new independent arm of the Congress**, capable of making independent studies on proposals before it.

First advanced in the House in the mid-sixties by Emilio Q. Daddario, then a member from Connecticut, the concept of OTA produced many hearings and much debate through 1970. Then the proposal became submerged in the legislative process, not to reappear until its successful passage in February by the House. The fact that the bill passed that body without a ripple is credited to Daddario's successor as chairman of the science, research, and development subcommittee, Georgia's John Davis [see p.14]. Now North Carolina's Everett Jordan, the Senate elder who chairs the Rules Committee, is expected to conduct swift hearings, and deliver the bill to the floor. With such leadership, no problems are anticipated there.

Because of the growth of the executive branch and its heavy annual outlays for defense, space, transportation, health, and law enforcement, **Congress has become increasingly frustrated by its inability to make its own assessment of program priorities and their true costs.** "When some administrator comes up here and testifies that Project X is going to cost \$100 million and someone else says, 'No, it's really going to cost you \$500 million before you are done,' we simply have not had the expertise to determine the truth," complains one House committee staffer.

**OTA would be able to subpoena appropriate Government and industry records and contract out for independent studies, giving Congress "an early warning system of the probable impacts—positive and negative—of the applications of technology"**—to quote John Davis. One strong argument for OTA, in the Davis view, is that Congress has provided itself with no new institutionalized aid since the functions of the General Accounting Office were established in 1921, despite the rapid growth of Federal support of technology.

**. . . will politics  
turn assessment  
into arrestment?**

Are there, then, no weaknesses in the establishment of OTA? The organization of its 11-member board appears sound. It will consist of two senators and two representatives from different parties—to be appointed by the president *pro tem* and the speaker, respectively—plus the Comptroller General, the director of the congressional research service, and four nationally prominent scientists or engineers named by the President for staggered terms of four years each. And to prevent the creation of a new Federal czardom, these 10 will elect the director of OTA to a six-year term. Though the office is scheduled to start with a \$5 million annual budget in addition to contracting studies and drawing on the resources of the CSR and GAO, it's sure to expand rapidly.

And there's the rub: **while OTA will be able to initiate its own studies, it must also respond to requests for studies by any one of 86 committee and subcommittee chairmen and ranking minority members.** That is almost certain to guarantee OTA's growth, and means that probably political considerations will motivate some in Congress to employ OTA for technology arrestment instead of assessment. Such qualms, however, produce knowing and unworried smiles on Capitol Hill where, as Davis puts it, "everything has its political component." Granting Congress's long-standing need, this suggests **OTA success will depend largely on the strengths of its early leadership and its ability to withstand pressures political and bureaucratic.** —Ray Connolly

# Here's enough to put you onto flat flexible cable.

Now you can have all the benefits of flat cable—weight, density and flexibility—to use it, everywhere. Our full line of connectors, specifically designed to take advantage of what flat flexible cable offers, will take you wherever you want to go—cable-to-cable, cable-to-wire, cable-to-post and cable-to-printed-circuit board. Now with the addition of our newest one-piece connector, we can also offer cable-to-printed-circuit board with a card-edge connector.

Once you decide on how to go, AMPECONOMATION, our unique automated termination technique, makes getting there fast, reliable and easy. No need to prepare the cable. Just cut to length and the machine terminates up to 3400 connections per hour . . . automatically. Four areas of contact, made with our exclusive insulation displacement crimp technique, assures the utmost in reliability.

We can supply connectors and application machine for flat cable assembly production in your plant, or provide finished assemblies to your specifications, ready for your equipment. For complete information write:

**AMP Incorporated, Industrial Division, Harrisburg, Pa. 17105.**

**AMP**  
INCORPORATED

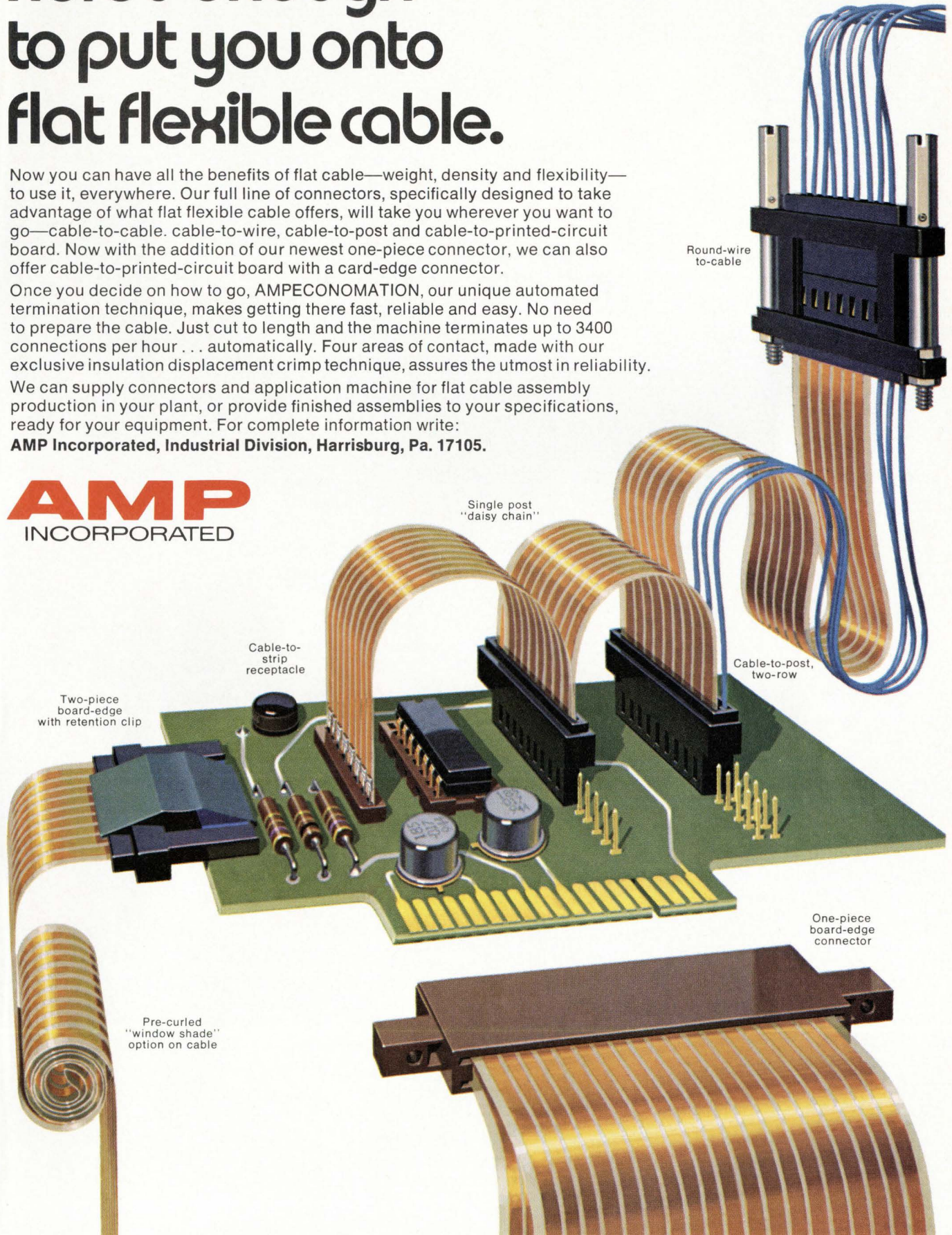

Round-wire to-cable

Single post "daisy chain"

Cable-to-strip receptacle

Cable-to-post, two-row

Two-piece board-edge with retention clip

One-piece board-edge connector

Pre-curved "window shade" option on cable

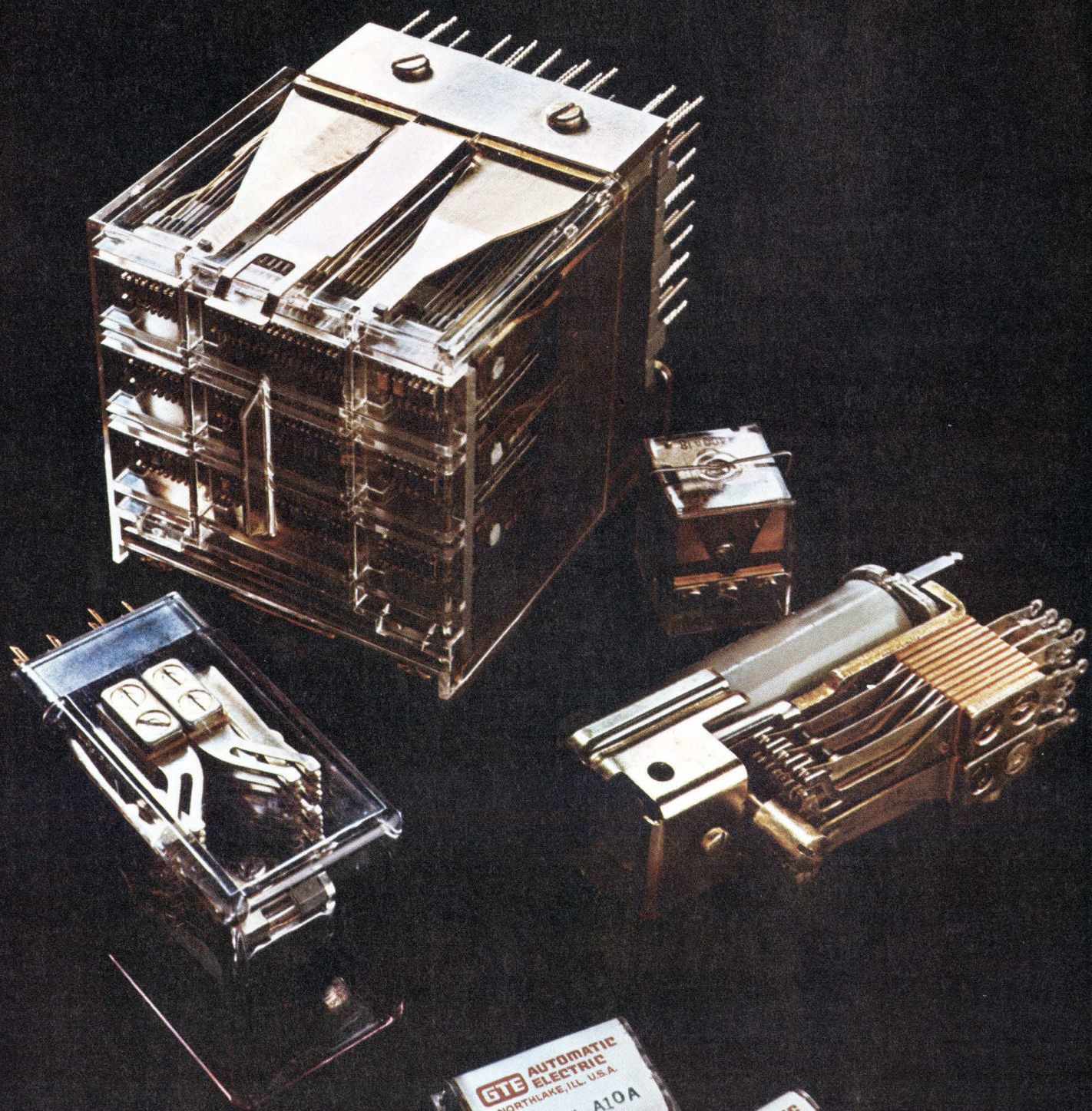

**GTE AUTOMATIC ELECTRIC**  
NORTHLAKE, ILL. U.S.A.  
PD1311 A10A  
1930 OHMS

**GTE AUTOMATIC ELECTRIC**  
NORTHLAKE, ILL. U.S.A.  
PD1308 A11A  
2600 OHMS



# Announcing the rediscovery of the relay.

In an age when most people think solid state is the only way to go, some designers have rediscovered the good old electro-mechanical relay. They found relays still can't be beat when it comes to certain jobs. And when they're dealing with tight fisted cost control committees. Maybe you can save some effort and expense by rediscovering the relay whenever you need these things:

## **1. Simple logic:**

Relays let you combine both power switching and logic functions economically. Memory can usually be retained, even after a power loss. And you don't need special power supplies or noise suppression techniques.

## **2. Easy troubleshooting:**

Most relay failures (and they do occur occasionally) can be identified visually. You can see what's wrong. And fix it easily.

## **3. Heat resistance:**

A relay shrugs off a short dose of overheating. Give a solid state device the same treatment while it's functioning near capacity and it's ruined forever. The amount of heat a solid state device can take is usually dependent on the heat sink used. It can take up all the room you expected to save with solid state in the first place. And finding the right heat sink design can become very involved.

## **4. Electrical isolation:**

Relays have a natural isolation between input

circuits, between output circuits, and between output and input control circuits. You can't get that with junction type semiconductors.

## **5. High insulation resistance:**

Open relay contacts have an insignificant amount of leakage ( $10^{10}$  ohms or more). Semiconductors can't match this. And, their leakage rates vary greatly with temperature changes.

## **6. Wide operating power range:**

Relays work with operating power anywhere from milliwatts to watts. And they usually don't require regulated power. Semiconductors do.

## **7. Transient voltage immunity:**

Transient voltage doesn't bother a relay. But high voltage, short duration transients can be sure death to semiconductors.

## **8. Forgiveness:**

Relays give you a little margin of safety should you want to change your mind. Maybe you find you need more contacts, or uncover a timing problem, or discover a need for absolute input-output isolation. You can change your circuit design a lot easier with relays.

If your project or product needs any of these things, just ask our salesman to help you rediscover relays. GTE Automatic Electric, Industrial Sales Division, Northlake, Illinois 60164.

**GTE AUTOMATIC ELECTRIC**

# Two Years Ago, Almost

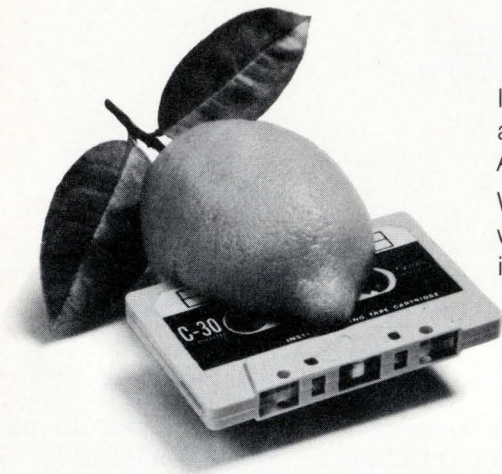

Including us. A digital cassette recorder. Seemed like a great idea at the time. But there was too much garbled info. And lousy reliability. A bumper crop of real lemons.

Well, we licked our wounds along with everyone else. But we also went back to the drawing board because we still thought the basic idea was sound. And we came up with a unit that really works.

## A Whole New Concept

To get super reliability, we reasoned, you have to control that tape. So, we started from scratch. Got rid of the traditional pinch rollers, belts, solenoids, levers and mechanical linkages from the transport. Took out the head guide forks.

Eliminated the need for pressure pads. Those were the main cause of head and tape wear, oxide shed and dropout.

Then, instead of just pushing the head up to the tape as it rolls by, we decided to get the tape out of the cassette. (That way the cassette is just a tape holder.)

So we designed two little fingers that pull the tape down past the head, over a precision guide and around a capstan. That maintains optimum head wrap angle—critical for read-after-write operation. And it's all done automatically as you load. (We've got a patent pending, in case you're interested.)

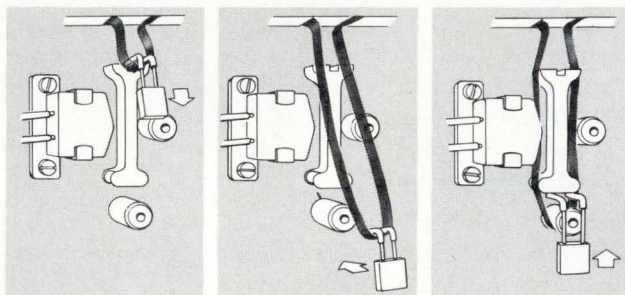

## The Insides

Next, we put in three DC motors. One for the capstan and one for each reel. Servos positively control tape tension on both sides of the capstan. And tension sensors confirm proper loading to BOT—no writing on tape leader. There's no drag on the tape. Ever.

So now we have high bi-directional tape speed, fast start/stop times, precise start/stop distances.

Reel motor torque is automatically reduced when EOT or BOT is sensed to prevent pulling tape from cassette reel hubs or other possible tape damage.

All modular electronics. Plug in PC boards. Logic and interface that're TTL compatible.

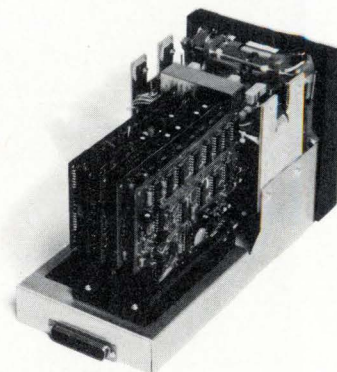

# Everybody Brought One Out

## The Outsides

All these components are mounted in a cast aluminum frame. Very, very rugged. So it works for any number of EDP OEM applications. And we supply it for users in a handsome case with straightforward, push-button controls.

## Real Reel to Reel Performance

Our basic Model 240 has 2 tracks, selectable data rates from 2 to 20 ips, with start/stop times of 15-30 msec. Same start/stop times for 50 ips search or fast forward/reverse. It operates in incremental and/or continuous modes, and in several combinations of recording codes/data channel selections. Test data indicates: calculated MTBF in excess of 2,000 hours. Thousands of passes without tape damage.

## Options

All sorts of options. Like two selectable read/write speeds. Dual gap read-after-write head. Separate read-after-write heads. Power supply. Rack mount kit. Automatic tape cleaner. Etcetera.

## Don't Wait. Order Now

Now that we've really licked performance and reliability problems, we figure our recorder's a natural for business machine manufacturers, terminal makers, mini computer builders.

And users. A great replacement for punched paper tape. Even some reel to reel mag tape applications. Especially at the price. About \$500 to \$600 in bunches.



## Bell & Howell & a Digital Cassette Recorder That Works

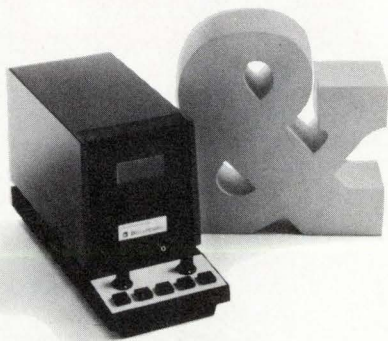

- Send me all the specs.
- Send a guy around for a demo.
- Here's my P.O. You fill in the blanks.

Name \_\_\_\_\_

Title \_\_\_\_\_

Company \_\_\_\_\_

Address \_\_\_\_\_

City \_\_\_\_\_ State \_\_\_\_\_ Zip \_\_\_\_\_

Bell & Howell - Electronics & Instruments Group,  
360 Sierra Madre Villa, Pasadena, California 91109

ELECTRONICS & INSTRUMENTS GROUP

 **BELL & HOWELL**

© COPYRIGHT 1972 BELL & HOWELL

# Only Electronics takes you into all 5 audience dimensions



**1. Management Dimension 2. Technical Dimension 3. International Dimension  
4. Purchasing Dimension 5. Reader Involvement Dimension**

**New reader profile study highlights the power of *Electronics* readers in five key areas. These are the people you must reach to move a product or a service in the worldwide electronics markets today—and tomorrow.**

**If you want to know just how powerful a magazine is as an advertising medium, ask its readers. We did. Here's what they said.**

**1. *Electronics* subscribers** are vitally important to their companies, and therefore must be important to you: 58,000 (67%) have a management responsibility. 48,000 (56%) are responsible for their companies' profit. 68,000 (79%) travel on business for their companies — 31% make more than 7 trips per year.

**2. *Electronics* subscribers** are determining the technical and business futures of their companies. They're also determining yours: 70,000 (81%) have engineering job functions. 69,000 (80%) participate in business, product or technology planning.

74,000 (86%) do or supervise design work.

**3. *Electronics* subscribers** are where you need them: 76,000 (88%) work in the worldwide electronics original equipment market. 7,600 (9%) more, work in vital "user" markets. 44,000 (52%) work in the five major growth markets of the '70's—computers, communications, instrumentation, industrial controls and consumer products.

**4. *Electronics* subscribers** buy your products: 73,000 (85%) select vendors. 23,000 (26%) recommend, approve or

specify purchases in excess of \$100,000 per year.

70,000 (82%) buy passive components.

71,000 (83%) buy control and display components.

77,000 (90%) buy active components.

75,000 (88%) buy instruments and test equipment.

**5. *Electronics* subscribers** depend on *Electronics*:

55,000 (64%) read it at home.

41,000 (48%) spend more than one hour reading each issue.

25,000 (29%) do not read *any* of the next six publications in the field.

55,000 (64%) do not read the second publication in the field.

68,000 (79%) do not read the third publication in the field.

It all adds up to this one crucial point—a magazine's power is only as great as the power of its readers. Only *Electronics* takes you into all 5 audience dimensions. For complete details on this new reader profile study, contact your nearest *Electronics* advertising district manager.

## Reach the buyers for your product where they're at.

Beginning with the January 3, 1972 issue, *Electronics* offers advertisers four different market-coverage opportunities.

**a. Full-Run.** Advertisers may reach the *Electronics* worldwide audience of 86,000 with one advertising message. Full-run advertising rates are lowest on a cost-per-thousand basis. Full-run space earns frequency discounts for all other options.

**b. Full-Run, Copy Split.** Advertisers may reach *Electronics* worldwide audience with two or more advertising messages. Full-run rates apply, plus split-run charge. A standard domestic-overseas split is available at low charge. Full-run split advertising space earns frequency discounts for other options.

**c. International Advertising.** Advertisers may elect to reach only the *Electronics* overseas audience of 16,000 through the International Advertising Section, which is available in all issues. IAS space earns frequency discounts only for IAS advertising.

**d. Domestic Advertising.** Advertisers may elect to reach only the *Electronics* U.S. and Canadian audience. This option is available every issue but publisher reserves the right to restrict space to 12 pages per issue. Space units of full page or larger only. Domestic advertising space earns frequency discounts for domestic advertising only.

## Electronics offers free proof of advertising effectiveness.

For 1972, *Electronics* offers you a free inquiry follow-up service—Buyer Action Measurement (BAM). It can determine for you just where the buying action is for your product. BAM has a tremendous memory bank which enables you to get unusual and critical information on products you advertise. And, *Electronics* is the only magazine in its field to offer any such service with BAM's capability. Here's how BAM works:

1. When a prospective buyer circles a number on the *Electronics* Reader Service Card, he also checks off his industry classification. When the card is received by BAM, the information is stored in the computer. Questionnaires are then mailed to the requestees to determine the action taken. The response to these questionnaires is also stored in the computer.

2. BAM then produces a printout table

that tells you number of requests for information, number of questionnaires returned from requestees, the percent of response, five types of action taken by respondents, number and percent of sales actions taken—all broken down by industry classification.

3. In addition, BAM gives you a comparison report showing the action taken by your customers and prospects on all similar products to yours that were advertised in the same issue.

4. And, as a final service, BAM offers a cumulative comparison report, by product, of all the issues studied. From this, you can determine where the

sales actions for your type of product come from over a period of time.

*Electronics* offers AD COM—Advertising Communications Evaluation—the most comprehensive advertising readership service available anywhere. It tells you, through 100 personal interviews, the percent of respondents who remembered seeing your ad and remembered reading it. It also tells you whether your message got through and whether it was believable. Finally, it tells you the percentage of readers who took or plan to take action as a result of reading your advertisement.

## 1972 ADVERTISING SCHEDULING GUIDE

Use this convenient advertising scheduling guide to take full advantage of special issues and reports, as well as those issues which are scheduled for BAM and

AD COM. You will be notified well in advance of closing dates of the additional special reports and studies as they become scheduled.

ISSUE	CLOSING	CYCLES	SPECIAL REPORTS	BAM	AD COM
Jan 3	Dec 10	A	Annual U.S. Markets Report	✓	
Jan 17	Dec 24	B			✓
Jan 31	Jan 7	A		✓	
Feb 14	Jan 21	B		✓	
Feb 28	Feb 4	A			✓
Mar 13	Feb 18	B	IEEE Preview		
Mar 27	Mar 3	A		✓	
Apr 10	Mar 17	B			✓
Apr 24	Mar 31	A			
May 8	Apr 14	B		✓	
May 22	Apr 28	A			✓
June 5	May 12	B		✓	
June 19	May 26	A			
Jul 3	June 9	B			✓
Jul 17	June 23	A			
Jul 31	Jul 7	B			
Aug 14	Jul 21	A			✓
Aug 28	Aug 4	B			
Sept 11	Aug 18	A	Wescon Preview		
Sept 25	Sept 1	B			
Oct 9	Sept 15	A			
Oct 23	Sept 29	B			
Nov 6	Oct 13	A			
Nov 20	Oct 27	B	Japan Markets Report		
Dec 4	Nov 10	A			
Dec 18	Nov 24	B	European Markets		

### TOTAL PAGES SCHEDULED \_\_\_\_\_

### Get the whole picture.

For the total picture of what the five-dimensional audience of *Electronics* can do for you, contact your local *Electronics* district manager.

That's also where you can get a complete copy of our new International Profile Study, as well as the recently-completed European Product Preference Poll and the domestic

Product Preference poll. Plus the 1972 *Electronics* rate card.

You can't sell to the world's electronics markets unless you reach all five audience dimensions.

**Electronics**  
The International Magazine  
of Electronics Technology



# Try our straightforward method of reducing fixed resistor costs.

You can't blame engineers or purchasing agents for trying to save every last penny on resistors these days. But lowest price doesn't necessarily mean lowest cost. For example, most manufacturer's color bands won't stand up to the cleaning methods used to remove excess flux. Or they darken and become illegible from the heat

produced in normal usage. This can mean costly identification errors on your production line. The unnecessary expense of rework. Our solution? A-B quality. Bright, crisp identification of Allen-Bradley's specially formulated paints. Baked on to stay on. Designed to resist aging. Discover the other ways to save money. Ask your nearest

A-B distributor for our free booklet "7 ways to tell the difference in fixed resistors." Or write Allen-Bradley Electronics Division, 1201 South Second Street, Milwaukee, Wisconsin 53204. Export: Bloomfield, New Jersey 07003. Canada: Galt, Ontario. United Kingdom: Bletchley, Bucks.

NEW DIMENSION ELECTRONICS  
**ALLEN-BRADLEY**



# Technical articles

---

## **Bucket brigade puts analog functions on chips: p.62 (cover)**

In bucket brigade devices, as in charge-coupled devices, charge is jumped from stage to stage before landing in an output amplifier, explains Solid State Editor Larry Altman in the first of three articles on this novel semiconductor technology. These devices are good as analog delay lines as well as for filtering and imaging applications. Also, to move the charge along, no contact is needed with the silicon, and this simplifies their manufacture. Being more conventional in structure than charge-coupled devices, however, BBDs will probably go into production sooner.

The cover: RCA's image sensor is based on bucket brigade principles, and was developed under contract to the Air Force.

In the second article, L. Boonstra and F. L. J. Sangster of Philips discuss bucket brigade theory and the practical adaptations needed to realize actual devices. They then describe a series of both bipolar and MOS devices that have already been built in their laboratory, some of which are expected to go into production shortly.

Last of all, four researchers from RCA—P. Weimer, M. Kovac, W. Pike, and F. Shallcross—assess the advantages that bucket brigade image sensors will have over X-Y addressed devices. They should be more sensitive, less affected by interference from switching transients, and, above all, self-scanning.

## **An inexpensive way of testing 1,000 transistors a day: p.84**

For production-line testing of a moderate volume of transistors, laboratory equipment is clumsy and often inaccurate, while special-purpose test sets are disproportionately expensive. The solution is to build your own equipment, says author Jerry Graeme. He outlines the eight basic circuits needed to handle bipolar and field effect transistors, and estimates their cost at not more than \$100 each—and their accuracy as equalling that of the high-volume equipment.

## **What the books don't tell you about preparing cost estimates: p.90**

The project engineer must avoid having a "provincial engineering viewpoint," warns author Thomas Samaras. He must take support costs into account along with basic hardware costs, he must keep two-way communications running with department heads, and he must be aware of the cost of expert advice. Perhaps his biggest headache is estimating requirements for new test and manufacturing equipment.

## **And in the next issue . . .**

New directions for IEEE . . . special report on digital-to-analog converters . . . a different way of interfacing minicomputers and peripherals.

# Bucket brigade devices pass from principle to prototype

An outline of the theory underlying bucket brigade devices, which belong to the new breed of charge transport semiconductors, introduces two articles on their use in many analog applications

by Laurence Altman, *Solid State Editor*

□ Bucket brigades, members of the expanding semiconductor family of charge transport devices, could prove to be the sleeper of the seventies.

Significantly, this technology, along with the related charge-coupled process, can be applied to complex analog signals, and for the first time brings the techniques of integrated circuitry to bear on these functions. In these circuits, charge is passed from stage to stage, and then dumped in an output amplifier. Unlike conventional MOS and bipolar circuits, bucket brigade devices can act as analog delay lines for audio and video systems, as filters, and as imaging devices for cameras.

The attractive thing about them is that they're economical to build. They require fewer diffusions into the silicon and fewer contacts through the silicon than do conventional MOS circuits. Moreover, their storage sites are smaller, making them particularly attractive for large memory and logical arrays.

### How it works

Figure 1 shows cross-sections of a bucket brigade and a charge-coupled device. They function as shift registers by manipulating charge along a series of electrodes, but, unlike all previous MOS structures, they move this charge without requiring contact with the silicon. However, the CCD stores the charge in potential wells, and moves these wells along from electrode to electrode, whereas the BBD controls the charge by means of transistors and capacitors. Being more conventional, BBDs occupy an intermediate step between MOS and CCDs, and will probably go into production before CCDs. But because CCDs are simple—no diffusions are required to transfer charge between sites, while a BBD requires two

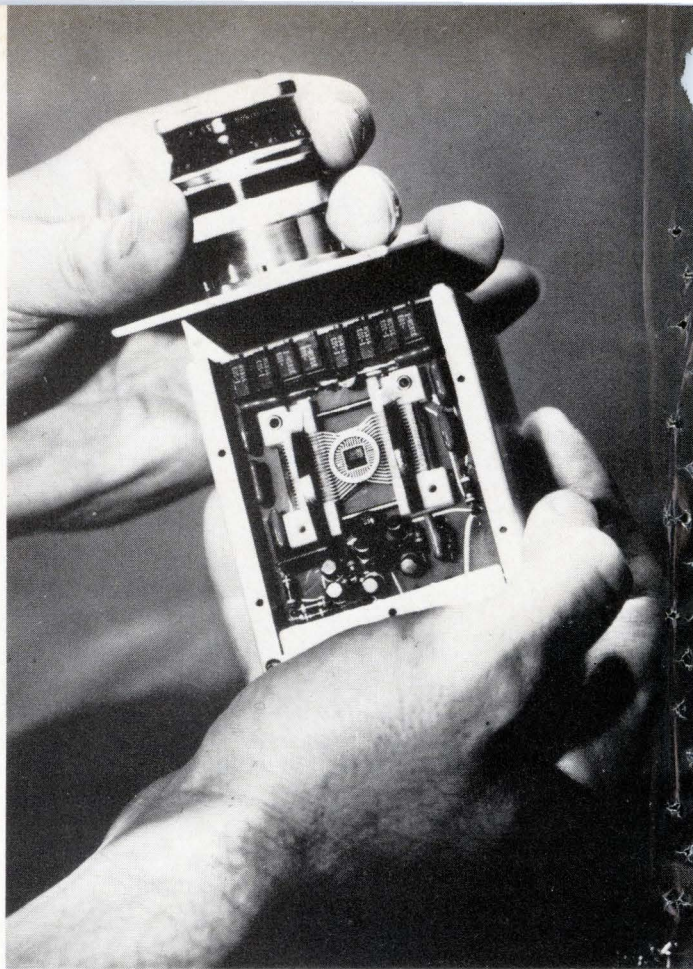

**Putting ICs in the picture.** Bucket brigade techniques are good ones for imaging because they are simpler than those of silicon diode targets. This BBD array, built by RCA for the Air Force at Wright Patterson, has a 44-by-30 element array (see article, p. 72).

per site—they ultimately may offer the greater cost advantage and better operating performance.

As the figure shows, a bucket brigade device is an insulated-gate, field effect transistor with a two-phase transfer mode. Storage sites are offset p-regions under MOS capacitors. Since no contact is made with these diffusions, which form islands in the silicon substrate, charge must be transferred by manipulation of the potential on adjacent electrodes.

A bucket brigade device operates in the two transfer modes. In the storage mode all electrodes are at the same potential. In the transfer mode the potential on one electrode is made large enough to reduce the potential barrier and let charge flow from one p-region to the next. This process is repeated until the charge is transferred through the device in normal shift register action.

Indeed, CCDs are not as simple in practice as they are conceptually. For example, although not part of the basic CCD concept, diffusions are inevitably necessary at the input and output of the CCD shift register, and in the regenerating stages as well.

The BBD may be thought of as a row of insulated-gate FETs with source and drains connected and with the gates capacitively coupled to the drains, all on a single substrate. As in ordinary MOS shift registers, minority carriers are transformed into majority carriers at each transfer step between depletion regions. Because of the presence of depletion regions, the transfer of charge is



relatively secure and can readily be implemented with today's fabricating techniques.

With CCDs, on the other hand, this transformation of majority carriers in the depletion region is not required at each transfer, and need occur only at those points where the charge is accumulated and detected either to regenerate the charge train or reroute it. Again, this ability of CCDs to operate with the charge remaining in its fundamental minority state confirms the elegance and ultimately the strength of this technology. The only problem is that, to get sufficient coupling between adjacent inversion layers, their separation must be as small as 3 microns, and this spacing is not attainable with standard photolithographic (10-micron) rules. And, though the use of overlapping silicon gate electrodes will get round this difficulty, it adds to CCD complexity.

### How they compare

A comparison of bucket brigade devices, charge-coupled devices, and conventional MOS memories is given in the table. As memories, CCDs and BBDs can operate at 10- to 20-megahertz data bit rates, consume only about 5 microwatts of power per bit, even when fabricated with the most relaxed rules—and are expected to become 10 times faster when better lithographic techniques are used. Comparable figures for the most advanced silicone gate MOS memories are 5 MHz and 100  $\mu\text{W}$  per bit.

Cell size can be expected to be less than a 1  $\text{mil}^2$  if silicon gate construction is used. Consequently bit packing densities of greater than 1 million bits per square inch are feasible. This compares to about 6- $\text{mil}^2$  cells for the best MOS operating today, although laboratory MOS devices have been built with cells of about 3  $\text{mil}^2$ . In any case, with their very high density and yield expectancy, charge transport devices having 10,000 bits on a chip and costing less than \$10 can be envisioned.

In the following articles, the technology of bucket brigade is explored. First, F. L. J. Sangster, who invented the technology, and his co-author L. Boonstra will give an overview of BB concepts and how they lend themselves to a whole range of applications. Next, Paul Weimer and his colleagues from RCA Labs in Princeton will describe a BB camera.  $\square$

### TECHNOLOGY PERFORMANCE COMPARISON

Type of device	Power per bit ( $\mu\text{W}$ )	Frequency (MHz)	Area per bit ( $\text{mil}^2$ )
MOS	100	5	2
BBD	5	10	2
CCD	5	20	6

### CHARGE TRANSPORT DEVICE COMPARISON

Type of device	Gain	No. of metal layers	No. of phases	Diffusions required	Clock dig-downs required	Process compatibility
BB	Active	1	2	Yes	No	Standard MOS (p & n channel)
CCD Bell Labs	Passive	1	3	No	Yes	Standard MOS (p & n channel)
GE	Active	2	2	No	No	Self-registered MOS (p or n channel)

**Charging along.** Both charge-coupled and bucket brigade devices transfer charge without needing contacts (digdowns) through the silicon substrate.

In the CCD structure (a), the charge that is stored in and transferred between potential wells forms the basis of operation. Shown here is a three-phase CCD system. In the storage mode, a voltage  $-V_2$  is greater than the bias voltage  $-V_1$  and forms a potential well that captures the charge. In the transfer mode, charge moves along to the next electrode as soon as a still larger voltage  $-V_3$  has been applied to that electrode, and has created a larger potential well into which the charge is dumped.

The bucket brigade structure illustrated in (b) is very like its charge-coupled counterpart in operation and construction. It has one additional fabricating complexity, however—it requires the usual p-type depletion regions in the n-substrate. This two-phase device has offset p-regions under its MOS capacitors, and these regions form islands in the silicon substrate.

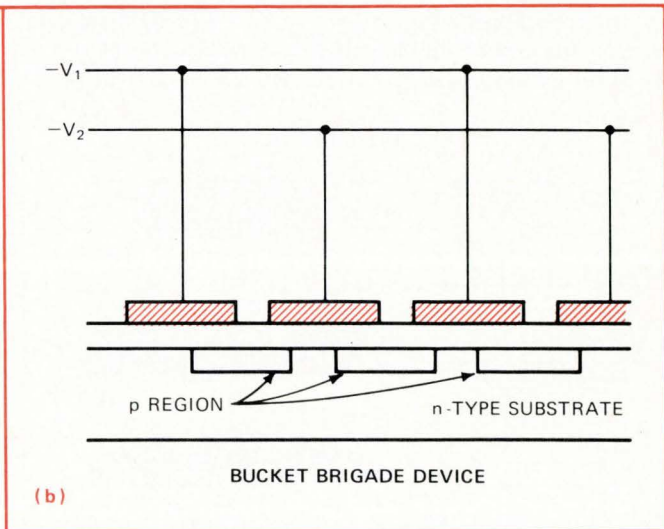
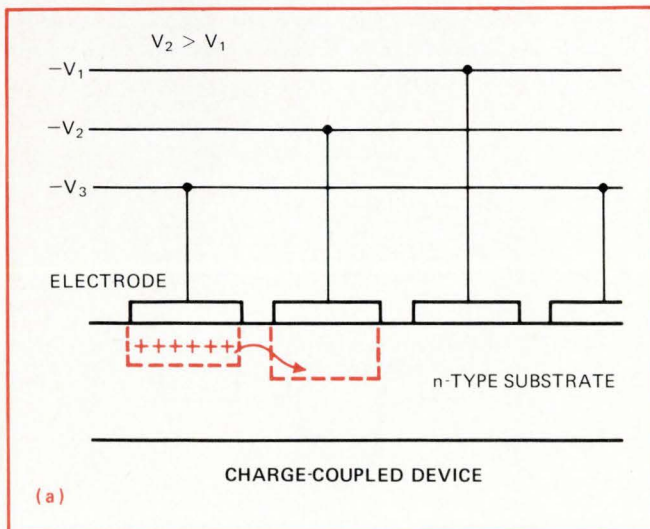

## Analog functions fit neatly onto charge transport chips

Delay lines, time-error correction, filters and imagers can all benefit from monolithic technology now that bucket brigade devices are proving out

by L. Boonstra and F. L. J. Sangster  
Philips Research Laboratories, Eindhoven, Netherlands

□ With the arrival of bucket brigade concepts, the techniques developed for digital ICs have become adaptable to analog signals. Indeed, the capacity to handle streams of analog signals is basic to the growing charge transport semiconductor technology, which provides elegant IC versions of a host of electronic functions: audio and video delay, time-error correction, time-scale conversion, filtering, and imaging.

The bucket brigade concept of storing analog signals is not new. In proposing it in 1946, K. Schlesinger showed that samples of analog signals could be stored as charge levels on a row of capacitors. These signals could then be shifted periodically from one capacitor to the next by means of transfer circuits operated by a clock signal.

Interestingly, it is this operating principle that is widely used in today's commercially available MOS digital shift registers. But it did not come into general use for analog information because here the function of the transfer circuit is different and rather sophisticated: it has to perform a near-perfect transfer of the signal samples, free from loss, noise, nonlinearity, and residual storage. Also, if it's to compete economically with conventional delay lines, the complete circuit has to be very

**1. Versatile.** A two-phase bucket brigade device can be built with either bipolar or MOS transistors. Storage utilizes parasitic collector-to-base or source-to-drain capacitance, which is enlarged in the bucket brigade structure, rather than minimized as in conventional structures. Because it's easy to make structures with large values of parasitic capacitance, BBDs are easier to build than standard IC structures—silicon gate structure yields maximum packing density.

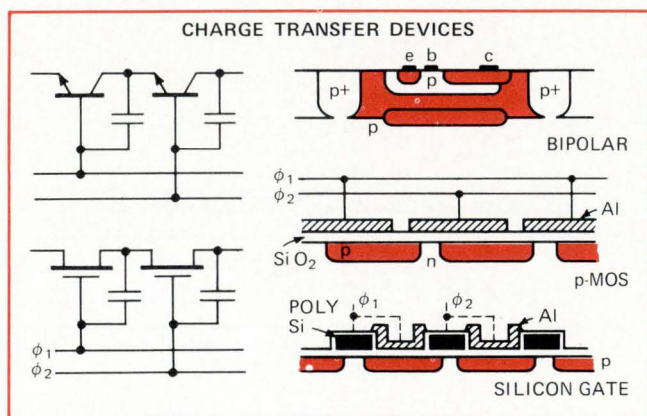

simple so that many stages can fit on one chip.

The first practical adaptation of the concept to analog signals, proposed by one of the authors in 1966, was in a simple but adequate circuit that used only one transistor to perform the transfer function. As shown in Fig. 1, this circuit can use either bipolar or MOS transistors. The parasitic collector-base or source-drain capacitance, which other circuit designers try to avoid, is deliberately enlarged to perform the storage function. This makes the IC realization of bucket brigades very simple.

### Storage and transfer modes

Figure 2 shows the surface potential below the circuit's electrodes. As the potential levels during the storage mode indicate, the first and third storage capacitors contain information represented by a surplus charge above a fixed reference level  $-V_{\phi} + V_T$ , where  $V_{\phi}$  and  $V_T$  represent the clock amplitude and the threshold voltage respectively. The second capacitor is charged to this reference level, and contains no information.

During the transfer mode, the voltages on the second capacitor electrode and on the gate of the preceding MOS transistor are lowered by an amount  $V_{\phi}$ . This potential change allows the excess charge of the first capacitor to move along to the second. The information in the third stage is similarly transferred to the fourth, etc.

According to the sampling theorem, a signal with a bandwidth of B hertz can be fully characterized by  $2B$  samples per second. Thus, for a delay of T seconds a circuit must be capable of storing at least  $2BT_d$  signal samples. In the two-phase system of Fig. 2, only half the capacitors contain information; thus the number of capacitors needed is:

$$N = 4 BT_d \quad (1)$$

In audio techniques, a bandwidth of a few kilohertz and a delay of at least a few tens of milliseconds are re-

**2. Charge of the bucket brigade.** In the storage mode, the first and third stages contain information represented by surplus charge above a fixed reference level  $-V_{\phi} + V_T$  where  $V_{\phi}$  and  $V_T$  represent the clock amplitude and the threshold voltage respectively. The second stage is charged to the reference level, and contains no information. To transfer charge, the voltage on the second capacitor electrode and on the gate of the preceding MOS structure is lowered by the amount  $V_{\phi}$ ; the excess charge of the first capacitor is transferred to the second; likewise, the information in the third stage is transferred to the fourth, and so on.

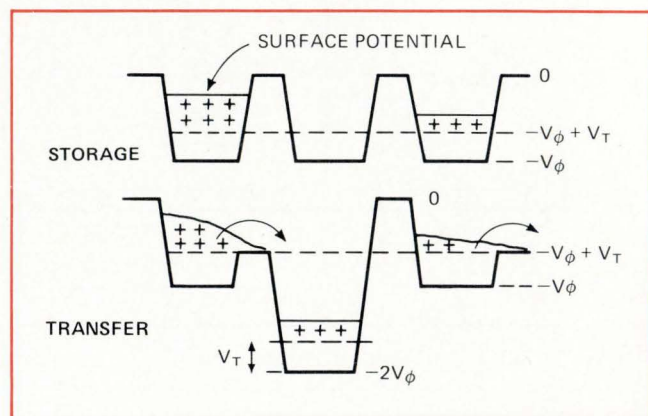

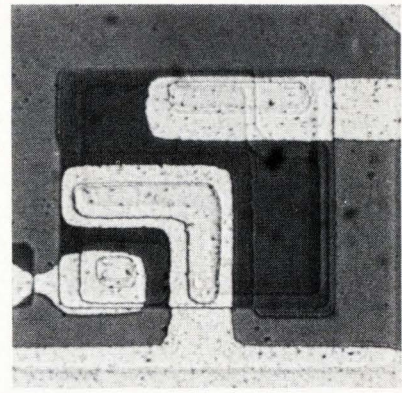
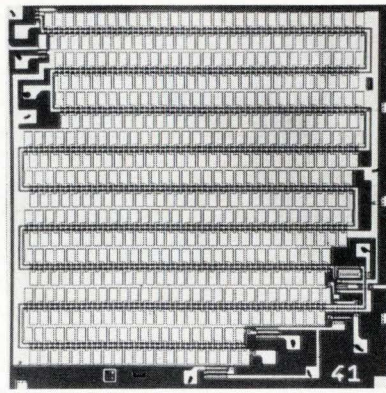
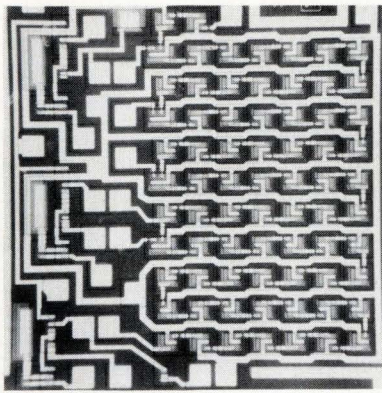

(a)

(b)

**3. Samples.** A variety of circuits can be built with bucket brigades. The photomicrograph (a) displays a bipolar BB delay line used for video signals. Also shown is the detail of a single bucket. Although area per bucket is only 150 to 150  $\mu\text{m}$ , bucket has a capacitance of 2 pF, resulting in logic swings that are easily detected. The 512-stage MOS BB shift register (b) is used as an audio delay line.

quired. In video techniques, at least a few megahertz and a few tens of microseconds are needed. From equation (1), these applications require delay lines of a few hundred stages, well within present IC capabilities.

On the basis of this theory, a variety of both bipolar and MOS bucket brigade ICs have been realized in the laboratory. Figure 3 (a) shows a bipolar BB delay line, consisting of 72 stages, which could be used for the delay of video signals. It has a per-bucket area of  $150 \times 150$  square micrometers and a storage capacitance of 2 picofarads. Figure 3 (b) is a photograph of a MOS BB with 512 stages. Chip size is only  $3 \times 3$  square millimeters, and storage capacitance is 3 pF.

### The charge transfer process

Since the key to adapting the capacitor array principle to analog functions is the charge transfer process, this process deserves detailed discussion. The curve in Fig. 4 (a) shows the variation of the excess charge on a storage capacitor as a function of time. At the start of the transfer process, the storage capacitor has an excess charge  $Q_0$ . At the end, all excess charge has been transferred, and the capacitor is recharged to the reference level, which in the bipolar version is  $+V_\phi$  and in the pMOS version,  $-V_\phi + V_T$ .

It can be shown that the discharge curve of the MOS BB closely approximates a curve of the form  $1/(1+t/\tau)$ . Initially the bipolar BB version follows the same  $1/(1+t/\tau)$  curve, but thereafter it converts to a  $\log 1/(1+t/\tau)$  curve for values of  $t$  greater than  $10\tau$ . In either case the value of the time constant  $\tau$  is dependent on the geometry of the storage cell.

Details of several discharge curves are given in Fig. 5. Note that all rapidly converge in a common discharge curve, regardless of their starting point. This is significant, since any residual charge left at the end of the transfer period, labelled  $Q_e$  in the figure, represents the reference level for the next transfer. The constant component of this charge residue is not harmful, for it results only in a constant dc bias shift of the signal. But the signal-dependent part adds to the next sample, and this effect is cumulative because it occurs in each stage. As a result, each signal sample will be smeared out, ar-

riving at the output of the chain as a spurious signal, as Fig. 4 (b) shows. Thus a signal step, which is the integral of a single pulse, will be distorted in the way indicated in Fig. 4 (c).

This residue-related signal distortion seriously limits the operation of bucket-brigade circuits. For example, in binary shift registers, its effect will be to reduce the noise margin between zeros and ones. In analog signal handling, its effect is manifested as an attenuation of the highest signal frequencies, and is cumulative. In fact, it is the residue charge that limits the speed of a BB shift register because the error margin becomes worse at higher transfer rates. And since it is cumulative, it also limits the number of cascaded stages, and hence, too, the register's size and bit handling capacity.

### An inconvenience

Apparently, however, the curves given in Fig. (a) of the error discussion on page 68 suggest that at low clock rates it should be possible to cascade a large number of stages. This certainly is true in the digital case—but things are not as convenient in the analog world. Because charge feedback occurs from drain to source in the MOS device, or from collector to emitter in the bipolar device, the reference level for a new sample in each storage stage is affected by the charge level of the next storage stage. This condition causes interference between successive signal samples, and gives a signal step response error similar to the dynamic error at high clock rates described above.

The drain-source feedback of the MOS transistor is heavily dependent on oxide thickness, channel length and substrate resistivity. Figure 6, which presents measurements on a number of BB devices of various geometries and substrate resistivities, shows that with the basic circuit, at intermediate channel lengths, it is not possible to obtain charge feedback of better than 0.001 per stage, representing an error of 0.1%. As a result, only a few hundred such stages can be cascaded in analog applications.

In the bipolar bucket brigade, the feedback due to the Early effect between collector and emitter is generally low—on the order of  $5 \times 10^{-4}$  per stage. But in the

## SPECIAL REPORT

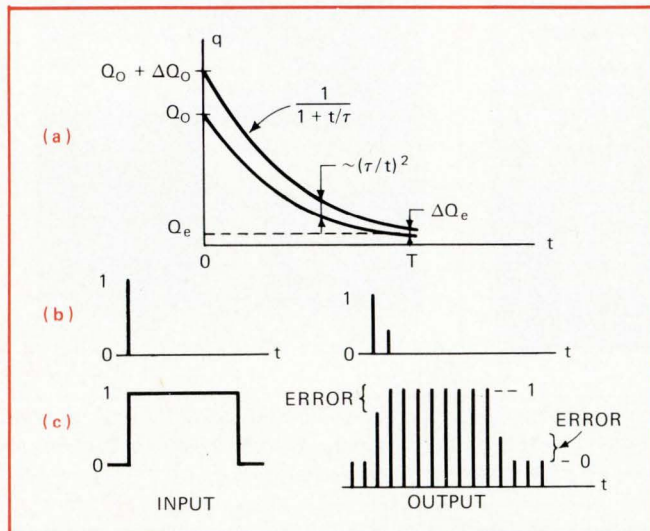

**4. Trouble ahead.** In the transfer process, some charge remains behind after transfer. The constant component of charge residue ( $Q_e$ ) is not harmful, but the rest is signal-dependent. This results in signals that have spurious pulses of the type shown in (b), or which lead to a spreading of the pulse of the type shown in (c). This smearing attenuates higher signal frequencies and limits the device speed.

bipolar case, another interference between signal samples takes place, due to the parasitic capacitance between the collector and emitter of each transistor. This error contribution can be minimized by narrowing the aluminum interconnections locally between stages, which reduces the parasitic capacitance between stages and minimizes the ratio of parasitic capacitance to storage capacitance. In practice, with a storage capacitance typically of 2 pF, the total interference (both from feedback capacitance and from Early effect) can be on the order of 0.001 or better, permitting several hundred stages to be cascaded in the bipolar case, just as with MOS.

The problem is that some applications call for delay lines consisting of thousands of stages in cascade. For such applications an improved bucket brigade version has been developed, which has two transistors per storage capacitor arranged in a cascade or tetrode configuration, as shown in Fig. 7 (a).

Feedback in the uppermost to the midpoint of the tetrode structure results ultimately in a smaller residue in the preceding storage capacitance. In theory, the feedback could be reduced to  $h^2$ , where  $h$  represents the feedback per transistor. But in an IC realization, this value is not achieved because, during each transfer, charge is left behind in the parasitic capacitance  $C_p$ , and added to the next sample. The feedback of the tetrode therefore is reduced from that of the basic circuit by a factor of  $C_p/C$ .

The photograph in Fig. 3 (b) shows a bucket brigade formed from cascaded tetrode stages, with  $C = 3$  pF. The ratio of  $C_p/C$  is of the order of 0.05, so that a feedback less than  $10^{-4}$  per stage is achieved. Figure 7 (c) gives the signal step response of the tetrode chain, which is seen to be nearly free of distortion.

One drawback of the tetrode configuration, however, is its inherent slowness, as compared with the basic circuit. To obtain low values of  $C_p/C$ , the ratio between gate capacitance and storage capacitance has to be low. This means that the gate electrode must be large in relation to the source and drain electrodes, and this results in large cell lengths and long transfer times. The time constant of the tetrode stage of Fig. 3 (b) is roughly ten times that of the basic circuit—or a maximum clockrate of about 50 kHz. This limits the usefulness of the tetrode concept to audio applications.

Another important parameter affecting applications is dynamic range—the ratio between maximum undistorted signal amplitude and full-band rms noise. For most audio applications a S/N ratio of at least 60 dB is necessary. For video, 40 dB is sufficient.

Calculated and measured values of S/N on laboratory models of both bipolar and MOS bucket brigade devices (see Fig. 8) indicate that the ratio falls well within the dynamic range requirements of audio and video delay lines.

### Applications

The bucket brigade can serve the needs of a variety of audio delay line applications. For example, many recirculating transmission lines, with this delay and bandwidth requirement, can readily be built with a tetrode bucket brigade array of fewer than 100 elements. These circuits could be used in artificial reverberation systems, or as delay equalization circuits in speech transmission systems, enabling audio system designers to perform these analog functions with simple IC techniques.

Delay equalization is especially important in radio telephone systems, such as the Lincompex (Linked Compander and Expander) system. Here it's necessary to equalize the delay, after filtering, of a pilot signal with respect to the speech signal. In this system, the need is for a 20-ms delay at a 4-kHz bandwidth. In public address systems, the varying delays of speech signals reproduced by several loudspeakers must also be equalized to improve intelligibility. Here, very long delays of several hundred milliseconds are required.

Speech scrambling is another job for which the BB tetrode is suited. One application could be in mobile police transceivers, to make the transmitted speech signal unintelligible to clandestine listeners. In one voice

**5. A sad tail.** Typical discharge curves show that three transfers of different quantities of charge approach a common discharge curve, independent of the starting point. The charge residue at the end of the transfer period represents the reference level for the next transfer and is cumulative, since it occurs in each stage.

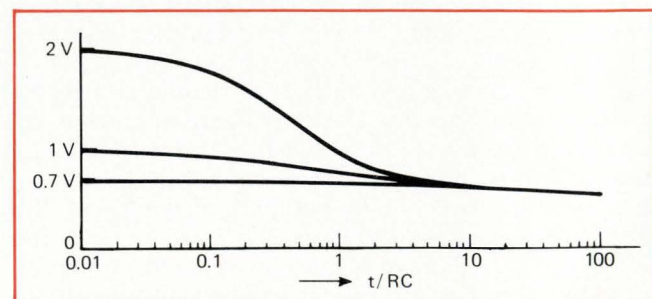

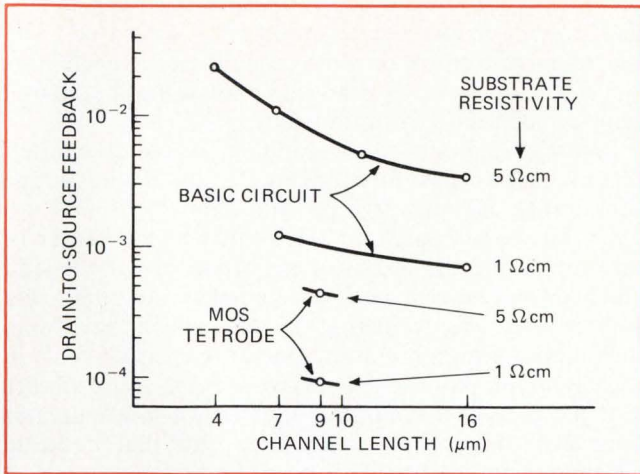

**6. Getting feedback.** Experiment on an MOS BB transistor shows that, for a given oxide thickness and substrate resistivity, the drain-to-source feedback depends on the channel length. In the basic BB circuit this feedback sets a limit of a few hundred to the number of stages that can be cascaded. The MOS tetrode circuit, however, has less feedback, can be successfully cascaded in lines of several hundred and more, but is limited by a larger time constant to a clock rate of 50 kHz and to audio applications only.

scrambling system several successive speech fragments are time-scrambled in a pseudorandom way with the aid of a tapped delay line. The receiver contains the scrambling key, so that the speech is reconstructed with a similarly programmed, tapped delay line. Delays of approximately 350 ms are required, well within the tetrode capability.

For video applications, however, faster circuits with greater bandwidths are required. The basic bucket brigade circuit could be used in the European PAL color television system, for instance, which currently corrects color faults with a glass ultrasonic delay line of 64 microseconds. Two BB delay lines, each providing 64- $\mu\text{s}$  time delay and 1-megahertz bandwidth, could be an IC to replace the ultrasonic delay line.

Bucket brigade techniques are also useful for time-scale conversion. With BB shift procedures it is possible to write a signal in the delay line at a certain clock rate,

**7. Improved.** The tetrode version of the bucket brigade has two transistors per storage site, arranged in a cascade configuration. This version reduces the feedback: it is  $C_p/C$  lower than the feedback of the basic circuit, where  $C_p$  is parasitic capacitance. Indeed, with the tetrode configuration, feedback as low as  $10^{-4}$  per stage can be achieved on a 1-cm substrate (see Fig. 6). Also known is the tetrode's equivalent circuit and signal step response for a tetrode chain, which is seen as closely approximating the ideal.

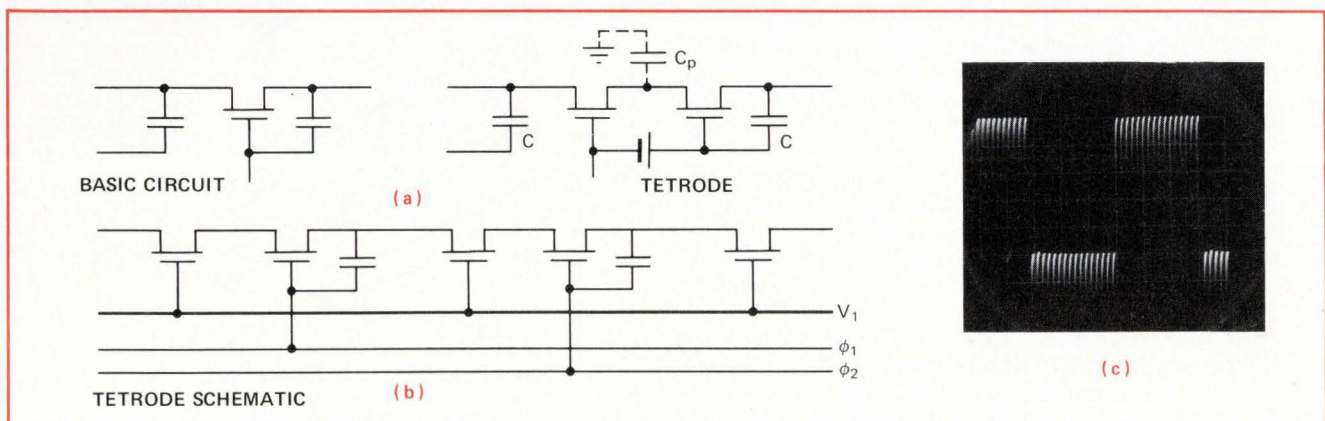

and then to read it out at a different rate.

This scheme would work in time-compression multiplex systems for telephony. Parts of the speech signals could be stored in a delay line at a low clockrate, say, 10 kHz, and then read out at a much higher rate, perhaps 1 MHz. A signal fragment of about 5 ms could be compressed into 50  $\mu\text{s}$ . Several channels could be read out sequentially in this way, resulting in one broadband multiplex signal that could be transmitted over one cable or wireless communication channel. At the receiver side, the signal would be demultiplexed similarly to derive the separate voice channels.

### Image sensors

One of the most important and immediate BB applications is in imaging. Exposing a BB array to a light image imposes a charge pattern on it (see the following article for details of the imaging application). Electrons and holes are generated in the depletion regions of source and drain, and cause a net current flow from the substrate to the negatively charged p-areas. These then discharge the storage capacitors as a function of the local light intensity. The charge pattern established in the mosaic can then be read out line by line by applying a sequence of shift pulses. The result is in an output signal like a TV vidicon's.

A mosaic with the same resolution as the TV vidicon should contain  $625 \times 625$  sense elements, or 625 lines of 1,250 buckets each. Such an array would have to cover a chip area of 250 to 1,000  $\text{mm}^2$ , however, and this is rather beyond the capacities of today's photolithographic techniques. Still,  $100 \times 100$ -element arrays are within available capabilities, and could fill many character recognition and facsimile functions.

Variable delay is another BB function with important applications in systems where time-error correction is required. For instance, in recording systems the signal may be affected by fluctuations in recording and playback speed. Here the time error could be detected by comparing a recorded pilot signal with the playback speed and equalizing the two by varying the clock frequency of a BB delay line appropriately. In helical-scan color TV recorders, timing errors can be of the order of a

# SPECIAL REPORT

few microseconds at 5-MHz bandwidth. An experimental setup incorporating two bipolar integrated BBs with 72 stages each has shown the feasibility of BBs for this application.

The BB concept can also be used to implement inductorless filters. The transversal filter is such a device. Here the filter characteristic is simulated by means of an impulse response in the time domain, using the technique known as weighting. (A transversal filter basically consists of a delay line with equally spaced taps. To get a specific filter characteristic, the signal sample at each tap is multiplied by a weighting factor and the weighted samples summed to obtain the filter output signal.)

A simple capacitive weighted method has been developed for BB devices. When a signal sample is transferred from one capacitor to the next, a quantity of charge equal to the value of the sample flows from one clock line to the other through the two bucket stages involved. Thus, in the two clock lines, the sum of all sam-

ples present in the delay line can be measured. The weighting factors are introduced by dividing each storage capacitor into two parts and measuring the charge transferred in the appropriate part.

Figure 9 shows a photograph of a MOS integrated phase-linear lowpass filter having 23 taps. Total storage capacitance per stage is 3 pF, and chip size is  $1 \times 1.6$  mm<sup>2</sup>. The MOS transistors are located in the center of the chip, while the MOS storage capacitors of the odd and even stages are located on the lower and upper side respectively. The weighting factors, which determine the unit pulse response of the filter, are clearly visible in the aluminum pattern. Advantages of this approach are that the area of a complete filter is not much greater than that of a simple delay line, and that accurate weighting within 1% to 2% is possible.

## Binary shift registers

Finally, BBs have great promise in binary shift registers. Because high S/N ratios are not necessary in binary applications, the digital BB storage cell can be small—say, 1 mil<sup>2</sup> per storage site. Also, unlike the

## Cutting your losses

An unfortunate fact of life with charge transfer devices is that transfers are not 100% efficient: a quantity of charge is lost in each transfer step—that is, left behind under the electrode. The problem is that this charge accumulates with subsequent transfers, and before long, shows up as a spurious signal (a logic 1 where there should be a logic 0), or as an unwanted increase in the magnitude of signal. For an imaging application, these distortions are disastrous, as the gray scale of the image depends on the circuit's capacity to maintain each signal's integrity.

Already the first experiments with bucket brigade devices have shown a way out of this dilemma: the error can be minimized by adding a bias charge to the signal. Clearly, a quantity of charge remains permanently in the register, only a portion of the charge will be transferred at each stage. This bias minimizes the time for transfer, which in turn minimizes the quantity of charge that stays behind.

The quadratic dependence of step-response error on time is shown by Fig. (a), in which the error is calculated for a MOS BB and for a three-phase charge-coupled device. This dependence on transfer time means that the step-response error (SRE) is proportional to the second power of the clock frequency  $f_{c1}$ . After  $m$  stages, the SRE is  $m\tau^2 f_{c1}^2$ . Thus, at a given maximum tolerable value of the SRE (e.g. 25%), the number of bits, or samples  $n$  in series ( $2n$  buckets or  $3n$  CCD stages), will be inversely proportional to the second power of the clock frequency.

Figure (b) gives a comparison for all CTD devices of maximum clock frequency versus  $n$  at a SRE of 25%. Curve 2 in the figure represents the optimum for a standard p-MOS BB device, and curve 1 does the same for a three-phase CCD with comparable cell size. Curve 3 is for an n-channel device that has recently been processed with LOCOS, a local oxide isolation process developed by Philips. Curves 4, 5, and 6 are for recently announced three-phase, four-phase and silicon gate CCDs and BBDs. The conclusion is simply this: devices with similar geometry and type of charge carrier result in roughly equal maximum speed for both BBDs and CCDs.

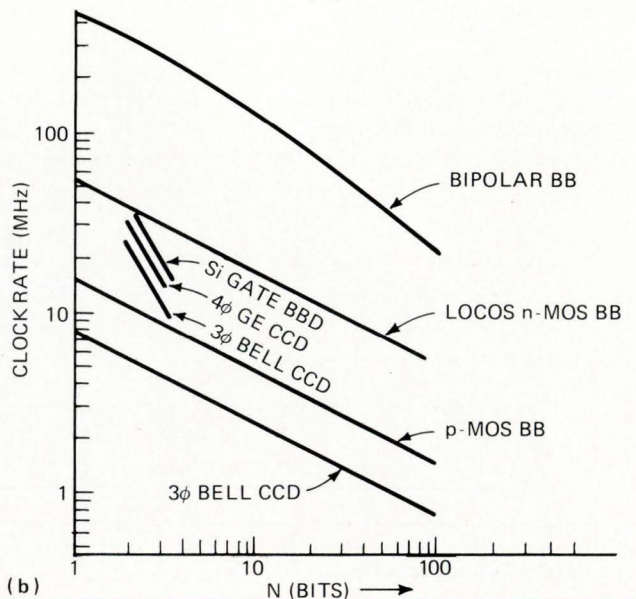
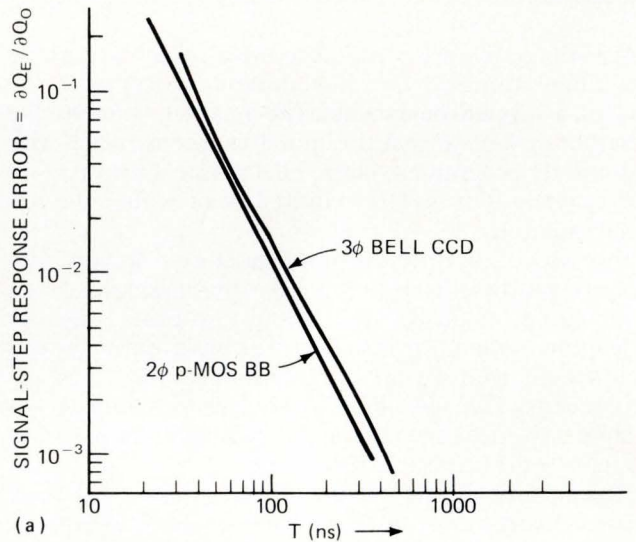

analog case, the number of cascaded stages in digital circuits is not limited by a cumulative signal step response error, because it is possible to insert signal regenerators after each row of 30 to 100 stages, to recover the correct binary levels.

Figure 10 illustrates two benefits of a BB binary shift register: high bit density, and low power dissipation. With standard p-MOS BB technology, densities of the order of 500 bits/mm<sup>2</sup> (exclusive of regenerators) can be obtained. This could be further increased by a factor of

three if modified silicon gate processing were used. Also, power dissipation as low as 5 μW/bit is possible.

The lowest power dissipation figures are obtained with a multiplex configuration. The signal, with bit rate  $f$ , is multiplexed into  $f/N^{1/2}$  parallel rows, giving each row a bit rate of  $f/N^{1/2}$ . This design has two advantages over a conventional signal shift register: the reduction of the clock rate in the internal BB matrix reduces the total power dissipation significantly; and each sample passes through only  $2f/N^{1/2}$  stages (or fewer than 100 for instance, if  $N = 2,048$  bits), so that only one signal regenerator is necessary at the output of the device.

BUCKET BRIGADE PERFORMANCE		
	MOS	Bipolar
Max signal (rms)	1 V	300 mV
Full band noise voltage (rms)	$\sqrt{\frac{8kT}{3C}} N$	$\sqrt{\frac{V_{dc}q}{\beta C}} N$
	C = capacitance value, pF N = number of samples $\beta$ = transistor current gain V <sub>dc</sub> = average transfer voltage (1 V)	
S/N ratio (dynamic range)	$10^4 \sqrt{C/N}$	$10^3 (1 - N/\beta) \sqrt{\beta C/N}$
Example	Audio delay line 5 kHz, 30 mS C = 3 pF N = 300 samples S/N = 10 <sup>3</sup> (60 db)	Video delay 5 MHz, 7 μS C = 2 pF N = 70 samples S/N = 10 <sup>3</sup> (60 db)
Harmonic distortion	< 0.5 %	~ 1 %

### Delay lines

One immediate use of binary shift registers is in analog delay lines. Such functions can be realized by a digital shift register with a-d and d-a converters at the input and output terminals. Typically 10 bits per sample are required at a S/N ratio of 60 dB. Thus the MOS tetrode of Fig. 4 is equivalent to a 5,000-bit binary shift register plus a-d and d-a converters on one chip.

Clearly, the digital approach is preferable in those circuits where long delay chains are required, like those used in high-fidelity audio reverberation and speech scrambling. The analog approach is cheaper where only a few hundred stages or less are required, as in color TV delay lines, timing error correction for video recorders,

**8. Clearly undistorted.** Both MOS and bipolar bucket brigade structures shown in the above picture provide adequate signal-to-noise ratios for many applications. MOS audio delay line and bipolar video delay line each have S/N of 10<sup>3</sup> (60 dB).

**9. It filters too.** Bucket brigade devices make good filters—the one below is a phase-linear lowpass filter having 23 taps. Chip measures only 1 by 1.6 mm<sup>2</sup>, which makes it hardly any larger than a simple delay line

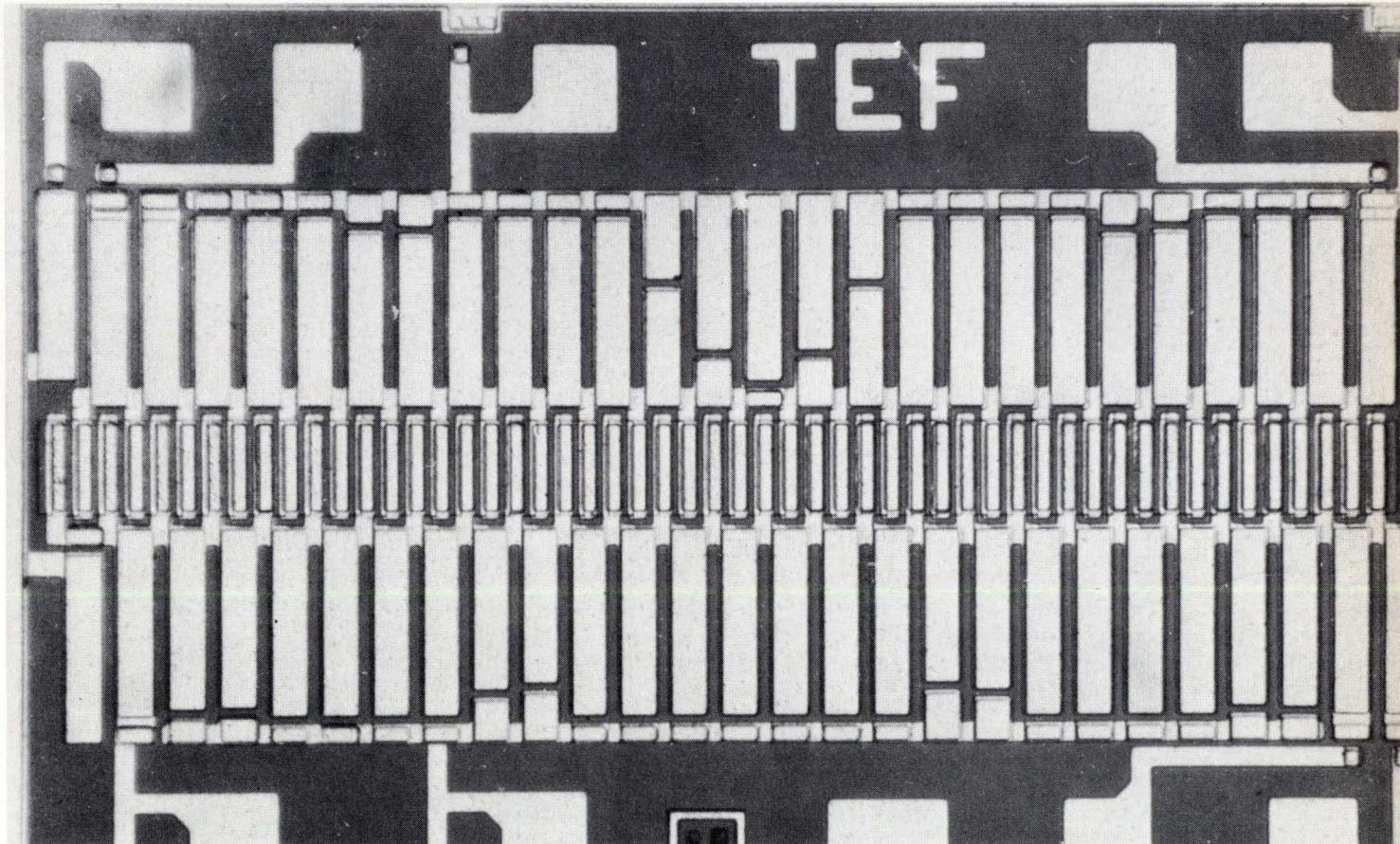

# SPECIAL REPORT

## BUCKET BRIGADE SHIFT REGISTER

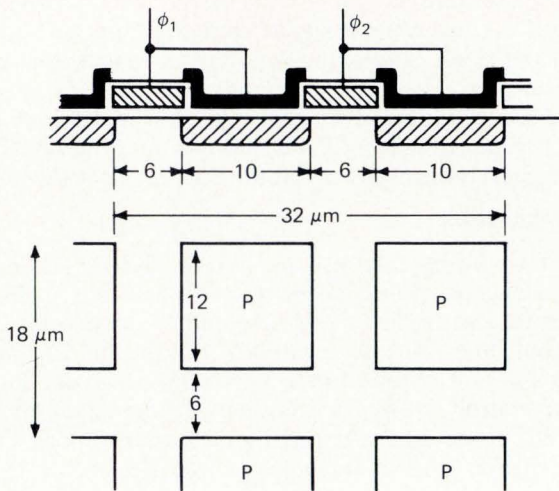

Si-GATE (MINIMUM AREA ELEMENT)

AREA PER BIT =  
 $18 \times 32 \mu\text{m} (1 \text{ MIL}^2)$

BIT DENSITY =  
 $1600 \text{ BITS} / \text{mm}^2 (10^6 \text{ BITS} / \text{INCH}^2)$

BIT ELEMENT

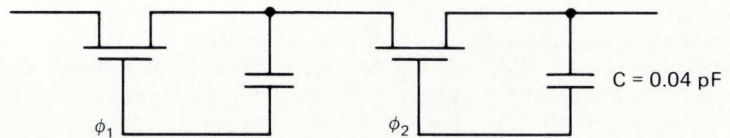

POWER DISSIPATION

$C = 0.04 \text{ pF}$   
 $V = 5 \text{ V}$   
 $f = 5 \text{ MHz}$   
 $P_0 = CV^2f = 5 \mu\text{W}$

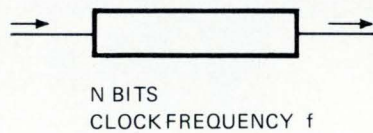

SERIAL BBD  
 $P = N \cdot P_0$

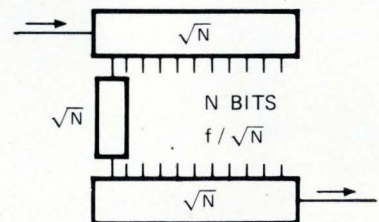

MULTIPLEX BBD  
 $P = 3\sqrt{N} \cdot P_0$

N	10,000 BITS
ACTIVE CHIP AREA	6 mm <sup>2</sup>
f <sub>MAX</sub>	5 MHz
ACCESS TIME	2 ms
POWER DISSIPATION (MULTIPLEX)	1.5 mW
COST PER BIT	0.1 ¢ PER BIT \$10 PER CHIP

**10. Small but charged.** Silicon gate structures offer the best chance for minimizing element area. With standard photolithographic rules, area per bit is about 1. mil<sup>2</sup>. Multiplex BBD has lowest power: 1.5 mW per bit at 5 MHz clock rates. In spite of small size and low power dissipation, BBDs can have bit densities of about a million bits per square inch.



TABLE: COMPARISON OF MEMORY TYPES

	MOS RAM	BBD <sub>II</sub>	BBD <sub>I</sub>	DISK (IBM)
N (BITS)	10 <sup>4</sup>	100 x 100 PARALLEL	MULTIPLEX 10 <sup>4</sup>	10 <sup>10</sup>
COST / BIT	0.1 ¢	0.1 ¢	0.1 ¢	0.001 ¢
BIT DENSITY	← ± 1600 BITS/mm <sup>2</sup> →			—
ACCESS TIME	200 ns	10 μs	2 ms	30 ms
DISSIPATION	2NP <sub>O</sub> = 100 mW	NP <sub>O</sub> = 50 mW	3√N P <sub>O</sub> = 1.5 mW	—

short audio delay lines, and image sensors.

It has been suggested that the BB device could eventually also play a role in computer memories, acting as a buffer between random access memory and disk stores. To investigate this possibility, it is instructive to compare two versions of the BB with the newest MOS RAM (the one transistor-per-bit storage cell), and with a disk memory. The figures for the disk memory represent access times now offered commercially.

From the comparison it can be seen that the BB because it uses the multiplex concept to access and transfer information, has too slow an access time—2 ms—to be generally useful in most computer applications. And this is in spite of the attractively low, 1.5-mW power dissipation. On the other hand the parallel device, shown as BB, with its 10μs access time and 50-mW power dissipation, could compete favorably with the RAM as a buffer memory. Whether it will actually replace the RAM in

large computer systems depends on overall system considerations, and these are still not clear. In any case, the future of the binary BB is indeed rosy for serial-access storage applications, where it should certainly replace the conventional MOS shift registers. □

**Bibliography**

- K. Schliesinger, Electron tube circuit, U.S. patent 2,403,955, filed 11 May 1943, granted 16 July 1946.
- F.L.J. Sangster and K. Teer, "Bucket Brigade Electronics—New Possibilities for Delay, Time-Axis Conversion and Scanning," IEEE J. Solid-State Circuits SC-4, June 1969, pp. 131-136.
- W.S. Boyle and G.E. Smith, "Charge-coupled Semiconductor Devices," B.S.T.J. 12, April 1970, pp. 587-593.
- P.K. Weimer, "Systems and Technologies for Solid State Image Sensors," RCA Review 32, June 1971, pp. 251-262.
- L. Altman, "The new concept for memory and imaging: charge coupling," Electronics, June 21, 1971, pp. 50-59.
- W.E. Engeler, J.J. Tiemann and R.D. Baertsch, "A Memory System Based on Surface-charge Transport," IEEE J. Solid State Circuits SC-6, Oct. 1971, pp. 306-313.
- W.F. Kosonocky and J.E. Carnes, "Charge-coupled Digital Circuits," IEEE J. Solid State Circuits, SC-6, Oct. 1971, pp. 314-326.
- L. Boonstra and F.L.J. Sangster, "Progress on Bucket Brigade Charge Transfer Devices," presented at the I.S.S.C.C. 1972.

**Go anywhere, do anything—almost**

Charge transport devices are the hottest items under development in semiconductors today—a fact that's underscored by the ISSCC held in Philadelphia this month, which devoted two technical sessions and an entire evening seminar to expounding the virtues of this new technology. The reason for the excitement? In one word: cost. The consensus at the ISSCC was that charge transport devices will ultimately have a five-to-one cost advantage over existing MOS memory devices.

The sharp difference results from two fabrication simplifications: fewer digdowns (holes through the substrate), and smaller storage sites. Thus higher-yield devices with more memory per chip can be expected—10,000 bits of memory for \$10 should be attainable.

Aside from cost, what makes charge transport technology so formidable is its versatility. Basically dynamic

shift registers, CTDs can be used wherever a serially accessed memory is used—as drum or disk type memories, delay line memories, CRT refresh memories, buffer memories, sequential-access memories, fast-access scratchpad memories, and so on.

But memory is still not the whole charge transport story: the devices also have an optical side and will quickly find their way into linear and area image camera systems, as replacements for silicon diode target tubes or as scanners for facsimile equipment. Significantly, charge transport image devices probably are closer to realization than memory devices. For example, RCA has under construction a charge transport camera for Wright Patterson (see cover), and Bell Laboratories has developed linear and area imagers for possible use in Picture-phones.

—Laurence Altman

## Solid state imaging emerges from charge transport

Small, experimental bucket brigade array has higher sensitivity and gets less interference from switching transients than X-Y addressing

M.G. Kovac, W.S. Pike, F.V. Shallcross and P.K. Weimer,  
RCA Laboratories, Princeton, N.J.

□ One of the major uses of charge transfer technology will be in solid state image sensors, which will provide better sensitivity and less interference from switching transients than earlier X-Y-addressed solid state sensors. Results obtained from 32-by-44-element bucket brigade sensor array, built on a single chip, have been so encouraging that a complete television camera that uses this sensor now is being built for the Air Force.

The key difference between charge transfer sensors and X-Y addressed sensors is that the former can be made to scan internally: charges are transferred bodily from element to element to the edge of the array<sup>1</sup> for sequencing into an output amplifier. In fact, no X-Y coordinate strips or external multipliers are required to generate the video signal. There may still be applications, however, where the higher signal levels of high-gain phototransistors or photoconductors are needed in an X-Y array, and charge transfer circuits can also be useful there as a means of scanning.

### Two methods available

Self-scanned sensor arrays can be built with either of the two methods of charge transfer available—the bucket brigade circuit, first proposed by the Semiconductor division of Philips Gloeilampenfabrieken,<sup>2,3</sup> and the charge-coupled circuit, first reported by workers at Bell Telephone Laboratories.<sup>4,5</sup> Both have sufficiently low transfer-loss characteristics to be promising for such arrays.

The two methods are quite similar in construction (Fig. 1), but the bucket brigade structure's additional diffused islands allow easier coupling to scan generators and input and output circuits (the diffused islands, however, may limit the ultimate packing density). For use in peripheral circuit functions—such as scan generators—the somewhat larger transfer loss in the bucket brigade register can be tolerated when relatively few stages are required.

The maximum number of picture elements for an internally scanned charge transfer sensor is determined by transfer losses at the scanning frequency. Transfer losses of about 0.02% per stage at 1 megahertz<sup>6</sup> have been observed in long single-line three-phase charge-coupled registers. With a loss per stage equal to the best reported<sup>7</sup> for a bucket brigade register (0.07% at 1 MHz, 0.3% at 5 MHz), the maximum array size now feasible is about 150 by 150 elements, scanned at 30 frames per

second. Losses will have to be reduced still further to make practical the 500-by-500-element sensor required for a useful television camera.

The 32-by-44-element array<sup>8</sup> is an extension of a 15-by-16-element array developed at RCA about two years ago.<sup>1</sup> Each of the 32 rows of the sensor array consists of a 44-element bucket brigade register in which the reverse-biased sources and drains of the metal-oxide semiconductor transistors act as photodiodes when illuminated. A single chip holds the vertical scan generator, transmission gates, sensor array, output shift register, and output amplifier.

The system is shown in block diagram form in Fig. 2, and a photo of the chip, which measures 200 mils by 200 mils, is also shown in Fig. 2. The devices were fabricated with p-channel MOS metal-gate technology. Individual picture elements of the sensor array are spaced on 3-mil centers.

A display obtained with the sensor array was tested by projecting an image from a photographic slide onto the metallized side of the chip. Sensitivity was excellent, even though the opaque electrode structure covered about 50% of the silicon in the image area. However, sensitivity could be improved further in future arrays by using transparent electrodes or by thinning the silicon and illuminating the array from the reverse side, as in the silicon vidicon target tube.<sup>9</sup>

With a horizontal clock rate of about 200 kHz and a vertical clock rate of about 1 kHz (for 60 frames per second), excellent signal-to-noise ratios were obtained with several foot candles of illumination on the sensor. Incandescent illumination was used, but it was filtered to

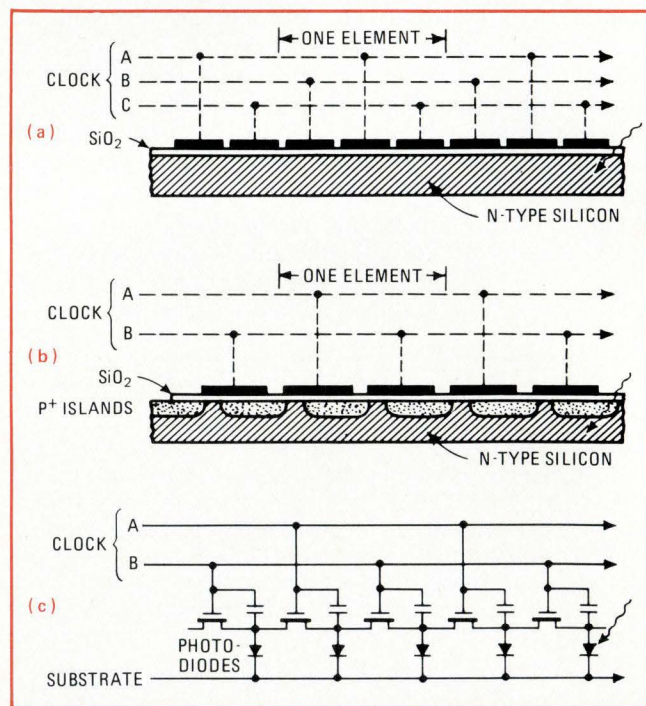

**1. Charge movers.** Two basic charge transfer structures are the three-phase charge-coupled device (a) and the two-phase bucket brigade (b). Note p+ islands in bucket brigade, which allow easy connection to elements. Circuit equivalent for bucket brigade (c) shows photodiodes, which generate charge that is transferred along row in the sensor.

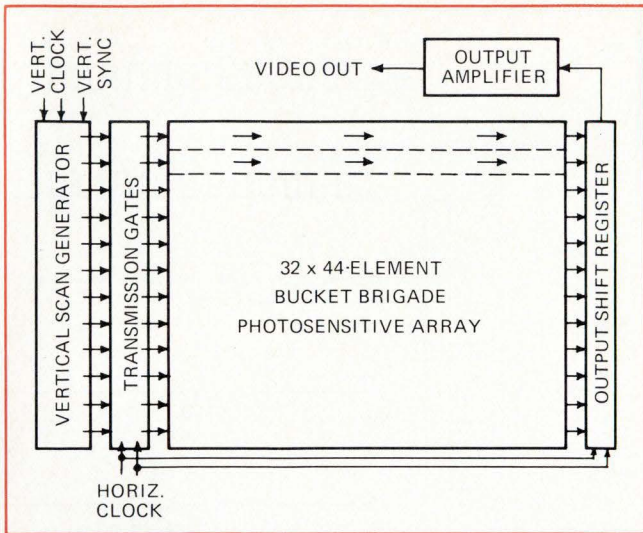

**2. Sensor building blocks.** Charges stored in the photodiodes of 32-by-44 element array are transferred to the output register when the vertical scan generator turns on transmission gate for row to be scanned. The horizontal clock first pulses, then steps the charges to output, where they are transferred to output amplifier. All circuits shown are on a single p-MOS metal-gate chip measuring 140 by 190 square mils. On the chip, the output register is at the right, the vertical scan generator at the left.

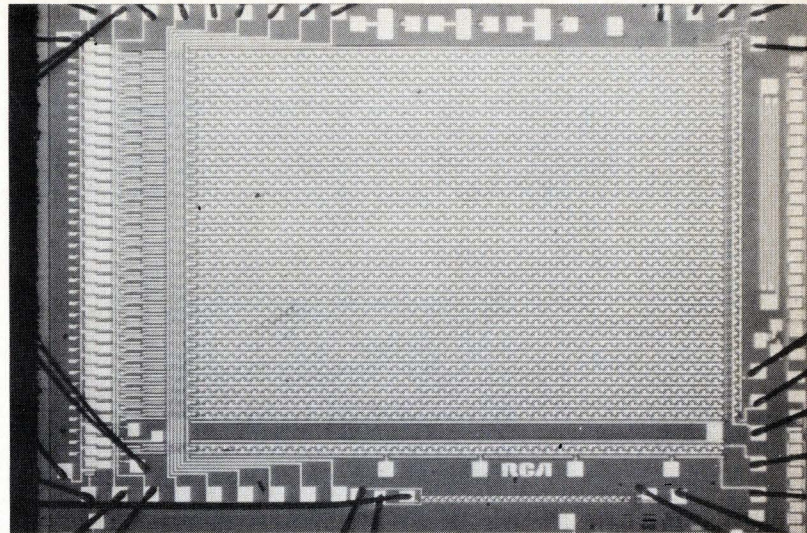

remove the infrared component. Without the filter, the sensor's strong response to infrared would not have resulted in a true test of its response to visible wavelengths.

Transfer efficiencies along the sensor rows were better than 99.7%, a performance that is apparent from the signal uniformity attained over the entire area of the sensor. One problem occurred, however: some photodiodes had higher dark current than was desirable.

Bright spots similar to those observed in silicon-target vidicon tubes occurred. However, in the charge transfer array, the charges move along the row, and thus the bright spots tend to spread out along the direction of transfer as the increased charge created by the local high dark currents is propagated along the line.

In the array, the vertical scan generator, a bucket brigade circuit, controls the transmission gates, which apply the horizontal clocks to one row at a time. At 60 frames per second, each row has a 1/60-second period between scans.

### Gates disconnect clocks

During this period, the horizontal clocks are disconnected by the transmission gates, and a charge pattern corresponding to the image builds up on the photodiodes. When a given line is to be scanned, the horizontal clock is reconnected, and the large pattern is transferred across the row toward the continuously running output shift register—a bucket brigade that delivers the charges in order to the output amplifier.

As shown in Fig. 3, the charge is transferred in serpentine fashion along the row. This geometry allows a maximum source-drain spacing to be achieved in each MOS transistor for a given cell size, which results in increased transfer efficiency.

The vertical scan generator, which requires only one transistor and one capacitor per stage (Fig. 4), is driven by symmetrical square-wave clocks. When the negative pulse  $V_{in}$  is introduced into the first stage of the register, it propagates through the register, appearing at success-

ive nodes with the proper polarity for driving the transmission gates.

During the 1/60-second interval between scans of a particular row, the horizontal clock lines are held at a positive potential to bias off all transistors in a row. If interlaced scanning were required, the vertical clock waveform could be adjusted to turn on alternate rows, passing through intermediate stages while the horizontal clock is turned off.

### Register synchronized

The output register (Fig. 5) is driven continuously in synchronism with the horizontal clock, and the sequence of charge packets from each row is transferred up the register to the output amplifier. The contents of more than one line may be in the output register at the same time—while one line is starting up the register, the previous line may be only one stage ahead of it, assuming no delay for horizontal flyback.

The output register thus adds one additional clock cycle of delay per line to the video signals. Although an interval will generally be desired between lines to account for retrace time on the television monitor, the extra cycle added by the register will probably not correspond to the retrace time. The extra cycle can be eliminated by advancing the vertical scanning pulse to the transmission gates as it moves down the scan generator register. This is accomplished by increasing slightly the frequency of the vertical register.

The output amplifier delivers a voltage-sampled representation of the video signal. Voltage sampling is preferable to current sampling here because the voltage remains constant during each half-cycle of the clock. If a current-sampled output were used, a series of current spikes would result that are coincident with spikes feeding through from the horizontal clocks, and separating the two would be difficult.

Although the video signal current from the output register in the 32-by-44-element array has not been measured directly, its approximate value can be com-

# SPECIAL REPORT

puted by multiplying the elemental charge by the horizontal clock frequency. With the capacitance of each bucket taken as 0.3 picofarad and with a 1-volt swing, the elemental charge is 0.3 picocoulomb, and the video signal current thus is 0.03 microamperes for the 100 kHz

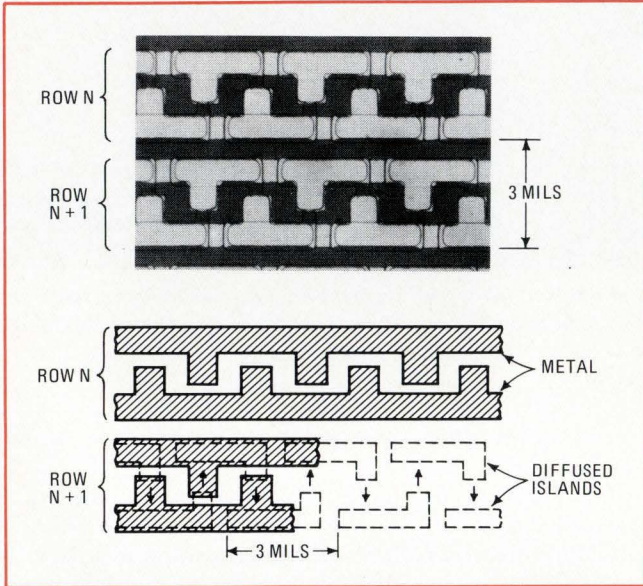

**3. Close-up.** Stages of this photosensitive array are interconnected with metal in an interdigitated format. Charges move across chip in serpentine fashion as shown in drawing (b.)

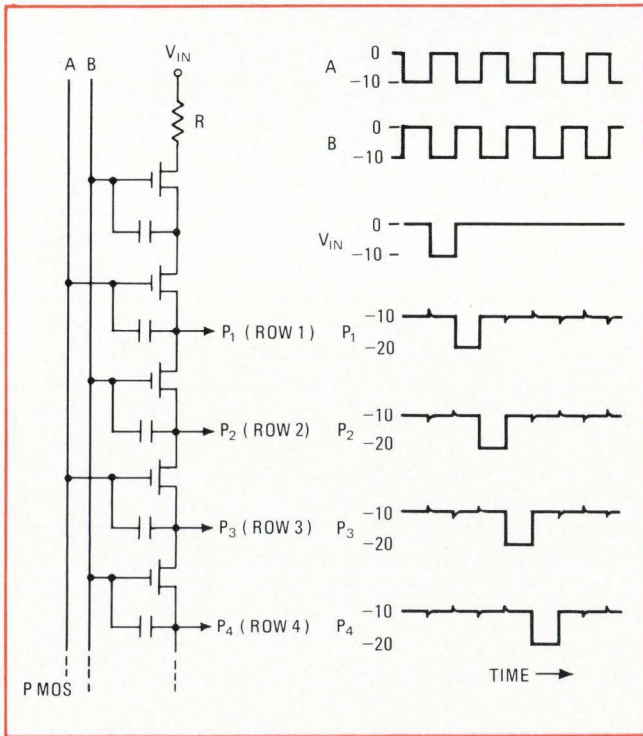

**4. One at a time.** Bucket brigade vertical scan generator, driven by two-phase vertical clock A-B, delivers sync pulse  $V_{in}$  to each of 32 rows  $P_1, P_2,$  etc., in succession. Pulses turn on the transmission gates in that row, allowing horizontal clocks to transfer charges to the output register.

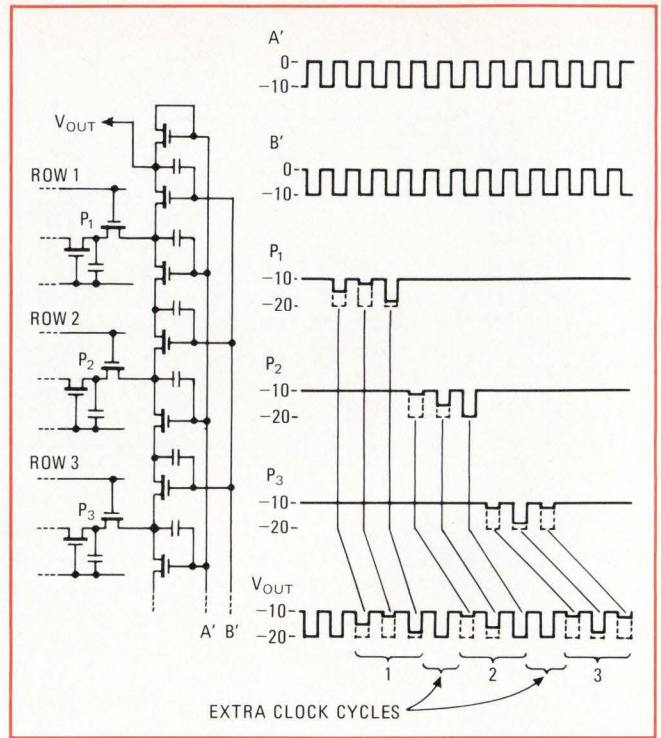

**5. End of the line.** Bucket brigade output register, driven by horizontal clocks A'-B', takes charges from rows and passes them to output for amplification. Charges from one row are one clock cycle ahead of charges from next row as they advance up the output register. This extra cycle could be removed by delaying the vertical scan pulses that are applied to transmission gates.

horizontal clock. However, an elemental charge packet as small as 0.002 pC could yield a video signal with a signal-to-noise ratio of 100, provided that the output amplifier noise contribution could be neglected.<sup>10</sup>

Even with voltage sampling of the video signal, the output is still embedded in the clock voltage waveform, giving the output signal a serrated appearance and a resultant poorer sensitivity and s/n ratio. A video signal maintained at a constant level throughout each clock cycle would be better.

### Circuit illustrated

One circuit for performing the separation is shown in Fig. 6. Points  $P_n$  and  $P_{n-1}$  represent successive nodes in the output register; the voltages at these points are added, and the clock pulses thus are suppressed. The circuit was operated separately with the 32-by-44-element array, but could be integrated readily on the same chip. Note that the circuit could also be used as a general-purpose sample-and-hold circuit when input pulses are repetitive and extremely short.

When the circuit of Fig. 6 was used to separate clock signals from the video output, the transmission of half-tone pictures was improved greatly. However, even without the extra circuit, the system's freedom from low-frequency clock components permits acceptable picture uniformity. Any pickup of clock signals can be removed by a low-pass filter, since the basic clock frequency is twice that of the video pass band. Low-pass filters are not as effective with conventional X-Y addressed sensors, which have pickup of clock voltages

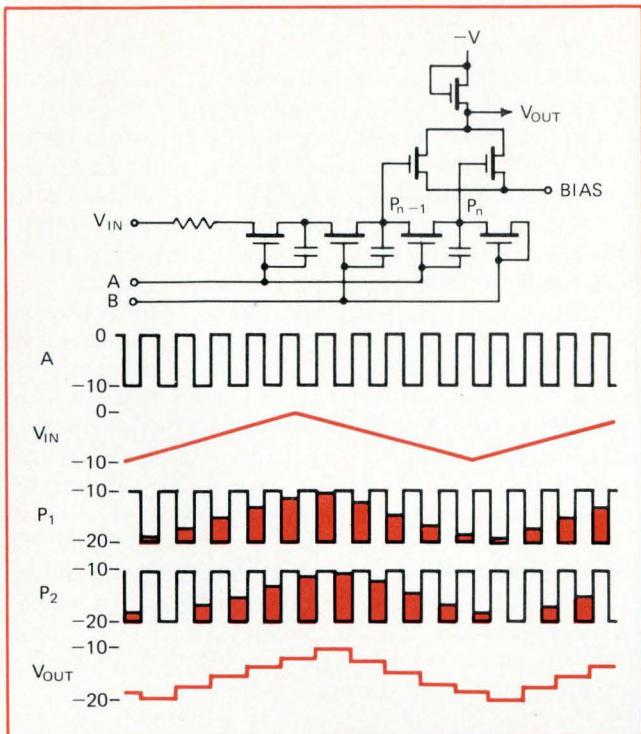

**6. Clock suppressor.** Signal from output register, buried in clock waveform, can be separated from clock by adding signals at two successive nodes,  $P_n$  and  $P_{n-1}$ , and with paralleled output transistors. Waveforms shown demonstrate use of circuit for a sample-and-hold function with input  $V_{in}$ .

with low-frequency components in the video pass band.

There are two systems for scanning charge transfer sensor arrays; each is shown in block-diagram form in Fig. 7. The horizontal transfer, line-by-line system (which was used in the RCA 32-by-44-element bucket-brigade sensor), and the vertical transfer system with a separate store, which has been proposed for charge-coupled sensors.<sup>11</sup>

### Systems compared

Either scanning system can be used with either method of charge transfer; thus, no distinction need be made between the two methods of transfer. Both scanning systems and both transfer methods can provide essentially the same over-all performance if transfer losses can be kept sufficiently low. However, there are differences between the two scanning methods that would affect the choice between them for a particular high-resolution sensor. The following points must be considered (although it must be noted that additional factors may yet arise that will be of equal importance):

- Chip area can be smaller with a horizontal transfer system, since it doesn't require the separate store of the vertical system. The separate store can be as large in area as the sensor itself. Although the horizontal system does require a vertical scan generator and transmission gates, these constitute a small fraction of the space required for the store.

- Fewer total transfers are required for the horizontal system, since additional transfers through the store are avoided. However, this gain in charge delivered to the output is somewhat offset by the improved transfer efficiency in the vertical system because of the lower transfer frequency.

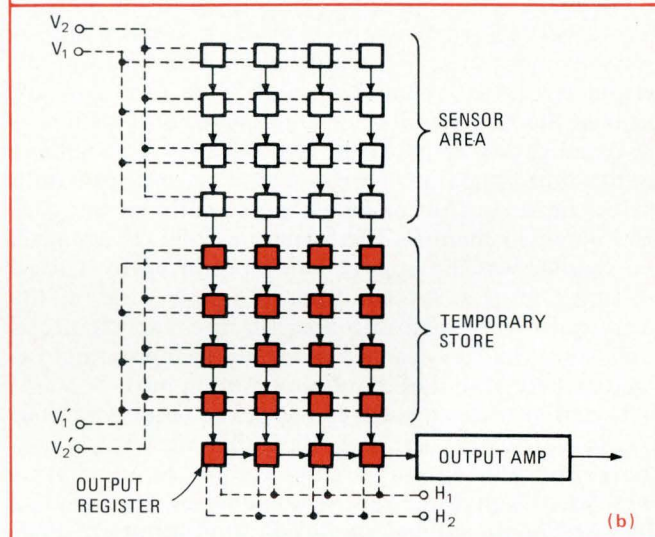
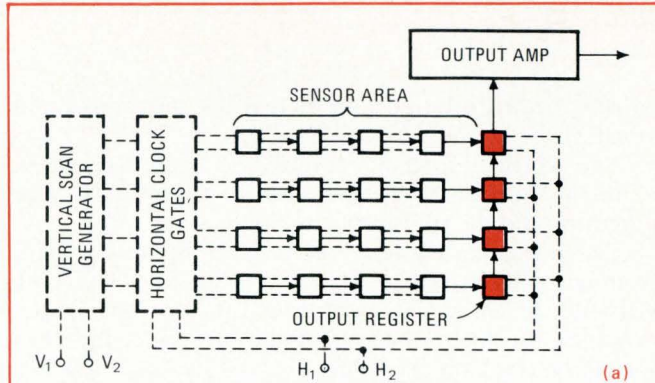

**7. Across or down?** Two systems of scanning charge transfer sensors are horizontal (a) along successive rows into a continuously running output register, and vertical (b) along columns in parallel into a separate store and a horizontal output register. Shaded areas represent stages needed in addition to the sensors.

ciency in the vertical system because of the lower transfer frequency.

- Charge packets in the horizontal system are active for a shorter time than the packets in the vertical system. The difference in time is one frame because of the additional delay introduced by the store in the vertical system. The effect of the delay in the vertical system is to demand that the permissible dark current and number of defects per unit area be approximately half that required in the horizontal system for comparable picture quality.

- In the horizontal system, a single short circuit between clock electrodes in any row will inactivate only that row, whereas the same defect in the vertical system would jeopardize the entire sensor. However, for a three-phase clock, the horizontal system would require clock crossovers within the sensor area, while the vertical system requires no such crossovers for any number of phases (for a two-phase system, the horizontal system doesn't require crossovers, since the sensor elements are accessible from two directions, as shown in the serpentine paths in Fig. 3).

- The horizontal system requires only two independent clock supplies, while the vertical system requires three (vertical transfer from sensor into store, vertical

## SPECIAL REPORT

transfer from store into output register, and horizontal transfer).

- The vertical system requires no scan generator, while the horizontal system requires the vertical scan generator and the transmission gating system.

- The horizontal system can provide directly a standard vertically interlaced signal at 60 fields per second, with full 1/30-second integration time for each field. However, the horizontal system does introduce the extra horizontal clock cycle between lines as shown in Fig. 5.

The extra cycle could be compensated for by increasing the vertical scan frequency, as was done with the 32-by-44-element array. It could be avoided by using an output circuit in which the signals from each row are delayed the same amount or not delayed at all. Circuits designed earlier to avoid the extra cycle<sup>12</sup> were subject to non-uniform gain from row to row or to degradation in s/n ratio because of excess capacitance in the converging video channel. The higher the load capacitance, the smaller was the voltage swing produced by a fixed amount of charge. If the outputs of  $n$  gates handling the  $n$  rows are converged into a single line, capacitance is high, since the stray capacitances add to the normal capacitance to ground of the common drain bus.

The circuit of Fig. 8 will converge the outputs without excessive load capacitance. Basically, the circuit is a charge transfer fan-in circuit, applicable to charge-coupled, as well as bucket-brigade devices, in which two lines are combined and the result and output are combined with the output of the next two lines. The capacitor receiving the signal can be made the same size as either of the two capacitors from which the signal may be transferred. Thus, total transistor stray capacitance of each common drain is never more than twice the stray

capacitance of a single stage in a normal register.

Although the capacitance to ground of some of the longer-drain buses in the fan-in circuit could degrade the transfer efficiency somewhat for these stages, it is not expected that a major limitation in an output signal would result, since only a few stages would be so affected. Only nine half-stages would be required to channel the signal from 512 rows into a common output. Note that a summing stage is used at the output to remove the clock pulse effects from the video signal.

Charge transfer scanning can also be applied to conventional arrays with X-Y coordinate strips, as shown in Fig. 9a, using photosensitive elements such as photodiodes, phototransistors<sup>13</sup> or photoconductors.<sup>11</sup> This arrangement would be useful for special-purpose arrays having high sensitivity at particular wavelengths, and for high-gain photoconductive arrays that operate by excitation storage rather than by charge storage.

With charge transfer scanning, the charges are removed simultaneously from the elements of a single row during one line period, stored temporarily in parallel charge transfer-holding elements, and then transferred in parallel to the output register. The charges then are scanned out during the next line period. Fig. 9b shows the circuit diagram for a photodiode MOS field-effect transistor sensor array constructed for scanning by charge transfer. In operation, light imaged on the array causes charges to accumulate on the elemental capacitors during the period between scans.

When a given row is to be scanned, the vertical scanner turns on all transistors in that row. Simultaneously, the transfer pulser causes the signals on each of the capacitors in that row to be transferred down to the temporary holding element CT. The signals are transferred out of the holding elements into the output register during the following horizontal retrace time.

During the next horizontal line time, the video infor-

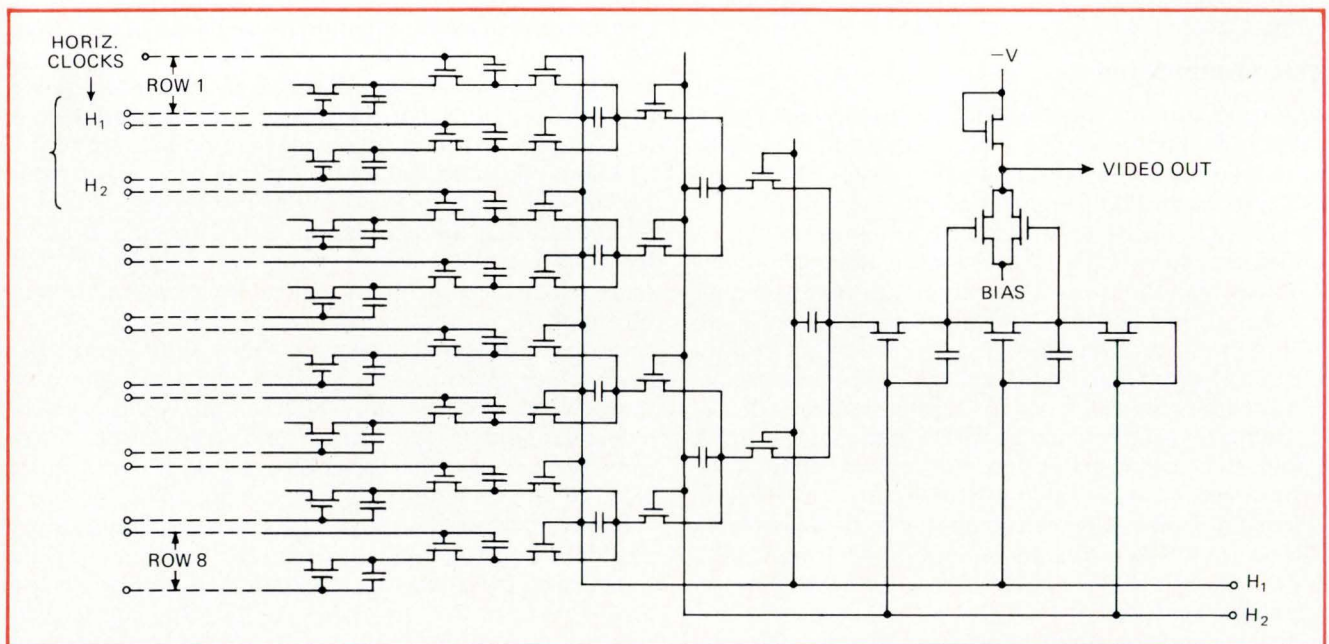

**8. Fan-in register.** Delay introduced by output register in horizontal transfer system can be eliminated with a charge transfer fan-in register. Shown for eight rows, outputs of pairs of rows are fed into capacitors and then combined with next pair in a similar state. Final output is summed in parallel output stage to remove clock waveform.

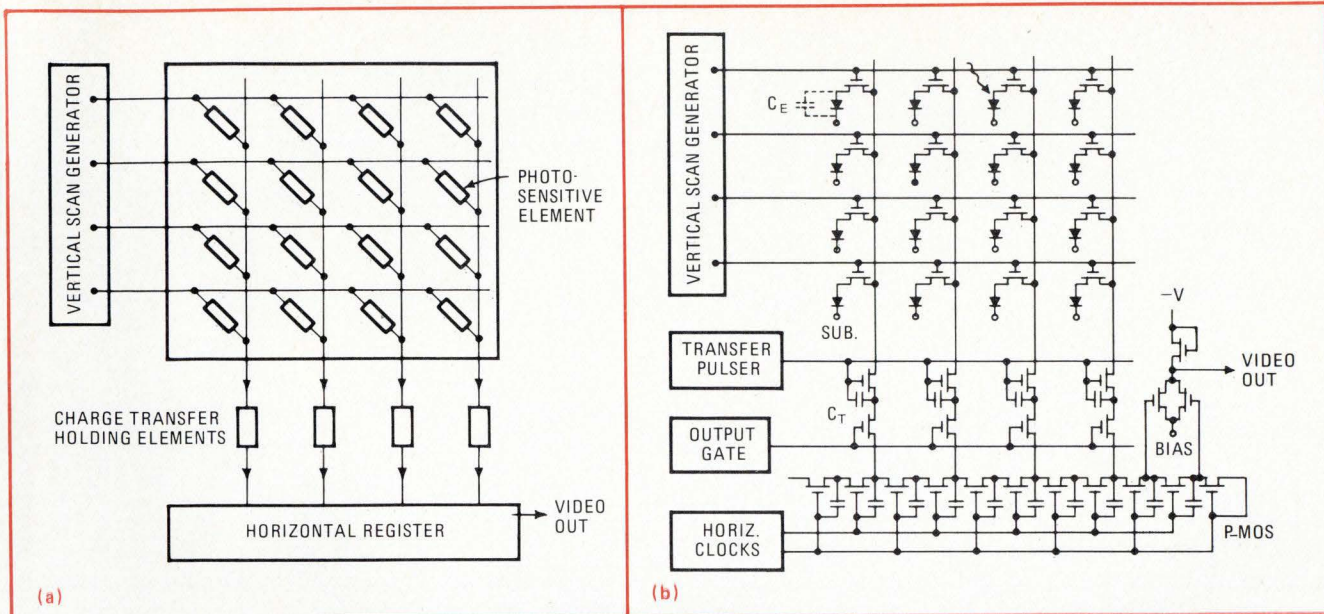

**9. X-Y array scanning.** Bucket brigade circuit improves signal extraction from conventional X-Y address arrays (a). Charges are removed simultaneously from row, temporarily stored in holding elements, and then transferred to output register for scanning during next line period. Circuit used for test array (b) shows portion of eight-by-eight format and associated bucket brigade circuitry, using discrete photo diodes, MOSFETs and capacitors.

mation is transferred stepwise through the output register, while charges from the next row are being transferred to the holding elements. The video signal is obtained by adding the voltage-sampled signals from two successive nodes of the output register using a circuit similar to that in Fig. 6.

A MOS photodiode test array in an 8-by-8 format has been built with discrete component photodiodes, MOS FETs and capacitors as in Fig. 9b. The resulting picture transmitted (Fig. 10) is displayed on a standard TV monitor operating at normal scan rates. (Because there are only eight lines, a simple image was all that could be used.)

### Signal transfer

The signal from successive rows in the array was transferred into the output register during the horizontal flyback time of every 16th TV line. Although square-clock pulses having 50-nanosecond rise times were used for the horizontal register, switching transients in the output of the summing amplifier were very low.

Similar techniques applied to other types of arrays with X-Y address strips would also improve operating sensitivity by reducing the switching transients normally obtained with conventional multiplexers. No experimental comparison of sensitivity has been made between integrated MOS photodiodes with readout by external charge transfer and an internal scanned array using direct illumination of the registers.

One possible limitation of the charge transfer readout of an X-Y array would arise from the larger capacitance of the column address strips, tending to limit the efficiency of transfer of signals from the elements to the output register. Fortunately, a line-time is available to complete this transfer, and any excess charge left over in the column capacitance could be removed so as not to interfere with the signal from succeeding lines. □

### References

1. M. G. Kovac, P. K. Weimer, F. V. Shallcross, and W. S. Pike, "Self-Scanned Image Sensors Based Upon Bucket-Brigade Scanning," IEEE Electron Devices Meeting Abstracts, Oct. 1970, p. 106.
2. F. L. J. Sangster and K. Teer, "Bucket-Brigade Electronics—New Possibilities for Delay, Time-Axis Conversion, and Scanning," IEEE J. Solid-State Circuits, June 1969, pp. 131-136.
3. F. L. J. Sangster, "Integrated MOS and Bipolar Analog Delay Lines Using Bucket-Brigade Capacitor Storage," Digest of Technical Papers, 1970 IEEE International Solid-State Circuits Conference, Feb. 1970, p. 74.
4. W. S. Boyle and G. E. Smith, "Charge Coupled Semiconductor Devices," Bell System Tech. J., April, 1970, p. 587.
5. W. J. Bertram, "Application of the Charge-Coupled Device Concept to Solid State Image Sensors," 1971 IEEE International Convention Digest, March 1971, p. 250.
6. M. F. Tompsett, G. F. Amelio, W. J. Bertram Jr., R. R. Buckley, W. J. McNamara, J. C. Mikkelsen Jr., and D. A. Sealer, "Charge-Coupled Imaging Devices: Experimental Results," IEEE Trans. Elect. Dev., Nov. 1971, pp. 992-996.
7. C. N. Berglund and H. J. Boll, "Performance Limits of Bucket-Brigade Shift Registers," IEEE Electron Devices Meeting Abstracts, Oct., 1970, p. 16.
8. M. G. Kovac, F. V. Shallcross, W. S. Pike and P. K. Weimer, "Image Sensors Based Upon Charge Transfer by Integrated Bucket-Brigades," IEEE Electron Devices Meeting Abstracts, Oct. 1971, p. 74.
9. E. I. Gordon and M. H. Crowell, "The Silicon Diode Array Camera Tube," Bell Syst. Tech. J., Nov. 1968, p. 1855.
10. G. F. Amelio, W. J. Bertram Jr., and M. F. Tompsett, "Charge Coupled Imaging Devices: Design Considerations," IEEE Trans. Electron Devices, Nov. 1971, pp. 986-992.
11. P. K. Weimer, W. S. Pike, G. Sadasiv, F. V. Shallcross, and L. Meray-Horvath, "Multi-element Self-scanned Mosaic Sensors," IEEE Spectrum, March 1969, p. 52.
12. P. K. Weimer, M. G. Kovac, F. V. Shallcross and W. S. Pike, "Self-Scanned Image Sensors Based Upon Charge Transfer by the Bucket-Brigade Method," IEEE Trans., Electron Devices, Nov. 1971, pp. 996-1003.
13. R. A. Anders, D. E. Callahan, W. F. List, D. H. McCann and M. A. Schuster, "Developmental Solid-State Imaging System," IEEE Trans. Electron Devices, 1968, pp. 191-196.

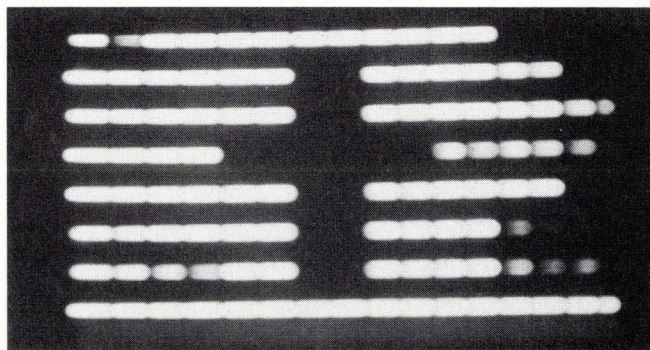

**10. Screening.** Television display is of signal transmitted by eight-by-eight MOSFET-photodiode array and scanned by bucket-brigade circuit. With only eight lines, test display had to be simple pattern.

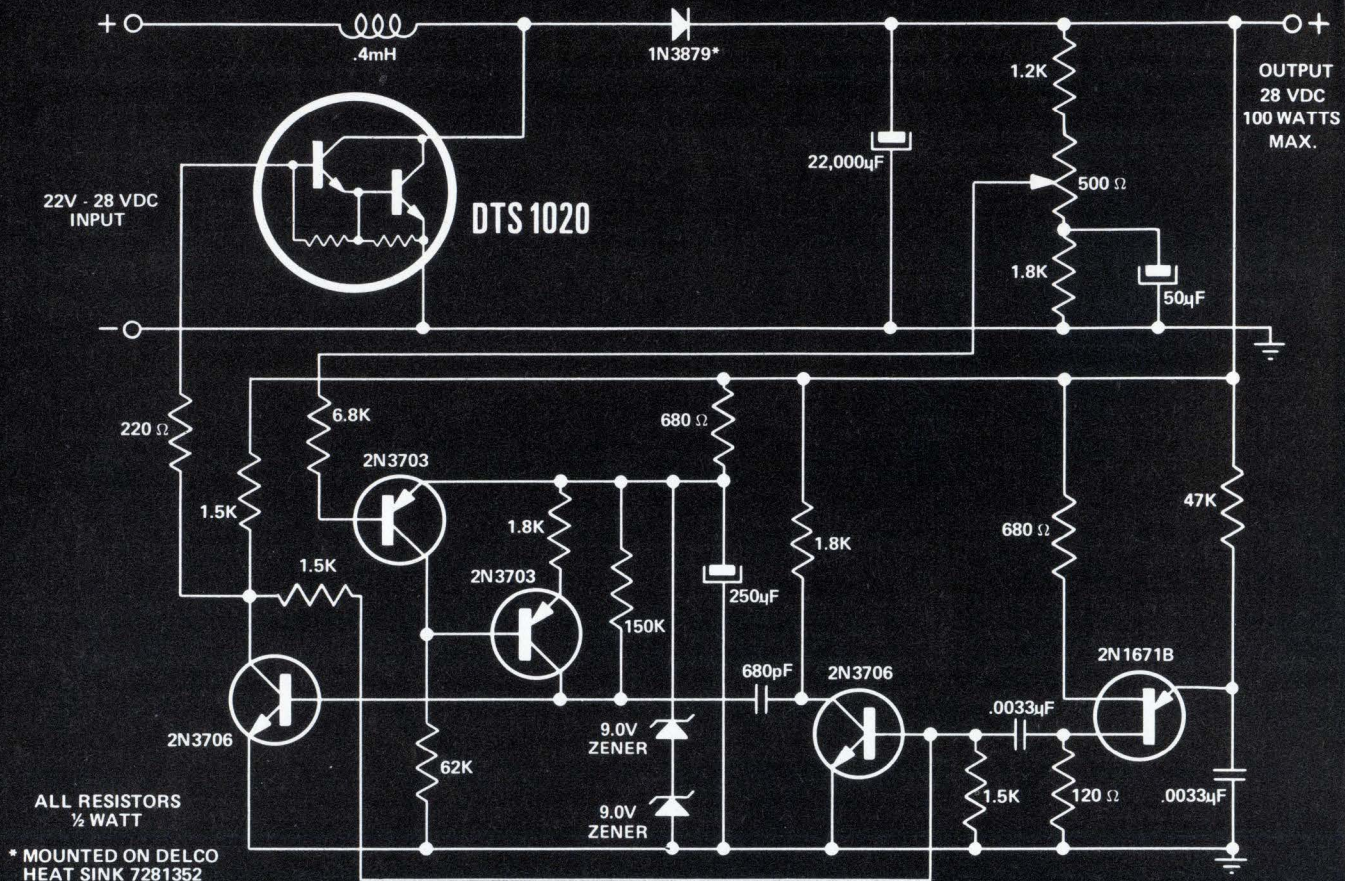

### SWITCHING REGULATOR

	$V_{CEO}$ @ 0.1 mA	$V_{EBO}$ @ 50 mA	$V_{CE(SUS)}$ @ 500 mA	$h_{fe}$ @ 1 MHz ( $V_{CE} = 10V,$ $I_C = 200 mA$ )	$h_{FE}$ ( $V_{CE} = 5V,$ $I_C = 10A$ )	$V_{CE(SAT)}$ @ 5.0 A	$I_C$	$P_T$ @ 75°C
<b>DTS-1010</b>	<b>120V</b>	<b>7V</b>	<b>80V</b>	<b>12</b>	<b>200</b>	<b>1.8V</b>	<b>10A</b>	<b>100W*</b>
<b>DTS-1020</b>	<b>120V</b>	<b>7V</b>	<b>80V</b>	<b>12</b>	<b>500</b>	<b>1.5V</b>	<b>10A</b>	<b>100W*</b>

\*100 percent tested at 2.5A, 40V.



# The Kokomoans now give you Darlington Switching Power.



Use a Darlington in place of an ordinary transistor, and you'll realize an additional magnitude of gain plus increased switching power. Use a Delco silicon power Darlington (DTS-1010 or DTS-1020) and you'll also realize a gain in dependability.

Delco's Darlington's are triple diffused mesa units housed in copper TO204MA cases and built for ruggedness. The design gives them high energy capability—the ability to handle surges of current and voltage simultaneously. They are ideal for switching inductive loads in circuits subject to transients or fault conditions.

Design a switching regulator circuit around a Delco Darlington or use it in any 60-100 volt

application to reduce circuit size, weight, and cost. In addition, the Darlington space saving feature allows you more design flexibility. Unlike an ordinary transistor, it's only energy-limited, not beta-limited. You can exploit its full energy capability in your circuit.

Call your nearest Delco distributor. He has them in stock and he's got the data on high energy switching for small spaces.

For details on the switching regulator circuit, ask for Application Note 49.

## Now available from these distributors in production quantities.

ALA., BIRMINGHAM • Forbes Distributing Co., Inc. (205)-251-4104  
 ARIZ., PHOENIX • Cramer/Arizona (602)-263-1112 • Sterling Electronics (602)-258-4531  
 CAL., LOS ANGELES • Kierulff Electronics, Inc. (213)-685-5511 • Radio Products Sales, Inc. (213)-748-1271  
 CAL., PALO ALTO • Kierulff Electronics, Inc. (415)-968-6292  
 CAL., REDWOOD CITY • Cramer/San Francisco, (415)-365-4000  
 CAL., SAN DIEGO • Milo of California, Inc. (714)-232-8951  
 CAL., SAN DIEGO • Radio Products Sales, Inc. (714)-292-5611  
 COLO., COLORADO SPRINGS • Walker Electronics (303)-636-1661  
 COLO., DENVER • Cramer/Denver (303)-758-2100 • Denver Walker Electronics (303)-935-2401  
 ILL., ROSEMONT (Chicago) • Kierulff/F-J-R (312)-678-8560  
 ILL., SKOKIE (Chicago) • Merquip Electronics (312)-282-5400  
 IND., INDIANAPOLIS • Graham Electronics Supply, Inc. (317)-634-8202  
 MD., BALTIMORE • Radio Electric Service Co. (301)-823-0070  
 MASS., NEEDHAM HEIGHTS • Kierulff Electronics, Inc. (617)-449-3600  
 MASS., NEWTON • The Greene-Shaw Co., Inc. (617)-969-8900  
 MICH., ROMULUS • Harvey/Detroit (313)-729-5500

MINN., MINNEAPOLIS • Stark Electronics Supply Co. (612)-332-1325  
 MO., KANSAS CITY • Walters Radio Supply, Inc. (816)-531-7015  
 MO., NO. KANSAS CITY • LCOMP-Kansas City, Inc. (816)-221-2400  
 MO., ST. LOUIS • LCOMP-St. Louis, Inc. (314)-647-5505  
 N.J., CLIFTON • Eastern Radio Corporation (201)-471-6600  
 N.M., ALBUQUERQUE • Cramer/New Mexico (505)-265-5767 • Sterling Electronics (505)-247-2486  
 N.Y., BINGHAMTON • Harvey/Federal (607)-748-8211  
 N.Y., EAST SYRACUSE • Cramer/Eastern (315)-437-6671  
 N.Y., ROCHESTER • Cramer/Rochester (716)-275-0300  
 N.Y., WOODBURY • Harvey/New York (516)-921-8700  
 OHIO, CINCINNATI • United Radio, Inc. (513)-761-4030  
 OHIO, CLEVELAND • Pattison Supply (216)-441-3000  
 OHIO, DAYTON • Kierulff/F-J-R (513)-278-9411  
 OKLA., OKLAHOMA CITY • Radio, Inc. (405)-235-1551  
 OKLA., TULSA • Radio, Inc. (918)-587-9123  
 PENN., PHILADELPHIA • Almo Electronics (215)-676-6000  
 PENN., PITTSBURGH • RPC Electronics (412)-782-3770

S.C., COLUMBIA • Dixie Radio Supply Co., Inc. (803)-253-5333  
 TEXAS, DALLAS • Adleta Electronics Co. (214)-741-3151  
 TEXAS, FORT WORTH • Adleta Electronics Co. (817)-336-7446  
 TEXAS, GARLAND • Kierulff Electronics, Inc. (214)-271-2471  
 TEXAS, HOUSTON • Harrison Equipment Co., Inc. (713)-224-9131  
 UTAH, SALT LAKE CITY • Cramer/Utah (801)-487-3681  
 VA., RICHMOND • Meridian Electronics, Inc., a Sterling Electronics Company (703)-353-6648  
 WASH., SEATTLE • Kierulff Electronics, Inc. (206)-763-1550  
 WASH., TACOMA • C & G Electronics Co. (206)-272-3181  
 CANADA, ONT., SCARBOROUGH • Lake Engineering Co., Ltd. (416)-751-5980  
**ALL OVERSEAS INQUIRIES:**  
 General Motors Overseas Operations Power and Industrial Products Dept., 767 Fifth Avenue, New York, N.Y. 10022. Phone: (212)-486-3723.

**Kokomoans' Regional Headquarters.**  
 Union, New Jersey 07083, Box 1018, Chestnut Station, (201) 687-3770.  
 El Segundo, Calif. 90245, 354 Coral Circle, (213) 640-0443.  
 Kokomo, Ind. 46901, 700 E. Firmin, (317) 459-2175 (Home Office).



**Delco Electronics**

DIVISION OF GENERAL MOTORS CORPORATION.  
 KOKOMO, INDIANA



# Designer's casebook

## Transducer preamplifier conserves quiescent power

by Robert F. Downs  
Ocean & Atmospheric Science Inc., Santa Ana, Calif.

A low-voltage micropower preamplifier holds power dissipation to approximately 13 microwatts because of the low bias current of its two-transistor impedance converter output stage. The preamplifier, which is intended for use with a capacitive transducer, operates at a quiescent current of 10 microamperes with a supply voltage of only 1.35 volts.

The gate of field-effect transistor  $Q_1$  is essentially biased at 0 v through resistor  $R_1$ . Negative feedback, provided by resistor  $R_2$ , maintains  $Q_1$ 's gate-to-source voltage at approximately -0.4 v, forcing its drain current to less than  $4\mu\text{A}$ . Resistor  $R_2$ , therefore, contributes significantly to  $Q_1$ 's bias stability.

Preamplifier input impedance depends on both  $R_1$  and the voltage gain of the field-effect transistor stage. Actual FET intrinsic input impedance can be ignored since it is orders of magnitude larger than  $R_1$ .

If  $e_i$  denotes input signal voltage, the voltage across  $R_1$  can be expressed as  $e_i(1+K_v)$ , where  $K_v$  is the stage's voltage gain. Since current through  $R_1$  is in-

creased by a factor of  $1 + K_v$ , the apparent input impedance is  $R_1/(1+K_v)$ .

On a small-signal basis, then, the preamplifier's input stage is equivalent to a common-source configuration, while the bias arrangement is that of a source-follower. For the over-all circuit, the dc input impedance is around 1.5 megohms, while the ac input impedance is about 300 kilohms.

The FET selected for this circuit should have a low pinch-off voltage ( $V_P$ ) and a low drain current ( $I_{DSS}$ ) when the gate-source junction is shorted. For the device used,  $V_P$  is about 0.1 v and  $I_{DSS}$  approximately  $100\mu\text{A}$ . Because a FET's transconductance ( $g_m$ ) depends on drain current,  $Q_1$ 's  $g_m$  is only around 50 micromhos.

Since the FET's output conductance is negligible, its output impedance, like that of a common-source stage, essentially equals  $R_2$ . Because this is a high resistance value, two bipolar transistors,  $Q_2$  and  $Q_3$ , are used as an impedance converter.

This converter stage operates like a pnp emitter-follower, providing very high values of current gain and input impedance. Moreover, it realizes greater bias voltage compatibility between the FET and bipolar stages than a conventional Darlington pair could. Converter bias current is about  $6\mu\text{A}$ , input impedance exceeds 2 megohms, and output impedance is about 4 kilohms.

For the preamplifier, equivalent input broadband noise is relatively low, about  $33\mu\text{V}$  from 140 hertz to 20 kilohertz. And voltage gain is nominally 5 (14 decibels).

**Power pincher.** Preamplifier for capacitive transducer input dissipates only 13 microwatts and operates from 1.35-volt supply. Bias current of impedance converter, composed of bipolar transistors  $Q_2$  and  $Q_3$ , is only 6 microamperes, keeping total circuit current drain to only  $10\mu\text{A}$ . FET input stage has source-follower bias arrangement but provides voltage gain of common-source configuration.

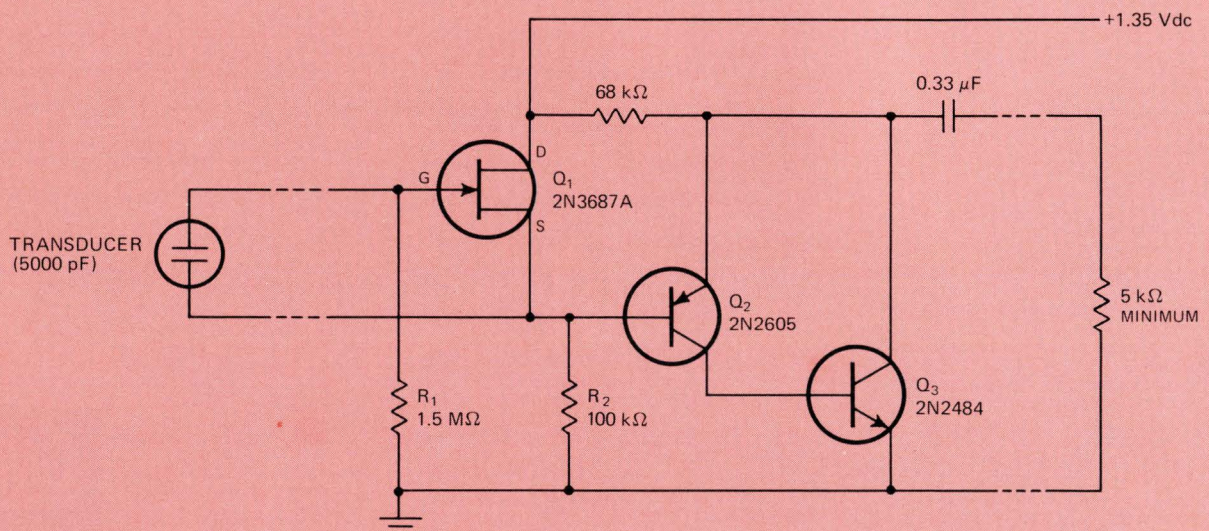

# Differentiate and count to find frequency error

by Robert C. Rogers  
Texas A&M University, College Station, Texas

By counting differential pulse transitions for a known period, a simple error-detection circuit measures the frequency difference between a variable square wave and reference square wave. Usually, frequency error is found by counting both signals for some fixed period and then comparing the resultant values, or by mixing the signals and then counting the beat frequency. The first method often requires a considerable amount of digital logic if high-frequency signals are involved, while the second method is generally limited by the passband of the beat-frequency detector.

The frequency error detector shown requires input signals that are compatible with logic circuits. (A zero crossover detector could be used initially to prepare the inputs.) The reference square wave is differentiated and

applied to the strobe input of a latch, and the variable square wave is applied to the data input of the latch.

How many positive or negative transitions the latch output makes in a given period represents the number of times the variable frequency has gained or lost a full cycle relative to the reference. Counting these transitions for a known period, then, yields the total frequency error during that period. A high-level output indicates that the variable is within the limit.

The time-base input signal sets the latch to a logic 1 if the four-bit counter does not reach a value of 10 in the preceding 0.1-second timing interval. This signal is also used to reset the counter for the next counting period, which begins when the reset pulse returns to zero.

There are two drawbacks that should be remembered. The detector fails if the variable frequency becomes identical to the reference in both frequency and phase, and it becomes ambiguous when the variable frequency is either a higher or lower harmonic of the reference. However, even with these limitations, the detector is useful and reliable over the reference range of 5 to 20 megahertz. Error limit for the circuit shown is  $\pm 100$  hertz and can be changed by altering the number detected by the counter gate.

**Frequency error detector.** Differentiated reference square wave drives latch strobe input; variable square wave feeds latch data input. Counter logs either positive or negative transitions of latch output for specific period to total frequency error between inputs. High circuit output indicates error is within desired limit. Time-base signal sets latch and resets counter. Detector range is 5 to 20 MHz for  $\pm 100$  Hz.

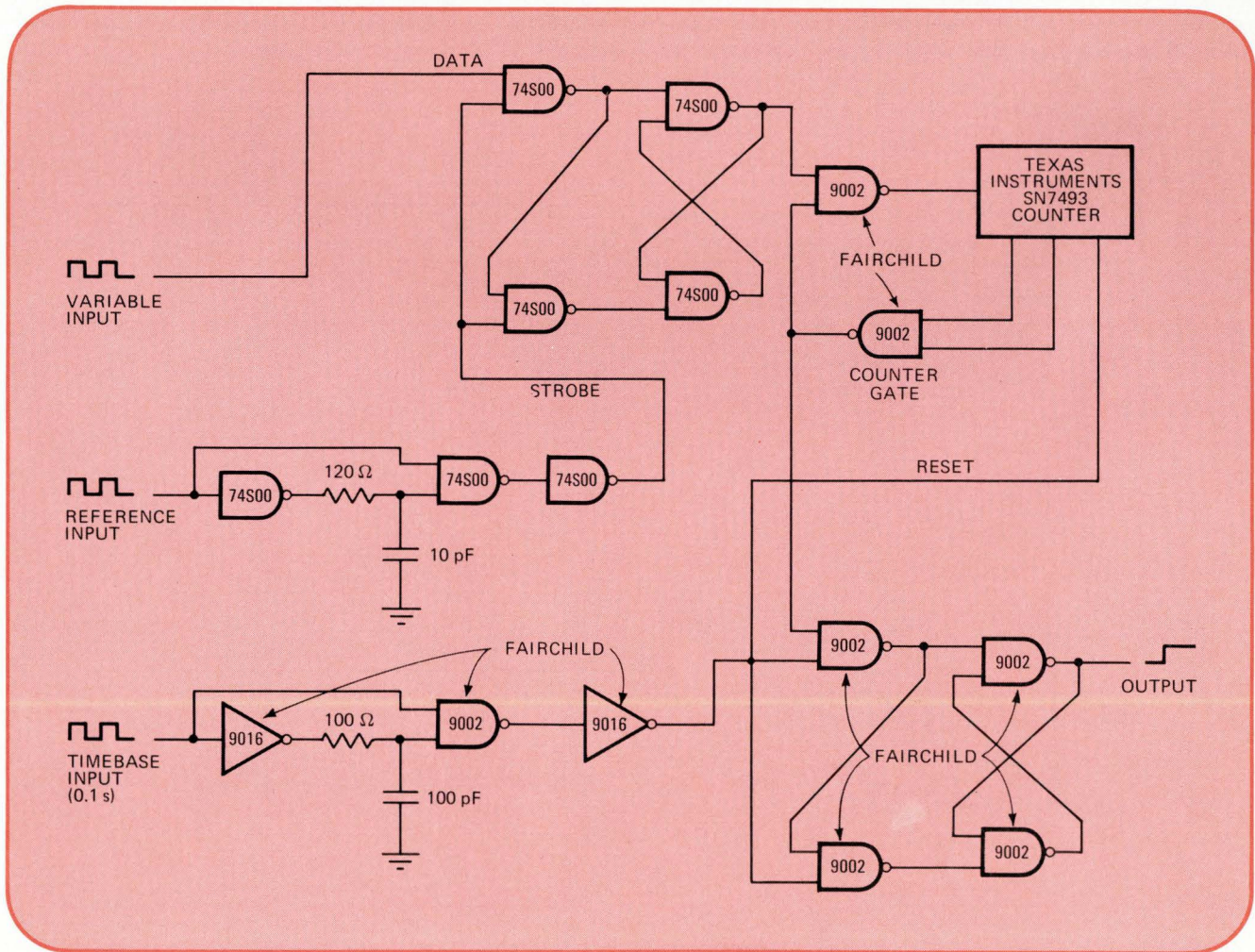

# Feedback latch reduces memory recovery time

by Joseph McDowell and William Moss  
*Monolithic Memories Inc., Sunnyvale, Calif.*

The cycle time of wire-ORed semiconductor memories can be improved with the addition of a feedback gate to a NAND gate latch. The resulting three-gate configuration, which also includes a diode and a resistor, provides latched data outputs from open-collector memory packages with significantly reduced turn-off delay.

For open-collector devices, like  $S_1$  through  $S_N$  in the diagram, the common problem is choosing a pull-up resistor that is small enough for fast turnoff and large enough for the current sinking capability of the package's open-collector driver. Turn-on speed is not usually a problem, since capacitors  $C_1$  through  $C_N$  are driven from a low-impedance saturated transistor.

However, turn-off speed or recovery time is determined by the RC time constant at the wire-ORed node. If many memory outputs turn on at once (for example when all low-logic signals are stored in a 72-bit memory word), the change in the power supply load (about 1

ampere in 10 nanoseconds for 15-milliampere open-collector drivers) may require a large pull-up resistor to keep voltage noise within specifications at the expense of turn-off speed.

The illustrated latch employs the common cross-couple gate arrangement of  $G_1$  and  $G_2$ . A feedback gate,  $G_3$  actively pulls up the wire-ORed line (like a tri-state gate) after the cross-coupled gates latch. Diode  $D_1$  isolates  $G_3$  from node A, allowing low-level signals to be sensed at this point. To avoid transistor-transistor logic high-level signal problems at node A,  $D_1$  should have a low forward-voltage drop.

Resistor  $R_1$  is used to limit the current from gate  $G_3$  to the open-collector outputs of memories  $S_1$  through  $S_N$ . The value of  $R_1$  must be small enough to provide an acceptably low signal level at the latch input. Only the output leakage of the wire-ORed memories and the input leakage of the feedback latch determine the maximum value of pull-up resistor  $R_2$ . Recommended values for resistor  $R_2$  range from 1 to 10 kilohms, depending on power supply load considerations.

For 16 wire-ORed memory packages and a 4.7-kilohm pull-up resistor, the feedback latch can reduce turn-off time from 70 to 10 nanoseconds.

**Speeding up wire-ored memories.** Cross-coupled gates  $G_1$  and  $G_2$ , along with feedback gate  $G_3$ , trim turn-off delay for array of wire-ored memories ( $S_1$  through  $S_N$ ). Three-gate feedback latch uses diode to isolate  $G_3$  so that low-level signals can be detected at wire-ored node A. Resistor  $R_1$  prevents surge currents from  $G_3$ . Maximum value of pull-up resistor  $R_2$  is determined by leakage currents.

Designer's casebook is a regular feature in Electronics. We invite readers to submit original and unpublished circuit ideas and solutions to design problems. Explain briefly but thoroughly the circuit's operating principle and purpose. We'll pay \$50 for each item published.

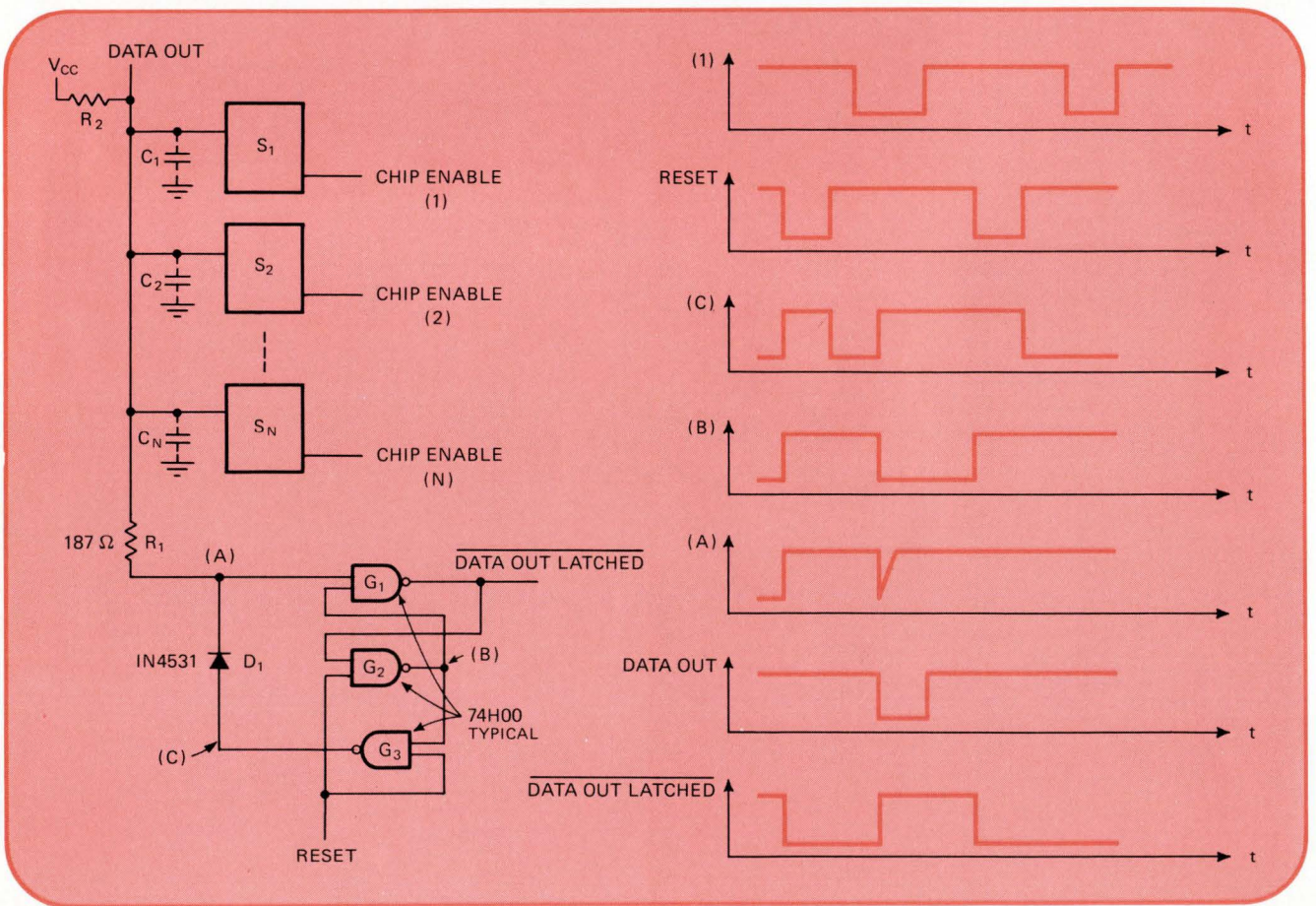



# Best FET yet.

Only \$8.50 in 100's.

Philbrick's 1421 FET operational amplifier is a guaranteed performer. Low bias current: less than 50pA *guaranteed*. High output current:  $\pm 10\text{mA}$  *guaranteed*. High CMRR: 4000 *guaranteed*. Common-mode voltage range:  $\pm 12\text{V}$  *guaranteed*. Unity-gain frequency: 1 MHz *guaranteed*.

These guarantees (and more) are all yours in a single TO-99 can. Attractive quantity discounts apply. Models 1421/01 and 1421/02 are the operational amplifiers with even tighter specs for more sophisticated applications.

And remember to power up with Philbrick Power Supplies for best performance.

Ask your local Philbrick representative for complete details or write, Teledyne Philbrick, Allied Drive at Route 128, Dedham, Massachusetts 02026. For toll-free ready data dial (800) 225-7883. In Massachusetts (617) 329-1600.

## Philbrick Operational Amplifiers The good ones.

# Accurate transistor tests can be made inexpensively

These eight op-amp circuits, costing \$75 to \$100 each, will measure the key characteristics of bipolar and field-effect transistors at a fraction of the cost of sophisticated special-purpose testers

by Jerald Graeme, *Burr-Brown Research Corp., Tucson, Ariz.*

□ Choosing a method of testing a moderate number of transistors—say, 1,000 a day—presents an intriguing challenge. A curve tracer is too slow because it usually needs adjustment for each device being tested, and it is not accurate enough for most leakage-current and device-matching measurements. A special-purpose test set can do the job well enough, but it costs too much to justify its use for such a small number of devices.

The best approach is to build the necessary circuits—eight will suffice—with commercially available operational amplifiers for testing the various parameters of bipolar and field-effect transistors. Each circuit, which costs only \$75 to \$100, provides the same high accuracy and test rates as more expensive special-purpose sets.

While the basic circuits are intended for voltmeter display, they can be used with simple ramp generators to provide oscilloscope traces of a wide variety of transistor parameters. When the oscilloscope and ramp generator are added, the various quantities can be displayed as a function of any selected parameter.

Only the resistors need to be adjusted in the op-amp test circuits to provide independent control of bias currents, bias voltages, and ac test signals. The indepen-

dence of the resistive controls is achieved by exploiting the high gains, high input resistances, and low output resistances of the op amps used in the test circuits.

The eight measuring circuits are described below. Two of them—those that measure beta and output conductance—are to be used with bipolar transistors. Three others—those that measure forward transconductance, drain-source resistance, and pinch-off voltage—are for field-effect transistors. The remaining three circuits—breakdown voltage, leakage current, and component matching—are for both types of transistors.

## Measurement of beta

In the usual curve-tracer measurement of beta, the instrument sets the base current for a common-emitter configuration, and beta is then found by observing the resulting collector current. This is a poor testing procedure because, with it, the collector bias and signal currents vary with beta. It is better to measure beta by observing the resulting base current at specific values of collector bias and signal currents.

With the recommended test circuit (Fig. 1), the collector bias and signal currents are established by the feed-

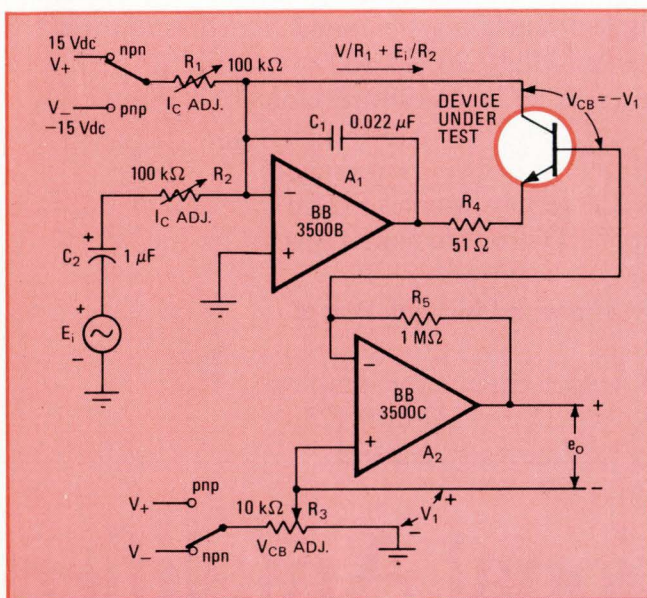

1. **Measuring current gain.** By fixing both dc and ac collector currents  $I_C$  and  $I_e$  and measuring base currents that result, this circuit avoids problem of having operating point vary with beta.

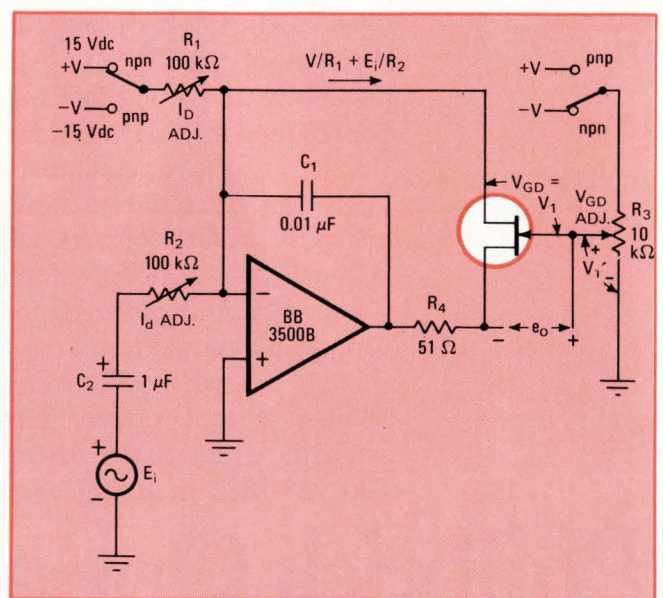

2. **Measuring  $g_{fs}$ .** Like the beta-measuring circuit for bipolar transistors (Fig. 1), this field-effect transistor tester measures forward transconductance  $g_{fs}$ , at a preset operating point.

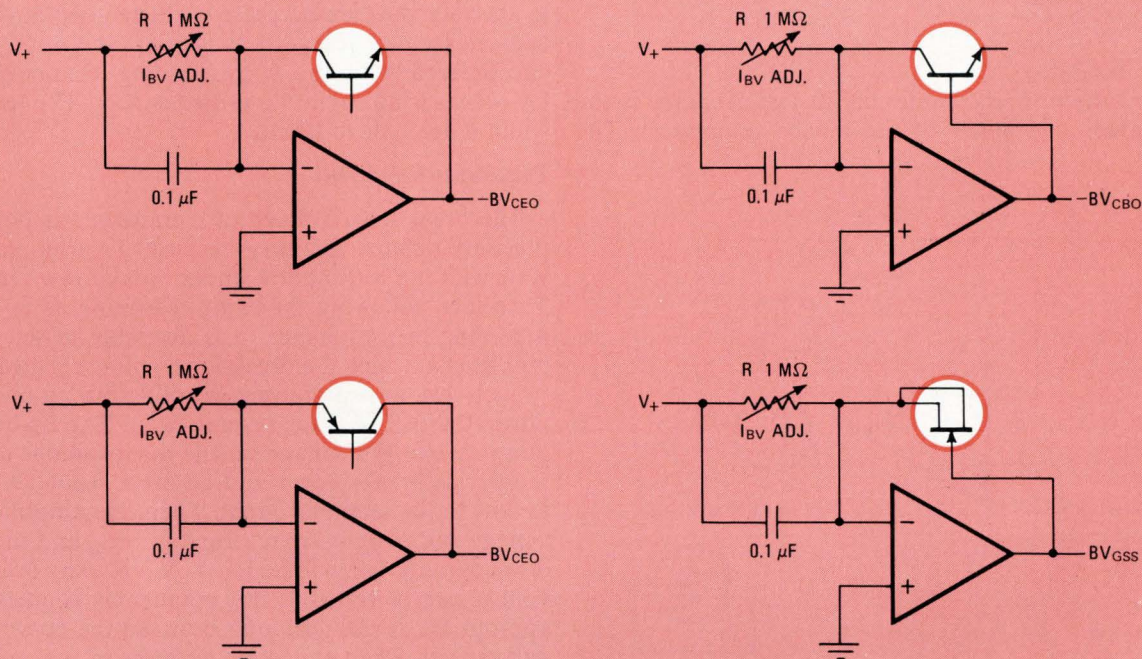

**3. Breakdown.** In all four of these setups, op amp increases voltage across device under test until it breaks down and allows feedback current to flow. Breakdown current is limited to  $V_+/R$ . Tester limits depend on output voltage range of the op amp.

back around amplifier  $A_1$ . In establishing these currents,  $A_1$  drives the transistor under test so as to maintain nearly zero voltage and current at the op-amp inputs. For zero input voltage, the common ends of  $R_1$  and  $R_2$  are at ground potential, and the input signals are impressed entirely across these resistors.

For zero op-amp input current, the currents through  $R_1$  and  $R_2$  all flow in the collector. The collector's direct current is then given by  $I_C = V/R_1$ , and the alternating current is given by  $I_c = E_i/R_2$ .

The base current resulting from the flow of these collector currents is supplied to  $A_2$  and flows through the feedback resistor  $R_5$ . From this current, an output voltage,  $e_o$ , is generated, where

$$e_o = R_5[(I_C/h_{FE}) + (I_c/h_{fe})].$$

The quantity  $h_{FE}$  is the dc or static value of beta, while  $h_{fe}$  is the ac, or dynamic value. If  $e_o$  is considered to have a dc component,  $E_o$ , and an ac component,  $E_o$ , then the two betas are given by

$$h_{FE} = (R_5/R_1)(V/E_o)$$

and

$$h_{fe} = (R_5/R_2)(E_i/E_o).$$

Amplifier  $A_2$  also serves as a convenient means of setting the collector-base bias,  $V_{CB}$ . From  $R_3$ , a voltage is set at one amplifier input and is thereby set at the base of the test transistor. This base voltage establishes  $V_{CB}$ , since the collector is held at zero voltage by  $A_1$ . Then, from Fig. 1,  $V_{CB} = -V_1$ .

Using this circuit, low-frequency measurements can be made within the deviation permitted by the temperature coefficient of beta. This temperature coefficient is about 0.5% per degree centigrade near room temperature, and normal ambient variations limit deviations to around 1%. Test accuracy is also directly related to the

accuracies of voltages  $V$  and  $E_i$  and of resistors  $R_1$ ,  $R_2$ , and  $R_5$ .  $R_1$  and  $R_2$  are usually multi-turn potentiometers with turns-counting dials. This makes it possible to set  $I_C$  and  $I_c$  without actually measuring the collector currents.

At low currents, an additional error in the test for  $h_{FE}$  is the input bias current of  $A_2$ , but this may be avoided by using a FET-input op amp. Further limitations to the  $h_{fe}$  test are the op-amp bandwidth and the stray capacitance shunting the high resistance of  $R_5$ . These latter factors limit ac beta testing to 10 kilohertz or lower.

Since the operator is completely free to choose the test frequency, he can select a low one for the low-level testing, thus avoiding the stray capacitance effects that limit the accuracy of measurements made on a curve tracer.

#### Likewise for $g_{fs}$

The forward transconductance,  $g_{fs}$ , of a FET, can be measured in a manner similar to that of the beta test above. Again it is preferable to test at a fixed operating point rather than with a fixed driving signal. Therefore, the drain bias and signal currents are fixed in Fig. 2 as they were in Fig. 1. In this case, the dc and ac drain currents are set by  $R_1$  and  $R_2$  to be  $I_D = V/R_1$  and  $I_d = E_i/R_2$ , respectively. The biasing voltage on the FET is set directly by establishing the gate voltage with  $R_3$ . Since the drain is held at zero voltage at the op-amp input, the gate-drain voltage,  $V_{GD}$ , is set by the gate bias at  $V_{GD} = V_1$ .

To find the forward transconductance, the gate source voltage developed by the drain current is measured at the output. By relating this voltage to the drain current,

the static and dynamic values of the forward transconductance are found to be

$$g_{FS} = V/R_1 E_0$$

and

$$g_{fs} = E_1/R_2 E_0.$$

Again, the primary limitation on test accuracy is the temperature coefficient of the device under test. The

exact coefficient encountered varies from zero to  $0.7\%/^{\circ}\text{C}$ , depending upon how close the test current is to the FET zero-temperature-coefficient point. The circuit-oriented accuracy limitations are the same as those encountered with the corresponding elements in the beta-measuring circuit described earlier. The test bandwidth is again dc to 10 kHz.

### Testing breakdown

The breakdown voltage of a transistor is not a very precisely defined quantity because it varies in several ways with the current flow under breakdown conditions. Therefore, following the same reasoning as in the two preceding measurements, it is desirable to set the current level at which the breakdown voltage is measured.

Such testing is performed readily with an op amp as illustrated in Fig. 3 for several cases. The op-amp output increases the voltage on the device under test until the device breaks down and allows a feedback current to flow to the amplifier input. Then, the amplifier input voltage and current are returned to zero, and the breakdown current,  $I_{BV}$ , will be  $I_{BV} = V_+/R$ . Any breakdown voltage can be tested in this manner by connecting the appropriate device terminals between the op-amp input and output. The connection polarity is that which results in breakdown with a current flow into the terminal connected at the input.

Errors in this breakdown voltage are negligible for the measurement accuracies normally desired. Test accuracy is maintained at low current levels until the in-

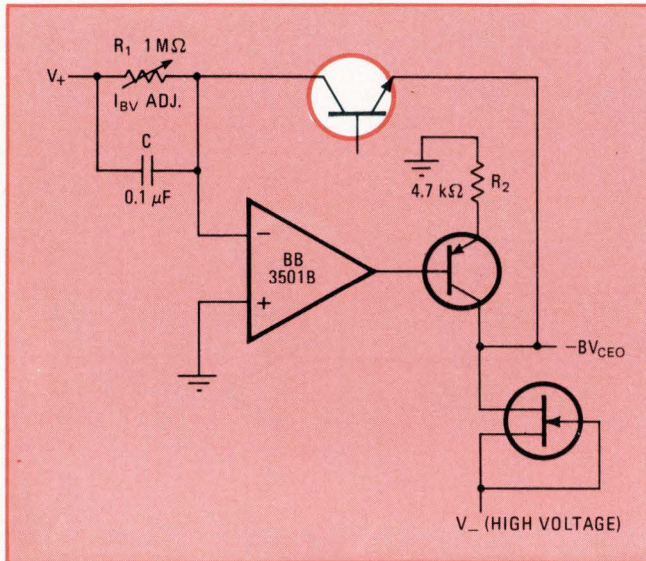

**4. Gain stage.** For transistors with high breakdown voltages, output voltage of operational amplifier can be boosted by adding a common-emitter amplifier and a FET current-source load.

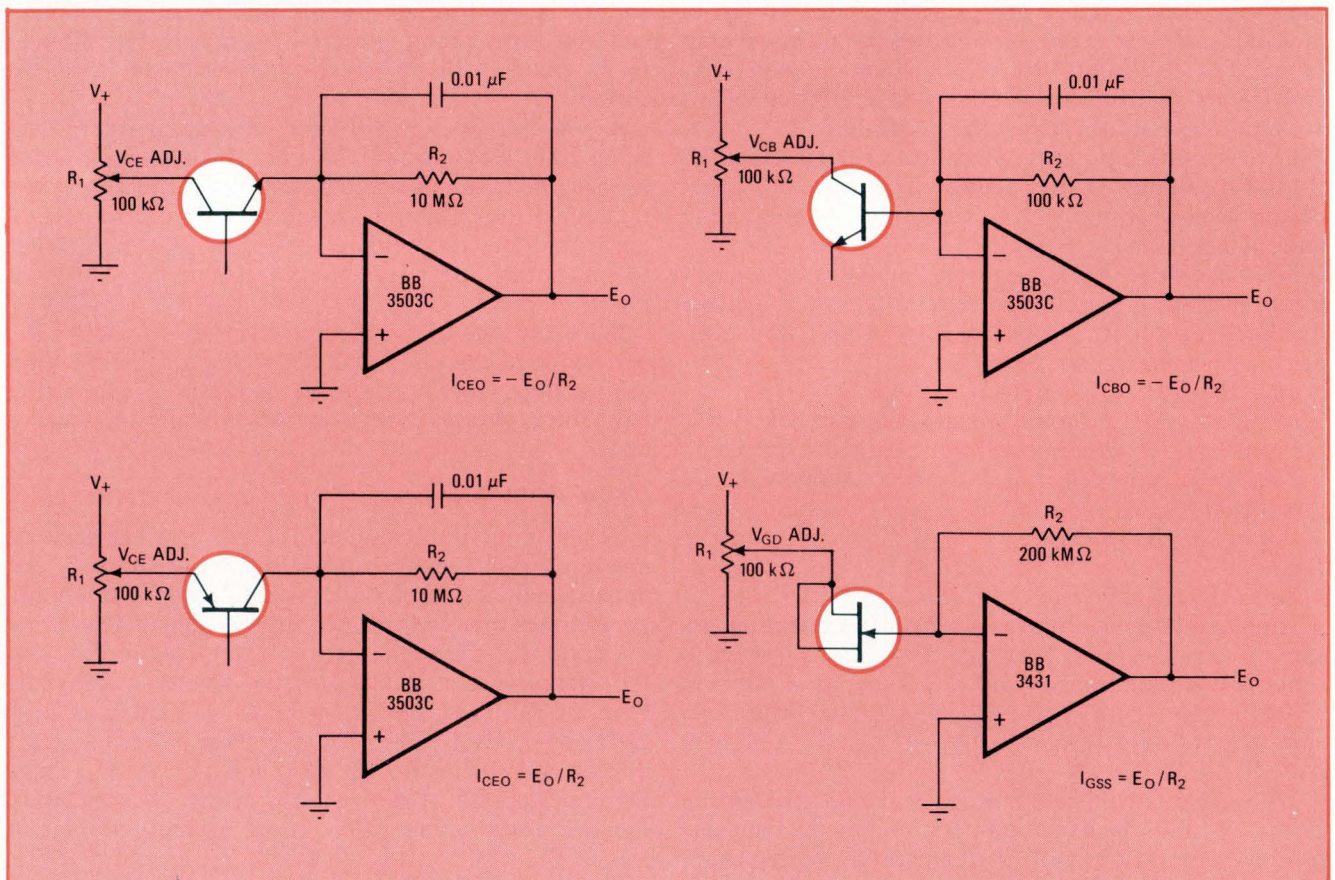

**5. Measuring leakage.** In each of these circuits, output voltage is directly proportional to leakage current in the feedback path. For accurate measurements, op amp input bias current must be negligible compared to leakage current of transistor under test.



put bias current of the op amp becomes significant. Since this limit can be quite low, breakdown testing at very low currents is possible for close examination of junction quality. However, the range of voltages accommodated in this test is more limited. The limitation is the output voltage range of the op amp. Hence, a high-voltage amplifier is required for this type of testing.

Often, even a high-voltage op amp cannot supply sufficient voltage for a breakdown test. In that case, the voltage range can be extended by adding some voltage gain after the amplifier, with a common-emitter transistor driving a FET current-source load (Fig. 4). By using the FET, both high gain and a current-limited output are achieved simply. Output current drawn through the test device is limited to the  $I_{DSS}$  of the FET. Further voltage range improvement can be achieved with a stacked output stage<sup>1</sup>. By stacking output transistors in series, the voltage range can be made greater than the breakdown levels of these transistors.

### Leakage-current checks

Very low leakage currents of silicon bipolar transistors and FETs present a significant measurement challenge. Bipolar transistor leakages of 0.1 nanoamperes and FET leakages of 0.1 picoamperes are now attained. Such low current levels can not be measured on most curve tracers or specialized transistor testers, but the op amp readily permits their measurement, as demonstrated in Fig. 5. In each case, the leakage current flows in the amplifier feedback path to develop an output voltage directly proportional to the leakage current. Feedback constrains one terminal of the device under test to zero voltage at the amplifier input. Then, the bias voltage is established by a potentiometer which controls the voltage at the other device terminal.

The principal limitations on the test accuracy and test-current range are the input-bias current of the op amp, stray leakages, and noise. To avoid input bias-current errors, which add directly to the leakage current, the op amp is chosen to have a negligible input bias current. For most bipolar transistor leakage-current testing, a FET-input op amp will do the job. When testing FETs, a varactor-input op amp and a very high feedback resistance are required.

For all cases, stray leakages should be minimized by keeping all insulating surfaces clean and isolating the test circuit from supply or bias voltages.

To reduce noise, various degrees of shielding and filtering are needed. In general, bypassing the feedback resistor provides adequate filtering—as is provided in the FET test circuit by the parasitic capacitance of the 200-megohm resistor.

### Measuring output conductance

For high gain in common-emitter amplifiers, high-resistance loads are used. The ability of a bipolar transistor to drive a high-resistance load is expressed by its output conductance,  $h_{oe}$ . To measure  $h_{oe}$ , the slope of the common-emitter characteristic curve can be calculated by using a curve tracer. Alternately, this small slope can be measured accurately and quickly with the circuit of Fig. 6.

Basically, this test circuit provides an output voltage

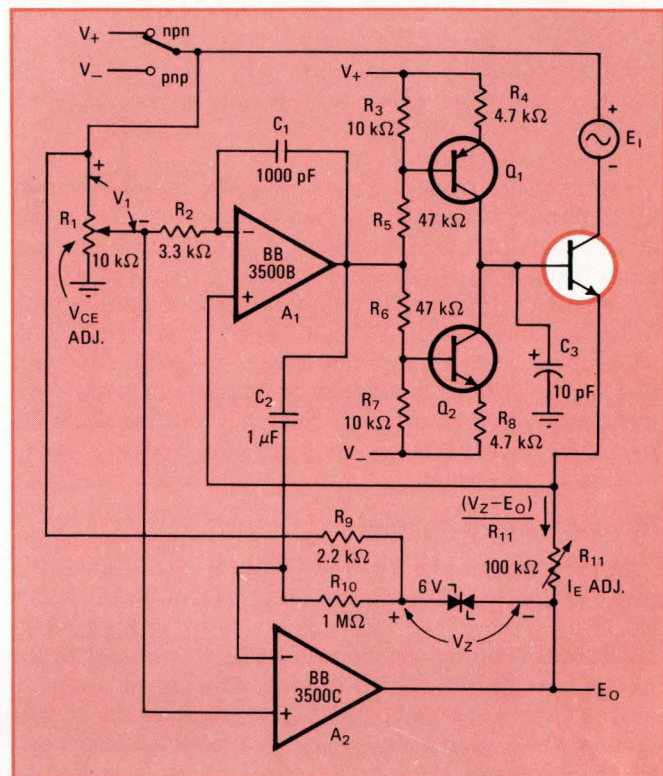

6. Measuring  $h_{oe}$ . Output conductance of a bipolar transistor is a measure of its ability to drive high-resistance loads. Since  $h_{oe}$  is a small-signal parameter, ac coupling must be used.

proportional to the change in emitter current induced by a change in collector-emitter voltage. The collector-emitter signal voltage is established by  $E_1$ , the emitter signal current is supplied by  $E_0$  from  $A_2$ , and biasing is set by  $A_1$  and  $A_2$ . Biasing the base of the test transistor is a differential current source formed with  $Q_1$  and  $Q_2$  and controlled by  $A_1$ . With current-source base bias, the biasing impedance will be much greater than the load impedance presented by the transistor. Then, the output conductance measured will be the worst case value,  $h_{oe}$ . Op-amp feedback around the current sources from the test transistor emitter forces the emitter voltage to equal that presented by  $R_1$ . This sets the dc collector-emitter voltage,  $V_{CE}$ , at  $V_{CE} = V_1$ .

The other op amp is also biased from  $R_1$  so that the adjustment of  $V_{CE}$  does not affect the emitter bias current,  $I_E$ . As  $R_1$  causes  $A_1$  to vary the test transistor emitter voltage, this potentiometer also causes  $A_2$  to vary identically the dc voltage at the other end of the emitter resistor,  $R_{11}$ . No change in emitter-resistor voltage results, and  $I_E$  is unaffected. Instead, the dc voltage on  $R_{11}$  is established by the zener diode in the feedback around  $A_2$ . The zener drops the dc output voltage of  $A_2$  below its input voltage, which is also the emitter voltage. Then  $I_E = V_Z/R_{11}$ .

If the output voltage of  $A_2$  were only a fixed dc level, the emitter signal currents created by variations in  $V_{ce}$  would not develop. Instead, the feedback provided by  $A_1$  would drive the base to hold the emitter voltage constant and would thereby eliminate the very current which is to be measured.

The desired emitter signal is restored by ac coupling

of the output of  $A_1$  to the input of  $A_2$ . The ac output of  $A_2$  drives  $R_{11}$  to supply the signal current and to present a buffered output for measurement. This yields  $I_e = E_o/R_{11}$  and an  $h_{oe}$  given by the ratio  $I_e/V_{ce}$ . In other words,

$$h_{oe} = E_o/R_{11}E_1.$$

Other than errors in  $E_1$  and  $R_{11}$ , the major accuracy limitations are the gain and bandwidth of  $A_2$ . To supply all of the emitter signal current,  $A_2$  must have a current gain through  $R_{11}$  that is much greater than the beta of the transistor tested. This commonly sets the upper limit of the test bandwidth at about 200 hertz. A lower bandwidth limit is similarly imposed by coupling capacitor  $C_2$ . Within this bandwidth, it is possible to make low-frequency  $h_{oe}$  measurements which avoid the stray capacitance hysteresis looping encountered on curve tracers at low current.

### Measuring $r_{ds}$ is simpler

Somewhat simpler than  $h_{oe}$  testing is the measurement of the drain-source resistance,  $r_{ds}$ , of a FET, which is the measure of the FET's ability to drive high-resistance loads. The  $r_{ds}$  test circuit of Fig. 7 is similar to the  $h_{oe}$  test circuit, but a high driving impedance is not required for the FET gate. Once again,  $A_1$  fixes the dc bias voltage at  $V_1$ , giving  $V_{DS} = V_1$ . The feedback zener sets the dc voltage on the source resistor giving  $I_s = V_z/R_2$ . As before,  $A_2$  supplies the signal current, which is now  $I_s = E_o/R_2$ , and the drain-source resistance is given by  $r_{ds} = E_1R_2/E_o$ .

The accuracy of this result is limited by errors in  $E_1$  and  $R_2$  and by the gain of  $A_2$ . The current gain through  $A_2$  and  $R_2$  must be much greater than the  $g_{fs}$  of the FET to have  $E_o$  supply all of the signal current. The measure-

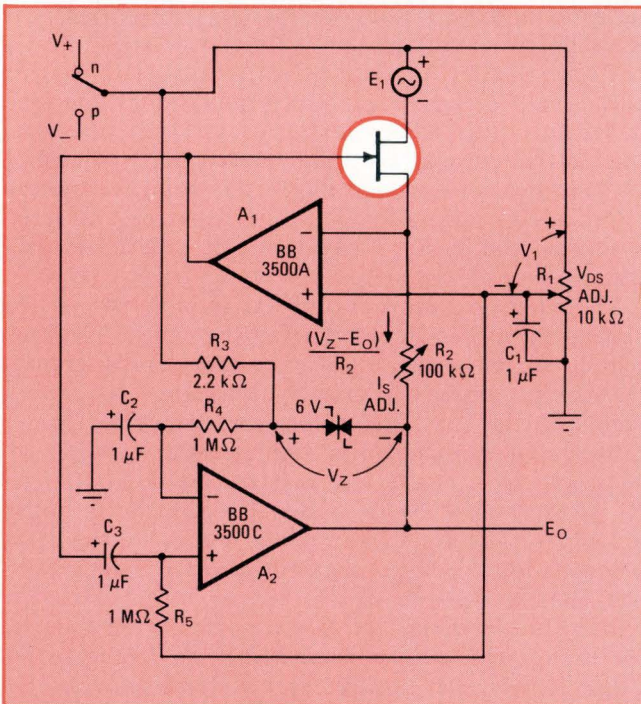

**7. Measuring output resistance.** Drain-source resistance  $r_{ds}$  of a FET—like  $h_{oe}$  of a field-effect transistor—is a measure of its ability to drive high-resistance loads. This test circuit is useful for checking frequency range of about 20 Hz to 20 kHz.

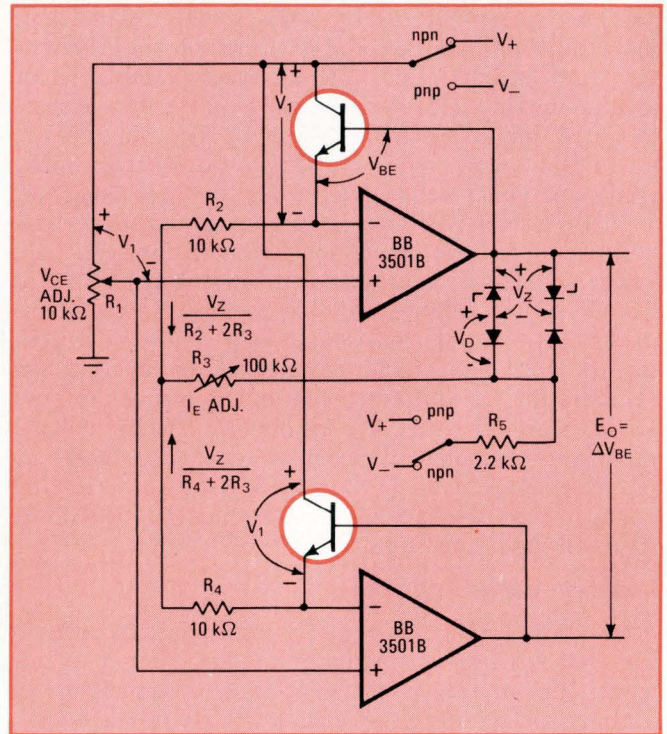

**8. Matchmaker.** Matching two devices involves measuring differences between their base-emitter (or gate-source) voltages when emitter (or source) currents are the same. Since this voltage is temperature-sensitive, it's extremely important to match thermal environments of the two transistors as closely as possible.

ment bandwidth thus extends from about 20 Hz to about 20 kHz.

### Matching transistors

Matched pairs of bipolar transistors or FETs are essential for the construction of differential amplifier stages with low dc errors and low thermal sensitivities. Such transistor pairs are matched in either emitter-base voltage,  $V_{BE}$ , or gate-source voltage,  $V_{GS}$ . Elementary biasing is not generally suitable for matching purposes because a mismatch in  $V_{BE}$  or  $V_{GS}$  will create a compensating current imbalance between the two transistors. Op amps can remove this interdependence.

The op-amp matching circuit (Fig. 8) makes the current balance between the transistors independent of the difference between their emitter-base voltages. The individual bias currents and voltages are also independently controlled. Although shown with bipolar transistors, the same circuit provides  $V_{GS}$  match testing for FETs. To set the two collector-emitter bias voltages,  $R_1$  sets the voltage at the inputs of both amplifiers and, thereby, at the two emitters. This gives  $V_{CE} = V_1$ . With emitters at the same voltage, the base voltages will differ by  $\Delta V_{BE}$ ; mismatch is measured as  $E_o = \Delta V_{BE}$ .

For the above output voltage to represent the transistor mismatch, the emitter currents must be identical. Feedback sets the two emitter currents as the op amps drive the transistors to accept the currents supplied by  $R_2$  and  $R_4$ . These resistors carry emitter currents derived from the zener diode voltage  $V_z$ . Since the diodes are referenced to one amplifier output, rather than ground, changing  $V_1$  does not alter the voltage on the

current-setting resistors,  $R_2$ ,  $R_3$ , and  $R_4$ . The voltage across  $R_2$  and  $R_3$  is  $-V_{BE} + V_Z + V_D$ . Since the diode voltage  $V_D$  will approximately cancel  $-V_{BE}$ , the drop on  $R_2$  and  $R_3$  is  $V_Z$ , as is the drop on  $R_4$  and  $R_5$ . For  $R_2 = R_4$ , the emitter currents are equal:

$$I_E = V_Z / (R_2 + 2R_3) \text{ and } I_E = V_Z / (R_4 + 2R_3).$$

The dominant measurement errors are those created by the differences in the op-amp offset voltages, in the emitter resistors,  $R_2$  and  $R_4$ , and in the temperatures of the two transistors. A difference in input offset voltages,  $\Delta V_{OS}$ , results in an identical difference in the transistor emitter voltages to produce an output error equal to  $\Delta V_{OS}$ . To remove this error,  $E_O$  is nullified by adjusting one of the op-amp offset-voltage potentiometers when the emitter-base junctions are shorted. Normally, this adjustment will have to be made only initially when the circuit is built and tested. A difference between  $R_2$  and  $R_4$  creates a  $\Delta V_{BE}$  error. The error, which is caused by a current imbalance, is given by <sup>2</sup>

$$\Delta V_{BE} = 25 \text{ mV} \ln [I_E / (I_E + \Delta I_E)].$$

Since the currents in this expression are directly determined by the resistors, the expression may be rewritten in terms of the resistances as

$$\Delta V_{BE} = 25 \text{ mV} \ln [(R + \Delta R) / R]$$

where  $R$  is the average of  $R_2$  and  $R_4$ . For small unbalances, the above resistance ratio is near unity, and the logarithm may be expanded to yield

$$\Delta V_{BE} = 25 \text{ mV} (\Delta R / R) \text{ for } \Delta R \text{ is much less than } R.$$

This result indicates that an emitter resistor mismatch of only 1% will produce a  $\Delta V_{BE}$  error of 0.25 mV. Removal of this error is accomplished by adjusting  $R_2$  and  $R_4$  until interchanging the two transistors creates only a reversal in the polarity of  $E_O$ .

Another  $\Delta V_{BE}$  error is produced by the difference in transistor temperatures,  $\Delta T$ . From the  $-2 \text{ mV}/^\circ\text{C}$  thermal sensitivity of a silicon junction, the resulting error is

$$\Delta V_{BE} = -(2 \text{ mV}/^\circ\text{C}) \Delta T$$

Just a  $0.1^\circ\text{C}$  difference results in a 0.2 mV error, so thermal conditions must be very well matched. Matching of the thermal environments of the two transistors is improved by using adjacent test sockets and by avoiding

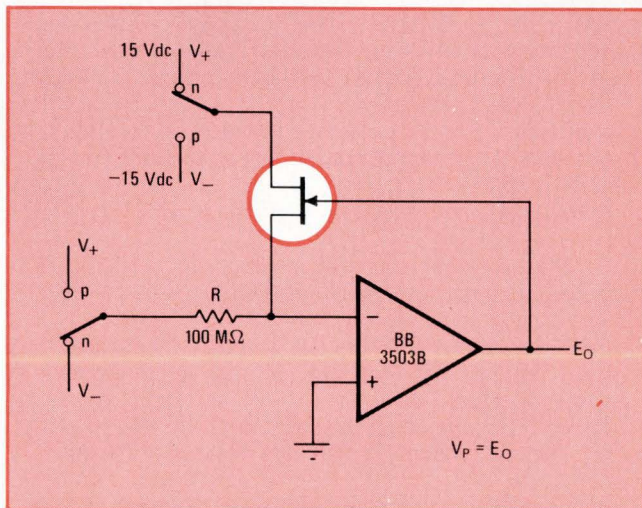

**9. Measuring  $V_p$ .** This circuit measures the pinch-off voltage,  $V_p$ , of a FET by measuring transistor's  $V_{GS}$  with extremely small source current. The 100-M $\Omega$  resistor makes  $I_S$  small enough so that  $V_{GS}$  is excellent approximation of  $V_p$ .

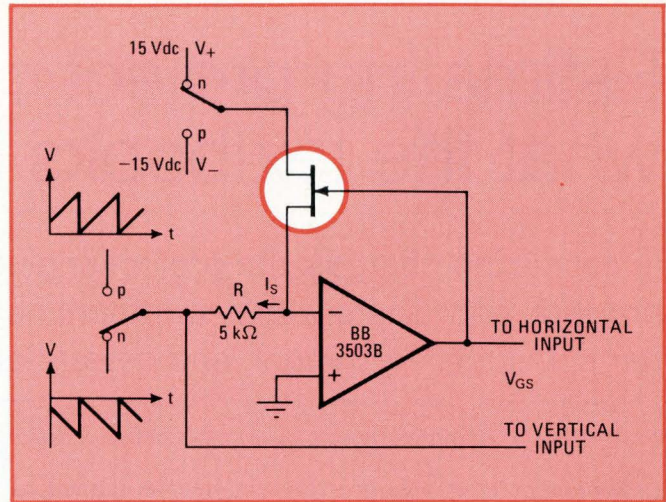

**10. Added scope.** Scope and a ramp generator added to measuring circuits provide display of any selected parameter dependency. One example:  $I_S$  versus  $V_{GS}$  is used to determine FET's zero temperature-coefficient point as the temperature is varied.

air drafts or nearby thermal radiation. If each of the above error sources is controlled, the over-all measurement error may be reduced to 0.1 mV.

### The pinch-off

To measure the pinch-off voltage,  $V_p$ , of a FET, the current in the FET must be nearly pinched off. The remaining low current level is sensitive to voltmeter loading, but can be buffered with an op amp which also biases the transistor (Fig. 9). With the FET source voltage driven to zero at the op-amp input, the output voltage is  $V_{GS}$ . This voltage is approximately equal to  $V_p$  for the small source current supplied through the 100-megohm resistor.

### Getting the picture

When a ramp generator and an oscilloscope are connected to any of the preceding circuits, the various parameter dependencies can be displayed as functions of a desired parameter. For example,  $I_S$  versus  $V_{GS}$  can be displayed and the temperature varied to locate a FET zero temperature coefficient point. Or beta can be examined as a function of  $I_C$  to determine the usable current range of a transistor. Similarly,  $g_{fs}$  versus  $I_S$  can be displayed for a FET. More conventional traces, such as the current-voltage characteristic of a junction, are also possible.

As an example, consider the display of  $I_S$  vs  $V_{GS}$  (Fig. 10). Just as in Fig. 9, the op amp output voltage is the gate-source voltage being measured. This voltage is displayed with respect to the ramp voltage that sets the source current. The most common source of error in this type of display is the nonlinearity of the sweeping ramp. This consideration is not very serious because a nonlinearity of 0.25% is acceptable in most practical situations, and such a ramp is easily produced with op-amp circuits.<sup>3</sup>

### REFERENCES

1. J. Graeme, G. Tobey, and L. Huelsman, *Operational Amplifiers: Design and Application*, McGraw-Hill Book Co., New York, 1971, p. 110.
2. op cit, p. 53.
3. op cit, p. 375.

# Estimating project costs— what the textbooks don't tell

In estimating charges, the project engineer must clearly define the product, coordinate with department heads, try to split costs of parts and test equipment, and beware of losing profits to inflation

by Thomas T. Samaras, *Universal Monitor Corp., Pasadena, Calif.*

□ Sooner or later, nearly every engineer is tapped to prepare an estimate of how much it will cost to develop and manufacture some kind of product. The basics of putting together such an estimate are well known, or at least they are not difficult to learn. But recognition of the most subtle aspects of the task will prevent non-competitive bids or overruns in costs.

The first pitfall is inadequate preparation. Too many engineers jump right into assembling costs for required components without first clearly defining the product, as well as what must be provided to the customer along with the hardware—documents, travel for periodic design reviews, and training of operators, for example.

If these costs grow too high, the engineer may even want to consider a hardware redesign to hold down total project costs. The flow chart of Fig. 1 lays out the best route to follow. The key point is to avoid a provincial engineering viewpoint that dwarfs or ignores the non-engineering tasks.

## Coordination

In following the steps laid out, there's no substitute for a coordinated approach to the job. The engineer himself is the coordinator during the estimate phase. He must negotiate with supervisors of other departments to be sure they understand the scope of the project and what is expected of them. The project chief must set a fixed time for submission of the estimates from other departments. And he should confer regularly with accounting and purchasing department personnel to get latest information on overhead rates, component costs, and delivery dates.

Contingency factors, which are present in high-risk projects, can trap the unwary into inflated total estimates because some department heads will include their own contingency factors in estimates they deliver. Although different departments usually require different contingency factors, these self-protective moves can raise prices out of the competitive range. The only way around this pitfall is close coordination with department heads to be sure exactly how all charges are estimated. If used at all, a reasonable contingency factor might be 10% to 30% of total costs.

The fundamental ingredient in most job costs is labor. On a complicated project, or when much work must be done in a short time, the project engineer will probably have his hands full with only the technical de-

## Glossary cost estimating terms

*Contingency:* a special allowance above estimated fundamental costs to cover possible unforeseen expenses. Used when uncertainties create a high-risk project.

*Direct costs:* costs that can be identified with a particular project or effort. Include labor, materials, subcontracts, consultants and purchased equipment.

*Other direct costs (ODC):* smaller costs elements, including travel, overtime, computer time, document reproduction, special tooling, transportation, and consultant services.

*Indirect costs:* costs that cannot be clearly identified with a particular project. Include overhead and general and administrative (G&A) expenses.

*General & administrative (G&A):* a percentage added to direct and overhead costs to cover such indirect expenses as management, secretarial, purchasing, sales accounting and general supplies. Rate may vary during the year.

*Overhead:* a percentage added to direct labor costs to cover indirect costs of supplying products (also called burden). Includes rent, engineering supplies, depreciation, and maintenance costs. Different rates can exist for engineering, quality control, and manufacturing functions. Different rates may prevail for different times of the year.

*Fee:* profit or payment to the company for supplying equipment or services. Added to the total cost after overhead and G&A costs have been added. Management usually sets fee rate.

*Nonrecurring costs:* costs due to one-time non-repetitive work, engineering, special test equipment, tooling and fixtures.

*Price:* total amount paid by customer; sum of fee and cost.

*Purchased equipment:* relatively high-priced items installed into product, such as test equipment, minicomputers, and motors.

*Purchased parts:* commercially available items used to build product, such as active and passive components and connectors.

*Recurring costs:* costs that vary in proportion to output. Include production materials, testing, and inspection costs.

*Subcontract costs:* costs due to procurement of outside services or major parts that are subject to company design and control.

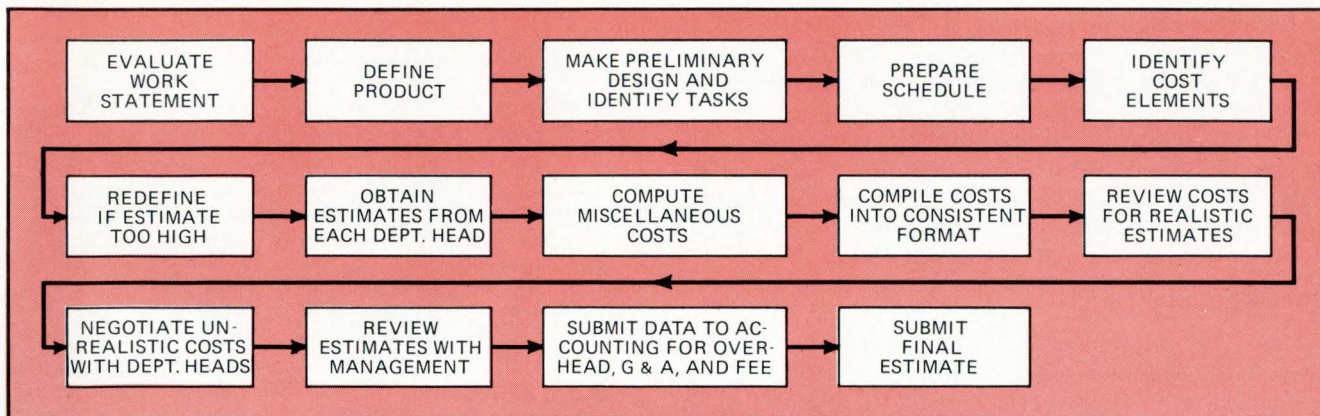

1. **Best route.** Steps in assembling cost estimate show importance of coordination with other department heads.

tails. In these cases, a full-time coordinator, drawing perhaps a senior engineer's salary, may be needed to assure that all details are being handled properly. This man's time must be included in the labor estimate.

How many total man-hours will it take to complete the job? That is a simple enough question, but many engineers overlook the fact that the question covers not only the number of man-hours of, say, engineering, but also particular engineers. Usually, when an engineer estimates the number of labor hours, he bases his figures on certain personnel within the company whose abilities he knows. If all have about average creativity and productivity, any available personnel may be used, and there'll be no difference in costs. However, if the estimate is based on the availability of one or more particularly productive individuals, it's wise to make it clear to management that if these persons won't be available, additional time and money will be needed to compensate for lack of ability in the substitutes.

### Parts

When it comes to parts, quantity discounts can be obtained if other groups in the plant can also use the same items. The purchasing department can provide data on the amounts of money that can be saved on buys of various quantities. On the other hand, parts cost will increase significantly if special testing is required to assure high reliability. It is not unusual for testing costs to triple the catalog prices of standard parts.

### Test equipment

New test or manufacturing equipment required for a project constitutes one of the grayest areas in cost estimating. If such equipment can be used on other projects, these costs can be shared—just as in volume buying of parts—and only a portion of the cost need be included in the estimate. However, several department heads must frequently share costs before the engineer can trim his own share to an acceptable level.

Custom-made test sets usually account for only a small fraction of a project's cost. But for unconventional projects, such as an instrument for measuring concentrations of environmental constituents, unique input signal simulators may be needed to evaluate the product's performance. In such a case, the cost of a specialized test setup can become a major factor.

For example, a recent estimate for the design, devel-

opment, and production of an instrument included environment simulator costs as high as 16% of the total project cost, with costs of special test sets accounting for another 10% of the total. Thus, the combined cost of test equipment represented more than a quarter of the total project outlay.

### Computer costs

In the same way that special tooling imposes high costs on custom-made parts, computer demands may incur unexpectedly large expenses. If the project requires use of a computer, the engineer should estimate how many hours of operation will be needed and the rate of charge. The estimate should not be based on hourly charges alone—setup time will probably impose a minimum charge for each computer use, even though the run itself may require less time.

Computer operation may require many hours of engineers' time to prepare input data, as well as coordination with computer programming and operating personnel. These costs may soar if simulation is required to optimize designs. There is also key-punching of data to be considered. And, perhaps most significant of all may be the costs of initial programming and debugging. Expert advice is therefore mandatory when estimating computer costs.

### Travel

Large expenses can be added to a project by necessary travel to coordinate with the customer, vendor, and subcontractors, especially if the trips cover long distances. The planner should ascertain who must be visited during the project, their locations, how often visits must be made, and mode of travel for each. The number of persons to make each visit should be estimated. A conference at a major subcontractor's facility may require six or seven engineers. In addition to travel and lodging, provisions must be made for such expenses as food, telephone, and local transportation.

In preparation for these trips, illustrators may be needed to prepare flip charts, projection flats, and other graphic materials. Shop time may be required to prepare models. Costs will often be multiplied by two or three design reviews during product development.

If the product is a sensitive instrument or machine that needs protection from damage or deterioration, a necessary but expensive storage case may be overlooked

in the original estimate. Besides material costs, considerable design time may be necessary to determine the best case material and configuration, packing material, pressure valves, latches, and similar factors.

Additional manufacturing time may be needed to assemble or modify a purchased case, mark it, and perform other operations. Thus, even for a small production run of 20 instruments, the total cost of carrying and storage cases can run to thousands of dollars.

### Documentation

Costs of documentation are commonly underestimated. Although some companies write off documentation costs as indirect charges, these costs, when considered, can easily inflate project costs. Charges for photographs, artwork, reports, manuals, schedules, and other documentation can easily elude the unwary. However, these costs frequently can be minimized by using existing documents, such as drawings and test procedures, salvaged from similar projects.

### Design changes

Just as inflated contingency factors can kill an estimate at the start, subsequent engineering changes can batter the budget after the project is underway. The project engineer may provide for requests for additional

#### CHECK LIST OF TASKS INVOLVED IN TYPICAL DESIGN CHANGE

##### Direct costs:

- Complete preliminary design
- Change control/evaluation board review
- Prepare engineering change proposal and coordinate with affected parties, including customer
- Breadboard, evaluate, and redesign improved circuit, component assembly, etc.
- Revise schematics, assembly drawings, parts lists, wiring diagram, etc.
- Release, issue, and file drawings, parts lists, and other documents
- Revise design and product specifications
- Revise manufacturing instructions and coordinate with assemblers
- Redesign and rebuild test fixtures
- Modify test equipment design and construction
- Buy new parts for entire production run (includes time to prepare and process purchase requests, handle parts, etc., before release for fabrication)
- Qualify new parts for high reliability requirements (e.g., thermal, vibration, and shock tests)
- Build new subassemblies
- Inspect new subassemblies
- Test new subassemblies
- Revise operators manual
- Revise test procedures
- Recompute reliability estimate
- Retrofit delivered products
  - Pack and ship back to company
  - Build new subassemblies
  - Inspect new subassemblies
  - Test new subassemblies
  - Install new subassemblies
  - Final-test products
- Pack and ship products to customer

Total direct costs

##### Indirect costs:

- Overhead
- Labor plus overhead
- Materials/subcontracts
- Burdened labor plus materials/subcontracts
- Add G & A
- Costs with G & A included
- Add fee

Total direct costs

Grand total

### Typical cost estimate

The estimate is prepared in three basic parts: direct costs (labor, parts and materials, subcontracts, and purchased equipment), indirect costs (overhead and general and administrative), and fee. The estimates are broken down into nonrecurring and recurring costs so that subsequent production costs can be determined easily.

Cost Element	Nonrecurring	Recurring	Total
Labor	\$6,000	\$20,000	\$26,000
Overhead (burden) (50% of labor cost)	3,000	10,000	13,000
<b>Subtotal (1)</b>	<b>\$9,000</b>	<b>\$30,000</b>	<b>\$39,000</b>
Parts & materials	\$4,000	\$30,000	\$34,000
Subcontracts	2,000	6,000	8,000
<b>Subtotal (2)</b>	<b>\$6,000</b>	<b>\$36,000</b>	<b>\$42,000</b>
Other direct costs			
Consultants	\$1,000	\$500	\$1,500
Travel	500	2,000	2,500
Publications	500	1,500	2,000
<b>Subtotal (3)</b>	<b>\$2,000</b>	<b>\$4,000</b>	<b>\$6,000</b>
<b>Subtotal</b>	<b>\$17,000</b>	<b>\$70,000</b>	<b>\$87,000</b>
G & A (25% of above subtotal)	\$4,250	\$17,500	\$21,750
<b>Subtotal</b>	<b>\$21,250</b>	<b>\$87,500</b>	<b>\$108,750</b>
Fee (10% of above subtotal)	\$2,125	\$8,750	\$10,875
<b>TOTAL</b>	<b>\$23,375</b>	<b>\$96,250</b>	<b>\$119,625</b>

funds if and when changes are recommended, or he can supplement the basic estimate with projected additional costs.

It's wise to make clear to the customer that uncertainties of final design do not indicate a lack of definition of the product, but are common in most phases of product development. Table 1 shows a list of typical items involved in a design change after a product is in production and some units have been delivered to the customer. And, depending on the particular situation, the list may be expanded to include such items as changes in computer program tapes, worst-case analysis, spare parts, training devices, maintenance equipment, operator retraining, and special tooling.

The project engineer can obtain help on design changes from experts in his own company. In a large firm, a formal design evaluation board, composed of experts in each key technical and purchasing area, will assess the impact of each proposed design change in terms of cost effectiveness. In a smaller company, the project engineer can organize his ad hoc evaluation committee from experts in the various departments.

And finally—Phase 2 notwithstanding—the project engineer must beware of the probability of inflation before completion of a long-term project that will cover a year or more. On a \$100,000 project, inflation can tack on a few more thousand dollars and cut the profit from, say, \$10,000 to \$7,000—a 30% reduction □

ONLY SOLITRON OFFERS THESE

# 10 AMP 200 VOLT

INDUSTRIAL POWER TRANSISTORS

# FOR UNDER \$5.00\*

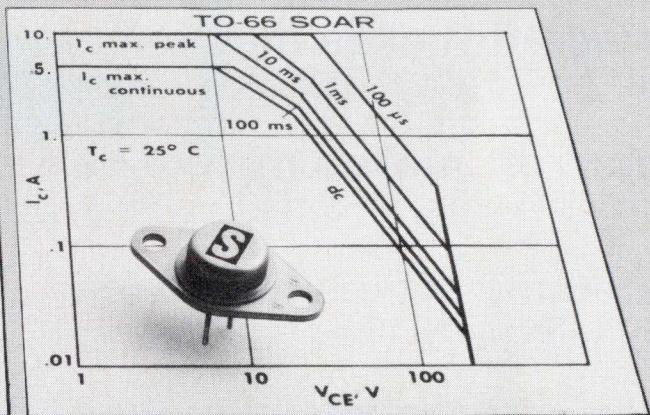
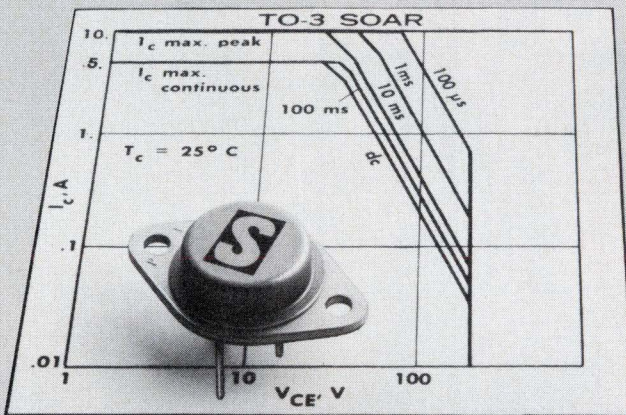

Solitron's low-cost series of 10 Amp Silicon NPN Power Transistors now replace many expensive hi-rel industrial devices. They provide the same performance characteristics and cost only one-half the price of other units.

These versatile transistors are available in a wide range of TO-3 (SDT 1611-1638) and TO-66 (SDT 1641-1668) packages with multiple gain selections and  $V_{CEO}$ 's from 40V to 200V. Features include multiple diffused planar process for excellent reliability; excellent fast-switching characteristics, with low turn-off time; and Safe Operating Area (SOAR) specified for forward and reverse-biased operation.

\*IN LARGE QUANTITY ORDERS

For complete information, prices and engineering application assistance, dial toll-free 1-800-327-3243. Or write:

# Solitron

DEVICES, INC.

1177 BLUE HERON BLVD. / RIVIERA BEACH, FLORIDA / (305) 848-4311  
TWX: (510) 952-7610

SAN DIEGO, CAL.  
8808 Balboa Avenue  
FET & Dual FET  
Transistors  
MOS/FET Devices  
MOS Memory Arrays  
Shift Registers  
Monolithic IC's  
Small Signal  
Transistors

RIVIERA BEACH, FLA.  
1177 Blue Heron Blvd.  
Hi-Rel Power Transistors  
SI & Ge. Power  
Transistors  
Hi-Rel Power Hybrids  
PNP-NPN Industrial  
Transistors

PORT SALERNO, FLA.  
Cove Road  
Microwave Connectors  
Plaxial (R) Cable  
Precision RF Coaxial

JUPITER, FLA.  
1440 W. Indiantown Rd  
Microwave Stripline  
Components  
Microwave Semiconductor  
RF Semiconductor  
Microwave Integrated  
Circuits

TAPPAN, N. Y.  
256 Oak Tree Road  
Diodes & Rectifiers  
Zeners  
High Voltage  
Assemblies  
Power Rectifiers  
Thick Film Hybrid  
Circuits  
Ferrite & Ferrite Devices  
Film Resistors

KENT, ENGLAND  
Tubbs Hill House  
London Road,  
Sevenoaks  
Solidev, Ltd.  
Full line of  
Solitron devices

BEN BARAQ, ISRAEL  
51 Hayarkon Street  
AEL Israel, Ltd.  
Full line of  
Solitron devices  
Trading  
Full line of  
Solitron devices

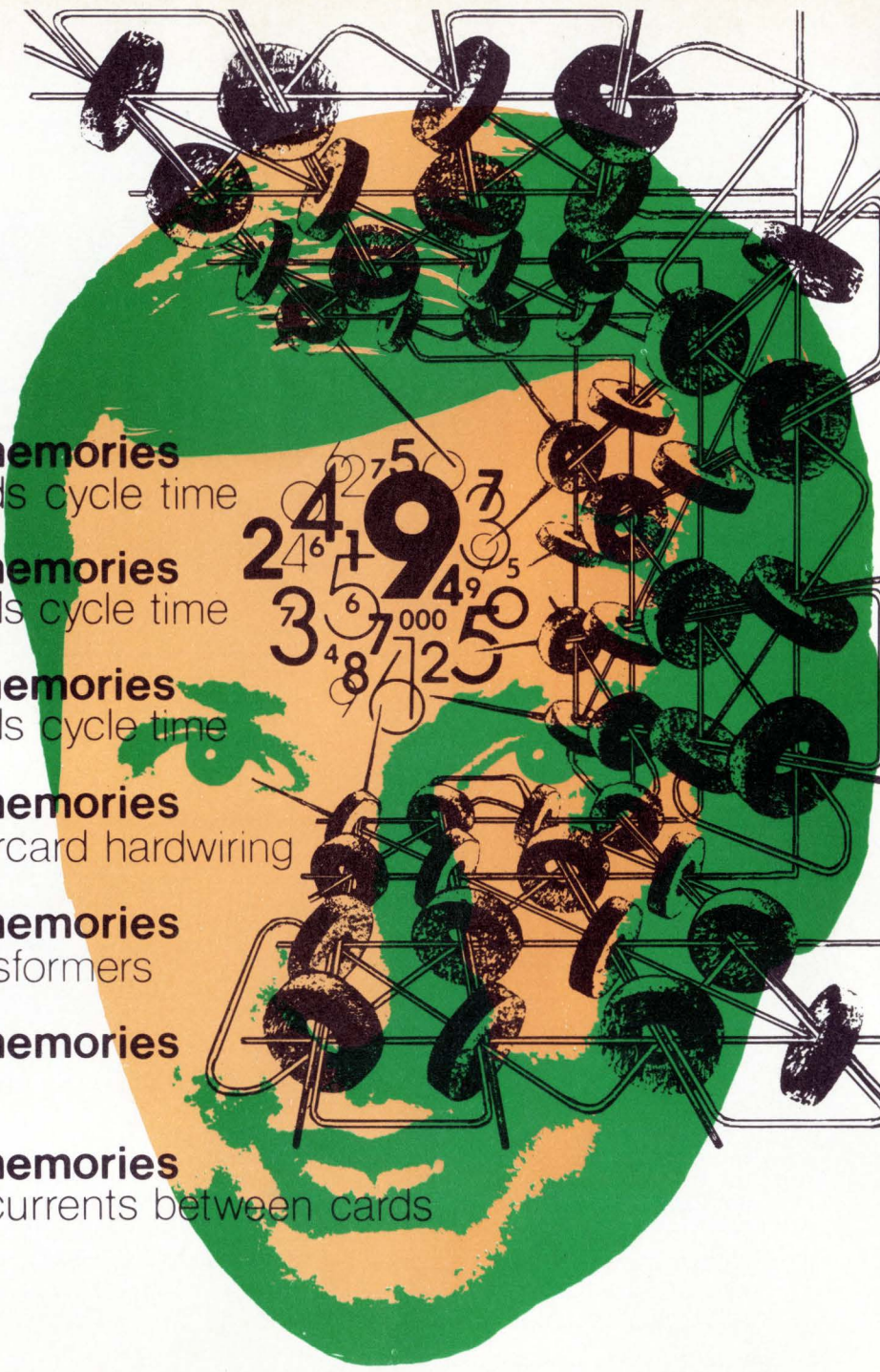

**Datacraft makes memories**  
with 900 nanoseconds cycle time

**Datacraft makes memories**  
with 750 nanoseconds cycle time

**Datacraft makes memories**  
with 650 nanoseconds cycle time

**Datacraft makes memories**  
that eliminate all intercard hardwiring

**Datacraft makes memories**  
that eliminate all transformers

**Datacraft makes memories**  
that eliminate risers

**Datacraft makes memories**  
that eliminate drive currents between cards

**Now, do you sincerely believe you can miss calling Datacraft?**

**call (305)974-1700**

Or if you like, write for our brochure, "Inside the DC-38."

***Datacraft*** Room 201 Post Office Box 23550 Fort Lauderdale, Florida 33307



# Probing the news

Analysis of technology and business developments



## Uhf tuner makers vie for profits

Manufacturers face deadline to meet FCC specifications on models using varactors or memory and non-memory electromechanical designs

by Marilyn Offenheiser, New York staff

**Manufacturers of ultrahigh** frequency television tuners are touting their entries in competition for a market that's expected to triple to 15 million units by 1974. Three different tuner designs are being advanced by the makers, spurred in part by Federal Communications Commission prodding to make uhf tuning more accurate: electromechanical non-memory and memory units, plus all-electronic varactor diode tuners. And the advocates of each type are vocal in presenting their cases because each tuner manufacturer hopes his design will become the industry standard.

By July, the FCC requires that 40% of the TV sets in any manufacturer's line must comply with one of the three approved uhf tuner designs. Two years ago, when the FCC said uhf tuners had to be as accurate as tuners for vhf channels, it approved use of varactor diode and memory-type tuners to achieve that accuracy. Then last November, the

FCC approved a third contender, a 70-position electromechanical non-memory device.

The 70-channel non-memory tuner, which costs \$1 to \$2, can pick up any of the uhf channels in the user's area, but it is not accurate enough yet to meet the FCC's ultimate standards. The electronic varactor tuner can tune in all 70 channels accurately, but it costs about \$15. Electromechanical memory tuners, which cost only \$2 or \$3, are accurate, but they can pick up only six or eight channels, and the tuner must be reset each time the set owner moves to another area.

Supporting the electromechanical 70-detent model is Sarkes Tarzian Inc., Bloomington, Ind., along with Japan's Matsushita (Panasonic) Electric Co. and Alps Electric Co. On the varactor side are Standard Kollsman Industries Inc., Melrose Park, Ill., Oak Manufacturing Co., Crystal Lake, Ill., ITT Semiconductor division, Lawrence, Mass.,

and Motorola Semiconductor Products division, Phoenix, Ariz. AEG-Telefunken, Englewood Cliffs, N.J., is banking on the memory tuner, and the F.W. Sickles division of General Instrument Corp., Chicopee, Mass., taking no chances, is providing all three.

Meanwhile some set makers are playing it cool, using all three tuners in different models across their lines, and letting the tuner maker work out the bugs. These are the Motorola Inc. Consumer Products division, Chicago, Admiral Corp., Chicago, and the Emerson TV and Radio division of National Union Electric Corp., Greenwich, Conn.

The RCA Corp., Consumer division, Indianapolis, is using varactors and 70-detents, while the Heath Corp., Benton Harbor, Mich., is providing only varactors in its construction kits. Japan's Sony and Matsushita are dropping the memory systems they now use in favor of the 70-detent, and New Nippon Electric

## Probing the news

Co., a Tarzian licensee also will use only 70-detents in its TV receivers.

The FCC, recognizing the design problems, has set up an ample timetable for compliance and has ruled that by July 1, 70-detent tuners must have a maximum deviation from accuracy per channel of  $\pm 3$  megahertz for one-half channel and numerical readout for all 70 channels. If vhf and uhf channels are displayed together, every other channel must be numbered.

By July 1, 1974, 70-detent tuners must be equipped with automatic fine-tuning circuitry and have an accuracy per channel of less than the pull-in range of the automatic frequency control to assure lock-in, regardless of the channel selected. What's more, by July 1973, 75% of the TVs in a manufacturer's line must comply with one of the three uhf designs; by July 1974, 100%.

**Presaging problems.** Although tuner makers say they can meet the  $\pm 3$  MHz requirement with the 70-detent, this design is beleaguered by controversies over accuracy, readout, short channel-tuning angle, inability to use remote control without remote fine tuning, and size. There is particular dissatisfaction over the fine-tuning standard set by the FCC. The Zenith Radio Corp., Chicago, supported by Matsushita, has already petitioned the FCC for a less stringent requirement. Tarzian, Sony, and GTE Sylvania, at Batavia, N.Y., say that afc is unnecessary, and that it adds additional cost to a job that manual fine tuning does almost as easily. And still pending at FCC headquarters is a petition from Philco-Ford Corp., Philadelphia, asking that the afc requirement for monochrome receivers be dropped.

The problem with readout is simply a matter of eyesight—it is difficult to read 70 numbers on a small dial. Tarzian is using a digital system on two dials, and Sony says it will use either a mechanical counter or a film strip moving on a spool. Other alternatives are to use window displays and to provide set owners with stick-on numbers.

As for tuning, detenting 70 channels on one gear hastens wear and causes channels to be skipped. Tar-

zian's Kevin Joyce, national sales manager, says his company has solved both problems by gearing the 70 channels with a digital counter so that the full range is covered in seven turns instead of one. "With this arrangement," he says, "life tests show the tuner to be practically indestructible."

Most tuner manufacturers are unwilling to redesign a tuner to provide it with remote-control capability, since this feature affects only a negligible percentage of the market, but tuner makers can't ignore the size problem. Tarzian says its 70-detent tuner is only 1/2-inch larger than conventional tuners.

**Electronic competition.** Since the varactor tuner uses semiconductors, one device can be used to pick up uhf and vhf channels. But it costs \$15. James Marx, marketing manager at Standard Kollsman, is out to change that. "The varactor," he says, "is going to be the standard; comparing it with a 70-detent is like comparing an automobile to a horse and buggy." Marx cites the problems of the 70-detent as too enormous to overcome. Besides, he says, "The industry is getting module-conscious, and the varactor is a module." Marx says he wants to cut the cost of the varactor in half and will know in three or four months if it is possible.

But Tarzian's Joyce doesn't think it is possible. "Standard Kollsman," Joyce asserts, "has missed the boat. The varactor's success isn't going to come overnight. We supply almost every TV manufacturer there is, and they are all going 70-detent." The prognosis is shared by others, who say that in addition to cost, varactors have problems with impedance matching and static discharge.

Meanwhile, despite such concern, Motorola's Semiconductor Products division is working with the varactor tuner [*Electronics*, Jan. 31, p. 36]. Erich Gottlieb, tuner marketing manager, lists these points in the varactor's favor: reduction in service and warranty costs, ability to locate the tuner in any part of the receiver, tuning by dc instead of uhf and vhf, and tuning without any contacts. "The key to successful varactor tuning," says Gottlieb, "is the ability to match the capacitance of the four varactor tuning diodes

throughout the voltage range over which they will be used."

Another varactor backer is the Oak Manufacturing Co., a division of Oak Electro/Netics. A leader in vhf tuners, Oak is quietly working on varactor tuners, unwilling to enter the 70-detent or memory uhf market. "It's not worth it economically," says James Wells, vice president of marketing. "We're banking on the varactor for the long haul."

A major supplier of varactor diodes is ITT's Semiconductor division. "We got into the varactor diode market in 1968 because we felt then the varactor tuner would be the trend in the long run," states Tom Mills, product line manager. ITT supplies glass-packaged diodes to RCA, Hitachi, Mitsubishi, and Sanyo Electric Co., as well as to Standard Kollsman, Tarzian, Oak, and General Instruments.

Mills says that the varactor will become economically feasible within the next few years through volume sales, but warns, "The Japanese may very well best us in this market because they are going after the smaller sets and do not restrict themselves to the top-of-the-line models, as we in the U.S. do."

**Forgotten memory.** The great varactor vs. 70-detent battle has seemingly left memory tuners on the skids. Tarzian plans to phase out its line of memory tuners. Al Sfreddo, director of engineering at F.W. Sickles, thinks that the 70-detent will obsolete memory types.

But AEG Telefunken, manufacturing a drive system for memory tuners, strongly disagrees. "Seventy-detent tuners are going to become obsolete," contends James Shoaf, AEG electronic component sales engineer. "The people working on 70-detent are just not going to be able to come up with the technology to make the tuner more accurate." Shoaf says the  $\pm 3$  MHz requirement is not stringent enough (the upper end of the UHF band is harder to tune since the percentage bandwidth is half as much). He continues that the Telefunken system is accurate to within  $\pm 1/2$  MHz. "We've been approached by three or four manufacturers offering to buy the patent," he says. "Moreover, we expect to have from a fourth to a half of the market by 1974." □

# IF YOUR DISPLAY STILL COMES IN A BOTTLE, DROP IT.

Here are six good reasons to go solid state with Litronix LEDs:

**1. They last and last.** Solid state LEDs have an anticipated life span far, far greater than their fragile bottled ancestors, as long as 20 to 30 years. They can take vibration and they don't break.

**2. And they are quiet.** Solid state LEDs produce no electrical noises, that's no RF interference. That's a cost savings on fancy shielding.

**3. They love IC's.** Solid state LEDs operate at low voltage and low power. They are directly compatible with IC's and that makes them ideal for hand-held battery operated things. No voltage converter needed and you save again!

**4. Small, medium and large.** Solid state LEDs come in all sizes. To name but a few: Our DL-62 has a 6/10 inch character in a DIP. Our DL-34 has four, 1/8-inch digits set on 187 mil centers for end-to-end stacking. (Calculator people love it.) And there's the DL-10A. It's a high efficiency, high brightness, low cost, 1/4-inch display. (Purchasing agents love it.)

**5. No hidden costs.** If you buy a glass tube display, it may cost you more than you bargained for. Add up the cost of a socket, a voltage converter or a transformer, a high voltage rectifier, additional assembly time and costs—then compare.

**6. Litronix.** We have a broad range of LEDs in the shape, size and cost range to compete with bottle displays. Write for our opto guide—it's free.

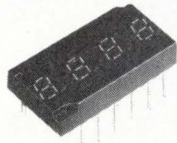
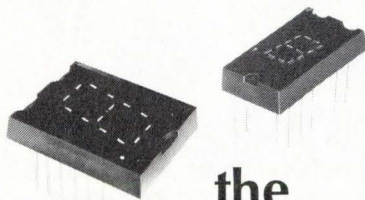

the  
bright  
guys

litronix

## Representatives

**Arizona:** Erskine Assoc.  
Scottsdale (602) 263-7654

**California:**  
Bertrand-Zoolalian,  
Downey (213) 927-4406  
Celtec, San Diego,  
(714) 279-7961

Trident Assoc., Mountain  
View (415) 967-7031

**Colorado:** R. G. Enterprises,  
Denver (303) 744-2464

**Florida:** WMM Assoc.,  
Altamonte Springs,  
(305) 831-4645

WMM Assoc., Clearwater,  
(813) 446-0075

WMM Assoc., Pompano  
Beach (305) 943-3091

WMM Assoc., West Palm  
Beach (305) 848-9042

**Illinois:** Compar,  
Des. Plaines (312) 824-0104

**Indiana:** Compar, Fort  
Wayne (219) 747-0402

**Kansas:** Compar, Wichita,  
(316) 722-6341

**Maryland:** Micro-Comp,  
Towson (301) 823-3603

**Massachusetts:** Contact  
Sales, Lexington,  
(617) 861-1550

**Michigan:** Greiner Assoc.,  
Grosse Point Park,  
(313) 499-0188

**Minnesota:** Comstrand,  
Minneapolis (612) 560-5300

**Missouri:** Compar,  
St. Louis (314) 567-3399

**New Jersey:** P.A.L.  
Components, Englewood  
Cliffs (201) 871-4020

TAI (Thomas Assoc.)  
Haddonfield (609) 854-3011

**New Mexico:** Electronic  
Marketing, Albuquerque  
(505) 265-7837

**New York:**  
P.A.L. Components  
Greenville, L.I.,  
(516) 484-4900

Tritech, DeWitt  
(315) 446-2881

**Ohio:** Compar, Fairview  
Park (216) 333-4120

Compar, Dayton  
(513) 435-1301

**Texas:** Carter,  
Garland (214) 276-7151

**Virginia:** Micro-Comp,  
Lynchburg (703) 239-1003

**Washington:** Compar  
Kirkland (206) 822-4191

**Canada:** Cantronics,  
Downsview (416) 636-8311

Cantronics,  
Montreal (514) 733-0749

**International  
Distributors**

**Australia:** CEMA Pty Ltd.  
Crows Nest, N.S.W. 2065  
439-4655

**Austria:** Bacher  
Elektronische, 1070 Vienna

**Denmark:** Tage Olsen A/S  
DK-2100 Copenhagen  
(01) 294800

**England:** Guest Int., Ltd.  
Surrey (01)-689-2121

**Finland:** SiV-Instruments  
00530 Helsinki 53, 738-265

**France:** ALMEX  
92-Chatillon-Sous-Bagneux  
Quatrelee S.A.,  
92 Levallis-Perret  
270-71-74 or 270-03-81

**Germany:** Omni-Ray GmbH  
6700 Ludwigshafen/Rhein  
513055-56

Omni-Ray GmbH  
D-8 München 19  
(0811) 5132059

Omni-Ray GmbH, Breyell,  
(02153) 3261

**Holland:** Klaasing  
Electronics NV,  
Amsterdam-C,  
928444 or 928445

**Israel:** Rapac  
Electronics Ltd.  
Tel Aviv 77 71 15-6-7

**Italy:** Eledra 35, Milano  
86.03.07

**Japan:** Electro Marketing  
Tokyo 359-4521  
Internix, Inc., Tokyo  
3633649

Riket Corporation, Tokyo  
591-5241

**Norway:** Nordisk Elektronik  
Majorstua-Oslo 3, 602590

**So. Africa:** Liberty  
Electronics, Boksburg  
527637-8

**Sweden:** Stenhardt  
Komponentbolag N,  
161 56 Bromma, 08/37-29-45

**Switzerland:** Dimos AG  
CH 8048 Zurich (051) 626140

## Field Sales Offices

**Atlantic States:** New York  
(516) 421-0162 or 692-4861

**Midwest States:**  
Creve Coeur (314) 872-8511

**New England:**  
Up-Stat N.Y.,  
Andover (617) 536-3366

**Southwestern States:**  
Palos Verdes (213) 377-7871

Industrial

# Automation boosts plant power

Industry turns to minicomputer-controlled systems to cut costs in materials handling, while generating management data

by Alfred Rosenblatt, New York bureau manager

From a disk-brake manufacturing plant in Saginaw, Mich.—where “the factory itself is like a machine”—to a 2,400-item chemical warehouse in South Charleston, W. Va., automation is taking over more and more of industry’s materials-handling chores. To a large extent, this burst of plant modernization has been brought about by the availability of low-priced, versatile minicomputers.

With new candidates for materials-handling automation being promoted, sales of these automated systems could reach as high as \$300 million in 1972, predicts M. L. McKenna, general manager of Aerojet-General Corp.’s Industrial Systems division, Frederick, Md.

What’s more, the proportion of electronics used in these systems is increasing rapidly.

**Electronics future.** By 1976, the electronics segment could average out to be as much as one-third of the total systems value, says Howard Zollinger, manager of the Controls division of the Rapistan Corp., a materials-handling equipment supplier in Grand Rapids, Mich. In contrast, Zollinger estimates that the value of electronics shipped in 1969 by his company amounted to only 1% of the total.

Electronic equipment includes automatic reading devices that identify special optical and magnetic codes; drive circuitry for controlling equipment motors; special circuitry

through which minicomputers actuate equipment, such as the drive controls on a stacker crane or the diversion chutes on a sorting machine; logic circuitry for decoding computer commands; and the minicomputers that monitor and control the entire operation.

**Reports.** Almost as a by-product, the minicomputers provide constant status reports of not only the machinery, but also all materials—from the time they are delivered to the plant until they are shipped out as finished products. These reports enable management to have unparalleled control of its production schedules and inventories.

In the past, materials-handling equipment manufacturers often

**Baggage control.** Central control console of United Air Line’s baggage handling system, developed by the Industrial Products division, Aerojet-General Corp., uses television cameras to monitor key portions along the baggage-delivery guideways.



# Why more people are buying DVM's from S-D:

Jerry Hartman, DVM Sales Manager

**3½ digit, 17,000 units sold.** High performance at lowest cost. Unequaled customer acceptance. Good noise rejection and long-term stability resulting from Dual-Slope integration design. Ideal for production, test and design areas. (Model 7050, \$279 and up)

**4½ digit, AC, DC, volts, amps, ohms.** 25 ranges of dc and ac volts, dc and ac current, and resistance. Full 4-digit display with 10 microvolt resolution. Dual-Slope design and a fully guarded input assure highest noise rejection. Lightweight, with optional battery pack and protective cover, for operate-anywhere convenience. (Model 7004, \$650)

**5½ digit bench. Best price/performance.** Full 5-digit accuracy and resolution at lowest cost. Use in any area where critical measurements must be made. Fast response readings. High input impedance; lowest 'kickback' noise. Plug-in card expandability—dc volts, dc millivolts, current, ac volts, resistance, auto-range, digital outputs. (Model 7005A, \$1295)

**5½ digit systems. Fast and Accurate.** 30 readings/second and high noise rejection. Fully isolated programming and digital outputs in a variety of optional formats. DC volts and ratio standard. Plug-in card options for ac volts, 4-wire ohms, system interface. (Model 7110, \$1695)

For full details, contact your Scientific Devices office or Concord Instruments Division, 888 Galindo Street, Concord, CA 94520. Phone (415) 682-6161.

**In Europe:** 8 München 60, Haidelweg 20, Germany. Telex: 841-529-615.

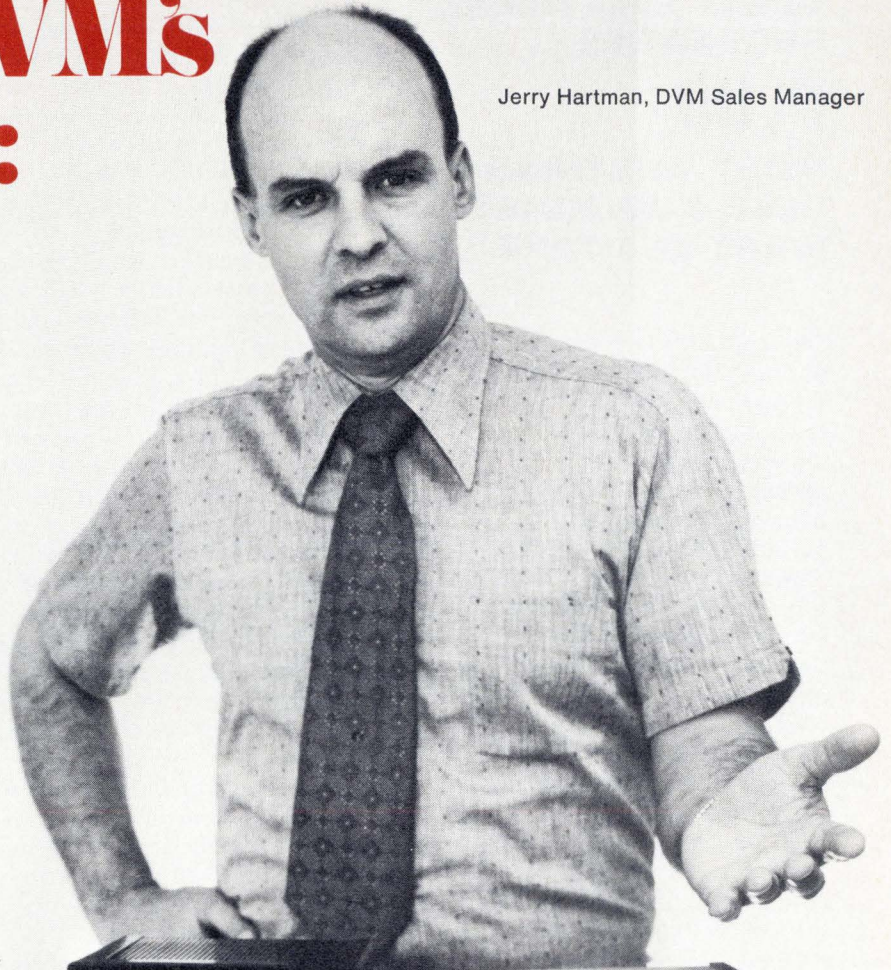

SYSTRON  DONNER

## The Systron-Donner Instruments Group:

Alpha Scientific  Computer Systems  Concord Instruments  Datapulse  Kruse Electronics  Microwave  Trygon Electronics

Circle 99 on reader service card

# TEMP-R-TAPE: GREAT ELECTRICAL PROPERTIES PLUS MOST ANYTHING ELSE YOU MIGHT WANT IN A TAPE.

Like high tensile or tear strength; excellent abrasion, thermal, and chemical resistance; exceptional dimensional stability; excellent conformability; and a low-friction, easy-release surface. Because Temp-R-Tape® is a complete tape "family" available in a variety of materials like polyester, polyester/rope paper laminate, Teflon\*, Kapton\*, and fiberglass. Supplied with thermosetting, silicone, or acrylic pressure-sensitive adhesive.

Find your CHR distributor in the Yellow Pages under "Tapes, Industrial" or in industrial directories. Or write for details and sample. The Connecticut Hard Rubber Company, New Haven, Connecticut 06509.

\*T.M. of DuPont

a HITCO company

## CHR

®

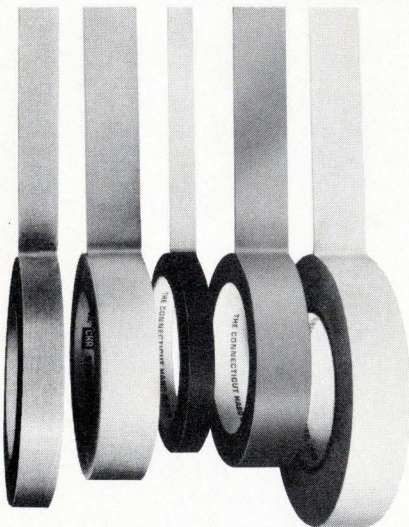

Circle 100 on reader service card

## Probing the news

elected to build their own special controllers to keep costs down. But this is no longer the most economical way to go, says David G. Curchey, manager of FMC's Controls group, especially with \$2,500 machines available from companies like Texas Instruments and Modular Data Systems. And he adds wistfully, "I wish I had a system where I could apply one of those right now."

One of the most sophisticated materials-handling systems in existence was dedicated this month in the new 750,000-square-foot Chevrolet disk brake manufacturing facility in Saginaw, Mich. A pair of Digital Equipment Corp. PDP-11/30 minicomputers in the \$6 million system provide complete control of materials handling, inventories, and manufacturing processes, as well as churning out comprehensive management reports on the status of all materials, production line, and equipment.

"The factory itself is like a machine," observes Barney O. Rae, a group manager at Cutler-Hammer's Industrial Systems division, designer of the Chevrolet materials-handling system. "Sure, it has individual machine tools and transfer machines, but they and the materials they work on are all tied together through a computer and operate as a unit."

Similar advantages are being realized in many other industries. Warehouses, with the introduction several years ago of computer-controlled stacker cranes, have become important candidates for automation. Union Carbide Corp's chemical warehouse in South Charleston,

W. Va., for example, now uses a Honeywell H-20 computer to track down and select for shipping as many as 2,400 stock items.

**Examples.** Among the prime examples of automated materials-handling systems are machines for sorting letters in post offices, a system being built for a distribution center owned by Sears, Roebuck & Co., baggage- and freight-handling system for United Air Lines and Pan American World Airways, and a linen and food-tray dispensing system for a Kansas City hospital.

On the frontier of new applications FMC Corp., Santa Clara, Calif., is working on an automated system for a major lumber producer in an industry which probably is one of the least automated. And Cutler-Hammer hopes to break through to bring automated techniques to the metal foundry industry, Rae says.

Relying on the optimistic predictions for total value of these automated systems to reach \$300 million this year, Aerojet—primarily an aerospace industry giant—regards the materials-handling field as one of its prime growth areas in the decade ahead. Consequently, officials are seeking to expand the company's position in that field through acquisitions and joint ventures.

The need for automation is indeed great, many observers agree. "Direct labor costs have been squeezed until they're pretty low in many cases," comments R.H. Huebenthal, senior systems specialists at General Electric's Industrial Sales division, Schenectady, N.Y. "Handling materials is often an exceptionally large portion of the cost of manufacturing a part." To move materials from one machine to the next still requires manpower. □

**Crane control.** Stacker crane of the kind used in automated warehouses can be operated manually in the event the central control computer should fail.

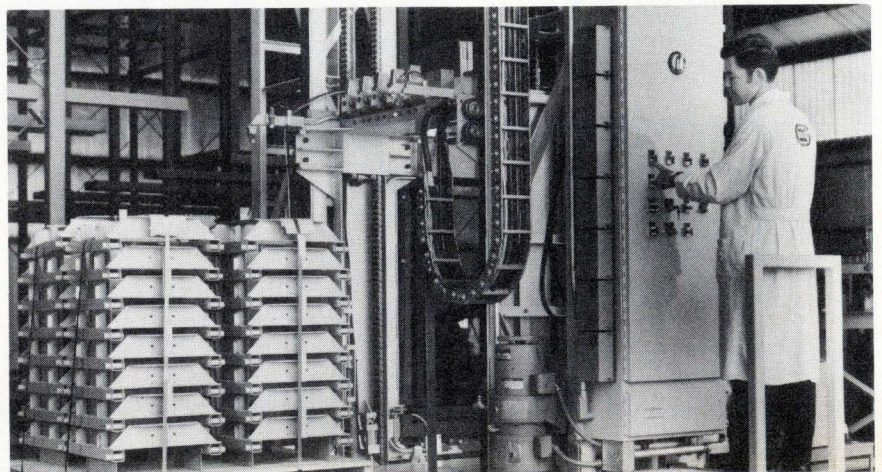

# Free! The profile chart that takes all the compromise (and gamble) out of fixed resistor selection



Don't settle for a resistor that is "almost" what you need. This chart provides complete electrical and physical characteristics for *all* popular fixed resistor types — with relative prices. See exactly what the trade-offs are and match up your needs just as if you were using custom parts.

Only TRW could (or would) offer you a chart like this. Because only TRW makes every popular type of fixed resistor. We never have to push one type over another. The choice is strictly up to you. In fact, buying from TRW gives you the variety and selection of 22 companies, with all the convenience of one source.

To prove this even more dramatically, we've prepared another chart—an industry-wide fixed resistor cross-reference. It covers every popular resistor type and every major manufacturer. Tells you who makes what, and what their competitive part numbers are.

To get either or both of these unique charts, just fill in the attached coupon and mail it today to TRW Fixed Resistors, an Operation of TRW Electronic Components. Or contact your local TRW Distributor.

TRW Fixed Resistors / Distributor Marketing  
P. O. Box 12867  
Philadelphia, Penn. 19108 (Phone 215/923-8230)

This I've got to see. Please send me a free copy of your fixed resistor profile and cross-reference charts.

\_\_\_\_\_  
Name

\_\_\_\_\_  
Company

\_\_\_\_\_  
Address

\_\_\_\_\_  
City

\_\_\_\_\_  
State

\_\_\_\_\_  
Zip

**TRW**  
IRC FIXED RESISTORS

Communications

# Spade system to shrink world

Satellite links will become available on demand to smaller nations through ground switching stations that obviate the need to preassign frequencies

by William F. Arnold, Aerospace Editor

**The smaller nations of the world** will find it easier to communicate by satellite with the advent next month of a new system dubbed Spade. As part of a country's ground station equipment, Spade will permit international communications via Intelsat 4 without the expense of leasing preassigned frequencies.

The ability of a country to use the Intelsat 4 satellite on a demand basis is made possible by Spade (single-channel-per-carrier, pulse-code-modulated, multiple-access, demand-assigned equipment). Spade switches telephone calls between countries on demand by using a common signaling channel through which ground stations can tell each other when they want to

talk. This avoids a central switchboard function and provides extensive flexibility.

When the Communications Satellite (Comsat) Corp. in Etam, W. Va., and the Bundespost in Raisting, West Germany, start talking to each other via Intelsat 4, Spade will also become the first long-haul pulse-code-modulation communications system. But apart from these firsts, Spade will be just in time to handle the burgeoning traffic demands of the Intelsat network.

**Sharing channels.** Intelsat officials liken Spade service to that of a good telephone company that offers customers service when they need it without making permanent assignments of channel capacity. Next

year, for example, they estimate that there will be 43 active earth stations in the Atlantic region alone. These stations will use up about 900 channels, but only about a quarter of these channels will be operating simultaneously, and only about one in 16 will be carrying enough traffic to justify its being preassigned.

With pre-assigned channels, which largely use frequency-division multiplexing, Intelsat must allocate its channel requirements six months in advance. It has no way to reassign earth station hardware or channel space in the interim, explains Andrew M. Werth, modulation techniques branch manager for Comsat Laboratories, Washington, D.C. Comsat manages the In-

**Communicate.** Added to an earth station, the Spade system permits international satellite communication without the expense of leasing preassigned channels. The DASS unit monitors all conversations and assigns calls to any of the 400 channels handled by Intelsat 4.

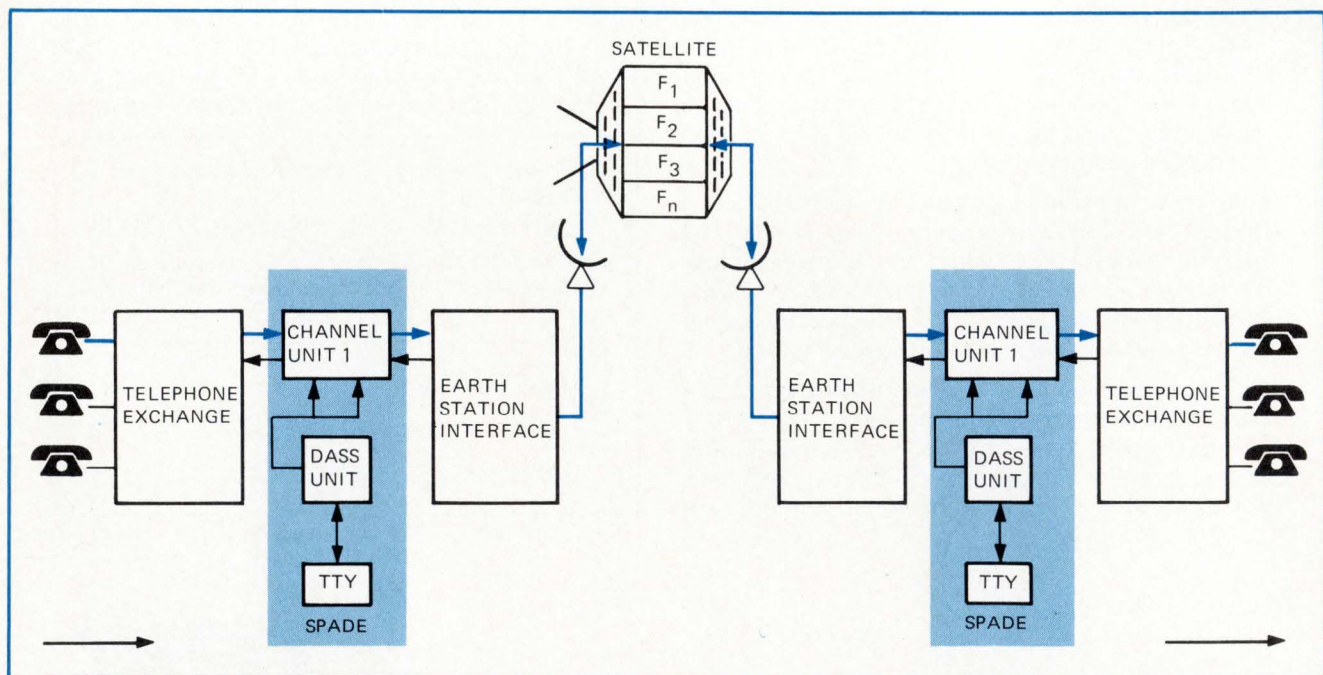



telsat network for the 82-member consortium. If a country overestimates its requirements and uses only 48 out of 60 pre-assigned channels until the next reallocation, says Werth, twelve channels will be wasted.

By the end of this year, Spade equipment will be installed in 12 ground stations. By 1974, there will be 30 Spade stations, and eventually there will be 62—one in every Atlantic region station.

Spade equipment, including installation and training, adds another 10% to the cost of a regular ground terminal, or about \$400,000 to \$500,000, says Werth. "For a \$5 million investment, a country gets a good system, with a maximum error rejection rate of 99 out of 100," he states. Because Spade is a PCM system, it can handle computer-to-computer, telegraphic, and facsimile transmission simultaneously. Each digitized voice channel operates at 64 kilobits per second. PCM also provides a two-to-one increase in channel capacity over frequency-division, frequency-modulation systems. And, with the assignment capability, the 800-channel transponder on Intelsat 4 can handle the equivalent of 2,400 preassigned channels.

Besides PCM, Spade uses four-phase coherent phase-shift-keying for channel encoding. Channel bandwidth is 38 kHz and spacing between channels, 45 kHz. The common signaling channel uses time-division multiple access and two-phase phase-shift-key modulation, with a rate of 128 kilobits per second, a frame length of 50 milliseconds, and a burst length of 1 millisecond. Forty-nine stations are able to access the channel.

**No central switching.** Spade's capability to handle calls on demand without central control was developed since "we couldn't consider having one central control because it wasn't politically or operationally practical," Werth says. Comsat Labs got around that, and also increased the system's flexibility, by developing what it calls the demand-assigned signaling and switching (DASS) unit. A DASS unit in each Spade terminal acts as a common signaling channel, similar to the 2,182-kHz channel used for marine telephone calls.

## What DASS does

So that the Intelsat network wouldn't need either pre-assigned channels between earth stations or a centralized switchboard for Spade, Comsat Labs developed DASS. The basis of the DASS approach is to have the Spade terminals share a common signalling channel (CSC) so they can tell each other whom they want to talk to and on what frequencies. Thus, a station will use the CSC to signal the called party, to tell it what frequency it will use to send the call, and what frequency the other station should use to reply.

All Spade terminals share a pool of 800 frequencies (400 two-way circuits). Besides carrying call information, the CSC also transmits a "roster" of those channels in the pool that are currently available. This roster is continuously updated by a computer in each ground station.

The CSC is a time-division, multiple-access channel that allows each Spade station in sequence to transmit a short burst of information, indicating one ground station has a call for another. The bursts are so short that 49 Spade stations in the system could all transmit them to each other in 50 milliseconds.

The DASS units monitor and direct these functions automatically. The ground station interface unit—essentially a big switch—makes the connections between the land lines, the channel units, and the DASS unit.

Each channel unit is composed of a PCM coder-decoder, a transmit-receive unit, a phased shift-key modem, and a frequency synthesizer. The PCM coder-decoder converts outgoing analog signals to digital and incoming digital to analog.

A transmit-receive unit times, buffers, and frames the digital bit streams representing the actual voice conversation. Its job is to look at the analog wave form of the voice 8,000 times a second, and to decide which of 128 possible digital numbers best describe the characteristics of the voice at that moment.

The phased-shift-key modem modulates the assigned carrier frequency with the outgoing bit stream and coherently demodulates the incoming bursts with the aid of the carrier and timing information contained in the incoming digital bit stream. The frequency synthesizer selects the frequencies for the call, using codes provided by the DASS unit.

DASS units monitor all calls continuously, and when a call is completed, returns the two circuits to the frequency pool for reassignment. This fact that the call is completed is instantaneously passed on to the other Spade terminals by their computers.

Spade conserves satellite power supply because it transmits a conversation only when someone is actually talking. This way, the large amount of silence in any telephone conversation is not carried. A voice detector monitors the content of the voice channel and switches the power on or off accordingly.

Spade is not like the Bell System's time-assignment-speech interpolation (TASI), which uses the gaps in conversation to interpolate pieces of other conversations digitally so that several are carried on the same channel. TASI predisposes a pre-assigned channel, whereas the demand-assigned Spade system conserves satellite power by using just one channel per conversation. Intelsat estimates that only about 40% of the 400 telephone circuits will be used at any one time.

Final acceptance tests are being

run this month on the Etam ground station equipment. This was built by Nippon Electric Co., Tokyo, which won the \$313,000 contract among seven bidders from four countries. The Raisting, Germany, station equipment also is built by Nippon, with AEG Telefunken, Munich, acting as systems integrator. About 10 other countries also have purchased the Nippon equipment, Werth comments.

Although the satellites are owned collectively by Intelsat, the individual earth stations are owned by the respective countries (or their chartered representatives as in Comsat's case).

Comsat is proud of Spade. "We have a high degree of confidence in demand-assignment techniques," Werth says. "After all, the telephone company has been using them for years." □

# LET MOS/LSI EXPAND YOUR THINKING- AND YOUR MARKETS.

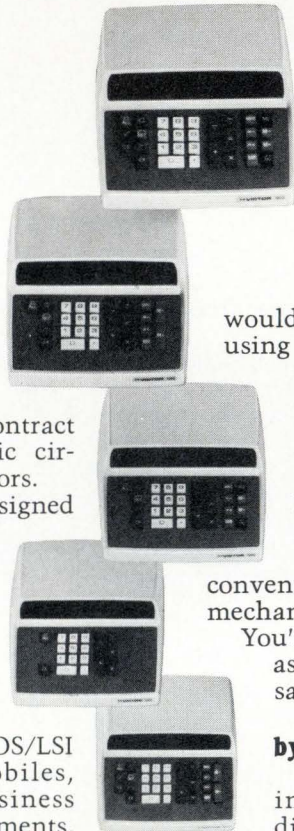

Looking back two short years, we recall the first commercial use of our MOS/LSI electronics—a multimillion dollar contract to supply microelectronic circuits for desk-top calculators.

Since then, we've designed hundreds of other MOS/LSI circuits. With production running in the millions each year.

Today, under contracts with some 20 major companies, we're working on nearly 30 product programs—applications of MOS/LSI technology for automobiles, trucks, appliances, business machines, musical instruments, computer peripherals, cash registers, calculators, data transmission and telecommunication equipment.

A couple of examples.

Right now we're working with Victor Comptometer Corporation on its development of a completely new line of business machines and calculators. And we supply the circuits for the musical computer of the new Allen electronic organ.

**MOS/LSI reduces systems costs more than 50%.**

Size and weight reductions alone

would be sufficient incentive for using our MOS/LSI technology. So would greater product reliability. So would lower power requirements.

But, in business, cost reduction is usually the key consideration. The cost of our MOS/LSI systems is as much as 50% that of conventional electronic or electro-mechanical systems.

You'll get the other advantages as bonuses, along with the savings.

#### **The state of the art— by its innovators.**

Our MOS/LSI technology includes many kinds of digital systems and circuits: switching, arithmetic, counting, driving, multiplexing, digital-analog and analog-digital

conversion, frequency generation and discrimination, digital filtering, modulation, demodulation, and memories of different types.

And right now we're developing future generations of microelectronics: new MOS processes, advanced packaging methods, multi-layer ceramic substrates, nitride passivation, silicon on sapphire, liquid crystal displays and more.

#### **A joint product commitment.**

As part of NR's Electronics Group, we're ready to share with you the long-term commitment required for new product design, testing and development.

Even more.

We'll join you in product planning, so that you may share in the progress of current research.

Drop us a line on your company letterhead for a copy of our

new brochure, "The Economics of Change!" Write: A.B. Chambers, P.O. Box 3669, Anaheim, California 92803.

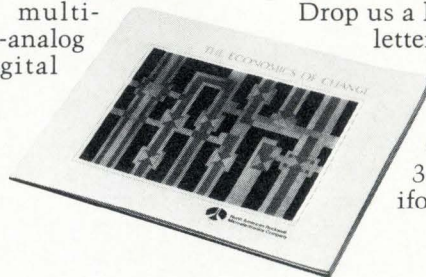

**North American Rockwell  
Microelectronics Company**

Communications

## FCC gets advice on digital data transmission

Compatibility of digital with analog modulation on microwave radio is biggest problem foreseen

By Lyman J. Hardeman, Communications and Microwave Editor

By the mid-1970s, the microwave spectrum must undergo an analog to digital conversion—at least in part. Basically, it must shift from handling almost entirely analog information to handling a mixture of both analog and digital signals. Difficulties are inevitable, and to anticipate as many of them as possible, the Federal Communications Commission set late last month as the deadline for receiving comments from the industry on how digital modulation will impact microwave.

Twenty-six respondents generally agreed that the modulation techniques used must allow efficient transfer of information, and that different modulation schemes operating in the same or adjacent bands must be compatible.

**Unscrambled and scrambled.** Scope traces from Avantek show how data scramblers distribute power more evenly over the rf spectrum. The spikes (left) result from a typical square wave modulating signal used to phase-shift-key a carrier at 6 Mbps. Scrambling the same signal (right) distributes the power over 12 MHz. A bandpass filter is used in both cases.

While recognizing the efficiency of frequency-division-multiplexed frequency-modulation techniques for analog voice transmission, the respondents were virtually unanimous in suggesting some form of digital modulation for transmitting information from computers, facsimile, video, and teletypewriter. The digital modulation techniques considered in the filings were compared with fdm/fm rather than with other digital methods. The modulation techniques proposed include phase-shift keying (PSK), minimum shift keying (MSK), frequency-shift keying (FSK) and amplitude-shift keying (ASK).

However, a couple of respondents—General Telephone and Electronics of New York City, and Mi-

# Procond is young (electronics too)

Plastic film and electrolytic capacitors for entertainment and professional field.

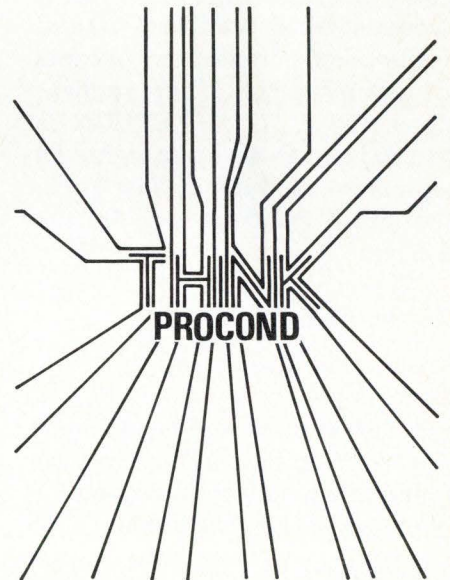

PROCOND S.p.A. - 32013 Longarone, Italy.

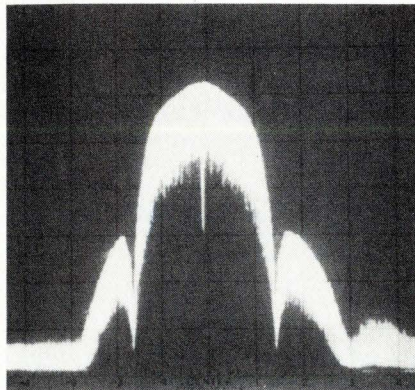
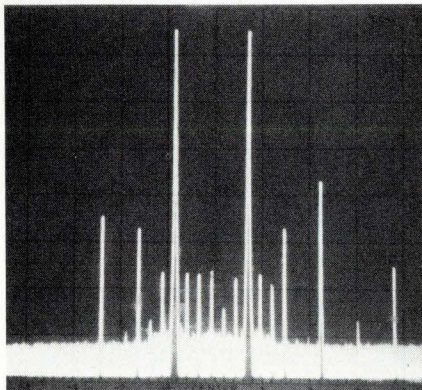

crowave Communications Inc., of Washington D.C.—disagreed that the public would gain from a “green light policy” on digital techniques. “Digital modulation,” said GTE, “should not be employed, except for developmental purposes, in bands below 13 GHz, until their full compatibility with fdm/fm systems has been proven.”

In geographically isolated regions where frequency spectrum saturation is not a problem, a number of respondents, including the American Telephone and Telegraph Co., New York City, recommend unrestricted use of digital modulation on microwave radio. In most areas, however, GTE claims that the interfering effects of digital modulation on fdm/fm may be a serious problem because the causes of such interference are not well understood, that adequate controls have not yet been developed, and that efficiency below 13 GHz would be endangered because of lower bandwidth utilization efficiency with digital techniques.

**Compatibility.** The major problem foreseen by most respondents was the compatibility of digital modulation techniques with each other and with fdm/fm. This will depend heavily on the ability to minimize the sideband energy of transmitted signals. Most of the filings indicated that filtering should be used to reduce sideband effects, but there were varying opinions on how much filtering should be required and whether the limits should be based on calculated data or on data measured in trials.

According to AT&T's filing with the FCC, “Experience with 18-GHz digital signals suggests that control of the first sideband to 35 or 40 dB below midchannel power density is enough to protect adjacent channels from interference.” But for digital systems operating below 15 GHz—where there is a serious congestion problem—AT&T recommends that sidebands be controlled to 50 dB below midchannel power density.

After reviewing AT&T's original filing, Data Transmission Co. (Datran), Vienna, Va., objected to the sideband limitation on two

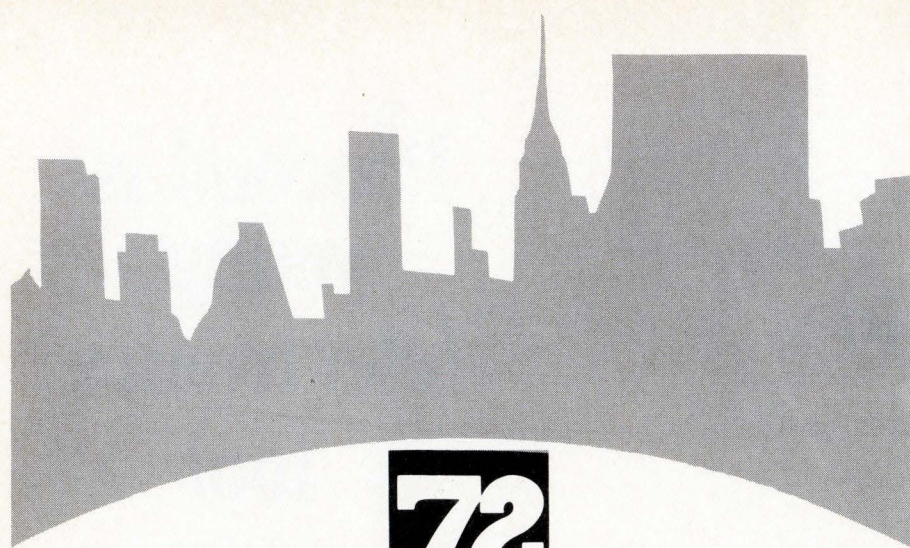

## MARCH 20-23, 1972

**It's the big one in New York.** The most important convention of its kind. Meet the influential people who call the shots in the rapidly-changing electrical/electronics industry. “New Horizons for Engineering” is the theme. The emphasis is on tomorrow — moving careers and companies along . . . how engineering and social changes will affect directions and assignments, create new concepts . . . new products . . . new applications. IEEE '72 INTERCON is where you can set your sights on tomorrow. And it's in New York, the most exciting city in the world.

### 3 Great Shows in 1

Production/Processing/  
Materials/  
Fabricating . . . Instrumentation/  
Control/Computer/Display . . .  
Components/Microelectronics/  
Communications/Systems

### Over 80 Technical Sessions

Applied, state-of-the-art and socio-technological sessions cover Transportation, Computers & Systems, Microelectronics, Semiconductors, Manufacturing Techniques, Packaging . . . and much more.

### New Science-Technology Center

See avant-garde industry and government solutions to control traffic, monitor pollution, increase communications, safeguard our health . . .

Plus . . . Company-Sponsored Seminars, “Tech-Talk Centers” and other innovations that are bound to bring you new ideas in fresh, exciting ways!

Write IEEE Convention Department for Advance Program and registration discount details.

IEEE '72

INTERNATIONAL CONVENTION AND EXPOSITION

New York Coliseum and New York Hilton



The Institute of Electrical and Electronics Engineers, Inc.  
345 East 47 Street, New York, N.Y. 10017

counts: "First, the requirement is related to the keying rate and not directly to the rf channel spacing—and for low keying rates this could result in a requirement for unnecessary in-band filtering. Second, it attempts to regulate only one specific form of digital modulation, namely four-phase PSK."

**Alternatives.** Several others, including the Electronic Industries Association, Raytheon Co., and Avantek Inc., agree generally that, if out-of-band emissions are to be regulated, a more flexible and universal policy should be adopted than that suggested by AT&T. A more viable alternative, based on a cross-section of comments, might combine a less rigidly specified out-of-band limit with procedures for resolving potential interference problems on a case-by-case basis.

One of the more serious problems considered in the filing is the formation of spikes in the power spectrum due to periodic patterns in the pulse stream of data signals. For example, the data output of a machine may go through extended periods without a transition from one logic state to another (as when a facsimile transmitter is transmitting a blank portion of a page). And yet there are many situations when the data output changes levels at every time increment.

These periodic patterns in the modulating signal result in an output spectrum with large unwanted spikes. For a square-wave modulating signal, two large spikes appear in the spectrum at frequencies above and below the carrier at a distance equal to the square-wave modulating rate.

"A simple method of eliminating these spikes," says L.R. Thielen, president of Avantek Inc., Santa Clara, Calif., "is to scramble the digital output with a pseudorandom generator." This, he says, averages the power in the output spectrum into many closely spaced discrete frequencies with a much more uniform distribution." Thielen says the circuitry required to scramble digital data is relatively simple and inexpensive to build. The pseudorandom code is of finite length and, of course, must be known to the receiving station where the signal is decoded. □

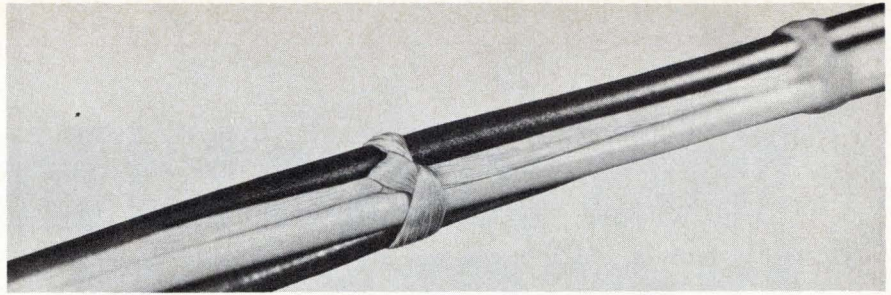

## Talk to Gudebrod about your tying operation this month...

**A**nd about Lacing Tapes, harness rooms and systems. About temperature and vibration . . . speed and rejects! About Nylon, Dacron, Teflon, Nomex, Glass tapes and cords—treated and untreated . . . that meet or exceed military and industrial specifications, about cost comparisons with other methods . . . and all backed up with one hundred years of manufacturing knowledge.

Dacron, Teflon, Nomex—Du Pont Registered Trade Marks

*Talk to Gudebrod this month!*

Write to this address for prompt return of our  
Product Data Catalog.

*Electronics Division*  
Dept. 852

**G**udebrod Bros. Silk Co., Inc. 12 South 12th Street, Philadelphia, Pa. 19107

Circle 107 on reader service card

## Rental wants you to know: The Secret to Greater Profits

Don't Spend Money . . . unless you have to! Remember, not spending it is almost the same as earning it. For example, you can have the best test equipment with no large capital investment by renting what you need . . . for as long as you need. Instead of building test equipment inventories, you build profits. Let us show you how it's done. Call or write Otto Rothfuss.

**Rental  
Electronics  
inc.**

A **PEPSICO** LEASING COMPANY

16600 Oakmont Avenue  
Gaithersburg, Maryland 20760  
Telephone (301) 948-0625

*Eight Major Service Centers  
Conveniently Located  
Throughout the U.S. and Canada*

# Two ways to improve your memory

from  
Microsystems  
International

You know us as a great MOS memory house, but that's only half the story. We are in business now with a new line of state-of-the-art bipolar memory products.

Our well-known silicon gate MOS memory capability has recently been complemented by the signing of a Technological Exchange/Alternate Source agreement with Monolithic Memories Inc. recognized leader in the bipolar memory field.

We have memories with bit densities from 64 up to 2048, and access times ranging from 40 to 300 nanoseconds—in fact all you're looking for in semiconductor memories.

For speed—specify our Bipolar. For low power dissipation—specify our MOS.

So, if you want to improve your memory, contact Microsystems International for the most advanced line of RAM's, ROM's, PROMS and Shift Registers in the industry.

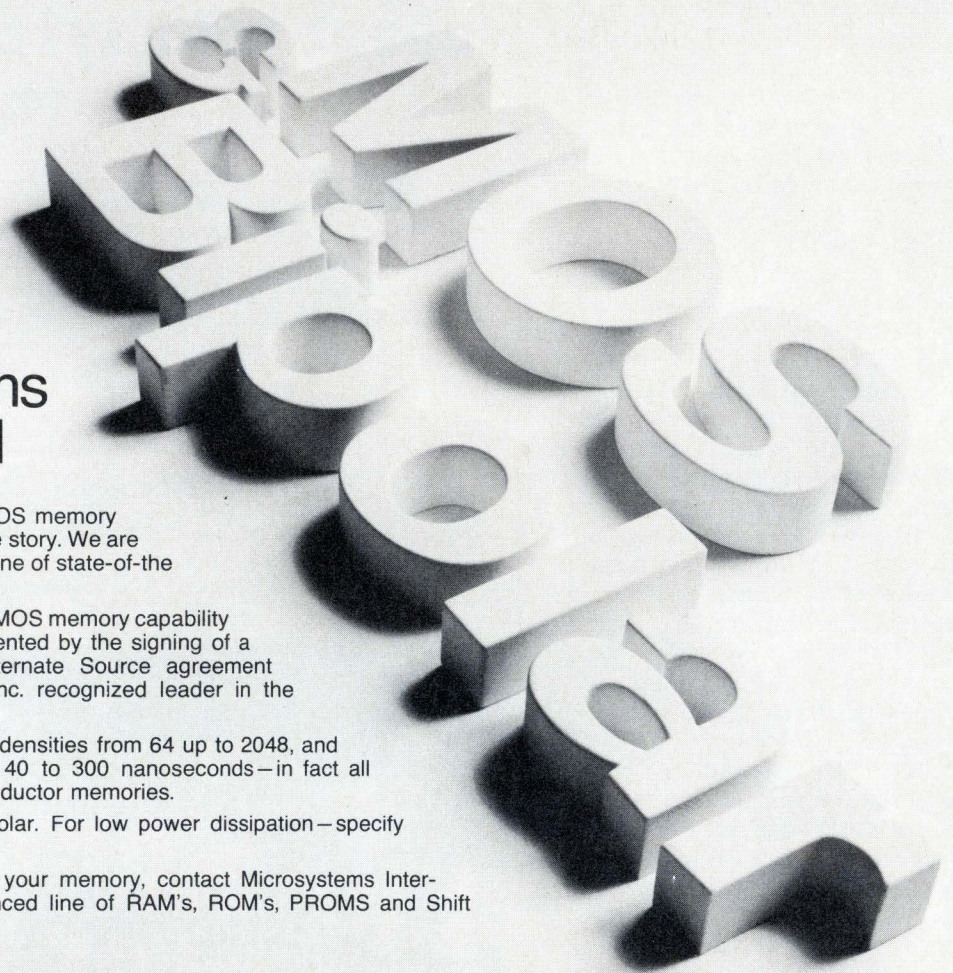

MOS & Bipolar Memories from  
the performance leader

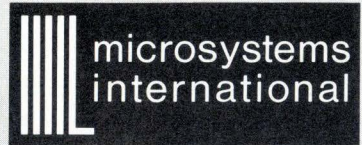

microsystems international limited, box 3529 station c, ottawa, canada - montreal, ottawa, toronto, brussels, stuttgart, london, palo alto, union.

For further information contact your nearest Microsystems International sales office.

**U.S.A.:** Palo Alto, California 94302; Suite 13, 450 San Antonio Road, Telephone: 415-493-0848; TWX: 910-373-1281  
Union, New Jersey 07083; 2401 Morris Avenue, Telephone: 201-964-3131; TWX: 710-985-5482

**CANADA:** Montreal 101, Quebec; 800 Dorchester Boulevard, West, Telephone: 514-875-2814; TWX: 610-421-4647  
Ottawa, Canada K1Y4J1; Box 3529, Station C, Telephone: 613-828-9191; TWX: 610-562-1910  
Toronto, Ontario; Box 34, Toronto Dominion Centre, Telephone: 416-336-7721; Telex: 02-21585

## New products

# Medium-speed printers aimed at minicomputer systems

by Marilyn Offenheiser, New York staff

Simplified mechanical and electronic assemblies are key to faster machines in \$3,000 price range

**Minicomputer users** who wanted hard copy at fairly high speed could always go to line printers, but these printers usually cost more than the computers. The lower-priced terminals, on the other hand, had a maximum printout rate of about 30 characters per second.

In recent months, however, a half-dozen or more companies have filled the gap with relatively high speed printers—100 characters a second—and prices in the \$3,000 range. And more of these units are on the way this year.

■ Mohawk Data Sciences' Franklin Electronics division, King of Prussia, Pa., will introduce after mid-year two impact-type models that can reach 100 characters a second and will sell for about \$3,000 in OEM quantities.

■ Centronics Data Computer Corp., Hudson, N.H., will follow up its present model 101A, a 165-character-per-second, \$2,595 printer, with a 70-character-per-second model that will sell for \$895.

■ Memorex Corp., Santa Clara, Calif., fairly new to the printer business, this spring will offer a 60-character-per-second model that will sell for \$4,875, and the California company plans to widen its printer line by mid-year with a series of faster models.

■ Printer Technology Inc., Woburn, Mass., which recently announced a 100-character-per-second

machine for an OEM price of \$1,200, will soon introduce a lower-priced 80-column printer.

■ Digital Equipment Corp., Maynard, Mass., the IBM of the minicomputer business, will announce this spring a printer line that will move the company deeper into the peripherals market.

A common element among the various designs is the simplification of both mechanical and electronic assemblies.

"This is an infant business now, but it's going to grow the way the minicomputer industry did during the past decade," says Philip Sweeney, a member of the marketing group at Printer Technology.

The combination of relatively high speed for a fairly low price requires several tradeoffs. A major one is the type of print mechanism. With the notable exception of Printer Technology's model 100, most companies have elected to use a dot-matrix configuration. The dot matrix is inherently cheaper because there are fewer mechanics in-

involved in getting the character printed. However, many users do not like the look of the dot-matrix character because it is more difficult to read. Printer Technology's Sweeney says the company decided to use a full character printout because "we found the dot matrix more prone to failure. The solenoids on the print head wear faster," he continues, "and they are difficult to maintain."

Another tradeoff has been in opting for the impact-type of printer, even though it is more cumbersome than the nonimpact type. And where the nonimpact printer may be cheaper, its disadvantage lies in the fact that it can only produce one copy at a time. An impact printer puts out as many as six copies.

Mohawk's new printers, models 4311 and 4312, will have 132 characters per line, 10 characters per inch horizontally, and six lines per inch vertically. Also offered will be a bit-serial interface and ASCII code. The printers will use a 7-by-5 dot

**Adaptable.** The Printec-100, manufactured by Printer Technology, accommodates any paper width to 136 columns. An 80-column machine is being developed by the company.

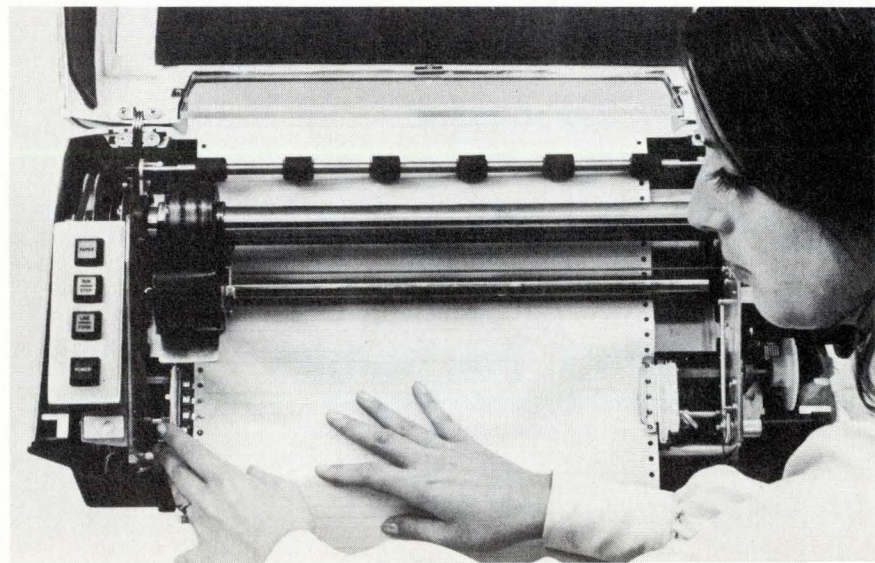

# Rental wants you to know: How to unfreeze Capital Funds

Simply call Rental Electronics and sit back and relax! Because Rental can supply practically all of your test equipment needs for as long as they exist. When the need disappears . . . call us and we'll make the test gear disappear and you'll still have your "frozen" budget in tact. Ask for Otto Rothfuss.

## Rental Electronics inc.

A **PEPSICO** LEASING COMPANY

16600 Oakmont Avenue  
Gaithersburg, Maryland 20760  
Telephone (301) 948-0625

*Eight Major Service Centers  
Conveniently Located  
Throughout the U.S. and Canada*

matrix for most characters, but will automatically switch to a denser 7-by-9 array for those characters that, because they have diagonal lines in them, tend to be hard to read in the standard matrix.

The \$895 Centronics printer, to be called the model 303, is designed to compete with teletypewriter terminals. Robert Howard, Centronics president, says that the printer will be manufactured by Brother Industries Ltd., Nagoya, Japan. The mechanisms will be shipped to Hudson to be integrated with Centronics-manufactured electronics and matrix heads. Other features of the 303 will include a capability to produce graphics, an 80-column config-

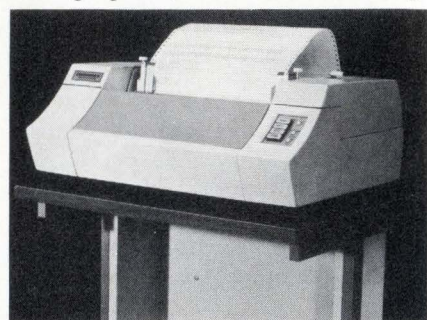

**Multilingual.** The model 101A from Centronics prints in any one of 17 languages.

uration, and 64 character sets each on two character generators.

One of these produces the standard Roman alphabet; the other contains all the special characters required to permit the printer to work in any of 16 other alphabets such as Greek, Cyrillic (Russian), and so on. Two optional character generators will produce the Japanese and Chinese alphabets.

The next step planned by Printer Technology is to add a keyboard to its Printec 100, an impact serial unit that sells for \$1,200 in OEM quantities and prints at 100 characters per second. The machine is also available on an ASCII level for \$2,200, or \$1,760 in OEM quantities. Built modularly to reduce cost, the 100 uses a multiple split-helix wheel, six hammers, and five printed-circuit boards. The machine's speed is due in part to its three 64-character ASCII fonts. The 100 also has bit-parallel ready strobe, an assortment of serial interfaces, with and without buffer, and a parallel interface with a memory buffer.



## think woven

### for connectability

Need a neat match for standard or specialized connectors? Woven Cable fits the picture with rollable, foldable, stackable adaptability. Woven connects!

## WOVEN ELECTRONICS

A DIVISION OF SOUTHERN WEAVING COMPANY

P.O. Box 189, Mauldin, S.C. 29662, (803) 288-4411

Circle 150 on reader service card

110 Circle 190 on reader service card

Electronics/February 28, 1972



Instruments

# Communications tester handles 120-megabit data channels

by James Brinton, Boston bureau manager

Checkout system for modems and other equipment includes time-division multiple-access capability

**Data transmission** equipment that is good for 100 megabits per second and more is fast leaving the drafting table for the test lab. But users of devices from modems to communications satellites are finding themselves limited by available test equipment. Systems equal to the task of checking out a 120-megabit multiplexer haven't been available commercially until the introduction of the S-120C communications channel tester by Tau-tron Inc.

Other commercial equipment tops out at speeds of about 40 megabits, whereas the 120C reaches 120 megabits. Similarly, while other systems offer only a single channel of test data, the 120C has up to four. And while time-division multiple-access communications systems seem to be the route of the future, today's testers either lack the capability of inserting TDMA preambles—needed to gain access to a user's time slot—or lack the speed to emulate the high-speed bursts of data which characterizes TDMA. The 120C has both.

At about \$15,000, it brings what Tau-tron considers a laboratory instrument within reach of the communications service end-user as a performance monitor. The 120C has been built to work in systems where error rates could be as high as one in 10 bits. Statistically, then, the probability of the 120C falling out of sync is very low— $10^{-12}$ —and, since

error rates over typical "bad" links are from  $10^{-3}$  to  $10^{-4}$ , dropouts should be rare.

Sync lock-on probability is high, and it's made possible with a multiple-integration, cross-correlation technique. The transmitter section of the 120C houses its own data generator, plus an ECL maximum-length shift register capable of producing a pseudo-random bit stream more than a megabit long 120 times a second. Its duplicate is in the receiver section. The bit streams of both are identical, and can be directly compared with one another.

The 120C is a multichannel device offering up to four channels of phase-shift keyed data at front-panel coaxial connectors. John Connolly, Tau-tron vice president, notes that, since most fast commercial transmission systems are multiplexed, the multichannel output eases the problem of spotting crosstalk. "With single-channel gear, crosstalk just doesn't appear in test; but with four channels of data available in the test system, it is possible to troubleshoot not only simple two-channel crosstalk, but also complex

multichannel situations," he says.

But Tau-tron adds channels at the expense of speed. With four channels running, the maximum output becomes 30 megabits.

Like almost all digital communications system testers, the 120C has an error-injection feature. It acts as a self-test, but more importantly serves to plant a known series of errors in a known location in its output. If the errors return intact and on time, everything is working as advertised. If not, there's troubleshooting to be done.

But Tau-tron's error-injection schemes can be "ignored" by the receiver. "This is an aid to spotting errors in noisy lines," says Connolly, "and in circuits with certain types of cryptographic gear on lines, especially those using memories as a code field." Often, injected errors result in a cascade of multiplicative errors in memory-type encoders, he notes, and since the 120C can be made to ignore its own errors, it can locate malfunctions and get exact counts of error and error rate.

Tau-tron Inc., 685 Lawrence Street, Lowell, Mass. 01852 [339]

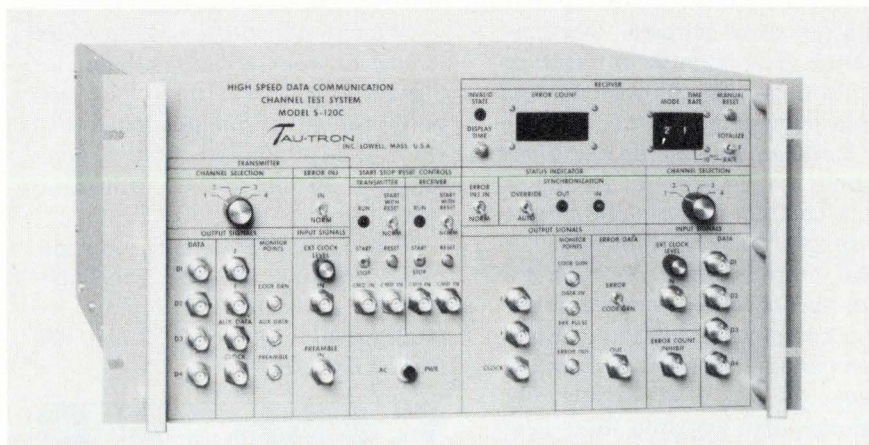

# The mini-maxi machine. Kearfott SKC-2000 Airborne Digital Computer.

Floating point arithmetic eliminates scaling problems and permits use of Fortran IV compiler.

Existing, working hardware designed to accommodate tomorrow's technology, today.

Large machine architecture used in compact airborne digital computer is readily expandable.

True modularity. Machine architecture and mechanical design permit virtually unlimited addition of CPU and memory modules.

Unique mechanical design provides for adequate cooling of MSI/LSI devices used.

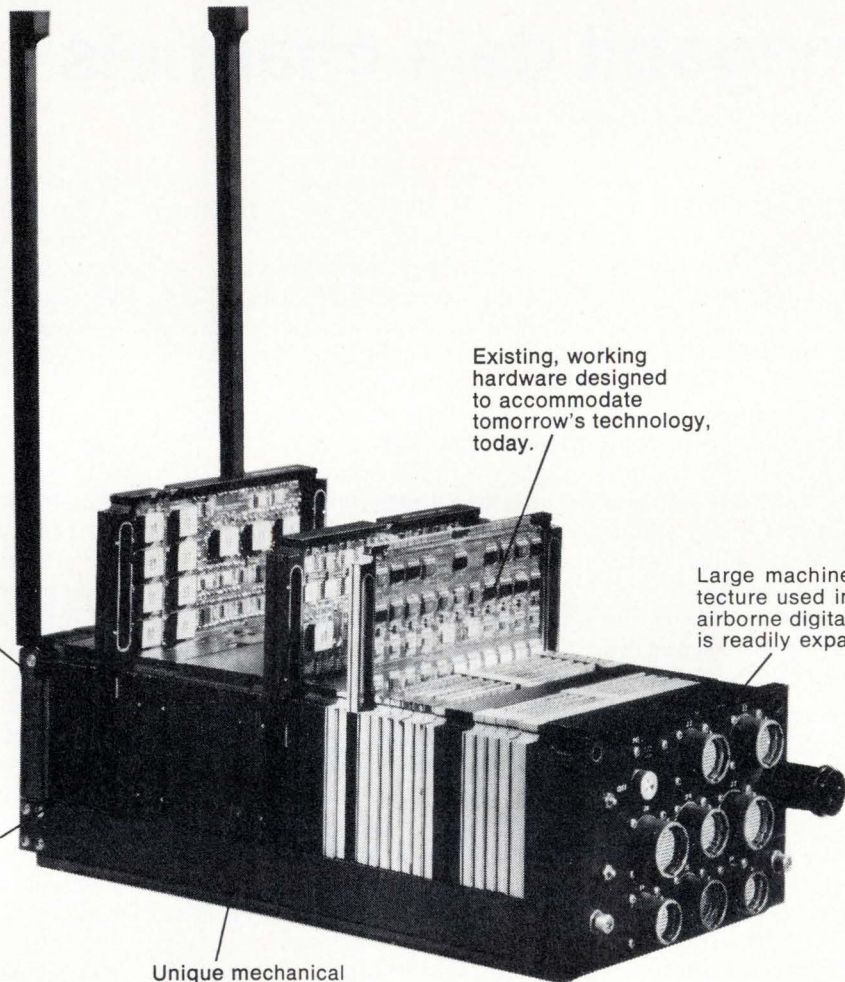

Here's a general purpose, high performance digital computer based on a single data and control bus, and an interconnecting series of modules. Modules that can be combined to form a simplex central computer, a multi-computer or a multi-processor—simply, quickly, efficiently.

But there's more. Through the use of asynchronous module operation, a complete spectrum of input/output capabilities is made possible. Because the SKC-2000 modules can be mixed and matched, and even replaced as new technological advancements are made.

We can provide you with a whole family of compatible modules for our SKC-2000. And one of our experts can help you put together a winning combination, from a mini-machine all the way up to a maxi-machine.

For more information, and a detailed new brochure, write The Singer Company, Kearfott Division, 1150 McBride Ave., Little Falls, N.J. 07424. Or call (201) 256-4000.

**SINGER**  
AEROSPACE & MARINE SYSTEMS

#### Typical Characteristics (CPU)

Number Systems	Binary, floating point and two's complement fixed point
Data words, Floating Point	24 bit mantissa, 8 bit exponents
Data words, Fixed Point	32 bits including sign
Instruction Words	16 bits short, 32 bits long
Instructions Address Modes	99 total long & short Direct, indirect, relative, immediate
Average Execution Times For 1.9 $\mu$ sec memory (LSI)	Add-2.125 $\mu$ sec, multiply-5.875 $\mu$ sec Divide-5.875 $\mu$ sec
Memory words directly addressable	131,072

### Instruments

## Low-cost scope covers 15 MHz

Portable dual-channel unit costs \$845, has vertical sensitivity to 5 mV/cm

For computer-peripherals servicing jobs, an oscilloscope should be truly portable and have a high performance-price ratio. Ballantine Laboratories' entry in this market is a 15-megahertz scope that weighs just

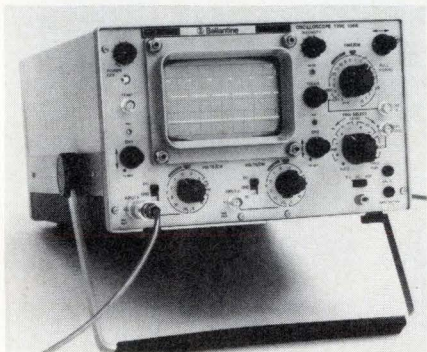

under 20 pounds, consumes about 28 watts, and sells for \$845. The model 1066A is a dual-channel instrument with a built-in delay line, sensitivity to 5 millivolts per centimeter (improving to 1 mV/cm at reduced bandwidth), front-panel voltage calibrator, fully regulated power supplies, and a TV sync stripper for optimum triggering of the sweep when working with cathode-ray tube displays.

The scope has two identical vertical channels that have 3-decibel passbands extending from dc to 15 MHz. Each channel has a rise time of 24 nanoseconds, and vertical deflection factors variable from 5 mV/cm to 20 V/cm in 12 calibrated steps. Uncalibrated verniers provide continuously variable adjustment between steps and extend the minimum sensitivity to beyond 50 V/cm. All of the calibrated steps are accurate to within 3%. The input impedance is 1 megohm in parallel with 28 picofarads.

The two vertical amplifiers can be

cascaded to provide a single channel with a sensitivity to 1 mV/cm over a passband from 5 Hz to 5 MHz. The cascaded amplifier has a rise time of 70 ns and a maximum calibration error of 6%.

The time base is variable from 0.5 microsecond/cm to 1 second/cm in 20 calibrated steps, with a continuously variable vernier for overlap between steps. The accuracy of the calibrated steps is within 3% over the central 8 cm of the CRT scale. A 10× magnifier operates over the full time base, thus extending the sweep rate to 50 ns/cm. The magnified time base is accurate to within 5% over the central 8 cm of the 10-cm CRT scale.

A novel feature of the 1066A is automatic mode selection for the dual-trace display. The chopped mode is selected for sweep rates from 1 ms/cm to 1 s/cm, inclusive; and the alternating mode is chosen for time base ranges from 0.5 ms/cm to 0.5 μs/cm. Z-axis blanking of the switching transients caused by the 250-kHz chopping signal is provided.

The scope's built-in delay line permits viewing of the leading edge of the triggering waveform. The line is of the printed-circuit type, and introduces a nondistorting signal delay of approximately 150 ns.

Any supply voltage from 95 V to 130 V, and 190 V to 260 V, can be accommodated by quick-change six-position switch on the rear panel. The supply-voltage frequency can be 45 Hz to 440 Hz.

Ballantine Laboratories, Inc., P.O. Box 97, Boonton, N.J. 07005 [351]

## Synthesizers keep 0.1-Hz resolution up to 13 MHz

Two automatic frequency synthesizers from Hewlett-Packard maintain a resolution of 0.1 hertz over the frequency range from 0.1 Hz to 13 MHz. The two units contain read-only memories for digital control of all instrument operations, thus permitting true digital sweeping—that is, synthesizer accuracy—at every step in the sweep.

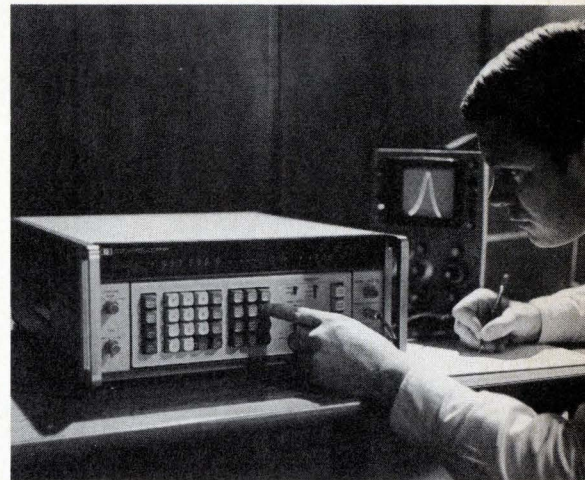

The model 3330A, at \$5,100, has a manual amplitude control with built-in leveling to ±0.5 decibel. At \$6,000, the model 3330B provides automatic amplitude control—including amplitude sweeping—over a 100-dB range. This instrument maintains an amplitude resolution of 0.01 dB over its full output range. Maximum power out of either synthesizer is +13 dBm.

Both synthesizers use an ovenized quartz crystal oscillator as a frequency standard. The drift of this oscillator is less than one part in 10<sup>8</sup> per day. Higher and lower stability references are also available.

Although no internal amplitude modulation is included in either instrument, both can be amplitude-modulated by an external signal as high as 100 kHz. This a-m can be applied even when the frequency is being swept.

While synthesizers are widely known to have excellent long-term stability, their spectral purity is usually not very good. In these instruments, however, spurious signals are at least 70 dB below the carrier, while harmonics are at least 40 dB down.

Hewlett-Packard Co., 1601 California Avenue, Palo Alto, Calif. 94304 [352]

## Direct-recording oscillograph has built-in duration control

A direct-recording oscillograph, the Visigraph-300 offers built-in duration control, and 12 galvanometer

## Centralab Rotary Switches... in line with your design requirements



Write  
Centralab  
for  
Bulletin  
No. 1101S(R)2

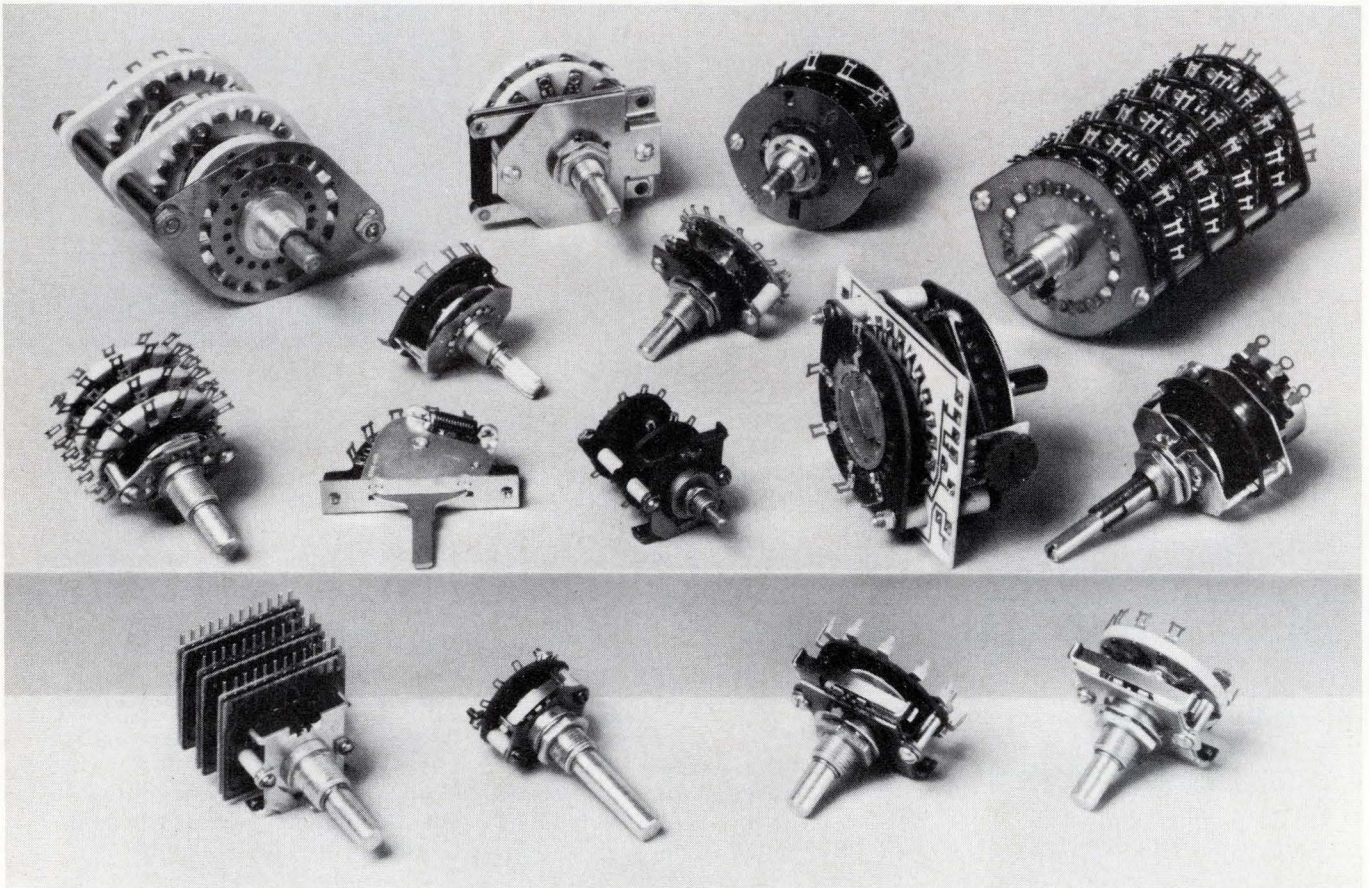

## Do you identify with this group?

The group is Centralab's rotary switch line—preferred by over half of today's design engineers. In unbiased product preference studies conducted annually by several leading electronics magazines, design engineers identified Centralab rotary switches as their first choice by a 2 to 1 margin.

And for good reason, too! Because most of you came to Centralab for a special rotary switch capability. And you got it.

Over 35 years of experience in solving switching problems is the reason Centralab can offer you a most extensive and growing line of standard switches. Now, for example, you can select from four new series of miniature and subminiature switches that feature a dual-ball sidethrust mechanism

for top index performance and exceptionally good torque and feel. Adjustable stop models require no disassembly or removal of stop tabs. You can easily change stops by varying the placement of one or two stop rings in the front plate. For torque adjustment you just change index springs on an otherwise completed switch. You can choose from a wide variety of section materials too, including diallyl phthalate for the highest insulation resistance.

When you come to Centralab you widen your choice of rotary switches—types, sizes, configurations, ratings and other options. You get the right switch at the right price. If you're not in that group, find out how the other half lives. Write Rotary Switch Sales Manager, Centralab.

### GET CENTRALAB THE "IN" LINE FOR YOUR DESIGN

Hybrid Microcircuits  
Pushbutton & Rotary Switches  
Capacitors  
Potentiometers  
Technical Ceramics  
Ceramic Packages  
Semiconductor Devices



**CENTRALAB**

Electronics Division  
GLOBE-UNION INC.

5757 NORTH GREEN BAY AVENUE  
MILWAUKEE, WISCONSIN 53201

# Centralab distributors identify with your switch requirements

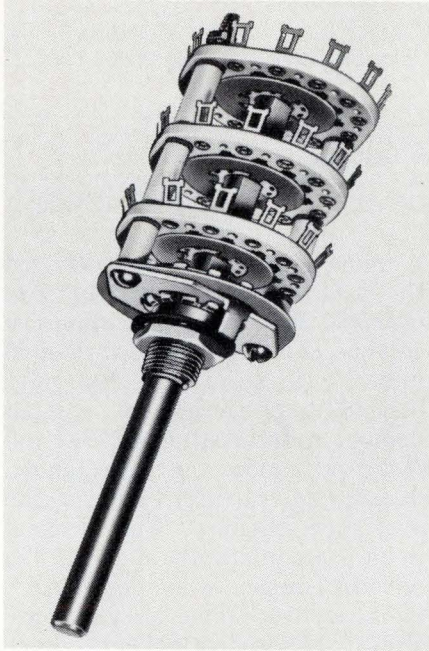

Centralab Distributors are your number one source for the number one line of standard rotary switches. You can select the switch you need — off the shelf — from all sizes and types, in prototype or small production quantities with immediate delivery. It's this kind of availability that lets you obtain the right switch for your design requirements every time. And, it's been that way for over 35 years.

Centralab Distributors also carry component switch parts in kit form for convenient field repair and economical prototype switch assembly.

When you need a rotary switch, look to your Centralab Distributor first. For a complete catalog of Centralab switches and switch kits, see your distributor or write Centralab Distributor Products, Dept. RS-1.

DISTRIBUTOR PRODUCTS



## New products

channels are available for recording data from dc to 13 kilohertz. Trace identification is also provided, along with 12 paper speeds from 0.2 to

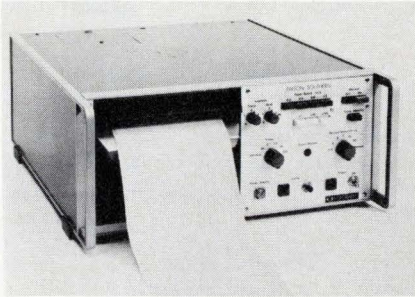

120 inches per second, and an optional 1,000:1 speed divider is available. Individual intensity controls for both grid lines and the signal traces permit adjustment for records at any chart speed. Price of the model 300 is \$2,200.

Dixon Inc., P.O. Box 1449, Grand Junction, Colo. 81501 [356]

Precision pulse generator repeats to 250 kilohertz

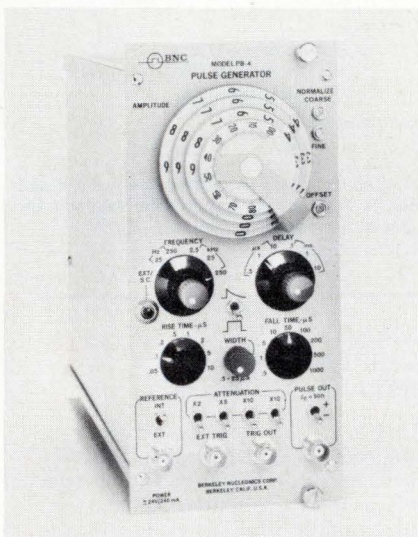

Both stability and versatility are provided in the model PB-4 pulse generator. The temperature stability of the output pulse is better than  $\pm 5$  parts per million/ $^{\circ}\text{C}$ , and the linearity is within  $\pm 5$  ppm. The generator may be loaded into 50 ohms without affecting these specifications. Independently adjustable rise and fall times are also provided, and the unit has a maximum repetition

rate of 250 kilohertz. Price of the PB-4 is \$1,450.

Berkeley Nucleonics Corp., 1198 Tenth St., Berkeley, Calif. 94710 [355]

Integrator-fluxmeter holds deviation to 1% of full scale

The model 701 integrates any voltage signal applied to its input terminal. The unit includes digital switches and a light-beam meter. The instrument can also be used as a fluxmeter or Gaussmeter and in

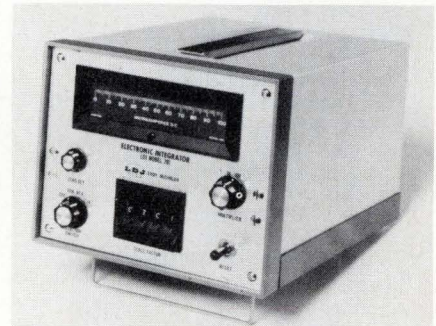

such equipment as permeameters, magnetic field surveyors, ferromagnetic detectors, instrumentation systems, production test equipment, stray flux detectors, and hysteresis loop tracers. The 701 is accurate to within 1% of full scale, and output terminals provide a signal adequate for driving an X-Y recorder.

LDJ Electronics Inc., 741 Owendale, Troy, Mich. 48084 [357]

Lock-in photometer offers synchronous detection

The model 20 lock-in photometer provides synchronous detection to extract small light signals from high ambient noise. The unit operates with voltage or current sources. Fre-

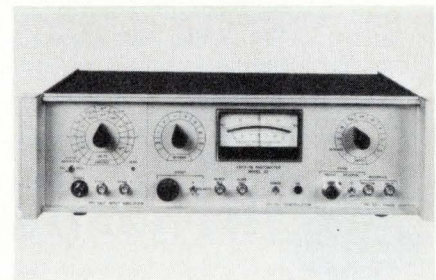

# ADLAKE DRY REED RELAYS

Quality and reliability are key design parameters built into Adlake's complete line of DRY REED RELAYS. Advanced electrical, mechanical and packaging features qualify these *standard*, *intermediate*, and *miniature* size devices for an extremely wide range of commercial, industrial, and military switching applications, such as control panels, machine process control instrumentation, and telephone and communications apparatus, to mention just a few.

## ELECTRICAL DETAILS:

- Contact Arrangements:**  
Up to 4-A or 2-B
- Contact Current Ratings:**  
Switch 0.5 A; carry 3 A (Miniature & Intermediate)  
Switch 1.5 A; carry 6 A (Standard)
- Contact Resistance:**  
Initial—50 milliohms max.; end-of-life—2 ohms max. (Standard)  
Initial—200 milliohms max.; end-of-life—2 ohms max. (Intermediate & Miniature)
- Contact Life:**  
Rated Loads—20 x 10<sup>6</sup> operations  
Dry Circuit—500 x 10<sup>6</sup> operations
- Contact Voltage Ratings:**  
100 VDC or 150 VAC (Miniature or Intermediate)  
150 VDC or 250 VAC (Standard)
- Insulation Resistance:**  
10<sup>12</sup> ohms (min.)
- Operating Speed:**  
1 to 2.5 ms (Miniature & Intermediate)  
2.5 to 4.5 ms (Standard)  
(Varies with sensitivity and number of poles; including contact bounce and coil time)

## MERCURY WETTED CONTACT RELAYS

Low, stable contact resistance and "1-billion-operation" life qualify Sensitive Mercury Wetted Contact Relays for a wide array of switching applications, such as digital and analog computers, telecommunications system, multiplex, industrial control equipment, power control devices. New Series MWK and AWK Sensitive Relays offer contact form K (SPDT, center off)—ideal for multiple channel switching.

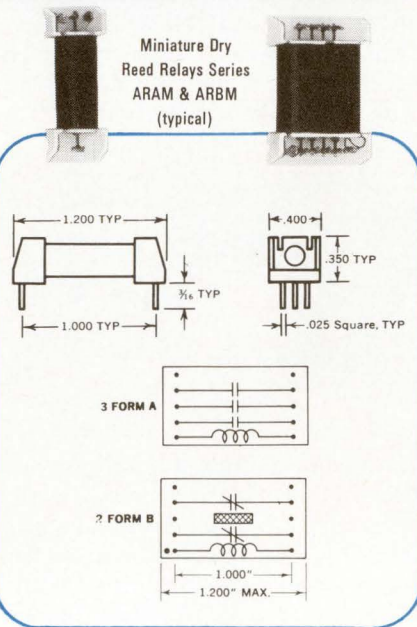

## PACKAGING DETAILS:

- Environmental Protection:**  
Hermetically sealed contacts. Rhodium plating on contacts for higher loads and longer life characteristics.
- Shielding:**  
Magnetic shielding layer
- Shock:**  
200G max. 11 ± 1 ms (Miniature & Intermediate)  
100G max. 11 ± 1 ms (Standard)
- Vibration:**  
30 G max. 0-1700 cps (Miniature & Intermediate)  
0-600 cps (Standard)
- Temperature Range:**  
—55 to 105°C
- Choose from 123 cataloged items. Dry Reed Relays with special features are available on special order with surprisingly short delivery times.

## MERCURY DISPLACEMENT RELAYS

Time delay and load relays meet the toughest, most demanding switching applications. Non-adjustable time delay relays offer contact forms A and B with delays up to 1 hour, current ratings to 15 amps. Load relays switch from 30 to 100 amps with contact forms A and B.

USE READER SERVICE NUMBER FOR COMPLETE INFORMATION



**THE ADAMS & WESTLAKE COMPANY**

ELKHART, INDIANA 46514 • 219 • 264-1141 • TWX 219 • 522-3102 • TELEX 25-8458 • CABLE ADLAKE

## New products

quency is continually tunable, reference signal locks automatically, and digital phase shifting is stable and accurate in resolution. Of modular construction, the model 20 includes phase shifter, amplifier, and demodulator.

Pacific Photometric Instruments, 5745 Peladeau St., Emeryville, Calif. 94608 [353]

## Counter in kit form covers 1 Hz-100 MHz range

A frequency-counter kit, designated the IB-1101, ranges from 1 hertz to over 100 megahertz. The input circuit accepts levels from less than 50 millivolts to more than 200 volts, depending on frequency, without damage to the instrument. The full five-digit readout can be expanded to eight-digit capability by using the overrange circuitry. The decimal point is automatically placed in the selected range, while megahertz, kilohertz, over-range, and gating are indicated by front panel lights. Price is \$269.95.

The Heath Co., Benton Harbor, Mich. 49022 [354]

## Generator combines many signal sources in one unit

A multifunction generator, the model 146, offers many signal sources in one package. Features include sweep frequency modulation,

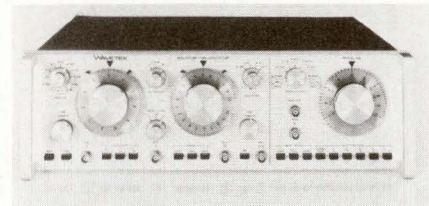

amplitude modulation, frequency-shift keying, triggered and gated operation, and swept amplitude modulation. The unit requires no external drive modules, and calibrated sweep and modulation of frequency and amplitude are provided. Price is \$1,495

Wavetek, P.O. Box 651, San Diego, Calif. 92112 [358]

# Sensitive & versatile



## New RCA Picoammeter measures direct current from 1 picoampere to 30 mA

- Solid-state components
- AC or battery operated
- Price \$250\*
- Full 12-month warranty on parts and labor... complete replacement parts availability

A high quality, extremely sensitive precision test instrument, with many capabilities usually found only in more costly equipment, the new easy-to-use RCA WV-511A is available through local RCA distributors.

This picoammeter measures low levels of direct current from 1 picoampere to 30 mA in 18 overlapping ranges. Accuracy is independent of source resistance. All ranges are easily selected with convenient pushbutton switches.

The WV-511A also serves as a high input-resistance voltmeter, as a megohmmeter, and as an amplifier.

Versatility of its design gives this picoammeter wide application in electronics, chemistry, metallurgy, biology, medicine, radiation, and other sciences. Specific uses include the measurement of minute currents in solid-state de-

vices, electron tubes—vidicons, image orthicons and photomultipliers, and mass spectrometry applications.

For further information, contact your local RCA Distributor or write RCA Test Equipment Headquarters, Harrison, N.J. 07029.

\*Optional Distributor Resale Price

**RCA** Electronic Components

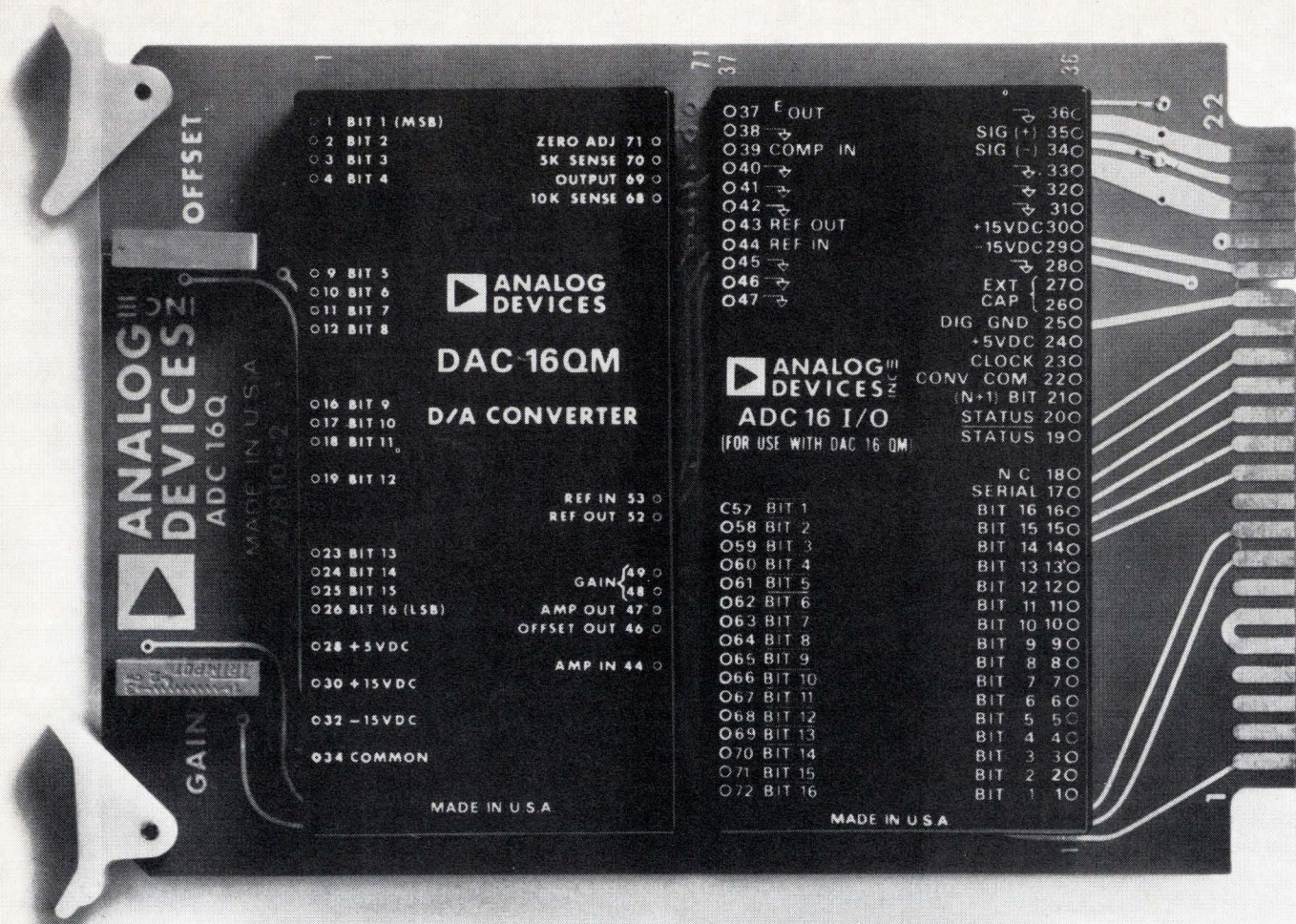

## This little converter has twice the dynamic range of any little converter you've been able to buy before. Even from us.

This is the first modular analog to digital converter that can measure from 150  $\mu$ V to 10V. That takes 16 Bit resolution.

It's our ADC 16Q.

As you can see, we've put this binary A/D converter on a compact 4½" x 6" printed circuit card.

It does the job you can only do now using both a 12-Bit A/D converter and a programable gain amplifier. And it's faster.

One of its two modules is the proven DAC 16QM digital to analog converter we've been giving you right along. The other is a carefully designed I/O module.

For components, we've used closely matched switches and resistor networks. And the most stable zener diode around.

You get relative accuracy of  $\pm 0.0015\%$  and even high

common mode rejection. Which makes our 150  $\mu$ V measurement mean something.

You can apply our ADC 16Q anywhere you're measuring over a wide dynamic range. Like gas chromatographs, mass spectrometers, electro optical instruments, and multi-point data acquisition.

And you can apply it now because units are available.

One of the reasons this little converter is a lot of converter is because we made it. And we make a lot more little converters than anyone else.

You can see them all by asking for our 1972 Product Guide.

Analog Devices, Inc., Norwood, Mass. 02062 Tel. (617) 329-4700.



ADC-16Q. INPUT CMRR of Input Buffer. DC to 100Hz: 100db typ. ACCURACY Linearity Error -20°C to 30°C.  $\pm 0.0015\%$  +.0005% max. Temperature Coefficient - Gain:  $\pm 0.0008\%/^{\circ}$ C max. Stability - 24 hours. Linearity:  $\pm 0.0005\%$ . Gain:  $\pm 0.0003\%$  max. Zero:  $\pm 0.0002\%$  max.



Data handling

## Disk challenges data cassettes

---

Flexible recording medium offers 60-ms random access, 1.2-megabit transfer rate

---

The digital tape cassette offers an economical way to store data without spending \$8,000 to \$10,000 for a disk file system. Now there is another alternative, the Iodisc series I, a flexible magnetic disk storage system from Iomec Inc.

Avery Blake, vice president of marketing, says that Iodisc offers disk-drive performance at cassette prices. A 250-kilobyte system, for example, costs about \$4,000.

But unlike the cassette system, Iodisc has a random-access time of only 60 milliseconds, and a data-transfer rate of 1.2 megabits per second. Blake says that to write 2,000 128-character records would require 3 to 6 minutes with a cassette system, compared with 9 seconds for Iodisc series I. The comparison is even more dramatic in reading out data: to seek and read out the 2,000 128-character records at random would take 3 minutes with Iodisc, but the cassette system would need from 5 to 11 hours, he says.

Iodisc employs a flexible magnetic disk developed by Iomec and called Cartridisc. In some ways, the concept is similar to IBM's floppy disk [*Electronics*, Aug. 16, 1971, p. 84] and Memorex's model 650 flexible disk drive. But the Iodisc head does not contact the disk.

Blake says that the Iodisc series I is intended for both program and data storage. For users who want both at the same time, a dual-drive unit is available. Other configurations include a single master disk and both one- and two-slave disk units that share the masters' electronics, but contain their own servo drive electronics. The third type is a basic unit that contains drive electronics, read/write decoding and

drive status, as well as addressing and line drivers and receivers that will connect to an external controller.

Cartridiscs are available in four versions, each with 64 tracks. The differences are in the number of sectors per track. Sector information is permanently recorded on the disk. Prices range from \$2,000 for a basic unit ordered in quantity to \$6,500 for a dual-drive master unit.

Iomec Inc., 345 Mathen St., Santa Clara, Calif 95050 [361]

---

## Now, converse with your calculator

Anyone looking for a top-quality calculator or an easy-to-use mini-computer without artificial machine rules, procedures, or languages, may find that the new Hewlett-Packard Co. 9820A programable desktop calculator is the answer. At least, it's

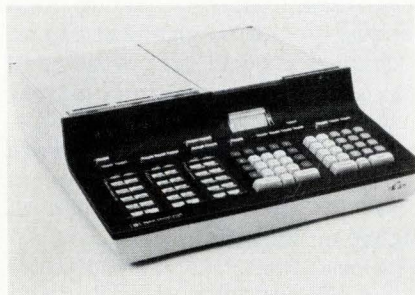

a \$5,475 answer. To solve a problem, the user simply enters the equations on the keyboard exactly as he would write them on paper, and then commands the calculator to start.

This interactive terminal, with instant display capability, can be programmed in algebraic language. Not only will the calculator solve the problem, but, depending on the peripheral chosen, the answer will be displayed on an X-Y plotter or a typewriter. In addition, a broad selection of input peripherals provides an option of choosing the best-suited format.

The digitizer is perhaps the most unusual of the input options. It automatically converts graphics into digital data to be analyzed by the calculator.

Model 9820A can accept both programs and data. It combines the traditional programable calculator keyboard with the best features of simple computer language, such as Fortran and Basic.

Once the entire algebraic expression is entered, it's executed or stored in the calculator's registers, and a thermal printer provides hard copy. If a language syntax error has been made, an error note appears immediately, and the calculator will not accept further entries until the error is corrected. Moreover, there is full editing capability. For example, a symbol or complete line can be deleted or changed, and a different request or instruction inserted without destroying the rest of the program. When a line is added, the entire program is automatically adjusted to use minimum memory.

The basic model 9820A is supplied with 173 registers and can be expanded internally to 429 registers. With this expanded power, the 9820A can solve up to 36 simultaneous linear equations with 36 unknowns; the basic model can handle 17 equations with 17 unknowns.

Of the five banks of standard keys, three can be customized by inserting a plug-in read-only memory module and placing on the key bank the associated template defining the new key functions. These plug-ins now include mathematics, user-definable functions, and peripheral devices. The mathematics module allows the user to perform common trigonometric and logarithmic functions on the information stored in any register, the user-definable module allows five to 25 keys to be dedicated to a particular program, and the peripheral module provides the proper interfacing.

Delivery is from stock.

Hewlett-Packard Co., Box 301, Loveland, Colo. 80537 [362]

---

## Impact line printers have variable operating speeds

Two impact line printers offer variable-speed operation, depending on the number of print columns used.

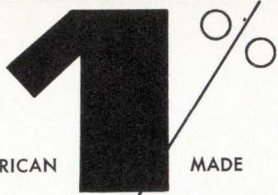

AMERICAN

MADE

# Tolerance SCHAUER 1-Watt ZENERS

## Immediate Shipment Low Prices

ANY voltage from 2.0 to 18.0

Quantity	Price each
1-99	\$1.07
100-499	.97
500-999	.91
1000-4999	.86
5000 up	.82



All welded and  
brazed assembly

No fragile  
lead heads

Write for complete  
rating data and other  
tolerance prices.

## Buy the kit- Save a lot

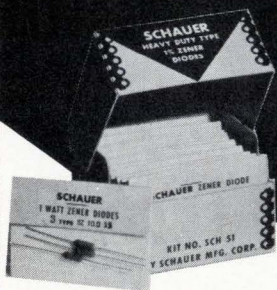

Kit contains a 51-piece assortment of SCHAUER 1% tolerance 1-watt zeners covering the voltage range of 2.7 to 16.0. Three diodes of each voltage packaged in reusable poly bags. Stored in a handy file box. Contact your distributor or order direct.

A \$54.57 value for  
ONLY **\$24<sup>50</sup>**

Semiconductor Division

# SCHAUER

Manufacturing Corp.

4514 Alpine Ave. Cincinnati, Ohio 45242  
Telephone: 513/791-3030

## New products

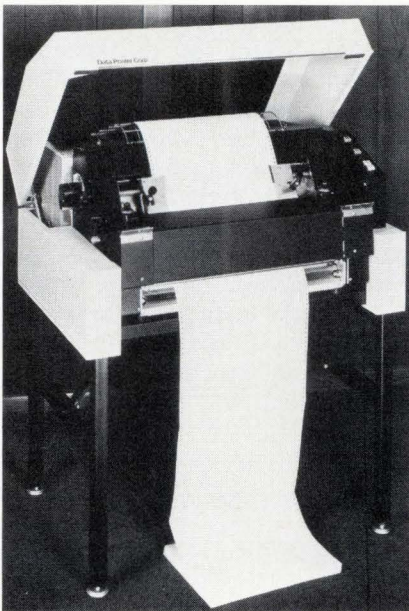

The model 246 prints the full 132-column format at 200 lines per minute, 96 columns at speeds to 400 lpm, and 48 columns to 600 lpm. The model 306 prints 132 columns at 300 lpm and can operate at 600 lpm when using 96 columns. Both models provide 64-character drums, 8-channel vertical formatting, and several options, such as special character fonts, 12-channel vertical formatting, and parity check. Price starts at \$5,500 each in OEM quantities for the model 246 and at \$6,100 for the 306.

Data Printer Corp., Msgr. O'Brien Highway, Cambridge, Mass. [363]

## Minicomputer line tailored to wide range of jobs

Six models of the SPC-16 minicomputer line are aimed at the low end, middle range, and high end of the market. The 16/45, 65, and 85 are designed for applications that require basic hardware at a minimum price, and the 16/40, 60, and 80 are for the middle range when self-contained processing power and input-output are required. The 16/45, 65, and 85 can be upgraded when extensive I/O capability, large memory capacity, and a full repertoire of software are needed. The low-end machines have a minimum memory of 4,096 16-bit words, op-

tional processing features, and an external I/O package, each of which can be expanded. At the high end, the minicomputers have 65-million-word memory capacities and speeds as fast as 80 nanoseconds. Prices range from \$3,950 to \$8,550.

General Automation Inc., 1055 S. East St., Anaheim, Calif. 92805 [364]

## Data coupler links computer to industrial machines

A data coupler called the model 400M accepts the control voltage signals from industrial machines and provides an isolated output that is compatible with multiplexed cabling systems. The coupler may be used with any of a number of computers, including the IBM System/7. Input signal surge suppression, an input signal level threshold, and a long-time-constant filter prevent damage to the coupler and erroneous output signals caused by conditions in industrial environments. Price is \$21.34 each in quantities of 250.

Greentron Inc., 112 Perimeter Rd., Donaldson Center, Greenville, S.C. 29605 [365]

## Contacting keyboard aimed at calculator market

A contacting keyboard for desk calculators and other devices provides keyboard assemblies with both momentary and alternate action. Features include normal typewriter keystroke, snap closure action, life expectancy in excess of 10 million operations, and contact bounce time of less than 1 millisecond. The unit is particularly suited for switching



# GO FAIL FREE

LOWEST PRICE  
CO<sub>2</sub> CHAMBER... **\$395**

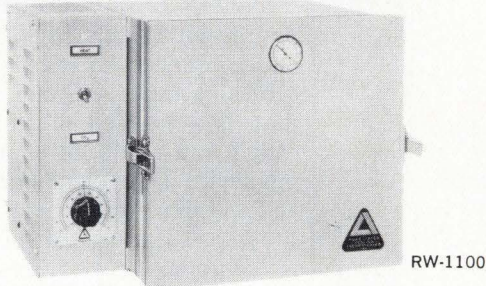

RW-1100

Now you can **Go Fail Free** without going broke! \$395 buys Associated's Model RW-1100 full range low/high temperature chamber, a compact bench unit lab-engineered specifically for small parts and assembly testing and quality control. Associated hasn't scrimped on quality at your expense either. Look at the full performance features you'll get: -100°F to +350°F range (¾° stability)... half cubic foot work area... door-mounted temperature readout... solid state temperature control... liquid CO<sub>2</sub> cooling.

LOWEST PRICE  
MECHANICAL CHAMBER...

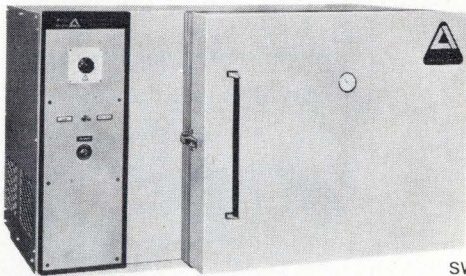

SW-5101

For a full range military testing capability, Associated's benchtop model SW-5101 extends from -100°F to +350°F at a phenomenally low cost. Add a host of other advantages such as single compressor design for simplified maintenance... all solid state control... high temperature failsafe. All for \$970!

Both units are fully presented in the all-new, complete Associated Environmental Equipment Catalog M-7-2. Why not get the whole story today?

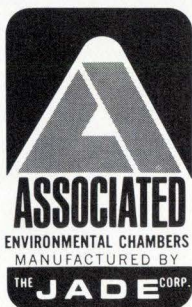

ASSOCIATED/JADE HUNTINGTON VALLEY, PENNA. 19006 • (215) 947-3333

25,000 chips per hour...mean

**LARGEST INVENTORY  
FASTEST DELIVERY  
LOWEST COST  
FINEST QUALITY**

...from **USCC/Centralab**

Yes, it's true! Because demand for ceramic chip capacitors in hybrid microelectronics will more than double within the next two years, USCC's production capability on popular sizes will increase to 25,000 per hour by mid-1972. That's over 50 million annually, with a demonstrated failure rate level of only .001%/1000 hours.

New automation techniques and materials cost reduction mean to you as a customer: fastest delivery and lowest prices on the finest quality ceramic chip capacitor on the market.

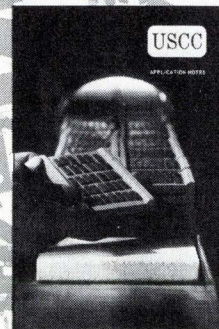

For your free copy of our Ceramic Capacitor Catalog and Applications Manual on how to use chip capacitors more advantageously, write: USCC/Centralab, 2151 N. Lincoln Street, Burbank, California 91504 or circle the information retrieval number below.

**USCC**

U. S. CAPACITOR CORPORATION



CENTRALAB  
Electronics Division • GLOBE-UNION INC.

# The new McGraw-Hill Building

in Rockefeller Center

## Eight floors available

Approximately 330,000 square feet available for sub-lease. Choice location at 1221 Avenue of the Americas in Rockefeller Center. 51 stories high, plazas, promenades, underground concourses. Unequaled operational standards. IND Subway Station "in the building." Theatres, restaurants, hotels and stores just minutes away. Modular office design provides ultimate layout flexibility. 280 seat auditorium. 1,200 seat cafeteria.

## Rental information

Contact McGraw-Hill's real estate consultant, James D. Landauer Associates, Inc., 200 Park Avenue, New York, N.Y. 10017, telephone (212) 687-2323; or your own broker, or John M. Holden, Vice President, McGraw-Hill, Inc., 330 West 42nd Street, New York, N.Y. 10036, telephone (212) 971-2382.

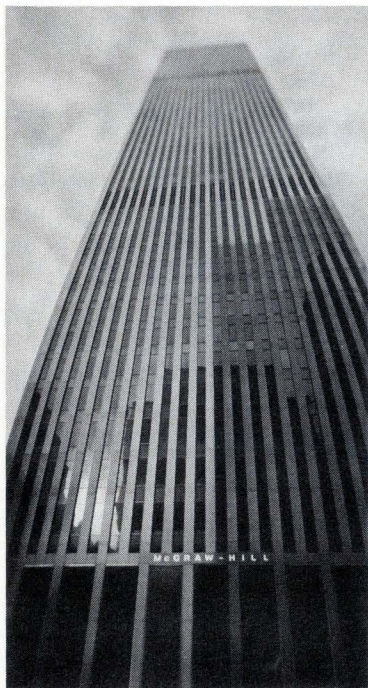

## New products

low-current loads found in metal oxide semiconductor and transistor-transistor logic

Colorado Instruments Inc., 1 Park St., Broomfield, Colo, 80020 [366]

Programmable coupler permits replacement for printer

Systems now using Hewlett-Packard printers can be interfaced to teletypewriters, paper-tape punches, cassette tapes, calculators, or small computers with the model 305-5050 plug-to-plug replacement. The unit, which connects to the printer input cables, accepts parallel BCD data that is serialized, formatted, decoded, and used to drive the recording device. Data can be generated in any sequence with any character desired so that tapes can be produced in compliance with existing software.

Data Graphics Corp., 8402 Speedway Dr., San Antonio, Texas 78230 [367]

Digital printers operate at 180 lines per minute

The DM-500 series of digital printers is available as a complete unit or with the electronics on a printed-circuit board. Printout rate is 180 lines per minute, and the print mechanism can be supplied as a

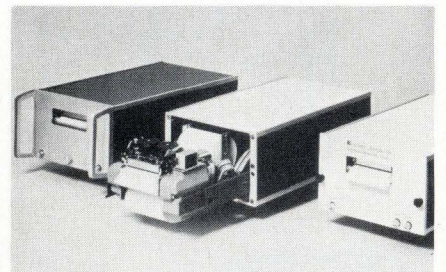

separate unit. The printer subassembly can interface with a Seiko print mechanism. The print motor drum operates either continuously or on demand. The motor, which is automatically controlled, operates only during the print cycle. Prices range from \$600 to \$720.

Keltron Corp., 225 Crescent St., Waltham, Mass. 02154 [368]

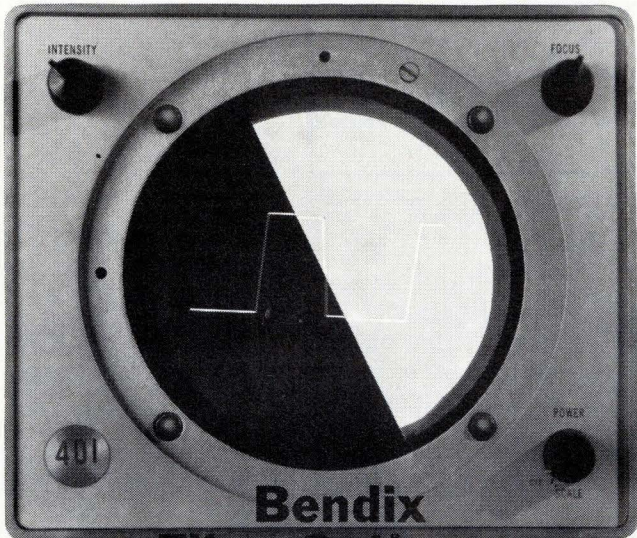

**Bendix**  
**Fiber Optic**  
**Faceplates**  
**are Bright,**  
**Sharp, Clear,**  
**and Cheap.**

Yes, cheap.

Over the last ten years, Bendix developed and produced our first 250,000 fiber optic faceplates for the military.

They were the expensive ones – what with the cost of R&D, prototypes, tool-ups and all. But they were excellent; met or exceeded all government specifications for brightness, resolution, contrast, etc.

And now, with the costly part behind them, our FO faceplates have been declassified by the military. So, they're on the open market.

At very competitive prices. (Or they *would* be if we had any real competition).

Actually, the units we're producing now will cost you about 1/6th of what one of our first 250,000 would have.

That's cheap.

But only the prices have changed. Which means you can improve your products with increased contrast, hard copy options, or off-axis filter characteristics of fiber optics in – video displays, business machine readouts, cockpit annunciators – just as the military has done in advanced facsimile equipment and aircraft. At a fraction of the cost.

And fiber optic faceplates are available for immediate delivery.

Doesn't that turn you on?

For more information contact: The Bendix Corporation, Electro-Optics Division, Galileo Park, Sturbridge, MA 01518. TEL: (617) 347-9191.



**emi/rfi filters...**

**STOCK**  
**TO**  
**TWO**  
**WEEKS**

**...from USCC/Centralab**

If you have an EMI/RFI problem—contact us first. That's because we've amassed an extensive distributor inventory on popular size EMI/RFI filters ready for immediate delivery. In addition, we've stocked our production shelves with all the components necessary to deliver other sizes in not more than two weeks. And if you have a custom requirement we have a staff of applications engineers whose business is solving your specific problem... and fast.

Before you buy, contact a reliable source for highest quality EMI/RFI filters—USCC/Centralab, 2151 N. Lincoln St., Burbank, California 91504 • (213) 843-4222.

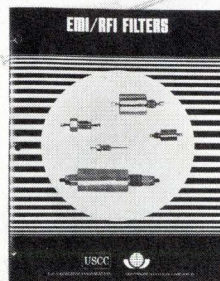

Send for your free copy of our EMI/RFI Catalog containing complete technical data on: Miniature Ceramic 1000/2000 Series, Subminiature Ceramic 3000 Series, 8000 Series for Data Processing Equipment, and 9000 Series Ceramic Feed-thru Filter/Capacitors.



**CENTRALAB**  
 Electronics Division • GLOBE-UNION INC.

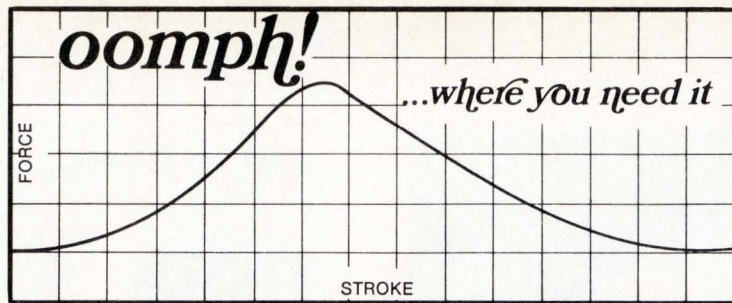

At Ledex we shape solenoids to give you the exact force and stroke you need.

**All about oomph . . . and where to get it**

The engineer needed a 2" stroke. Little force at the start, then a 40 lb. wallop in the middle. To reduce impact at the end, he wanted the force to tail off.

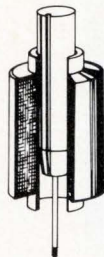

We call our answer the solenoid with the oomph in the middle. Just as the curve shows, it's designed so the maximum output comes out near the center of the stroke.

For other actuating applications, there are over 300 Ledex shelf model solutions to choose from. Here are just three examples:

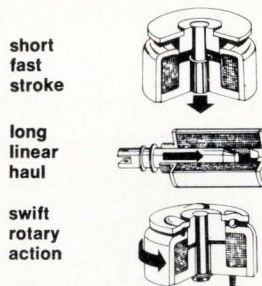

short fast stroke

Move a short stroke load in 5 to 10 milliseconds with a Ledex flat-face pancake shape solenoid.

long linear haul

You can move big loads far with Ledex tapered plunger cylindrical solenoids.

swift rotary action

For action in an arc or uniform linear movement, or both, consider a Ledex rotary solenoid.

To get the exact force, stroke and speed you need, just describe your application to our actuating technology people. If your exact answer isn't already on our shelf, we'll design one for you.



*the total technology people*

**LEDEX INC.**  
123 Webster Street  
Dayton, Ohio 45401  
(513) 224-9891

POSITIONING · SWITCHING · MICROELECTRONICS

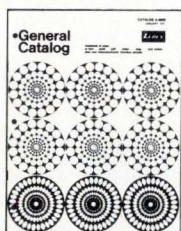

Over 400 ways to turn . . . push . . . pull . . . index . . . step . . . and switch, plus new microelectronic interface circuits. All from the shelf.

Ask for Catalog A-9500

*new things  
keep  
happening  
at Ledex*

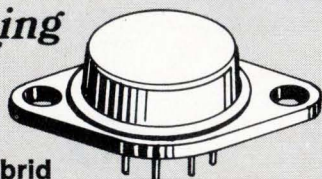

**. . . like this hybrid thick film driver**

If you're working with a control signal that can only deliver 10 milliamps and you really need 5 to 7 amps, consider the Ledex LMD-5 power driver.

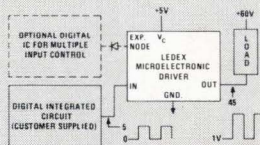

With the LMD-5 you can switch up to 325 watts. It has an expander node terminal, so you can add multiple inputs. An internal diode protects the circuit from damage when driving inductive loads.

Available from the shelf in 1-9 quantities at \$32.07 each. Only \$14.30 each in 1,000 lots.

Semiconductors

## And now— a DVM on a chip

Almost all the logic for 4½-decade voltmeter is built into silicon-gate MOS IC

An electronic calculator on a single monolithic IC and even a digital clock on a chip are now commonplace. But Fairchild Semiconductor has gone one better step and put a digital voltmeter on a chip.

The Fairchild 3814 p-channel silicon gate MOS IC contains almost all the logic required for a four-and-a-half-decade digital voltmeter. That includes all the BCD counters, latches, and display multiplexing logic, plus generation of the control signals needed for dual-slope integration. The BCD outputs will directly drive a 9315 BCD to Nixie or a 9307/9337 BCD to seven-segment decoder, and feeding back the digit-select output will generate zero suppression on-chip. Outputs are also available for over-range and under-range indication.

As the diagram shows, the 3814 chip consists of four-and-a-half decades of BCD counters with a modulus of 40,000 clocked by a separate TTL-compatible input. To mask any noise generated by the analog circuitry, a 10-count pause is incorporated at the start of each cycle. The output of the second decade is gated with the clock and brought out off the chip to provide a clock-pulse output for every 100 input clock pulses—this is the divide-by-100 output at the top of the diagram, which is used to drive the output multiplexer. Also, the output of the first flip-flop of the 1,000-decade is buffered and brought directly off the chip—this is the divide-by-2,000 output that can be used to down-range in an autoranging setup.

Other logic outputs brought out as control functions include QE1 and QE2, which are the outputs of both flip-flops of the fifth half-decade,

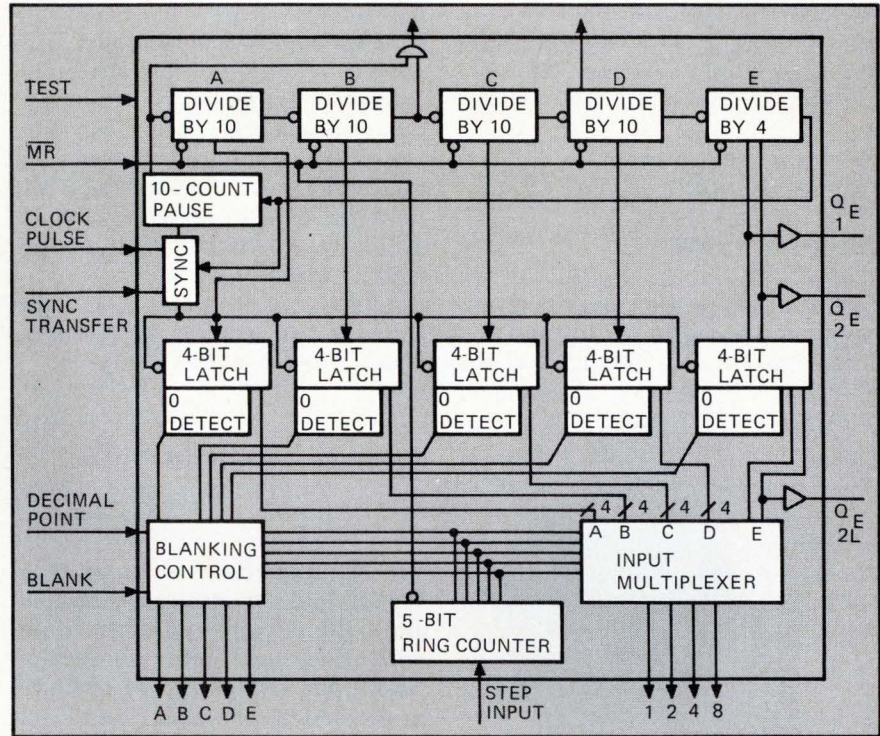

and QE2L, which is the latched state of the most significant bit. These outputs control the integration period of the dual-slope circuitry. By gating QE1, QE2, the divide-by-2,000 output, and the comparator, an under-range signal can be generated.

A transfer input causes the data in the counters to be stored in latches. This input is edge-sensitive, and is synchronized internally with the clock. When the transfer input goes from high to low, the circuit is enabled, so at the time the clock goes low, data will be stored.

A transfer command is permitted only once during a count cycle and occurs when an internal flip-flop is reset by the terminal count transition from 39,999 to 00,000. It is set when the first transfer occurs, and remains set until the next count.

The latched state of each decade is multiplexed out as BCD data on the outputs labeled A, B, C, D, E. The multiplexer is driven from a 5-bit ring counter with outputs that are also available as 1, 2, 4, 8. The ring counter is clocked by the step input which causes the stored data to appear, decade by decade, on the 1, 2, 4, 8 outputs. One of the A-E outputs will be high, indicating which decade is being displayed so

that it will strobe the display. The blank input makes all five A-E outputs go low, and, since these outputs are used to turn on display lamps in a multiplexed display scheme, the display will go blank. The 3814 will be available by mid-March and will cost \$16.25 each in quantities of 100.

Fairchild Semiconductor Corp. 313 Fairchild Drive, Mountain View, Calif. 94040 [411]

## RF power amplifier delivers 5 W over 500 MHz to 1 GHz

A transistorized rf wideband power amplifier operates from 500 megahertz to 1 gigahertz and puts out 5 watts. Called the model LWA 510-4, the unit, operating as a linear amplifier, will deliver a minimum of 4 w at the 1-decibel compression point, and will exhibit second harmonics down to a least 33 dB below the fundamental signal. The input VSWR is typically 1.5:1, and the out-

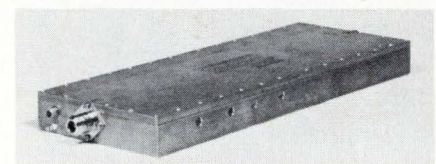

## New products

put VSWR is typically 1.8:1. Price is \$2,850.

Microwave Power Devices Inc., 556 Peninsula Blvd., Hempstead, N.Y. 11550 [413]

LED numeric readout  
is 0.6 inch high

Believed to be the largest seven-segment numeric light-emitting diode display on the market, the Data-Lit 62 provides a character

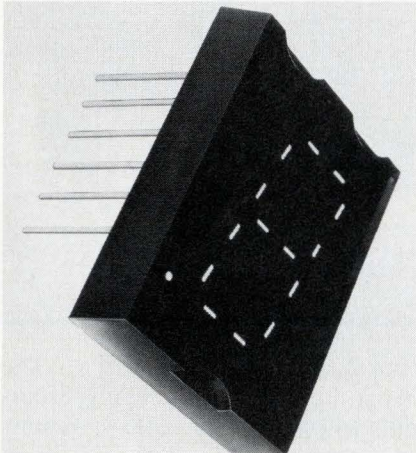

height of 0.6 inch. It is built for control panels, digital clocks, and other beyond-arm's-length displays. Power requirements are the same as for 0.3-inch characters. Housed in a dual in-line package, the Data-Lit 62 provides a typical output of 500 foot-lamberts at 3.4 volts and 20 milliamperes per segment. Price is \$9.45 in quantities of 1,000.

Litronix Inc., 19000 Homestead Rd., Cupertino, Calif. [414]

2-by-4-bit multiplier uses  
internal carry lookahead

A 2-by-4-bit transistor-transistor logic multiplier, the model 9344, uses internal-carry lookahead and

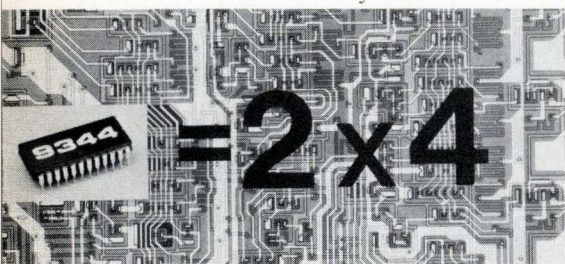

has sufficient carry inputs to combine all equal-weight outputs. This allows the design of interactive multiplication arrays without using any other components. Each 9344 generates eight partial products and sums the carries from adjacent cells. The multiplier is expandable to any size array. Price in 100 to 999 quantities is \$17.50 each.

Fairchild Camera & Instrument Corp., Semiconductor Components Group, 464 Ellis St., Mountain View, Calif. 94040 [415]

Monolithic op amp  
has high input impedance

An operational amplifier,  $\mu\text{PC152A}$ , is useful as an integrator, sample-and-hold circuit, and in medical, measuring, and control equipment. An output voltage can be fed back to the source of metal oxide semiconductor field-effect transistor input so that the unit can be used as a high-input-impedance inverting amplifier circuit. The p-channel enhancement device has input impedance of  $10^7$  megohms typical, and a low input leakage of 0.1 picoampere typical. The op amp offers a wide dynamic range, internal frequency compensation, and offset voltage null capability. Price is \$7.20 each in lots of 1,000.

NEC America Inc., Pan Am Building, Suite 4321, 200 Park Ave., New York, N.Y. 10017 [416]

IC op amps are available  
in drift-matched pairs

The model 3500MP is a pair of operational amplifiers that have initial offset voltage and drift matched to 200 microvolts maximum and  $1.0 \mu\text{V}/^\circ\text{C}$  maximum. The pair is said to provide low drift in many two-amplifier circuits at a cost lower than two individual amplifiers. The 3500MP also can be connected to simulate a single low-drift op amp. The units are computer-matched over the full temperature range to guarantee a maximum differential offset voltage between the two units

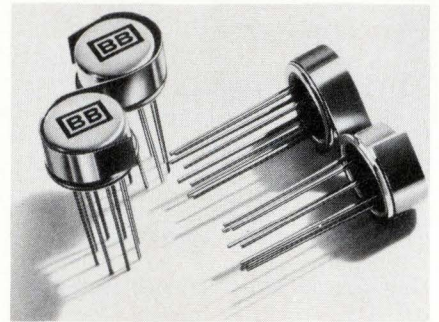

of 200  $\mu\text{V}$ . Price is \$16.70 each in quantities of 100.

Burr-Brown Research Corp., International Airport Industrial Park, Tucson, Ariz. 85706 [417]

5-ampere planar diodes  
recover in 150 nanoseconds

Designed for high-reliability switching applications, the SDD 500 series of 5-ampere planar diodes offers a typical recovery time of 150 nanoseconds. Packaged in DO-4 cases, the diodes use 12-mil 99.999% pure aluminum wire, ultrasonically bonded to 99.999% pure aluminum anode metalization. In addition to



fast recovery, the diodes have an operating range from  $-55^\circ$  to  $+200^\circ\text{C}$ , typical leakage current of 15 milliamperes at  $200^\circ\text{C}$ , and storage temperature greater than  $300^\circ\text{C}$ .

Solitron Devices Inc., Semiconductor Div., Riviera Beach, Fla. [418]



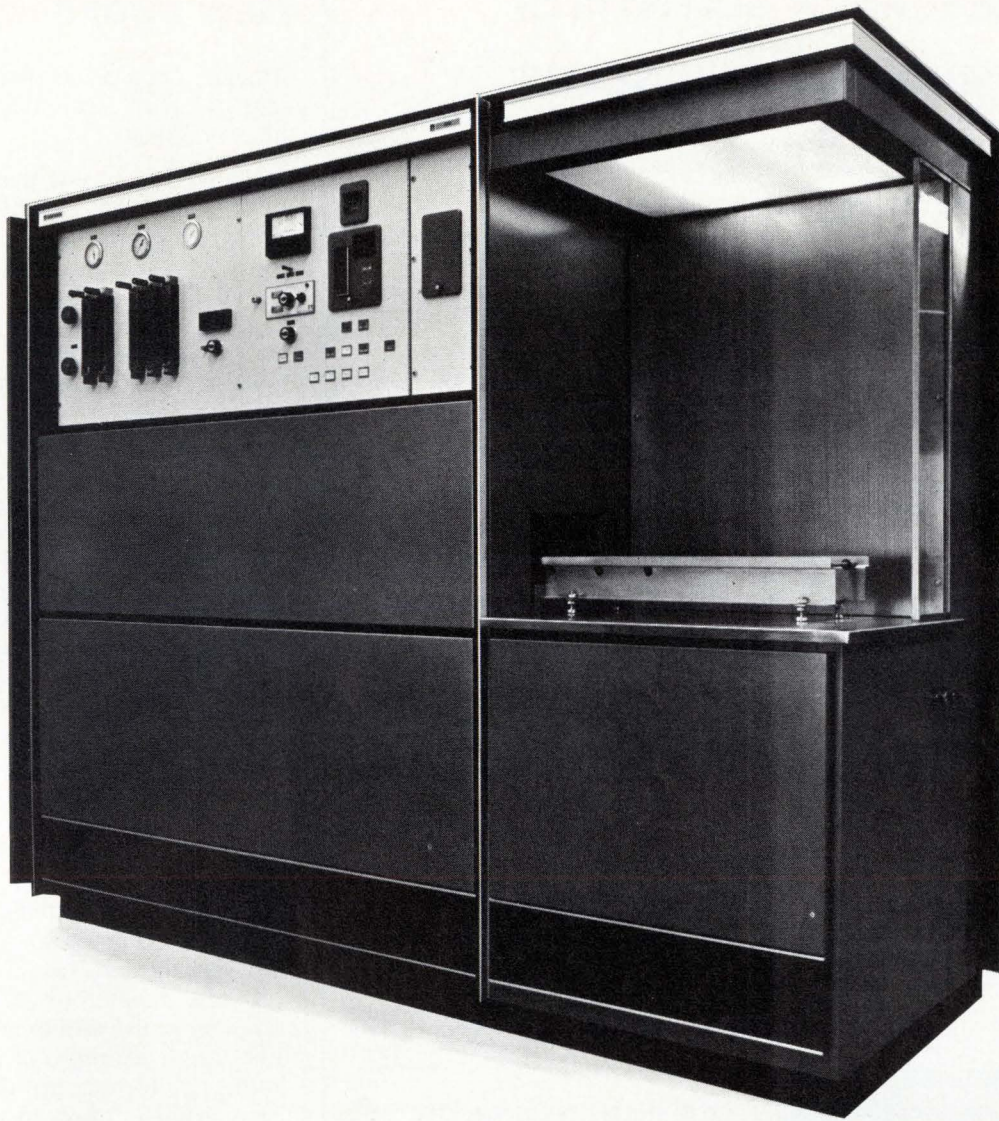

# The one and only Nitrox™ Reactor. Reliability guaranteed.

If you're in multi-layer, dielectric films for semiconductor devices, and demand ultimate control of your process over a broad temperature range, we have the one reactor that can support you.

Whether you're involved with  $S_iO_2$ ,  $S_3N_4$ ,  $Al_2O_3$ , polysil or refractory metals, our reactor can handle it automatically. From  $400^\circ C$  to  $1000^\circ C$ . With automatic flow control, automatic temperature control, and time sequence programming.

All with our own performance-proved power supply. Radiant energy. Quiet! There is no RF noise to disturb sensitive lab instruments. And the radiant energy unit is built-in, so you also save on valuable floor space, installation costs and maintenance required by bulky RF power supplies.

We guarantee our reactor's reliability for 1000 hours over its entire  $600^\circ$  operating range. From  $400^\circ$  to  $1000^\circ C$ . We also have complete three-zone thermo-

couple temperature control. Meaning greater uniformity, repeatability, better temperature control by far than optical methods. This is especially important in multi-layer devices.

Our cold wall chamber insures better yields than diffusion furnaces. And because there are no RF coils to adjust, you can achieve a perfectly uniform temperature profile within the turn of a dial. You can process up to thirty 2" wafers at a time.

Our new Nitrox reactor is the finest unit available. Write for our free literature pack. Call collect for immediate requirements.

Applied Materials Technology, 2999 San Ysidro Way, Santa Clara, California 95051, (408) 738-0600.



**Applied Materials**

## RESEARCH SCIENTISTS and PRINCIPAL ENGINEERS

Inaugural company effort in advanced development requires the establishment of a prime Research and Development Group. The expertise of this group will be applied in advanced studies, systems research and development of

### ELECTRONIC SWITCHING SYSTEMS

These positions provide stability and continuity due to long range commitments in advanced development in a commercially-oriented company.

Candidates for consideration must have a minimum of a Masters Degree and 5 years experience in Research and Development in one or more of the following fields:

- Electronic Switching Systems
- Digital Communication Systems (PCM  $\Delta$  M, Digital Filtering, Digital Switching and Communications theory)
- Computer architecture and design of micro-programmable control systems
- Software architecture for real time control systems
- Maintenance and diagnostics of digital systems

This Research and Development Group has excellent working conditions in our new, ultra modern research center. This center is located near Columbus, Ohio, and several large universities and colleges, including Ohio State University. This location provides unusually broad selections of life styles, i.e.; metropolitan, suburban, small city and rural. Salaries are commensurate with experience and abilities. Send your resume in confidence

Mr. E. L. Epperson  
Manager Salaried Employment  
Dept 855

**NORTH**   
ELECTRIC COMPANY

An equal opportunity employer

A subsidiary of United Utilities Incorporated

**PAUL HENSON  
RESEARCH CENTER**

P. O. Box 20345  
Columbus, Ohio 43220

## New books

**Modern Data Processors and Systems**, Donald Eadie, Prentice-Hall, pp. 448, \$14.50

Donald Eadie has written a book for those who know something about basic computer and programing concepts, but who aren't quite ready for advanced studies in specific aspects of the technology. As stated in his preface, he covers "the middle ground"—computer organization, system design, and the software/hardware interface.

As Eadie promises, the book contains no chapters on logic design or Boolean algebra. The first few chapters begin at an elementary level and work up to such topics as fast-carry adders and microprograming. Other chapters cover software, real-time systems, time-sharing, system design, and future trends.

Although the book's subject matter is complete and its organization seems well-planned, some sections are inadequate. For example, one might expect the chapter on "The Fortran Compiler" to describe what the compiler is, but the chapter is really a short course in how to write programs in Fortran.

In the chapter on business data processing, the author uses the IBM 7080 as an example of a computer in this application. But the 7080 had been obsolete for seven years before this book was copyrighted. Surely the author could have found a typical example of more recent vintage.

Eadie's book also contains a number of typographical and spelling errors. This reviewer found the section on error-correction codes difficult to follow, and he wondered if the fault was in himself, in the writing, or in those types. Wallace B. Riley  
Computer editor

**Modern Operational Circuit Design**, John I. Smith, Wiley Interscience pp. 256, \$14.95

This is a highly readable and well-organized text for the nonspecialist who wants to know how operational amplifiers are used in linear and nonlinear analog circuits. Chapters cover inverters, integrators, differentiators, followers, and precision-diode circuitry.

CLASSIFIED ADVERTISING

### SEARCHLIGHT SECTION

BUSINESS OPPORTUNITIES  
USED OR SURPLUS EQUIPMENT

RADAR SYSTEMS GROUND AND AIRBORNE. AUTOMATIC TRACKING ANTENNA SYSTEMS. NIKE AJAX. NIKE HERCULES. M-33. MSQ-1A. MPS-19. MPS-9. SCR 584. TPS-1D. TPS-28. FAA-ASR-2. AIRBORNE SYSTEMS. APN-84. APN-102. APS-20. APS-27. APS-45. DPN-19. DIGITAL COMPUTERS. IBM 650. IBM 704.

LARGEST INVENTORY OF RADAR AND MICROWAVE EQUIPMENT IN THE WORLD.

 **RADIO RESEARCH INSTRUMENT CO.**  
3 QUINCY ST., NORWALK, CONN. 06850 (203) 853-2600

CIRCLE 952 ON READER SERVICE CARD

## DESIGN ENGINEER

The DeVilbiss Company, a division of Champion Spark Plug, is seeking an individual with experience and interest in the field of medical electronics. Duties will include designing and developing components for medical equipment.

A BS in EE, plus 1-3 years industrial experience is desired; Salary based on qualifications and ability.

Send resume in confidence to:

Mr. A. G. Hammond

**DeVILBISS COMPANY**  
Box 913 • Toledo, OH 43692

### POSITIONS VACANT

#### Electronic Technicians, Relay Technicians

—Rapidly growing southwestern utility has immediate openings for qualified electronic and relay technicians. Electronic technicians must have a minimum of three years experience in installation, testing and troubleshooting all types of telemetering, supervisory, load control, power line carrier, microwave and mobile radio systems. First or second class F.C.C. license is required. Relay technicians must have a minimum of three years experience in installation, testing and troubleshooting all types of protective relaying, plant and substation control equipment. Experience with solid state relays desirable. Starting rate of both positions is \$5.49 per hour with excellent fringe benefits. Address complete resume of experience and education in confidence to: P-7004, Electronics. An Equal Opportunity Employer.

## Somebody— Somewhere

needs your idle equipment! Reach that buyer quickly and economically thru the

### "SEARCHLIGHT SECTION"

The meeting place of  
Used Equipment Buyers and Sellers

# meeting ground



where  
medicine and  
electronics  
come together

The 4th National Conference on Electronics in Medicine provides a major forum for the interchange of ideas and information between the men who make and the men who use electronic equipment for one overriding purpose—the betterment of worldwide health care.

Sponsored by McGraw-Hill's *Medical World News*, the focus of this year's conference will be on what is available and *practical* in the diagnostic, therapeutic and monitoring phases of medicine.

Neither physician nor engineer can afford to miss this 3-day dialogue. Both electronics and medicine are two of the fastest changing and growing professions in the world—and today's physician, nurse and hospital administrator must have every available input.

And engineers and manufacturers need the information exchange that comes from these invaluable conferences in order to develop the kind of sophisticated equipment necessary for modern health care. Only through knowledge of the medical profession's needs can industry develop and produce that equipment.

Speakers and panel members will include Howard Rusk, M.D., Director NYU Rehabilitation Center; Tom Bird, Manager, Monitoring Systems, General Electric; William Kerr, Director Medical Division, IBM; Merlin K. DuVal, M.D., Assistant Secretary for Health and Scientific Affairs; Dwight E. Harken, M.D., Clinical Professor of Surgery, Emeritus, Harvard Medical School; J. Willis Hurst, M.D., Professor and Chairman, Dept. of Medicine, Emory University School of Medicine, President American Heart Association; Thelma Schorr, R.N., Editor, American Journal of Nursing.

Date: March 27, 28, 29, 1972

Place: Chicago, Drake Hotel

Take advantage of the pre-registration price of \$165 (registration at Conference—\$200) by filling out the coupon and mailing today. The Drake Hotel has a number of rooms reserved—please make your room reservation directly with the Drake, and indicate that you will be attending the Conference.

## Conference Highlights

- Applications of instrument and computer technology
- Hardware obsolescence and problems of repair, maintenance and cost
- Continuing government role in developing device legislation
- The trend toward minicomputers
- Emergency care: growing role for electronics
- Applications of space technology to medicine
- Multiphasic screening—demonstration session
- New Problems in Liability and Malpractice—what does the increased use of electronics portend?
- Man and machine—is dehumanization a problem?
- Problem-oriented Medical Record—getting ready for the computer
- Meet-the-experts (evening session)

Medical World News, 299 Park Avenue, New York, N.Y. 10017

Yes, I would like to be pre-registered at the 4th National Conference on Electronics in Medicine at the special advance rate of \$165. Please make checks payable to Donald Rubin, Conference Chairman.

Check enclosed

Please bill me

Name \_\_\_\_\_ Title \_\_\_\_\_

Company (Hospital) \_\_\_\_\_

Address \_\_\_\_\_

City \_\_\_\_\_ State \_\_\_\_\_ Zip \_\_\_\_\_



# LOW COST

# PC CARD MODEM

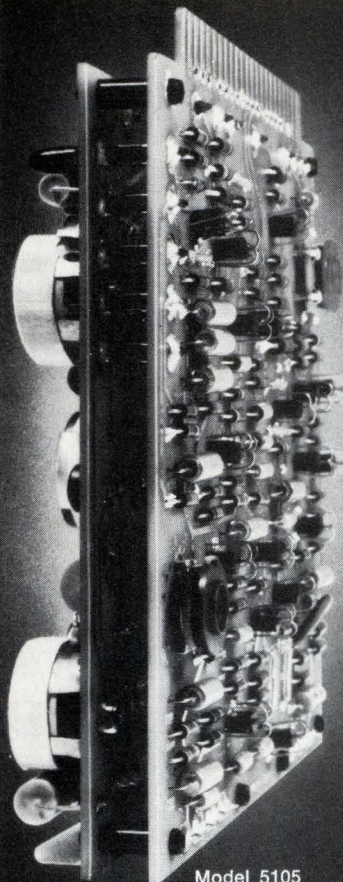

Model 5105  
5" x 4 3/4" x 1 1/2"

- -20° to +60°C
- New Small Size
- ADJUSTABLE Frequency, Gain, Bias, Sensitivity

An originate-only Modem for O.E.M. applications.

Compatible with Bell 101, 103, 113 series.

Operates full-duplex up to 300 bps. Strappable for half-duplex. Interfaces with Bell Manual Couplers (CDT). 60dB minimum adjacent channel rejection.

#### Plug-In Filters for FDM

Optional "piggy back" filter assemblies enable assignment of operating frequencies for FDM.

Other options include Carrier Detect Circuit, housing and power supply for stand-alone applications. Contact us for additional information.  RFL

Industries, Inc., Communications Division, Boonton, N. J. 07005

TEL. 201-334-3100

TWX: 710-987-8352

CABLE RADAIRCO, N.J.



**RFL Industries, Inc.**

# \$95.

## New literature

**PCM system.** General Electric Co., Telecommunications Products Dept., Section P, P.O. Box 4197, Lynchburg, Va. 24502, has issued a four-page brochure outlining the company's 24-channel pulse code modulation cable carrier system. Information on the repeater housings used with the system is also included. Circle 421 on reader service card.

**Microminiature assemblies.** A 21-page applications note on specialized techniques for the rework, repair, modification and prototyping of microminiature electronic assemblies is available from Pace Inc., 9329 Fraser St., Silver Spring, Md. 20910. [422]

**Data test set.** International Communications Corp., 7620 N.W. 36th Ave., Miami, Florida 33147, has available a four-page data sheet describing the model 220 data transmission test set. The bulletin includes a technical description and functional information. [423]

**System power monitoring.** General Microwave Corp., 155 Marine St., Farmingdale, N.Y. 11735, has published bulletin N425 describing integrated assemblies of thermoelectric power sensors and dc amplifiers for power systems monitoring. [424]

**Data acquisition systems.** Dattel Systems Inc., 1020 Turnpike St., Canton, Mass., has available an applications handbook detailing information about modular data acquisition systems such as analog multiplexers and sample-and-hold circuits. The 23-page booklet is divided into six comprehensive sections. [425]

**Semiconductor packages.** A catalog from Texas Instruments, P.O. Box 5012, Dallas, Texas, describes the company's line of semiconductor packages. Included are specifications, measurements, and recommended applications. [426]

**Doppler radar module.** Hewlett-Packard Co., 1601 California Ave., Palo Alto, Calif. 94304, describes a

10-GHz doppler radar module in an applications manual that also details basic principles and engineering calculations. [427]

**Insertion handbook.** A 16-page guide to the insertion of components into printed-circuit boards is available from Universal Instruments Corp., East Frederick St., Binghamton, N.Y. 13902. [428]

**Ac volt-amp recorder.** Rustrak Instrument Div., Gulton Industries Inc., Municipal Airport, Manchester, N.H. 03103, has issued a data sheet on an ac volt-amp recorder called the model 230. Included are specifications and general information. [429]

**Rotary position transducer.** Bulletin 1240 from the Permalink Corp., 327 Valley View Rd., King of Prussia, Pa., 19406, provides a technical description of the model FA1 rotary position transducer. [430]

**Printed-circuit relays.** An eight-page catalog details custom and standard features, dimensions, modes of operation, and ratings of printed-circuit relays, and is available from Printact Relay Div., P.O. Box 1430, Long Island City, N.Y. 11101. [431]

**Choppers.** Solid State Electronics Corp., 15321 Rayen St., Sepulveda, Calif., has made an application sheet available that covers the company's line of solid state electronic choppers. [432]

**SCR devices.** Sarkes Tarzian Inc., 415 N. College Ave., Bloomington, Ind., 47401, has published a 12-page catalog listing seven series of SCR devices with ratings ranging from 3 to 35 amperes. [433]

**Test equipment.** Kearfott Div., Singer Co., 1150 McBride Ave., Little Falls, N.J. 07424, in a 16-page brochure, describes a variety of automatic testers custom-designed to check out equipment. Covered are inertial systems and components, circuit cards and modules, assemblies, computers and their peripherals. [434]

# WIDEBAND 2 MHz PORTABLE RECORDER WITH 6 SPEED 14 TRACK REPRODUCE FOR DATA ANALYSIS

COMPLETE 14 TRACK 7 SPEED RECORD/REPRODUCE:  
DIRECT, FM, AND DIGITAL • COMPLETE MODULARITY  
FOR EASE OF MAINTENANCE AND OPERATOR  
CONVENIENCE

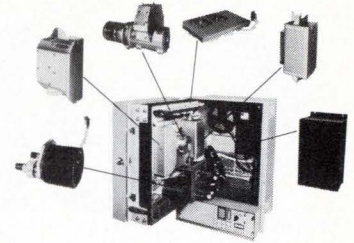

Total Front Access  
To All Modules

## ASTRO-SCIENCE A TRACOR COMPANY

ASTRO-SCIENCE CORPORATION • 9700 Factorial Way • South El Monte, California 91734 • (213) 443-3211 • TWX 910-587-3440

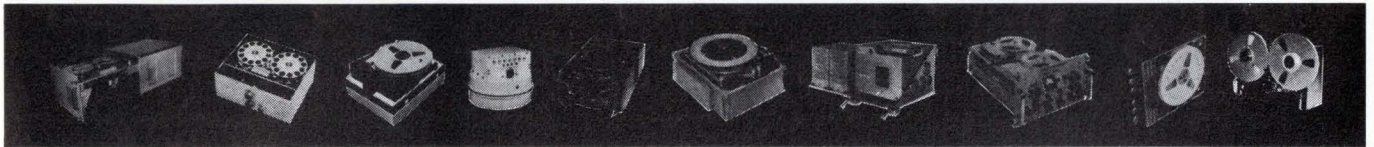

IRIG Wideband 2 MHz  
Direct, Wideband Group I  
FM, or 10K BPI Digital  
Interchangeable  
(1.5 MHz optional)

Flutter (per IRIG 106-71)  
no more than 0.25% p-p  
at 120 ips from 0.2 Hz  
to 10 KHz

115 v/220 v, 48 to 420 Hz  
power

Expandable to 28 tracks,  
2 MHz / 14 track  
Bandwidth at 60 ips,  
Wideband Group II FM,  
or 2.88 MBPS Digital

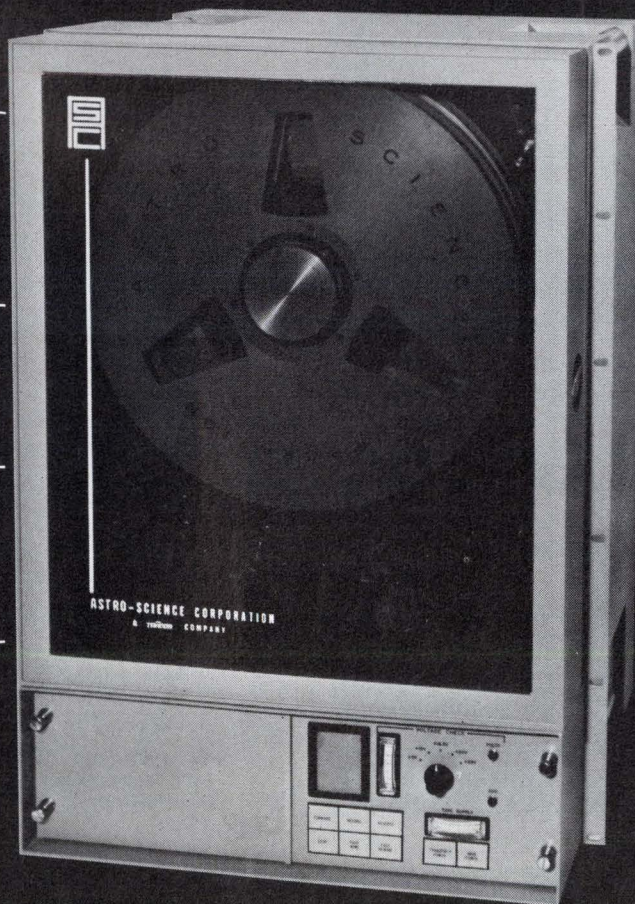

Record Speeds: 1 7/8 to  
120 ips  
Reproduce Speeds: 3 3/4  
to 120 ips, or 1 7/8 to 60 ips  
automatically switched

Self-contained, includes  
AC Power Supply &  
Record/Reproduce  
Electronics

19" rack size x 26 1/4"  
high x 16" deep

Rugged for shipboard,  
mobile, or aircraft  
environments

# Celco Yokes for CRT DISPLAYS



CELCO makes YOKES. They make them good. In fact, CELCO has been making the best CRT deflection yokes and focus coils in the industry for the past twenty years.

CELCO makes yokes for precision displays when you must have the highest performance available.

And CELCO makes yokes for computer terminal displays when you need reliable repetitive scan yokes for commercial purposes, at low cost.

Not only does CELCO make good yokes, but they make sure you get the right yoke for your particular CRT display requirements.

Call CELCO on your present display problem. A CELCO yoke will solve it. (It might even be one of the standard CELCO yokes listed below:)

#### CELCO PRECISION DISPLAY YOKES:

- DNA702 "superfastDYNAYOKE"  
(2  $\mu$ sec recovery time to 0.1%)
- HDN428 Low-Zero Approach
- HDQ428 Mini-Spot, (CRT/Yoke matched)

#### CELCO COMPUTER TERMINAL DISPLAY YOKES:

- PW Position-Write Yokes
- PWM Position-Write, with Pincushion Correction
- YA Resonant Drive, Hi-Q

CONSTANTINE ENGINEERING LABORATORIES COMPANY  
MAHWAH, N. J. 07430 TEL. 201-327-1123 TWX: 710-988-1018  
UPLAND, CAL. 91786 TEL. 714-982-0215 TWX: 910-581-3401

Go ahead and call CELCO. All you've got to lose are your yoke problems.

**Celco**

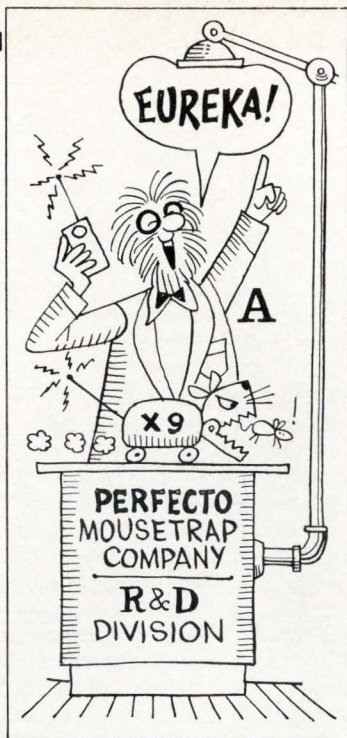

FEBRUARY 1972

INVESTMENTS

On capturing profits from "special situations"

Are no-load mutual funds all they are said to be?

INSURANCE

Rich man, poor man—both can protect their incomes

EDUCATION

Spreading the bills for college

HOBBIES

Starting small, thinking big in your own home workshop

SPORTS

Sailing on ice—fastest, frostiest way to go

THE GOOD LIFE

Brandy's dandy, but Cognac is an experience

HEALTHY, WEALTHY AND WISE

INVESTMENTS

**Capturing profits when a situation becomes "special"**

For several months in late 1970 and early 1971, a stock known as Dentsply International was quietly trading in the \$30 range on the New York Stock Exchange. Last May, dealing in the shares picked up sharply, and the price romped to \$54.50. The reason: Dentsply, a leading manufacturer of dental and ophthalmological supplies, was reported to have come up with a revolutionary system for preventing tooth decay.

As is often the case, Wall Street enthusiasm ran its route, and at year's end Dentsply shares were again selling at about \$30. But for those who had acted on the news early—and sold before the

bloom was off the rose—Dentsply was a perfect example of what is known in the investment world as a "special situation" stock. By definition, this can be any stock that goes up for special reasons of its own and regardless of what other stocks are doing. They are the stuff of which many a private investor's dreams are made, and trying to spot a special situation occupies much of the time of many professionals as well.

There are a variety of conditions that can make a special situation. In his *Investor's Handbook*, Jacob O. Kamm points particularly to securities "that are selling at prices below their intrinsic value as represented by the net assets of the corporate issuer." Arnold Bernhard, founder of the *Value Line* services (including the *Value Line Special Situations*

*Service*), thinks of them also as stocks issued by "new and potentially great companies."

One of the more widely accepted definitions is that of Lin Tso, in his book, *Techniques for Discovering Hidden-Value Stocks*. He says, "It (special situation) is one in which a development, non-recurring in nature, is expected to occur which will substantially increase the value of the stock . . . Alternately, (it is one) in which such a development has occurred but the significance of it is not generally realized."

The Dentsply development is practically a case-book example, an anatomy lesson in special situations. Actually, the anti-cavity system that sparked it all was known to dentists a full year before the spectacular market rise; it was first mentioned in the February, 1970, *Journal of the American Dental Assn.* Briefly, the Caulk Nuva System, as it is called, is a two-part method of applying a plastic sealant to the molars of the young—the special Nuva Seal is applied then polymerized by an ultraviolet Nuva light.

A year later, last February, Dentsply displayed its system at a meeting of the Chicago Dental Society. Still nothing

PERSONAL BUSINESS

like all McGraw-Hill publications, is written for a select audience. Prepared each month by the Personal Business staff, it is devoted entirely to your own interests and activities. Its theme: Better management of your time and money. This supplement reaches a limited audience and there is no separate subscription list, or rate.

happened for nearly three months. Then something—it may have been a fuller article that appeared in the May issue of the ADA Journal or, more likely, gossip among brokers—turned Dentsply into a “special situation.” Even Dentsply’s management cannot explain it. They still have not promoted the Nuva system in a big way. Indeed, Nuva has yet to contribute materially to company earnings. But, although the Nuva system promised cavity protection only for the healthy molars (not even the incisors) of only adolescent and younger children (and is certainly not the only plastic-coating system on the market), it captured enough investor attention to boost Dentsply’s shares more than 80% in value.

Why the stock then slid back to “normal” can only be ascribed to an FDA decision to include such systems within its purview. This spelled delay to some investors, and they sold.

For the special-situation seeker, there is a moral in the Dentsply story. Time is a vital factor in profiting from special situations. The trick is to recognize them early. Nothing is a special situation once it becomes a matter of common knowledge, and fully discounted in advanced prices. Further, such deals are largely speculative. They usually involve something in the future—which may or may not be realized. If it develops as expected, the best-advised investor will take his profit. (Of course, if the stock remains attractive it can be held, but it’s no longer a special situation. It’s a growth stock.) Conversely, if the situation fails to mature, the wisest course is still to sell, swallow one’s disappointment—and look for a new one.

Finding one is largely a matter of keeping an ear to the ground. A businessman may recognize the potential of a new product before it becomes widely known. A dentist may read in his journal of another Dentsply. Attorneys, geologists, mining engineers, chemists—all occasionally hear of developments in their own fields before the rest of us do.

Indeed, a merchant noting the initial success of a new product on his counters may well have a “special situation” within his grasp.

There is, too, a wealth of professional help in this direction. Brokerages such as Seiden & DeCuevas, First Manhattan, and L.F. Rothschild devote considerable research to uncovering their versions of what a special situation might be. At least half a dozen New York houses and about an equal number of regional firms, such as Hambrecht & Quist of San Francisco, are active in this area. So are such broad-based firms as William D. Witter and E.F. Hutton, both of which prepare special reports on special-situation issues. Brokers with large orders in mind take pains to uncover such developments for their institutional customers, and such advisory outfits as Value Line Special Situation Service and the Capital Gains Research Bureau sell similar service to their subscribers.

For the individual investor, examples may best point the way for recognizing situations that could become “special.” The entertainment industry is often a fertile field. Some years ago, Columbia Pictures was a relatively small company with no theaters of its own, and thus largely dependent on the profitability of its films. After a doldrum of poor box-office, Columbia produced *From Here to Eternity* and *The Caine Mutiny*, two big hits. Those who saw the previews—and correctly appraised them—had a real special situation. The stock, which had been selling under \$10, advanced sharply to \$30. The more recent success of *Airport* similarly bolstered the earnings of MCA, Inc., which owned Universal Pictures, producers of the film, and snapped MCA stock from the low-\$20 range to nearly \$30 last fall.

The automobile industry, with its yearly introduction of new models, is another area to watch. The introduction of

the first small cars under the then president, George Romney, for instance, made American Motors a special situation in its time. Chrysler may be suffering today, but in 1962 a change in management that ushered in a couple of years of rising earnings drove Chrysler shares from below \$7 to almost \$70—a spectacular special situation reaction. It must be noted, however, that a success like Ford’s new Mustang may occasionally come along, but there have also been such things as the Edsel.

Reports of new discoveries by mining and petroleum companies have produced their share of special situations. The 1964 discovery of the Kidd Mine ran the stock of Texas Gulf Sulphur from \$9 to more than \$50 by 1967, although it also produced several lawsuits. Atlantic Richfield, among others, had a major rise in 1968 when oil was discovered in Alaska. Starting around \$50 in 1968, Atlantic Richfield hit about \$135 by 1969.

New products, such as Dentsply’s anti-cavity system, are perhaps the most notable inspiration for special situation speculation. There are many examples—Dupont’s Cellophane, Polaroid’s picture-in-a-minute process, Eastman Kodak’s Instamatic camera, Syntex and “The Pill,” and Xerox’s magical duplicator. A recent example is Bausch & Lomb, the optical company. Its stock sold as low as 27½ at the bottom of the market in 1970. It recovered with the market but then went on to new highs above \$160—mainly on the potential for a big jump in earnings that investors saw in Soflens, B&L’s “soft” contact-lens development.

Knowing in advance about a possible takeover can also be very profitable, for those who act quickly. In the summer of 1968, for instance, Goodrich was selling at about \$40. By January of 1969 it had advanced to just under \$70 on the news that Loew’s Theatres had acquired a large block. Shortly, Northwest Industries offered a securities package valued between \$75 and \$80 a share. But, as does happen, Goodrich’s management fought off the takeover. By summertime, the stock was back to \$40. In 1970 it was below \$20.

—GERALD M. LOEB

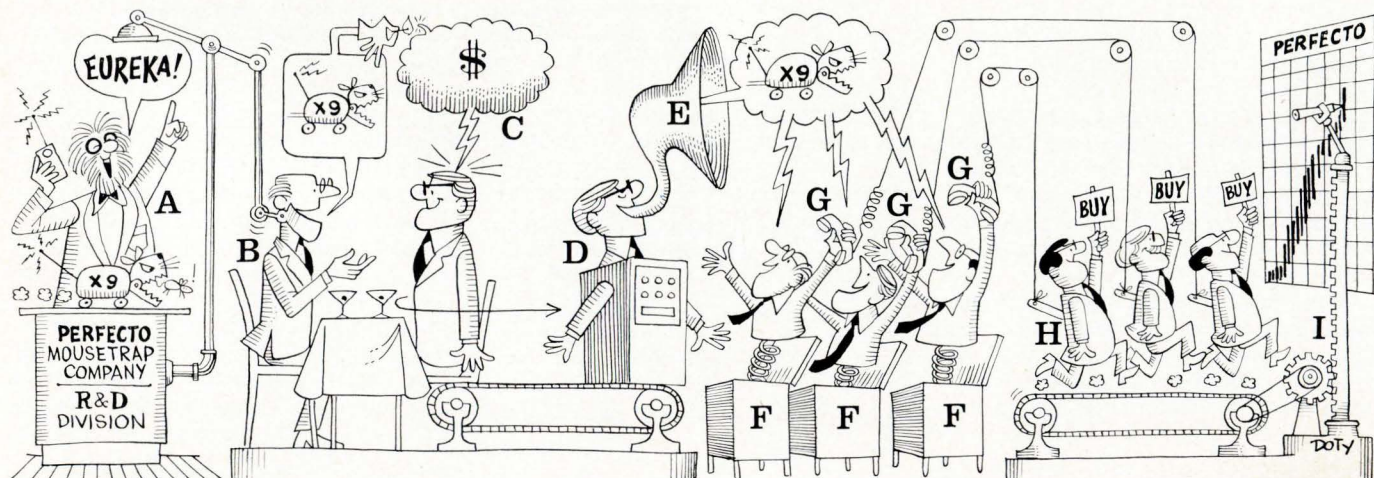



Is somebody misspelling our name?

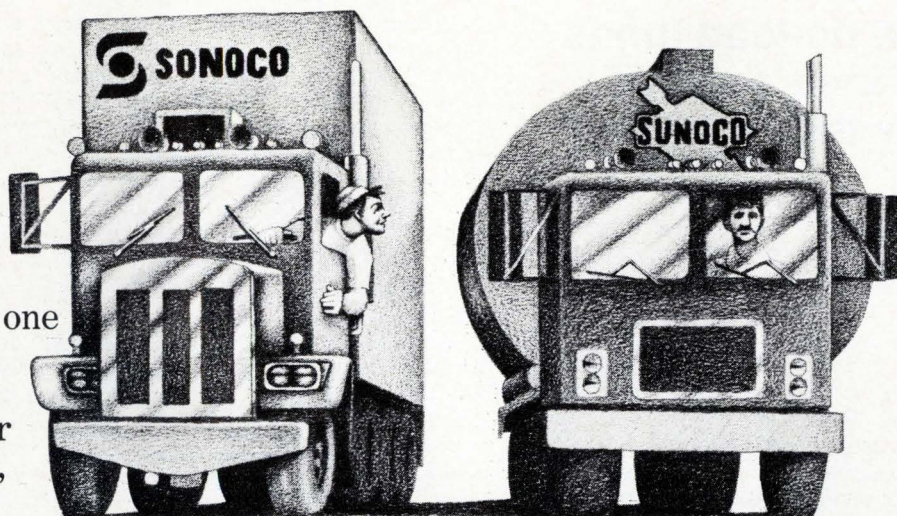

There's only one way to spell Sonoco. With an O.

So if you ever see it spelled with a U, that isn't us you're seeing. That's Sunoco, the gasoline people, with whom we are in no way related. Except in sound only.

At Sonoco we make paper and plastic products for industry in plants in the United States and in 16 foreign countries. And most of them we develop in our own laboratories with our own technical groups.

For the textile industry we make cones, cores and spools. For paper manufacturers and converters we make cores and tubes. For packagers we make cans, containers, folding cartons and fibre partitions. For the construction industry we make forms for columns and one and two-way joist systems. For the utility industries we make underground vaults, meter boxes and bituminized pipe for sewer and drain lines. And for a lot of other industries we make specialty paperboard.

So how can anybody make the mistake of thinking we pump gas for a living?

Maybe it's because all our products are made to solve specialized industrial problems. Which hasn't exactly given us the opportunity to become a household word.

But whatever the reason, we'd like to be better known than we are throughout the world. Especially the industrial world. That's why we've written a booklet that tells all about us. Write Sonoco Products Company, Department B, Hartsville, S.C. 29550, and we'll send you a copy. And there's only one thing we'll ask in return.

Please, when you're spelling our name, don't put a U where the O's supposed to go.

**Sonoco Products Company.**  
Innovators in paper  
and plastics.



## Are no-load funds all their sellers say they are?

OR DO HIGHER COSTS AND BREAK-EVENS NIP THE INVESTOR?

Back in March of last year, several investment men got together and formed the No-Load Mutual Fund Association, an organization conceived to promote the best interests of those funds which do not charge a sales commission when investors purchase them. The move was a clear sign that an idea had come of age.

In just 16 years, no-load funds have grown from a scant 20, representing \$200-million in assets, to 149, with more than \$5-billion of investment under their management. This is still just a fraction of the business enjoyed by the front-load funds, the assets of which are now well over \$50-billion. But, while the mutual fund industry in general has been suffering from what amounts to a "run on the bank" in the form of heavy redemptions compared to sales, no-load fund investors have proven themselves to be intensely loyal. In the first nine months of 1971, new sales of no-loads amounted to \$709-million, while redemptions totalled only \$460-million. Indeed, roughly half of the new money coming into the mutual fund business these days flows into the no-loads. This would seem to indicate that, in the eyes of a large part of the investing public, the no-load people must be doing something right.

Just what they are doing to merit this following, however, is somewhat less clear. Like the load funds, performance varies; no-load funds can be aggressively growth-oriented, or they can also perform like income-pinching conservatives. They can be top-heavy in common stocks, or they can concentrate the majority of their assets in bonds. Like their load-fund brethren, they can range in size from \$1-million or so in assets to a giant like the T. Rowe Price Growth Stock Fund of Baltimore, with around \$900-million under its wing.

With so much in common with the front-load funds, and minus any "sales charge" (no-loads, by definition, are

sold at net asset value), why would any mutual fund investor buy anything but a no-load? There are some reasons.

For one thing, the no-load fund investor can oftentimes find himself buying in a vacuum of information. There is, after all, no salesman to consult.

"The mutual fund salesman," says one investment expert, "does serve a useful purpose, despite all the criticism of the 'excessiveness' of some sales charges. He can help the investor sort out the chaff, and he can educate him to the experience and performance of various funds, in terms of the investor's own goals. I've yet to hear of a no-load fund taking the time to interview the prospective investor to make sure that he is making the right choice."

The objection is particularly to the point, since no-load funds, which generally have small minimum investment requirements, have largely appealed to the investor of the "little guy" variety who is usually not overly informed in the market nuances. The no-loads attract him primarily two ways: Through advertisements in financial journals and business pages of major newspapers, or through word-of-mouth. (A smaller amount of sales comes from brokerage houses which, for pushing the no-load, are rewarded with commission, generating brokerage business.)

When a potential investor fills out the coupon in one of the advertisements, he receives a prospectus. Unless he is a student of mutual funds, however, the prospectus alone may not tell him all he needs to know, either about the fund or its investment objectives. And, of course, when it comes to judging whether this particular fund is "right" for him, he is strictly on his own.

There is also the problem of the no-load fund's characteristically high break-

even point. Since no-loads must channel money heavily into advertising and promotion, and since their operating income is derived largely from the management fee (and brokerage fee, if the fund is operated by a stock exchange member firm), the break-even point, by some estimates, is nearly twice that of funds which charge a sales commission.

"I don't know whether you can quantify it," grouses one front-load fund official, predictably critical of no-loads, "but I suspect that this sort of thing may well lead to cutbacks elsewhere—in research, service, and, most important, maybe in performance."

Indeed, with generally higher annual operating expenses, including advisory fees deducted from gross income before dividends are paid or reinvested, no-loads sometimes cost the investor more than a front-load fund over the long pull, according to their critics.

There may be other drawbacks as well. Many no-load funds were established by investment-counseling and brokerage firms simply as repositories for investors who did not have enough money to command separately-managed accounts. The charge was made—but largely discounted by most mutual fund men today—that investors in these funds got less than first-class service.

Another criticism of mutual funds, and particularly the no-loads, is the tendency of some investors to use them as a trading medium, like common stocks. No-loads are particularly attractive for this purpose, since the trader pays no commission charge on his purchases. For long-term investors, however, it can mean a dilution of their interest in the fund. Nonetheless, since no-load funds deal directly with their investors, this can be easily avoided—providing the fund operators make an effort to do so.

In the end, an investor interested in mutual funds is simply looking for the best performance vehicle compatible with his own objectives, and most no-loads can serve this purpose as well as front-load funds. For the serious investor, it is nevertheless wise to investigate the mutual fund evaluation services available, such as that offered by such New York firms as Weisenberger Financial Services or the Arthur Lipper Corp. Prices vary, but less than \$100 a year should yield a nice cross-section of information. Don't forget, too, that a man's regular broker—if he really knows his customer's requirements—can be the handiest advisor on what fund's right for his particular needs.

—PETER F. EGAN

Behind the scenes in mutual fund trading: Manhattan office of Lionel D. Edie & Co.



Dick Wolters



# If you need more than just a simple answer



Any calculator can give you answers. But if you need more — if you need solutions — then bring on your toughest problems and see what Wang calculators have to offer.

Power, for one thing. Power to whiz you through interest rates or static values of pre-stressed concrete bridges. Or just about anything in between.

Versatility: each Wang calculator is field-expandable to fit your changing needs, to handle more difficult challenges.

And value: each Wang calculator has the greatest price/performance ratio in its respective class.

Wang is the largest American calculator manufacturer and offers the most extensive line of calculators in the world. We've earned a reputation for excellence and we intend to protect that reputation with superior products and factory-direct service.

So think about it: do you need answers?  
Or do you really need us instead?



**WANG**  
LABORATORIES, INC.

836 North Street  
Tewksbury, Massachusetts 01876  
Telephone: (617) 851-7311  
TWX 710-343-6769  
Telex 94-7421

Dept. PB-2

# FTD Speed-A- Gift



Now you can wire a beautiful, fresh flowers and gift combination almost anywhere in the country.

Just call or visit your FTD florist and choose from his Speed-A-Gift collection.

It's so easy. No wrapping, no mailing, no worries. Why not surprise a loved one, thank a friend... or just remember someone in a very special way for no special reason?

Available through your FTD Florist.

Pictured above is SG-17, Cups and Caddy. Colorful, footed mugs designed for display on functional see-through caddy. Has easy-carry handle for no-spill service.

## The gift that travels by wire.



## INSURANCE

### Rich man or poor, now both can get income protection

"Loss-of-income coverage," says an independent Boston insurance consultant with obvious enthusiasm, "is really big today." Indeed it is. About 60-million Americans pay well over \$1-billion in premiums, quite apart from their medical coverage, to be sure that at least part of their income continues if they become lengthily sick or disabled by accident. Equally dramatically, disability insurance, once thought of as the protector of the modest wage earner, has come up in the world.

In the past several months, company after company has come forth with coverage that will pay up to \$3,000 a month to a policyholder suddenly unable to work. No one is allowed, of course, to turn a profit on his misfortune—the rule of thumb is that policies will pay out only 50% of usual income, plus \$50, to a maximum of \$3,000 a month. Still, the new levels are high enough to provide respectable protection even for those whose occupations put them in the \$75,000-and-up brackets.

Most common coverage spans two years of sickness disability or a lifetime of accidental disabling. Insurance experts advise any family's income-producer, particularly the executive or professional, to insure himself against these eventualities up to age 65 at least. "If a family needs \$2,000 a month to live on in the event of the principal's death," the Boston consultant points out, "surely they'll need the same amount if he lives but cannot work. Besides, it only makes good sense to be covered for medical expenses beyond those covered even in some of the more generous major-medical policies."

Brokers stress the importance of disability income insurance for the self-employed, particularly professionals. The message is equally clear for executives whose assets may not yet be enough to sustain them through a long-term illness.

In former years, insurance companies have often limited top-cash benefits to terms of five years or up to age 55, whichever is longer. Now, insurers are following one of the leaders in the field, Union Mutual, by extending the benefit periods to cover any term up to age 65.

A typical loss-of-income policy covering a 50-year-old, \$50,000-a-year professional man would be one providing benefits of \$2,000 a month to age 65, with a 30-day "elimination period"—the time span before benefits begin—for a premium of about \$1,360 annually. Premiums drop as elimination periods lengthen—they can range from as brief a time as seven days to an entire year. The choice, of course, depends on how long a policyholder figures his resources can carry him.

Additional benefits are available through endorsements. "Accidental death or dismemberment" coverage (the latter: severance or loss of use of a limb) costs a man of 50 with a \$50,000 annual income about \$1.80 per \$1,000. Partial disability benefits are much more costly—\$78.20 per \$1,000. Another idea is "guaranteed insurability." People between the ages of 18 and 49 are offered up to 10 option dates, one every two years, to increase coverage by \$100 at 15% of the base price, regardless of their health. Another trend, begun by Provident Mutual Life, is to hedge against inflation. Say the insured buys coverage to take effect from the onset of long-term disability to 65 years of age. The monthly payout rises 2% starting at the end of each year, a modest percentage, but a help in offsetting those cost-of-living increases that have become an annual occurrence.

Newest twist in some states is the return-of-premium policy. Aetna, for one, has a policy which is getting quite a bit of attention. If the policy continues until age 65, the insurance company will return 100% of the premiums paid, less any claims. Other disability income insurance companies offer 80%-20% "tenure roll-over" endorsements. With these, the insured holds onto the policy for 10 years. If claims within that period do not exceed 20%, then 80% of the premiums will be reimbursed. But the price is dear for return-of-premium policies—the increase in cost is anywhere from 30% to 55%.

A very popular coverage for self-employed businessmen and professionals is business-overhead expense protection. It defrays everyday operating expenses up to \$3,500 a month of the individual's business or profession, in addition to any benefits he may receive from an individual income-replacement policy. These are issued as separate policies, and are available to a man of 50 on a \$2000-a-month payout basis—after a 30-day waiting period—for about \$550.

—MARGARET DONOVAN

## Brandy's dandy, but Cognac is an experience

The perky little white daisy is, in truth, a chrysanthemum, but it bears little resemblance to one. The same may be said of a brandy when it is compared with the ineffable brandy of Cognac. A family resemblance—yes. But that's as far as it goes.

If you distill any wine, the distillate will be brandy. Only if you distill wine fermented from the Charente (in West Central France, just north of Bordeaux, on the Atlantic), do you get Cognac. The name is fiercely defended, and the area is sternly circumscribed.

Aging is vital to Cognac. The oak of Limousin supplies the wood for the aging barrels (with a little from Tronçais)—and each barrel is made by hand and "signed by the artist." Slumbering in their oaken vaults, the great Cognacs age three years (the least that is legal in Britain—two in the U. S.) to upwards of 50 or even 60 years. After that, to avoid woodiness, it is put in glass, to await the blender. The blender is the Merlin of the distillery. He must blend Cognacs old and new; mix Cognacs of all the demarcated areas, AND he must remember to achieve continuity of the House style.

Labels may no longer carry designation of years of age because France itself does not police age after five years. However, it is generally accepted that 3-star is about 5; V. S. O. P. (Very Special Old Pale) would approach 20; and the Reserve, Extra, etc. special marks indicate Cognacs up to 40 and 50 years. Bisquit Doubouche's "Extra Vielle" is 40 to 60. Their "V. S. O. P. Napoleon" is 50% Grande and 50% Petite Champagne and hence can call itself "Fine Champagne." This is exceptional. Other great Houses—Hennessy, Martel, Otard, Courvoisier, Remy-Martin, Hine, Briand, and many others—have their special types and styles.

The drinking of Cognac is an experience. The bouquet is to begin with, almost impossible to describe. That is why the glass is so important. In Cognac one hardly ever sees one of those great balloon affairs, capable of holding a small aquarium. They use palm-sized glasses of thin glass (so the heat of the hand comes through) sometimes with a funnel neck to concentrate the fumes.

—ROBERT J. MISCH

LOOK FOR THE SHEAFFER "WHITE DOT"



Of all sterling silver gifts only one carries the "White Dot".

From the "White Dot" collection by Sheaffer, the Silver Imperial. Crafted in the timeless tradition of the world's finest writing instruments. Ballpoint or pencil, \$15. Pen, \$25.

**SHEAFFER**  
the proud craftsmen

SHEAFFER, WORLD-WIDE, A **textron** COMPANY



## Combine Europe with a new Mercedes-Benz.

This coupon will bring you, free, the Mercedes-Benz Guide to European Delivery.

How to order a Mercedes-Benz here, pick it up there. The advantages of touring Europe in your own car. The facts on shipping it home.

Plus a full-color brochure, factory-delivered prices and a work sheet to figure costs.

Mr. Peter Grassl  
Mercedes-Benz of North America, Inc.  
158 Linwood Plaza, Fort Lee, N.J. 07024

Please send me the Mercedes-Benz Guide to European Delivery.

Name \_\_\_\_\_

Address \_\_\_\_\_

City \_\_\_\_\_

State \_\_\_\_\_ Zip \_\_\_\_\_ PBI-2



## Frostbite is their co-pilot

If there ever was a sport that should have gone with the wind—the way the hapless dinosaur went with the wind—it's ice boating. It is at its best only under fairly rare and usually frightful conditions. The weather has to be abysmally cold, to make thick ice, and there has to be a wind, which makes it feel even colder. But there can't be much snow. Thus in many parts of the country, ice boaters can count their good times for the year on the numbed fingers of one hand.

So why do so many Americans make such pets of these mosquito-like contraptions, and pick frostbite as their favorite co-pilot? Why, indeed, has ice boating survived? Probably because it is still the fastest way for a man to go without a motor, short of falling out a window. Aerodynamic effects drive ice boats at four and five times the wind velocity, and speeds of over 100 mph. are not uncommon. Ice boating hasn't gone with the wind, simply because the wind hasn't caught up with it.

The Dutch are credited with starting it

Dick Wolters



all. Authentic records date the first ice boat in the year 1768. The story is that a young man was ice skating with a girl friend on a frozen canal when the wind caught her skirt, and away she went. The swirling dirndl suggested to the young Dutchman a sailboat for ice. Dutch settlers later brought their own to America, and for a century made New York's Hudson Valley the center of ice-boat activity.

The sport caught on as a rich man's pastime. Sails in the early days ran to 1,000 sq. ft., and expenses were high; runners cost as much as \$1,000. Thus names like Astor, Vanderbilt, Roosevelt, and Ruppert dominate the early racing annals. But anonymous professionals usually did the racing, and it was a rough business. On nights before a big race, such as the Challenge Pennant, crews slept with their boats, to beat off marauding competitors and perhaps do a little marauding of their own. A more acceptable diversion was to race New York Central trains as they steamed down the Valley. It was no contest, when the wind was right.

The early designers theorized that the bigger the sail, the faster she would go. But the giant boats became obsolete as the science of aerodynamics came along to tell the ice sailor that the wind not only could push his boat but could also pull it along much faster. The principle was the same as in the "lift" created by airflow over an aircraft wing. With his sail set in relation to the wind to create this effect, the ice boater found he could move at far greater speeds than the wind itself.

Despite this new dimension, the heyday of the sport seemed to be over by the 1930s. Ice breakers had opened the Hudson to commercial winter traffic, and many of the rich families found other amusements. But the sport sprang up in the Midwest. The Hearst and Stewart Cups became coveted prizes, and interstate and even international rivalry went on to new heights.

The new era has brought new designs. Where the old boats, steered by rear tillers, used to spin out when the wind heeled the steering blade off the ice, the new boats have their steering blades in the front. Masts are now higher, and raked, but sails are smaller. One of today's biggest boats, the "Skeeter", carries 75 sq. ft. of sail, but hits speeds of over 100 mph. There are only about 700 in the U.S., and they can cost up to several thousand dollars.

Actually, there has been a place for the little man in the sport since 1937, when the Detroit News ran a how-to story and a set of plans for a small ice-boat at "depression" cost. It became the DN (for Detroit News), and today there are nearly 3,000 DN-60 boats in the U.S. and 500 abroad. They carry 60 sq. ft. of sail, and do a smart 60 to 70 mph.

What started as a "depression" boat now costs \$695 complete. But it can be bought in kit form (sails included) for \$450, or built from plans for \$200. Robert Wotton of Montvale, N.J., a dealer and manufacturer of DNs, however, has come up with something even smaller and less expensive, the "Wisp." It carries 34 sq. ft. of sail, can do 45 mph., and costs \$295 complete. It is so simply designed, that just unstepping the mast makes it ready to be popped onto the cartop and carried wherever the ice may be.

Although many ice boaters build their own, four major builders have emerged in the Middle West. William Boehmke of Walworth, Wisc., and KEM Marine, Waukesha, Wisc., will build anything from a "Skeeter" to a DN. Mel Holman, Toledo, O., and Gougeon Bros., Bay City, Mich., specialize in DNs.

While iceboating is now enjoying something of a renaissance—you couldn't tell it from the amount of literature available. There seems to be only one really good book on the subject. It's *Ice Boating* by S. Calhoun Smith, published by A. Van Norstrand in 1962. It's out of print, but your local library may have a copy.

Getting started in the sport is mainly a matter of local geography and climate. Wherever ice boating abides, local newspapers usually carry feature stories on clubs to join. Otherwise, the National Ice Boat Authority, Box 40, Williams Bay, Wisc., 53191, can direct would-be ice boaters to the club nearest their home.

As for clothing, the word is warmth. Ski clothes under a snowmobile coverall will do it. Thermal boots are a must. Mittens, not gloves, are best. Metal-spiked "creepers" for walking on ice are advised. Ski goggles are excellent for eye protection. Even though racers wear crash helmets, they shun visors—these can frost up. And, while some purists like to "feel" the wind with their face, there are times when a ski mask is absolutely essential.

If that catalogue doesn't deter the beginner, there are some purists who wish that it might. Says one past national champion, "There are so few good week-ends during the winter, so few good places to sail. Why should we publicize the sport, and turn our frozen lakes into ski slopes?"

He is fighting the elitist's losing battle. Ice boating has survived because it is fun, as safe as any winter sport, and a heartily sociable way to play. The people joining the sport are a friendly lot, and it looks as though a lot more of them will be DN-ed and Wisp-ed away this winter.

—RICHARD A. WOLTERS



©PLAYBOY®, Playboy Bunny, and Bunny Costume are marks of Playboy. Reg. U.S. Pat. Off.™

## If you'd like to see how beautiful our building products are, just take a look at one of our doors.

In case you haven't noticed there is a door in the picture. It's one of the many C-E aluminum patio doors at the new Playboy Club-Hotel at Great Gorge, McAfee, New Jersey. Doors that were built to show off the clean modern lines of this complex, yet work efficiently year after year.

But this is just one of the many product lines at C-E Glass and C-E Building Products.

Lines that include insulating glass that has a mirror-like, gold coating to reflect sunlight; hermetically-sealed units that have rotating venetian blinds between the glasses; and tempered glass for applications where safety is as important as looks.

Plus windows and sliding glass doors for residential and commercial, store-fronts, curtainwall, shower-tub enclosures, storm windows and doors.

Everything to keep up with the building boom, including the kind of quality service that helps to sell quality products nationally.

And the real beauty of it is that they're all well-built.



**COMBUSTION ENGINEERING, INC.**  
277 Park Avenue, New York, N.Y. 10017

**Our names in the building industry... C-E Glass and C-E Building Products.**



**We're  
29 stories up.  
And closer to  
heaven than  
most places.**

For reservations dial  
**800-325-3535**



**Sheraton-Boston Hotel**   
PRUDENTIAL CENTER  
SHERATON HOTELS AND MOTOR INNS A WORLDWIDE SERVICE OF IIT

## Business Week's Guide to Personal Business

This unique book, distilled from the popular "Personal Business" section of *Business Week*, offers you a wealth of new ideas on planning and managing your personal finances. Real estate, investments, insurance, school costs, taxes, estate planning—even advice on how to choose and evaluate an advisor! The money you can save—or make—from just one of the ideas in this 320-page guide should more than pay for its modest cost.

Get it now from your favorite book store for \$9.95. Or send your order (enclose payment please) to the address below.

Note: a special deluxe edition, bound in buckram, gold stamped, slipcased is available at \$2.50 more per copy, *by mail only*.

Business Week Guide  
Book Service Office  
330 Broadway  
Marion, Ohio 43302

## EDUCATION

### Spreading the bills for college

Since Yale announced it last year, the Ford Foundation has come up with \$500,000 to study it. More than 100 colleges have sought information about it. Duke University is giving it a try, and fully one-third of Yale's freshman class is on it. It, of course, is the Tuition Postponement Option (TPO), as it has been dubbed at Yale.

It's a new way of financing college costs that is stirring debate in just about every bursar's office across the country—and considerable interest among students and parents looking for any reasonable way to ease the crunch of the rising cost of a college education. TPO and similar plans are even capturing the hopeful attention of the moderately well-to-do, whose income excludes them from most low-interest loans and nearly all scholarship aid, and who find the only way to keep ahead of mounting college expenses is to rifle their savings accounts and portfolios.

Students who elect TPO are, in effect, offered an alternative to the traditional college loan with its stipulated repayment sum. Instead, a student will face repayments of .4% of his after-graduation income per \$1,000 borrowed, whatever his income—be he cashless hippie or moneyed tycoon in later life. There is a minimum payment, but it is only \$29. While borrowing so far is limited to \$800 a year, the pay-back time can stretch all the way to 35 years, instead of the usual 10-year maximum on student loans.

The idea of repaying education loans at a sum based on later earnings is not revolutionary. Conservative economist Milton Friedman suggested it back in the 1950s, and Jerrold Zacharias, current president of MIT, picked it up in the 1960s. But some educators deplored the idea. They insisted that society benefits as much as the student from his education, and thus should subsidize it. Be-

## If you read the May 31 issue of TIME, you won't want to miss the 1971 issue of Georgia's Industrial Survey.



If you caught the cover story of the May 31 issue of TIME, you read that "the Southern boom has urbanized and industrialized Georgia more quickly and completely than the rest of the Deep South.

"Georgia leads the region's indexes of growth and change."

Of course, you don't have to take TIME's

word for what's  
happening  
in Georgia.

You can send for  
your free copy of our 1971  
Industrial Survey and get it  
straight from the source.

Georgia Department of Industry & Trade  
Industry Division, Dept. MH-5, P.O. Box 38097,  
Atlanta, Georgia 30334.

Please send me a copy of your 1971 Industrial Survey.

Name \_\_\_\_\_ Title \_\_\_\_\_

Company \_\_\_\_\_

Address \_\_\_\_\_

City \_\_\_\_\_ State \_\_\_\_\_ Zip \_\_\_\_\_

**Georgia, the unspoiled.**



sides, they worried that colleges would use the mechanism to justify willy-nilly tuition rises.

But the red ink in college budgets—and strapped parents—have put the idea in vogue. "Because of the financial pinch, we had to raise tuition," explains Yale's Associate Director for Student Services, C.P. Howland. "But in the past, a lot of the raise was diluted by the additional financial aid we had to give. So, to get us—and the student—over the hump, we came up with TPO."

While it is the student who ultimately bears the burden under TPO, there are some dispensations. For one thing, a newly-employed graduate is not clobbered with stiff repayments at the very moment when his career is at bottom earnings. Then, too, his choice of vocation is not circumscribed by the need to make money fast.

A rich Yale alumnus, on the other hand, can end up subsidizing his poorer classmates. To fulfill his obligation to Yale, each TPO recipient is placed in a repayment "class". He continues to pay back .4% of his income until the total "class" debt is paid. A wealthy man could end up paying back three times what he borrowed, while a poor one might pay back only a fraction. The rich man, however, has an escape under TPO—paying back 150% of what he borrowed, with 7% interest, clears his obligation. At Duke, where there is some "need" requirement, grads can pay only their own freight by repaying their loan, with 8% interest.

"From the school's point of view," says Bruce Johnstone, who is studying the idea at the Ford Foundation, "there is just an incredible number of variables to consider." For starters, there is determining potential average incomes for a long period of time, ascertaining who might elect such a program, and—more crucial—finding a source of money to make such long-term loans. Yale has been able to borrow, but not all schools have Yale's backing in endowment and prestige. Duke has simply allocated \$50,000 of its scholarship money for the experiment, lending it out on the basis of need at the rate of .36% over 30 years.

Obviously, as yet, deferred tuition loans are barely a trickle in the flood of tuition borrowing. Johnstone estimates the national education loan outflow at \$1.5-billion this year alone.

While colleges are cautiously juggling the variables that may lead to other income-contingent plans, parents continue juggling their finances to pay for schooling. Of course, Yale's costs of \$4,400 (probably \$300 higher next year) are higher than most, but it is the rare parent who can look at current bills from any college without blanching. Scholarships, always hard to come by, now go only to students in real need. At most schools, scholarship students also get

## Do you need a few copies?



## A versatile duplicator?



## Or a complete reproduction department?

Making a few copies with a duplicator is like hiring a bus to take the baby-sitter home.

Duplicating lots of copies with a copier is like borrowing a bicycle to take the Ladies Auxiliary Club home.

There's no such thing as an efficient "copier/duplicator". That's why Gestetner—the world's leading maker of duplicating equipment—now offers an equally superior copier, too.

For fascinating details mail the coupon or...

**Call toll free—(800) 243-6000.**

(In Connecticut, call 1-800-942-0655.)

### Gestetner

Dept. PEB-2  
Gestetner Park,  
Yonkers, N.Y. 10703

Please send information about:

- Duplicators
- Copiers
- Repro Center

Name \_\_\_\_\_

Organization \_\_\_\_\_

Address \_\_\_\_\_

City \_\_\_\_\_

State \_\_\_\_\_ Zip \_\_\_\_\_



## The Sheraton-Park in Washington, D.C.

### Where a little meeting goes a long way.

Lecture rooms. Conference rooms. Reception rooms. Rooms for meetings of 20 or 200. Spacious suites in our Congressional Wing for all-day sessions in complete privacy. At your disposal after your meeting, all the superb facilities of the Sheraton-Park, including luxuriously refurbished accommodations at moderate rates. Write for our conference brochure or call our sales office collect at 202-265-2000.



### Sheraton-Park Hotel & Motor Inn

2660 WOODLEY ROAD, N.W.  
SHERATON HOTELS AND MOTOR INNS  
A WORLDWIDE SERVICE OF **ITT**

Director of Sales  
Sheraton-Park Hotel & Motor Inn  
2660 Woodley Road, N.W.  
Washington, D.C. 20008

Please send me your conference brochure, including complete information on smaller meeting facilities.

Name \_\_\_\_\_  
Title \_\_\_\_\_  
Organization \_\_\_\_\_  
Address \_\_\_\_\_  
City \_\_\_\_\_ State \_\_\_\_\_  
Zip \_\_\_\_\_

all the campus jobs. Although some schools help find off-campus work, many will not let freshmen take it. Low-interest loans are also reserved to those with average incomes of about \$7,500. Better-heeled parents can only dream of the 3% National Student Defense Loans.

There are alternatives. The government guarantees 7% loans, with a lid of \$1,500 a year and \$7,500 per customer. These become payable only nine months after graduation. While they are made by many banks, bankers do not publicize them, since there is so little profit involved. Also, these loans are restricted by need, since they are insured by federal, state, or United Students Aid Funds programs.

It should be noted, however, that different states have different stipulations, and "need" is not always equated with income. With colleges that use the College Scholarship Service to allot scholarship money, need is determined by a number of things: size of family, number of children in college, elderly dependents, medical or emergency expenses, current debts, and even the ages of the parents and their probable retirement needs. Fully 15% of such guaranteed loans go to families in the over-\$15,000 brackets—although they, unlike less prosperous borrowers, pay interest on the loan while the student is still in school.

Still, the going rates for education loans can pinch even the upper-income parent. Interest ranges from 11½% to nearly 13%. And, though big banks make such loans, smaller ones are often reluctant, giving them only to old customers. Then, too, the payments are due practically before the money reaches the college. Some banks do offer plans to stretch tuition costs, say, by paying two

years over a four-year period, or four years over eight. But this can boost effective interest above 15%.

Bankers concede that if a parent must borrow from them, he gets his best deal by putting up stock or other collateral, or re-mortgaging his home. There are other optional plans for the parent who can foot schooling costs but simply does not want to part with two large lump sums, one for each semester, each year.

The largest and oldest of these is The Tuition Plan, Inc. (575 Madison Ave., New York, N.Y.). It has a dozen different ways of financing an education, and offers its services through some 800 colleges or directly to individuals. There are options to repay on a monthly or quarterly basis, spreading the cost over five or six years, all the while borrowing each semester's funds when they come due, thus holding interest charges down. Still, this is not cheap—interest runs to 1½% per month, or 18% annually.

Borrowing on one's insurance is probably the best answer for the parent with whole-life coverage. "This is a touchy subject with some insurers," says one insurance man, "but, no matter what the company, anyone can borrow the full cash value of his policy." It's a losing proposition for the company—interest only runs 5% or 6%. But a man of, say, 45, who has had a \$20,000 policy for 20 years will have access to cash value of about \$5,680. Furthermore, he can set his own terms of repayment. Or he may not pay it back at all, but have the borrowing, plus interest, subtracted from his policy's worth.

With costs going in only one direction—and fast at that—there is a question in many minds as to how much of the burden parents can go on bearing. What makes Yale's TPO and Duke's tuition option plan particularly interesting to educators is their emphasis on giving the student himself some of the load to carry. Redistribution of the burden has a special appeal as U.S. students continue to go on to graduate and professional schools. Indeed, graduate schools at both Yale and Duke are trying the optional plans, and Stanford's president, Dr. Richard W. Lyman, has said, half-wistfully, that he would like to see the university's business school using one.

Perhaps not surprisingly, many students seem delighted at the idea of taking on some of the cost, and some educators even think such a plan could help de-fuse campus disorder by making the student feel more a part of the college establishment. Everett Weatherspoon, administrator of Duke's plan, makes an additional point: "It's a good scheme to link students to the institution. It's not just a loan, but an arrangement that makes them contributors to the institution over the years."

—BARBARA RADLOFF

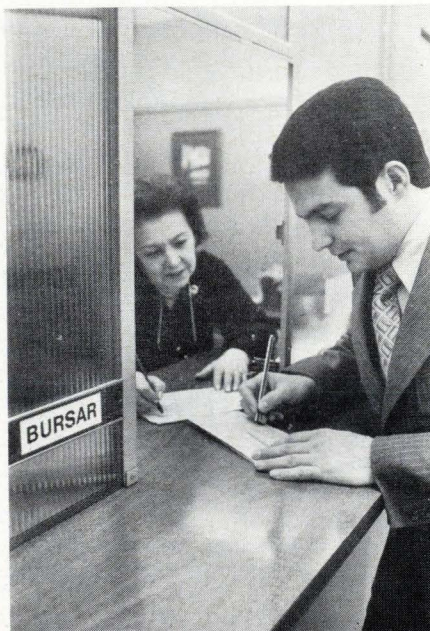

Dick Wolters

Students are now borrowing \$1.5-billion.

# TED FOX TALKS ABOUT BECOMING THE DOMINANT CALCULATOR COMPANY

"When we established UniCom in mid-1971, we set a fairly ambitious objective for ourselves. We said we were going to become the dominant company in the calculator industry. Nothing less. The laughter you heard was from our polite competitors. The less polite simply called us crazy. □ In a fiercely competitive market, how could a new, little company hope to compete with the really big guys—Friden, Sharp, Monroe, SCM, Burroughs, Olivetti—and the dozens of others crowding the industry? □ So that our announced objective wouldn't sound like an idle boast, we explained how we were going to become number one. We said that we were going to put together a management team that knew how to react. With products and with service. We said that we would establish a broad distribution network to reach every nook and cranny of the market. We said that we would offer the broadest product line available in terms of both price and performance. That's what we said we were going to do. And we have done it. □ UniCom is already a larger calculator company than many well known, older companies. In fact, recently we shipped more machines in a single month than one of the greatest names in the American calculator industry. □ Our nationwide distribution network of company-owned branches, franchise dealers, consumer product dealers, and mass merchandisers is being established right on schedule. New products are being introduced at a pace that many long-established companies cannot match. And finally, in the only meaningful test, sales have reached levels that might have seemed outrageously high for a new company—before UniCom. Suddenly there isn't much laughter from the polite competition. But the less polite still say we're a little crazy."

**UniCom**  
Systems, Inc.

Cupertino, Calif. 95014  
Telephone: (408) 255-3650

**THEY'RE CRAZY ALL RIGHT.  
CRAZY LIKE A FOX.**

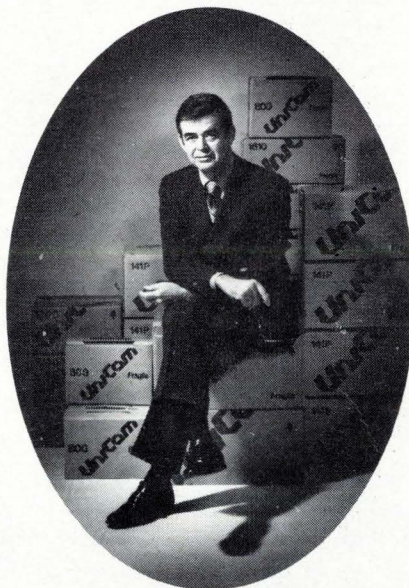

Theo L. Fox, President  
UniCom Systems, Inc.

## Home workshop: Start it small, but think big

Since the do-it-yourself boom started about 25 years ago, the home workshop has advanced to a stage of virtual space-age sophistication. So have the skills of some of the business and professional men who descend during these long winter evenings into their private workshops for their more creative recreation. Much is due to the versatility of tools now available. But, while cabinet work, refinishing and fix-it jobs still are the main products of U.S. home workshops, a growing number of amateur craftsmen have branched into work formerly reserved for professionals.

A Pennsylvania physician, for instance, restores old violins and other musical instruments (with rave reviews from critics). A midwestern lawyer, specializing in metalworking, has become a notable sculptor-in-metal. And a Connecticut doctor with a bent for astronomy has built a complete home observatory, largely with sophisticated equipment turned out in his own workshop at home.

Even if one's workshop goals are more modest, knowing how to set up a workshop, or expand an existing one properly, can make a major difference in final results. And today, of course, a minimal workshop of some sort is essential just for surviving in a world where

plumbers seldom make house calls and a good repairman is more than just hard to find.

First rule is to start with a good location. Most commonly, workshops are set up in the basement or garage, but there are plenty of other possibilities. Workshops have been located in attics, closed-in porches, spare rooms, and separate structures. In a pinch, a mini-shop can even be set up in a closet. In his *The Complete Book of Home Workshops* (Harper & Row, \$8.95), David X. Manners describes how it's done by hanging essential tools and a fold-down table in the closet interior.

A serious workshop should start with a minimum floor area of 8x12 ft. with a 7-ft. ceiling height—larger if big stationary tools are contemplated. If future plans are flexible, the rule is to start small and think big; pick a location that can easily be enlarged. Besides space for tools and working area, the provident do-it-yourselfer also allows elbow-room for handling large sheets of plywood and long lumber. That also calls for a convenient and comfortably large outdoor entrance.

For safety's sake—and for the sanity of others in the family—it's usually best to enclose a workshop within its own four walls, if possible. If there are children around, a lock should go on the door. Good, bright illumination is essential, and fluorescent lighting gets the nod over conventional bulbs because of its low-glare, high illumination characteristics. Adequate wiring (for three-prong outlets) should be installed, of course, for power tools.

Depending on location, a small heater may have to be installed. Naturally, good ventilation is important. Fumes from paints, stains and other finishes can be a

hazard, so an adequate built-in exhaust fan is recommended.

Storage space for lumber and materials depends, in the main, on the ambitions of the workman involved. Ceiling-high bins, such as one sees at lumber yards, conserve floor space, and are a boon in storing long lumber. Convenient storage should also be planned for those inevitable odd-sized leftovers.

If the workshop is to be any fun at all, it should be easy to clean. Choose low-maintenance materials, and if the floor is the usual basement concrete, paint it or put down asphalt tiles.

As for tools, Rule No. 1 is: Don't skimp on quality. Even the simple hand tools should be good quality. The same certainly goes for power tools like the electric drill, the most commonly needed power tool of all. Models can be bought for \$10 or \$15, but it almost always pays to spend the \$30 to \$40 for a top-quality drill, one with double insulation to prevent shocks, for example.

The biggest mistake in assembling tools, however, is failing to think through one's tool requirements, and buying a lot of expensive power equipment that is rarely needed. With the attachments and accessories available today, the ubiquitous ¼-in. power drill fills a multitude of needs—as electric screwdriver, sander, grinder, saw, polisher, or paint mixer. There is even a new attachment (about \$7) that turns the drill into a pump to bail out a damp cellar or boat.

The ultimate step is buying stationary tools, with their own working surfaces. The three prime items are the 10-in. saw, a combination jointer-planer-miller (chiefly for fine cabinetry), and radial drill press (especially for metalwork). All three will cost about \$500. For considerably less, a less than all-out enthusiast might do well to consider one of the versatile stationary tools, such as a radial-arm saw with accessories.

A good look around before leaping into the big-tool market is essential. This will require visiting stores, and some reading. One of the best books for the beginner is *America's Handyman's Book* (Scribner's, \$8.95), with excellent sections on tools and workshop practices. Another is the perennial best-seller, *How to Work with Tools and Woods*, first published 45 years ago, since revised, and still available for \$1.25 from Stanley Works, Dept. P.I.D., Box 1800, New Britain, Conn., 06050.

One area certainly worth scouting is the adult education program of the local high school or community college. Many have well-staffed manual arts departments which run after-hours classes in the workshop crafts for everyone—from skilled amateur to the all-thumbs, elementary beginner.

—ARTHUR M. WATKINS

"Even if one's goals are modest, knowing how can make a difference."



You have a lot more going for you when you make Lyon your single source for all your steel equipment needs. Because we must offer the best products and services to maintain our leadership. We must live up to our reputation for precision quality.

We must offer the broadest selection (more than 1600 stock items). Our products must be the easiest to order. Our packaging must be the finest. Our delivery must be the fastest. And our field service must be outstanding. So, we put more manpower in the

field, maintain the largest dealer network, and three strategically located plants. We see that you get personal help when you need it. Call your Lyon Dealer for *all* your steel equipment needs. There is a lot to be said for staying with the leading name.

## There's a lot to be said for staying with the leading name

LYON METAL PRODUCTS, Inc.  
75 Monroe Avenue, Aurora, Illinois 60507

Please send me a copy of catalog No. 100

Name \_\_\_\_\_

Firm \_\_\_\_\_

Address \_\_\_\_\_

City \_\_\_\_\_ State \_\_\_\_\_ Zip \_\_\_\_\_

Look for us in the Yellow Pages under LYON  
"STEEL SHELVING," "LOCKERS," or "SHOP EQUIPMENT"



LYON METAL PRODUCTS, INC.  
General Offices: 75 Monroe Ave., Aurora, Ill. 60507  
Plants in Aurora, Ill., York, Pa., Los Angeles  
Dealers and Branches in All Principal Cities

**LYON** METAL PRODUCTS®



### Investors' play: stamps at 2¢ each —up to \$280,000

These days the stamp collector is more and more the dead serious investor with a sizable bankroll. Stamps can give you a hedge against inflation as well as rapid appreciation. Consider the recent sale of a 1¢ lone surviving British Guiana stamp, auctioned for \$280,000; the buyer was no rich eccentric, but a bidder representing a syndicate of investors. Since 1960, collections of American and European stamps have appreciated an average 10% a year, and anybody with a good Japanese collection might have seen his holdings soar in value as much as 1,000%. . . . Today, floating currencies provide an added lure. Foreign stamps fluctuate in the same way as the value of a foreign currency. So, for example, a German collection—on the basis of the currency relationship alone—would bring more in dollars than it did a year ago.

To get started, it may be wise to consider having a good dealer assist in building a basic collection. His fee will be 5% to 10% of stamp value; but the quality will show up when you undertake later dealings. Dealers belonging to the Collector's Club are reliable; here, though, more checking is needed. There are many sources for adding to a collection. October to May there is an auction in the U.S. almost daily, with frequent bidding by mail. Auctions are followed in *Linn's Weekly Stamp News* (Sidney, Ohio 43565) and *Stamps Magazine* (153 Waverly Pl., New York 10014). For general Background: *The Foundations of Philately*, by Boggs and Strange (Faber & Faber, London). . . . Caution: Stamps, too, take some patience. There can be bad years, such as 1970 when collections had little or no appreciation—like stocks in 1970.

### Que nos vemos mañana en Mexico

*Mexico: An Extraordinary Guide* is by Loraine Carlson, a journalist who for 20 years has covered the territory in the course of repeated expeditions. She knows the chic restaurants of Mexico City's Zona Rosa as well as the remotest archeological sites from the Yucatan to southern Chiapas on the border of Guatemala. Anyone planning a trip—even a week's trip—would do well to bone up on Mrs. Carlson's ideas for "digging into Mexican soil." She gets you past the tourist veneer (Rand McNally, \$9.95). . . . *Fodor's Caribbean, Bahamas and Bermuda 1972* keeps its rating as possibly the best of many guides. Practical information is excellent, as is treatment of the island cultures (McKay, \$8.95).

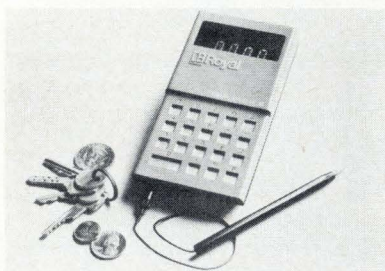

Insurance scene: J. K. Lasser, the tax firm, has been telling clients about the "fifth option" under some life insurance policies. Dividends on a policy can be taken in cash, applied to cut premiums, used to buy paid-up coverage, or left with the company to draw interest. A fifth option, notes Lasser, lets the insured use his dividends to buy more coverage in the form of one-year term insurance. This idea is being used by younger men with children; it's a way to build protection during a time of greatest need. It is also used by older men who are in poor health since the term coverage is available without a physical examination. . . . Managing math: A 14-oz. battery-powered electronic calculator with an 8-digit capacity has been put on the market by Royal Typewriter (Litton). The pocket-size Royal Digital III adds, subtracts, multiplies, divides, performs mixed calculations (\$139.95).

### Vintage '71

If you lay away just an occasional few bottles of wine, you may have wondered about the 1971s of France. Wine expert Robert J. Misch labels '71 a "good" year and notes that the Bordeaux and Burgundy productions are of high quality; the Beaujolais crop is excellent, while the '71 Rhines and Moselles are beautiful—but prices of all are high due to small crops. . . . PB's restaurant-of-the-month: Green Tulip in New York's Plaza Hotel—but tabs are high here, too.

---

# International Newsletter

---

February 28, 1972

**U.S. aerosat  
veto angers  
Europeans . . .**

European electronics firms and space officials are shocked—but not speechless—over White House rejection of the aerosat agreement that would have given U. S. and European governments 50-50 ownership of the \$140 million air navigation satellite system for the Atlantic and Pacific. The decision junks the accord painstakingly worked out last summer by the Federal Aviation Administration and ESRO, the European Space Research Organization [*Electronics*, International Newsletter, Aug. 16, 1971].

The White House, which favors private ownership of aerosat, has shifted future negotiation responsibility to its Office of Telecommunications [see p. 38]. **Europeans had given up their demand to write in a 50-50 hardware contract provision in the FAA-ESRO accord and settled for a clause promising a "fair and reasonable" portion of the development and production of components.**

**. . . who may build  
their own  
Atlantic system**

The White House move indicates that U.S. will push for ownership by one U. S. company, leaving some European firms a minor share of production under subcontract. Space officials are so irked that they warn privately that failure to work out an amicable agreement will "jeopardize all areas of space cooperation" with the Americans.

But "the door is still open," says one informed Paris space official, warning, "if we can't have half ownership, we have alternative plans—such as our own system for the Atlantic."

**ESRO awards  
contracts for  
regional comsat**

For a regional communications satellite, the European Space Research Organization is thinking in terms of a single satellite weighing about 1,800 pounds or of two spacecraft weighing half that amount. In both cases the total capacity is likely to be between 8,000 and 25,000 telephone channels, plus two color TV channels, through 12 repeaters in all. According to definition study contracts just awarded, the **two small craft may have an edge because they offer less risk of total failure of the project due to launch troubles, and partly because they could use smaller launchers.** The small-craft study will be carried out by the pan-European Cosmos consortium, led by Marconi Space and Defence Systems Ltd. The large craft will be studied by the STAR consortium led by British Aircraft Corp. Launch date will be near the end of this decade, preceded by the flight of a smaller experimental craft.

**West Germans  
to woo Soviets  
with instruments**

In an effort to establish a bridgehead on the Soviet Union's instruments market, two West German test and measuring equipment makers are getting set for a big demonstration of their wares in that country. **Significantly, the two firms—Rohde und Schwarz and Wandel und Goltermann—have picked as a site of their exhibition the West Siberian city of Novosibirsk, the oft-quoted center of electronics research activities in the Soviet Union.** At the nine-day specialists-only show in June, the two companies will exhibit an across-the-board program of their latest equipment and will hold a concurrent series of technical sessions. A Rohde und Schwarz spokesman says his firm is hopeful of getting a foothold in the Russian instruments market, but that it is **also aware of**

---

# International Newsletter

---

still-enforced, albeit relaxed, embargo regulations that could bar the sale of some sophisticated equipment.

## Tokyo supermarket sells eight-digit calculator for \$87

Japan's consumer calculator age is being ushered in with two private label calculators, built by Crown Radio Corp., now on sale at supermarkets operated by Dai-Ei Inc. One calculator is an eight-digit unit that sets new low price for calculators of \$87 in Japan. The other is same basic calculator with built-in AM-FM clock radio for \$129. **The lowest previous price was \$10 higher for a 12-digit calculator announced late last year by Eiko Business Machines Ltd.** The calculators use single chip LSI, made by Texas Instruments, which feature a constant key and suppression of zeroes before the first significant digit.

Crown last year got into the domestic private label business with 13- and 18-inch color TVs for Dai-Ei. **But Crown's exports are doing badly and there are rumors that Dai-Ei will take over company as its consumer electronics subsidiary. There is no precedent in Japan for a supermarket having such a subsidiary.**

## \$150 million seen in decade for Norway computers . . .

Norway expects sales in its relatively small computer industry to reach about \$150 million annually in a decade. **Sales last year amounted to \$40 million—including data-processing services—and that was 25% more than in 1970.** The increase will come through concentration in highly specialized Norwegian industrial areas—primarily shipping, shipbuilding, smelting, and chemicals—according to Finn Lied, minister of industry. Lied made the prediction at his nation's first industrial electronics export trade show in Stockholm earlier this month. **Displaying wares were 10 companies, including the two Norwegian computer makers, Kongsberg and Norsk Data-Elektronikk.** Lied, an EE, said that the two companies sold or took orders for 350 machines, including Kongsberg's military minicomputers.

## . . . as shipboard systems sell well

**The leading Norwegian supplier of shipboard computer systems, Noratom-Norcontrol A/S has sold a total of 27 data bridge systems and two chief systems.** The bridge system is primarily for navigation and collision avoidance; the chief system is for engine room control and maintenance. Sales last year, according to Ibb Hoivold, managing director, reached \$3 million. He estimates his company will sell at least 20 systems annually in the next few years. The Norcontrol units use Norsk-Data computers. **Meanwhile, the other Norwegian computer maker, Kongsberg, has delivered two machines for installation on Swedish-built and -owned supertankers.**

## Japanese makers push color TV in Yugoslavia

Now that Yugoslavia's market for color television sets is taking shape, Japanese firms are lining up to get in on the action. **One, Hitachi Ltd., is negotiating with a Zurich-based import-export agency about delivering to Yugoslavia some 5,000 sets.** Another Japanese firm is said to be discussing a deal to sell receiver components to firms in Yugoslavia for assembly there. **Color broadcasts based on the West German PAL system were started officially in Yugoslavia a few months ago, but test programs have been aired for the past two years.**



## Japanese makers turn out new 110° color tubes

Hitachi is latest to announce a narrow neck, wide angle tube; first version is a 20-incher

The move to 110° deflection-angle color picture tubes is picking up steam in Japan with announcement by Hitachi Ltd. of a 20-inch tube with a 29-millimeter narrow neck, which it will show at the upcoming IEEE show. The tube for Japan will have a black matrix, but the one for the U.S. and parts of Europe will not because of a Zenith patent. Hitachi will follow this tube with 18- and 16-in. sizes.

This strong 110° effort by Hitachi will make it the second big 110° company in Japan, after Mitsubishi, and it will have greater effect because Hitachi sells tubes outside company as well as to own TV division, while Mitsubishi tubes are for in-house use only. Toshiba has just unveiled a 36-mm neck 110° tube, and both Matsushita and New Nippon Electric Co. have distributed samples of 110° tubes with 29-mm necks to customers. Industry observers say that by April all Japanese companies will market sets with 110° tubes.

In a departure from usual practice, Hitachi has talked more about the method it uses for making the tube, which can operate with ordinary components and circuits, than about the tubes themselves.

In most 110° tubes, the large convergence angle near the edges of the tube upsets the static convergence adjustment, and dynamic convergence compensation causes shape

distortion. Thus, the three electron beams passing through an aperture in the shadow mask no longer land on corners of an equilateral triangle. This causes mislanding, which can degrade purity.

A connection lens used when baking phosphor dots onto the faceplate with ultraviolet light during fabrication is supposed to make the light rays more nearly correspond to electron beam paths, which puts dots where beams actually land and thus prevents mislanding. Hitachi says that a continuous lens is inadequate for the task and has developed a stepped plastic multiblock lens, which resembles a checkerboard with 315 facets.

Hitachi's tube permits building a TV set with components and circuits similar to those used with 90° deflection-angle tubes, rather than requiring use of special deflection coils or complex and expensive circuits, such as those used by Philips and other European manufacturers.

Hitachi fabricates the tube to match the distorted trio produced by three electron beams, rather than correcting the shape of the electron beam pattern. This limits transparency at edges of shadow mask so dots do not overlap, and may limit transparency of the mask near the center, so the ratio of transparencies is not too great.

Meanwhile Toshiba announced its 110° tube with in-line gun [*Electronics*, Nov. 22, 1971, International Newsletter], which it says has an electron-beam shape error of about one quarter that of Hitachi tube, permitting greater brightness. Toshiba says it has already distributed samples to Japanese and foreign set makers at the end of last year. Be-

cause of a small shape error, Toshiba's tube can be made with ordinary continuous correction lens.

---

### France

---

Barium titanate with iron will store trillion bits

Les Grands Informaticiens—the computer architects responsible for the next generation of French data-processing hardware—are thinking big when it comes to memories. They want a fast random-access memory that can store up to  $10^{12}$  or even  $10^3$  bits.

To pack such a staggering quantity of information into a manageable package—say a few tens of cubic centimeters—magnetic cores or even semiconductor memories are out of the question. But a “stack” of millions of holograms each one a “page” of some  $10^5$  bits, is one answer [*Electronics*, Feb. 14, p. 60].

**Compact.** Researchers at Thomson-CSF think they've found a technique that eventually could lead to memories with millions of holograms crammed into a workable volume. François Micheron has successfully demonstrated that holograms can be “stacked” into ferroelectric materials. Another team headed by Erich Spitz is at work trying to translate Micheron's essentially physical discoveries into full-fledged mass memories.

There are hundreds of ferroelectric materials, but Micheron has found one with the three main properties needed for a mass hologram memory. It's a barium titanate doped with iron impurities. Because

of the impurities, the transparent crystals are highly photosensitive, and that's the first property necessary to record the interference waves that make up a hologram. Secondly, the hologram patterns can be fixed rapidly in the crystal so they won't be wiped out when they're read out by a beam of light. Finally, once fixed in the crystal, holograms can be erased with little trouble and new ones written in.

**Fix.** The CSF people were not the first to look at ferroelectric crystals for optical memories. A team at RCA last summer recorded and fixed holograms in a complex material—LiNbO<sub>3</sub>. To fix its holograms, though, the RCA team has to heat its crystals to 100°C and hold them at that temperature for 30 minutes. To erase, the crystal has to be heated to 300°C.

In the French method, proved out for the first time last fall, fixing and erasing are accomplished electrically and take between a millisecond and a second. Micheron explained the technique at the International Solid Circuits Conference in Philadelphia.

When there's a holographic pattern projected into the ferro-electric crystal, space charges build up at the boundaries between lit and unlit areas because of the migration of excited impurity electrons. The electric fields associated with the space charges vary the refractive index of the crystal to record the pattern.

The readout, of course, has to be by light. Ordinarily, then, the electrons would be excited once again. In other words, no more pattern.

**Ionic.** Ions, however, don't migrate when they are illuminated and thus the hologram pattern can be effectively fixed by setting up an ion pattern that matches the electron pattern. This is what the RCA crew do when they heat their crystals. The ions become mobile and migrate under the influence of the space charges associated with the hologram pattern.

Micheron, too, sets up an ionic pattern, but he makes the ions move by means of electric fields. There's no external applied field on the crystal during writing, although

there is an internal one, the remanent field characteristic of a ferroelectric material. The space charges set up by the electron migrations interact with the coercive field, which becomes spatially modulated inside the crystal.

Now, applying an external field causes partial switching of ionic polarization and therefore forces the ions to take a pattern matching that of the electrons. The fixing field is 1 kilovolt per centimeter. Erasure is accomplished by applying a field high enough to saturate the crystal and thus reestablish a uniform distribution of the ions. The erasing field has to be between 4 and 5 kV/cm.

---

### Using capacitances to measure microdistances

A private electronics laboratory in Grenoble has developed what it calls a new concept in measuring microdistances, one that can provide precision up to 1/160 of a micron without contact. Its developers foresee a broad spectrum of applications for the principle involved, ranging from gas analysis in pollution control to accelerometers in the aerospace field.

The first prototype last month got certification from Cetim Laboratories (Centre Technique des Industries Mechaniques), a French bureau of standards. The prototype measures the distance between two electrodes so accurately that a gentle draft from an open door causes the digital display to register the contraction of the metals. When the door closes, the temperature rises a degree or two, and the display shows the metals slowly returning to their prescribed size, 1/160 of a micron at a time.

**Center.** Researchers at LEAD (Laboratoire d'Electronique et d'Automatique Dauphinois) have been working for about 10 years on the principle of measuring distances and material consistency by recording changes in capacitance. The first successful application that LEAD made was in a centering device, us-

ing a rotating probe that finds the center of a hole by seeking the point where capacitance is equal in all directions inside the hole. LEAD president Ferdy D. Mayer has sold French license rights for the centering device to Sagem and a license option to the Industrial Metrology division of the Bendix Corp.

**Switching.** Mayer says patent searches indicate that he is original in his technique of making measurements by switching between a known capacitance and an unknown, varying the unknown until it matches the known. The switching is constant and the two circuits symmetrical, eliminating the danger of error by frequency drift or accidental vibration. The principle, Mayer maintains, can be used in the measurement of resistance, inductance, or even optical parameters as indicators of distance. He is now hard at work on new prototypes and new applications.

He demonstrated at Cetim's laboratories near Paris a prototype of an instrument to measure the distance between two electrodes. The reference capacity was 240 picofarads and the variable capacity was adjustable between two electrodes separated by 1 millimeter of air. The numerical display ticked off 160 digits for each micron of distance the two electrodes were separated.

**Noncontact.** Mayer says a major point of originality is the ability of the instrument to make measurements without contact between the two parts being measured. Thus, he sees applications in the measurement of the density of gases and in the aerospace field, where he expects to gain at least one or two orders of magnitude in precision in accelerometers in inertial platforms.

---

## Great Britain

### Spotting IC pin holes with liquid crystals

As oxide layers get thinner it becomes more difficult to stop pin holes from forming. Pin holes, or sometimes merely areas of oxide

that are too thin, cause short circuits. Until recently there has been no convenient way of locating pin holes without destroying the oxide, which makes it difficult to work out why they are there.

Now a Briton at the Royal Radar Establishment has come up with a simple method of producing a striking display of hole locations. What's more, the approach doesn't affect the holes and can be repeated indefinitely. But there's one hitch. Although IC makers in Britain say that the method looks good, the only one that set out to use it regularly—Ferranti Ltd.—dropped it earlier this month after a few weeks, despite excellent results. The snag: the technician must constantly handle a liquid crystal that Ferranti's chief chemist has advised might cause cancer.

**Details.** Basically, the technique consists of putting a couple of drops of a liquid crystal onto a slice, and placing a thin glass sheet on the drops so that they spread over the wafer and support the glass. The glass has a transparent layer of tin oxide on its underface, which forms one electrode. A voltage is applied to the back of the wafer. Where the thin oxide is not effective, as above pin holes, the crystal becomes visible instead of transparent. The crystal becomes turbulent—a pin hole display looks rather like a microscope image of active bacteria—and is very easy to see. If a pin hole connects with surface metalization, all the crystal above the shorted metal becomes turbulent.

At low voltages only obvious defects in the oxide produce a display. As the voltage is turned up, the less obviously defective areas, such as those that are simply too thin, produce a display. Switching off the voltage makes the crystal transparent again, and the tests can be repeated indefinitely, provided the oxide breakdown voltage is not grossly exceeded.

**The problem.** The trouble is that the only generally available liquid crystals that give a good display at room temperature using suitable voltages—3 to 4 volts and up—are the MBBA negative nematic types,

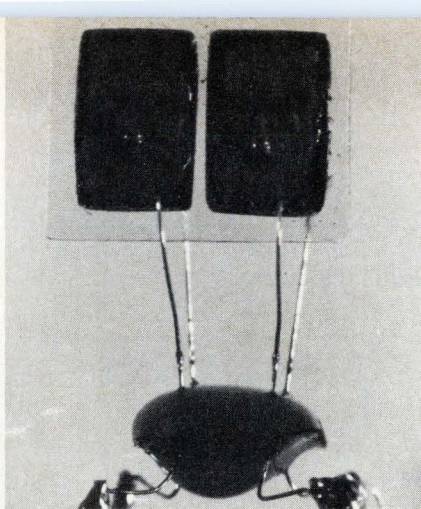

**Store house.** Analog memory device can also act as multiplier of signals.

which contain benzylidene compounds. There are grounds for thinking these compounds can stimulate cancer, and nobody has proved they don't.

John Keen, the RRE inventor of the technique, works in a fume-free area, wears surgical gloves, and takes care over disposing of the solvents he uses for cleaning crystal off the slice. However, Ferranti's chemist recommended stricter precautions, which IC development engineer Alan Worrell says take up too much time, and he has stopped routine use of the method until a known safe crystal is available. Worrell will certainly use it for routine quality control if a trustworthy crystal does come along, because it's so simple and so effective. "A test takes only a couple of minutes to set up" he says.

**Drops.** Keen, who described the technique at the International Solid State Circuits Conference, says the size of the display over a pin hole is in proportion to the thickness of the crystal layer and is only slightly affected by the size of the hole. Two drops of crystal on a 2-inch slice produce a layer about 10 microns thick, which is about optimum. He reckons a 10 cubic centimeter bottle of MBBA crystal will provide about 280 slice displays.

In England the cheapest suitable crystal is Vari-Light VL-1047 at the equivalent of \$32.60 for 10 cm<sup>3</sup>, or about 11.5 cents per slice. However VL-1047 is not a full MBBA crystal and strips off positive resists, though it is all right with negative resists. Full MBBA crystals, which don't harm positive resists, are the equivalent of about \$50 for 10 cm<sup>3</sup>.

---

## Japan

---

### Analog memory provides nondestructive readout

Even though the demand for analog computers as such is not great, equipment with analog-type computing circuits continues to proliferate. So there should be a good market for a nondestructive readout analog memory under development at the Analog Information Research Section of Japan's Electrotechnical Laboratory. The memory can also function as a variable coefficient device that can multiply a second input by the stored value.

The new memory makes use of several physical properties that occur simultaneously in single-crystal slabs of triglycerine sulphate, a ferroelectric material. Characteristics of TGS make it very suitable for use in memory applications. It is spontaneously polarized by an applied field, and the hysteresis characteristics of its polarization have a square shape.

**Locked in.** This characteristic is the most important for writing in information, because when the polarizing field is removed the polarization remains at the same level as before the field was removed. However, polarization is essentially a charge locked in the material, and it is not available for direct readout.

The piezoelectric characteristics of TGS offer the method of non-destructively reading out the stored information. For example, consider a device consisting of slab of TGS with two sets of electrodes, each set consisting of an identical electrode on opposite sides of the slab.

The material under each set of electrodes must be polarized by a voltage applied to the electrode pair to obtain piezoelectric characteristics. Then a voltage applied to one set of electrodes will set up a vibration in the slab, and the vibration will generate a voltage at the second set.

The voltage at the second set of electrodes is proportional to the polarization at the second set multi-

plied by the polarization at the first set multiplied by the voltage applied to the first set. Thus, polarization at the second set can be read out, if the polarization of the first set and the voltage applied to it are standardized.

**Saturation.** For the actual operation as an analog memory, the material under the first set of electrodes is polarized to saturation value for maximum readout voltage. Excitation is provided by connecting an IC comparator circuit to the first set of electrodes, leading to self-excited oscillations as in a crystal oscillator. Oscillation occurs at the self-resonant frequency of the slab, which is optimum for high output voltage. Oscillation waveform, and thus voltage applied to the first set of electrodes, is a square wave because of characteristics of the IC. Because the exciting waveform is a unidirectional voltage varying between a value close to 0 and a value close to the power supply voltage, polarization is not changed by the driving voltage.

When the device is used as a memory circuit, the voltage applied to the oscillator circuit is set at precisely 10 volts. As for other analog memory or hold circuits, a feedback arrangement is used to compare and set the stored voltage equal to the analog input voltage.

**Multiplier.** When the analog device is used as a variable coefficient circuit, operation is initially similar, except that the stored voltage corresponds to the variable coefficient. Then the analog input to be multiplied by the adjustable coefficient is connected to the oscillator circuit in place of the precise 10-v supply used for standardization. In this mode the output voltage is the product of the stored adjustable coefficient multiplied by the analog input voltage, which can vary between 0.4 and 10 v.

For the voltage range over which the memory device and its associated circuits provide variable coefficient operation, linearity is within about 3%. The nonlinearity appears to be closely related to the variation in the stored value with time. At present, the stored value

appears to fall about 3% during the first 30 minutes, after which its value stabilizes.

### Programable MAS ROM

comes to market

A versatile programable read-only memory developed by Nippon Electric Co. packs long-term non-volatility, on-chip address decoding, extremely high speed, transistor-transistor logic compatibility, and high yield into one product. Initially it will be available in a 256-bit version, the  $\mu$ PC451D, with a 1,024-bit version scheduled to become available this summer and even larger versions later on.

Memory transistors and all other active elements on the memory chip use the metal alumina semiconductor, n-channel, enhancement-type field effect transistor structure developed two years ago by Nippon Electric [*Electronics*, Feb. 16, 1970, p. 71]. This includes the decoder transistors, load transistors, and selector transistors.

Inclusion of on-chip decoding has greatly increased memory density by decreasing the amount of peripheral connections required. Nippon Electric can fit a 256-bit memory on a 2-by-2-mm chip, compared to the 3-by-3-mm chip used earlier.

**Structure.** All field effect transistors have a 150 angstrom, thermally grown silicon dioxide layer with overlying 1,300 angstrom alumina layer as gate insulator under aluminum gates. This structure gives a stable initial threshold voltage, rigid critical voltage, and high channel mobility. In addition, reliability is improved by using heavy boron diffusions as channel stoppers between adjacent transistors to suppress leakage current, which would otherwise be caused by the high positive voltage applied to the gate electrode during the write operation.

MAS memory chips of this type can be erased with either ultraviolet light or X rays, and a paper at the International Solid State Circuits Conference describes a method of electrically erasing the memory with

a large negative voltage. But the memory will not initially be specified in the catalog for reprogramming—its package prevents use of ultraviolet rays after assembly, and X rays are considered too dangerous. Electrical erasing will not be specified because of the possibility that voltage spikes during erasing may destroy the memory devices.

**Lines.** A 256-bit memory has eight X lines, four Y lines, and eight Z lines. For proper circuit operation, transistors are designed so that the mutual conductance of the memory transistors, load transistors, selector transistors, and decoding transistors is in the ratio of 6:1:18:24.

The load transistors get their name because of the resemblance of the circuit configuration to the load transistors often used in MOS gate circuits. Load transistors provide a high-resistance return path for the memory transistor drains to the read line during write. The selector transistors provide a path for readout current during read and block sneak currents during write. When provided with a separate terminal, they provide a method of selecting output from one chip among many.

To program a selected bit, 25 volts is applied to the read line and a selected Y terminal, while 60 v is applied to a selected Z terminal. The terminals are connected to +25 v, with voltage of the selected X terminal lowered to 0 v, if the selected bit is to have a 0 written in. The 25-, 60-, and 0-v pulses should occur simultaneously and be 10 milliseconds or longer for reliable programming while the writing voltages are applied.

**Readout.** To read contents of memory, TTL high output level—about 4.5 v—is applied to the selection terminal and to the selected Z, Y, and X terminals. Output current flows into the X terminal through decoding transistor, memory transistor, selection transistor, and a resistor connected between read terminal and ground. A sense amplifier boosts output across the resistor to drive subsequent gates. This configuration gives a one-bit-at-a-time output for each of 256 words.

## Advertising Sales Staff

**Pierre J. Braudé** [212] 971-3485  
Advertising Sales Manager

**Atlanta, Ga. 30309:** Joseph Lane  
100 Colony Square, 1175 Peachtree St., N.E.  
[404] 892-2868

**Boston, Mass. 02116:** James R. Pierce  
607 Boylston St. [617] 262-1160

**Chicago, Ill. 60611:** Robert W. Bartlett  
Kenneth E. Nicklas, 645 North Michigan  
Avenue, [312] MO 4-5800

**Cleveland, Ohio 44113:** William J. Boyle  
[716] 586-5040

**Dallas, Texas 75201:** Richard P. Poole  
1340 Republic National Bank Building  
[214] RI 7-9721

**Denver, Colo. 80202:** Harry B. Doyle, Jr.  
Tower Bldg., 1700 Broadway  
[303] 266-3863

**Detroit, Michigan 48226:** Robert W. Bartlett  
2600 Penobscot Building  
[313] 962-1793

**Houston, Texas 77002:** Richard P. Poole  
2270 Humble Bldg. [713] CA 4-8381

**Los Angeles, Calif. 90017:** Robert J. Rielly  
Bradley K. Jones, 1125 W. 6th St.,  
[213] HU 2-5450

**Minneapolis, Minn. 55402:** Kenneth E. Nicklas  
1104 Northstar Center [612] 332-7425

**New York, N.Y. 10036**  
330 W. 42nd St.  
Warren H. Gardner [212] 971-3617  
Michael J. Stoller [212] 971-3616

**Philadelphia, Pa. 19103:** Warren H. Gardner  
6 Penn Center Plaza,  
[212] 971-3617

**Pittsburgh, Pa. 15222:** Warren H. Gardner  
4 Gateway Center, [212-971-3617

**Rochester, N.Y. 14534:** William J. Boyle  
9 Greylock Ridge, Pittsford, N.Y.  
[716] 586-5040

**St. Louis, Mo. 63105:** Kenneth E. Nicklas  
The Clayton Tower, 7751 Carondelet Ave.  
[341] PA 5-7285

**San Francisco, Calif. 94111:** Don Farris  
Robert J. Rielly, 425 Battery Street,  
[415] 362-4600

**Paris:** Alain Offergeld  
17 Rue-Georges Bizet, 75 Paris 16, France  
Tel: 720-73-01

**Geneva:** Alain Offergeld  
1 rue du Temple, Geneva, Switzerland  
Tel: 32-35-63

**United Kingdom:** Keith Mantle  
Tel: 01-493-1451, 34 Dover Street, London W1

**Milan:** Robert Sidel, Roberto Laureri  
1 via Baracchini Phone 86-90-656

**Brussels:** Alain Offergeld  
22 Chaussee de Wavre  
Brussels 1040, Belgium  
Tel: 13-65-03

**Stockholm:** Brian Bowes  
Office 17, Kontor-Center AB, Hagagarten 29,  
113 47 Stockholm. Tel: 24 72 00

**Frankfurt/Main:** Fritz Krusebecker  
Liebigstrasse 27c  
Phone 72 01 81

**Tokyo:** Masaru Wakeshima, McGraw-Hill  
Publications Overseas Corporation,  
Kasumigaseki Building 2-5, 3-chome,  
Kasumigaseki, Chiyoda-Ku, Tokyo, Japan  
[581] 9811

**Osaka:** Ryji Kobayashi, McGraw-Hill  
Publications Overseas Corporation, Kondo  
Bldg., 163, Umegae-cho Kita-ku [362] 8771

**Australasia:** Warren E. Ball, IPO Box 5106,  
Tokyo, Japan

## Business Department

**Stephen R. Weiss, Manager**  
[212] 971-2044

**Thomas M. Egan,**  
Production Manager [212] 971-3140

**Carol Gallagher**  
Assistant Production Manager [212] 971-2045

**Dorothy Carter,** Contracts and Billings  
[212] 971-2908

**Frances Vallone,** Reader Service Manager  
[212] 971-6057

## Electronics Buyers' Guide

**George F. Werner,** Associate Publisher  
[212] 971-3139

**Regina Hera,** Directory Manager  
[212] 971-2544

present  
crimp  
method

new  
crimp  
method

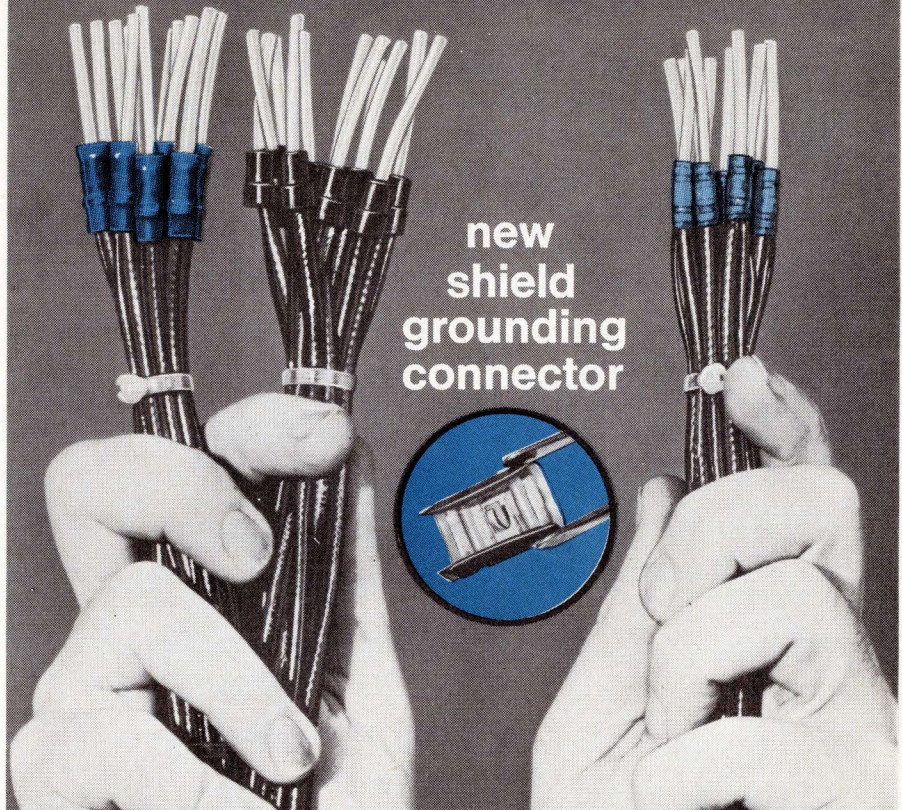

## The most compact Solderless Connector ... and a NEW Lower Installed Cost

New, miniature connector gives you 75 to 90% time saving over present compression technique. Its high reliability factor results from the no-heat requirement as well as complete visibility for inspection of the one-piece connection before, during and after termination.

Only three sizes are needed to handle the range of shielded cables from .055 to .205 over braid dia.

The installing tool features the exclusive Shure-Stake® mechanism which assures that the proper, preset compression will be reached before the tool will release the connector. The Thomas & Betts Company, Elizabeth, New Jersey 07207. In Canada, Thomas & Betts Ltd., P.Q.

### New Shield-Kon® Wrap Around Connector Features

- miniature size, light weight, one piece construction
- lower installed costs
- higher reliability, meets or exceeds the applicable performance requirements of MIL-F-21608.
- mid-span termination capabilities



Division of Thomas & Betts Corporation

Sold Coast-to-Coast  
Through Authorized  
T&B Distributors

# Electronics advertisers

February 28, 1972

<b>ACDC Electronics, Inc.</b> Rose Associates Advertising & Public Relations	17	<b>Electronics</b>	58-59	<b>North American Rockwell, Microelectronics Co.</b> Campbell-Ewald Company	104
<b>Adams &amp; Westlake Co.</b> Scotfield, Hiers & Malone, Inc.	116	<b>Fairchild Semiconductor, Inc.</b> Carson/Roberts, Inc. Adv.	46-47	<b>North Atlantic Industries, Inc.</b> Helme Associates, Inc.	37
<b># AEG Telefunken</b> Werbeagentur	20E	<b>Fairchild Systems Technology</b> Hall Butler Blatherwick, Inc.	27-29	<b># Oscilloquartz SA, Neuchatel</b> M. R. Hofer Werbeagentur BSR/EAAA Bern	12E
<b>Alco Electronic Products, Inc.</b> Marketronics Advertising	D-4	<b>Florists' Transworld Delivery</b> Post-Keyes-Gardner, Inc.	PB-6	<b># Philips Gad Elcoma</b> Tag-Intermarco delaMar	4E
<b>Allen-Bradley Company</b> Hoffman-York, Inc.	60	<b># General Electric Co., Semiconductor Products Department</b> Advertising & Sales Promotion Syracuse Operation	9	<b># Philips N. V. Pit/T &amp; M Division</b> Marsteller International S. A.	24
<b>American Optical Corp., Fiber Optics</b> Fuller & Smith & Ross, Inc.	42	<b>General Radio Co.</b> GRAD Associates	43	<b>PROCOND S.p.A.</b> QUADRAGONO	105
<b>AMP, Inc.</b> Aitkin-Kynett Co., Inc.	53	<b>Georgia Department of Industry &amp; Trade</b> Cargill, Wilson & Acree, Inc.	PB-10	<b>Raytheon Semiconductor</b> Durel Advertising	38-39
<b>Analog Devices, Inc.</b> Kalb & Schneider, Inc.	2,10-11 & 118	<b>Gestetner</b> Savitt Tobias Balk, Inc.	PB-11	<b>RCA Electronic Components</b> Al Paul Letton Company	117
<b># Anritsu Electronic Co. Ltd.</b> Diamond Agency Co. Ltd.	17E	<b># Goerz Electro GmbH</b> Werbemittlung	10E	<b>Rental Electronics, Inc.</b> Technical, Industrial & Scientific Marketing, Inc.	107,110
<b>Applied Materials</b> Hall Butler Blatherwick, Inc.	127	<b>Gudebrod Bros. Silk Co. Electronics Division</b> Coastline Advertising	107	<b>RFL Industries (Instrumentation Div.)</b> Josephson, Cuffari & Company	130
<b>Associated/The Jade Corporation</b> A. D. Adams Advertising, Inc.	121	<b># Heinzinger</b> Technik Marketing	15	<b># Rohde &amp; Schwarz</b>	3E
<b>Astro-Science</b> Farrell-Bergmann Advertising	131	<b>Hermes Electronics Ltd.</b> Public & Industrial Relations Limited	16	<b>Schauer Manufacturing Corp.</b> Nolan, Keelor & Stites	120
<b>Automatic Electric Co., Sub. of General Telephone &amp; Electronics Corp.</b> Marsteller, Inc.	54-55	<b># Hewlett Packard</b> Richardson, Seigle, Rolfs & McCoy, Inc.	1	<b>W. A. Sheaffer Pen Company, A Textron Company</b> Sperry Bomm, Inc.	PB-7
<b>Avantek</b> Fleig & Le Boeuf Advertising, Inc.	22	<b># Hewlett Packard</b> Tallant Yates Advertising, Inc.	20-21	<b>Sheraton-Boston Hotel</b> Needham & Grohmann, Inc.	PB-10
<b>Bell &amp; Howell—Electronics &amp; Instruments Group</b> Coordinated Communications, Inc.	56-57	<b>Hughes Aircraft Company</b> Foote, Cone & Belding	40-41	<b>Sheraton-Park Hotel &amp; Motor Inn</b> Needham & Grohmann, Inc.	PB-12
<b>Bendix, Electro Optics Div.</b> Van Christo Associates, Inc.	123	<b>IEEE '72 International Convention</b> IEEE Advertising Office	106	<b>Singer Company, Kearfoot Div.</b> Gaynor & Ducas, Inc.	112
<b>Business Week Guide</b> Benson & Stagg, Inc.	PB-10	<b>Intel Corporation</b> Bonfield Associates	45	<b>Soliton Devices, Inc., Transistor Division</b> Haseimire Pearson Advertising, Inc.	93
<b># Cambridge Thermionic Corporation</b> Chirurg & Cairns, Inc.	D-4	<b># 1972 International Conference on Thin Films</b>	15E	<b>Sonoco Products Company</b> Cargill, Wilson & Acree, Inc.	PB-3
<b># CELCO (Constantine Engineering Laboratory Co.)</b> Stano Advertising	132	<b>Krohn-Hite Corporation</b> Impact Advertising, Inc.	5	<b># Sorensen Operation Raytheon Company</b> Provandie Eastwood & Lombardi, Inc.	23
<b># Constantine Engineering Laboratory Co. (CELCO)</b> Stano Advertising	132	<b>Ledex, Inc.</b> Mervar Advertising	124	<b>Sprague Electric Company</b> Harry P. Bridge Company	8
<b>Centralab, Div. of Globe Union, Inc.</b> The Brady Co.	114-115	<b>Litronix, Inc.</b> Regis McKenna, Inc.	97	<b># Systron Donner Concord Instruments</b> Bonfield Associates	99
<b>Combustion Engineering, Inc.</b> Coordinated Communications, Inc.	PB-9	<b>Lockheed Electronics Company</b> McCann-Erickson, Inc.	50	<b># Teledyne Philbrick</b> Ingalls Associates, Inc. Advertising	83
<b>The Connecticut Hard Rubber Company</b> Cohar Associates	100	<b># LTT</b> Publibel	19E	<b>Thomas &amp; Betts Company</b> McCarthy, Scelba, DeBiasi Advertising Agency, Inc.	D-1
<b>Dale Electronics, Inc., A Sub. of The Lionel Corporation</b> Swanson, Sinky, Ellis, Inc. Advertising	4th cover	<b>Lyon Metal Products</b> Reincke, Meyer & Finn Advertising	PB-15	<b># TRW, Electronic Components Division</b> The Bowes Company	101
<b>Dana Laboratories, Inc.</b> Image Advertising and Public Relations	D-3	<b>Medical World News</b> Friedrich Fearon & Strohmeier	129	<b>Unicom Systems, Inc.</b> Stanbro, Smallwood & Drummond Advertising, Inc.	PB-13
<b>Datacraft Corporation</b> Advertising Art Services	94	<b>Mercedes-Benz of North America, Inc.</b> Ogilvy & Mather, Inc.	PB-7	<b># Unirode Corporation</b> Impact Advertising	35
<b>Delco Electronics Division General Motors Corp.</b> Campbell-Ewald Company	78-79	<b>Microsystems International Ltd.</b> Media Advertising Ltd.	108	<b>USCC/CENTRALAB (Division of Globe Union)</b> Brown Clark Elkus & Moses, Inc.	121,123
<b># Digital Equipment Corporation</b> Kalb & Schneider, Inc.	48-49	<b># Miller Stephenson Chemical Co., Inc.</b> A. B. W. Tolt and Co.	13E	<b># Wang Laboratories, Inc.</b> WLI Associates Advertising	PB-5
<b>Dumont Oscilloscope Laboratories, Inc.</b> Barbetta Miller Advertising, Inc.	6	<b>MOS Technology, Inc.</b> Henry S. Goodsett Advertising, Inc.	2nd Cover	<b># Wayne Kerr Co. Ltd.</b> Dennis & Garland Ltd.	9E
<b># Duncan Electronics, Inc., Sub. of Systron Donner Corp.</b> Enyart & Ross Advertising, Inc.	D-4	<b>Mostek Corporation</b> Continental Communications Incorporated	30	<b>Westinghouse Semiconductor</b> Ketchum, MacLeod & Grove, Inc.	18-19
<b>DuPont de Nemours &amp; Company, Freon Division</b> N. W. Ayer & Son, Inc.	15	<b>Motorola Semiconductor Products, Inc.</b> E. B. Lane & Associates, Inc.	12-13	<b>Woven Electronics</b> Prentiss Court	110
<b># Electronic Navigation Industries</b> Hart Conway Co., Inc.	14	<b># National Semiconductor Corp.</b> Chiat/Day, Inc. Advertising	7		
		<b>NJE Corp.</b> Ophlode Advertising	24		
		<b>Nortec Electronics Corporation</b> Paul Pease Advertising	3rd cover		

## Classified & Employment Advertising

F. J. Eberle, Manager 212-971-2557

<b>EQUIPMENT (Used or Surplus New) For Sale</b>	
Do Vibiss Co. ....	128
North Electric Co. ....	128
Radio Research Instruments Co. ....	128

# For more information on complete product line see advertisement in the latest Electronics Buyer's Guide  
# Advertisers in Electronics International

# DANA

5 DC RANGES

COMPLETE AUTORANGING

ANALOG OUTPUT

1  $\mu$ V RESOLUTION

.005% DC ACCURACY

only \$1295



... for Dana's **5300** ... A five digit, premium quality, high performance DVM ... Take a look ... You get a standard instrument featuring 5-DC Ranges (1-1000V) with 1  $\mu$ V resolution; .005% DC accuracy, complete auto-ranging; 74 dB noise rejection at 60Hz; analog output; and 10,000 megohm input resistance. But that's not all ... by using field expandable plug-in options you can extend the capability of the **5300**. Add 6 ranges of 4-terminal ohms with 1m $\Omega$  resolution; 4 ranges of AC (1-1000V) with 10  $\mu$ V resolution over a broad band from 30 Hz to 250 kHz; 5 ranges of bipolar 4-wire DC/DC ratio; isolated remote programming and BCD output; 100 readings per second (fully programmable) ... There is much more to the **5300** than we can possibly tell you here ... so let us show you.

You have the budget and the decision, Dana has the Digital Voltmeters.

**DANA**

DIGITAL VOLTMETERS

Dana Laboratories, Inc.  
2401 Campus Drive, Irvine  
California 92664 (714) 833-1234

*When Test and Measurement Count*

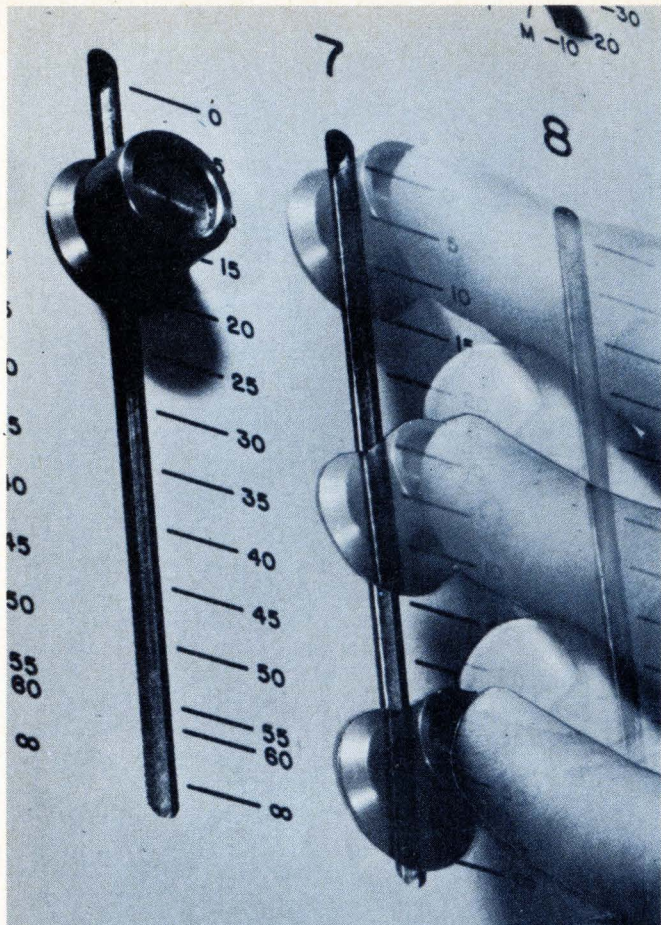

# Slide Actuated Pots

Duncan Electronics 2 3/4" linear travel slide actuated potentiometer combines infinite resolution with long life — and at low cost. The series 200 design features "touch-sensitivity," enabling the operator to feel the action without disturbing the smoothness of motion. They are used widely in audio control consoles for the recording and broadcast industries, commercial sound systems and (with SCRs) as "dimmers" in lighting controls. Key features include: single or dual resistance elements, linear or audio tapers, standard tap positions, all-metal housing. Write for new free catalog!

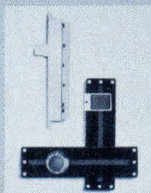

**DUNCAN ELECTRONICS**  
SUBSIDIARY

**SYSTRON**  **DONNER**

2865 FAIRVIEW ROAD □ COSTA MESA, CALIFORNIA 92626  
PHONE: (714) 545-8261 □ TWX 910-595-1128

D4 Circle 142 on reader service card

## A CAMBION® Double "QQ" Product Line

When your design calls for handles, standoffs, solder terminals, spacers, insulated terminals, battery holders, and basic hardware, it's nice to know there's a source that believes in quality — CAMBION. And it's also nice to know that you can get CAMBION quality in quantity. That's the CAMBION Double "Q" approach.

CAMBION puts the extra finish on handles, precise plating on significant surfaces of terminals, and long-life in plugs and jacks for almost infinite cycling. The quality stands up as the quantity goes on. All CAMBION hardware items are available "off-the-shelf."

Try the CAMBION Double "Q" approach. Tell us of your needs and we'll supply a jumbo catalog, No. 747, full of answers. Cambridge Thermionic Corporation, 445 Concord Avenue, Cambridge, Mass. 02138. In Los Angeles, 8703 La Tijera Blvd.

## There's plenty more where these come from.



Circle 152 on reader service card

## PUSH BUTTON MINIATURES

Exceptionally high current. 6A @ 125 VAC. Snap-action with fast make and break contacts. SPDT, DPDT & 4PDT, usable as either Norm. Open or Norm. Closed switch. Silver contacts & terminals.

Push-ON, Push-OFF

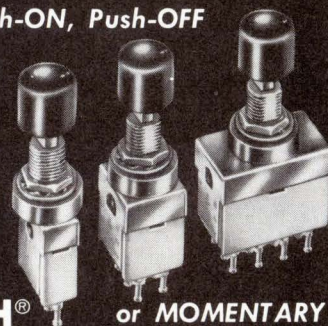

**ALCOSWITCH®** or **MOMENTARY**  
DIV. OF ALCO ELECTRONIC PRODUCTS, INC., LAWRENCE, MASS.

Circle 153 on reader service card

## DESIGN YOUR OWN KEYBOARD

A reliable reed switch is actuated by a permanent magnet. Close tolerance is maintained in operating pressure and operating points. Wide variety of 2-shot molded keytops allows you to design your own!



Send for complete listing.

**ALCOSWITCH®**  
DIV. OF ALCO ELECTRONIC PRODUCTS, INC. NORTH ANDOVER, MASS. 01845

Circle 154 on reader service card