

January 17, 1972

\$1.00 A McGraw-Hill Publication

For safety's sake, radar takes to the highway 54

Enhancing computer systems with cache memories 58

How to get the most out of trimmer specs 79

RECEIVED

FEB 23 1972

LIBRARY

Electronics®

**A treat
for designers
dollar-a-digit
LED displays**



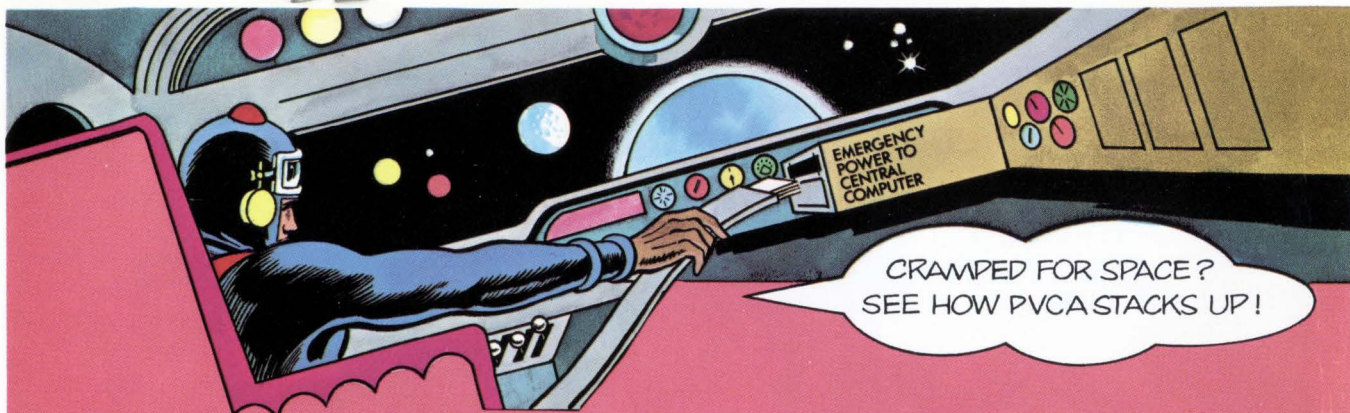

Brand-Rex introduces PVCA cable; a new concept in flat power distribution systems.

If you're trying to cram more power distribution cable into an enclosure than there's room for, Brand-Rex can help. We've got a packaging idea that's as modern as tomorrow. New PVCA™ cable. A flat, vinyl insulated aluminum strip that can be stacked, run in trays and ducts, bent at any angle for branching or to follow any contour.

PVCA™ cable is U.L. recognized for 105°C, 100 volt operation. It passes the U.L. vertical flame test and is resistant to oil and grease.

No termination problems either. Standard terminals, including center tap are readily available for fast, economical, airtight, moisture-resistant connections and splices.

Cost? Less than the conventional cable it replaces.

See for yourself how the new PVCA™ cable stacks up. For the free Fact File write to Buck Rogers, Brand-Rex Co., Willimantic, Conn. 06226. Or call (203) 423-7771.

BRAND-REX...WAY AHEAD IN WIRE AND CABLE

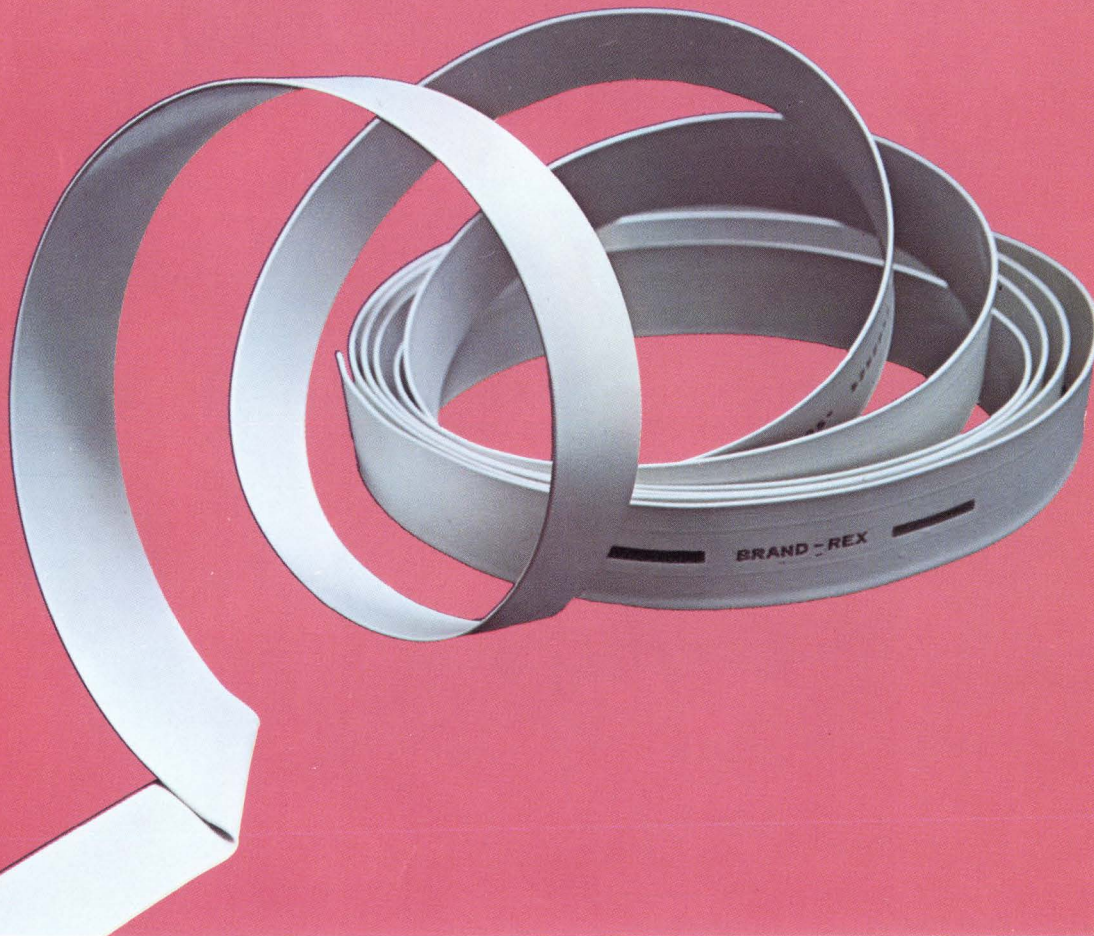

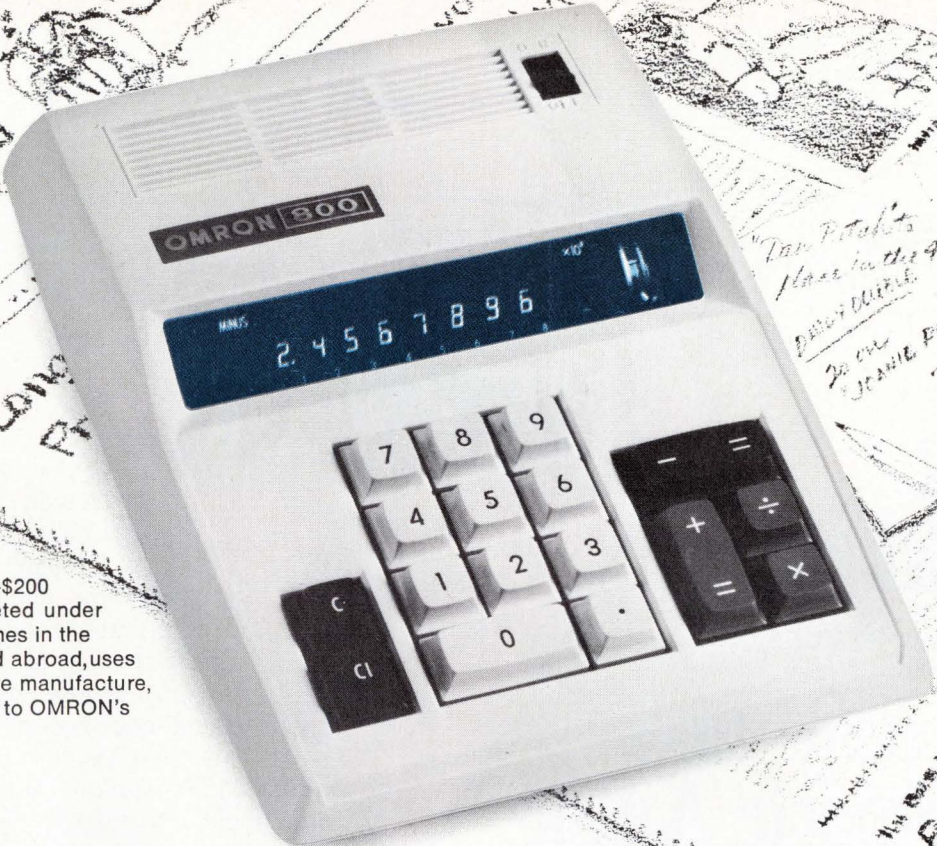

OMRON's under-\$200 calculator, marketed under various trade names in the United States and abroad, uses an MOS device we manufacture, package and test to OMRON's specifications.

“We knew that \$400 calculators could sell for under \$200 with MOS/LSI circuits. NORTEC helped us break that price barrier.”
Dr. Bernard Jacobs, President,
OMRON Systems, Inc. Mountain View, Ca.

NORTEC Electronics is in business to make winners of our customers. We're designing and building parts for bill changers, computers, entertainment consoles, panel meters, and communications blackboxes. The only way we'll make it big in MOS/LSI is by helping our customers make it big. Try us for design, prototypes, or production. Send in the bingo card or call (408) 732-2204.

NORTEC MOS AT WORK.



3697 Tahoe Way, Santa Clara, Ca. 95051 • Tel. (408) 732-2204 • Telex 348-359

OUR ANGLE: High Speed Accurate and Automatic Angle Position Indicators

WHAT'S YOUR ANGLE?



MODEL 545/100

If you're converting synchro/resolver data to digital format, you need both speed *and* accuracy to keep pace with today's data explosion. Only one converter meets both these requirements without compromise. And for under \$4K. . . . North Atlantic's Model 545/100.

The solid-state Model 545/100 converts both resolver and synchro data with 0.01° accuracy and resolution. And continuously digitizes input angle data at $20,000^\circ$ per second in the face of real-life noise, harmonics and quadrature levels. BCD output is available at the rear connector. Conversion can be stopped by a data freeze command. If multiplexed signals are your bag, acquisition time is less than 30 ms.

Options? Other models offer many options, including 0.001° resolution with 10 arc-second accuracy; data frequencies from 60Hz to 2.4kHz, binary output, small size.

No matter what your conversion problem, if you require ultra-fast, ultra-accurate tracking, contact your North Atlantic sales engineering representative today. He'll show you a better angle.

NA

NORTH ATLANTIC
industries, inc.

200 TERMINAL DRIVE, PLAINVIEW, NEW YORK 11803
cable: noatlantic / twx: 510-221-1879 / phone: (516) 681-8600

29 Electronics Review

CONSUMER ELECTRONICS: C/MOS watch kit aims at potential \$50 million market, 29
COMPONENTS: Monolithic crystal filter in production, 29
COMMUNICATIONS: Combiner gives Navy low-cost satellite terminal, 30
COMMERCIAL ELECTRONICS: H-P introduces \$395 electronic slide rule, 31
DISPLAYS: Deformable film offers storage, display capability, 32
MEDICAL ELECTRONICS: Defibrillator works automatically, 34; Area self-scanner for blind, 34
SPACE ELECTRONICS: Shuttle means \$600 million for avionics competitors, 36
AIR TRAFFIC CONTROL: FAA ready to award training simulator contract, 36
COMPUTERS: Radar, minicomputer tell when to turn on snow, 38
FOR THE RECORD: 38

53 Technical Articles

CONSUMER: Radar hits road, but it's a costly ride, 54
COMPUTERS: How a cache memory enhances a computer's performance, 58
INSTRUMENTATION: Strobed LED display breaks the design cost barrier, 64
CIRCUIT DESIGN: Designer's casebook, 68
COMMUNICATIONS: Solid state design amplifies vhf to kilowatt level, 72
CIRCUIT DESIGN: Diode switching matrices make a comeback, 76
COMPONENTS: Trimmers take a turn for the better, 79

87 Probing the News

COMMUNICATIONS: Scrambled data baffles thieves, 87
COMMUNICATIONS: FET low-noise R&D heats up, 90
GOVERNMENT ELECTRONICS: The computerized drugstore, 92
COMMERCIAL ELECTRONICS: Voiceprints gain a hearing, 94

99 New Products

IN THE SPOTLIGHT: Multimeter has LED display built into probe, 99; Stripline hybrid puts out 15 W, 101
COMPONENTS: Converters offer speed, accuracy, 103
SUBASSEMBLIES: Plug-in extends oscillator range, 107
DATA HANDLING: Intelligent terminal has low price, 109
SEMICONDUCTORS: IC aimed at consumer applications, 111
MATERIALS: 114

119 Electronics International

GREAT BRITAIN: Fuel injection system uses read-only memory, 119
SWEDEN: Heat-scanning microscope checks ICs under load, 119
JAPAN: Planar Schottky diodes for quasi-millimeter-wave gear, 120
FRANCE: RTC jumps into miniradar market, 121
WEST GERMANY: Transmission system displays accurate time on TV sets, 121

Departments

Publisher's letter, 4
Readers comment, 6
People, 14
40 years ago, 21
Meetings, 22
Electronics Newsletter, 25
Washington Newsletter, 43
Washington Commentary, 44
New Literature, 114
International Newsletter, 117

Title R registered U.S. Patent Office; Copyright 1972 McGraw-Hill Inc.
All rights reserved, including the right to reproduce the contents of this publication in whole or part.
Volume No. 45, Number 2

Electronics

EDITOR-IN-CHIEF: Kemp Anderson

EXECUTIVE EDITOR: Samuel Weber

MANAGING EDITORS: Lawrence Curran, *News*;
Arthur Erikson, *International*

SENIOR EDITORS: John Johnsrud,
H. Thomas Maguire, Stephen E. Scrupski

ART DIRECTOR: Fred Sklenar

ASSOCIATE EDITORS: Richard Gundlach,
John N. Kessler, Howard Wolff

DEPARTMENT EDITORS

Aerospace: William F. Arnold
Circuit Design: Lucinda Mattered
Communications & Microwave:

Lyman J. Hardeman
Computers: Wallace B. Riley
Consumer: Gerald M. Walker
Industrial: Alfred Rosenblatt
Instrumentation: Michael J. Riezenman
Military: Ray Connolly
New Products: H. Thomas Maguire
Packaging & Production:

Stephen E. Scrupski
Solid State: Laurence Altman
Special Issues: Harry R. Karp

COPY EDITORS: Margaret Eastman,
Everett C. Terry

ART: Charles D. Ciatto, *Associate Director*

PRODUCTION EDITORS:
Patricia Cybulski, Arthur C. Miller

EDITORIAL ASSISTANT: Marilyn Offenheiser

EDITORIAL SECRETARIES: Vickie Green,
Joyce Kamerer

FIELD EDITORS

Boston: James Brinton (Mgr.), Gail Farrell
Dallas: Paul Franson (Mgr.)
Los Angeles: Lawrence Curran (Mgr.)
New York: Alfred Rosenblatt (Mgr.)
San Francisco: Stephen Wm. Fields (Mgr.),
Roberta Schwartz
Washington: Ray Connolly (Mgr.),
Larry Armstrong, William F. Arnold
Frankfurt: John Gosch
London: Michael Payne
Paris: Arthur Erikson
Tokyo: Charles Cohen

McGRAW-HILL WORLD NEWS

Director: Walter A. Stanbury; *Atlanta*: Stan Fisher; *Chicago*: Mike Sheldrick; *Cleveland*: Arthur Zimmerman; *Detroit*: James Wargo; *Houston*: Robert E. Lee; *Los Angeles*: Michael Murphy; *Gerald Parkinson*; *San Francisco*: Margaret Drossel; *Seattle*: Ray Bloomberg; *Washington*: James Canan, Herbert W. Cheshire, Seth Payne, Warren Burkett, William D. Hickman; *Bonn*: Robert Ingersoll; *Brussels*: James Smith; *London*: Marvin Petal; *Milan*: Peter Hoffmann, Andrew Heath; *Moscow*: Axel Krause; *Paris*: Stewart Toy, Michael Johnson; *Stockholm*: Robert Skole; *Tokyo*: Mike Mealey

PUBLISHER: Dan McMillan

ADVERTISING SALES MANAGER: Pierre J. Braudé

ADVERTISING SALES SERVICE MANAGER:
Wallis Clarke

BUSINESS MANAGER: Stephen R. Weiss

CIRCULATION MANAGER: George F. Werner

RESEARCH MANAGER: David Strassler

MARKETING SERVICES MANAGER:
Tomlinson Howland

Publisher's letter

Our Washington coverage, as you'd expect, is heavy on political, military, and aerospace developments. But as the Government shifts its priorities, there are more good stories than ever coming out of Washington about the civilian use of advanced electronic techniques. This issue, our Washington bureau covers two of these developments—voiceprints and the computerized drugstore.

Voiceprints last week made national headlines when Howard Hughes broke his years of silence to deny he had written an autobiography. The tapes of his phone news conference and of a speech he gave before he went into seclusion over a decade ago were compared by voice-print analysis and found by experts to be virtually identical. That set at rest rumors that it was not Hughes on the phone. For the full story on voiceprints' progress down the rocky road to acceptance, both technically and legally, see our Probing the News (page 94) by Larry Armstrong.

Then there's the less sensational, but equally significant, story about lashing together the nation's drugstores into a network of prescription and drug data centers, with eventual connection to hospitals, doctors, and government agencies (see Probing the News, page 92).

Bill Arnold, who recently rejoined *Electronics*, first came across the story while he was working for a Washington-based drug newsletter. Bill, both intrigued by the electronics angle of the story and knowing the extent of the interest generated by the network in drug industry circles, has put together a well bal-

anced assessment of the future of the system.

Bill first joined *Electronics*' Washington bureau in June 1967 after a year with McGraw-Hill World News and, before that, jobs with two San Francisco area suburban dailies and the Newark Evening News. He has his BA and MA in political science from Berkeley.

As design engineers well know, the problems of circuit development devices like integrated circuits. There's still a big role for prosaic components like the redoubtable trimmer. And although trimmers have been around for quite awhile, there has still been a steady improvement in trimmer performance and cost that make it virtually irreplaceable.

What's behind these improvements, and what it means to the circuit designer is the subject of a special feature article that starts on page 79. Putting the report together was Harry Karp, our Special Issues Editor, with some inputs supplied by *Electronics*' news bureaus.

To gather information, Harry took several swings around the country to visit trimmer makers, and found out, among other things, why the trimmer is still holding its own in this age of large scale integration. And he's put together some useful data on trimmers that will help designers select the right trimmer for any application, as well as use them to their full potential.



January 17, 1972 Volume 45, Number 2
89,767 copies of this issue printed

Published every other Monday by McGraw-Hill, Inc. Founder: James H. McGraw 1860-1948. Publication office 330 West 42nd Street, N.Y., N.Y. 10036; second class postage paid at New York, N.Y. and additional mailing offices.

Executive, editorial, circulation and advertising addresses: *Electronics*, McGraw-Hill Building, 330 West 42nd Street, New York, N.Y. 10036; Telephone (212) 971-3333; Teletype TWX N.Y. 710-581-4235. Cable address: MCGRAW HILL N.Y.

Subscriptions limited to persons with active, professional, functional responsibility in electronics technology. Publisher reserves the right to reject non-qualified requests. No subscriptions accepted without complete identification of subscriber name, title, or job function, company or organization, including product manufactured or services performed. Subscription rates: qualified subscribers in the United States and possessions and Canada, \$8.00 one year; \$12.00 two years; \$16.00 three years; all other countries \$25.00 one year except Japan \$50.00 per year including air freight. Limited quota of subscriptions available at higher-than-basic rate for persons outside of field served, as follows: U.S. and possessions and Canada, \$25.00 one year; all other countries \$50.00. Single copies: United States and possessions and Canada, \$1.00; all other countries, \$1.75.

Officers of the McGraw-Hill Publications Company: John R. Emery, President; J. Elton Tuohy, Senior Vice President—Services; Donald B. Gridley, Group Vice President; Vice Presidents: Ralph Blackburn, Circulation; John R. Callahan, Editorial; David G. Jensen, Manufacturing; Jerome D. Luntz, Planning & Development; Joseph C. Page, Marketing; Robert M. Wilhelmy, Finance.

Officers of the Corporation: Shelton Fisher, President; Joseph H. Allen, President Publications and Business Services Group; John J. Cooke, Senior Vice President and Secretary; Ralph J. Webb, Treasurer. Title registered in U.S. Patent Office; Copyright 1972 by McGraw-Hill, Inc. All rights reserved. The contents of this publication may not be reproduced either in whole or in part without the consent of copyright owner.

Subscribers: The publisher, upon written request to our New York office from any subscriber, agrees to refund that part of the subscription price applying to copies not yet mailed. Please send change of address notices or complaints to Fulfillment Manager; subscription orders to Circulation Manager, *Electronics*, at address below. Change of address notices should provide old as well as new address, including postal zip code number. If possible, attach address label from recent issue. Allow one month for change to become effective.

Postmaster: Please send form 3579 to Fulfillment Manager, *Electronics*, P.O. Box 430, Hightstown, N.J. 08520.

CURRENT STABILIZED POWER

from **KEPCO**

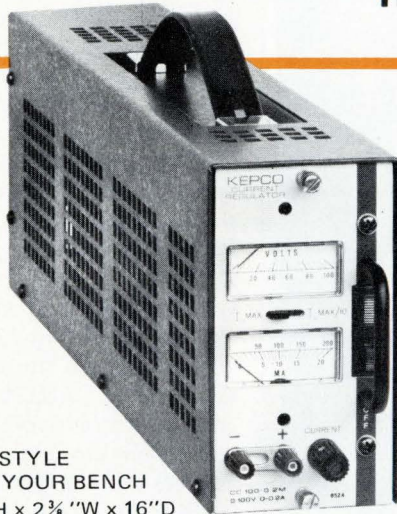

LAB STYLE
FOR YOUR BENCH
5 1/4" H x 2 3/4" W x 16" D

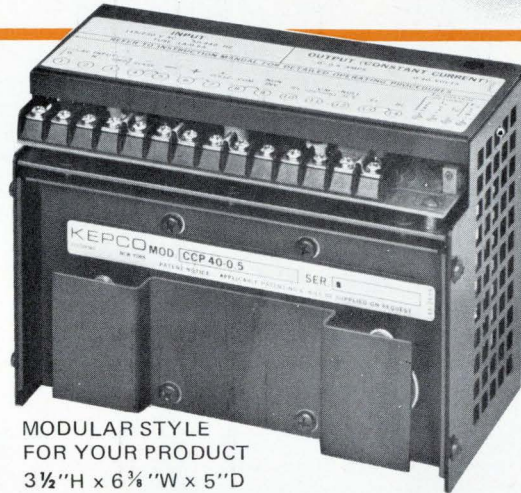

MODULAR STYLE
FOR YOUR PRODUCT
3 1/2" H x 6 3/4" W x 5" D

The Kepco CC design provides a precision current controller in a convenient plug-in bench style. Housings are available to mount one, two or three units side-by-side or six units abreast in a standard 19-inch rack. The CC Power Supplies feature built-in dual range, 10-turn current control (0.05% resolution), plus isolated voltage and current metering.

The Kepco CCP Series offers an OEM the same selection of current stabilizing power supplies in a compact modular format suited for remote control. A 0-1000 ohm rheostat controls current through the full range and a built-in (optional) voltage repeater will run your meters without loading the output. CCP modules feature a built-in, adjustable voltage limiter.

In either style, the Kepco current stabilizers offer extraordinary performance:

Source effect (line regulation):	0.0005% or 0.2 μ A.
Load effect (load regulation):	0.005% or 2 μ A.
Temperature effect coefficient:	0.01% per $^{\circ}$ C.
Ripple (Continuous or Random Unprogrammed Deviation):	0.02% I_o max.

The heart of each power supply is a monolithic I-C comparator to insure high stability, even in an adverse thermal environment. A unique feature is a fast-recovery, capacitorless output circuit that allows current to recover from a load (voltage) change up to 2 μ sec. per volt.

OUTPUT		BENCH MODEL*	PRICE	OEM MODULE	PRICE
AMPS	VOLTS				
0-2A	0-7V	CC 7-2M	\$209.00	CCP 7-2	\$150.00
0-1.5A	0-15V	CC 15-1.5M	209.00	CCP 15-1.5	150.00
0-1A	0-21V	CC 21-1M	209.00	CCP 21-1	150.00
0-0.5A	0-40V	CC 40-0.5M	209.00	CCP 40-0.5	150.00
0-0.3A	0-72V	CC 72-0.3M	209.00	CCP 72-0.3	150.00
0-0.2A	0-100V	CC 100-0.2M	209.00	CCP 100-0.2	150.00

*Single unit case, Model CA-3: \$22.00

ALL KEPCO POWER SUPPLIES CARRY A FIVE-YEAR WARRANTY

For complete specifications and applications notes — write Dept. DX-14

KEPCO®

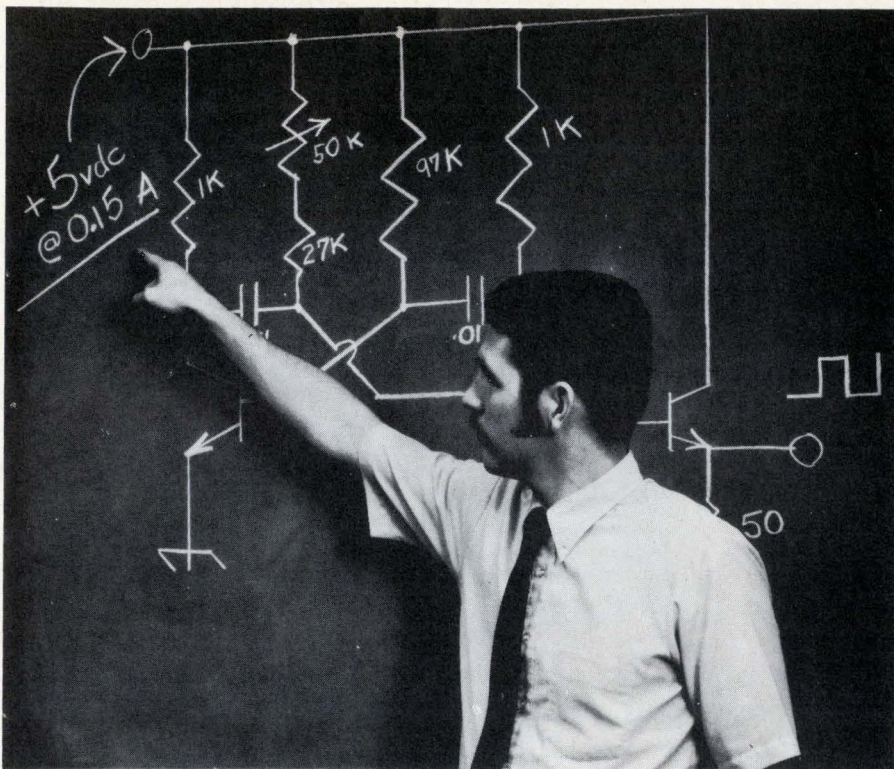

How to Design Your Power Supply for \$83

You get the **complete schematic diagram, and parts list** with operating and installation instructions when you spend \$83 for an Abbott Model "R" power supply. Two years in development, this model represents the latest state of the art in power module design. It features close regulation ($\pm 0.05\%$), low ripple (0.02%), automatic short circuit and complimentary overvoltage protection and continuous operation in a 160°F ambient.

Abbott Engineers followed specific design criteria in engineering these modules. First, the electrical design was carefully engineered to insure that all components operate well within their limits, under "worst case" operating conditions. Second, the thermal design, including case construction, was carefully made to insure that the maximum temperature limits of all components are never exceeded. Then the size and weight of these modules were controlled to a minimum, without sacrificing reliability. Finally these units were thoroughly tested to make certain that all design and performance specifications were met.

So, you can build your own power supply using our schematic diagram if you want to—but we think we can build it more

reliably and for less cost, simply because we have been doing it for ten years. Put our power supply in your system first and try it. Examine its performance. We think you will be pleasantly surprised at the quality, adherence to specifications, and the reliability you find in the Abbott Model "R".

Any output voltage from 5 to 100 volts DC with current from 0.15 to 20 amperes is available. **Many of the popular voltages are carried in stock for immediate delivery.** Please call us for attractive O.E.M. discount prices.

Abbott also manufactures 3,000 other models of power supplies with output voltages from 5.0 to 3,650 volts DC and with output currents from 2 milliamperes to 20 amperes. They are all listed **with prices** in the new Abbott catalog with various inputs:

- 60 A to DC, Hermetically Sealed
- 400 A to DC, Regulated
- 28 VDC to DC, Regulated
- 28 VDC to 400 A, 1 ϕ or 3 ϕ
- 24 VDC to 60 A, 1 ϕ

Please see pages 618 to 632 of your 1971-72 EEM (ELECTRONIC ENGINEERS MASTER Catalog) for complete information on Abbott modules.

Send for our new 56 page FREE catalog.

abbott transistor

LABORATORIES, INCORPORATED

5200 W. Jefferson Blvd./Los Angeles 90016
(213) 936-8185 Cable ABTLABS

1224 Anderson Ave./Fort Lee, N.J. 07024
(201) 224-6900

Readers comment

More about Project MAC

To the Editor: Having been involved with Project MAC from its inception, I was dismayed by a paragraph in your article, "Wanted for the '70s: easier-to-program computers" (Sept. 13, 1971, p. 68). Project MAC is not a time-sharing system but a group of faculty, students and staff doing computer science research. There have been three, not just one, significant time-sharing systems developed within the framework of Project MAC.

There is an implication in the statement attributed to an anonymous observer that the extended development period of the Multics system has not been worth it. But this is not a representative view. Today Multics is not only the most widely used computer system at MIT but contains several research advances which will allow more controllable and effective computer utilities to be set up in the future.

Finally, you mistakenly associate me with the MIT Computation Center, an organization which ceased to exist four years ago.

F. J. Corbató

Professor of electrical engineering
Massachusetts Institute
of Technology
Cambridge, Mass.

■ *Originally, MAC was an acronym for Multiple-Access Computer, which is synonymous with time-shared computer. The other referent, Machine-Aided Cognition, did not appear till about a year later.*

Meta, too

To the Editor: In commenting on the Univac 9700 (November 22, 1971, p. 32), you say: "Only one other company presently makes computers with emulation—Standard Computer Corp., of Santa Ana, Calif. Its IC-7000 [can] emulate any other computer, but has no identity of its own."

Digital Scientific's META 4 computer system was first shipped in July 1970, with complete and absolute emulation of IBM's 1130. It was the first, and is yet today, the only emulation that is completely transparent to the target machine's software, i.e. no conversion need be

The General Electric Glass Menagerie

For decades, General Electric has explored the possibilities of glass as it relates to industry's engineers and designers.

Would you like to know what we've learned? What we can make? We'll be pleased to inform you with a captivating new folder now in preparation.

You'll read how vast quantities of glass parts are supplied to meet needs in the Electronic Industry. Where miniature bulb blanks in over one hundred shapes and sizes and many colors of glass beads for sealing to Dumet wire, are manufactured by the millions. How electronic glass is made available for electronic tubes and television picture tube necks. Where tubing is supplied in both long length and cut pieces to meet the exacting requirements of the Electronic Industry.

How we press borosilicate glass into shapes weighing from less than an ounce to as much as ten pounds. How we press parts with dimensional accuracy so that in many instances the cost of grinding or polishing is eliminated.

Though countless standard glass products from lime or low lead or high lead glass are manufactured we also make something special, whenever anyone needs it, such as a high X-ray absorption glass.

For interesting reading, and spectacular photography, just ask us to send you a copy of **Glass in the Twentieth Century**. Available soon. Write: Lamp Glass Department, General Electric Company, 24400 Highland Road, Richmond Heights, Ohio 44143.



GENERAL  ELECTRIC

Circle 7 on reader service card

New! ONE Relay that compacts 21,600 switch points with modular ease... at \$1 per pole!*

Meet the T-BAR® "PLUGGABLE"®

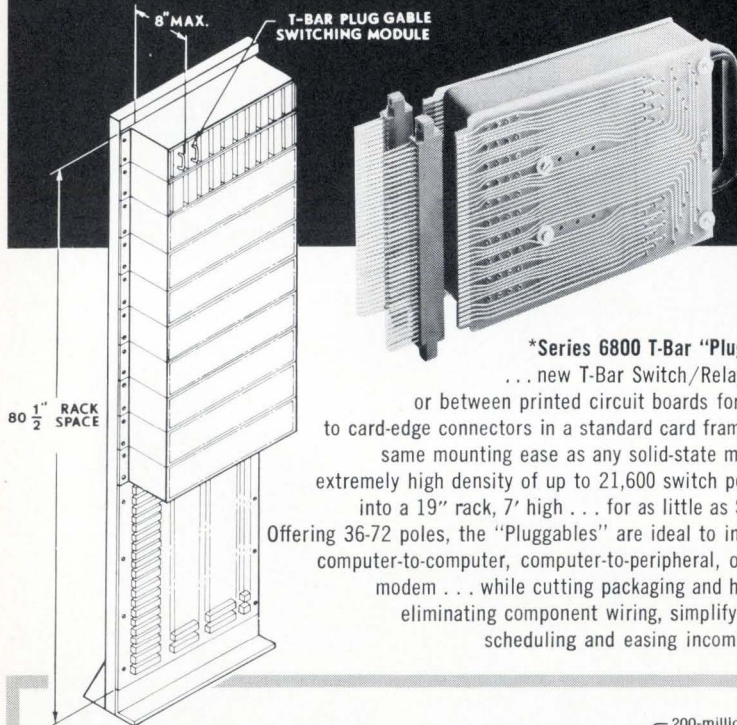

*Series 6800 T-Bar "Pluggable" Relays
... new T-Bar Switch/Relays mounted on or between printed circuit boards for **direct plug-in** to card-edge connectors in a standard card frame ... with the same mounting ease as any solid-state module ... with extremely high density of up to 21,600 switch points packaged into a 19" rack, 7" high ... for as little as \$1.00 per pole. Offering 36-72 poles, the "Pluggables" are ideal to interface switch computer-to-computer, computer-to-peripheral, or computer-to-modem ... while cutting packaging and hardware costs, eliminating component wiring, simplifying component scheduling and easing incoming inspection.

Features new Data-Rite™ T-Bars with unique EDGE-TO-DOME™ Bifurcated Contacts ...

Wipes in two directions across a dome shaped contact that is as effective as a SOLID GOLD Contact Set.

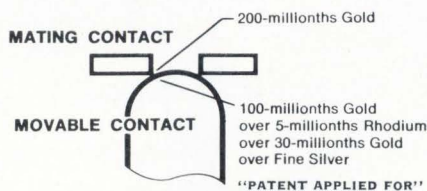

Want more facts on the "Pluggables"?
Write or phone today for complete literature and prices on 6800 Series and other T-Bars ...

T-Bar
INCORPORATED
SWITCHING TECHNOLOGY

141 Danbury Road, Wilton, CT 06897
phone: 203/762-8351

Readers comment

made in order to run the target software on the META 4.

Warren Harris
Digital Scientific Corp.
San Diego, Calif.

Burden of proof

To the Editor: B. Stopka's circuit in "Shorted load folds back supply current" [*Electronics*, June 21, 1971, p. 65] doesn't work as the article says. Here's why!

Turn on of the current limit translator is caused initially by the voltage drop across R_1 , bringing the output into current limit. As the output drops below the point where additional on bias is supplied by D_{1A} through D_1 and R_3 , the output current starts slowly decreasing. Eventually, the output current of Q_2 will no longer be dominant in biasing Q_1 on, and the output current will then really fold back.

For the output to fold back as shown, the drive supplied to Q_1 must increase more rapidly than the decrease through R_1 after current limit has been reached. Since all components shown are linear devices, this cannot happen. The output characteristic can be shown on an X-Y oscilloscope by slowly sweeping the supply into short circuit. The curve will look as below.

D. S. Belanger
Semiconductor Circuits Inc.
Haverhill, Mass.

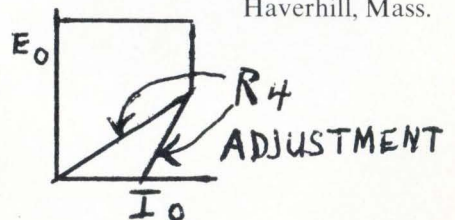

■ *Mr. Stopka replies:* A minor error in the published schematic makes it refer only to the situation described in the article's last paragraph. To reflect the bulk of the write-up, the anode of diode D_1 should be connected to V_{ref} . So there may be no real disagreement with Mr. Belanger, whose curve looks similar to the one printed, except that its breakpoint (point 2 in the article) occurs at a much lower voltage. With a very low V_{out} —2.5 to 3 volts—his curve can be simulated, because the breakpoint always occurs at approximately 2.25 v below nominal V_{out} .

POWERTEC'S THE NAME WINNING'S THE GAME

4 NEW DC POWER SUPPLIES

ALL MODELS DELIVERABLE FROM STOCK IN 24 HOURS

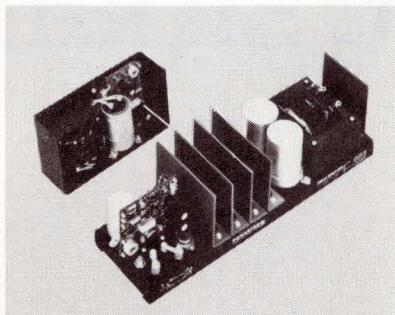

OEM Power Supplies

Model Number	*(5)		*(15)		*(24)			Unit Price
	5V	6V	12V	15V	18V	20V	24V	
2B(*)	3A	2.5A	1.5A	1.3A	1.0A	1.0A	1.0A	\$ 24.95
2C(*)	6A	5A	3.0A	2.8A	2.0A	2.3A	2.3A	\$ 44.00
2D(*)	12A	10A	6.5A	6.0A	4.5A	5.0A	5.0A	\$ 75.90
2E(*)	25A	23A	15A	14A	10A	12A	11A	\$129.00
2F(*)	50A	46A	30A	28A	20A	24A	22A	\$219.00
2G(*)	75A	68A	45A	42A	30A	36A	33A	\$299.00

Specifications REGULATION: Line $\pm 0.5\%$; Load $\pm 0.5\%$; INPUT: 115 VAC $\pm 10V$ 47-63 Hz; RIPPLE: 1 mV RMS (5 & 15V), 3 mV RMS (24V); O.L. PROTECTION: current limit foldback; RESPONSE: 50 usec typical; TEMPERATURE: 0°C to 40°C derated to 71°C; OVP: optional

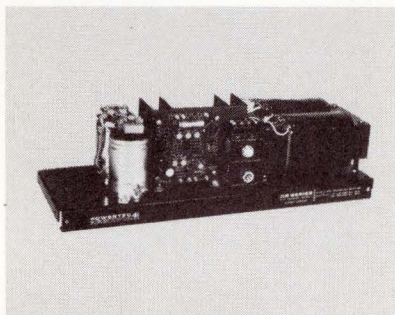

CR Power Supplies

Model Number	Output Power		Unit Price
	12 to 25V	24 to 50V	
10B300	12A	6A	\$129.00
10C600	24A	12A	\$187.00

Specifications INPUT: 115 VAC $\pm 10V$, 47-63 Hz; REGULATION: Line $\pm 1\%$, Load $\pm 1\%$; TEMPERATURE: 0°C to 40°C - derated to 71°C; O.L. PROTECTION: circuit breaker; RIPPLE: 300 mV/25V, 600 mV/50V (150 mV/25V, 300 mV/50V with ORR module).

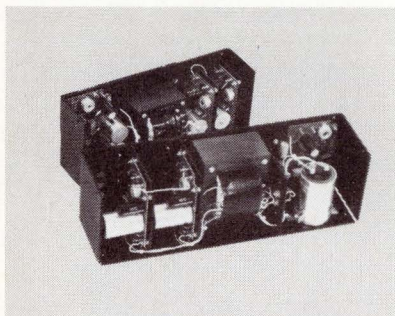

Multiple Output OEM Power Supplies

Model Number	Output Power			Unit Price
	$\pm 12V$ or $\pm 15V$	5V		
2K15D-1.3	1.5A	1.3A	NA	\$ 46.00
2L15D-2.8	3.0A	2.8A	NA	\$ 81.00
2R-70T	1.5A	1.3A	6.0A	\$ 86.00
2S-140T	3.0A	2.8A	12.0A	\$149.00

Specifications REGULATION: Line $\pm 25\%$, Load $\pm 25\%$; INPUT: 115 VAC $\pm 10V$ 47-63 Hz; RIPPLE: 1 mV RMS (5 & 15V); RESPONSE: 50 usec typical; TEMPERATURE: 0°C to 40°C derated to 71°C; O.L. PROTECTION: current limit/foldback; OVP: optional.

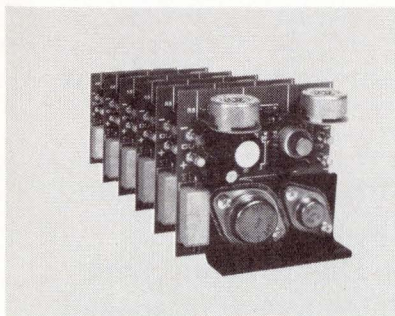

DC Power Regulators (2 7/8" x 2 3/4" x 1 3/16")

90 WATT MODEL	DC OUTPUT		180 WATT MODEL	DC OUTPUT	
	VOLTS	AMPS		VOLTS	AMPS
1B5-6	4.5-6.5	6.0	1C5-12	4.5-6.5	12.0
1B15-6	11.5-15.5	6.0	1C15-12	11.5-15.5	12.0
1B24-4.5	17.5-24.5	4.5	1C24-8	17.5-24.5	8.0
Unit price	\$15.00		Unit price	\$22.00	

Specifications INPUT VOLTAGE (MAX.): 40 VDC; REGULATION: Line $\pm 0.75\%$, Load $\pm 0.75\%$; INPUT-OUTPUT DIFFERENTIAL (MIN.): 4.5 VDC; OUTPUT RIPPLE (MAX.): 4 mV P-P (2.0V P-P input ripple); OPERATION AMBIENT TEMP.: -5° to +75°C; TRANSIENT RESPONSE: 25 usec. (50% load change).

Request free application data and catalog.

POWERTEC INC.

an Airtronics subsidiary

9168 De Soto Ave., Chatsworth, California 91311 (213) 882-0004 TWX 910-494-2092

AZ. Scottsdale, Hamilton (602) 948-3661
 CAL. Los Angeles, Burtis (213) 670-5863
 CAL. Santa Clara, Richards (408) 246-5860
 COLO. Denver, D.E. Bond (303) 756-1234
 FLA. Miami Beach, Geartner (305) 531-0200
 FLA. Orlando, Geartner (305) 299-1000

IND. Indianapolis, Holsapple (317) 894-0513
 MD. Annapolis, Hayden (202) 296-6059
 MASS. Needham, Garrettson (617) 449-2640
 MINN. Minneapolis, Comstrand (612) 560-5300
 MO. St. Louis, P.A.C. (314) 426-2331
 N.M. Albuquerque, D.E. Bond (505) 296-9111

N.Y. White Plains, Garrettson (914) 946-3001
 N.Y. Williston Park, Garrettson (516) 747-6610
 PA. Philadelphia, Garrettson (215) 464-2275
 TEX. Dallas, Reese (214) 638-6575
 TEX. Houston, Reese (713) 621-3134
 WASH. Bellevue, A. Smith (206) 746-6770

The reason most companies can't give you is because they're small

We make and market more kinds of computers than any other computer company in the world.

Big computers. Middle size computers. And small computers.

And our Logic Products Group can hook them up to anything you want them hooked up to (in the trade we call it "interfacing"), to do whatever job you want them to do.

Because we make all the parts and pieces it takes to do it ourselves.

Like genuine Digital Equipment Corporation modules (including special modules) plus labs, wire wrap service, engineers, designers, logic people, seminars we set up for you and your people in your area, cabinets, cables, hardware, assembled logic arrays, terminals, etc.

The reason most small computer companies can't give you big

small computer big computer support computer companies.

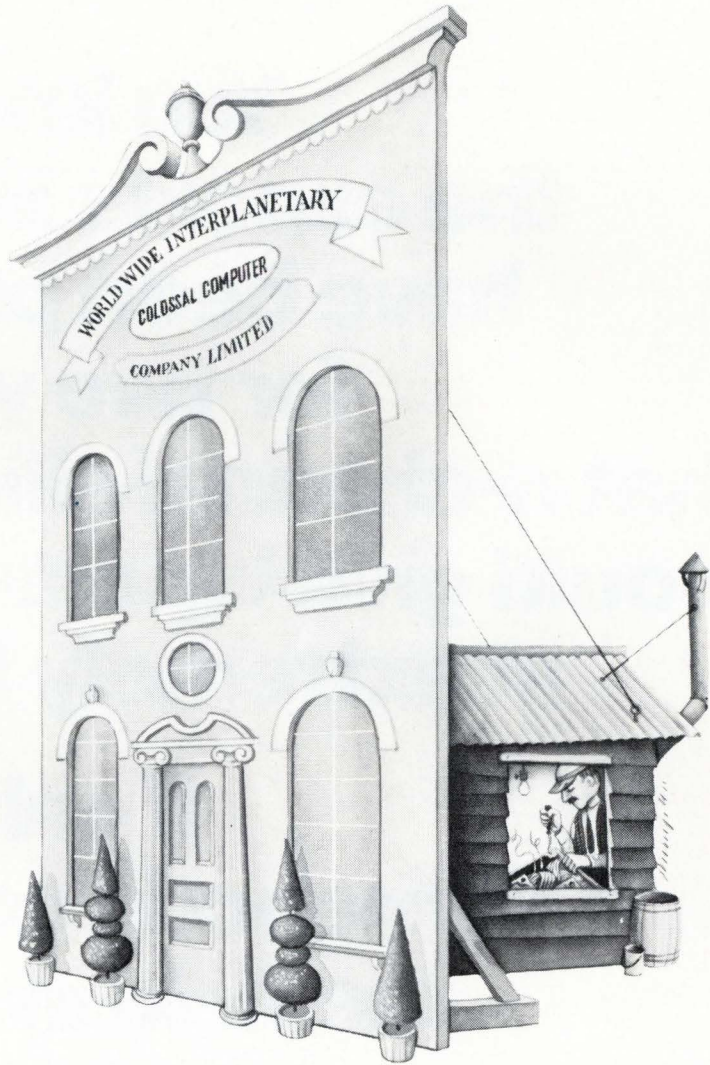

We'd be happier if everybody in the world bought all their computers from us.

But, if you don't and you don't know how to hook their's up when it does finally arrive, and they don't have anybody to run over and help you, we do.

And we will.

You see, we're big enough that it's no big deal to do it.

And we're bright enough to know that if we hook your computer up properly even if it isn't ours, you'll think we're nice guys and come to us first when it comes time to buy your second. (617) 897-5111 (Ext. 2785).

Digital Equipment Corporation,
Maynard, Massachusetts 01754

digital

computer support is because they're small computer companies.

**You know,
the experts in MOS/LSI
have been predicting
for two years
that n-channel silicon gate MOS
would give bipolar performance
at extremely low cost...**

**if only
somebody could solve
the field inversion
problem.**

SOMEBODY HAS!

Standard Microsystems Corporation has perfected and put into production a simple, reliable n-channel silicon gate technology, COPLANOX*. The structure is inherently immune to field inversions and the process is so suitable for high-density arrays that COPLANOX is actually more economical than conventional p-channel MOS.

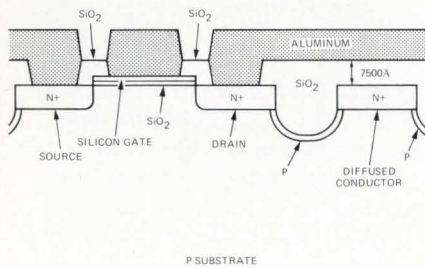

COPLANOX* cross section view

Consequently, Standard Microsystems is now accepting orders for the development and production of custom COPLANOX logic, memory and data communications subsystems. By subsystems, we mean MOS/LSI replacements for assemblies of bipolar digital circuits, conventional MOS/LSI circuits, or both. Standard Microsystems' engineering staff is particularly expert in calculator, computer and modem design.

COPLANOX culminates years of research and development. Standard Microsystems was organized this year for the express purpose of completing process and system design work begun at companies amalgamated into the present corporation.



Dr. Charles H. Sutcliffe, president: managed semiconductor operations at Philco and General Instrument; managed MOS operations at Fairchild; co-founder and president of Four-Phase Systems, among other executive positions in the semiconductor industry.

COPLANOX is a technique of forming a very thick oxide structure around the operating transistors. The structure and doping of the underlying silicon prevent field inversion. In addition, the structure results in a much smoother surface on the silicon wafer and allows much smaller circuit elements to be formed. This configuration achieves both stability and a functional density up to four times that of conventional MOS.

Stability, because the unrelated regions in the substrate have a field inversion threshold many times normal operating voltage. A voltage greater than 100 volts is needed to create field inversion and a "phantom transistor" between unrelated regions.

COPLANOX arrays operate at DTL and TTL supply and logic levels. Being n-channel silicon

gate, they also operate with a speed/power product comparable to bipolar logic.

High density, because narrower spacing between unrelated regions and narrower metallization lines may now be used with excellent reliability. There are no steep oxide cliffs to jeopardize the integrity of the thin-film metallization. The wafer surface is nearly smooth, hence the name COPLANOX.

Freedom from field inversions and up to four times the density make COPLANOX the most economical and reliable MOS/LSI technology available today. It is available only at Standard Microsystems. Now is the best time to talk with us about your custom subsystem requirements.

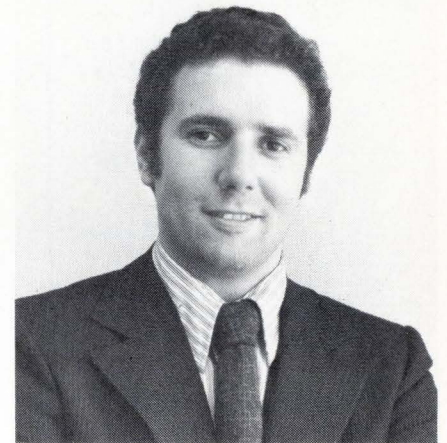

Paul Richman, vice president, research: eight patents issued or pending in MOS technology; at GT&E Laboratories, developed the first operational space-charge-limited MOS tetrode and fabricated one of the first p-channel silicon gate devices.

*COPLANOX is a development of Standard Microsystems Corporation. Patent applications have been filed for the structure and the process.

 **STANDARD
MICROSYSTEMS
CORPORATION**
1101 San Antonio Road
Mountain View, California 94040
(415) 965-0575

Eastern Area Sales Office: Call Jerry Gollub (516) 231-5151

Circle 13 on reader service card

New commercial versions of RCL's MINIATURE ROTARY SWITCHES

as low as

\$196
each
in quantities of 1,000

DELIVERY FROM STOCK

5 Separate Series 6-10-12-24 Position

(Price Applies to All Multi-Deck Miniature Switches)

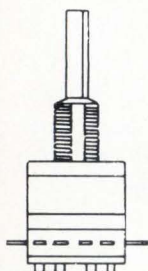

Completely automated facilities and mass production tooling now makes RCL highly competitive in commercial applications with "obsolete" wafer-type open frame switches.

Material and tooling are modified to further reduce cost, but equivalent performance is maintained to correspond with "instrument type" switches.

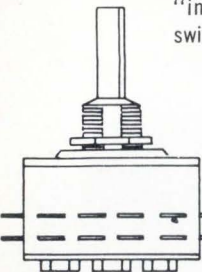

- Up to 12 poles per deck
- As many as 9 decks may be specified.
- Life expectancy in excess of 50,000 mechanical operations.

- Available modifications include spring return feature, and "push-to-turn" and "pull-to-turn" spring loaded action.

(U.S. Pat. #3352979)

Write for complete engineering information

RCL

General Sales Office
RCL ELECTRONICS, INC.
700 South 21st Street
Irvington, New Jersey 07111

People

ECI's Scott courts shrinking military dollar

You might think that Peter L. Scott, president of Electronic Communications Inc., a long-time supplier of communications gear to military and aerospace customers, would thank his lucky stars these days that he also had some commercial and industrial product lines under his wing. But you'd be wrong.

Although such diversification is the aim of many companies as the number of electronics procurement dollars have shrunk, it's not Scott's goal at all. "We're after the military electronics dollar," he declares cheerfully, reiterating a decision made last June. This decision was to give his company all of the defense and space electronics contracts of NCR, which has been ECI's parent since 1968. So far, results have been quite satisfactory.

Twice the list. "Our backlog doubled in the last six months of 1971," Scott asserts. The contracts have come as extensions to ECI's established product lines—shipboard tactical UHF satellite communications terminals, S-band telemetry transmitters, shipboard UHF radios, and thermal printers.

In gearing up for his new business concentration, the 44-year old Scott sold off, closed down, or transferred to NCR several commercial operations which had represented as much as 15% of ECI's total business. These included lines of stainless steel and aluminum barrels, receivers and equipment for amateur radio enthusiasts, and cockpit instruments for the general aviation industry. From four divisions, ECI is left with its St. Petersburg, Fla., division and its affiliate Scott Electronics Corp., an Orlando, Fla., manufacturer of specialized magnetic components for communications, radar, and computer gear.

A BSEE degree holder from Ohio State University (1949), Scott is amply qualified to thread his way through the difficult electronics marketplace. ECI, which employs about 1,000 people, is the third company he's headed. The first two he



Scott: "We're after the military dollar."

founded himself: Hermetic Seal Transformer Co. in Garland, Texas, in 1952, and Scott Electronics Corp. in 1963. The latter was acquired by ECI in 1965, and Scott became president of ECI in March 1971.

Looking off into the future, Scott is pushing his company more vigorously into foreign marketplaces to "amortize the non-recurrent development costs over a large number of units." Selling only in this country won't generate enough sales, he fears. Scott is also looking for the right kind of acquisitions to "expand ECI's product base." And he's keeping careful check of development and manufacturing costs in order to stay profitable because, he points out, the government will no longer tolerate the kind of equipment costs it once did.

COM's coming on, says Quantor's Askanas

Computer-output microfilm, once seen by many as an alternative to the paper glut, has been drifting as a business for several years. But according to Charles Askanas, president of Quantor Corp., a Cupertino, Calif., maker of COM equipment, "It's coming into its own now."

While Askanas has an understandable prejudice, his optimism is tempered by realism. In his view, COM must hurdle three obstacles before it can become a commercially viable technology.

"The computer industry ignores COM, the electronics industry ignores COM, and the microfilm industry, which latched onto it, doesn't understand it," says the 40-year-old New York City native. The point is that COM isn't the paper saver it was believed to be. Rather, one of its

ac, dc, volts, amps, ohms

25 ranges

0.01% dc accuracy

\$650 complete



Systron-Donner's new all-function 7004 Digital Multimeter. Measures **everything**—dc and ac voltage, dc and ac current, and resistance. Built-in shunts for current measurements. Fully guarded input for highest common mode isolation. Dual-slope integration design. 1,000 megohm input impedance on three lowest ranges. Optional battery pack with recharger (\$95) **mounts internally**. For lab, field or systems use (with DTL/TTL compatible BCD outputs \$45). Ask your local Scientific Devices offices for technical data or contact: Concord Instruments Division, 888 Galindo St., Concord, CA 94520. Phone (415) 682-6161.

SYSTRON  DONNER

Another S-D instrument first! Electronic counters / Digital voltmeters / Pulse generators / Data generators / Time code generators / Sweep generators / Spectrum analyzers / Digital panel meters / Digital clocks / Signal generators / Oscillators / Laboratory magnets / Precision power supplies / Analog & analog-hybrid computers / Data acquisition systems.

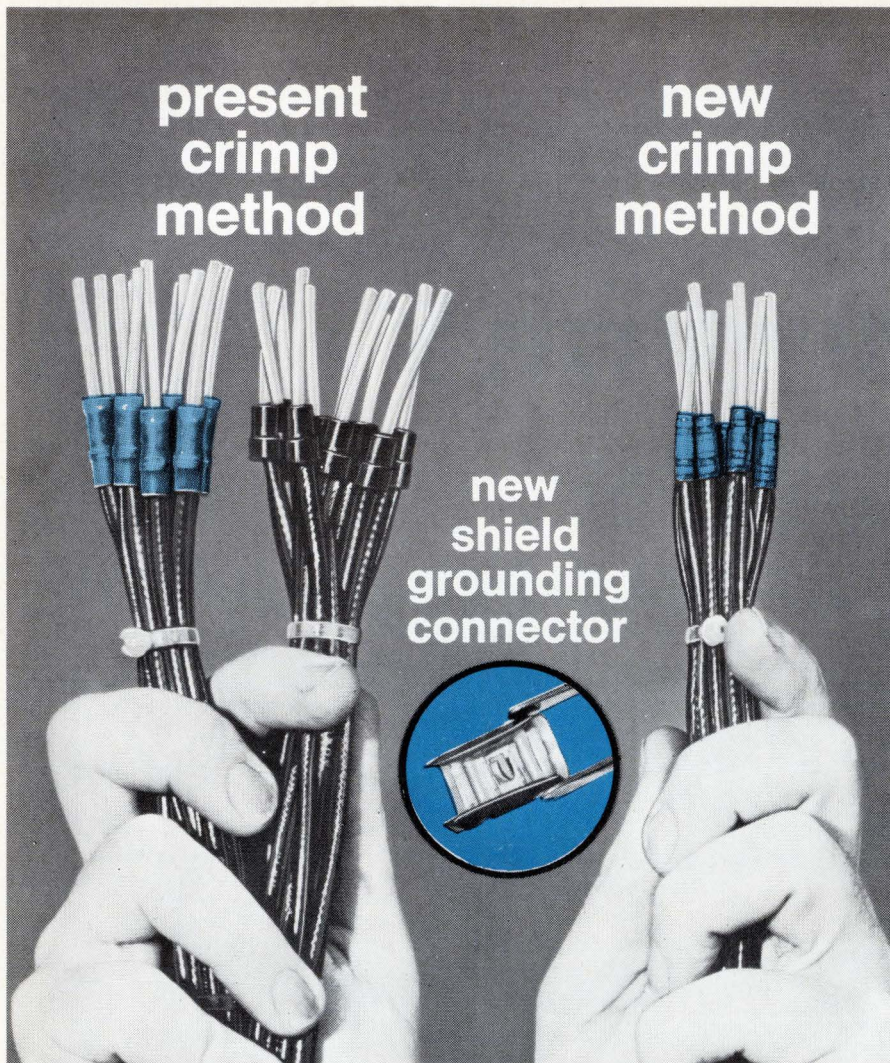

The most compact Solderless Connector ... and a NEW Lower Installed Cost

New, miniature connector gives you 75 to 90% time saving over present compression technique. Its high reliability factor results from the no-heat requirement as well as complete visibility for inspection of the one-piece connection before, during and after termination.

Only three sizes are needed to handle the range of shielded cables from .055 to .205 over braid dia.

The installing tool features the exclusive Shure-Stake® mechanism which assures that the proper, preset compression will be reached before the tool will release the connector. The Thomas & Betts Company, Elizabeth, New Jersey 07207. In Canada, Thomas & Betts Ltd., P.Q.

New Shield-Kon® Wrap Around Connector Features

- miniature size, light weight, one piece construction
- lower installed costs
- higher reliability, meets or exceeds the applicable performance requirements of MIL-F-21608.
- mid-span termination capabilities

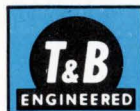

THOMAS & BETTS

Division of Thomas & Betts Corporation

Sold Coast-to-Coast
Through Authorized
T&B Distributors

486

major functions is as a line printer ancillary.

Aims at business. There are three types of COM: photo typesetting; engineering, which produces drawings; and alphanumeric, or business, output. It's the last category on which Quantor is concentrating and on which Askanas is basing his hopes. He reasons that, where output must go to many locations, and true real-time response isn't necessary, COM is most economical.

During last month's Christmas shopping crush, for instance, the San Francisco outlets of a major department store chain used COM to eliminate the bottleneck created by shoppers who forget their credit cards. To complete a sale, the purchaser's account number and account status had to be determined. If this had been done with printed pages at each cash register, too much time would have been needed for each sale. And for security reasons, it's not a good idea to have customer names and account numbers so readily available. The solution: install a Quantor COM recorder, duplicator, and 15 terminals with keyboard index and retrieval systems. Terminal operators were contacted by phone.

According to a store spokesman, the system performed very well. Total monthly rental was about \$5,000; to implement a similar system using CRT displays and associated hardware would have cost two to three times as much.

Askanas, who was general manager of Fairchild's Systems division before starting Quantor two and a half years ago, says that most people are leery about COM equipment because they think chemicals and plumbing are required. "This just isn't the case," he says. "The only connection required by our model 100 and 105 recorders [*Electronics*, Jan. 3, p. 112] is the ac plug. Everything else is contained inside."

Askanas' main task now is to make it understood that COM is not a substitute for line printers and is not messy film-processing equipment, but "an extremely powerful and cost-effective substitute for an on-line CRT terminal system."

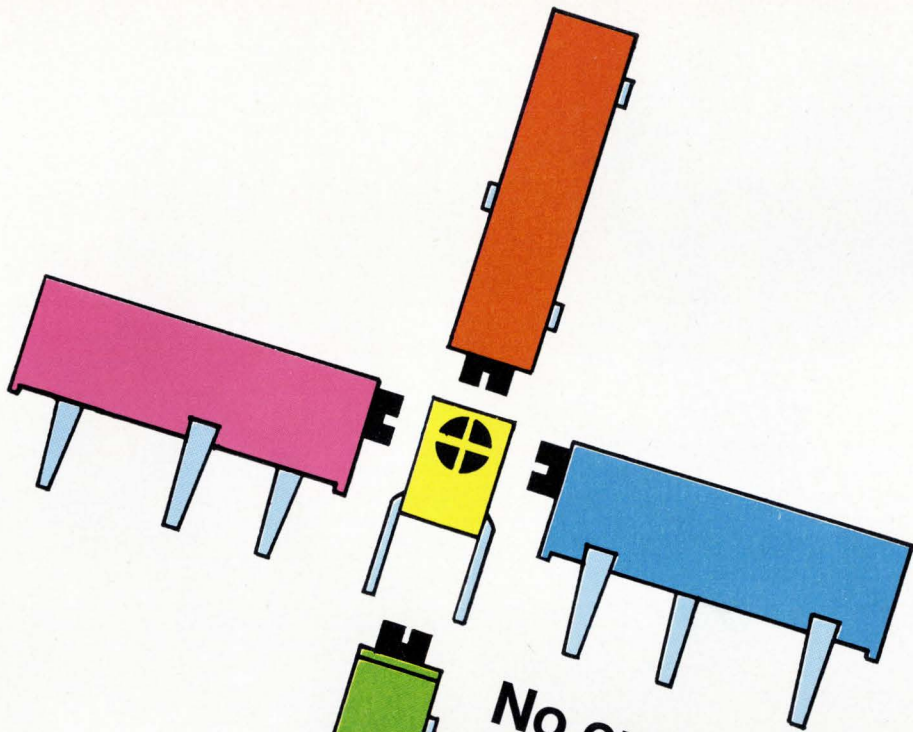

No one else packs so much quality into a 3/4" trimmer -

- **Improved Setability and Stability** - Twenty turns, brush contacts, and unique "T" slider block design.
- **Improved CRV and RT Tolerance** - Three percent or three ohms CRV and $\pm 10\%$ RT tolerance.
- **Double Slotted Metal Shaft** - Accommodates standard or phillips-head screwdriver.
- **Sealed Case** - Permits cleaning in common solvents.
- **Choice of 3 Pin Configurations** - All 3 pin configurations available.
- **Low Profile** - Stands only $\frac{1}{4}$ inch above the board.
- **Resistance to Shock and Vibration** - Meets pertinent MIL-R-22097 requirements.

and sells it for less!

For a data sheet, just use the reader service card.

THE NEW MODEL 43



actual size

Spectrol

SPECTROL ELECTRONICS CORPORATION
A Subsidiary of Carrier Corporation
17070 EAST GALE AVENUE
CITY OF INDUSTRY, CALIFORNIA 91745
TELEPHONE: (213) 964-6565
TWX (910) 584-7314



Accept No Substitutes!

The New HP Series 9800 is the best programmable calculator system now—and in the foreseeable future. Price. Performance. Simplicity of operation. No matter what criterion you use, there is absolutely no other system on the market that can match the Series 9800.

Only HP Offers You All This For The Low Price Of \$2975

To build your personal desk-top computing system, start with the Series 9800/Model 10 Programmable Calculator. Your basic Model 10 comes with standard equipment that is either not available, or available only as an extra-cost option, on other machines.

If bad experiences have taught you that basic is synonymous with stripped—have no fear. The *basic* Model 10 can perform a complete regression analysis, or solve a system of 10 simultaneous equations.

Only HP Offers You A Fully Modular Calculator

The unique, modular/plug-in architecture of the Model 10 lets you “design” your own problem-solving system. You can expand the memory, add peripherals, or change the keyboard of your existing Model 10, at any time.

Only HP Gives You A Fully Expandable Dual Memory

The Model 10 has a unique dual memory system—one memory for programs and one for data. You can expand from the basic 500 program steps *and* 51 data registers to 2036 program steps *and* 111 data registers.

Beware of simple number comparisons with other calculators. The refinements in the memory design and the keyboard make the Model 10 so efficient that in most cases it requires *fewer steps to execute a given problem*.

Only HP Lets You Design Your Own Keyboard

Interchangeable keyboard plug-in blocks give you a choice of powerful *Statistics* or *Mathematics* functions, complete with their own memories, under single keystroke command. Another option, the *User Definable Function* plug-in, lets *you* customize individual keys with operations uniquely important to *you*.

Only HP Offers An Alphanumeric Printer

By simply inserting the *exclusive HP Alphanumeric Printer Plug-in*, you can automatically generate labels, program instructions, or messages—in English—right on the printer tape.

Only HP Gives You A Wide Choice of Sophisticated Peripherals

The I/O bus of the Model 10 lets you plug-in a Marked Card Reader, Paper Tape Reader, Digitizer, Typewriter, Tape Cassette, or the *exclusive X-Y Plotter* that plots linear, log-log, semi-log, or polar plots, and writes alphanumerics.

Only HP Offers You A Totally New System

The Series 9800 is no paper tiger. It's available now to free you from the drudgery of problem-solving so you can get on with your job of innovative thinking and designing. For more information or a “hands-on demonstration” at your desk, write: Hewlett-Packard, P.O. Box 301, Loveland, Colorado 80537. In Europe: 1217 Meyrin-Geneva Switzerland.

COE115

HEWLETT  PACKARD

CALCULATOR PRODUCTS

Now your #1 source for digital is also your #1 source of reference.



The "can-do" champions in digital capability put it in writing. With the most complete "how-to" library available off-the-shelf. Check the coupon below, or call your local Signetics salesman or rep.

Signetics

Signetics-Digital
811 E. Arques Avenue
Sunnyvale, California 94086

Please rush your digital manuals, containing comprehensive logic diagrams, schematics, pin configurations, operating characteristics and application information on Signetics #1 Digital Line.

Check or money order, payable to Signetics-Digital, enclosed to cover nominal postage and handling costs. \$1.00 for entire set, 50¢ each for individual handbook.

- Complete Digital Package (6 books) \$1.00
- 54/7400 TTL Handbook, 256 pages. 50¢
- Utilogic II/600 TTL/DTL Handbook, 64 pages. 50¢
- 8000 Series TTL/MSI and Memory Handbook, 208 pages. 50¢
- DCL SSI 84/8800 TTL/DTL Handbook, 112 pages. 50¢
- MOS Silicon Gate 2500 Series Handbook, 176 pages. 50¢
- 8000/5400 Chip Catalog, 72 pages. 50¢

Name

Title

Company

Address

City

State

Zip

Telephone ()

SIGNETICS CORPORATION — A SUBSIDIARY OF CORNING GLASS WORKS

SALES OFFICES

CALIFORNIA

Del Mar: (714) 453-7570
Irvine: (714) 833-8980 (213) 437-6718
Sunnyvale: (408) 739-7700

FLORIDA

Boca Raton: (305) 391-8318
Clearwater: (813) 726-3469

ILLINOIS

Rolling Meadows: (312) 259-8300

MARYLAND

Silver Springs: (301) 946-6030

MASSACHUSETTS

Lexington: (617) 861-0840

NEW JERSEY

Fort Lee: (201) 947-9870

PENNSYLVANIA AND SOUTHERN NEW JERSEY

Medford: (609) 665-5071

VIRGINIA

Reston: (301) 946-6030

REPRESENTATIVES

ALABAMA

Huntsville
Compar Corp. (205) 539-8476

ARIZONA

Scottsdale
Compar Corp. (602) 947-4336

CALIFORNIA

San Diego
Celtic Company (714) 279-7961

CANADA

Montreal, Quebec
Corning Glass Works of Canada

Toronto, Ontario
Corning Glass Works of Canada (416) 421-1500

COLORADO

Denver
Elcom (303) 771-6200

CONNECTICUT

Hamden
Compar Corp. (203) 288-9276

FLORIDA

Altamonte Springs
WMM Associates, Inc.
(305) 831-4645
Clearwater
WMM Associates, Inc.
(813) 446-0075
Pompano Beach
WMM Associates, Inc.
(305) 943-3091

INDIANA

Indianapolis
R. H. Newsom Associates
(317) 849-4442

MARYLAND

Silver Springs
Mechronic Sales, Inc.
(301) 622-2420

MASSACHUSETTS

Newton Highlands
Compar Corp. (617) 969-7140

MICHIGAN

Grosse Pointe Park
Greiner Associates, Inc.
(313) 449-0188 (313) 449-0189

MINNESOTA

Minneapolis
Compar Corp. (612) 922-7011

MISSOURI

St. Louis
Compar Corp. (314) 567-3399

NEW MEXICO

Albuquerque
Compar Corp. (505) 242-3633

METROPOLITAN NEW YORK

Manhasset, Long Island
Win-Cor Electronics Sales Corp.
(516) 627-9474

UPSTATE NEW YORK

TriTech Electronics, Inc.
(315) 446-2881

NORTH CAROLINA

Winston-Salem
Compar Corp. (919) 723-1002

OHIO

Dayton
Compar Corp. (513) 890-9260
Fairview Park
Compar Corp. (216) 333-4120

SOUTHERN NEW JERSEY AND PENNSYLVANIA

Haddonfield, N.J.
Compar Corp. (609) 429-1526

TEXAS

Richardson
Semiconductor Sales Associates
(214) 231-6181

UTAH

Salt Lake City
Elcom (801) 846-2317

WASHINGTON

Bellevue
Western Technical Sales
(206) 454-3906

40 years ago

From the pages of Electronics, January 1932

Going on the assumption that no year is a success without one or more new tubes, it is interesting to speculate on what may happen in 1932. Undoubtedly the pentode type of rf tube will come into general use. Possibly some revamping of the 224 or 227 as to make them perform their detector-oscillator functions better will come about. The 235 will continue to be the rf tube. But the 280 in its large bulb, and with its high resistance, seems doomed—if the present difficulties with mercury vapor tubes can be ironed out.

Experimental tubes seen are in an S12 envelope, deliver 150 milliamperes, have a 2-volt, 3-ampere filament. The advantages of this type of rectifier are well known. Good regulation, low voltage drop, comparative freedom from line fluctuations, are cited. The smaller size would be welcome to midget manufacturers. Better regulation is desirable in a.v.c. sets and Class B amplifiers.

The use of permanent-magnet speakers may be another step toward cheaper filter-rectifier systems. For a 1,000-ohm speaker field one can substitute a 200-ohm choke with equivalent filtering but with less loss of voltage and regulation. On the other hand, no manufacturer has seen fit to substitute a 40-cent choke for the present speaker field in his filter to get the better regulation. After all, some argue, there would be a saving of only a few turns of wire on the transformer and what is that, with the present price of copper?

Two new types of microphones were introduced in 1931: the ribbon microphone, as developed by RCA Photophone, and the dynamic microphone developed by the Bell Laboratories. The former, because of its directional characteristics, has found particular application in sound-picture work. The dynamic microphone represents a decided improvement over the condenser microphone heretofore used for broadcasting and sound picture recording.

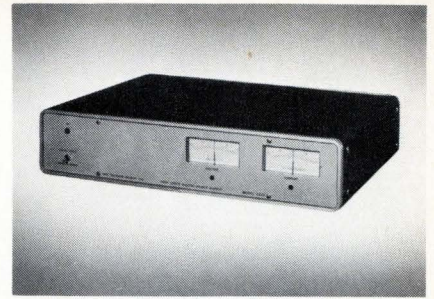

High-Speed Digital Power Supplies. Unique Series 3530 offers 0 to $\pm 100V$ and 0 to 10A. Remotely programmed in BCD or binary (14-bit with sign) at speeds greater than 10kHz and accuracies of 0.1%. Digital input controls output with TTL logic levels. Isolation 10pf AC and 2,000 megohms DC. Repeatability 0.005%. SRC/MOXON CIRCLE 148

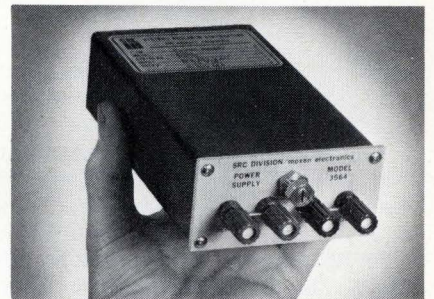

\$84.00 Isolated Miniature Power Supplies. Compact Model 3564 exceeds specifications of high priced supplies. Low 0.1pF AC and 10,000 megohms DC isolation (due to fiber glass front panel, precise component placement and multi-shielded XFMR). Ripple 75uV p-p. Front panel 10-turn pot. adjusts output 0-25VDC, 0 to 200mA. SRC/MOXON CIRCLE 149

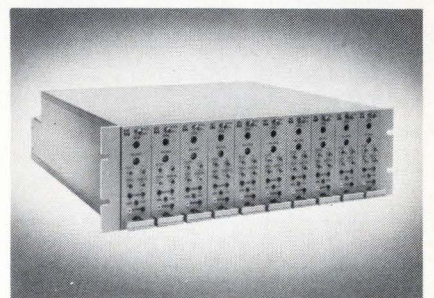

Universal Signal Conditioner. Excite transducers, troubleshoot or calibrate complete systems with Model 2541 or 2545. Modular plug-in construction allows individual channels to be adapted for conditioning of strain gages, thermocouples, RTB's, potentiometers, etc. Highest performance in industry. SRC/MOXON CIRCLE 150



SRC DIVISION/Moxon Inc.
2222 Michelson Drive
Newport Beach, Calif. 92664
Phone: (714) 833-2000

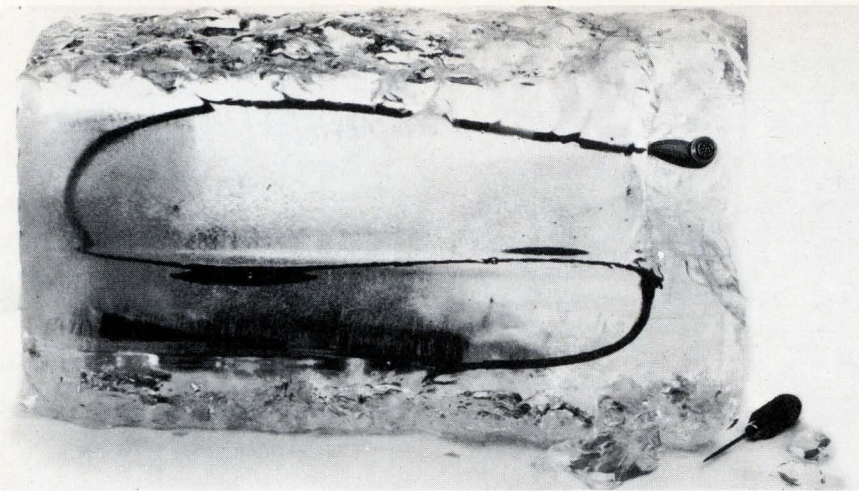

FREEZING

... CAN'T STOP A TRIANGLE MOLDED CABLE ASSEMBLY

High reliability molded cable assemblies have been developed by Triangle for stress applications where standard metal connector and potted cables have proven unreliable.

Our new design and manufacturing techniques have created a dependable molded cable with virtually unlimited small conductor and contact density potential. A permanent union between molding compound and cable jacket has been achieved through Triangle's intermolecular bonding process.

Thousands of hours of testing have proven our new molded cables reliable under the most varied and demanding conditions. They are the only cable assemblies that have met the U.S. Marine Corps rigid battlefield standards for vehicular radio communications (VRC series).

If you need high reliability in your cable assemblies, you need Triangle. For full details write or call today.

TRIANGLE MOLDED CABLE ASSEMBLIES VS. STANDARD METAL CONNECTOR CABLE ASSEMBLIES

Test	Immersion 48 Hours 30 Feet	Temp. Cycling -55C +85C	Dielectric to 1500 V for 1 Min.	Moisture 30 Cycles 24 Hours 98% R.H.	Vibration 50 g's 10-500 CPS	Flex 180° 1000 Cycles at Room Temp.	High Temp. 185° F.
Standard Cable Percentage Passed	48%	73%	80%	50%	41%	23%	30%
Triangle Molded Cable Percentage Passed	100%	100%	100%	100%	100%	100%	100%
Increase in Reliability	52%	27%	20%	50%	59%	77%	70%

TRIANGLE ELECTRONIC MANUFACTURING CO.

Headquarters:
182 N. Hamilton Street
Poughkeepsie, New York 12602
(914) 471-5020



DIVISIONS:
TRIANGLE ELECTRONIC MFG. CO., INC.
BOULDER, COLORADO
THOR ELECTRONICS OF CALIFORNIA, INC.
SALINAS, CALIFORNIA
THOR ELECTRONICS OF FLORIDA, INC.
DEERFIELD BEACH, FLORIDA

Circle 22 on reader service card

FIGHT THEM ALL...

Heart Attack
Stroke
High Blood Pressure
Rheumatic Fever



GIVE ... SO MORE
WILL LIVE HEART FUND

Meetings

Aerospace & Electronics Systems Winter Convention (WINCON): IEEE, Biltmore, Los Angeles, Feb. 8-10.

International Solid State Circuits Conference: IEEE, Sheraton Hotel, University of Pennsylvania, Philadelphia, Feb. 16-18.

International Convention & Exhibition: IEEE, Coliseum and N.Y. Hilton, New York, March 20-23.

International Geoscience Electronics Symposium: IEEE, Marriott Twin Bridges Motor Hotel, Washington, D.C., April 9-14.

International Conference on Magnetism (INTERMAG): IEE, Kyoto International Conference Hall, Kyoto, Japan, April 19-21.

Southwestern IEEE Conference & Exhibition (SWIEEEO): IEEE, Baker Hotel & Dallas Mem. Aud., Dallas, Texas, April 19-21.

Electrochemical Society Spring Meeting: Electrochem. Soc., Shamrock Hilton, Houston, Texas, May 5-12.

Quantum Electronics: IEEE, AIP, OSA, APA, Queen Elizabeth Hotel, Montreal, Canada, May 7-11.

Spring Joint Computer Conference: IEEE, Convention Center, Atlantic City, N.J., May 15-18.

Aerospace Electronics Conference: G-AES, Dayton Section, Sheraton Dayton Hotel, Dayton, Ohio, May 15-17.

International Microwave Symposium: G-MTT, Chicago Section, Arlington Park Towers Hotel, Chicago, May 22-25.

CALL FOR PAPERS

Conference on Nuclear and Space Radiation Effects: IEEE, Seattle, Wash. Summaries must be submitted to: B.L. Gregory, Division 1933, Sandia Laboratories, Albuquerque, N.M. 87115, by April 3.

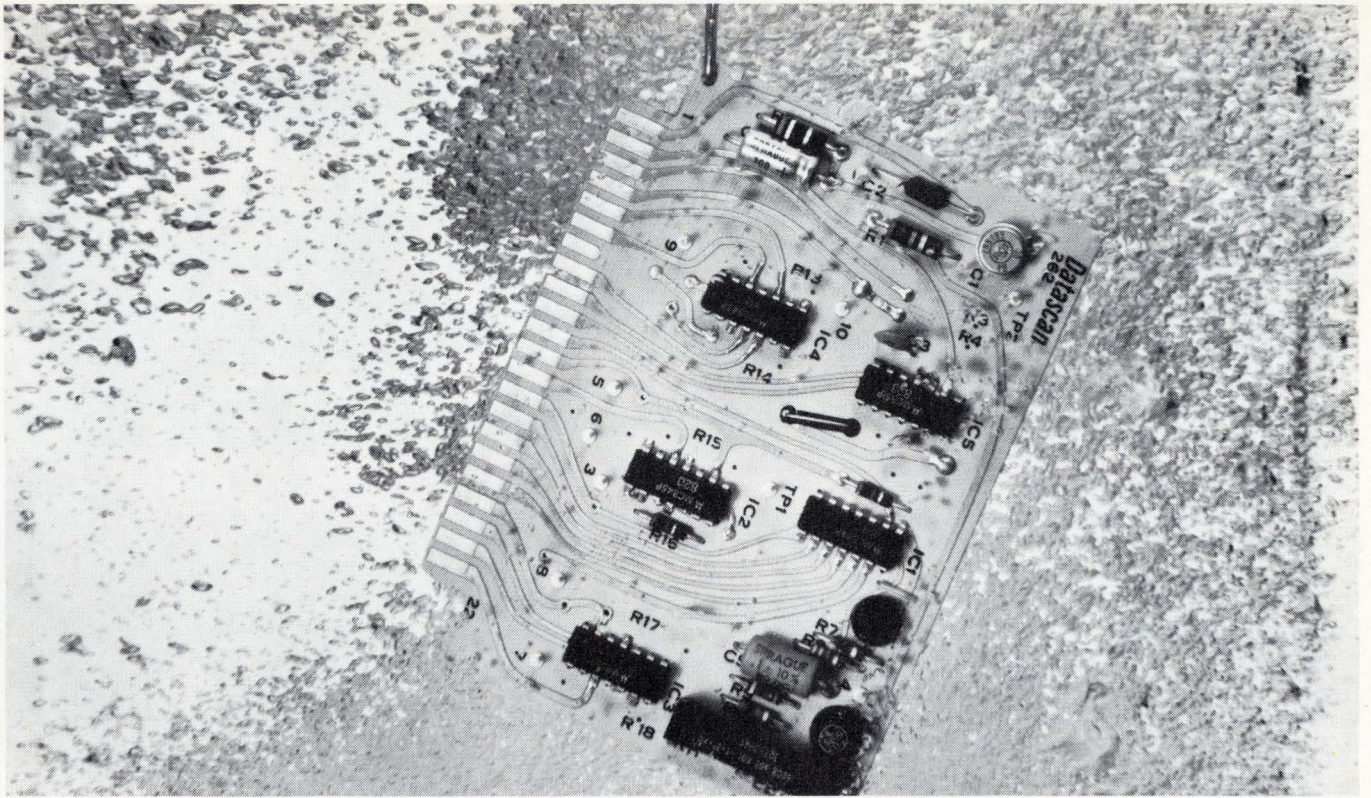

Clean the entire package residue-free with compatible FREON and save.

You can lower cleaning cost per board with FREON cleaning agents because they're compatible with most materials of construction, including polycarbonates. You can clean completely assembled boards without damage to substrate, components or markings. Remove all rosin-based flux and other contaminants at the same time. Get clean, dry, residue-free boards.

Flux Removal. A typical cleaning cycle for cleaning p.c. boards in a four-stage vapor defluxer is (1) gross removal of flux and contaminants in boiling FREON (below 118°F), (2) liquid rinse in FREON, (3) spray rinse, (4) final vapor rinse in vapors of freshly distilled FREON.

Low Solvent Replacement Cost. FREON cleaning agents are constantly

recovered and purified for reuse. In a properly designed and operated defluxer, solvent losses are minimal.

Purity. FREON cleaning agents are electronic grade materials and chemically stable. No stabilizers or inhibitors are needed.

Safety. FREON cleaning agents have a low order of toxicity. They are non-flammable and nonexplosive and do not require any special safety equipment.

See what a difference a properly designed FREON cleaning system can make in your cleaning costs. Write for more information about FREON and cleaning and defluxing systems. Du Pont Company, Room 22443I, Wilmington, Del. 19898.



FREON
cleaning agents

FREON is Du Pont's registered trademark for its fluorocarbon cleaning agents.

For built-in reliability, design with "Scotchflex" Flat Cable/Connector Systems.

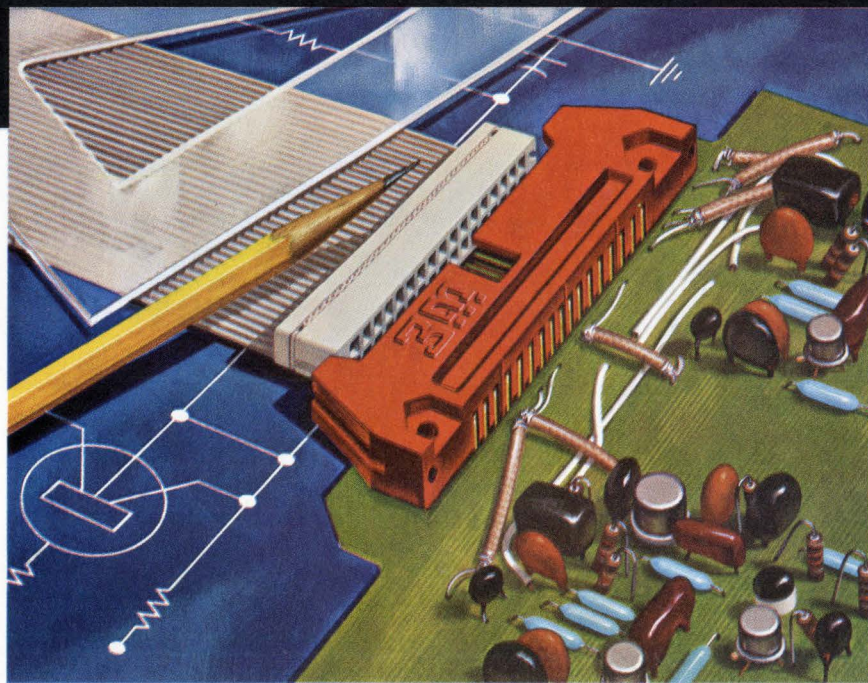

"SCOTCHFLEX" IS A REGISTERED TRADEMARK OF 3M CO.

"Scotchflex" Flat Cable and Connectors can offer you trouble-free packaging for your next generation equipment.

There's built-in reliability for your circuit inter-connects. Our flat, flexible PVC Cable has up to 50 precisely spaced conductors. The gold plated U-contacts are set into a plastic body to provide positive alignment. They strip through the insulation, capture the conductor, and provide a gas-tight pressure connection.

Assembly cost reductions are built-in, too. "Scotchflex" Connectors make up to 50 simultaneous connections without stripping or soldering. No special training or

costly assembly equipment is needed.

Off-the-shelf stock offers you flat cable in a choice of lengths and number of conductors from 14 to 50. Connector models interface with standard DIP sockets, wrap posts on .100 x .100 in. grid, or printed circuit boards. Headers are available to provide a de-pluggable inter-connection between cable jumpers and printed circuit boards (as shown). Custom assemblies are also available on request.

For full information on the "Scotchflex" systems approach to circuitry, write to Dept. EAH-1, 3M Center, St. Paul, Minn. 55101.



Electronics Newsletter

January 17, 1972

New epoxy offers acid-free package

The plastic dual in-line IC package debate of silicone vs. epoxy has been opened again by development of a new type of epoxy material by Allied Chemical and two other plastics companies. Most semiconductor companies employ silicone, except Texas Instruments, which uses epoxy. While epoxy forms a better physical package—a tighter bond between package and leads—ionic by-products are formed during the curing process that can combine with moisture to form acid. Because these acids destroy chip metallization, silicone has been preferred. **But the newly developed material produces no ionic by-products that could form acid.**

The first company to use the new material is National Semiconductor Corp., Santa Clara, Calif., which has conducted 6 million device hours of testing. **All types of bipolar digital ICs will be available in the new epoxy package by March**, and industrial linear and hybrid ICs will be phased in next. A company spokesman said that MOS circuits, which now are in hermetic packages, will be available in the new epoxy material as soon as reliability tests are completed.

NRMEC maps liquid crystal push

Officials at North American Rockwell Microelectronics Co. are putting their money on liquid crystal displays. NRMEC has geared a pilot production line in Anaheim, Calif., to produce several thousand a month, with **an eye toward eventual output of tens of thousands a month from a production line to be located elsewhere**, says NRMEC president R.S. Carlson. He says NRMEC will produce "several hundred thousand" transmissive liquid crystal displays in the next 15 months, to be sold initially in conjunction with other NRMEC products, particularly MOS/LSI drivers.

The pilot line and eventual production plant won't be built on speculation; **the output is needed to meet contractual commitments for the display**. Carlson says NRMEC engineers have overcome early criticism of slow response time and temperature sensitivity of the displays with their proprietary liquid crystal material and screened tin-oxide production process.

Kearfott computer for Swedish fighter

The Kearfott division of the Singer Co., Little Falls, N.J., has been awarded a \$2.5 million developmental contract for the airborne digital computer for the new JA-37 fighter version of the Viggen-series aircraft. The award, by the Swedish Armed Forces Materiel Administration, bypassed Saab-Scania, the Swedish firm already building the computer for the attack version of the Mach-2 aircraft. A spokesman for the administration said Kearfott's bid was the lowest it received and that the computer is expected to be made in Sweden. At stake, in addition, Kearfott reports, is an option for as many as 250 follow-on production units. Kearfott will be building on its SKC-2000 computer, a multi-purpose, modular and asynchronous machine with a memory of 16,000 words of 32 bits that is expandable to 32,000 words. Development will take about two years.

The new award is the first production-oriented contract for the Kearfott computer, which was announced by the company at the Paris Air Show last spring.

Electronics Newsletter

Light detector for digital output goes monolithic

Designers at NRMEC have come up with what they believe is the first monolithic MOS/LSI photodiode-shift register array **intended for use as a light detector that gives a direct digital output**. The 16-bit array contains 16 diodes, the detectors, sample gates, timing circuits, and a static shift register. **Such a function has heretofore been performed with hybrid circuits**, says Fred Jenne, NRMEC's manager of MOS process development, who designed the array.

It's in a lens-top eight-lead TO-5 package and is designed to operate in light intensities ranging from 0.1 to 25 milliwatts per square centimeter over the -55°C to $+70^{\circ}\text{C}$ temperature range. Jenne expects the unit to find application where linear distance and angular motion have to be measured and a digital readout provided, as in electronic scales and embossed card readers.

Lago-Calc eyes another supplier

Lago-Calc Inc., which bought the design rights to the calculator line and leased the facilities of International Calculating Machines Inc. in Woodland Hills, Calif. [*Electronics*, Oct. 11, 1971, p. 26], may be switching from Electronic Arrays Inc. to North American Rockwell Microelectronics Co. as its MOS/LSI circuit supplier. Lago-Calc's president, Max Lagomarsino, and his associates have been huddling with NRMEC officials in Anaheim, Calif.

Electronic Arrays, whose Systems division spawned ICM as an original-equipment calculator builder, has continued as Lago-Calc's chip supplier, but Lago-Calc is either considering broadening its supplier base or dropping Electronic Arrays.

TRW increases Darlington voltage

TRW Semiconductor, Inc., Lawndale, Calif., will boost the voltage of monolithic power Darlington circuits next month with the introduction of its SVT 6000 series, **rated to 650 volts at 10 to 15 amperes**. Previous limits for such circuits have been about 150 V at 5 A. The units are for use in automotive ignition systems, television sweep circuits, and other high-gain power conditioning circuits.

The SVT 6000 has a collector-to-base voltage of 450 V at 15 A peak collector current. The SVT 6001 goes to 550 V at 15 A, and the SVT 6002 reaches a specified maximum of 650 V at that current. **The monolithic chip is 200 mils square, and includes the high-gain Darlington transistor pair plus two resistors, and an external diode provides rapid turn-off**. The units, housed in TO-3 packages, will sell for less than \$20 in single quantities, and the price will dip below \$10 each at 1,000 quantities.

Sun-powered laser delivers 1.5 watts

GTE Sylvania has developed a **sunlight-powered laser designed for long-lived communications in space**. The company, at its Mountain View, Calif., facility, obtained 1.5 watts of output power from a neodymium YAG (yttrium aluminum garnet) laser. Solar energy for exciting the laser was collected by a 24-inch mirror and focused into one end of the lasing material. Sylvania predicts that a similar unit could operate up to seven years—well beyond the lifetime expected of present lasers using conventional exciting methods. The work was performed under a contract from the Avionics Laboratory, Wright-Patterson Air Force Base, Ohio, as part of an effort to determine the feasibility of satellite optical communications.

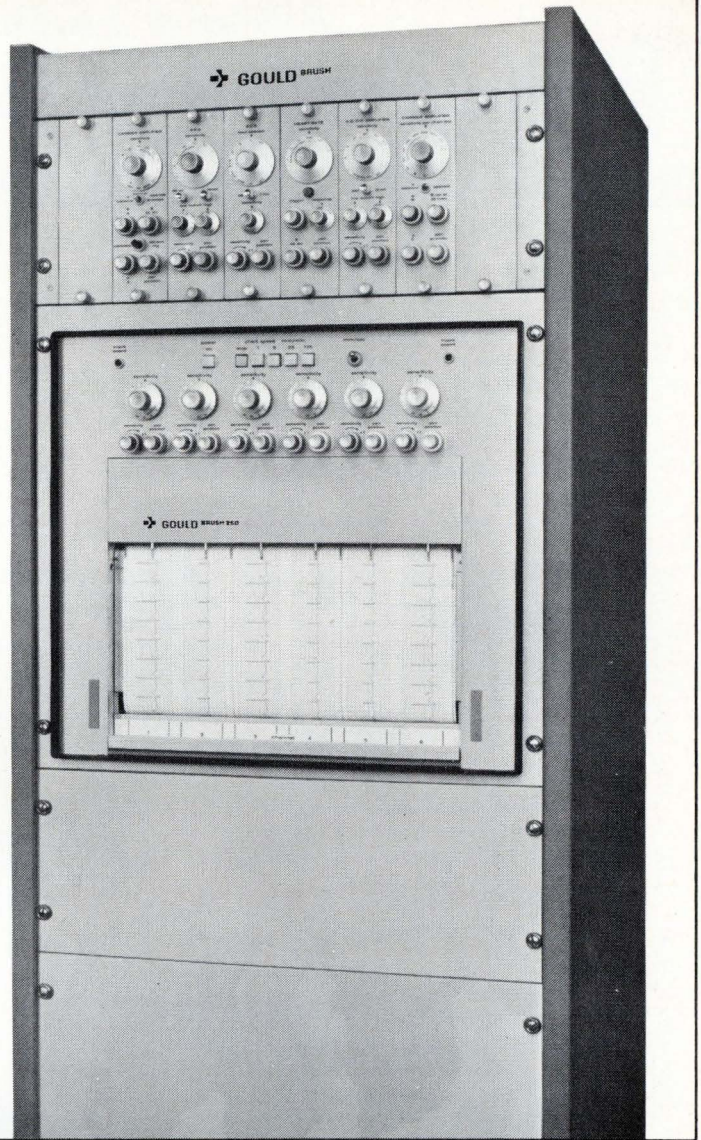
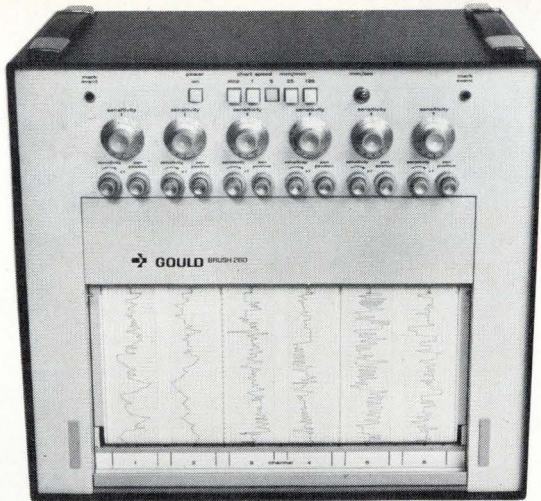

FREQUENCY RESPONSE AND AMPLITUDE

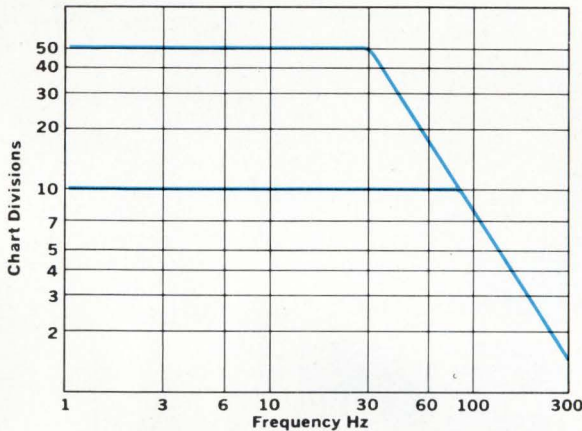

The Brush 260 is one of the few bargains left.

Because the Brush 260 6-channel recorder gives you the most accurate, reliable data at the lowest cost per channel.

The 260 also gives you all the important Brush exclusives. Like a pressurized ink system. Which eliminates smudging, puddling, and priming. So traces are always crisp, clear, and uniform. And a throw-away plastic cartridge which holds a year's supply of ink.

Another Brush exclusive is our Metrisite® non-contact servo-loop feedback device. The Metrisite makes the 260 so accurate we guarantee 99½% linearity.

And the 260 has built-in preamps which provide a

measurement range from 1mV/div. to 500V full scale. Frequency response for the 260 at 50 divisions is flat within ± 2% of full scale from d-c to 40Hz.

Add in six 40mm analog channels and four event markers. Plus eight pushbutton chart speeds from 1.0 to 125mm/second and mm/min. And you can use the 260 as a portable unit, rack mount it or put it in a roll-around cart.

The Brush 260. It's a good way to get the most for your money. For more information, write: Gould Inc., Instrument Systems Division, 3631 Perkins Avenue, Cleveland, Ohio 44114. Or Rue Van Boeckel 38, Brussels 1140, Belgium.

BRUSH INSTRUMENTS

 **GOULD**

MOSTEK MOS ion-implanted for high performance! easy to use...now easier than ever to buy!

RAMS

MK 4002 P

64 x 4 static TTL/DTL compatible RAM.

MK 4006 P, MK 4008 P

1024 x 1 TTL/DTL compatible RAM; dynamic storage but no clocks required; 400 ns access times available; 16-pin package.

MK 4007 P

256 x 1, pin-for-pin replacement for 1101 but with less than 250 mW of power and wide -6.5 to -15 V negative supply range.

(RS 110)

ROMS

MK 2002 P, MK 2101 P, MK 2302 P, MK 2408 P, MK 3101

Character generators; 64 characters, 5x7 dot matrix.

MK 2400 P

256 x 10 TTL/DTL compatible ROM with 550 ns cycle times.

(RS 111)

CALCULATORS

MK 5010 P

Single IC, four function (+ × - ÷) 10-digit calculator with display decoder, multiplexing circuitry, leading-zero blanking.

MK 5012 P

12-digit version of MK 5010 P.

MK 5013/5014 P

IC pair; four function 12-digit calculator with display circuitry, 1 memory, automatic constant, selectable 5/4 roundoff or truncate, leading-zero blanking.

Printer interface chip to be available.

(RS 112)

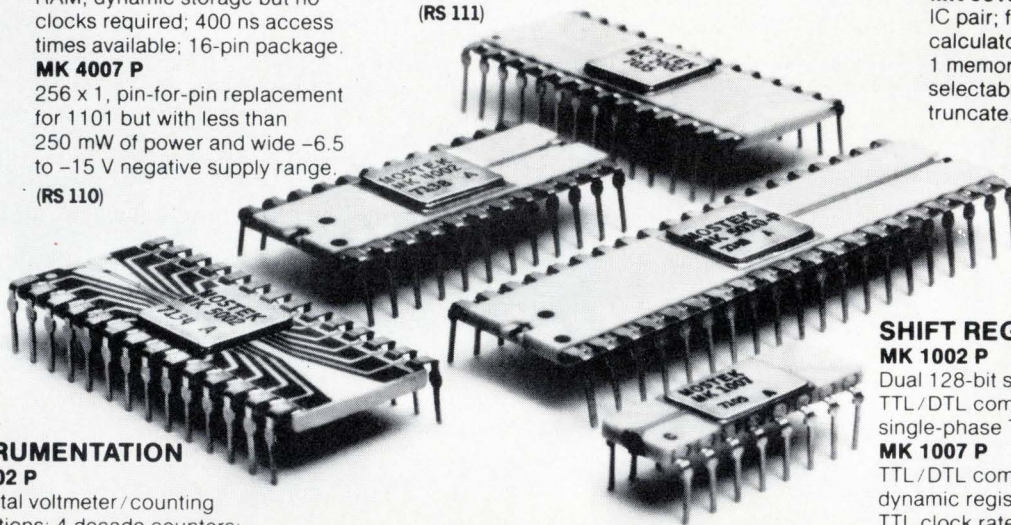

INSTRUMENTATION

MK 5002 P

For digital voltmeter/counting applications: 4 decade counters; storage; display; multiplexing; single + 5 to 20 V supply; power under 25 mW.

(RS 114)

SHIFT REGISTERS

MK 1002 P

Dual 128-bit static register; full TTL/DTL compatibility and single-phase TTL clocks.

MK 1007 P

TTL/DTL compatible quad 80-bit dynamic register; single-phase TTL clock rate to 2.5 MHz and built-in recirculate logic.

(RS 113)

Circle appropriate Reader Service (RS) numbers.

MOSTEK has made MOS easy to use and added unique MOS/LSI performance capabilities through its ion-implantation techniques. Now MOSTEK has made its standard

products more available than ever before thanks to a new network of distributors and representatives. Call the one nearest you *today* for information and off-the-shelf delivery.



1400 Upfield Drive
Carrollton, Texas 75006

Regional Sales Offices: West: 12870 Panama Street, Los Angeles, Calif. 90066 (213) 391-2746. East: 60 Turner Street, Waltham, Mass. 02154 (617) 899-9107. Midwest/Southeast: 515 S. W. Avenue, Jackson, Michigan 49203 (517) 787-0508.

Representatives: HMR Inc., Minneapolis, Minn. (612) 920-8200; **W. J. Purdy Co.**, Burlingame, Calif. (415) 347-7701; Littleton, Colo. (303) 794-4225; **KCE Corp.**, San Diego, Calif. (714) 278-7640; Los Angeles, Calif. (213) 391-0586; **Sheridan Associates, Inc.**, Cincinnati, Ohio (513) 761-5432; Florissant, Missouri (314) 837-5200; Cleveland, Ohio (216) 524-8120; Dayton, Ohio (513) 277-8911; Lathrup Village, Mich. (313) 358-3333; Pittsburgh, Pa. (412) 243-6655; **FM Associates Ltd.**, Greensboro, N. Carolina (919) 294-2754; Huntsville, Ala. (205) 536-9990; Orlando, Fla. (305) 851-5710; **Sprague Electric Co.**, Wayne, New Jersey (201) 696-8200; Schiller Park, Ill. (312) 678-2262; Richardson, Texas (214) 235-1256; Tempe, Arizona (602) 966-7233; N. Seattle, Wash. (206) 632-7761; **Precision Electronics, Inc.**, Glenside, Pa. (215) M16-8383.

Distributors: **Cramer Electronics Inc.**—Alabama: Huntsville (205) 539-5772; Arizona: Phoenix (602) 263-1112; California: San Diego (714) 279-6300; Colorado: Denver (303) 758-2100; Connecticut: North Haven (203) 239-5641; Florida: Hollywood (305) 923-8181; Orlando (305) 841-1550; Georgia: Atlanta (404) 451-5421; Illinois: Mt. Prospect (312) 593-0230; Maryland: Baltimore (301) 354-0100; Gaithersburg (301) 354-0100; Massachusetts: Newton (617) 969-7700; Minnesota: Bloomington (612) 881-8678; New Jersey: Union, (201) 687-7870; Pennsauken (215) 923-5950; New Mexico: Albuquerque (515) 265-5767; New York: Hauppauge, L.I. (516) 231-5600; Endwell (607) 754-6661; Rochester (716) 275-0300; East Syracuse (315) 437-6671; North Carolina: Raleigh (919) 876-2371; Winston-Salem (919) 725-8711; Ohio: Cleveland (216) 248-7740; Cincinnati (513) 771-6441; Oklahoma: Tulsa (918) 836-3371; Texas: Dallas (214) 350-1355; Utah: Salt Lake City (801) 487-3681; Wisconsin: Milwaukee (414) 462-8300; Canada: Ontario (416) 630-5023; **Brill Electronics**, Oakland, Calif. (415) 834-5888; **Elmar Electronics**, Mt. View, Calif. (415) 961-3611; **Liberty Electronics**, Inglewood, Calif. (213) 776-6252; **Wesco Electronics**, Los Angeles, Calif. (213) 685-9533; **Merquip Electronics**, Skokie, Ill. (312) 965-7500; **Stark Electronics Supply**, Minneapolis, Minn. (612) 333-3361; **Sheridan Sales Co.**, Cincinnati, Ohio (513) 761-5432.

International: MOSTEK GmbH, 7 Stuitgart 80, Waldburgstrasse 79, West Germany 0711-731305; System Marketing Inc., Center News Bldg., 1-3-11 Sotokanda, Chiyoda-ku, Tokyo, Japan; W. G. Booth Pty., Ltd., 39 Church Street, Hawthorn, Victoria 3122, Australia.

Circle 28 on reader service card

C/MOS watch kit aims at potential \$50 million market

Motorola corporate effort puts circuitry, frequency divider, and output driver elements into \$15 package

For more than a year, officials at the Semiconductor Products division of Motorola Inc. have been trumpeting their commitment to complementary MOS generally and the electronic timepiece market specifically. Now Motorola has gone two steps beyond the C/MOS watch circuits it's been making by offering the first integrated electronic watch kit to timepiece manufacturers. The kit consists of the C/MOS circuit—oscillator, frequency divider, and output driver elements—a precision quartz crystal, and a miniature micro-watt motor.

What's more, the effort is a corporate one, directed by Daniel E. Noble, chairman of Motorola Inc.'s Science Advisory Board, which further signifies the firm's determination to make it big in the timepiece market. The C/MOS circuit—already in production—and motor will be fabricated in Phoenix at the Semiconductor Products division, and the ultrastable quartz crystals are in production at the company's communications division in Chicago. Charles T. Johnson, appointed worldwide marketing manager for the watch kit program, will work out of Phoenix.

Hand-in-Hand. Jack C. Haenichen, vice president and director of MOS operations at the Semiconductor division, is blunt about the decision to market an entire electronic watch kit: "Electronic watches

have caught the watch manufacturers flatfooted. Most customers want to be led by the hand," he says. "That's why Motorola will do most of the work for them."

Kenneth Oliphant, consumer products marketing manager at the semiconductor division, adds that "the customer can see it all work together. He doesn't have to have a spec for the IC, one for the quartz crystal, and one for the motor. He has one source responsible for the whole kit." However, Motorola is also willing to sell the parts separately.

Interest high. Haenichen characterizes customer activity as "really high. We're in a tremendous position to take over the market." He says Noble regards the timepiece kit effort as potentially a \$50-million-a-year business for Motorola. At least one customer has already placed an order for several thousand kits.

Motorola decided to make the motors "to get vertical integration," Haenichen notes. "If anyone else would make motors for less than \$5, we couldn't do this," he adds. That's the price Motorola generally encountered when it sought to buy the motors. Oliphant says the motor is relatively easy to build, but that the circuit output has to be matched to the motor input to minimize torque. Motorola planners believe motors will drive a conventional hand indicator in electronic watches for some time to come, noting that other types of displays aren't maturing very fast.

The quartz crystals have to be small and have long-term aging stability that can be reset with a warping (trimmer) capacitor that's a separate component in the watch. The

crystals also must be highly shock resistant. Their frequencies will range from 32 kilohertz to 256 kilohertz initially, but that span could be increased later.

Although the kit may sell for \$15 or more in large quantities at first, Haenichen asserts that Motorola will have to get the price of each of the three chief components down to \$1. "Watches are going to be in the \$17 range eventually," he adds. "We're not banking on people upgrading their buying habits to buy electronic watches. That's why each of the elements has to be in the \$1 range."

Haenichen describes the timepiece kit program as a corporate effort "and a culmination of a long-time idea of Dan Noble's. He's commandeered all the effort required in the company to get this whole idea going as a business."

Components

Monolithic crystal filter in production after 5 years

Five years and millions of dollars after the device was invented, Bell Laboratories and Western Electric

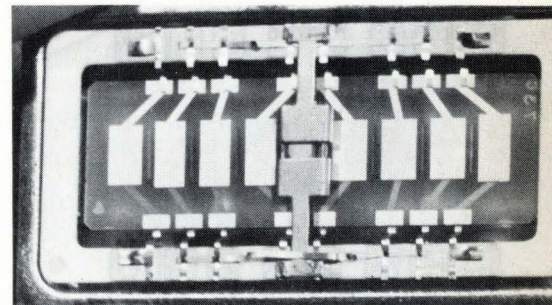

Pairs. Monolithic filter's resonators.

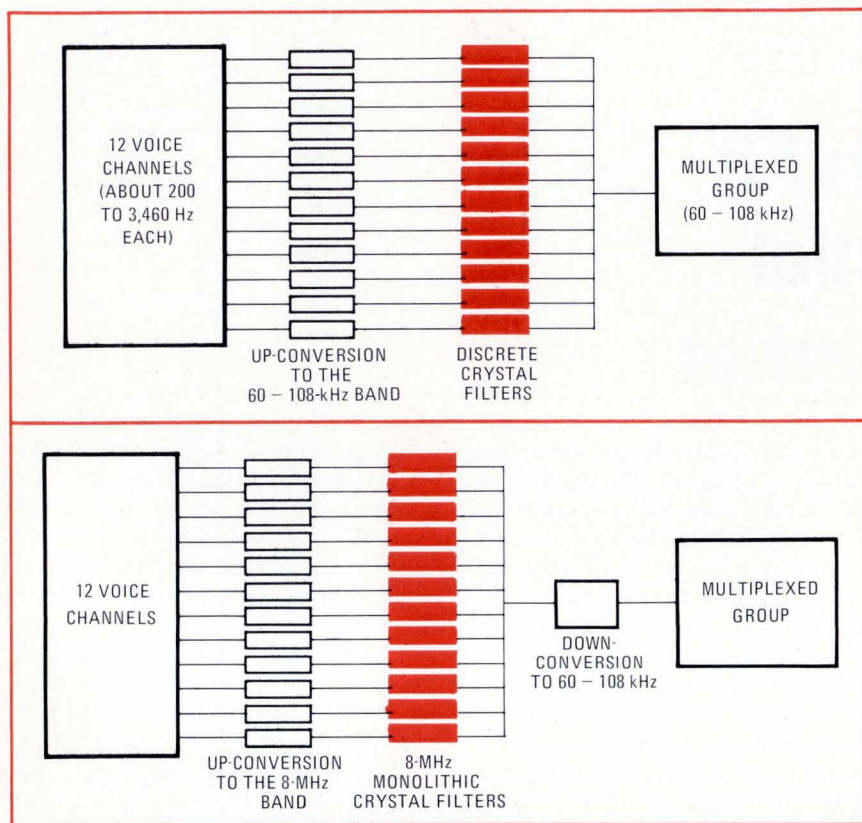

Replacement. Old filter bank (top) used bigger, costlier discretés. With new monolithic crystal filters (bottom), even the extra down-conversion doesn't hurt cost advantage.

Co. have succeeded in bringing a bandpass monolithic crystal filter into limited manufacture. The new part will play a vital role in the multiplexing banks used to stack telephone calls for the Bell System's long-haul transmission facilities.

Only a fraction the size of previous filters performing the same function, the monolithic filters require no bulky transformers or inductors. What's more, they're more reliable than conventional filters and ultimately promise to cost considerably less, according to Ivan Oak, department chief responsible for their development at Western Electric's Merrimack Valley Works in North Andover, Mass.

Tight fit. "Probably the most critical task," says Oak, "was that of locating the passband to within 3 hertz of the desired center frequency." Since the filter's center frequency is about 8 megahertz, this tolerance is equivalent to approximately 0.5 parts per million.

The filter consists of a wafer of crystalline quartz, onto which eight

pairs of metal electrodes have been deposited. Each pair forms a resonator with its resonant frequency determined by the combined thickness of the quartz wafer and the area of the metallic electrode films. "At present," says Oak, "the eight-resonator wafer is cut into two four-resonator segments, and the segments are electrically joined by a coupling capacitor."

The process capability line, developed for \$1.5 million, uses some new technologies to produce up to a half-million filters annually.

First among those techniques, X-ray diffraction ensures that the crystallographic orientation of the plates is held to within 30 seconds of the proper angle for cutting. Then, the electrode array is applied by vapor deposition of titanium-palladium-gold films on both sides of the polished wafer and the quartz plate is attached to a supporting ceramic frame. Thermocompression bonding—new to quartz crystal manufacture—is used for mounting.

Finally, a Q-switched yttrium-

aluminum-garnet laser is used to tune the filter by trimming the size of the electrodes and the tiny coupling stripes between the electrodes. The finished monolithic crystal filter replaces the conventional filter function in multiplexing equipment, but at a different point in the overall system.

Combining. William Spencer, head of the piezoelectric devices department at Bell Laboratories, explains that existing equipment up-converts a baseband voice channel to the international standard band from 60 to 108 kilohertz. The channel is then filtered and combined with 12 other channels to form a "group" for long-haul transmission. Any new multiplexing system must interface with the standard 60-to-108-kHz group.

Since the new filter operates at 8 MHz, the voice channel must be up-converted to this frequency for filtering, says Spencer. After filtering 12 individual channels, the group is then down-converted to the standard 60-to-108 kHz range. Thus, the new system requires 13 conversion steps, instead of the 12 required before.

The new system is less expensive and requires much less space, claims Spencer, adding that conversion steps are actually saved when this system is used to combine 12-channel groups into 60-channel "super-groups" used by Bell in high-volume links.

The 8 MHz frequency was chosen as a good engineering compromise, says Spencer. Going lower would mean an unnecessarily large crystal wafer, and shrinking circuit Qs serve to place an upper limit on frequency.

Communications

Combiner gives Navy low-cost satellite terminal

The Naval Electronics Systems Command has begun to receive a predetection combiner for shipboard satellite communications that could cost a quarter of previously

used systems. Made by Motorola's Government Electronics division in Scottsdale, Ariz., it uses less expensive conical and omnidirectional antennas to provide the relatively high gains needed. Steerable shipboard antennas that can cost \$50,000 or more have been used, but the new combiner gives enough gain to be used as a communications terminal.

The MVEC-70 combiner also may be used in aircraft and other moving vehicles, and has been used successfully in troposcatter receiving systems. The Navy contract is for engineering test and service test models using the combiner as a shipboard terminal.

Big market. John Knudsen, program development manager for electronic support measures and surface communications in the division's communications operations, looks for a mushrooming shipboard terminal market because the fleet satellite communications program has been approved. There also are upwards of 500 troposcatter systems, many of them using huge racks of tubes, that could be upgraded with the MVEC-70.

The combiner fits on four circuit boards—one for each antenna in the usual system—plus a sum-up board. The system will sell for \$12,500 in small quantities. Knudsen says the omnidirectional antennas cost about \$250, and the conical antennas sell for \$1,000 or more. Even when two combiners are used for redundancy, plus a down-converter, the system

cost is significantly less than if much larger steerable antennas were used to get the proper gain. The two predetection combiners and down-converter stack up to a height of 21 inches at full rack width for communications at 900 megahertz; Knudsen says that a whole rack of equipment is required for post-detection combiners.

The MVEC-70 is a maximal ratio (ratio squaring), four-channel combiner for use with diversity systems, phased arrays, or automatically switched antenna systems. With multiple receiving antennas, such as phased arrays, the combiner forms an adaptive array that can track a signal source or serve as a smooth, transitionless switch as the signal is changed from one antenna to another.

The combiner uses mixers and filters to recover the modulation-free carrier used to remove the phase difference from each received signal. Four-quadrant analog multipliers provide ratio squaring that turns off the weaker channel. The signals are combined without using phase-locked oscillators, which Knudsen says have been required in previous predetection combiners, making them bigger and more expensive than the MVEC-70.

Gain is 10 dB. In tests receiving Air Force tactical satellite signals aboard a guided-missile frigate, using stationary fore and aft omnidirectional antennas, plus port and starboard conical antennas, the

combiner delivered an average gain of about 10 decibels by summing the signals from all four antennas. Signals from the individual antennas ranged from 0 dB to a high of 10.5 dB as the ship maneuvered.

Aboard an aircraft carrier using four omnidirectional antennas, the combined gain went to about 11 dB, with individual antenna gains from 0 to 8 dB. After these tests, the Navy decided to use the predetection combiner approach, Knudsen says.

The MVEC-70, tested in a troposcatter system—using four receivers to cover two frequencies, thereby minimizing signal fading—delivered "better than an order of magnitude improvement in bit error rates" than a similarly tested post-detection combiner, he adds. For a given bit-error rate, Knudsen says this means the same results could have been achieved with one-fourth the transmitter power. Signal fading is characteristic of a troposcatter system, in which signals are bounced off the troposphere.

Commercial electronics

H-P introduces \$395 electronic slide rule

As if the electronic calculator market weren't crowded enough, the Hewlett-Packard Co. has entered with a machine of its own—but this one is different. Called the H-P 35, it's a shirt pocket portable that not only offers the usual four functions, but also has full logarithmic and trigonometric capabilities. The price is only \$395.

The only machines that come close to H-P's new electronic slide rule are the scientific/business machines by Wang, Tektronix, and H-P that sell in the \$2,000-\$4,000 range.

The H-P 35 employs five MOS chips, manufactured by American Microsystems Inc. in Santa Clara, Calif., and Mostek Inc. in Dallas, plus two bipolar display chips made by H-P. The new light-emitting-diode five-digit cluster unit is also made by H-P [see p.64].

The machine is extremely easy to

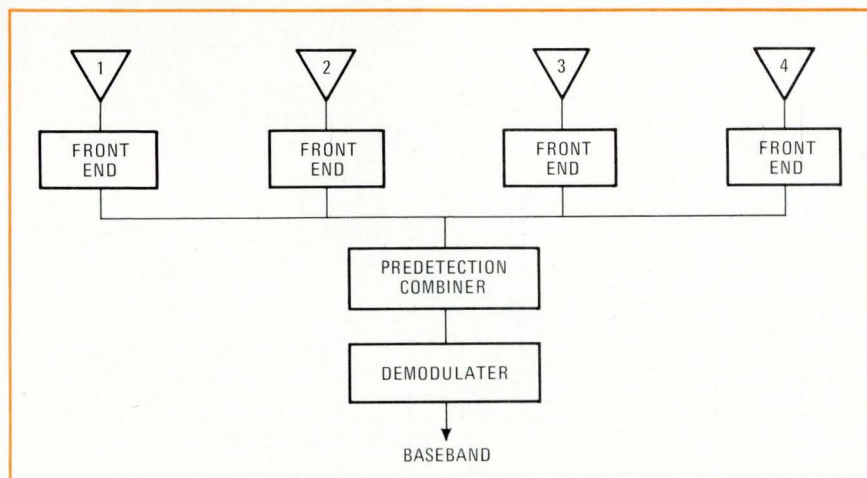

Cost cutter. Motorola's combiner can use less expensive antennas and replace steerable shipboard antenna often costing \$50,000 for satellite communications receiver system.

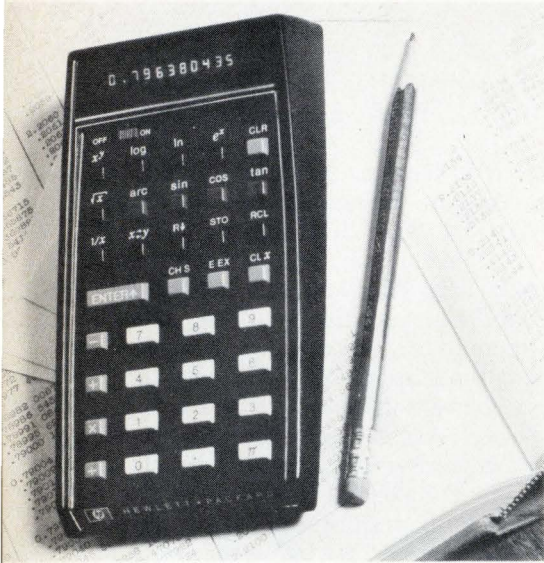

Slide rule. H-P 35 will do it all for \$395—trig, log, and four functions.

operate. Four internal registers permit complex calculations without forcing the user to write intermediate answers on scratch paper—subtotals are held in the registers until needed. A fifth register, or memory, stores constants. Answers are in decimal or scientific notation.

H-P's method of selling the electronic slide rule will be as unusual as the machine itself—at least for H-P. Direct mail will be used to reach as many as possible of the estimated 3 million potential customers, especially engineers, scientists, architects, and statisticians. A trial period will be allowed, and payment can be made with credit cards.

But while H-P may have the electronic slide rule market to itself for now, traditional slide rule makers are not too far behind. As long as six months ago, the Eugene Dietzgen Co. was working on such a machine and the Keuffel & Esser Co. is talking with several MOS makers.

Displays

Deformable film offers storage, display capability

Conventional storage cathode-ray tube systems can't project and require additional power for storage. But IBM researchers believe they

have overcome these disadvantages by using a deformable film in an evacuated chamber that's separate from the CRT's main vacuum chamber. The result is a so-called deformographic storage display tube, or DSDT [*Electronics*, Dec. 7, 1970, p.78].

Like a conventional storage tube, the DSDT can store an image for several hours without refreshing it. But unlike a conventional tube, the storage capability requires no power. Furthermore, the tube image can be projected on a screen with the aid of a schlieren optical system; in fact, the direct image isn't normally visible.

Two aims. Work on the basic deformographic tube was carried out at IBM's development laboratories in Kingston, N.Y. These laboratories, part of the System Development division, designed the tube for applications where refreshing the conventional CRT is a nuisance, or worse—notably in complex graphic displays. Meanwhile, at IBM's Federal Systems division laboratories in Oswego, N.Y., engineers are using the tube in display systems for military applications.

The DSDT's capabilities make the tube useful in display systems for group briefings and in large multipurpose consoles requiring images up to 5 feet in diameter to be displayed. The tube could be used in an airplane cockpit to project com-

puter-generated navigational information onto a separately projected map image. With conventional navigation systems, maps must be projected on aluminized phosphor inside the CRT which raises problems both in phosphor formulation and in projection system design.

Other applications include those combining several functions in one unit, which conventionally requires separate CRTs. The DSDT can be built in small sizes and can be used by any type of display scan; such projection CRT machines as the Eidophor are not only quite large but are limited to raster scans.

The new tube contains two vacuum chambers separated by a sheet of mica. In one of the chambers, which is essentially identical to a conventional non-storage CRT, an electron beam writes charge patterns on the mica surface. The other surface of the mica carries an elastic membrane topped by a conductive metal film. The charges stored on the underside of the mica sheet deform the elastic membrane and the metal film. These deformations are picked up by a beam of light reflected off the film and focused onto a viewing screen. The image is retained so long as the charges stay on the mica; because mica is an insulator, the charges can be retained for several hours.

On the other hand, the image can

Projectable storage tube. Deformable film plus schlieren optics makes display system with many advantages. IBM sees its deformographic tube going into complex graphic displays, or display systems for military applications—such as airplane cockpits as a navigation aid.

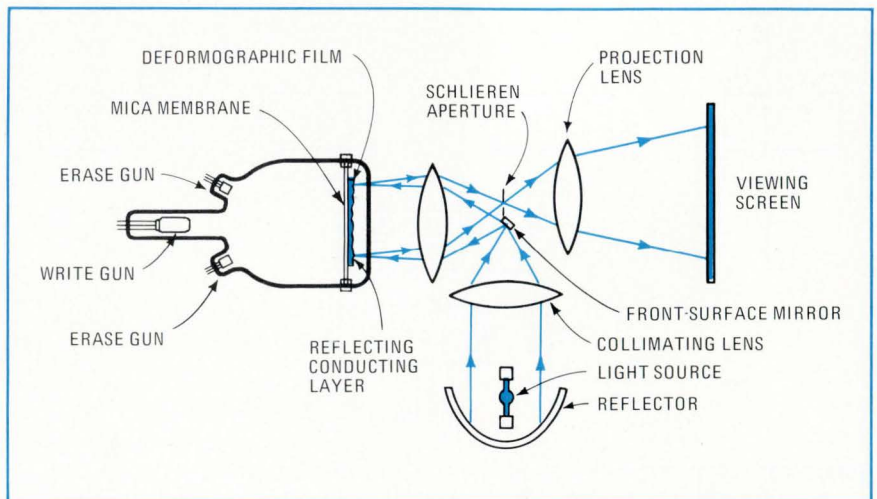

TEKTRONIX® GRAPHING TERMINAL

shatters

the
price
barrier

TIME
SHARING

MINI'S

360/370'S

\$3950
or less



NEW 4010—The new Tektronix 4010 Terminal is an engineering and business oriented computer display terminal with interactive graphing and alphanumeric capabilities. It is hardware and software operational with a host of popular mini-computers, with IBM 360/370 systems and presently with over 20 timesharing systems.

NEW LOW-COST—Scientific, engineering and business managers will find the TEKTRONIX 4010 Terminal the best price/performance answer for single and multiple interactive graphing terminal needs. The price of a 4010 is only \$3950, or it may be leased for \$190/month including maintenance. Quantity discounts tumble costs to as LOW as \$3358 each for 20 or more.

NEW PLOT-10—This new package provides extensive software capabilities in graphing and application interface routines. It provides you with a series of modules from which you can select elements best suited to your particular operating environment and application. New PLOT-10 lets your computer display more information in less time at much lower cost than ever before.

NEW 4610—The new 4610 Hard Copy Unit produces fast, inexpensive, high-resolution, high-contrast, permanent copies of the graphic and alphanumeric information displayed on the 4010-1. The easy-to-handle 8½ x 11-inch DRY copies are most convenient for documentation, communication, recording and filing uses.



TEKTRONIX®
excellence in
information display

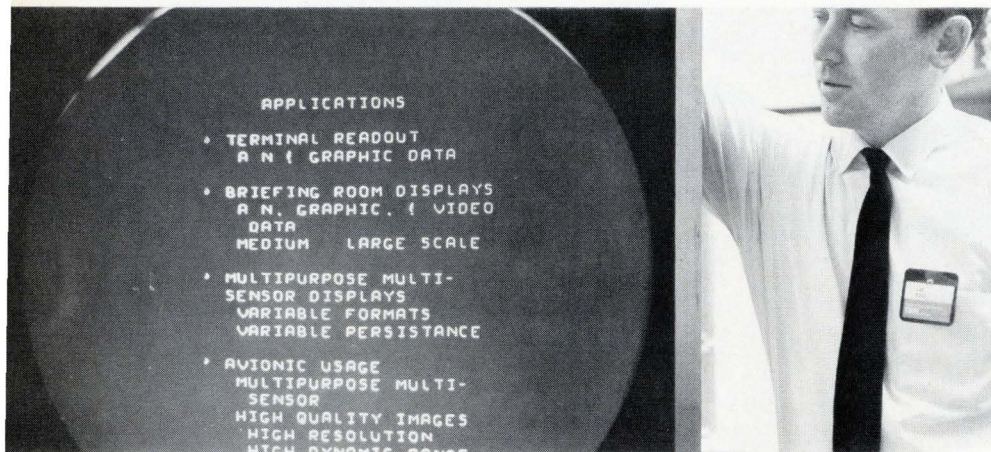

Big picture. IBM engineer Jim Ross poses with images projected by DSDT. Work was supported in part by Office of Naval Research, Rome Air Development Center, Wright-Patterson.

be neutralized by an erasing beam from a separate electron gun in the tube. This erasing beam effectively primes the mica surface for subsequent writing with the other beam.

By operating the erasing beam and the writing beam concurrently, a real-time dynamic display is possible.

In the absence of a stored image, the metal film is flat; light reflected from it misses the small aperture that is characteristic of schlieren optical systems, and the projection screen remains dark. But when an image deforms the film, light from the deformations passes through the aperture and projects an image on the screen.

Medical electronics

Defibrillator automatically shocks fluttering heart

Most deaths from coronary heart disease are not entirely unexpected. Nearly all result from electrical instability that culminates in fibrillation—a quivering motion of the heart muscle in which no useful pumping action is accomplished. While the heart can be defibrillated by application of a high-energy electrical pulse across the patient's chest, the treatment must start within a minute or two of the onset of the disorder.

To eliminate the usual delay in getting heart-attack victims to a hospital, Drs. Michel Mirowski and Morton Mower of Baltimore's Sinai Hospital have come up with an automatic defibrillator that holds forth great hope for reducing the number of deaths caused by coronary heart disease. The device is a transvenous electronic defibrillator that can automatically recognize and treat ventricular fibrillation in the high-risk patients in whom it would be implanted.

Outside circuitry. Basically, the device consists of two subsystems: a fibrillation detector and a countershock pulse generator. Both the detector and the electrodes for the countershock pulse generator are contained in a single catheter that is passed into the heart's right ventricle through the jugular vein. In the experimental work carried out thus far, the power supply and other circuitry have been outside the patient's body.

When the detector senses that the heart is fibrillating, it triggers the pulse generator. Since the countershock is applied directly to the heart, pulses with energies of only about 5 to 15 watt-seconds are required, in contrast to the 200 to 400 watt-seconds commonly used when the pulse is applied across the patient's chest.

Following a successful series of laboratory experiments on animals, clinical prototypes of the detector and countershock subsystems were

constructed by Medtronic Inc., of Minneapolis. The detector, which is undergoing testing in animals, monitors the mechanical action of the heart as well as its electrical activity. Both parameters must indicate fibrillation before the countershock circuitry is triggered.

The electrical signals are picked up through the countershock electrodes, while the mechanical action is sensed by measuring the resistance of a piece of flexible elastomer mounted in the catheter. As the heart contracts, it squeezes the elastomer and charges its resistance. During fibrillation, the heart merely quivers and exerts essentially no force on the sensor.

The countershock pulse-generating subsystem is undergoing clinical evaluation in a limited number of human patients. A Medtronic spokesman, said that it is still too early to comment on the results of this phase of the testing.

Area self-scanner to help the blind

The big semiconductor manufacturers, always looking for new markets to supplement sagging military and computer sales, are ever more frequently eyeing the medical industry as a lucrative outlet for their circuits. But the newer, smaller IC makers often react more quickly to new opportunities. Reticon Corp., the little company that makes self-scanning diode arrays in Mountain View, Calif., is an example.

Jumping at a chance to provide a useful service—an aid for the blind—as well as to address itself to a growing market, Reticon has developed a 1,024-element diode on a 32-by-32 matrix, the first self-scanning diode device to be built in an area configuration. The work was done for an institute for the blind.

High speed. Until now, only linear diode arrays have been available but an area device is necessary for sight aids because it does not require mechanical scanning, as do the linear devices. In fact, John Rado, president of Reticon, says of

**MULTI-TURN SETABILITY...
...AT SINGLE-TURN PRICES!
... IN A SQUARE PACKAGE!**

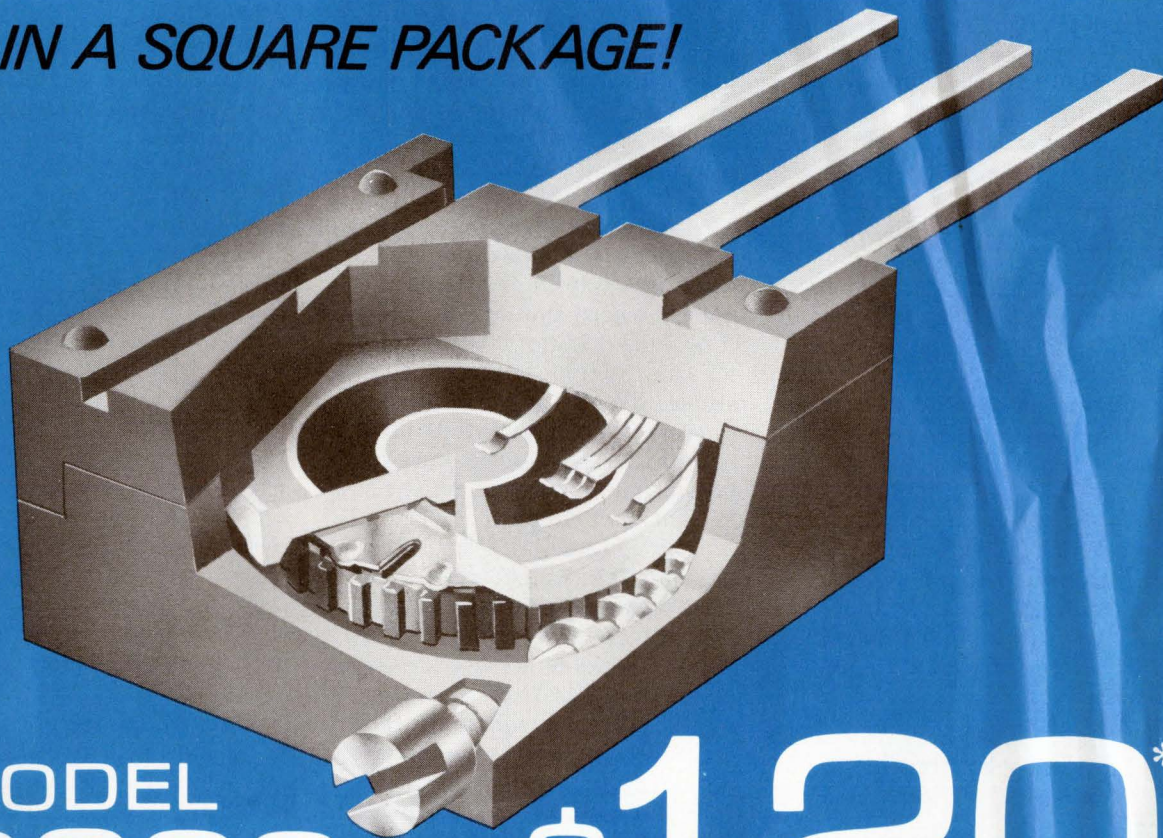

**MODEL
3299**

\$1.20*

*500-999 quantity

NEW CERMET TRIMPOT® POTENTIOMETER

THAT MAKES IT THE LOWEST-PRICED SQUARE MULTI-TURN ON THE MARKET.

In addition to low-cost, Bourns Model 3299 incorporates a number of features usually found only in higher-priced units.

PRECISE SETABILITY

... multi-turn adjustment provides quick, precise set-ability with infinite resolution.

POPULAR 3/8" SQUARE PACKAGE

... it occupies less space on the circuit board.

HIGH POWER RATING:

1/2 watt at 70°C.

CHOICE OF 3 PIN STYLES

... provides designers with the most popular pin styles for greater design flexibility.

MOLDED-IN TERMINALS

... enhance ruggedness of construction. Of course the unit is sealed to withstand printed circuit board cleaning processes.

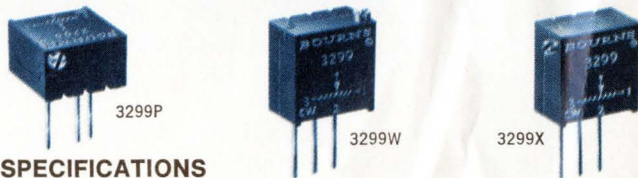

SPECIFICATIONS

Dimensions375" x .395" x .250"
Standard Resistance Range 100 to 1,000,000 ohms
Resistance Tolerance ±10% Standard
Power Rating0.5 Watts at 70°C
Operating Temperature Range -55 to +125°C
Temperature Coefficient ±150 ppm/°C

Delivery is off-the-shelf. Get full details on this new Cermet unit today by contacting your local Bourns Field Office, Representative, or the Factory direct.



BOURNS, INC., TRIMPOT PRODUCTS DIVISION • 1200 COLUMBIA AVE., RIVERSIDE, CALIF. 92507

the area unit, "It has the same high speed (10 megahertz) and self-scanning features as the linear devices. The masks are already made and we plan to deliver prototypes to the institute this month."

The diode elements in the array are on 4-mil centers—no easy achievement—with a total active area of only 7.5 square mils. Rado explains that the diode matrix, along with a small light and zoom lens, is mounted on glasses worn by the blind person. The scene, imaged onto the matrix, is scanned in the normal way. Electrical outputs are sent to a 32-by-32-element electrode pattern next to the skin on the wearer's back. In this manner, a one-for-one electrode stimulus is reproduced on the skin. The wearer, trained to interpret this pattern, reproduces the picture he "sees."

The device, with a dynamic range of 100 to 1, operates at 10 to 400 frames per second.

Space electronics

Shuttle means \$600 million for avionics competitors

White House approval of a \$5.5 billion space shuttle development program opens intense competition among aerospace and electronic systems manufacturers for the lucrative six-year development program. And NASA is wasting little time now that President Nixon has okayed the booster and orbiter combination craft—requests for proposals will be issued in the spring, and contractors will be chosen this summer to begin building the outer space bus due to operate by 1978.

The shuttle, which rekindles NASA's flickering manned space program [*Electronics*, Dec. 6, 1971, p. 42], should prove a boost also to electronics manufacturers because the electronics portion of the program is estimated at 15% to 20%. Although the program won't reach peak funding for several years, the avionics alone is estimated at \$600 million for the whole program.

Several remaining key decisions

are expected soon from NASA. For example, it hasn't been determined whether avionics development should be handled separately or as a subcontract from the prime contractor. However, William A. Summerfelt, the shuttle program office's director of engineering, says: "The odds are it'll be subcontract."

MSI circuits. Because of cost and reliability considerations, NASA won't be exploring much new technology where shuttle electronics is concerned. Most of it will be state of the art, Summerfelt says. For example, "We'll stay with MSI [medium-scale integration] because going to LSI [large-scale integration] doesn't buy us any more," he says. Weight isn't much of a factor because electronics is a small part of the shuttle's weight and, besides, "we have a pretty impressive achievement in reliability with MSI."

NASA hopes to achieve high levels of reliability and redundancy even as it keeps new technology development to a minimum. The DC-9-size orbiter, for example, will use "conventional aircraft" displays when it is flown back to earth and "next generation derivative" Apollo command module displays when it rockets from earth, says Summerfelt.

The shuttle's avionics money is "substantially down" from previous estimates when NASA wanted advanced systems integration with on-board data management, automatic checkout, and redundancy in the data bus [*Electronics*, Dec. 20, 1971]. Whereas NASA once talked about quadruple redundancy in some systems, it now sees triple redundancy as adequate.

It means jobs. The scaling down of the avionics matched the cost cut in the once-\$13 billion program as NASA fought to save it from White House skepticism. A major NASA argument was that the shuttle program would provide aerospace jobs, important in an election year, and a point repeated by Administrator James C. Fletcher after his meeting with the President. He estimated 50,000 persons would be directly employed, which comes to about 25% of those laid off because of space cutbacks in recent years.

Apparently saved, too, was the space station proposed to follow the shuttle program; this means that NASA's manned space program will continue well into the 1980s. But, since President Nixon also bought the shuttle because it "will take the astronomical costs out of astronautics," NASA must now produce the economical shuttle it sold.

Air traffic control

FAA ready to award training simulator contract

The Federal Aviation Administration's enroute air traffic control centers are to be converted to an automated alphanumeric radar tracking system by 1975. But it won't be possible to divert that system often enough to train developmental air traffic controllers—those lacking enough experience to qualify as journeymen. And even journeymen require separate equipment to prepare them for the automated system and to keep their skills honed once that system is in use.

That's why the FAA wants a training simulator, and at least nine companies bid last September when proposals were sought for one.

Worth \$5 million. An award, expected late this month or early next, could lead to \$5 million in business over three years for research and development of the prototype, plus production of up to 27 additional systems if the FAA exercises the full production option. The prototype is to be delivered within nine months of contractor selection.

The prototype and seven production systems would go to the FAA Academy in Oklahoma City, Okla., and 20 production simulators would go to various FAA air route traffic control centers around the country.

The simulator will be built around two major pieces of hardware—a radar display subsystem and a data processing subsystem. A minicomputer will be employed in the data-processing subsystem to present realistic problems and scenarios to trainees on the two cath-



cmos is important to your immediate future

It's going to change your product . . . your profitability . . . even your warranty. And if you're going to be in-business in the '70's . . . you're going to be in CMOS. So, stay ahead on this fast-paced technology . . . get the facts through our technical newsletter that covers CMOS and our wide range of both high and low threshold voltage PMOS circuits including RAMS, ROMS, standard low shift registers, D/A converters and character generators.

Give us a quick call today, and test our producibility.

Solitron Devices, Inc., P.O. Box 1416
San Diego, California 92112

Telephone 714/278-8780
TWX 910-335-1221



SAN DIEGO, CALIF.
8808 Balboa Ave.
CMOS, PMOS Circuits
Diodes, Rectifiers, &
Zeners
FET & Dual FET
Transistors
High Voltage Assemblies
Linear & Monolithic IC's

TAPPAN, N.Y.
256 Oak Tree Road
Diodes & Rectifiers
Ferrite & Ferrite Devices
High Voltage Assemblies
Power Rectifiers
Thick Film Hybrid Circuits

RIVERA BEACH, FLA.
1177 Blue Heron Blvd.
Hi-Rel Power Hybrids
Hi-Rel Power Transistors
PNP-NPN Ind. Transistors
Si & Ge Power Transistors

JUPITER, FLA.
1440 W. Indiantown
Road
Microwave IC's
Microwave Semi-
Conductor
Microwave Stripline
Components
RF Semiconductor

PORT SOLERNO, FLA.
Cove Road
Microwave Connectors
Plaxial (R) Cable
Precision RF Coaxial

BEN BAROQ ISRAEL
AEL Israel, Ltd.
Full line of Solitron
devices

KENT, ENGLAND
London Road,
Sevenoaks
Full line of Solitron
devices

TOKYO 105, JAPAN
Rm. No. 21, Kyodo Bldg.
No. 4-10, 2 Chome
Higashi Shinbashi
Minato-ku
Full line of Solitron devices

ADD ME TO YOUR FREE CMOS INFORMATION PROGRAM

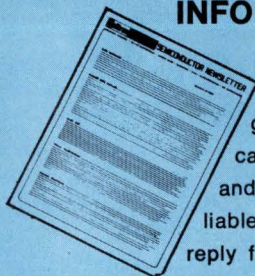

Stay ahead on technology . . . get the facts through our technical newsletter that covers CMOS and our complete line of highly reliable circuits. Fill out and return the reply form now.

Please add me to your FREE CMOS technical information program.

NAME:.....TITLE:.....
MAIL STATION:.....PHONE:.....EXT.....
COMPANY:.....
ADDRESS:.....
CITY:.....ZIP CODE:.....

I HAVE A REQUIREMENT FOR.....

IMMEDIATE NEXT 6 MONTHS
 HAVE SALES ENGINEER PHONE SEE ME

Check out your IC's in 3D

The images tell the story. No ordinary microscope gives you the wealth of in-depth detail revealed by the MAC SX-II scanning electron microscope.

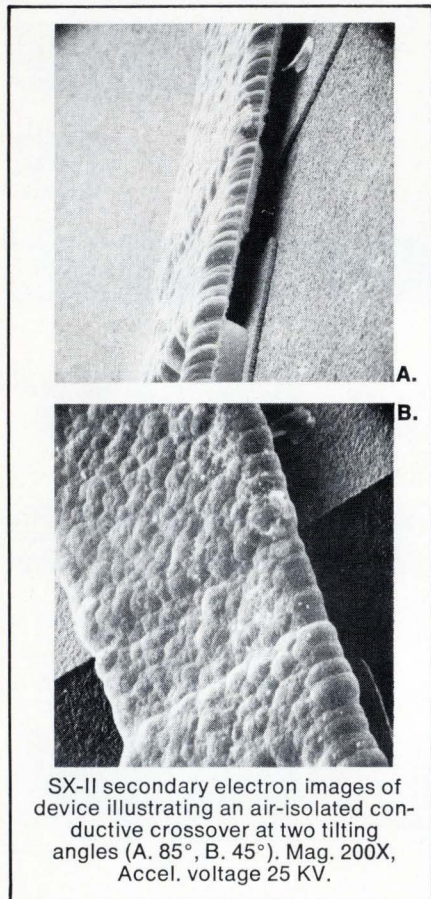

SX-II secondary electron images of device illustrating an air-isolated conductive crossover at two tilting angles (A. 85°, B. 45°). Mag. 200X, Accel. voltage 25 KV.

The SX-II conveniently accepts any wafer up to 3" diameter without cutting. Inspect your device from various angles using the scanner's 0 to 90° tilt feature. Defects and contaminants are rapidly and positively located, simple to photograph.

This high performance (150 Angstroms resolution) scanner is by far the best buy in its class—\$41,000. You can also lease the SX-II for less than \$1,000/month. For more details and/or a demonstration, call or write

MAC

MATERIALS ANALYSIS COMPANY

A Heath Techna Company

1060 East Meadow Circle, Palo Alto,
CA 94303 / Phone (415) 326-6556

Electronics review

ode-ray tubes, 22 inches in diameter, included in each radar display subsystem. Also included will be subsystems for target control and monitoring, video generation, beacon, and communications. Test and early delivery versions of the operational software and scenario generation programs round it out.

Bidders. FAA officials haven't divulged who bid, but industry insiders indicate that the list includes a team of Austin Electronics and Marconi from England; General Dynamics Corp.; Goodyear Aerospace Corp.; the Link division of Singer Co.; Logicon Inc.; LTV; GTE Sylvania; Univac; and possibly Philco-Ford. Sources believe the finalists, however, are Logicon, LTV, and possibly Link.

No matter who wins, though, the FAA is looking to the simulator to cut up to six months off the three and a half years it now takes to train an enroute developmental controller to full proficiency, and to upgrade more of the developmental personnel to journeyman status faster without sacrificing safety. Only a little more than a year ago, upwards of 5,000 FAA employees carried the developmental rank compared with only 3,981 fully rated journeymen.

An air traffic control career committee established in August 1960 regarded it "as urgent that FAA acquire simulation capability to permit training in enroute and terminal environments."

Computers

Radar, minicomputer tell
when to turn on the snow

A University of Nevada professor has designed a weather-control system using radar and a minicomputer to determine where and when clouds should be seeded to produce snow. The professor, John A. Kleppe of the university's Desert Research Institute in Reno, foresees the day when his system could be used to put a lid on hurricanes and lessen their intensity.

Kleppe is running a pilot project

to determine the feasibility of using his techniques to increase the annual snow pack in the Sierras.

Radar watch. The system works this way: the main eye, a remotely-controlled Bendix X-band weather radar, is placed at Squaw Peak, Calif. It employs the same decoder (dialer) as the controls of six silver iodide seeding generators. A preprocessor compresses the radar information into the bandwidth of an ordinary voice-grade telephone line. The information, received by a Digital Equipment Corp. PDP-8 at the desert institute, is reconstructed and displayed. From this data, a decision is made about which generator to turn on, and the machine is started by a signal on the line.

The vhf signal received by the generator is decoded into one of five possible functions. One function, for example, requests a status report on the generator's effectiveness. This causes the telemetry unit to activate a small vhf transmitter, which conveys the desired information to Squaw Peak Radio where, in turn, it is relayed via phone lines to the control center and displayed.

The institute also receives information from cloud-seeding aircraft and from field crews.

For the record

Show changes. Even as the IEEE's board of directors grapples with the problem of how to make the body more responsive to strong member desires for a semi-lobbying organization [*Electronics*, Jan. 3, p. 25], the institute has mapped major changes in its annual New York convention and exhibition.

That fixture has been suffering in recent years from decreased attendance. To counteract the problem, the managers of this year's show (March 20-23) are providing, among other things, company-sponsored seminars and an entire floor devoted to a science/technology center displaying only research projects.

The IEEE will also organize shows-within-the-show, with its exhibits relating to electronics packaging and medical electronics. In addition, exhibit booths will vary more in their



TRY 'EM...YOU'LL LIKE 'EM

Instant relief for design congestion: **Cherry Subminiature snap-action switches.**

When your design is afflicted with circuit congestion brought on by acute lack of space, here's the prescribed cure: Cherry 5 and 10 amp subminiature switches! Compact, easy-to-take size . . . refreshingly dependable coil spring action . . . plus long overtravel to combat assembly line headaches. You get Speedy snap-action relief in the dosage you prescribe: Either individual switches or space-saving multiple switch modules. Consultation available if design distress persists . . . Cherry diagnoses proven in over 160 million cases.

Try 'em: Send for free sample switch.
You'll like it.

CHERRY



TWX 910-235-1572 . . . or PHONE (312) 689-7600 . . . or WRITE:

CHERRY ELECTRICAL PRODUCTS CORP.
3608 Sunset Avenue, Waukegan, Illinois 60085

Makers of patented Leverwheel/Thumbwheel Switches, Matrix Selector Switches, Snap-Action Switches and Keyboards.

Circle 39 on reader service card

New rugged TO-5 relays ...sensitive, too!

A unique magnetic structure with larger diameter coil and integral return spring, and a new ball-bearing armature support provide increased stability and improved operating characteristics for these new Babcock TO-5 relays in high shock and vibration environments. This low level to 1 amp, DPDT,

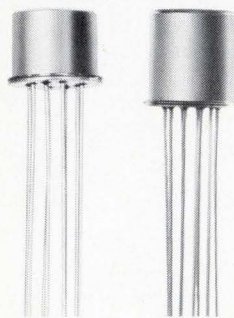

BR40

BR41

all-welded series (qualified to MIL-R-5757) is offered in 6, 9, 12, 18 and 26 VDC versions, and includes a sensitive model requiring only 60 mw pull-in. In low level applications, relay life can be as high as 10,000,000 operations.

For complete information on these new TO-5 relays, write or call Babcock Control Products, Babcock Electronics Corp., Sub. of Esterline Corp., 3501 No. Harbor Blvd., Costa Mesa, Calif. 92626; Tel: (714) 540-1234.



MIL-R-6106



MIL-R-5757



TIMERS/SENSORS



MERCURY WETTED



20A INDUSTRIAL



2A INDUSTRIAL

BABCOCK SUBSIDIARY OF ESTERLINE CORPORATION

ESTERLINE
Circle 141 on reader service card

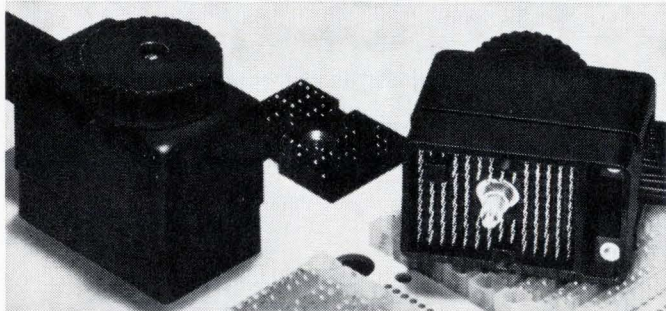

At last. An I/O connector designed exclusively for back panel assemblies.

Here it is. An input/output connector that features up to 120 crimp-removal contacts on a .100" grid which accepts #22 to #26 gage stranded wire.

The receptacle contacts, fixed to the panel half, can be supplied in numerous .025" wrap post lengths. The receptacle contacts are as precisely located as the rest of the back panel contacts, and automatic wiring presents no problem.

Get all the facts, write for free Bulletin No. I/O 100.

Gentlemen:
Please send me Bulletin No. I/O 100.

TERADYNE

Name _____

Company _____ Street _____

City _____ State _____ Zip _____

Teradyne Components, Inc., 900 Lawrence Street, Lowell, Mass. 01852

Electronics review

sizes and shapes and, finally, in a bow to the tight economics which probably plagued the show in the first place, exhibitors will be able to buy "free passes" for potential customers for only \$2 each—half of what they cost last year.

Thin film. Univac's Federal Systems division, St. Paul, Minn., is scheduled this month to deliver an oligatonic thin film memory to the National Aeronautics and Space Administration for evaluation for possible use in the space shuttle [see p. 36].

Univac engineer have been working on the concept for several years. The word "oligatonic," derived from the Greek for "a few atoms thick," describes a thin film of permalloy only 100 angstroms thick. Conventional thin films and the plating on plated wire are 1,000 angstroms thick. The technology has the potential of one-tenth the cost of semiconductor or ferrite core memories, and is especially attractive for military applications. It's capable of storage densities of up to 40,000 bits per square inch.

Ham in space. Along with entertainment tapes and, possibly, recorded videotapes, the astronauts who spend up to 56 days aboard the Skylab space station may have another source of relaxation—and a first in space.

AMSAT, the Amateur Satellite Corp., which has already arranged for the orbiting of an Australian amateur-made satellite, has proposed to NASA that Skylab include a small AMSAT-supplied single-side-band transceiver for the 10-meter amateur band.

Injury watch. Although only 39 hospital emergency rooms are reporting on-line to the Food and Drug Administration's National Electronic Injury Surveillance System, the \$1.8 million program is yielding results. "The data collected so far indicate a need for work on blenders, children's vaporizers, and joiner-planers," says Director Malcolm W. Jensen. By February, 118 hospitals will have signed up.



The Ultimate Network/Circuit Test System There's something in it for you

... a faster, lower-cost way to perform analog tests, logic tests, and passive tests. Take your pick of any combination to measure (simultaneously, if you wish) analog, hybrid and digital pc boards; active and passive networks; hybrid IC's; active, passive and digital components. But, get only the capabilities you need now. Don't worry about adding more later; we've already made provision for

expansion with modular hardware and software. Here's the big difference between our system and others. The measurement units in GR Systems 2200 are modules, especially designed for computer control. They are not automatic instruments adapted for computer control but unique modules that do their jobs faster than instruments. There's no time wasted translat-

ing commands, driving readouts, and the like. You get faster testing, increased throughput, and over-all cost savings in your test operations.

The "ultimate" system illustrated was designed and built for a giant electronics manufacturer who needed 10-station capability to handle a huge volume. Almost everybody's testing requirements, however, can be satisfied with a single-station system, selecting from the several modules already designed for the 10-station ultimate.

Let's talk about what GR can do for you. Write or call your GR sales engineer or GR, Concord, Mass. In Europe write Postfach CH 8034, Zurich, Switzerland.



General Radio

NEW YORK (N.Y.) 212 964-2722 (N.J.) 201 791-8990 • BOSTON 617 646-0550
CHICAGO 312 992-0800 • WASHINGTON, D.C. 301 881-5333 • LOS ANGELES 714 540-9830
TORONTO 416 252-3395 • ZÜRICH (01) 55 24 20
GRASON-STADLER 617 369-3787 • TIME/DATA 415 327-8322

Scanbe takes the gamble out of the card game.

Our card files provide a sure thing for mounting your P.C. cards. The well known secret to Scanbe's system is the nylon guides with integral mounting feet to insure precise card/connector alignment. The guides are fixed on extruded aluminum bars between end plates or drawer frames. The extruded aluminum mounting bars offer exceptional rigidity, yet the files are rugged and lightweight.

Configurations are virtually unlimited . . . files, kits, drawers, both vertical and horizontal, and fully wired systems. Also, this truly universal system offers any card/connector combination, any card spacing with single and multi row designs. Let our application engineers give you a winning hand for all your packaging needs. For the solution to your packaging problems, contact "The Packaging People" at Scanbe.



SCANBE MANUFACTURING CORP.

"The Packaging People"

3445 Fletcher Avenue
El Monte, California 91731
Telephone (213) 579-2300

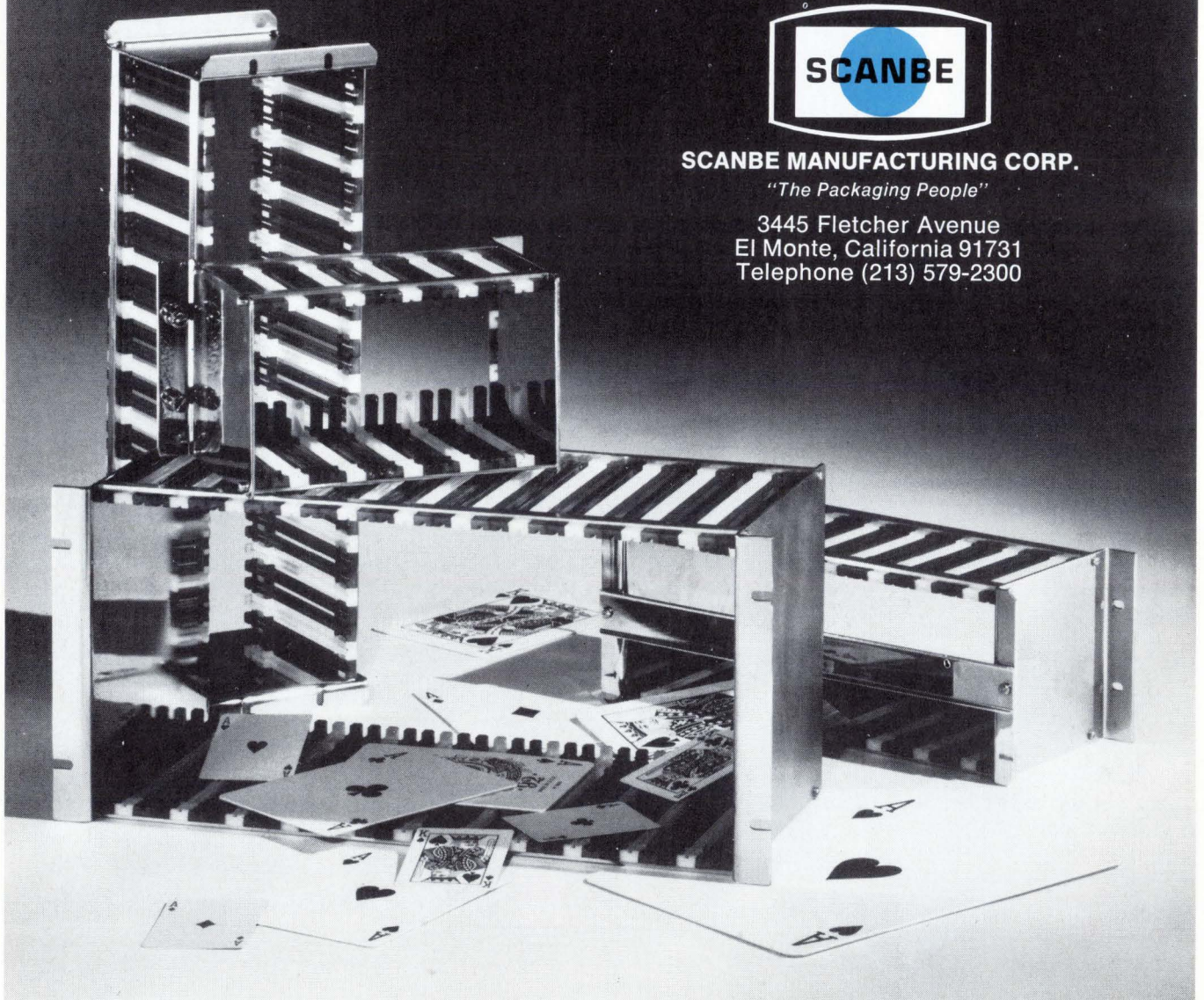

Washington Newsletter

January 17, 1972

Congress weighs a water borne FAA...

Congress will almost certainly give the U.S. Coast Guard much the same power over congested harbors and waterways as the Federal Aviation Administration has over the nation's airways. Under a bill presently being considered, the Coast Guard would "establish, operate, and maintain vessel traffic systems," and require ships in harbors to comply with the system by installing electronic and other necessary devices. The bill has already passed the House, and the Senate Commerce Committee is expected to vote on it in February, says one key committee staffer. Some subsequent legislation and rule making would be needed to create the traffic system for which the bill provides the groundwork, the aide adds.

... but Coast Guard makes haste slowly

The Coast Guard appears reluctant to become a water borne FAA and would prefer to "proceed at a sedate pace," says one high-placed officer. However, it is installing an experimental computer-directed radar system in San Francisco harbor and has a less sophisticated system about to go into operation in Puget Sound, Wash. Observers say the service will eventually establish harbor traffic systems to cope with the increasing number of commercial and pleasure craft. These should provide a small electronics bonanza, especially if pleasure craft have to be equipped with transponders to use them.

LEAA electronics contracts may go to Government labs

Major changes in the way the Law Enforcement Assistance Administration does its business may put a damper on electronics companies hoping to break into potentially lucrative law enforcement markets. The National Institute of Law Enforcement and Criminal Justice, the agency's R&D arm, expects to announce equipment priorities "imminently," says Martin Dansiger, new head of the institute. Since the beginning of the fiscal year, when Dansiger took over the group, it has yet to spend any of its budget for new equipment projects, although Congress tripled its funding from \$7.5 to \$21 million.

With more money and essentially identical staff capabilities, the institute is expected to give out fewer, but much larger, grants for hardware development. "LEAA wants to act like a prime contractor and have as few vendors as possible," says an agency insider, who adds that after work on current development projects is concluded, the institute may make as few as three awards per year, possibly to laboratories at NASA, the Defense Department, and the National Bureau of Standards. Electronics companies may be slighted in the institute's new plan: LEAA has lost its top electronics and communications staffer, Walter Key, and reportedly has no plans to replace him.

Addenda

Future military aviation R&D policy and priorities are to be studied by a committee that the National Aeronautics and Space Administration, the Defense Department and other agencies will set up—probably in early spring, says a knowledgeable NASA source. . . . The call by Sen. Walter F. Mondale (D., Minn.) for the anti-supersonic transport coalition to defeat the \$5.5 billion space shuttle project is unlikely to succeed, say Capitol Hill observers. They don't see an election-year Congress turning down a job-producing program.

Washington Commentary

New U.S. trade policies for a changing world . . .

"Free trade is not a principle," declared Benjamin Disraeli, "it is an expedient." The truth of that British Prime Minister's assertion some 129 years ago has come back to haunt the United States today. **The open trade policies that were expedient for a country anxious to aid others devastated by World War 2 brought the nation in 1971 its first negative trade balance in more than a century.** As a promising first step toward restoring that balance—in which the value of U.S. exports of computers, avionics and components still exceeds consumer electronics imports—**President Nixon has negotiated his international monetary agreements.**

Now industry is asking, "What next?" The most likely answer will be derived from three separate but related Federal efforts examining the diplomatic, financial and technological requirements for making American electronics technology competitive in the world marketplace.

At the Department of Commerce, Secretary Maurice Stans wants to **build new markets for commercial and industrial hardware in the Soviet Union and Eastern Europe,** a goal supported by the Electronic Industries Association.

At the Treasury, **a major internal study is nearing completion on international technology transfer and its impact on the national economy.** That effort could go far to explain how and why American companies, their overseas subsidiaries, and foreign competitors exploit electronics and other technologies by direct investment and licensing.

The third project is the much-discussed effort directed by Presidential assistant William Magruder and designed to **spur U.S. corporate R&D by a combination of direct and indirect Federal subsidies.**

Though each of these programs appeals in varying degrees to electronics manufacturers, American labor is definitely unhappy with the trend toward exporting U.S. electronics technology and the jobs that go with it. "American companies have been exporting American technology, and this is technology frequently developed at the cost of the American taxpayer," contends AFL-CIO research chief Nathaniel Goldfinger. And by using U.S. capital to build plants abroad, he adds, "we have already displaced considerable U.S. production."

. . . emphasize plans to promote innovative technology

The solution to retaining a competitive position in the world market for commercial and industrial electronics without exporting technology and the jobs it provides will require major changes in Government operations and laws, according to manufacturers' inputs to Government.

Specifically, they see a need for: modernized antitrust statutes to permit joint R&D ventures to cut the costs, risks and lead times associated with development of new electronic products—products whose lifetimes are shortened by rapidly changing technology; greater uniformity in engineering standards—a goal that also would require changes in antitrust laws, and probably the substitution of performance standards for material standards; and, finally, a single Federal group able to evaluate and forecast the potential for electronics and other high technologies in world markets.

Do such calls for new trade expedients imply greater Federal control of American technology? "A totally passive role by the Government is no longer appropriate," replies one ranking official at Commerce. Though innovation and competitive interaction will still lie within the private sector, he explains, the Government should be prepared to encourage declining industries. **Thus does the answer on controls become "no" for a highly competitive electronics industry—so long as it can also remain competitive in world markets.**

—Ray Connolly

The new Merlin 1[®] connector.

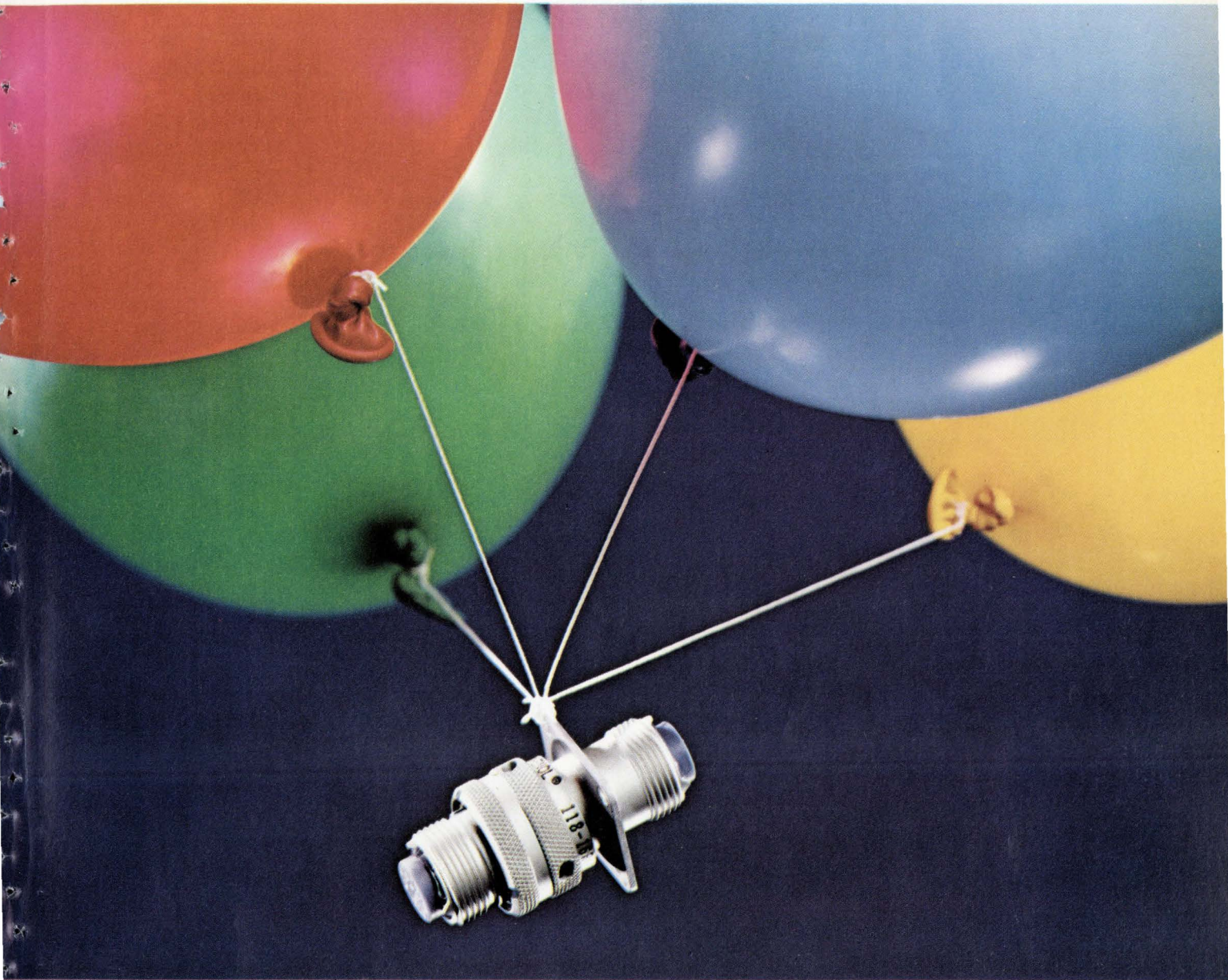

40% lighter than anybody else's.

Through the magic of Amphenol engineering we now bring you a rear-release, cylindrical, environmental connector that is not only 40% lighter than competition, but 1/2-inch shorter than most.

A one-piece thermoplastic retention disc, molded of tough Astrel 360* replaces the individual metal retention clips common in heavier connectors. Therefore, a 61-pin Merlin configuration has one retention disc instead of 61 individual metal clips. The result is a lot less useless weight. And, without all those parts, more reliability.

Adds a little magic to cost-cutting, too.

Our new Merlin exceeds all performance requirements of MIL-C-83723, MIL-C-26482 and NAS-1599 and is fully intermateable and intermountable with all three of these types.

Shell sizes are available in the eight most popular configurations with your choice of straight plug and both wall-mounted or jam-nut receptacles.

To get the full story on the new Merlin 1 connectors, just write or call Steve Kelleher, Amphenol Connector Division, Bunker Ramo Corporation, 2801 S. 25th Avenue, Broadview, Ill. 60153, (312) 261-2000.

*Registered Trade Mark 3M Company.



AMPHENOL

Circle 45 on reader service card

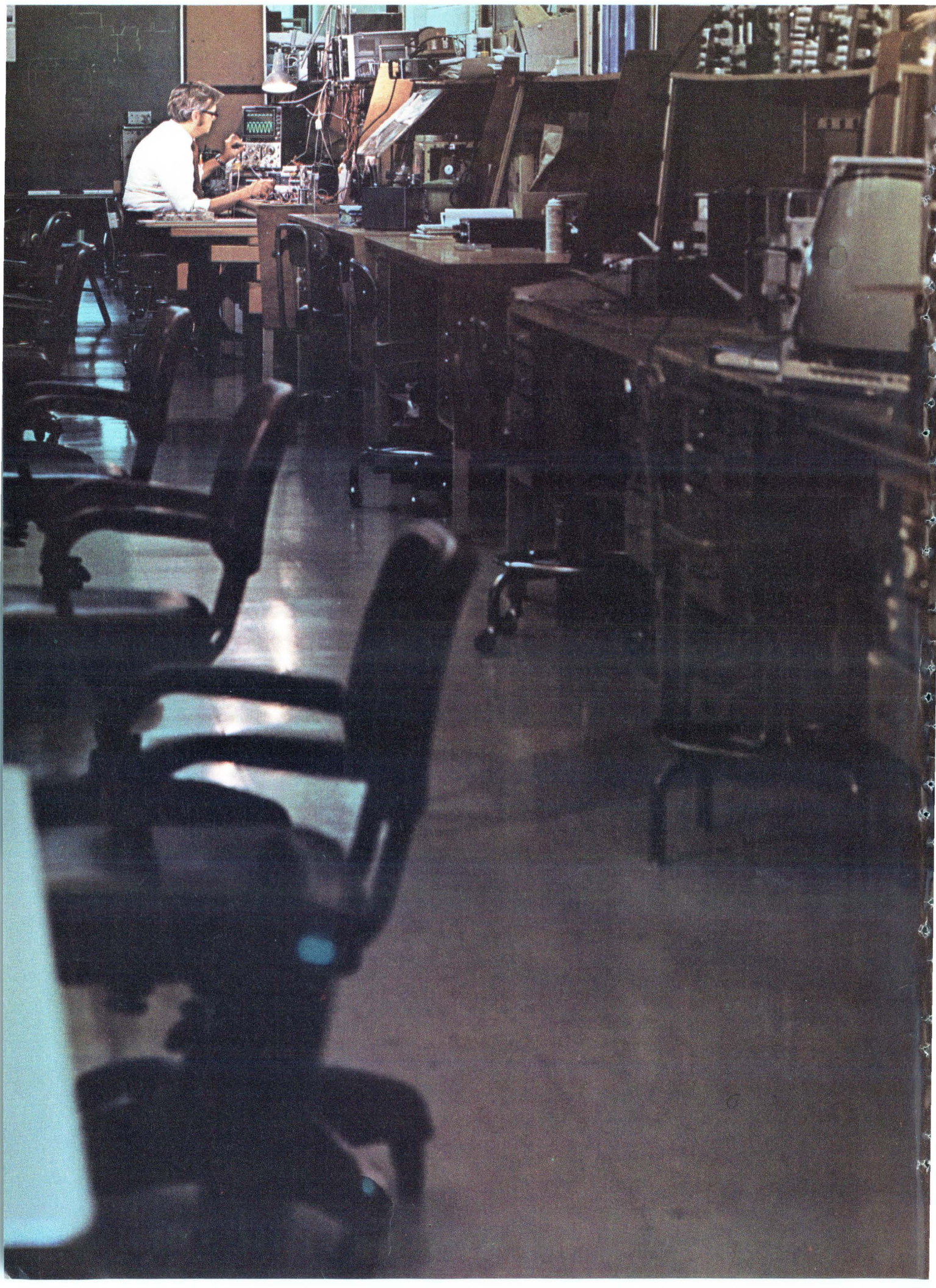

Think Twice:

If your job depends on your ability to make measurements... check out HP's new scopes.

You owe it to yourself. The days of the "gravy train" in the electronics industry are over. Today, you have to do a really outstanding job to get ahead—or even just to hold on to what you've already got.

That's why it's imperative that you *double-check* before making purchase decisions today — especially decisions on something as important as a new scope. Because, if you *do* make comparisons between the available alternatives, you'll be in an unassailable position to justify your choice — whatever it is — and in a pretty poor position, if you don't.

This is important because, today, as never before, you're going to be judged on your ability to do the best possible job at the lowest possible cost. Pinched for profits, management is now demanding hard-nosed justifications for every decision. They're examining *total acquisition costs*, as they've never done before.

As a result, doing things just because "you've always done them that way" can be deadly. Because now, it's a whole new ball game. The old reasons for "sticking with the tried and true" are out the window.

Take scopes, for instance. The cur-

rent generation is so different from the last generation that the decision to buy *any* new scope—whether ours or our competitor's—involves a whole battery of related changes. New test procedures. New calibration setups. New parts inventories.

Thus, to be sure that you're getting the best buy, in terms of performance vs. total acquisition cost, you should thoroughly check *both* manufacturers' offerings.

Check prices. Find out exactly how much it will cost to get the measurement capabilities you need, including all accessories. In many cases, you'll find that Hewlett-Packard can save you a significant amount.

Check Performance. Call us for a "hands-on" demonstration of the scopes or systems that are *most relevant to your particular needs*. Remember—what counts is the ability to meet *your* frequency, accuracy, and sensitivity requirements...not technological "fireworks displays" in areas far from your own concerns.

Check ease of use. Compare simplicity of controls, display size, error-prevention devices. Does the scope you're considering have *useful, time-saving* features, like selectable input

impedance, variable persistence storage, bandwidth to meet your current and near-future requirements, and simplified sampling...or just flashy "bells and whistles" that add little to usability, and a lot to the price?

When you make these comparisons, we think you'll choose Hewlett-Packard. We've found that once people get the facts, they usually do. For a revealing package of information on H-P's new scopes, send for a free copy of our "No-Nonsense Guide to Oscilloscope Selection." Or contact your local H-P field engineer for a demonstration. Check before you choose. Hewlett-Packard, Palo Alto, California 94304. In Europe: 1217 Meyrin-Geneva, Switzerland.

**Scopes Are Changing;
Think Twice.**

082/1

HEWLETT  PACKARD

O S C I L L O S C O P E S
Circle 47 on reader service card

Ingersoll-Rand



Panel courtesy of Elco Cer

"Rapps" it up.

It figures. I-R, one of the pioneers in the development of wire wrappers, has everything you need for time-saving, cost-conscious operation in the electronics industry.

Forexample? *Perma-Rapp*® ... wire wrappers with features that make the competition look obsolete. Featherweight tools (as little as 17 ounces) that keep production rates up, keep fatigue and errors down. And those high-power motors make child's play out of jobs involving a wide range of wire sizes. Positive power-driven homing, too, for simplified wire insertion. Fingertip speed adjustment. Full-circle indexing, adjustable through 360°. All this in a simplified 2-pack construction that uses fewer parts than many competitive tools... but works a lot harder. Both air

and electric models are compact, smooth-running, and built to keep noise and vibration down.

Want more? I-R has it. A complete range of wire wrapping bits, sleeves and accessories. Including attachments for cutting and stripping.

Perma-Rapp® wire un-

wrapping tools. An anti-back-force device. Options that can triple the versatility of the tools. And, of course, worldwide servicing available for all products in the line.

These great little performers are part of Ingersoll-Rand's wide selection of products for the electronics market. Miniature screw drivers and grinders. Drills. Tool Balancers. Automatic screw drivers. Rapid Automatic Drills.

Want the complete story? Write to Ed Julander, Product Manager, Electronics Industry, Ingersoll-Rand, 28 Kennedy Blvd., E. Brunswick, N.J. 08816.

SEE I-R at
**NEPCON
'72 WEST**

Booth 261
Anaheim, California
Feb. 8-10

Circle 244 on Reader Service Card

1971-2071



CENTURY II

Ingersoll-Rand

Only Electronics takes you into all 5 audience dimensions

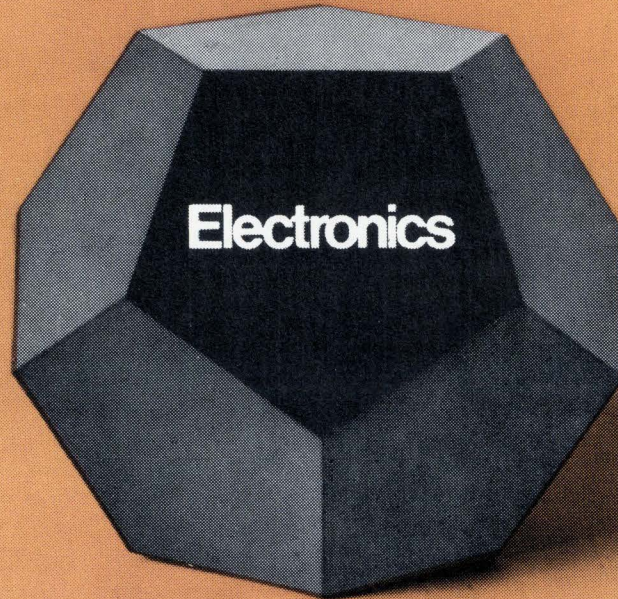

**1. Management Dimension 2. Technical Dimension 3. International Dimension
4. Purchasing Dimension 5. Reader Involvement Dimension**

New reader profile study highlights the power of *Electronics* readers in five key areas. These are the people you must reach to move a product or a service in the worldwide electronics markets today—and tomorrow.

If you want to know just how powerful a magazine is as an advertising medium, ask its readers. We did. Here's what they said.

1. *Electronics* subscribers are vitally important to their companies, and therefore must be important to you: 58,000 (67%) have a management responsibility. 48,000 (56%) are responsible for their companies' profit. 68,000 (79%) travel on business for their companies — 31% make more than 7 trips per year.

2. *Electronics* subscribers are determining the technical and business futures of their companies. They're also determining yours: 70,000 (81%) have engineering job functions. 69,000 (80%) participate in business, product or technology planning.

74,000 (86%) do or supervise design work.

3. *Electronics* subscribers are where you need them: 76,000 (88%) work in the worldwide electronics original equipment market. 7,600 (9%) more, work in vital "user" markets. 44,000 (52%) work in the five major growth markets of the '70's—computers, communications, instrumentation, industrial controls and consumer products.

4. *Electronics* subscribers buy your products: 73,000 (85%) select vendors. 23,000 (26%) recommend, approve or

specify purchases in excess of \$100,000 per year.

70,000 (82%) buy passive components.

71,000 (83%) buy control and display components.

77,000 (90%) buy active components.

75,000 (88%) buy instruments and test equipment.

5. *Electronics* subscribers depend on *Electronics*:

55,000 (64%) read it at home.

41,000 (48%) spend more than one hour reading each issue.

25,000 (29%) do not read *any* of the next six publications in the field.

55,000 (64%) do not read the second publication in the field.

68,000 (79%) do not read the third publication in the field.

It all adds up to this one crucial point—a magazine's power is only as great as the power of its readers. Only *Electronics* takes you into all 5 audience dimensions. For complete details on this new reader profile study, contact your nearest *Electronics* advertising district manager.

Reach the buyers for your product where they're at.

Beginning with the January 3, 1972 issue, *Electronics* offers advertisers four different market-coverage opportunities.

a. Full-Run. Advertisers may reach the *Electronics* worldwide audience of 86,000 with one advertising message. Full-run advertising rates are lowest on a cost-per-thousand basis. Full-run space earns frequency discounts for all other options.

b. Full-Run, Copy Split. Advertisers may reach *Electronics* worldwide audience with two or more advertising messages. Full-run rates apply, plus split-run charge. A standard domestic-overseas split is available at low charge. Full-run split advertising space earns frequency discounts for other options.

c. International Advertising. Advertisers may elect to reach only the *Electronics* overseas audience of 16,000 through the International Advertising Section, which is available in all issues. IAS space earns frequency discounts only for IAS advertising.

d. Domestic Advertising. Advertisers may elect to reach only the *Electronics* U.S. and Canadian audience. This option is available every issue but publisher reserves the right to restrict space to 12 pages per issue. Space units of full page or larger only. Domestic advertising space earns frequency discounts for domestic advertising only.

Electronics offers free proof of advertising effectiveness.

For 1972, *Electronics* offers you a free inquiry follow-up service—Buyer Action Measurement (BAM). It can determine for you just where the buying action is for your product. BAM has a tremendous memory bank which enables you to get unusual and critical information on products you advertise. And, *Electronics* is the only magazine in its field to offer any such service with BAM's capability. Here's how BAM works:

1. When a prospective buyer circles a number on the *Electronics* Reader Service Card, he also checks off his industry classification. When the card is received by BAM, the information is stored in the computer. Questionnaires are then mailed to the requestees to determine the action taken. The response to these questionnaires is also stored in the computer.

2. BAM then produces a printout table

that tells you number of requests for information, number of questionnaires returned from requestees, the percent of response, five types of action taken by respondents, number and percent of sales actions taken—all broken down by *industry classification*.

3. In addition, BAM gives you a comparison report showing the action taken by your customers and prospects on *all similar products* to yours that were advertised in the same issue.

4. And, as a final service, BAM offers a *cumulative comparison report*, by product, of all the issues studied. From this, you can determine where the

sales actions for your type of product come from over a period of time.

Electronics offers AD COM—Advertising Communications Evaluation—the most comprehensive advertising readership service available anywhere. It tells you, through 100 personal interviews, the percent of respondents who remembered seeing your ad and remembered reading it. It also tells you whether your message got through and whether it was believable. Finally, it tells you the percentage of readers who took or plan to take action as a result of reading your advertisement.

1972 ADVERTISING SCHEDULING GUIDE

Use this convenient advertising scheduling guide to take full advantage of special issues and reports, as well as those issues which are scheduled for BAM and

AD COM. You will be notified well in advance of closing dates of the additional special reports and studies as they become scheduled.

ISSUE	CLOSING	CYCLES	SPECIAL REPORTS	BAM	AD COM
Jan 3	Dec 10	A	Annual U.S. Markets Report	✓	
Jan 17	Dec 24	B			✓
Jan 31	Jan 7	A		✓	
Feb 14	Jan 21	B		✓	
Feb 28	Feb 4	A			✓
Mar 13	Feb 18	B	IEEE Preview		
Mar 27	Mar 3	A		✓	
Apr 10	Mar 17	B			✓
Apr 24	Mar 31	A			
May 8	Apr 14	B		✓	
May 22	Apr 28	A			✓
June 5	May 12	B		✓	
June 19	May 26	A			
Jul 3	June 9	B			✓
Jul 17	June 23	A			
Jul 31	Jul 7	B			
Aug 14	Jul 21	A			✓
Aug 28	Aug 4	B			
Sept 11	Aug 18	A	Wescon Preview		
Sept 25	Sept 1	B			
Oct 9	Sept 15	A			
Oct 23	Sept 29	B			
Nov 6	Oct 13	A			
Nov 20	Oct 27	B	Japan Markets Report		
Dec 4	Nov 10	A			
Dec 18	Nov 24	B	European Markets		

TOTAL PAGES SCHEDULED _____

Get the whole picture.

For the total picture of what the five-dimensional audience of *Electronics* can do for you, contact your local *Electronics* district manager.

That's also where you can get a complete copy of our new International Profile Study, as well as the recently-completed European Product Preference Poll and the domestic

Product Preference poll. Plus the 1972 *Electronics* rate card.

You can't sell to the world's electronics markets unless you reach all five audience dimensions.

Electronics
The International Magazine
of Electronics Technology

Try our straightforward method of reducing fixed resistor costs.

Uniform manufacturing process results in consistent quality that lowers your installed cost. And cuts down unnecessary after-purchase expenses. As a result, some of our customers have been able to discontinue incoming inspection. The unique

Allen-Bradley hot-molding process minimizes the variations that make ordinary resistors noisy, thermally sensitive, and poor on power handling ability. If you think all resistors are the same, read: "7 ways to tell the difference in fixed resistors."

Free from your A-B distributor, or write to: Allen-Bradley Electronics Division, 1201 South Second Street, Milwaukee, Wisconsin 53204. Export: Bloomfield, New Jersey 07003. Canada: Galt, Ontario. United Kingdom: Bletchley, Bucks.

ALLEN-BRADLEY
QUALITY ELECTRONIC COMPONENTS



Technical articles

Radar car control systems point way to automated travel: p. 54

Faster, safer travel on the interstate highways is the goal of programs for automatic car control. But the automotive environment presents severe thermal and mechanical problems. Author William Harokopus describes two versions of an adaptive speed control radar system, which uses thermistor-sensistor compensation and a non-microphonic mixer but is as yet too costly for mass production.

Cache memories promise economies for large computer designs: p. 58

"Generally speaking, the larger the main memory of a system, the more attractive the use of a cache becomes," maintains author Robert M. Meade, "because the system can then use a less expensive and slower backing memory." This is true even of multiprocessors, where caches can be attached to the individual processors, and multiprogramming systems, since a program changeover does not demand complete emptying and refilling of the cache.

Five figures on a chip fit hand-sized instrument displays: p. 64

If a pocket-sized electronic instrument is also to be only a small out-of-pocket expense, it will need a small, inexpensive and reliable numeric display. A plastic lens over a gallium-arsenide-phosphide LED chip creates a 5-digit display that, say authors R. W. Soshea and R. L. Steward, is highly legible yet low-cost. Strobed operation adds to its luminous efficiency.

The cover: The day approaches when multi-digit displays, like these from Hewlett-Packard, will be almost as cheap as candy.

Vhf solid state amplifier achieves 1-kilowatt power level: p. 72

Airborne communications transmitters, which need to be economical in their use of power, are an ideal application for this all-solid-state amplifier, says author Louis W. Simon. Tests show it can have twice the efficiency of vacuum tubes.

The return of diode switching matrices: p. 76

Once again it's proving a good idea to use diode gates with TTL or DTL circuitry, now that high-noise-immunity logic families are available. As David Guzman, the author, points out, "substituting a simple diode gate can reduce parts cost—often by a factor of four."

Trimmers are far from losing their grip: p. 79

Though designers would like to use only fixed-value components in their circuits, manufacturers keep producing small, better and less expensive adjustable-resistance trimmers. Special issues editor Harry R. Karp explores the many varieties available for today's needs.

And in the next issue . . .

A novel display for a wristwatch . . . monolithic crystal filters for communications . . . designing hf logarithmic amplifiers.

Radar hits road, but it's a costly ride

Two car radars have been tested in adaptive speed control systems that had to meet severe auto environment

by William P. Harokopus,
Bendix Research Laboratories, Southfield, Mich.

□ Designing an automatic pilot for automobiles requires nearly as much courage and daring as driving down a busy highway for the first time in an expensive car that has its speed and braking controlled by radar. While few have taken the ride or tried the design, this boldness has met some sobering tests on the drawing board. And in the Adaptive Speed Control (ASC) radar system, designed by Bendix Corp. Research Laboratories, some unique design tradeoffs have resulted.

Only the first step toward gradual implementation of the automatic vehicle control considered necessary for improved traffic flow and safety, this development program has for its ultimate goal more efficient use of highways. During the next decade, according to current projections, gradual upgrading of the interstate highway system for automatic car control will probably begin.

One proposal has been to add a new lane to offer right-of-way only to automatically controlled vehicles. Longitudinal control has been developed, and latitudinal control—to keep cars in the proper lanes—has also been demonstrated experimentally. Using the two control systems, traffic could be stacked automatically, with cars maintaining safe intervals, despite high speeds.

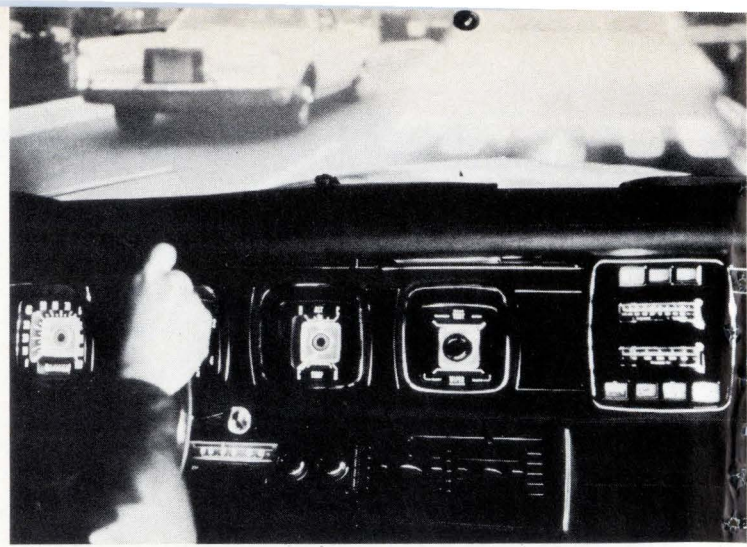

The automatic traffic pattern may require both a radar control and another redundant control, such as cable connection to the vehicle. Individual car-by-car control, however, is an important first step in the introduction of electronic highways, since it will be impossible to convert overnight the national road network.

Engineers challenged

While today's automobile presents a tremendous opportunity for application of electronic devices—not only for radar equipment, but also other controls—the automotive environment is severe. Temperature ranges are fierce, going from -40°F to $+250^{\circ}\text{F}$.

Perhaps the most significant stress imposed by the automobile environment is extreme temperature shock. When started, an engine cold-soaked at -40°F begins radiating heat rapidly, and this change may be repeated several times a day—thus playing havoc with electronic components and connections.

Then there are mechanical shock forces—which can reach 30 g—normally amounting to about 10 g. Jacking up component costs to this Mil-Spec level is unthinkable in Detroit, so high cost must be overcome if

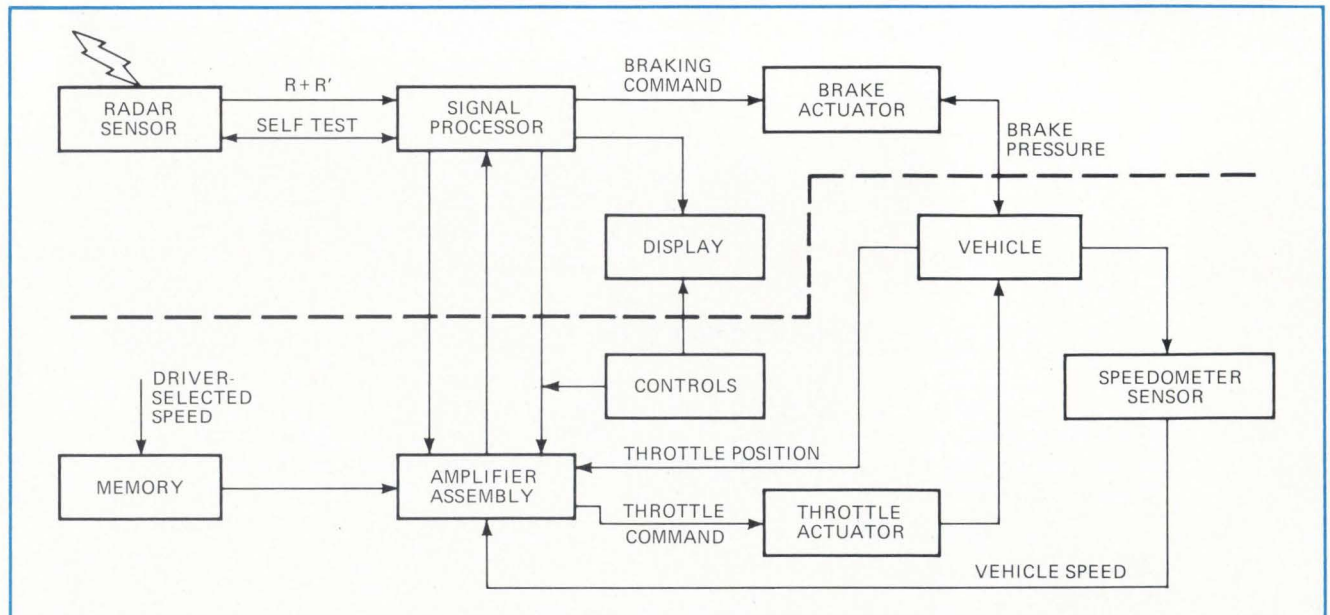

1. Speed trap. This radar system, designed for economical control of automobile speed and braking, acquires targets at 300 feet, processes the distance to a lead vehicle, and automatically adjusts to maintain a safe distance in moderately heavy traffic, even at high speeds.

electronic control is to be successful. In addition, space on and behind the automobile dashboard is becoming scarce because of competition from other electronic controls and entertainment systems.

The automobile environment is a formidable challenge to electronics engineers. The difficulties are suggested by the environmental conditions listed in the table to the right. In addition, electrical problems arise from variations in steady-state and transient voltage levels characteristic of the automobile's electrical system. Add to this the electromagnetic radiation that may be coupled into the system, and the design road blocks become more difficult to cross.

Systems combined

A speed control system—in a version originally developed by the Bendix Automotive Electronics division as a driver convenience option on 1969 Fords—allows the driver to hold the speed he desires by a push of the button. He can then remove his foot from the throttle pedal, and the system maintains the desired speed—whatever the road level, car load, or wind velocity.

Radar was combined with this pioneering development to build the ASC system, which adjusts the car's speed so that the radar-equipped vehicle maintains a safe distance behind an automobile in the same traffic lane within range of the radar sensor.

Bendix has developed and tested two radar systems—one at 16 GHz and another at 36 GHz—for routine control of a driver's speed and headway. While the ASCs have been subjected to more than 10,000 miles of road tests thus far, environmental tests—that is, those at production-level—are yet to be completed. The final configuration of an automobile radar control system has not been established yet, either.

ASC links controls

The ASC involves a system that closes the loop, consisting of an automatic throttle setting, automatic brak-

ing, and acceleration. The driver continues to handle the steering and may institute instant manual override in those situations requiring human judgment.

To do this, the driver cuts off the system when he hits the brake, tripping a miniature switch that returns manual control. When he wants to speed up, he pushes the accelerator, and another switch interrupts the automatic control until he removes his foot from the throttle. He can turn off the system with a switch within easy reach.

In the layout for the complete ASC system (Fig. 1), the radar determines the range and relative velocity of the lead vehicle, and a speedometer cable sensor provides the speed reference for the controlled automobile. The signal processor computes the headway for a given set of conditions, based on a control law computation explained later. A display for system control state, brake pressure, throttle position, and measured range, which was included for engineering test purposes, may not be necessary for production models.

A key aspect of the signal processor's commands to the throttle is the headway mode control law. It is:

AUTO ENVIRONMENT	
Here are typical specifications on electronics designed for today's car:	
Passenger Compartment	
Temperature range	
Life tests	-40° F to +175° F
Operating	-20° to +140° F
Vibration	10 to 55 Hz, maximum amplitude 5g
Shock	
Life tests	30 g, 10 milliseconds duration
Operating	10 g
Under Hood	
Temperature range	-40° F to +250° F (may go higher with new emission controls)

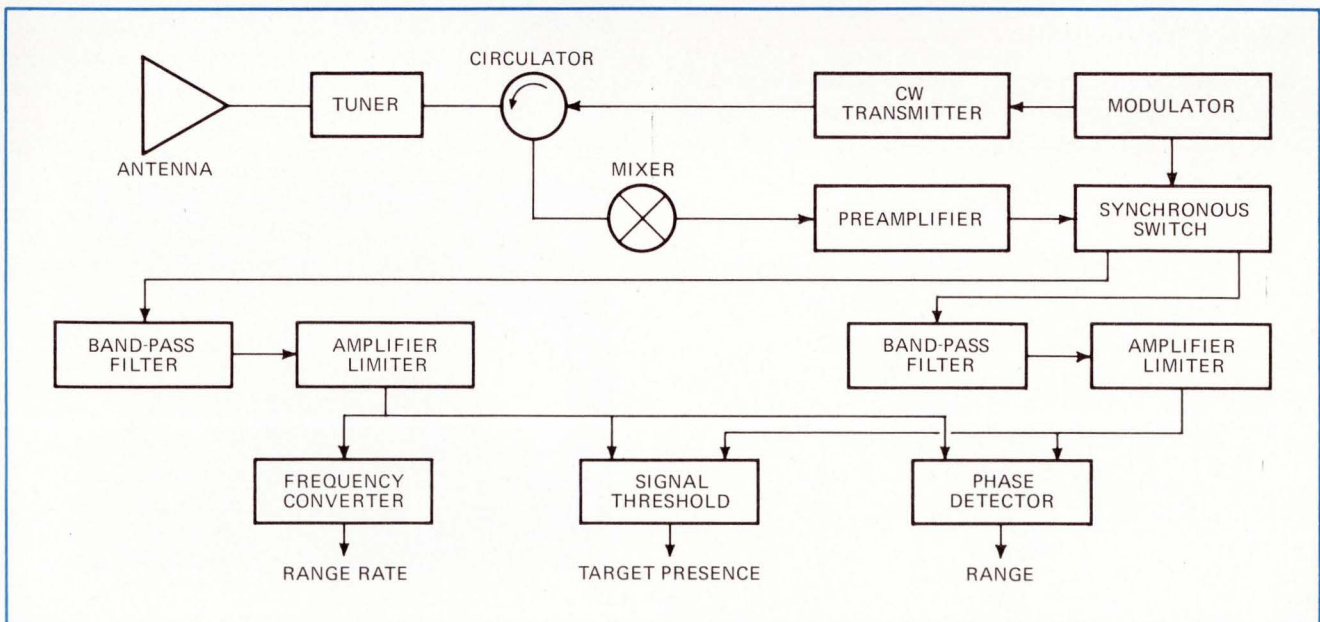

2. Signal ahead. Since the system requires a single antenna to perform both transmission and reception, the circulator was deemed necessary for duplex operation. In addition, the single-ended mixer eliminates the need for local oscillator and mixer diode, thus reducing costs.

$$E = (R - R^*) + 3R'$$

$$R^* = 50 + V$$

Where: E = control voltage level

R = measured range in feet

R* = desired range in feet

R' = measured relative velocity in miles per hour
(positive for opening, negative for closing ranges)

V = equipped vehicle velocity in miles per hour

In operation, the control voltage level is at zero when the system is at desired headway. A positive voltage triggers acceleration, a negative voltage initiates throttle backoff, and a more negative level starts braking.

Three parameters met

An automobile radar design must take into account three basic specifications: it must be adaptable to low-cost production, operate off the low-voltage automobile power supply, and be able to measure both range and range rate. These requirements are satisfied by a solid-state continuous-wave system using a Gunn oscillator. A coherent system—that is, one that measures velocity via doppler shift—was designed to measure range by frequency modulation of the transmitted carrier signal.

An auto radar must have another important capability—the control system must respond equally well to large and small objects. For example, the radar cross-section of a Volkswagen car and a Mack truck differ by several orders of magnitude. On the other hand, if transmitter power is raised to accommodate the smallest possible target, the system will pick up ambiguous target information from trucks at long ranges.

This problem necessitated a range cutoff, which is one of the key features of the Bendix design. This cutoff design involves a variation of a dual frequency modulation technique in which two closely spaced frequencies are sequentially transmitted and received. The cutoff range selected is 300 ft.; however, this figure can be altered during manufacturing. Essentially, the system cuts off signals from beyond the set range by a sequential turning of the transmitter on and off.

Phase shift calculated

In this system, range is proportional to the phase shift between the two doppler signals, obtained by mixing

the local reference from the transmitted and the received signals. The relationship between range and the other system parameters may be expressed as:

$$\phi = (2\pi) (2R) / \Delta\lambda$$

where ϕ is the measured phase shift, R is the target range, and $\Delta\lambda$ is the difference frequency wavelength. Another way of putting it:

$$\phi = 2\pi (2R/C) (f_2 - f_1)$$

where C is the velocity of light and f_2 and f_1 are the two sequentially transmitted frequencies. For accurate ranging, therefore, it is only necessary that the difference frequency ($f_2 - f_1$) be controlled accurately to provide accurate phase measurement. A ranging error of a few feet on a strong target is typical.

As indicated in the block diagram of the radar system (Fig. 2), a single antenna performs both transmission and reception in order to cut down on the space taken in the car and make installation as easy as possible.

Design minimizes cost.

A homodyne system with a single-ended mixer eliminates the local oscillator and mixer diode, which minimizes costs; however, there is a disadvantage over a more expensive pulse system. When the vehicle is at the point where doppler return is zero, that is, the lead car and the tracking car have matched speed, the system is

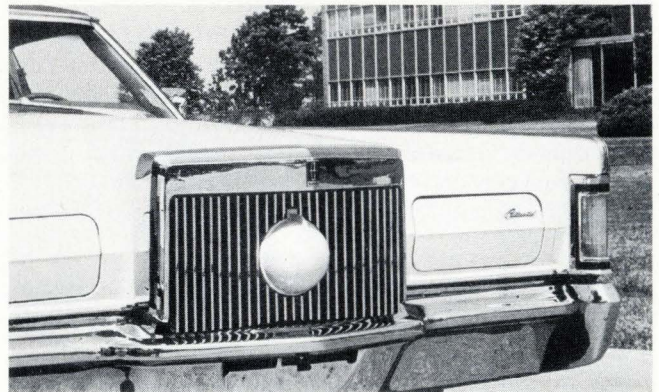

4. Car dome. The 36-GHz antenna, much smaller than the 16-GHz version, performs essentially the same in target acquisition, but isn't suitable for all-weather operation, primarily because heavy rain causes a significant reduction in target-acquisition accuracy.

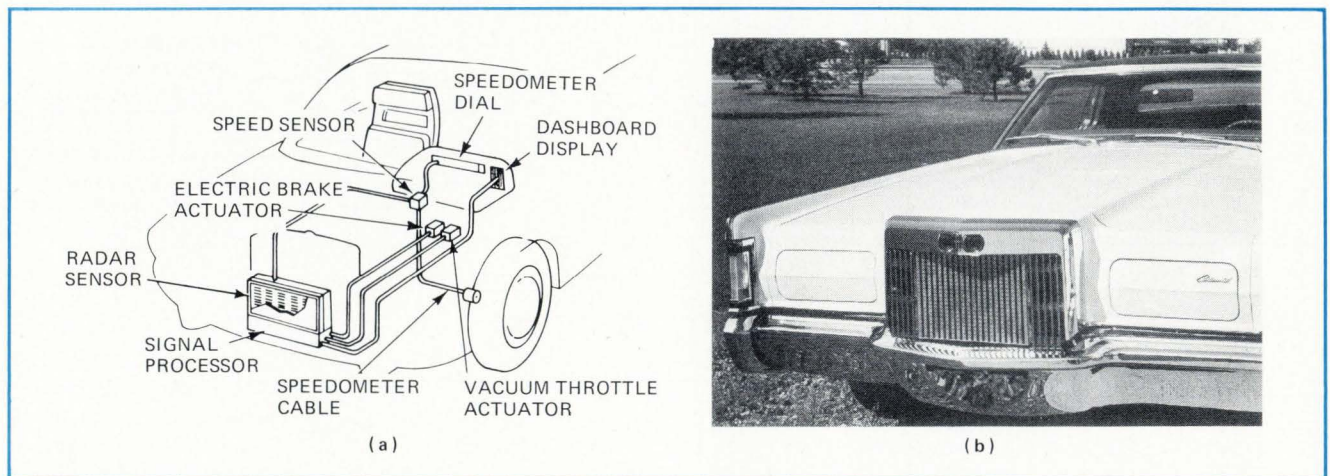

3. Target practice. The first 16-GHz antenna and processor fit in front of the test car's radiator as part of the radar system (3a), but, because of its size and shape, requires space to permit circulation of air through the assembly to the auto's cooling system (3b) behind it.

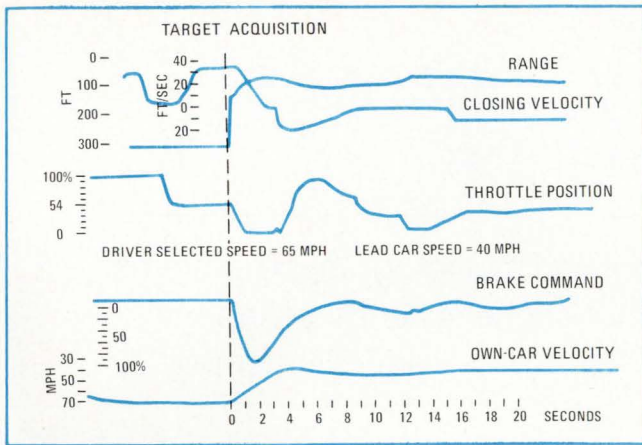

5. Road test. The time history in a road test reproduced here is typical of those performance characteristics obtained when overtaking a slower-moving lead vehicle. In this encounter, the driver of the adaptive speed controlled car, the overtaking vehicle, has selected a speed of 65 mph. Upon overtaking a car traveling at 40 mph, the system automatically releases the throttle and applies the brakes, slowing the controlled car to 40 mph within 5 seconds.

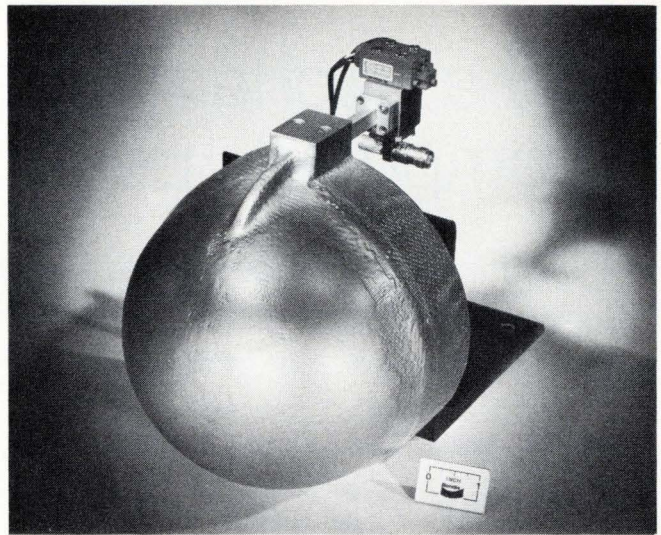

6. Car hop stop. To minimize annoying microphonics in the rf plumbing caused by normal vehicle vibration, packaging in radome of low-cost glass-fiber-covered dielectric foam was selected. A non-microphonic mixer was also chosen to counteract vibration.

receiving no information. Thus, additional logic in the processor is required to hold the last received range and speed setting in memory until there is a change in conditions. This is a closed loop system, so that at zero doppler, the processor memory maintains control.

However, when the auto reaches zero doppler, the processor could interpret the lack of signal as no target ahead. To counter this, the system is designed to have the processor gradually accelerate the car to take it out of zero doppler and return to pre-set speed if the target car ahead has indeed disappeared. Acceleration is so gradual that the driver does not notice the change—the system gets off zero doppler when the velocity changes by less than $\frac{1}{2}$ foot per second per second. This smooth, feathered acceleration also updates the memory.

The transmitter reference signal required for mixing is controlled by tuning in the antenna channel. The synchronous switch, after the preamplifier, splits the two doppler signals into separate channels, where further amplification and filtering are accomplished prior to phase comparison.

Radars use 16 GHz and 36 GHz

The first experimental radar (see Fig. 3a) was designed to operate at 16 GHz. The antenna is a standing-wave waveguide array. A beam width of 3° to 4° minimizes adjacent lane interference, but requires a 1-foot-square aperture in the auto grill. This arrangement, in turn, requires gaps between waveguide sections to permit air passage to the radiator, shown in Fig. 3b.

This radar acquired automobile targets at 200 to 450 feet, depending on size and shape, but did not have the range cutoff feature mentioned above. Range cutoff of 300 feet was introduced into a 36-GHz design that has a 6-inch diameter parabolic dish antenna (Fig. 4), with the waveguide forming a buttonhook feed. This smaller antenna blends in more easily with front-end design and has a range performance comparable to that obtained with the 16-GHz model. The radome is constructed of glass-fiber-covered dielectric foam. Figure 5

shows the time history of a typical encounter taken early in the development stages of the system. This chart exhibits a little bumpiness, which has been smoothed out since.

Both the experimental and the final production packaging of these radars stipulates waveguide construction. Although a 36-GHz microwave IC may certainly be feasible today, this technology is not ready for the kind of low-cost production required for an automotive industry product. Initial production of the radar will be done with standard components.

Frequency stabilized.

The severe temperature environment most affected the radar modulator-transmitter. The modulation frequency limits had to be maintained constant over the entire temperature range. But since the tuning sensitivity of the Gunn oscillator changes with temperature, compensation was necessary to prevent frequency excursions. To maintain fixed modulation over the temperature spectrum, thermistor-sensistor compensation was used—both positive slope and negative slope parts.

Vibration and shock in the car induced microphonics in the rf plumbing as well. This problem was solved by selecting a non-microphonic mixer and compact packaging of the assembly (Fig. 6). As for power fluctuations, heavy power line filtering and regulation solved the problem, while shielding and grounding were controlled to minimize radiated and conducted interference.

Still up in the air is the optimum antenna size. For instance, the 36-GHz version offers ease of styling, but does not perform well in very heavy rains. If radar control is to be considered a device to be used optionally only in fair weather, the 36-GHz unit is adequate.

But if all-weather performance will be required, an operating frequency lower than 36 GHz will be in order, which, in turn will affect the antenna size. Probably an all-weather system will dictate a dual antenna, thus filling both frequency and styling demands. □

How a cache memory enhances a computer's performance

Large computers, including multiprocessors and multiprogramming systems, can exploit the concept of the semiconductor cache; it keeps on tap a pool of the most-wanted data, drawn from a slower magnetic memory

by Robert M. Meade, *Cogar Corp., Wappingers Falls, N.Y.*

□ Cache memories are still a mystery to many people, and their promise is underestimated. Yet, though the IBM Systems 360 and 370 are the only computers so far to use them, they could undoubtedly enhance the performance of certain other large systems, even including some multiprogrammed systems and multiprocessors.

A form of buffer, the cache memory is physically part of the processor—and its purpose is to make immediately available to the processor that pool of information which is currently in use. Its effectiveness depends on the fact that, when information is obtained from a particular location in a memory, a nearby location will very probably be addressed soon after—that is, the information is clustered.

Accordingly, the cache automatically retains the information most recently taken from memory, together with immediately adjacent information, on the assumption that data in that block will shortly be used again. Then blocks are moved automatically under hardware control between the faster cache and the slower, backing memory (Fig. 1), in such a way as to make the cache completely invisible to the programmer.

Generally speaking, the larger the main memory of a system, the more attractive the use of a cache becomes, because the system can then use a less expensive and slower backing memory. But some design techniques, such as making main and control functions share a single memory, reduce the cache advantages. Moreover, in a multiprogramming system, the cache can only be fully effective if the time it takes to transfer adequate working data into the cache after switching programs is considerably shorter than the period of time allotted to each program.

The application of the cache concept in five IBM computers (System 360 models 85 and 195, and System 370 models 155, 165, and 195) has been described in several articles.^{1,2,3,4} In its more recent systems, IBM opted for fast single-level main memories for both data storage and control microprograms. This fact, however, shouldn't be taken as invalidating the concept, but as illustrating the tradeoffs that must be made in designing a system to a given set of performance objectives.

The performance of a processor with a cache is defined by its system parameters. Given appropriate block size and transfer data rates, the most important parameter for the designer is the buffer capacity; these determine the average frequency of references made by the

user's program to the backing memory. The cache concept applies equally well to fixed-word-length processing and to byte-oriented structures.

Fairly small blocks of information are essential. If too big, they force the buffer to be expensively large, and demand too much of the transfer data rate between the buffer and the rest of the memory. (The same is true of the pages used in virtual memory systems, which, however, being transferred from a much slower memory, must be larger than cache blocks.)

When deciding on cache capacity, the designer must know the probable size of the working set—the minimum amount of information that a program uses over some interval of time⁵—plus the size of the block into which the memories are to be partitioned. He must also devise a scheme for allocating space in the cache buffer against the total backing-memory space.

An example of how to measure the data referencing patterns in a typical operating system is given in Fig. 2, which shows the frequency of reference to different small blocks of memory in a Xerox Data Systems Sigma 5 computer by a typical Fortran analysis program. The length of each vertical line is proportional to the number of references the program makes to a particular block of 200 contiguous addresses.

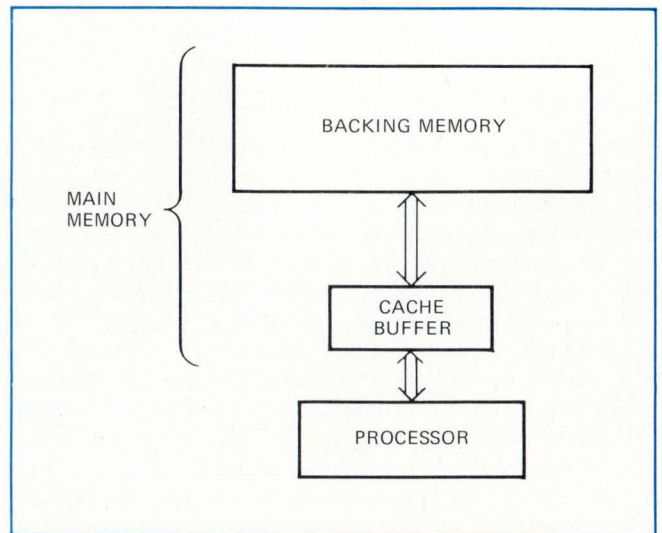

1. Cache concept. Small high-speed buffer in front of large slow memory makes the big memory seem to work at the speed of the fast buffer. The combination thus increases system throughput.

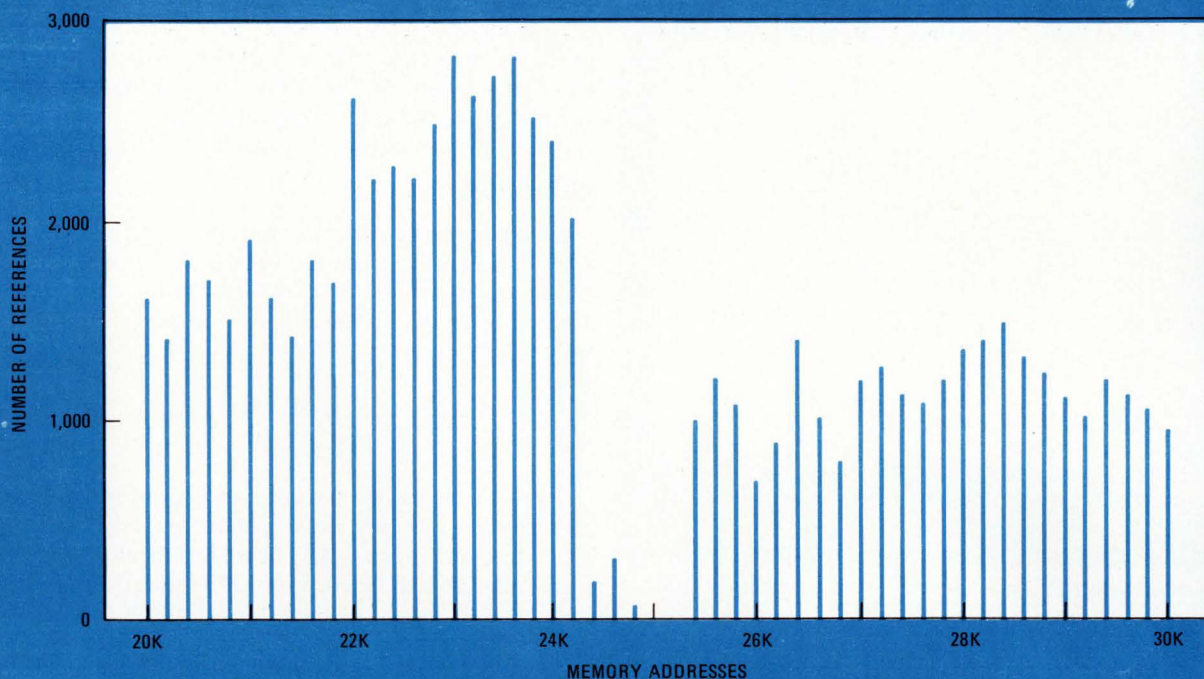

2. Pattern of memory references. A typical program running on an XDS Sigma 5, a medium-size computer, makes many references to some memory locations and few or none to others. As a result, the over-all pattern is highly non-uniform.

The pattern of referencing is highly nonuniform and therefore highly informative. Its key features are the few references between addresses 24,400 and 25,400, its uniformly distributed references to addresses above 27,000, and the distinct peak, showing many repeated references, between addresses 22,000 and 24,000.

Ground rules for cache design

As in any design problem, the choice of cache and backing memories must be determined from analysis of performance and cost. Design considerations, methods of analysis, and implementation of controls are discussed in considerable detail elsewhere.⁶ Here we shall briefly review the chief design parameters, of which the most important to come under the designer's immediate control are buffer capacity and information block size. In addition, since the information flow is governed by built-in system logic, he must determine the rules or algorithms implemented by these controls.

Ideally, a processor should be able to compute an address during one cycle—for example, by adding an index value to a reference address—and then obtain the operand it seeks during the next cycle. Since the cache exists to meet this goal as often as possible, its cycle should be equal to or less than the processor cycle, and the technology with which it's built must be like that of the processing logic. For this reason, the cache concept became feasible only with the availability of a viable monolithic semiconductor memory technology.

The access time for the cache is limited more by the control paths than by the memory array time, because every reference has to determine whether or not the operand sought is currently in the cache. Critical to this determination is the choice of the mapping rule, by

which buffer space is allocated to blocks brought from the main memory.

If the over-all access time of the cache is longer than the basic processor cycle, it may be broken into two phases using two successive cycles: one for determining an operand's location in the cache, and one for reading it out. The designer may pipeline the operation of this two-phase mode, so that two successive references can be simultaneously in execution, one in each phase.

When the cache operates at the same speed as the processor, it virtually eliminates the need for other forms of buffering within the processor. In fact, the designer could use the cache in place of an internal scratchpad register array, at least in systems where the internal registers have memory addresses in the same range as the main memory.

Miss distribution

An ideal cache would contain all memory references. For a real system, however, the miss distribution (the frequency of addresses not found in the buffer) is normally roughly exponential. For any particular program, the miss distribution can be measured, and plotted as a graph of the number of misses—references to backing memory—versus the number of memory references between misses. From the design viewpoint, these references affect the bandwidth of the path between backing memory and processor; the memory system must not degrade the arithmetic unit's performance, which must not suffer excessively from waiting for data from the backing memory.

A graph of a miss distribution appears in Fig. 3. The program measured is typical of those running on a Sigma 5 computer. Although the machine does not have

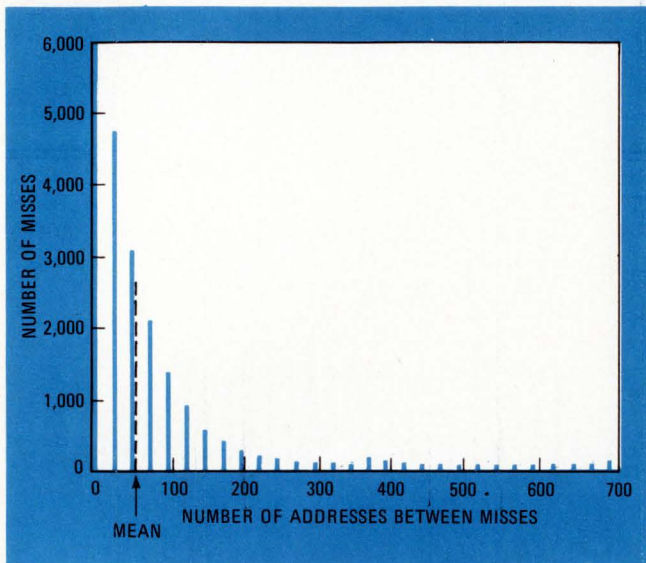

3. Miss distribution. In a simulation of a cache system, a "miss" is an address that is not in a small group of sequential addresses in a program. The distribution of the number of misses in a typical program indicates the value of the cache concept for that program.

a cache memory, the analysis is valid because the plot shows memory references outside the clusters of addresses that would be in a cache. It shows, for example, that during execution there were about 4,750 references to backing memory separated by no more than 25 references to the cache; slightly over 3,000 references separated by 26 to 50 clustered references; and so on. Thus, nearly successive addresses often cause reference to the backing memory. However, these are balanced by the cases in which a long sequence of addresses comes from the cache.

The mean of this distribution is the average number of addresses between calls to the backing memory. On the graph the mean is represented by the vertical line that divides the total length of all the bars into two equal parts. In this diagram the mean is 50 addresses. The reciprocal of this mean—the fraction of the addresses that require a backing-memory cycle—is the miss rate. This value indicates the performance of the cache system, and describes what proportion of its time the processor spends waiting for data from the backing memory.

The miss rate depends on both the block size and the cache capacity. For any block size, the larger the cache, the smaller the miss rate. But for a given cache capacity, increasing the block size first reduces the miss rate as the blocks contain larger clusters of information, but then increases it as the number of independent blocks that the cache can hold becomes too small.

For maximum cost-effectiveness these factors must be interrelated. In Fig. 4, the miss rate is plotted as a surface function of both factors. The cache size is the more important, but small blocks tolerate a small cache better. A large cache achieves the lowest miss rate with a block large enough to be disastrous with a small cache.

In general, no two programs have the same miss distribution. For some programs, the curve is steep and hugs the coordinate axes; its peak is high, and its mean

is far to the left, corresponding to a very small number of memory accesses between misses. For such a program the miss rate is high, and the cache is of little use. For other programs, the curve drops slowly, the mean is further to the right, the miss rate is lower, and the cache radically improves the performance of the machine.

Data rate criteria

Program analysis shows that, because practical block sizes are powers of 2, the data rate from the backing memory always increases as the block size increases. This implies that doubling the block size reduces the miss rate by a factor of less than 2. If the block size and the miss rate were inversely proportional, however, this change would not affect the data rate. As it is, the block size must be chosen so that the data rate is not excessive.

To avoid delay, the readout and transfer capability of the backing memory must satisfy the processor's peak data demands. The miss distribution shows that this peak demand can be considerably higher than the average demand, which is determined by the miss rate. The entire block must arrive in the cache before the processor encounters another miss. This criterion places an additional demand upon the backing memory's data rate.

The bandwidth demand for the system is set by the processor's arithmetic speed: the higher its speed, the more rapidly it needs information. Therefore, a larger block size, and an adequate data rate to support it, are appropriate in a larger system. Fortunately, a cache makes optimum use of the data rate potential of interleaved memories because addresses within a block are guaranteed to be sequential. Thus interleaving is one way to provide adequate bandwidth without increasing backing memory speed. Longer words in each array have the same effect. Conceivably an entire block could be read from the backing memory as one long word.

The capacity of the backing memory is not limited by the use of a cache, but is fixed by the over-all system definition. Its cost is determined by the speed cost curve for the available level of technology. But the influence of its speed upon system performance depends very much on the cache. A highly effective cache makes high performance possible with a slow backing memory. Naturally, the time required for accesses to the backing memory degrades system performance from the ideal case, in which all references would be to the buffer. But thus, if the miss rate is low, performance is relatively insensitive to that access time (always provided the bandwidth of the backing memory can support the miss rates).

The capacity of the buffer directly sets the cache cost and, through its influence on the miss rate, also largely sets the system performance. Optimizing the buffer capacity consists of finding that combination of buffer and backing memories for which the cost-delay product is a minimum, the backing memory having a fixed size at variable cost and performance, and the buffer memory having a variable size with fixed cost and performance. Comparing various two-level and single-level memory alternatives for maximum cost-performance is the only valid way to decide where a cache is advantageous.

For very large systems, a cache or the equivalent is

essential to overcome the performance limitations of size. Control Data Corp.'s giant 7600 computer, for example, does not have a hardware-controlled cache, but does employ a relatively small, fast, internal ferrite memory through which information passes under software control.

For intermediate systems, the decision to use a cache must be based strictly upon cost/performance analysis. For example, the absence of a cache memory on the smaller models of IBM's System 370 does not belie its efficacy elsewhere. Since the cache can improve system speed well beyond the level of a backing memory, it becomes a profitable investment only when the cache plus backing memory costs less than a single main memory fast enough to permit equal throughput. If memories of 200-ns cycle time were no more expensive than memories ten times slower, today's systems would not use cache memories.

Consequently, the larger the main memory in a system, the smaller the cost reduction per bit that is needed to make a cache profitable. Conversely, in planning a series of machines of descending performance levels and memory capacities, a level is reached at which employing a cache is unprofitable. The point at which this occurs depends upon the cost and performance ratios for the memories available to a manufacturer.

Wide spread pays off

A comparison among three hypothetical machines, illustrated in Fig. 5, shows that a cache memory is likely to be much more cost-effective in a large machine than in a small one. The spread between the curves, illustrating both improved performance going toward the left and reduced cost going down, is much greater for the large machine. The diagram also shows, by the steepness of the cache curve for a small machine, that the cost of a cache is a larger proportion of the total cost of such a machine, severely limiting the range of circumstances in which it would be cost-effective.

Another factor pertinent to the cost/performance analysis of cache for a particular machine is that machine's control design. Microprogramed controls require a relatively fast control memory. Historically, these have been read-only memories because the microcode was relatively permanent and because they offered a significant cost/performance advantage. Some recent systems use read/write memories for microprograms. Moreover, some permit the user's program and the microprogram to share the same memory, a concept that has become more attractive with the advent of the relatively fast semiconductor main memory. When one memory serves double duty in this way, a larger investment in its speed and size can be more profitable than investing in a separate cache memory.

However, the cache can also apply to microprogram memories. For example, a machine might use a large, inexpensive, easily changed, read-only memory to contain the microcode, and a small, fast, read-write transparent control memory at the execution level. In a sense, System 370 models 135 and 145 are designed this way since the primary microprogram storage is the console read-only disk, and the control memory, though not transparent, is read-write.

In multiprograming, the main memory contains two or more programs, among which the processor shares its execution time. Using a cache buffer in a multiprogramed machine implies that the cache must be reloaded with every change of program. This reloading exacts an execution-time penalty that a system with a single-level main memory would not incur.

Three factors save cache

But there are several mitigating factors. First, part of the cache usually holds blocks of the supervisory program, rather than problem program blocks: the former are common to all programs and need not be replaced. Secondly, the program that is starting or resuming need not replace more than a few blocks in the cache in order to proceed. While the maximum rate of replacement occurs immediately upon program switching, as the new program seeks an adequate working set, it often calls on a long string of addresses within the cache after having fetched only a few blocks from the backing memory. Indeed, in many situations, the new program uses only a few information blocks before it reaches a condition that causes the supervisor to switch to a third program.

Thirdly, for those programs that do have substantial execution time and do require a large working set, the time required to fill the cache is usually short compared to the running time. For a particular set of system parameters, the time to fill a cache would be only about 2% of the period in which a single program is guaranteed exclusive use of the machine. For the Sigma 5, this period is typically 100 milliseconds, which guarantees a response time of less than 15 seconds for each of 32

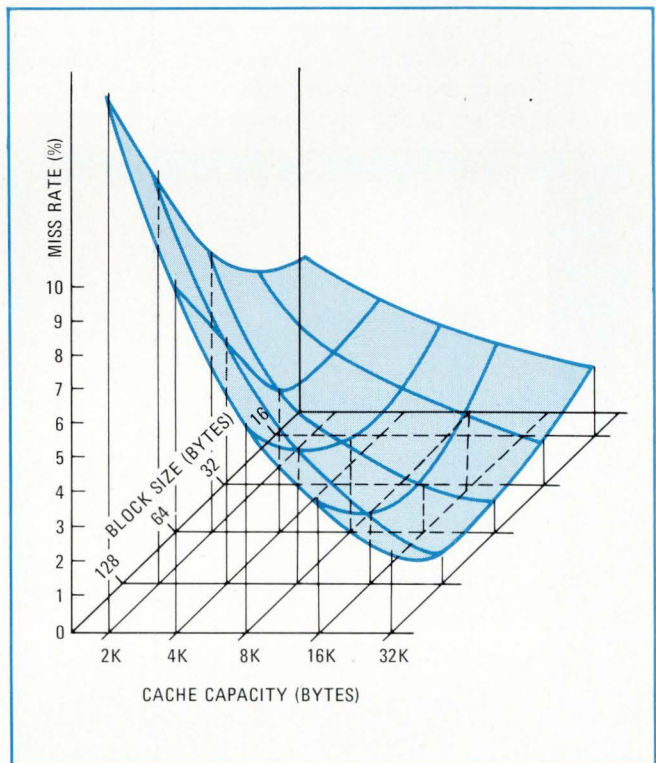

4. Miss rate. Both block size and cache capacity are important factors in determining the miss rate. For a fixed block size, a larger cache gives a lower miss rate; but for a fixed cache capacity, the miss rate first decreases, then increases, as the block grows.

users, yet allocates three-quarters of the total execution time to batch jobs. Furthermore, even a system ten times faster and using a correspondingly shorter time slot to service many more users, would not need excessive filling time.

Virtual systems

The logical step beyond multiprogramming is the use of cache in virtual memory systems, in which the programmer need not concern himself with the physical capacity of his memory, but only with the maximum space addressable in his instruction format. (This is actually an extension of the cache concept, the cache itself being a subclass of virtual memory.)

In the virtual system, the main memory is itself a buffer for the large address-space of an auxiliary memory, usually a disk file. Just as blocks are transferred from the main memory to the cache, so larger segments called "pages" are transferred from the auxiliary to the main memory. No new considerations are introduced in the design of a cache to be used with that main memory. The designer can implement the virtual memory paging process either in hardware or in software, whether or not he employs a cache. But use of a cache does tend to make hardware control for the virtual memory mapping more attractive, because the two sets of controls for auxiliary-to-main mapping and main-to-cache mapping can be effectively combined.

In the single-level virtual memory every reference to the memory must be accompanied by an address transformation, because the data in general isn't literally at the location specified by the programmer. Typically, the transformation is executed by hardware if the word is already in the main memory, by software if it is in a page that must be pulled in from an auxiliary memory. In either case, the transformation increases the access time. But with a cache, the controls can be so designed

that a transformation is needed only when an auxiliary-to-main or a main-to-cache transfer is required, not when the word is already in the cache.

Design parameters similar to those for cache memories apply also to the main memory and the auxiliary memory considered as a virtual system. However, the optimum numbers change significantly because the memories have vastly different performance ratios: whereas the cache/main-memory access time ratio is typically about 1:10, that between main and auxiliary memory is closer to 1:1,000. Because of this larger ratio, the main memory must contain more pages than a cache buffer contains blocks. The ratio also calls for pages themselves to be much larger than blocks—typically 1,000 bytes compared to 32. But the access time ratio will probably improve significantly when solid-state replacements for auxiliary memories become available.

Multiprocessing in cache systems

Parallel multiprocessor configurations may have shared address space—that is, common main memories. The interconnection delays in such configurations tend to slow the system. These delays are reduced when the processors include caches, which decouple processor performance from backing memory access time.

One difficulty in multiprocessing is insuring that one processor is not changing a status indicator just as another processor is taking action based upon the previous state. Such status indicators usually are bits in words of shared memory.

One solution to this problem employs a split memory cycle in which interrogation and modification always occurs between the read half and the write half. This prevents a processor from ever gaining access to a word in transition. To extend this solution to processors with caches, a privileged instruction establishes the split cycle in the backing memory. Alternatively, a processor can set a memory-protect key for the control word page prior to any interrogation. Other interlocking approaches, such as signals extended from each processor to all others in the system, are also feasible.

Multiprocessors can also share a common cache/backing memory combination. This is less attractive, however, because it inserts cabling and logic delay in the path between the cache and the processor. These delays make it nearly impossible to maintain a one-cycle access time to the cache, a disadvantage that far outweighs the reduction in miss rate achieved by pooling the high-speed memory into one large cache.

On the other hand, attractive cost/performance is offered by a multiprocessing configuration of cache-buffered minicomputers sharing a large core memory as a common backing memory, as shown in Fig. 6. The ratios of arithmetic speed and data rates match advantageously. The capacity of the core memory permits the processor to work either on large problems or on many small tasks. With the 16- to 18-bit word of the miniprocessor, a cache of 2,000 to 4,000 bytes is effective, and the long word length of the core memory can contain an entire block.

Cache architectures are a timely solution to the problem of making the transition from all-magnetic to all-semiconductor memories. How long they can persist de-

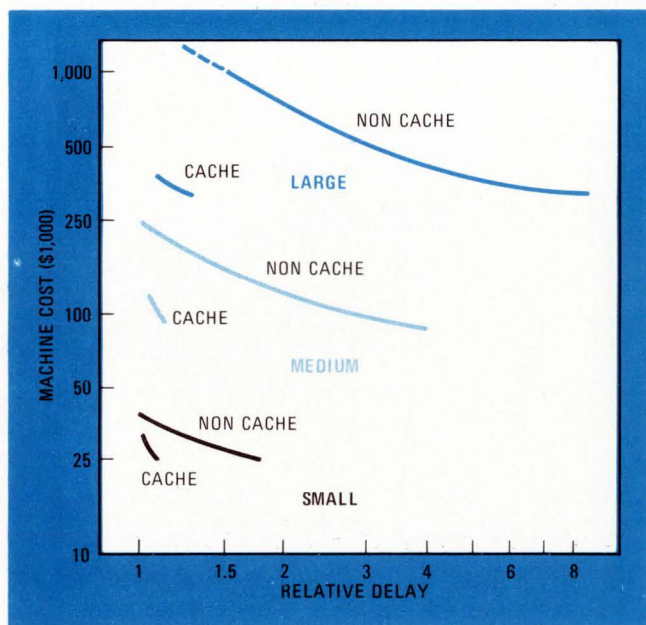

5. Cache vs machine cost. Large spread between two solid-color curves shows that a cache memory is more cost-effective in a large computer than in a small one (black curves close together). For intermediate machines other tradeoffs must be carefully considered.

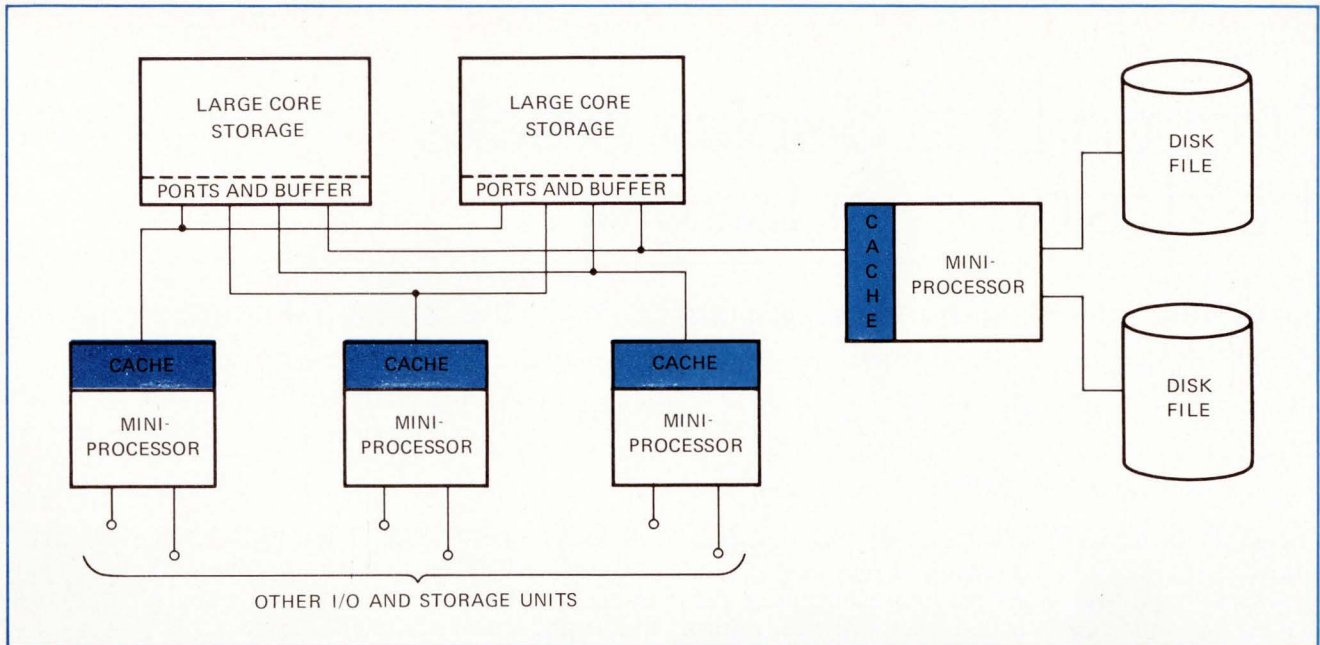

6. Cache in network. A network of minicomputers can make very advantageous use of the cache concept when they share a large, slow core memory and, through a dedicated processor, a disk file as auxiliary storage. Caches can contain up to 4,000 words apiece.

depends very much on monolithic memory development. Semiconductor memory systems using inexpensive MOS technology are now being delivered with access times of 175 ns and cycle times of less than 300 ns in capacities of many millions of bits. These imply the adequacy of a single-level main memory for all but the highest performance systems. Consequently, without progress in logic circuits relative to performance-oriented and cost-oriented monolithic memories, cache systems will offer little advantage.

More cache is likely

Because semiconductor memories can employ both bipolar and MOS technologies, they will probably offer a continuing spread in cost and performance greater than that which was available in magnetics. The bipolar gain-bandwidth advantage yields faster memories, whereas the MOS density advantage is translated into lower-cost memories.

The progress that has been made in logic and memory speeds in recent years is diagrammed in Fig. 7. Effective cache memory systems have been designed using 4-ns logic delays, 40-ns bipolar cache access times, and 600-ns backing memory access times. By extrapolating the graph, future compatible sets can be predicted that use, for example, 1.5-ns logic, 16- to 20-ns bipolar cache access times and 240- to 320-ns backing memory access times. The latter falls within the range covered by cost-oriented MOS memories. If these cost and performance trends continue, some future systems will use the cache architecture with all-semiconductor memories. Indeed, designs now in the laboratory suggest that a third-level MOS memory, slower and larger than today's conventional backing memory, will become economical. This memory would be much less expensive than today's cache buffer, and somewhat cheaper than cost/performance MOS arrays.

Thus, while cache memories are necessary only for

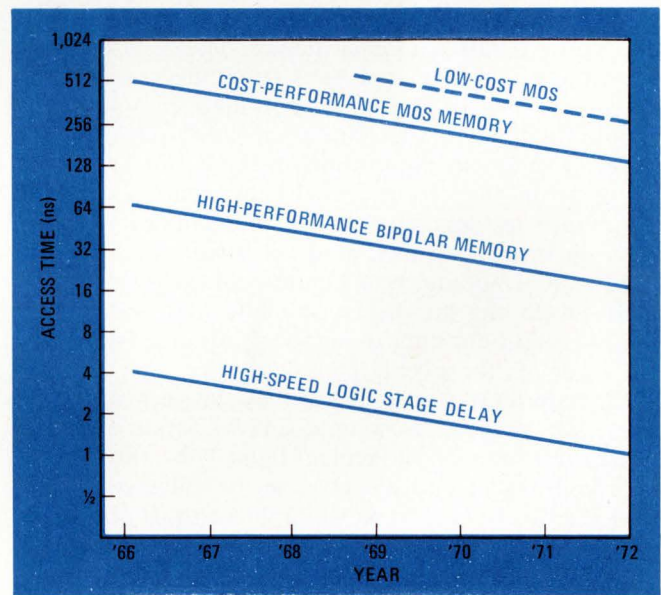

7. Technical progress. Since semiconductor memory and logic speeds are improving at approximately equal rates, two- or even three-level all-solid-state cache memories will become feasible.

highest performance systems, they are widely applicable and provide another tool by which designers can continue to improve systems cost-effectiveness. □

References

1. J.S. Liptay, "Structural Aspects of the System 360, Model 85; Part II—The Cache," IBM Systems Journal, Vol. 7, No. 1, 1968, p.15.
2. Carl J. Conti, "Concepts for Buffer Storage," IEEE Computer Group News, March, 1969.
3. Donald H. Gibson and W. Lee Shevel, "Cache turns up a treasure," Electronics, Oct. 13, 1969, p. 105.
4. Robert M. Meade, "On Memory System Design," AFIPS Conference Proceedings, Vol. 37 (Fall Joint Computer Conference), 1970, p. 33.
5. P.J. Denning, "The Working Set Model," Communications of the ACM, 1969.
6. Robert M. Meade, "Design Approaches for Cache Memory Control," Computer Design, January, 1971, p. 87.
7. Joseph H. Kroeger and Robert M. Meade, "Cache Buffer Memory Specification," Proceedings, 1971 Computer Designer's Conference, Vol. 1, 1971.
8. Wallace B. Riley, "Minicomputer networks—a challenge to maxicomputers," Electronics, March 29, 1971, p. 56.

Strobed LED display breaks the design cost barrier

Use of integrally molded magnifying lenses halves the required amount of gallium arsenide phosphide, and strobed operation spreads cost of driving circuitry over several digits and increases LED efficiency

by R. W. Soshea and R. L. Steward, *Hewlett-Packard Co., Palo Alto, Calif.*

□ What the world needs now is a good, small, low-cost, attractive, and low-power numeric display device. The prospect of hand-held probe readouts, shirt-pocket calculators, and other miniaturized electronic instruments has created a powerful demand for such a component.

These objectives are now in sight thanks to a new five-digit display which uses an integrally molded magnifying lens to halve the amount of gallium arsenide phosphide required in each device. The resulting benefit to the designer is a substantial decrease in the amount of power required for normal display visibility, coupled with over-all lower cost. Now, prices in the range of \$2.25 per digit in quantities of 100,000 can be realized, and they are expected to approach \$1/digit in the future as demand reaches the millions of digits level. A 15-digit display, made of three separate packages, is shown in Fig. 1 on a hand-held calculator.

In developing the display, a choice had to be made between light-emitting diodes and liquid crystals. The LEDs won out for several reasons.

First, the LED is an active display device which emits light, whereas, liquid-crystal displays operate by reflection or transmission of incident light. Thus, the contrast and legibility of LED displays can be enhanced by increasing the drive current, while the contrast of a liquid crystal display is fixed.

Liquid-crystal displays now available suffer from an annoyingly slow response at and below 0°C, and lose contrast ratio rapidly with increasing temperature, becoming illegible at about 75°C.

Finally, LED displays have proven their inherent long-term reliability. On the other hand, liquid-crystal displays are limited to 10,000 hours under ac drive conditions and much less under dc drive.

The new display uses a monolithic LED chip of GaAsP with all seven segments and a centrally located decimal point diffused into the passivated planar surface. Although many LED displays use a discrete chip for each segment, the monolithic approach was chosen because of its lower assembly cost, higher reliability, and better character appearance. The large central decimal point which is substituted for a digit, helps avoid reading errors. For applications using a fixed decimal point or none at all—such as odometers and counters—this design is more cost effective than one which requires an additional decimal point chip next to each digit.

Although GaP can also be a red-emitter, GaAsP is better in this application because the low self-absorption of red light in GaP causes the digit to be poorly defined when normal planar techniques are used. Green-emitting GaP can also be used for monolithic displays, but its materials cost is several times higher than that of the red-emitting variety.

It's all done with lenses

One of the key features of the display package is the use of integrally molded lenses to achieve a character magnification of $M = 1.41$. This magnification, which reduces the amount of GaAsP material required to ob-

1. End-stackable. Three individual LED units in standard 14-pin DIPs make up the 15-digit display in this hand-held portable calculator. Each digit, formed by seven-segment monolithic GaAsP chips 0.11 in. high, is magnified 1.41 times by molded lenses.

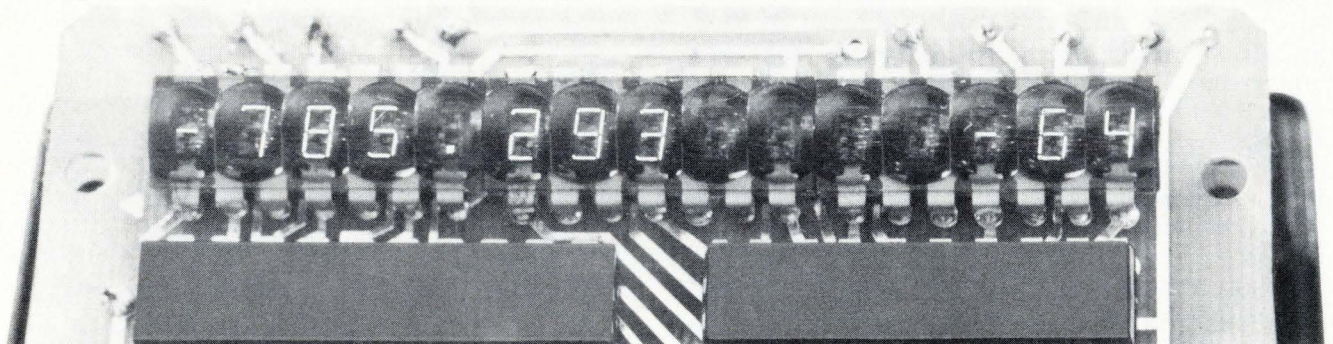

tain a given character height by a factor of $M^2 = 2.0$, is a major contributor to the low cost of the display. In addition, magnification increases the luminous intensity by M^2 , compared with an unmagnified character at the same drive current. The lens design allows a vertical viewing angle of 60° and a horizontal viewing angle of 35° from the normal to the LED surface.

A lens array molded as an integral part of the plastic package has several significant advantages over a lens array attached separately. The manufacturing cost of an integrally molded lens array is the same as the cost of a flat package, thus eliminating the additional cost of molding and mounting a separate lens array. In addition, unless it is glued to the package to eliminate the air interface between package and lens, the separate lens array causes the viewing angle to be reduced substantially. For example, if the present display with $M = 1.41$ were made with a separate lens, the vertical viewing angle would be reduced from its present value of 60° to approximately 36° .

For a LED display to be legible under bright ambient light, it should reflect a minimum amount of incident light. The display uses a lead frame which has been darkened selectively to avoid this reflection. The lower portions of the pins are gold plated to ensure reliable soldering. To increase contrast and legibility further, the plastic lens material incorporates a red dye that absorbs strongly at all visible wavelengths except the 650 nanometers emitted by the LED.

Strobed operation benefits

Multi-digit displays are usually operated by strobing to spread the cost of the driving circuitry over several digits. Strobed operation brings a second benefit as well: since each digit in an array of n digits will be turned on with a duty cycle of, at most, $1/n$, the digits will operate at high peak-current levels, with a concomitant gain in luminous efficiency as in Fig. 2.

This increase in efficiency with current, common to all GaAsP diodes, is caused by a non-radiative current component that increases with forward voltage more slowly than does the radiative current component. The

2. Efficiency increases with current. The pulses used in gathering the data for this curve, typical of GaAsP diodes, were short enough to avoid any significant thermal effects.

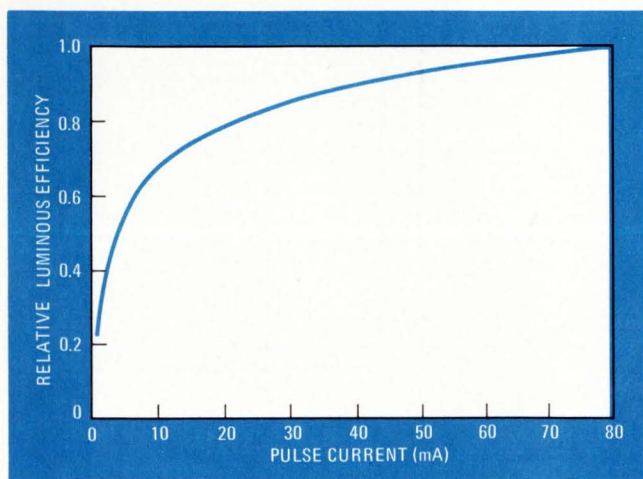

pulsed luminous intensity per character is typically 21 millicandela at a pulse current of 80 milliamperes per segment. If the display is driven by 10-mA pulses, its efficiency will drop to 64% of its value at 80 mA. The power dissipation under normal viewing needs to be only 7 mW per digit.

Two methods for strobing the displays are the current-limiting resistor technique (Fig. 3a) and the energy-storage technique (Fig. 3b). The current-limiting-resistor circuit is compact and simple to implement. The display is turned on only at a high current level, thus operating the LED at a relatively high efficiency.

In the idealized energy-storage circuit of Fig. 3b, the power-wasting resistor is replaced by an inductor. This

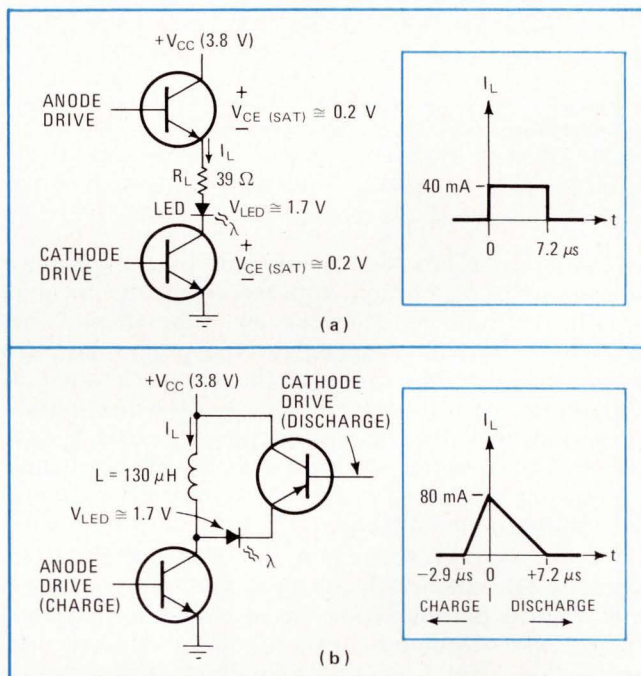

3. Strobing. The current-limiting resistor circuit (a) wastes power, but it is simple and compact and produces well-defined square pulses. The energy-storage circuit (b) is bulkier, and it presents some timing problems, but it's twice as efficient.

approach is attractive in battery-powered applications, where it can halve the amount of power required for a given brightness level. A disadvantage of the circuit is that the inductor can be quite large when long pulse lengths are required.

The capacitive analog to the circuit of Fig. 3b can also be used, provided that provision is made to limit momentary current spikes to a safe level.

As mentioned above, the decimal point is designed to be activated in the same fashion as any other character. Since it is located at the center of each digit—not at a corner—this provides an economical means for enhancing display legibility. Two ways of activating the decimal point are illustrated in Figs. 4a and 4b. For comparison, Fig. 4c shows the technique normally used with a lower right decimal point. In Fig. 4a, a time frame, as well as a digit position, is dedicated to decimal-point display. Printing calculators employ this technique. When one has the freedom of a custom design, this is often the easiest mode to implement.

DECIMAL POINT DISPLAY TECHNIQUES

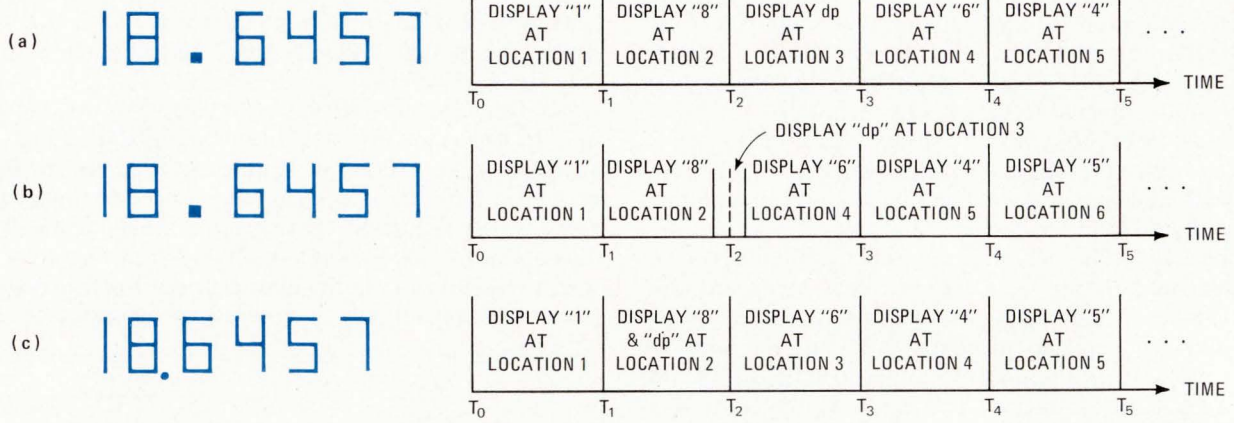

4. Getting the point. Probably the easiest way to display the decimal point is to dedicate both a time frame and a digit position to this function (a). Alternately, in existing systems that do not provide a time frame for the decimal point, it can be given its own spatial position while being squeezed in between two other time frames (b). The conventional lower-right decimal point (c) is more expensive than the preceding designs because it requires a separate decimal point next to each digit.

In other cases, however, an alternative technique may be preferable. A desirable approach is for the decimal point to be squeezed between two time frames and character information steered to the proper slot. As shown in Fig. 4b, the timing of this approach is not as straightforward as the previous one, but it permits interfacing with established timing circuitry that does not allow for an extra time frame before recycling to time frame zero. The standard calculator-on-a-chip circuits are good examples of this.

For the display to remain uniformly bright from character to character, the decimal point must consume only a small portion of the display times of adjacent characters. To compensate for its much shorter pulse length, the decimal point's anode driver is usually designed to provide pulses at a higher current level.

The steering and timing circuitry to implement Fig. 4b can either be part of a custom timing chip, or, for less than \$2, it can be made of standard gates (Fig. 5).

The decimal point conditioning circuit produces a timing signal that controls the driving of the decimal point between time frames. This pulse serves two functions: It enables the decimal point's anode driver, and it triggers a circuit that disables all other anode drivers while the decimal point is lit.

The digit-select steering circuit controls the timing signals to the cathode drivers. For character information appearing to the left of the decimal point, digit timing signals from the calculator chip are transmitted to the cathode drivers without change—that is, the digit

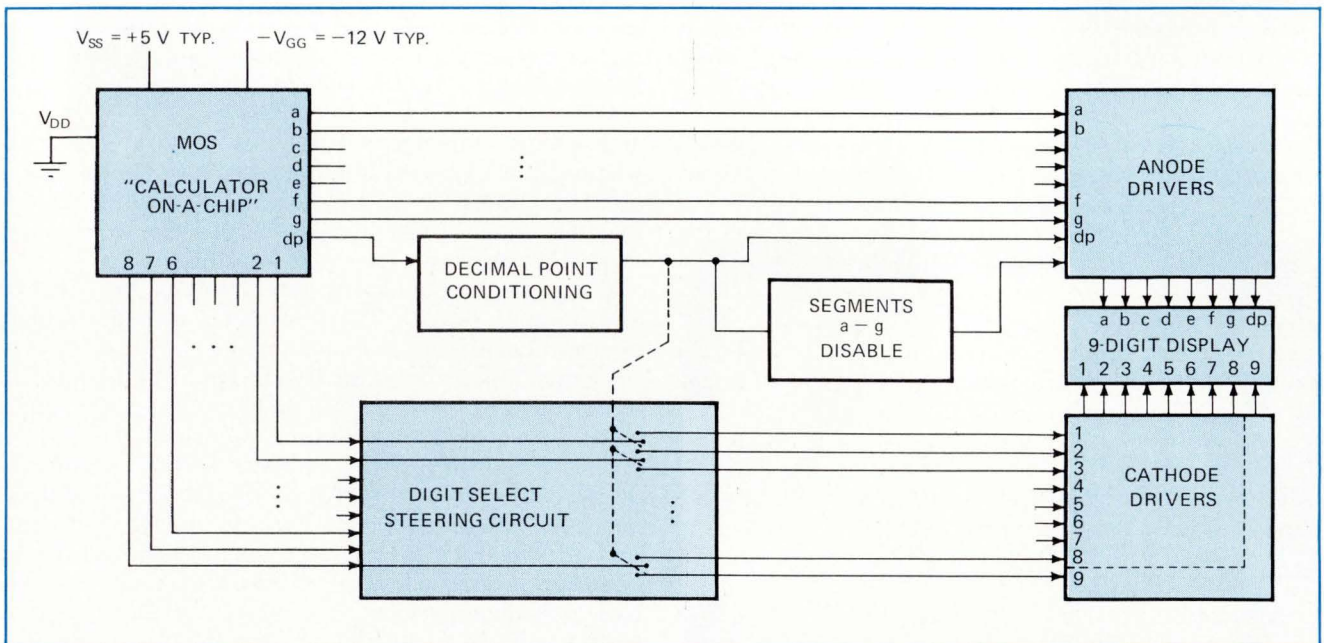

5. Cheap. Connecting the MOS calculator-on-a chip to the display drivers requires some thought but not much money. The steering and timing circuitry shown here can be put together for under \$2, using standard gates. Alternately, a custom chip can be designed.

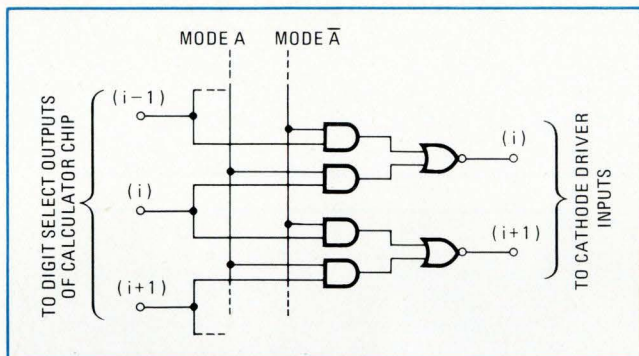

6. Steering the digits. In this implementation of the digit-select steering circuit, for characters to the left of the decimal point, the Mode A signal is a 1 and the Mode \bar{A} signal is a 0. Thus, the i^{th} digit is fed to the i^{th} cathode driver. For characters to the right of the decimal point, the signals are reversed, and the i^{th} digit goes to the $(i + 1)^{\text{th}}$ cathode driver.

timing signals for the i^{th} character are steered to the i^{th} cathode driver. For character information appearing to the right of the decimal point, digit timing signals for the i^{th} character are steered to the $(i + 1)^{\text{th}}$ cathode driver.

One way to implement the decimal point conditioning circuit is to connect a resistor and a capacitor in parallel between the decimal-point line and $-V_{GG}$. When the calculator chip's decimal-point line is activated, the character information appearing concurrently on the segment lines is displayed while the charging capacitor raises the voltage of the decimal point line toward V_{SS} . The capacitor is chosen so that after 85% of the time frame the voltage will forward-bias the transistors, enabling the decimal point driver and disabling the segment drivers. At the end of the time frame, the voltage decays at a rate set by the R-C time constant. The resistor is selected to produce cutoff of the enabling and disabling transistors after 15% of the next time frame.

A segment-disable circuit can be implemented by a single transistor used either as a series switch to disconnect the drivers from the collector supply voltage, or as a parallel shunt to short out the drivers. The relative decimal point pulse width used determines which technique consumes the least power.

One implementation of the digit-select steering circuit uses a series of dual, two-input AND-OR-INVERT gates, the basic cell of which is shown in Fig. 6. Each digit select line from the calculator chip is connected via AND gates to two cathode-driver inputs. A mode control signal and its complement are used to control whether cathode driver i or $i + 1$ receives the digit i select signal. To generate the Mode A and Mode \bar{A} digit-select steering signals, two transistors or inverting gates can be cross-coupled to form a bistable latch. The decimal-point timing pulse sets the latch while the pulse from the least-significant-digit select line resets.

Standard package is used

The display package outline matches that of a standard 14-pin DIP with 0.1-in. pin spacing and 0.3 in. between rows of pins. It is assembled on a DIP-type lead frame, rather than on a ceramic or plastic substrate that

uses round pins. Thus, standard DIP insertion tools and techniques can be used to load them quickly onto a pc board. The number of parts requiring loading and subsequent alignment is reduced by clustering five characters in a single package. This feature, along with fewer drill holes and simpler interconnect patterns, results in lower assembly cost. Longer character strings can be aligned by simple clip or clothespin techniques.

A well designed instrument has its display mounted so its image plane is normal to the most frequent viewing angle. For hand-held or desk-top applications, this usually means tilting the display at some angle to the instrument's main pc board. In the HP display, the shoulders of the lead frame pins are intentionally raised above the bottom of the package, so that the display can be mounted at an angle to the board. Mounting angles up to 20° are easily accommodated. The desired orientation can be achieved by either mounting the display at an angle to the board or by tilting a portion of the board itself. The former may require more elaborate assembly fixturing, while the latter may involve a flexible pc board or an additional board connected by a piece of flexible cable to the main board. A simple fixture (Fig. 7) has been developed to function as an alignment aid and insertion tool.

The display is wired with like segments of each of the five digits connected to the same anode pin, and the substrate of each digit brought out on a separate cathode pin. It is driven in the high-efficiency pulse or strobe mode, sequentially illuminating each character at a minimum of 100 times per second for a flicker-free appearance. In addition to being suitable for strobed driving, the internal wiring reduces the required number of pins from 45 to 13 for a five-character display.

The cluster approach to packaging, used in this display, is best suited to the handling of decoded, bit-parallel, character-serial data. However, other data forms can be easily accommodated. If the data is bit-parallel, character-serial but coded into BCD form, a simple BCD-to-7-segment decoder is used. If the information arrives bit-parallel, character-parallel, a dynamic shift register can provide the recirculating memory to convert to a character-serial format. As above, if the incoming data is in BCD form, a decoder should be inserted before the display. For fully serialized data, a serial-in, parallel-out shift register does the necessary conversion. □

7. Tilt. This combination alignment aid and insertion tool is designed to simplify mounting of the HP 5082-7405 display directly on a pc board at a 20° angle.

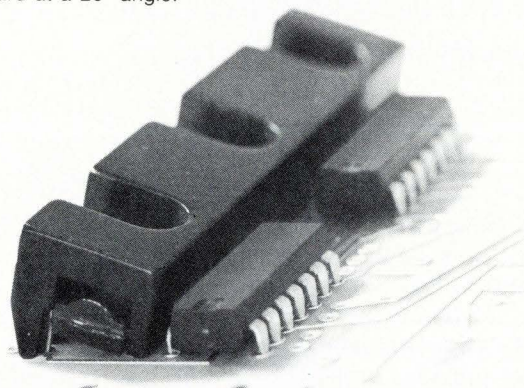

Designer's casebook

Bootstrapped capacitor stabilizes UJT oscillator

by Michael J. Debronsky
KDI/Labtron Corp., Dayton, Ohio

A highly accurate low-frequency relaxation oscillator can be built by making the circuit independent of the unijunction transistor's interbase resistance. Simply bootstrapping the voltage of the charging capacitor through a temperature-compensated zener diode back to the UJT's base₂ does the job. Good frequency stability can be attained—0.05% over a 0°C–55°C temperature range and 0.5% for a 100% change in the supply.

There are certain circuit conditions that must be observed, however, for good stability. The value of timing capacitor C₁ must be much greater than that of bypass capacitor C₂. The latter bypasses any zener noise to avoid output jitter. Moreover, current through timing resistor R₁ must be more than Q₁'s base current, and the UJT's voltage must be larger than the zener's.

C₁ is discharged by the UJT when its voltage is:

$$V_c = \eta V_z (1 - \eta)$$

where η is the intrinsic standoff ratio of the UJT, and V_z is zener voltage. Usually, the base-emitter voltages of Q₁ and Q₂ are small compared to V_z . Then:

$$V_c = \frac{1}{C_1} \int i(t) dt = V_z t / R_1 C_1$$

And output pulse duration becomes:

$$t = 1/f = \eta R_1 C_1 / (1 - \eta)$$

For 60-Hz operation, R₁ ranges from 10 to 50 kilohms, and C₁ must be greater than 0.001 microfarad.

Brief Fortran program for active low-pass filters

by Irvine P. Stapp, Jr.
University of Kentucky, Lexington, Ky.

A short computer program, written in 1130/1800 Fortran, makes it possible to design three-pole active low-pass Butterworth filters with gains between 1.00 and 2.00. What's more, the program can be easily translated into Basic computer language.

Unlike previous programs, the one shown in (a) uses

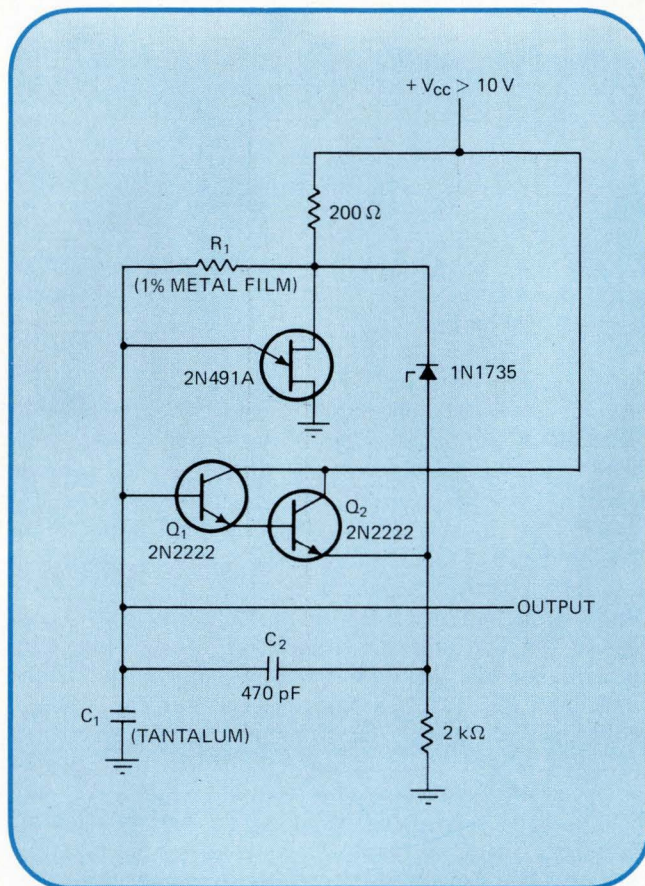

Tightening frequency stability. Low-frequency oscillator provides frequency stability of 0.05% over a temperature range of 0°C to 55°C. Bootstrapping voltage of timing capacitor C₁ back to base₂ of unijunction frees oscillator circuit from dependence on UJT's interbase resistance, the usual cause of instability. Temperature-compensated zener and bypass capacitor C₂ are also used.

a simple iterative procedure to converge on normalized element values, instead of solving for the roots of a cubic equation. This technique simplifies calculating gains other than unity. Finding capacitor values that are accurate to one part in 10⁷ (0.1 ppm) requires about 30 traversals of the iteration loop.

A filter designed with the program shown in (b) provides a 15-hertz cutoff frequency and a gain of 1.20. The filter is intended to drive a multiplexer input network with a gain of 1/1.20.

If a small amount of gain is included in an active filter, many scaling amplifiers frequently can be eliminated from a multiplexed analog-to-digital system where over-all gain must be maintained at some established value. For example, certain process control com-

puters, like the IBM 1800, require multiplexer input points to be preloaded with low impedances, in the order of 1 kilohm shunted by 0.05 microfarad. Only a few operational amplifiers can tolerate this much capacitance with a tight feedback loop. But many will function properly if decoupled from the capacitive load by about 100 ohms.

A sample of the program's output, also included in (b), shows the design solution: K is the number of iterations required to reach desired accuracy; L, M, and N are normalized capacitor values in farads for a 3-decibel

point of 1 radian per second. Besides capacitor values, the program finds the values for R_1 and R_2 that yield optimum filter gain.

Other common low-pass filtering functions can be realized with the program by modifying the iterative equations. A data card is needed to indicate the number of runs, followed by cards specifying, for each run, the desired cutoff frequency in hertz, the resistance level in ohms, and amplifier gain. Program statement 23 points out where the data should be placed on the card. The program is easily adapted for remote terminals.

(a)

```

21 WRITE (4,21)
   FORMAT('ELEMENT VALUES FOR 3-POLE LOW PASS BUTTERWORTH FILTER WITH
   1H PREASSIGNED GAIN BETWEEN 1.00 AND 2.00. '// ' K IS LOOP INDEX WHEN
   2 SOLUTION CONVERGED TO 0.1 PPM. '// ' L,M,N ARE CAPACITOR VALUES IN
   3FARADS, NORMALIZED TO 1 OHM, 1 RADIAN/SECOND.')
20 READ (3,20) NRUN
   FORMAT (12)
   DO 88 J=1, NRUN
   READ (3,23) F,R,G
23 FORMAT (T1,E13.6,T15,E13.6,T30,E13.6)
   AM = 1.
   AN = 1.
   AL = 1.
   E=G-1.
   DO 200 K=1,99
   BM=AM
   BN=AN
   BL=AL
   AL=2.-3.*AN+2.*AM*E
   AN=(2.+AM*AL*E)/(2*(AL+AM))
   AM=1./(AL*AN)
   IF (AL*AM*AN-1.E-04) 250,250,260

```

```

260 IF (ABS(BL-AL)+ABS(BN-AN)+ABS(BM-AM)-1.E-07) 300,300,200
250 E=E+1.E-05
200 CONTINUE
300 WRITE (4,22) K,AL,AM,AN ,G
22 FORMAT ('0',T3,'K=',I3 ,T21,'L=',E13.6,T38,'M=',E13.6,T56,'N=',E
113.6,T74,'G=',E13.6 )
   Q= 159154.9/(F*R)
   C1=AL*Q
   C2=AM*Q
   C3=AN*Q
   RK=R*1.E-03
   R1=3.*G*RK
   R2=R1/E
   WRITE(4,24) G,RK,F,C1,C2,C3 ,R1,R2
24 FORMAT ('0','FOR GAIN OF',F6.2,' AND RESISTORS OF',F6.2,' KILOHMS
1 A CUTOFF FREQUENCY OF',F9.2,' HERTZ REQUIRES'//' ',C1=',F9.6,3X
2,'C2=',F9.6,3X,'C3=',F9.6,1X,' MICROFARADS. OPTIMUM GAIN-SETTING RE
3SISTORS ARE '//' ',R1=',F9.4,3X,'R2=',F9.4,1X,' KILOHMS'//' ',I19
4(1H*))
88 CONTINUE
   CALL EXIT
   END

```

(b)

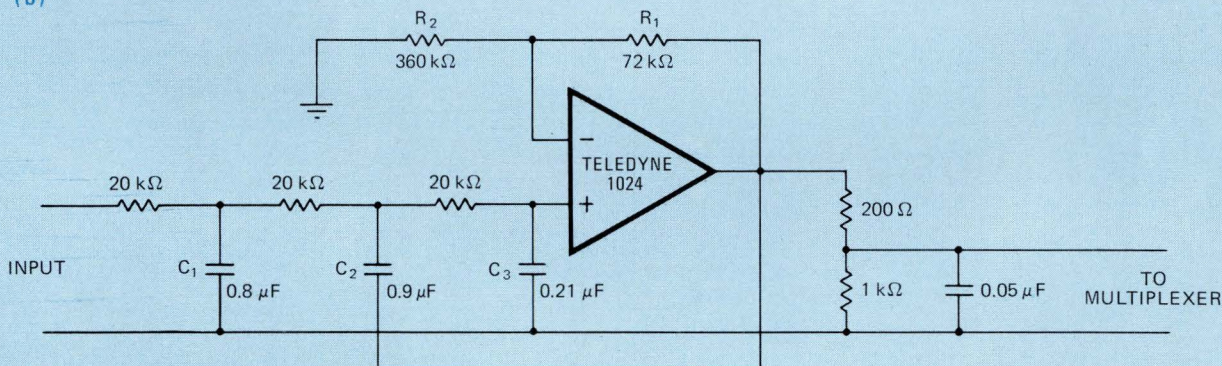

ELEMENT VALUES FOR 3-POLE LOW PASS BUTTERWORTH FILTER WITH PREASSIGNED GAIN BETWEEN 1.00 AND 2.00.

K IS LOOP INDEX WHEN SOLUTION CONVERGED TO 0.1 PPM.

L,M,N ARE CAPACITOR VALUES IN FARADS, NORMALIZED TO 1 OHM, 1 RADIAN/SECOND.

K= 29 L= 0.150211E 01 M= 0.169718E 01 N= 0.392253E 00 G= 0.120000E 01

FOR GAIN OF 1.20 AND RESISTORS OF 20.00 KILOHMS A CUTOFF FREQUENCY OF 15.00 HERTZ REQUIRES

C1= 0.796896 C2= 0.900386 C3= 0.208096 MICROFARADS. OPTIMUM GAIN-SETTING RESISTORS ARE

R1= 71.9999 R2= 360.0000 KILOHMS

Filter design. Fortran listing (a) eases design of three-pole active low-pass Butterworth filters. Program finds capacitor values and optimum-gain resistors. Filter gain is preset between 1.00 and 2.00; the value of ladder resistors is also fixed. Program uses iteration for extremely accurate capacitor determination. Design example for 15-hertz filter and sample of program output are given in (b).

Feedback current switch divides rf inputs by 20

by Roland J. Turner
RCA Corp., Missile and Surface Radar division, Moorestown, N.J.

In a ripple-carry binary feedback counter, counting down to 20:1 requires five binary stages, and the time it takes for the signal to pass through all five stages limits counting speed. But an analog counter that employs positive feedback around a single current switch stage requires only one transition period to establish the count. This current switch, which has a transition time in the order of 1 nanosecond, counts a 1-gigahertz signal down to 50 megahertz in one stage. Two switches in cascade, then, provide a 400:1 countdown.

The usefulness of the counter lies in its ability to provide a low-frequency sync signal that is locked to an rf carrier, so that full advantage can be taken of an oscilloscope's vertical bandwidth. The detailed characteristics of each rf cycle of the signal may then be observed on a scope with a low-frequency sync capability.

When an rf signal at the base of transistor Q_1 goes

positive, the base of transistor Q_2 is driven negative, turning Q_2 off. As the emitter current of Q_2 changes, the emitter current of transistor Q_3 is forced to increase, and starts positive feedback action through capacitor C_1 to the base of Q_2 . Additional positive feedback is fed from the collector of Q_2 to the base of Q_3 through C_2 .

During the recovery period of Q_2 , the current switch formed by Q_2 and Q_3 acts as a high-speed comparator, while the base voltage of Q_2 decreases toward ground. As soon as the most positive swing of the input signal exceeds the V_D bias at the base of Q_3 , positive feedback begins again, and the switch automatically resets itself to the initial state. Transistor Q_4 serves as an output buffer to drive another analog stage. The output is a square wave with a 2.2-volt peak-to-peak amplitude.

Potentiometers R_1 and R_2 control the initial bias condition of Q_2 and Q_3 , respectively. And the collector bias of both Q_2 and Q_3 is well above their saturation voltage. Moreover, when one of these transistors is in cutoff, it still has a 1-milliamperere idling current to assure that it maintains a high f_T .

The countdown of the circuit can be altered by returning R_2 to a different supply voltage.

Designer's casebook is a regular feature in Electronics. We invite readers to submit original and unpublished circuit ideas and solutions to design problems. Explain briefly but thoroughly the circuit's operating principle and purpose. We'll pay \$50 for each item published.

Divide-by-20 counter. Analog circuit counts down rf signal in one transition. For positive input, Q_2 turns off and Q_3 turns on, causing positive feedback to Q_2 's base. While Q_2 's base voltage approaches ground, Q_2 and Q_3 perform as high-speed comparator. When rf input exceeds Q_3 's base bias, positive feedback resets Q_2 and Q_3 to their initial state. Q_4 is buffer stage for output square wave.

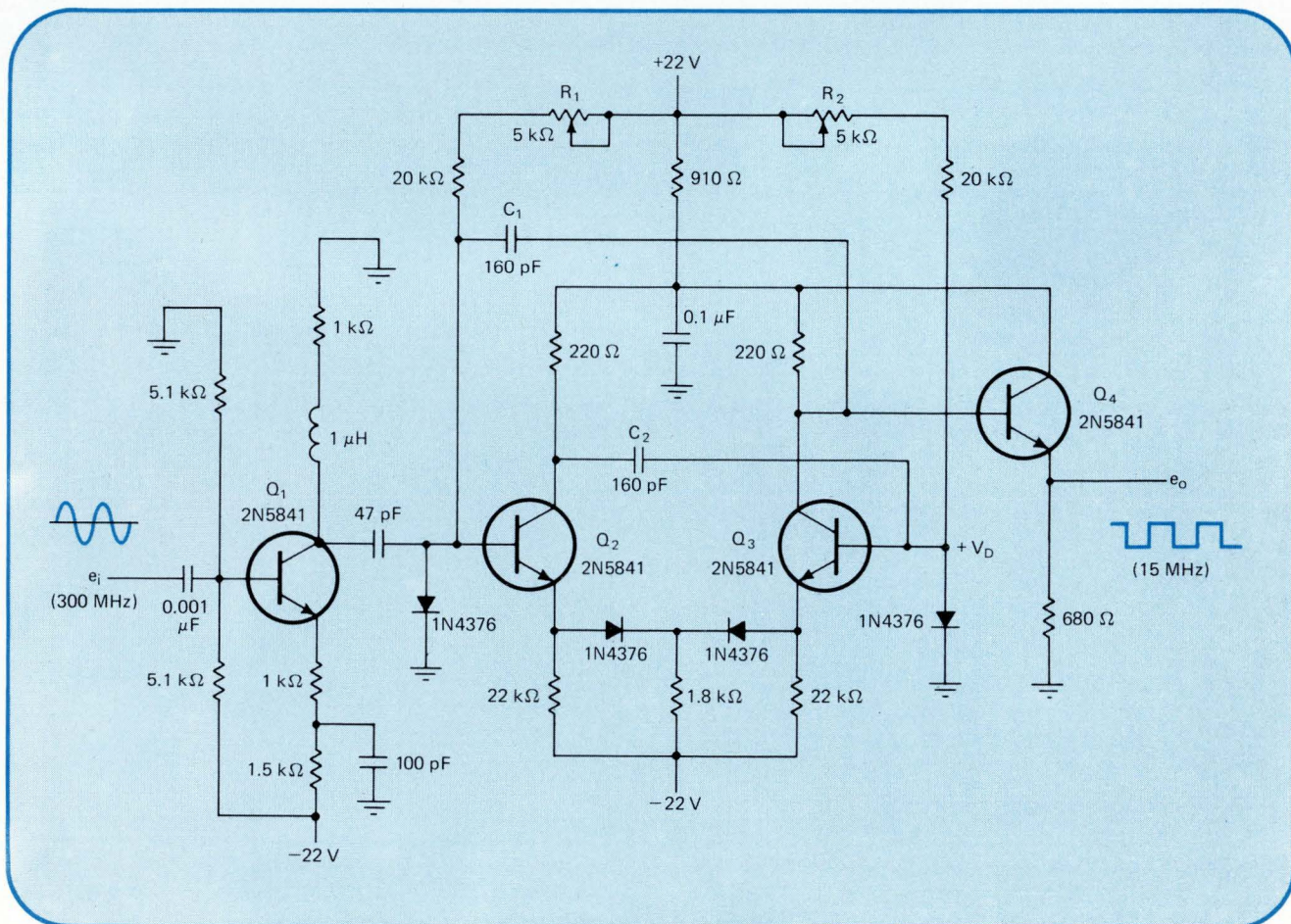

5 AMP Planar Hi-Rel Diodes



SDD500
DO-4 Case

**FAST RECOVERY
@ 5 AMPS**

FEATURING

- Planar Construction
- Operating Range from -55° to $+200^{\circ}\text{C}$
- Low Leakage Current ($15\ \mu\text{A}$ Typical @ 200°C)
- B_V to 200V
- Fast Recovery (150 nsec Typical @ 5A)
- Storage Temperature Greater Than 300°C

Solitron's new series of 5 Amp planar diodes is the only one of its kind now available to the industry for hi-rel switching applications. Why? Because the devices are constructed with a gold silicon hard eutectic die-mount. They utilize 12 mil 99.999% pure aluminum wire, ultrasonically bonded to 99.999% pure aluminum anode metalization.

Reverse Current Vs. Temperature

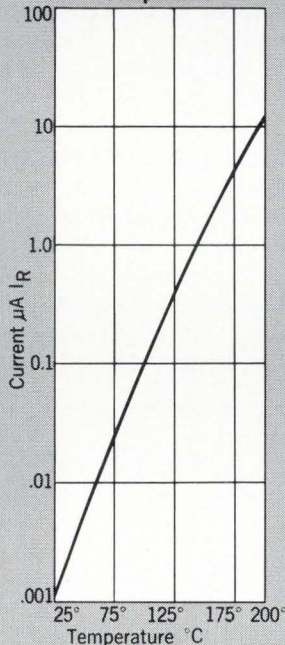

Forward Voltages Vs. Forward Current

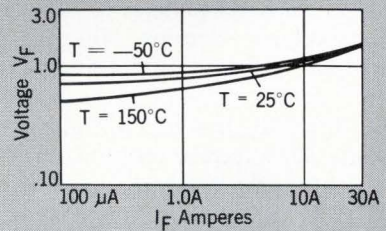

Forward Drop Vs. Temperature

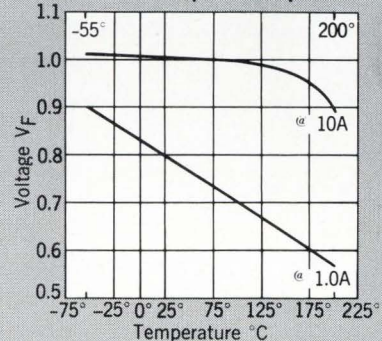

For complete information, prices and engineering application assistance, dial toll-free 1-800-327-3243. Or write:

Solitron

DEVICES, INC.

1177 BLUE HERON BLVD. / RIVIERA BEACH, FLORIDA / (305) 848-4311
TWX: (510) 952-7610

SAN DIEGO, CAL.
8808 Balboa Avenue
FET & Dual FET
Transistors
MOS/FET Devices
MOS Memory Arrays
Shift Registers
Monolithic IC's
Small Signal
Transistors

RIVIERA BEACH, FLA.
1177 Blue Heron Blvd.
Hi-Rel Power Transistors
SI & Ge. Power
Transistors
Hi-Rel Power Hybrids
PNP-NPN Industrial
Transistors

PORT SALERNO, FLA.
Cove Road
Microwave Connectors
Plaxial (R) Cable
Precision RF Coaxial

JUPITER, FLA.
1440 W. Indiantown Rd
Microwave Stripline
Components
Microwave Semiconductor
RF Semiconductor
Microwave Integrated
Circuits

TAPPAN, N. Y.
256 Oak Tree Road
Diodes & Rectifiers
Zeners
High Voltage
Assemblies
Power Rectifiers
Thick Film Hybrid
Circuits
Ferrite & Ferrite Devices
Film Resistors

KENT, ENGLAND
Tubbs Hill House
London Road,
Sevenoaks
Solidev, Ltd.
Full line of
Solitron devices

BEN BARAQ, ISRAEL
51 Hayarkon Street
AEL Israel, Ltd.
Full line of
Solitron devices

TOKYO 105, JAPAN
No. 5, 3-Chome
Shibahamamatsu-Cho
Minato-Ku
Matsushita Electric
Trading
Full line of
Solitron devices

Solid state design amplifies vhf to kilowatt level

Experimental 32-transistor configuration yields double the efficiency of tubes and surpasses performance of all competing designs, delivering 1 kW of broadband cw power for such uses as airborne communications

by Louis W. Simon, Avco Corp., Electronics Division, Cincinnati, Ohio

□ Achieving a kilowatt of broadband continuous wave power at very high frequencies is a task that in the past has been reserved solely for vacuum tubes. But test results from an all-solid-state amplifier show that transistors can do the job—and in some cases, do it better. The higher efficiencies achieved make the vhf solid state amplifier attractive for such applications as airborne fm communications transmitters where onboard power is at a premium.

Even considering radio frequency losses in a network that combines the output powers of 32 transistors, the amplifier yields efficiencies which exceed those of all other competing designs. The feasibility model described here operates from 100–180 megahertz with an efficiency greater than 35%—about twice that of existing vacuum-tube distributed amplifiers.

The measured power output of the amplifier is 1 kilowatt cw from 100–160 MHz and drops to 500 w at 180 MHz. The input power to the pre-driver ranges from 1.5 w at the low end of the band to 3 w at 180 MHz.

The predicted mean time between failures for the solid state unit is calculated to be 1,400 hours, which compares quite favorably with existing broadband vhf amplifiers. The amplifier, which weighs 65 pounds, occupies a volume of 1.8 cubic feet. It is estimated that these quantities could be reduced by 30% in production designs.

The amplifier development has been partially supported by the Air Force. Using similar techniques, a 225–400-MHz amplifier could be built for military aircraft, or a 1-kw narrowband unit could yield efficiencies even greater—close to 50%.

The amplifier design is structured around five 250-w power modules. One module is used as a driver and four parallel modules form the final output stage (Fig. 1). The low-level input stages are standard commercial laboratory units, which were used to demonstrate the feasibility of achieving a high-gain, high-efficiency amplifier system.

Four-way dividers and combiners connect the power

1. Amplifier system. The amplifier hardware (far right) includes a pre-driver, driver, and the final 1-kW output stage. A modular design (below) allows the use of 5 identical 250 W units (one in the driver and four in parallel in the output). The low-level input stages are commercial laboratory units and were used in this prototype to show the feasibility of achieving a 90-dB-gain amplifier.

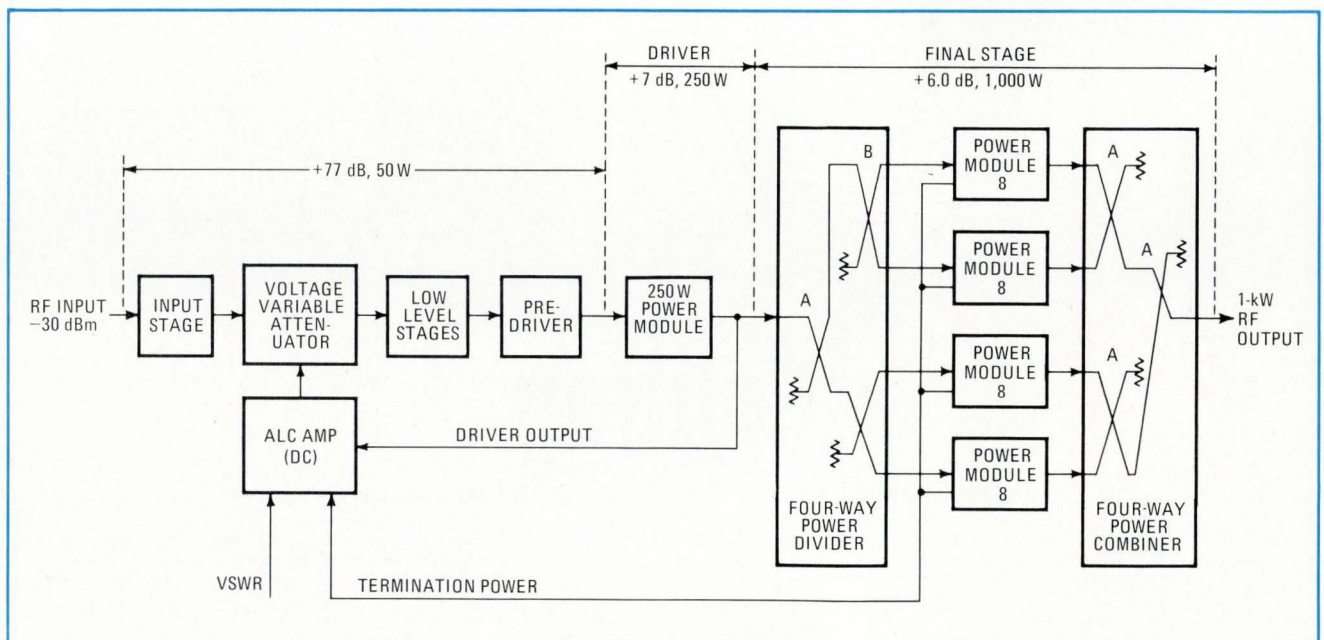

modules in the final stage. All dividing and combining networks use 3-decibel, 90° hybrid circuits in stripline. Couplers marked A in Fig. 1 are both electrically and mechanically identical and are designed for 1-kw operation. Insertion loss is less than 0.05 dB for the single-section design used. The B couplers use a three-section design for a more broadband frequency response, at the expense of added insertion loss and increased size and weight.

Inside the power module

The 250-w power module (Fig. 2) divides a 50-w input eight ways yielding a 6-w drive for each of eight transistor stages. Three layers of tandem hybrids are required for this function. Identical circuitry is used in the output hybrid couplers to give a total module power of about 260 w.

The single 50-w transistor stage, which uses a Motorola MM-1552 device, is repeated eight times in each of the five power modules, or 40 times in the total amplifier. To obtain reliable performance and simple design, the number of components in the transistor stage is minimized (Fig. 3).

The input impedance characteristics for rf power transistors do not allow matching to a voltage standing wave ratio of less than 7.0 over an octave band. By use of a 90° hybrid divider, transistor input vswr's of 7.0 at the low end of the band can be tolerated as long as the mismatches are consistent for all the transistor inputs.

Mismatch power at the low end of the band is dissipated in the termination. By providing a match at the high end of the band and using the divider, mismatch loss at the low end compensates for inherent higher power gain. The result is a nearly flat response for the transistor pair. At the input to the divider feeding two transistors, the worst case vswr is 1.3 across the band.

The collector load impedance must be very nearly resistive for efficient operation. Since the transistors are

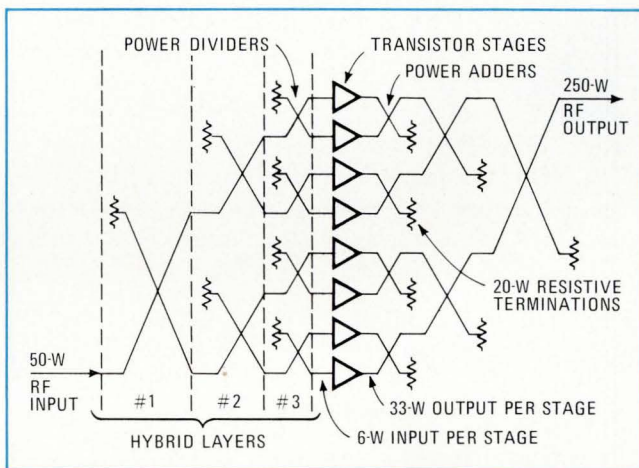
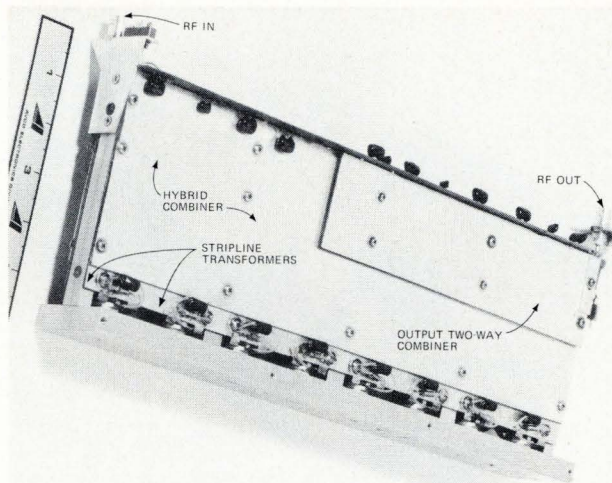

2. Power module. Following the modular design, three hybrid layers used as input dividers are also used in the output combining circuitry. Stripline impedance transformers (from 50 ohms at the transmission line to 5 ohms at the transistor) also use the same hardware in both input and output stages. All resistive terminations in the hybrid couplers have 20-W ratings.

operated close to saturation for high efficiency, the load impedance is determined from the supply voltage used and the amount of power output desired. Transistor matching networks are designed in stripline, using both lumped constants and stripline transformers.

At the time of design, transistor manufacturers' specification sheets lacked broadband performance data. Due to impedance variations over octave bandwidths, gain and power specified at 10% bandwidth had to be derated by almost 50%. A typical device rated at 90 w and 9-dB gain would yield only 50 w at 6- to 7-dB gain for an octave bandwidth. Today several available transistors provide broadband performance when a transistor fails.

The coupling networks within the power module also use 3-dB, 90° hybrids. An analysis of the coupling networks shows what size termination is required under worst-case conditions—a transistor failure causing an infinite vswr at the hybrid ports.

First consider the output of the transistor circuit (Fig. 4a). Zero insertion loss, no phase errors, and infinite isolation are assumed. The properties of a 90° hybrid are

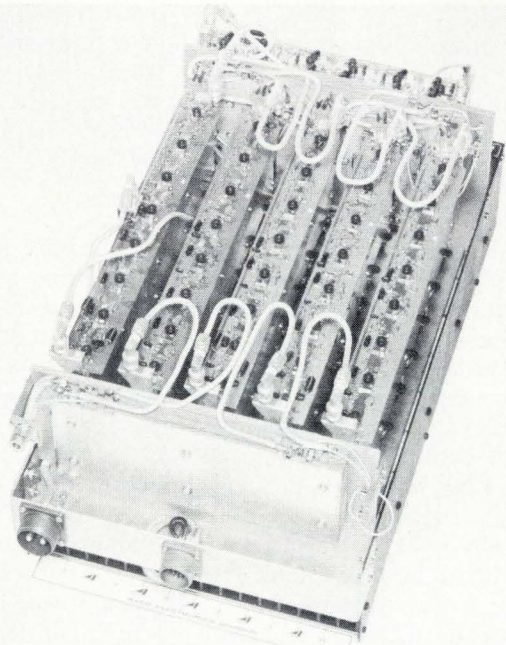

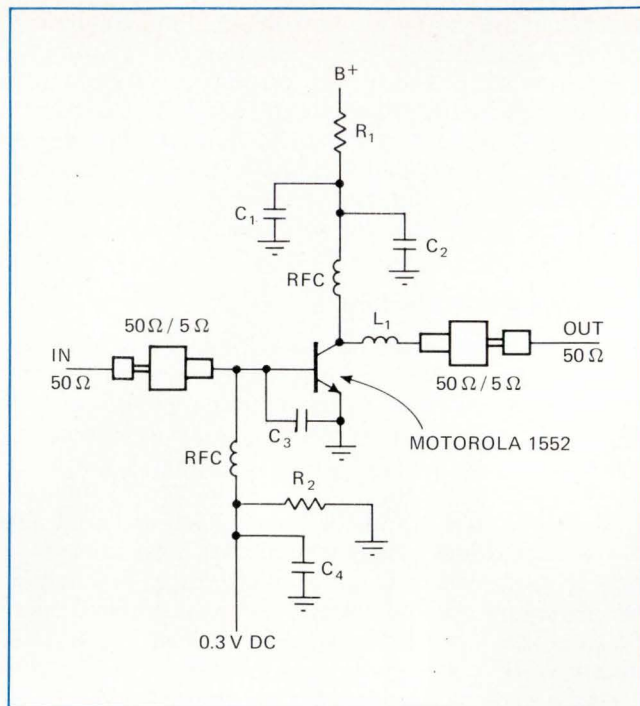
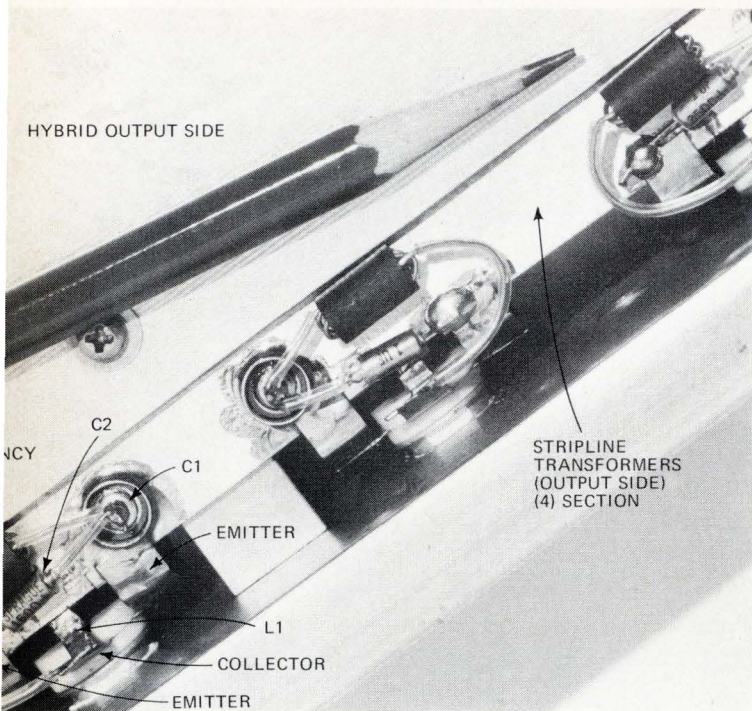

3. Identical circuits. Single transistor stage is repeated 40 times in the overall amplifier. The number of components is minimized to obtain reliable performance and design simplicity. Transistor heat-sinking and the transistor-stripline interface are illustrated in the photo of the collector outputs of three parallel transistor stages.

such that the power out is:

$$P_o = P_1 + P_2 + (P_1 P_2)^{1/2} \quad (1)$$

Then power into the termination is:

$$P_T = (P_1 + P_2) - P_o \quad (2)$$

Thus, for a hybrid in the first output layer with one transistor failure, $P_o = 16.5$ w and $P_T = 16.5$ w. For the second layer, $P_o = 74.2$ w and $P_T = 8.3$ w. And for the final layer, $P_o = 202.1$ w and $P_T = 4.1$ w.

Note that the drop in overall power due to one transistor failure is $250 - 202.1 = 47.9$ w. The highest power dissipated in a termination is the first output layer—16.5 w. Therefore, 20 w terminations were chosen for this amplifier. If more than one device fails, the termination loading can get worse.

Termination loading is less severe in the input coupling network (Fig. 4b). The maximum power reflected into the termination is 12 w for any mode of failure. Therefore, the 20-w terminations are adequate in the input hybrid network.

Circuitry has been provided to protect the terminations in the event of multiple device failure or other termination burnout. A simple diode detector (Fig. 4c) is connected at the terminations in the output hybrid combiners. If any one termination dissipates more than 20 w, the rf input to the power amplifier is reduced by automatic level control circuitry.

Toward a linear power transfer

Although eliminating non-linear distortion was not a primary consideration for the type of modulation for which the amplifier was designed, an attempt has been made to linearize its input-output power transfer characteristics. The dominant factor contributing to non-

linear distortion is the saturation of the transistor at the high-power end of the power transfer curve. But on the low end of this curve, a few dB improvement in third-order intermodulation distortion is achieved by forward biasing the transistor-emitter junction.

A bias of 0.3 v is chosen to allow low-level signals to ride a little higher into the amplifier's linear region. A slightly larger bias, while improving small-signal operation, would allow the junction temperature to increase, leading to thermal regeneration and self-destruction of the device. While closed-loop methods could be designed to control the base voltage, the number of components required (times 40 for the system) prohibits their use.

Typical distortion measurements show a third-order intermodulation product improvement from -15 to -18 dB with the 0.3-v bias applied. The test was made using two signals at 140 MHz separated by 300 kHz. The test signals measured 30 w peak-to-peak at the output.

Packaging and cooling

Chief factors considered in the mechanical packaging of the amplifier included signal flow, cooling, size, and weight. Consistent with the modular concept, transistors are mounted on an intermediate heat sink. This module also includes the stripline matching transformers, and the stripline hybrid couplers. These intermediate heat sink modules are then attached to a primary heat exchanger of extruded aluminum. It has 18 fins, each 1 3/4 inches high with 3/4-in. spacing, that runs the total length of the amplifier.

Forced air cooling is required for the main heat exchanger with an air flow rate of 160 cubic feet per minute. Under these conditions and with an ambient air temperature of +50°C, the calculated junction tem-

perature of the hottest transistor is less than 170°C. This cooling capability is equivalent to an effective heat transfer of 9,180 British thermal units per hour.

The predicted 1,400-hour MTBF for the solid-state amplifier is based on single-part failures, and the following assumptions: all standard components use failure rates per MIL-HDBK-217; ambient operating temperature is +65°C; stress ratios are 30% for the low-level transistors, 10% for diodes, 30% for resistors and 50% for capacitors; and the failure rate for rf power transistors is 1% per 1,000 hours.

The actual MTBF would be several times this figure if a degradation of 2 dB were permitted at the output. The increased MTBF is due to built-in redundancy in that several transistors can fail before the power will degrade by 2 dB.

Getting even higher powers

The most direct way to increase the total power output, while maintaining all other desired parameters, is to use higher-powered transistors. This, of course, is dependent on state-of-the-art transistor design and, no doubt, will improve with time. Progress in achieving these transistors is inhibited by severe problems of impedance matching across large bandwidths, but these barriers can probably be crossed.

Assuming that device parameters are fixed, power output can be increased by adding more transistors. But, again, this approach has its limiting factors. First, consider the case of narrow-band (5–10%) operation. As more transistors are added by adding more hybrid layers, the insertion loss of the hybrid tree increases. Eventually, the insertion loss would cancel the power gain of the single stage.

For example, assuming 0.2-dB loss per hybrid layer, seven layers on both the input and output hybrid networks would cause a total gain reduction of 2.8 dB. Seven layers, however, would allow the combining of 128 transistors, possibly producing 4–5-w output power. If size and weight permit, the insertion loss per hybrid could be reduced to 0.15 dB, which would probably be necessary to lower the power dissipation in the output hybrids. Narrow-band power in the 20-w region might then be achieved.

For octave bandwidths, three primary factors limit the ultimate achievable power output by adding more layers in the hybrid network:

- Deviation from an ideal power split,
- Deviation from equal phase shift through each single-stage amplifier, and
- Variation in gain of each single-stage amplifier.

The problem in adding more hybrid layers is illustrated in Fig. 5. Typical vhf performance curves show that, at the center and edges of the band, the division of power differs by approximately 0.4 dB. This characteristic imposes a limitation on the number of transistors that can be combined using tandem hybrid networks.

When using several layers of hybrids the power variation of one hybrid at a given frequency is multiplied by the number of tandem layers. Thus, when 32 transistors are driven in this manner, some of the transistors will experience drive levels differing from others by as much as 2 dB (5 layers times 0.4 dB per layer).

4. Terminations. Failure of a 33-W transistor at P_1 or P_2 results in 16.5 W dissipated in the 20-W termination (a). Maximum dissipation of only 6 W, however, is required of the terminations in the input hybrid dividers when a transistor failure occurs (b). Simple detector circuits protect terminations if terminated power exceeds 20 W (c).

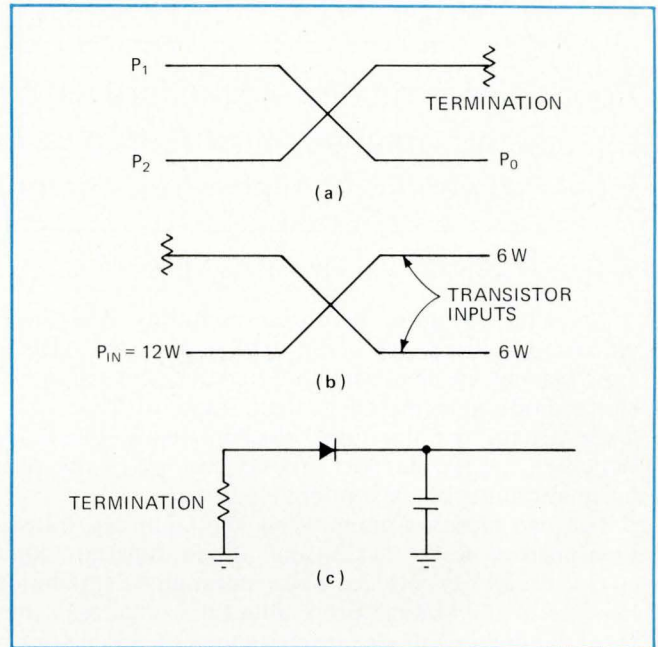

To combat these limits, multi-section hybrid couplers might be used to provide a better frequency response than the single-section designs. Also, phase compensation can be used to advantage. To control the power gain variation, transistors could be selected or automatic gain control circuitry employed. Using these designs the present upper limit for broadband operation is in the 5–10-kw range. The advantage of high efficiency—(30–40%)—could still be maintained. □

5. Broadband limit. Power at the two output ports of the octave vhf hybrid differs by about 0.4 dB, both near the center frequency and at the band edges. This property limits the number of hybrid layers that can be used, since each layer increases separation between the drive levels of the transistor input stages fed by divider network.

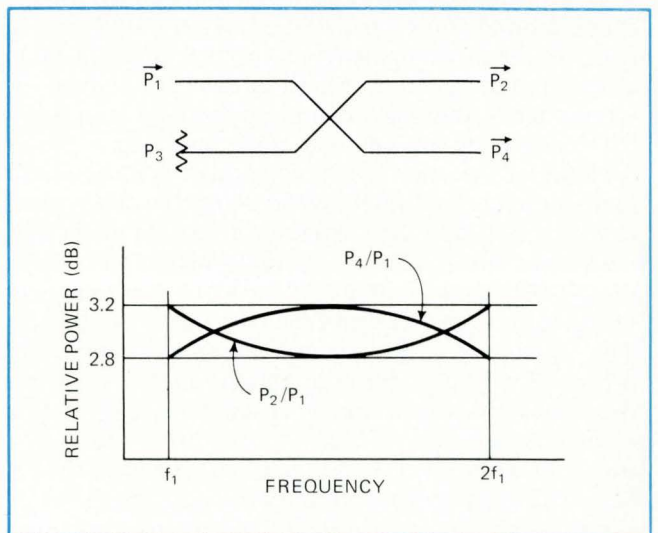

Diode switching matrices make a comeback

Poor noise immunity of standard logic gates has restricted diode use, but cost advantages of matrices now can be realized by constructing these networks with high-noise-immunity integrated circuits

by Dave Guzman, Teledyne Semiconductor, Palo Alto, Calif.

□ Since the advent of high-noise-immunity logic, diode switching matrices are being used more extensively in logic systems, particularly those for code conversion, because diode gates cost less than standard logic gates. Once a very popular logic building block, the diode switching matrix had lost ground because of the poor noise immunity of conventional logic gates.

The two most common 5-volt logic families, transistor-transistor logic (TTL) and diode-transistor logic (DTL), usually experience noise immunity degradation because of the voltage drop, about 0.7 V, across a forward-conducting diode. Improvement in circuit noise immunity becomes important for code conversion applications, such as decimal-to-excess-three encoders. And substituting a simple diode gate for a standard gate can reduce parts costs—often by a factor of four.

A noise immunity problem arises whenever simple diode gates are driven by conventional TTL or DTL. Since noise immunity voltage for any gate is the difference between the guaranteed input threshold voltage and the gate output voltage, the already narrow 400-millivolt noise immunity offered by most TTL is easily exceeded by the additional diode voltage drop.

Noise immunity: problem and solution

Suppose a simple diode AND gate is driven by a standard TTL active output gate whose maximum output voltage in the logic 0 state is 0.4 V. As shown in Fig. 1(a), the forward-biased diode at input A, which drops around 0.7 V, makes the logic 0 output voltage (V_{OL}) of the driving gate equal to 1.1 V. Since the guaranteed input logic 0 threshold of conventional TTL devices is 0.8 V, the noise immunity becomes $0.8 - 0.4 = 0.4$ V, exceeding TTL's 400-mV noise immunity.

Consider the same circuit when high-noise-immunity logic is used, as indicated in Fig. 1(b). Now, the guaranteed driving gate V_{OL} increases to 1.5 V and the guaranteed input threshold increases to as high as 5 V. Adding the 0.7-V diode drop to the 1.5-V V_{OL} of the driving gate brings the output voltage of the diode AND gate to 2.2 V. The worst-case logic 0 noise immunity becomes $5 - 2.2 = 2.8$ V. Many devices in high-noise-immunity families have open-collector or passive pull-up outputs whose guaranteed V_{OL} is 0.5 V. Then noise immunity of the diode AND gate is better yet: logic 0 output is $0.5 + 0.7 = 1.2$ V, and noise immunity is $5 - 1.2 = 3.8$ V.

This significant improvement in noise immunity over

that of conventional TTL becomes important for code conversion applications; for example, decimal-to-excess-three encoders that use keyboard switch inputs. With high-noise-immunity logic, the keyboard switches can be located remotely from the logic cards, and worst-case noise immunity can be as high as 4.3 V.

The excess-three encoder of Fig. 2(a) consists of 10 keyboard switches, four high-noise-immunity dual-input NAND gates and several diodes. Essentially, the encoder uses the same principle as the simple diode AND gate. As individual keyboard switches are closed, the diodes tied to the supply voltage through pull-up resistors become forward-biased. In this case, the diodes are wired to make the input to the NAND gates the complement of the desired excess-three code.

The NAND gates restore the input signal levels for full noise immunity in the system. An inhibit line is also provided to block or transfer data from the keyboard switches into the system logic.

This encoder, however, may present a problem since its output becomes 1111, which can be mistaken for some other number, causing an unwanted output when the inhibit line drops low. A more usable circuit is one whose output goes to 0011, the excess-three code for

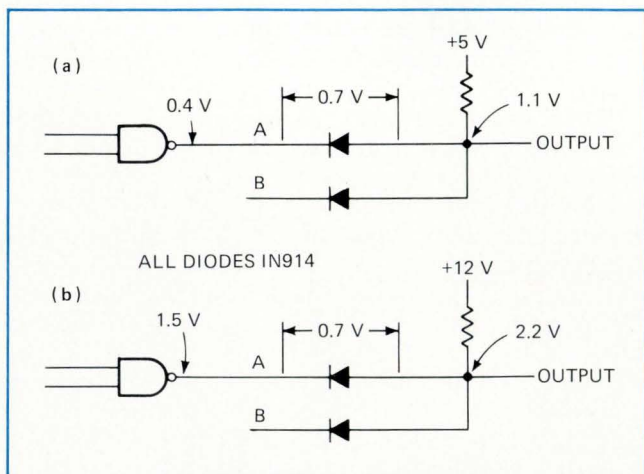

1. Noise immunity. When conventional TTL gate with active output drives diode AND gate (a), noise immunity of TTL driving gate is exceeded because of the diode's forward voltage drop. Using high-noise-immunity logic driving gate (b) solves the problem since its guaranteed input threshold is 5 V, rather than the 0.8 V of standard TTL. Noise immunity, which is 0.4 V for (a), increases to 2.8 V for (b).

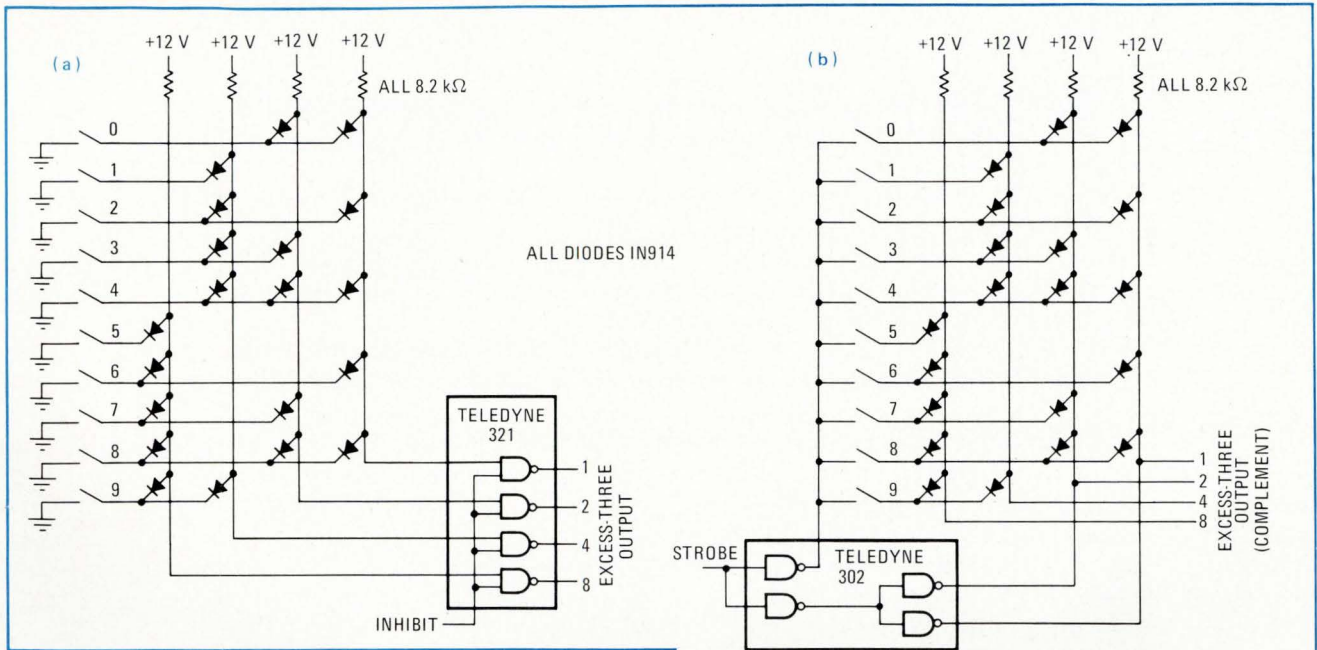

2. Excess-three encoding. Diode matrix (a) converts keyboard switch inputs to complementary excess-three code. NAND gates invert the signal and restore signal level. Another arrangement (b) codes the 1111 output, which could be mistaken for another number, to 0011 (excess-three code for zero) whenever strobe line goes low. Third encoder (c) employs quad latch for interfacing keyboard outputs with holding register. In this switching matrix, the diodes provide a true, rather than complementary, excess-three output code.

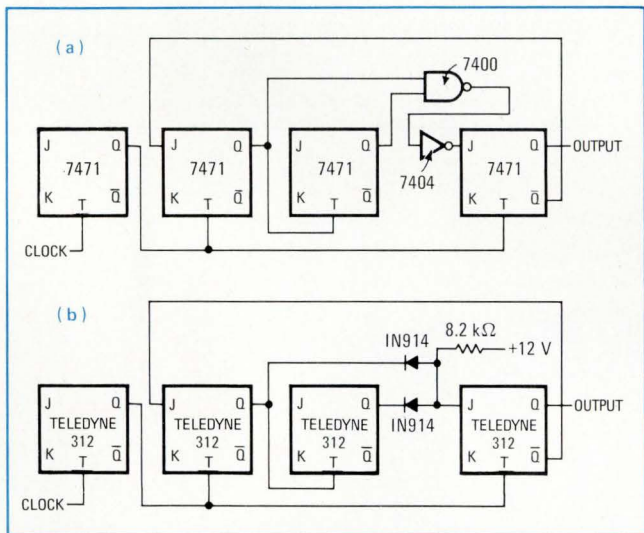

3. Saving dollars with diodes. Substituting a simple diode gate for standard logic gates can considerably reduce parts cost—often by a factor of four. For example, serial NAND gate and inverter (a) of BCD decoder/counter can be replaced by diode AND gate (b).

zero, rather than 1111. To implement such an encoder, shown in Fig. 2(b), several NAND gates are used to disconnect all keyboard switches from their common ground and to ground output lines 4 and 8. This corresponds to the complement of 0011. Since the NAND gates are open-collector devices, the matrix resistors serve as pull-ups for the NAND gates, while protecting their outputs from being grounded.

Another encoder variation should be implemented if

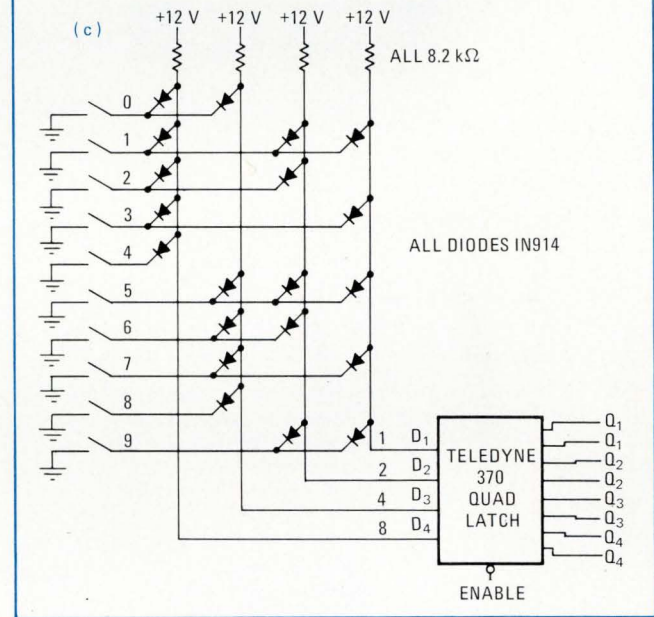

the keyboard outputs must be fed into a holding register, as indicated in Fig. 2(c). Here, the diodes are connected within the matrix to provide true excess-three outputs, rather than the complementary form. These outputs then drive a quad latch, which consists of four Type D flip-flops. The latch is provided with an enable input that prevents data from being entered into the flip-flops, except when the enable line is low.

Besides encoder circuitry, diode gates can be used extensively in combinational logic. For example, many circuits in digital systems use NAND gates followed by inverters. In most instances, this common configuration can be replaced by a simple diode AND gate, at cost savings as high as four to one. The BCD decoder/counter of Fig. 3(a) provides a typical circuit for diode gate substitution. In Fig. 3(b), two diodes and a resistor replace the NAND gate and inverter. □

Heath/Schlumberger?

That's right...Heath/Schlumberger. A new name in design-quality, factory assembled and calibrated instruments.

The "Heath" part of our name comes from being a division of that well known manufacturer of kits. But we don't make kits. In fact, Heath/Schlumberger is an entirely separate operation.

The "Schlumberger" (pronounced Shlum-bear-zhay) part of our name comes from being a member of that world-wide corporation devoted to measurements of many kinds. Schlumberger is one of the leading European manufacturers of electronic instrumentation.

With that background, you can see why we're producing state-of-the-art, ready-to-use, instrumentation...comparable to some of the best in performance...but with better performance/price ratios.

So when you're ready to buy electronic instruments, remember us. We're the group to watch.

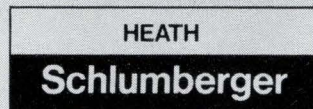

HEATH/SCHLUMBERGER
SCIENTIFIC INSTRUMENTS
BENTON HARBOR,
MICHIGAN 49022

To order or receive additional information, write Dept. 520-28.

- A. SM-104A 80 MHz counter. BCD output. 1 MHz TCXO with 1 ppm/yr. stability. \$500.
- B. EU-205B solid-state strip chart recorder. 23 speeds, 30 in/min. to 0.2 in/hr.; 18 calibrated ranges, 1 mV to 500 V full scale. 0.5 sec. pen response. 0.1% tracking accuracy and linearity. Completely programmable. \$675.
- C. EU-70A solid-state dual trace scope. DC-15 MHz. Complete dual trace capability. Triggered sweep. 18 calibrated time bases. X-Y capability. \$595.
- D. SM-105A 80 MHz counter. Same as SM-104A above but without BCD output and uses a 1 MHz crystal with ± 10 ppm/yr. stability. \$350.
- E. EU-81A function generator. Sine, square and triangle wave output. 0.1 Hz to 1 MHz. Linear dial. External voltage control. \$245.



EK-317

Trimmers take a turn for the better

Few circuit designers like the idea of paying for a set-and-forget trimmer, however essential, but lower cost, improved performance, and smaller size keep trimmers on the design scene

by Harry R. Karp,
Special Issues Editor

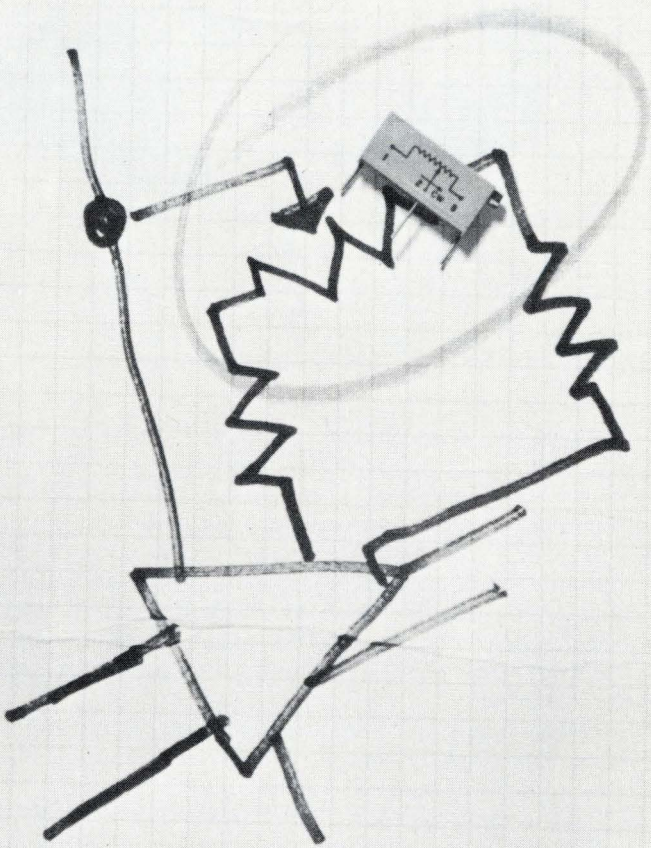

□ Despite efforts to design them out of electronic circuits, adjustable-resistance trimmers keep showing up in new applications. They remain one of the least expensive ways of adjusting over-all circuit performance during product assembly, largely because makers have cut their cost to 30% to 50% of former levels and have shrunk their size to meet the demands of printed circuit board packaging density.

Trimmer buyers, sensing their strength during the recent economic doldrums, have kept up the pressure for still further reductions in cost along with still better performance. The manufacturers are responding. To cut production costs, they have revamped trimmer designs to contain fewer parts for assembly, use more injection-molded plastic parts, and employ more automatic manufacturing. In addition, they have become more knowledgeable about resistor materials, particularly cermet, so their yields have gone up.

The trimmer makers also report a change in the orientation of the user engineer. Five or six years ago, when military requirements were pushing trimmer technology, he tended to specify the "best" that could be obtained. But today's industrial user is more realistic, and matches trimmer specs—and cost—closely to the application.

The upshot is that today electronics engineers pay less for upgraded trimmers. Figure 1 shows a CTS of Berne model 185 multiturn cermet trimmer, introduced in the early 1960s, that sold then and still sells for about \$2 in production quantities. On top of it is an improved model 192 trimmer, brought out in 1970, that sells for 70 cents and is about a sixth the volume of 185. A recent innovation is a trimmer resistive network (TRN), which includes four fixed resistors and one trimmer resistor, all cermet, screened on the same ceramic substrate and housed in a $\frac{3}{4}$ -inch-long trimmer package (Fig. 2). The trimmer alone sells for about 60 cents, and the TRN unit for "less than a dollar," says Walter L. Kercho, marketing vice president of Amphenol Controls division, Janesville, Wis.

The choice before the buyer

Specifications and costs exhibit a considerable range, from an 8 cents sprayed-carbon, open-construction trimmer for low-cost consumer products to a \$2-or-more, metal film, well-sealed trimmer for an ultrahigh-performance circuit. The range is contained in Table 1, which outlines trimmer price/performance factors. The structure of this table results from a discussion with Ervin E. Liban, manager of variable resistor sales at Al-

len-Bradley Co., Milwaukee, Wis. The specific information represents a consensus derived from data supplied by many trimmer manufacturers.

The breakout shows that a cost-conscious electronics engineer has a wide choice of trimmer grades in which price and performance are closely related. Electrical performance in the circuit is, of course, paramount, but also involved are such cost factors as whether the case is made of flame-retardant materials, whether the trimmer will be mounted in a dual in-line package for automatic insertion (Fig. 3), and whether a higher-cost multiterminal trimmer (Fig. 4) is required to assure accurate and easy setting of the required resistance.

Military fallout

Many lower-cost industrial trimmers now reflect the influence of military specifications on configuration and performance. Figure 5 shows a potpourri of such trimmers from just one company, Dale Electronics Inc., Columbus, Neb. The industrial and military types are very much alike, the main reason for the higher cost of military trimmers being extensive testing and documentation. About the only major difference is in maximum operating temperature, says Robert Klug, Dale's engineering manager. Military trimmers are rated for maximum temperatures of 150° or 175° C, while industrial/commercial types have maximum temperatures of 105° or 125° C. This lower rating permits the use of cheaper thermoplastic materials in industrial trimmers, compared with thermosetting materials in military-application trimmers.

For these reasons, the adjustable trimmer remains a low-cost way of compensating (trimming) during circuit assembly for the net effect of the tolerances of other components. It also permits field calibration—of an instrument, for example—to compensate for subsequent component aging and circuit drifting.

Basically, the trimmer is a set-and-forget component. It does not have to survive many cycles of abrasive wear of the slider against the resistance track. This limited rotational life requirement distinguishes a trimmer from its progenitor, the longer-lived potentiometer.

Good setting for forgetting

Even though a trimmer is a set-and-forget device, a factor of major importance is how accurately and easily the trimmer can be set to a prescribed value and how well it retains its setting. Makers of the better grades of trimmers have therefore concentrated in recent years on improvements in the nature of the resistive-track material, the slider-contact design, and the mechanical fineness of the over-all package. This effort, which will be detailed later, has permitted cermet and metal film trimmers to encroach on application areas formerly the preserve of wirewound trimmers.

While manufacturers have improved trimmers and

2. Network. Trimmer package by Amphenol Controls includes four fixed cermet resistors on same substrate as trimmer resistor. Each resistor bears a fixed ratio of resistance to other resistors in standard packages, but concept will probably be most successful in custom configurations. At right is Centralab's carbon film trimmer with two fixed carbon resistors, priced at 17 cents in lots of 5,000.

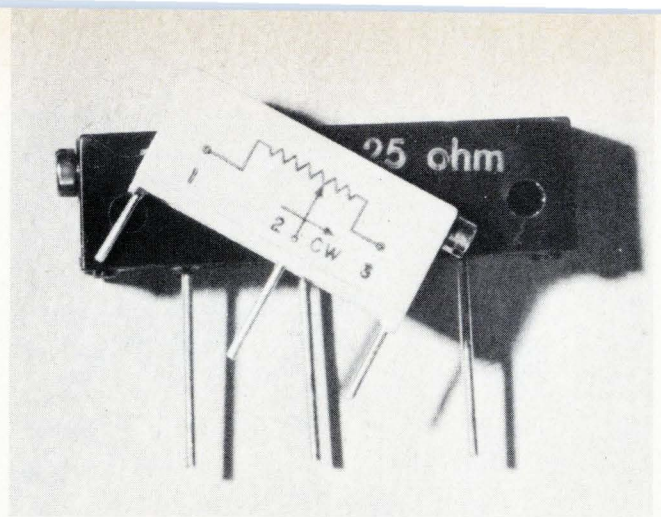

1. Reduced. Meeting demands for smaller components for pc board mounting, trimmer at top occupies a sixth the volume of its predecessor, bottom. Price of top trimmer is 70 cents, compared with \$2 for older unit. Pin configurations are the same.

cut prices, the electronics designer is still pretty much on his own in selecting the best trimmer from all alternative grades, materials, and packages. Manufacturers issue detailed specification sheets, but little application information.

Determining a trimmer's electrical specifications is only slightly more complicated than determining them for a fixed resistor. The trimmer, though, is also a mechanical device, and it is the interaction between the electrical and mechanical parameters that requires a little extra diligence of the designer.

Diligence means doing a circuit analysis to determine the actual significance of the parameters included in the spec sheets. The sorts of questions that need answering are: once the trimmer has been set, how much trimmer-resistance change due to temperature variation can the circuit tolerate and still function properly? How much contact-resistance uncertainty is tolerable?

Variable importance

When a trimmer serves as a three-terminal voltage divider (Fig. 6), as in a bridge or comparator circuit, the slider is set at some desired resistance ratio to balance the circuit. As temperature changes induce changes in the trimmer's nominal resistance, the ratio will remain substantially constant, and the balance setting will remain substantially valid. In such applications, low values of temperature coefficient of resistance (tempco) are not of primary importance.

However, when the trimmer is used as a two-terminal adjustable resistance (Fig. 7), as in a biasing circuit, an increase in trimmer temperature definitely changes the

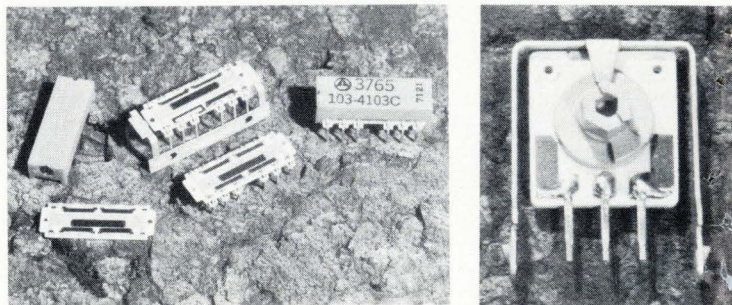
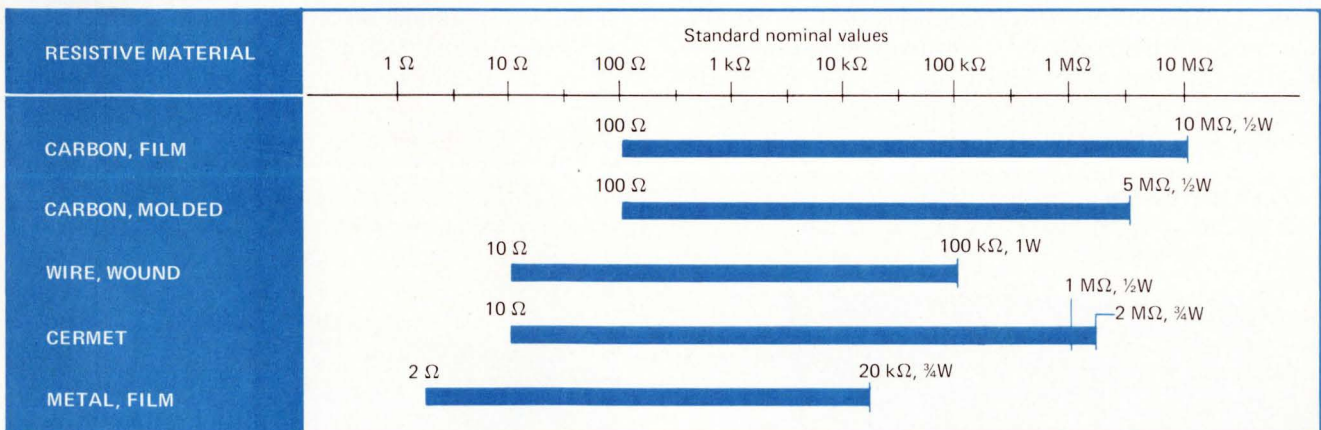

TABLE 1: TRIMMER PRICE/PERFORMANCE FACTORS

	General consumer grade	Quality consumer grade	General industrial grade	Quality industrial grade	High-performance grade	Ultrahigh-performance grade
Price, approximate midrange, at quantities related to grade	8 ¢	35 ¢	50 ¢	75 ¢	\$1	\$2 and up
Resistive material	Carbon sprayed on phenolic substrate	Cermet; carbon screened on ceramic substrate; carbon, molded	Cermet; carbon, molded	Cermet; carbon, molded; wirewound	Cermet; wirewound; metal film	Cermet; metal film; wirewound
Construction	Open	Open	Sealed, for immersion in 50° - 70°C water	Sealed, for immersion in 85°C solution	Very well sealed	Extremely well sealed
Turns	Single	Single	Single	Single, multiturn	Multiturn	Multiturn
Resistance, nominal	(Depends on resistive material. See chart "Trimmer resistance ranges")					
Resistance tolerance	±30%	±20%	±10%, ±20%	±10%, perhaps ±5%	±5%	±5%
Rotational life	Not quoted *	100 cycles*	200 cycles	200 cycles	200 cycles	200 cycles
Temperature coefficient of resistance	For applications where TCR not of consequence	About 600 ppm/°C or less	±250 ppm/°C or less	±250 ppm/°C or less	±100 ppm/°C	10 - 50 ppm/°C
Power, watts	0.1 - 0.2	¼, ½	½	½ - 1	½ - 1	¼
Operating temperature at rated power	25°C	25 - 70°C	70°C	85°C	85°C	85°C
Maximum operating temperature derated to zero power	85°C	105, 125°C	105, 125°C	105, 125°C	150, 175°C	150, 175°C
Comments	*Factory adjust and set	*Often not quoted but reasonable expectation of 100 cycles	Many terminal options	Withstand washing to remove solder flux	Testing and documentation	Stability ±0.05%. Extensive testing and documentation

TABLE 2: TRIMMER RESISTANCE RANGES



resistance from its set value—and too large a resistance offset could adversely affect circuit operation.

Overspecifying in terms of tempco can increase trimmer cost, particularly for custom-designed units made of cermet for which manufacturers can control the materials formulation and the processing conditions. One way to relax tempco specs is to determine the actual variation in operating temperature of the circuit, rather than use the operating temperature range specified for the trimmer. That is, says Ronald Stuckey, chief design engineer at CTS of Berne, “narrower variations in actual operating temperature can be traded for more parts per million.”

Since a trimmer most probably will be used with fixed resistors (Figs. 8 and 9), the effect of net resistance change—not just of the trimmer—due to temperature variations must be taken into account. One factor in choosing the trimmer’s resistive material is that it have a tempco compatible with the materials of other components in the circuit.

Thus, the application, not the specifications, sets the requirements. Finding a trimmer whose specs meet the needs at the lowest cost requires the evaluation, says Samuel A. Johnston, engineering project manager of Amphenol Controls, of many different electrical, packaging, materials, and environmental alternatives, and as the evaluation proceeds the interaction between these factors calls for reassessment and tradeoffs.

Well begun is half done

Fortunately, the first few steps in an orderly selection process eliminate many alternatives, so the choice of trimmer type rapidly narrows down. For example, if the calculation for nominal resistance for the trimmer results in 500 kilohms, the trimmer resistance ranges of Table 2 show that this value can be obtained as a standard catalog item in trimmers with resistance tracks made of film carbon, molded carbon, and cermet materials. Wirewound and film metal trimmers cannot normally be obtained for this resistance. Moreover, if the application requires a tempco not to exceed 100 ppm/°C, carbon trimmers—with a tempco of 600–800 ppm/°C—cannot provide this value. Cermet, then, with an available tempco of ± 100 ppm/°C, is the material to be selected for this application.

Similarly, the resistance-range chart shows that 10 megohms is obtained only in a film carbon trimmer.

The (negative) tempco of film carbon is 600–800 ppm/°C, and of molded carbon, 400–600 ppm/°C. Wirewound trimmers have a (positive) tempco of about 50 ppm/°C, and metal film units range from 10–100 ppm/°C. Cermet tempco depends on the particular metal-glass formulation and processing conditions. In

3. Automatic mounting. This dual in-line packaged trimmer from Allen-Bradley is ready for machine insertion into pc board.

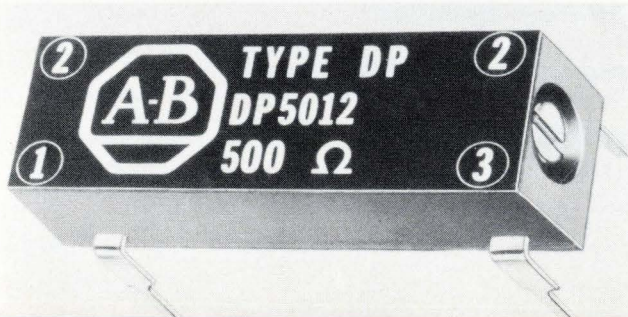

general, cermet trimmers in the medium resistance range (1–200k Ω) exhibit values of, nominally, ± 100 ppm/°C or less over the temperature range of -55°C to $+125^\circ\text{C}$. Their tempco is negative at lower temperatures, positive at higher. Better cermet tempcos are available and, depending on nominal resistance, can be made all negative or all positive over the specified temperature range.

Required resistance

Determining the trimmer’s nominal resistance depends on circuit requirements in conjunction with other resistors in series with the trimmer. If the trimmer serves as two arms of a bridge circuit, the trimmer resistance itself can be the total resistance of this voltage divider network, as in Fig. 6. However, taking this approach decreases the ability to set the slider—that is, balance the bridge—at some desired value. An alternative is to use a lower-value trimmer in series with two fixed resistors (Fig. 8), reducing the effect of the trimmer’s resolution or settability.

Similarly, when a certain over-all fixed resistance is required, it may be appropriate to use a lower-value trimmer connected as a two-terminal device in series with a lower-value fixed resistor (Fig. 9), again improving circuit settability.

Once the trimmer nominal resistance has been determined, the power rating (the power that can be safely dissipated in the trimmer at some stated operating temperature) can be determined from the voltage across or the current through the trimmer. Regardless of power, current must not exceed a certain maximum, lest it damage or burn out the trimmer.

Conventionally, manufacturers rate trimmers in increments of $\frac{1}{4}$ watt, from $\frac{1}{4}$ watt to 1 watt. While makers often state the maximum voltage (usually 300 volts) that can be applied, maximum current is not explicitly stated, though it can be readily computed. Knowledge of the maximum current is particularly necessary when the trimmer is used in the voltage-divider configuration, in which the slider contact carries some current to a load. This load current must be included to assure that no part of the resistance carries excessive current.

Again, when the trimmer is used as an adjustable resistor set at less than nominal resistance, the maximum current can’t be exceeded, even though the trimmer operates at less than its nominal power rating.

Since by application the trimmer is an adjustable device, some variation from nominal resistance is not critical to circuit operation. The essential point is whether a

4. Multiturn. Lead screw in multiturn trimmer, this one from Vishay, gives human adjuster finer control in setting the slider. Use of multi-fingered contact by trimmer makers cuts down on contact resistance variations, and improves settability.

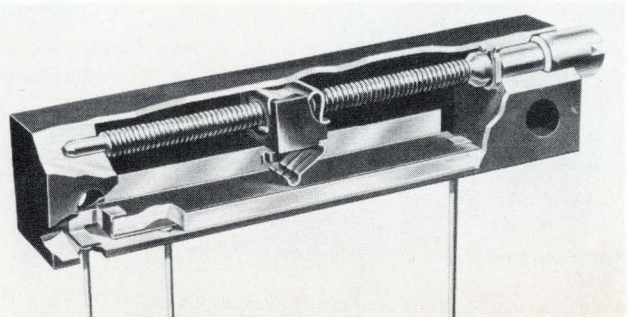

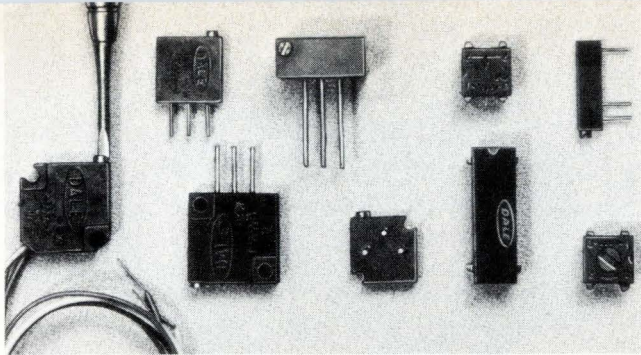

5. Shapes and sizes. Equipment designers can pick and choose in selecting a trimmer, not only in resistance and power ratings, but also in package shapes, single-turn and multiturn designs, pin configurations, and whether top or side adjust. These trimmers, from Dale Electronics, typify the variety available from major makers.

particular trimmer, whether higher or lower than nominal resistance, has enough resistance variation to permit adjustment of the over-all circuit. Generally speaking, better quality and more costly trimmers enjoy better resistance tolerances than do less costly ones.

As mentioned, makers have succeeded in improving film trimmers to the point where they're in fact much better than specs say they are. In particular, the contact noise and settability of cermet trimmers are approaching wirewound performance levels. But comparing actual spec sheets may be confusing because of the different definitions, testing procedures, and performance tolerances for the two types that still prevail in industrial and military standards.

When film-type trimmers, particularly cermet, were introduced, their most touted feature was "infinite resolution" because the slider traversed a continuous resistive surface. This is in contrast to the wirewound trimmer, in which the slider jumps from turn to turn and whose resolution is finite—and inversely proportional to the number of turns traversed by the slider.

On the other hand, the wirewound trimmer exhibits much lower contact resistance and contact noise than do cermet trimmers. In fact, in establishing the standards, contact noise was intentionally defined and tested in

many different ways for wirewound trimmers and for film types, so as not to let cermet trimmers appear in too bad a light. And the large contact resistance variation in cermet trimmers limited the accuracy and ease with which these trimmers could be set at some desired value. Eventually, the mystique of infinite resolution for film trimmers gave way to the more realistic parameter

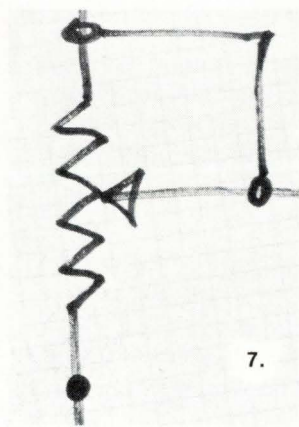

7.

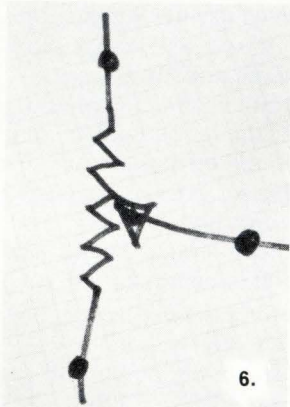

6.

called settability. Settability for film trimmers is comparable to the finite resolution of wirewound trimmers.

Settability, described as a percentage of nominal resistance, depends on many factors under control of the manufacturer: the resistive material and its surface characteristics; the design and material of the slider contact; and the over-all design of the trimmer's mechanical structure to maintain proper force of the slider on the surface and to reduce inadvertent relative movement between the contact and the surface.

Settability also includes a user factor, the skill of the person who's making the adjustment. Multiturn trimmers, which have gearing between the screw and the slider, give the adjuster finer control—by about twice as fine for cermet—than do single-turn units (Fig. 10).

A major factor in settability of film trimmers is the contact resistance variation (CRV) that occurs as the slider moves while the trimmer is being set. CRV is a dynamic uncertainty in the resistance value at the wiper terminal. Cermet trimmer makers specify CRV (usually 3% of nominal resistance or 20 ohms, whichever is greater), but they don't specify contact resistance (CR), the resistance when the wiper is at rest. Often, depending on the quality of the cermet trimmer, CR can be greater than CRV. Figures 11 and 12 (following page) show CR and CRV in three-terminal and two-terminal trimmer configurations. Again, a simple circuit analysis will reveal the importance of CR and CRV in the application.

Fig. 13 shows a typical change in resistance, measured at the slider terminal of a cermet trimmer as it moves from one end of the resistance track to the other. The peak-to-peak variation is CRV. The large dc value, however, results from contact resistance. Interestingly, good wirewound trimmers have little CR, so the wiper produces only a dynamic resistance variation, and that usually from dirt or oxide. For wirewounds this contact resistance variation is called ENR, equivalent noise resistance. As mentioned, the significance of contact resistance in film type trimmers is masked because only CRV is specified. In fact, the military and industrial standards for testing film trimmers calls for a filter to remove the dc value, making film trimmers seem like

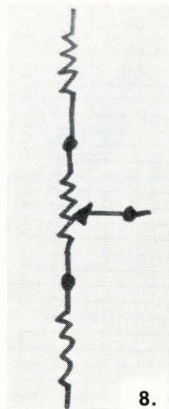

8.

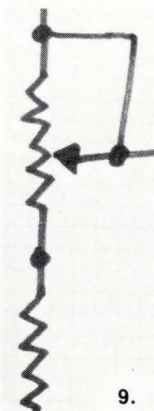

9.

10. Single turns. For many consumer and industrial applications, single-turn trimmers provide adequate service at lower cost than multiturn units. Shown here are Beckman trimmers.

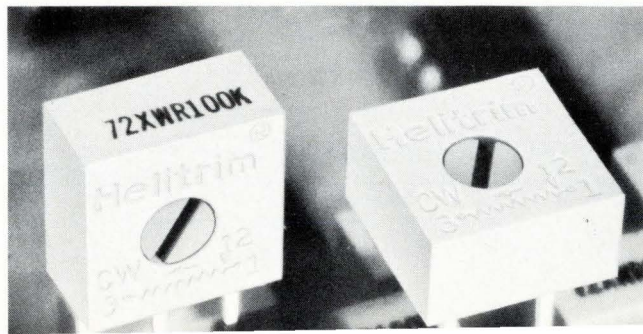

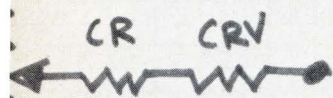

11.

ink is screened onto a ceramic substrate. Applied heat drives off the solvent and there's a physical bond between the remaining carbon particles on the substrate surface.

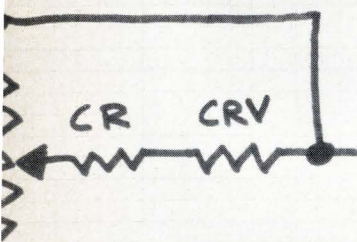

12.

can be obtained: sheet resistivity ranges from 0.5 ohms per square up to 2.5 megohms per square.

Most metal film trimmers are made by evaporating a very thin layer of resistive metal onto a substrate. Typical is Amphenol's multiturn trimmer (Fig. 14).

Cermet thicknesses will range from 0.0005 to 0.001 inches, while metal film will range from 100 to 2,000 angstroms (or about a millionth of an inch). Cermet is therefore classified as thick film, and metal as thin film.

However, in some metal film trimmers, such as those made by Vishay Resistor Products, Malvern, Pa., a thin resistive metal sheet is clad to a glass substrate (Fig. 4). The metal layer is much thicker than in evaporated types, and this is one reason Vishay can make a metal trimmer with a 2-ohm nominal resistance.

Whether cermet or metal, the layer is so thin that imperfections in the substrate surface affect the resistive

wirewounds with respect to contact noise.

The term film applies to those trimmers, whether carbon, metal, or cermet, in which the resistive material is very thin compared with its length. Lower-cost carbon film trimmers are made by spraying carbon particles in solution onto a phenolic substrate. In better quality units, the carbon

containing precious metal and glass particles is screened onto ceramic. Firing at high temperature forms a chemical bond between the particles. The materials formulation and the processing conditions determine the total resistance and the temperature coefficient of resistance. The versatility of cermet as a resistive material is evidenced by the wide range of values that

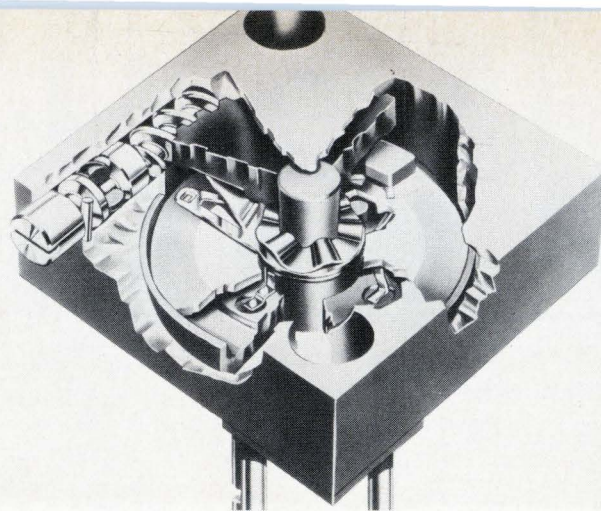

14. **Evaporated.** Lead screw of multiturn trimmer from Amphenol drives slider contact around metal layer evaporated onto substrate.

surface. Such hill-and-valley irregularities interfere with consistent contact by the slider, causing contact resistance variation. In cermet, of course, the granular characteristic of the metal-glass resistive track adds its own irregularities, aggravating the problem.

For many applications the cermet trimmer has become directly competitive with the wirewound trimmer, and makers of cermets continue product improvements. In the recent past, these improvements included etching of the cermet surface to reveal the metal particles, the use of better materials to provide lower tempcos, the introduction of multi-finger sliders to assure good contact and average the hill-and-valley surface irregularities, and more attention to mechanical design to provide constant slider pressure on the resistive track.

Contact resistance variation in cermet trimmers has declined so significantly in the past year that units are now being shipped, though not guaranteed, with 1% CRV. Specifications may soon reflect this response to users' demands for lower contact noise.

Frank J. Bruder, supervisor of new product development of the Trimpot division of Bourns, Inc., Riverside, Calif., agrees that noise levels have dropped by 50% in the past year and that "contact noise is probably getting the most emphasis from an engineering standpoint." And L.T. Peart, chief engineer for trimmers at the Helipot division of Beckman Instruments Inc., Buena Vista, Calif., says that adding more fingers to the wiper contact—10 contact points instead of the usual three across the 0.030-inch-wide track—can cut the noise by a factor ranging from 3 to 10. Most other companies have increased or will increase the number of contacts, but such designs boost the cost to the trimmers.

Customer demand for miniaturization continues, makers report, and this will result in trimmers with reduced height above the printed circuit board as designers strive to stack boards closer together.

The move to miniaturization "will kill wirewounds," says Peart, a prediction echoed by other cermet (and wirewound) trimmer makers.

Perhaps the next major development will be the base-metal, instead of precious-metal, cermet trimmer, for some applications. Peart says, "Beckman is working on this system now, but there's no indication when it will come on the market." The goal: a lower-grade cermet trimmer to sell for 15 cents. □

13. **Skittish.** Film type trimmers, particularly cermet, exhibit contact resistance variations (CRV), but values are getting smaller.

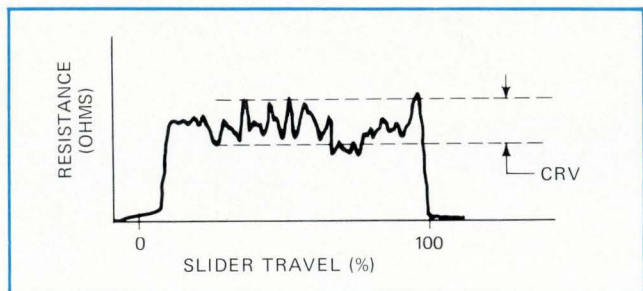

Tips on cooling off hot semiconductors

As power levels go up and up and package size shrinks, circuit designers are keeping semiconductors cool with IERC Heat Sinks/Dissipators. Reducing junction temperature gives many benefits: faster rise and fall times, faster switching speed and beta, fewer circuit loading effects and longer transistor life and circuit reliability.

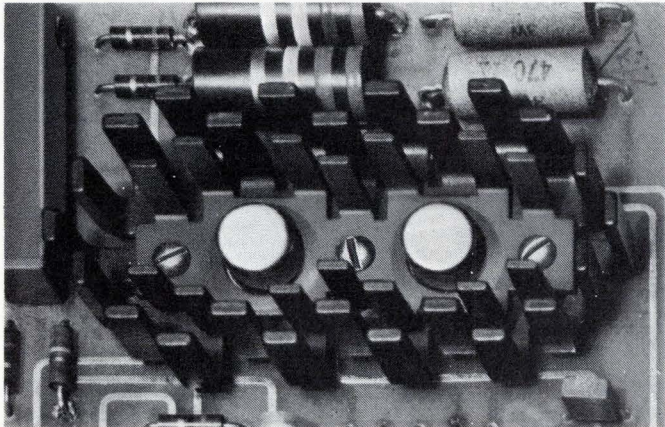

Thermal mating of matched transistors, such as these TO5's shown on a dual LP, maintains matched operating characteristics. The LP's unique multiple staggered-finger design (both single and dual models) maximizes radiation and convection cooling, results in a high efficiency-to-weight and -volume ratio.

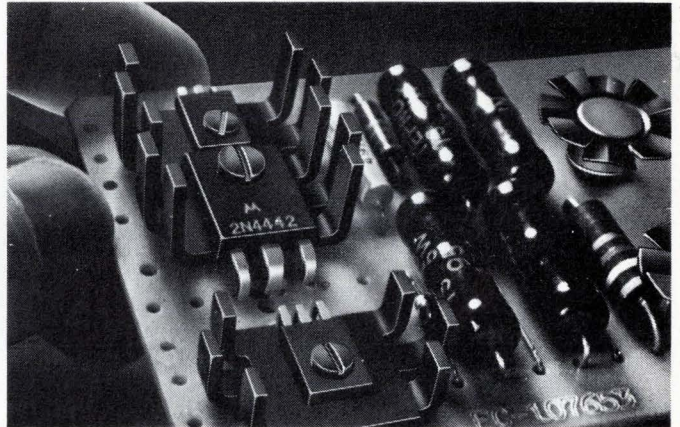

Power levels of plastic power devices such as X58's, MS9's, and M386's can be increased up to 80% in natural convection and 500% in forced air when used with PA and PB Dissipators. PA's need only .65 sq. in. to mount; PB's 1.17 sq. in. Staggered finger design gives these light-weight dissipators their high efficiency.

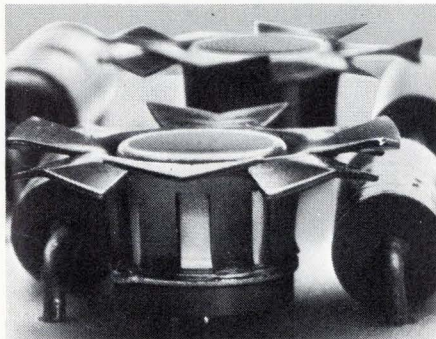

TO5's and TO18's in high density packages can be cooled off with efficient push-on Fan Tops that cost only pennies. T-shaped, need no board room, let other components snug-gle close. Spring fingers accommodate wide case diameter variations. Models for RO97's, RO97A and D-style plastic devices also.

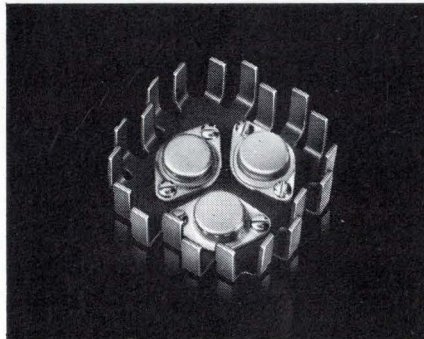

High power TO3's, TO66's, TO6's, TO15's, etc. can be operated with much more power when used with HP's. These compact, light-weight staggered finger devices accommodate from one to four TO3's. Provide the same heat dissipation as an extrusion that's three times heavier and one-third larger.

Heat problems? IERC engineers welcome the opportunity to help solve your heat dissipation problems. As the world's largest manufacturer of heat sinks/dissipators for lead and case mounted semiconductors, they can come up with a practical, low cost solution.

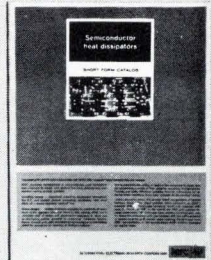

Free four-page Short Form Catalog. Send for your copy today.

Heat Sinks/Dissipators

IERC



RCA—where the action is 'VERSAWATT' and 'REVERSAWATT'

Here's a sample listing from RCA Interchangeability Guide
—Available from your RCA Distributor

N-P-N	RCA N-P-N	P-N-P	RCA P-N-P
MJE-201	RCA-201	MJE-101	RCA-101
MJE-202	RCA-202	MJE-102	RCA-102
MJE-203	RCA-203	MJE-103	RCA-103
MJE-204	RCA-204	MJE-104	RCA-104
MJE-205	RCA-205	MJE-105	RCA-105
2N5190	RCA-45190	2N5193	RCA-45193
2N5191	RCA-45191	2N5194	RCA-45194
2N5192	RCA-45192	2N5195	RCA-45195
MJE-520	RCA-520	MJE-370	RCA-370
MJE-521	RCA-521	MJE-371	RCA-371

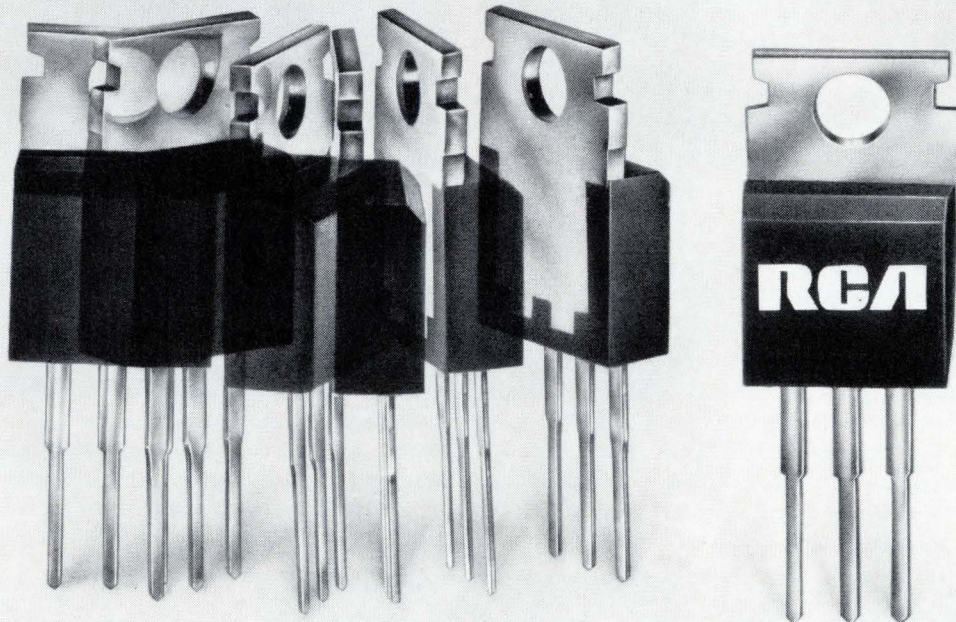

BCE
Epitaxial-base

ECB
Epitaxial-base

Leads custom-formed to your specifications

Now! You can *select* epitaxial-base transistors in an industry standard package, color-coded gray for n-p-n and green for p-n-p. They have an established "look" and an established label. It's RCA.

Called "REVERSAWATT" transistors, because the emitter and base leads are reversed from the popular VERSAWATT transistors, they offer mechanical versatility, achieved at no extra cost as a result of the symmetry of the RCA power transistor chips, offering designers additional flexibility in circuit layout.

Breakdown voltages from 30 to 100 V and beta from 1 to 3 A are provided in this new series, which is backed by safe-area-of-operation curves and RCA's

thermal cycle ratings. This is just the beginning. More units are coming—with the electrical characteristics you want in an epitaxial configuration. Get acquainted with RCA's epitaxial line. See your RCA Distributor. He's your local source for all RCA solid-state products including "REVERSAWATT" transistors.

For more information on RCA epitaxial-base transistors, see your RCA Representative. For technical data on specific types, write: RCA Solid State Division, Section 70A-17/UTL26, Box 3200, Somerville, N.J. 08876.

International: RCA, Sunbury-on-Thames, U.K., or P. O. Box 112, Hong Kong. In Canada: RCA Limited, Ste. Anne de Bellevue, 810 Quebec.

RCA Solid State
products that make products pay off

Probing the news

Analysis of technology and business developments



Scrambled data baffles thieves

Industry is becoming more interested in scrambling, now that company secrets are freely transmitted over data networks

by Paul Franson, Dallas bureau manager

Data theft is bugging commercial firms that transmit private information over public and leased telephone lines. A major reason for heightened concern is the explosive growth of computer networks.

"During the past several years we have seen a drastic change in the application of computers," says Peter Maitland, vice president of engineering at Ground/Data Corp., Fort Lauderdale, Fla. Instead of powerful calculating machines, Maitland sees computers becoming massive and instantly referenced filing systems. This change, he says, is due to "the development and implementation of time-shared computer systems, in which a large data bank may be accessed by a number of remote users through common carrier communications links."

It's often difficult to detect data theft. As George Goode, president of Datotek Inc., Dallas, points out,

"the disconcerting aspect of data theft is that company secrets may fall into the hands of a competitor without the company ever being aware that a theft has occurred."

The degree of concern depends on the industry, with international, financial and oil companies perhaps most careful. The Government intelligence agencies and the Defense Department have long been conscious of security, and now, Maitland says, they're being joined by welfare agencies, law enforcement and social security agencies.

The largest European private company in the field is Crypto AG in Zug, Switzerland. Max Fenn, Crypto's sales manager, points out that far and away the biggest customers are Government agencies, and the biggest producers of cryptographic machines in Europe are Government-owned factories.

The biggest commercial buyers of

Crypto equipment in Europe are oil companies. "Customers have told me that competitors were finding out about oil strikes before headquarters did because of leaks through Telex systems," Fenn goes on. The second-largest group of non-Government customers, according to Fenn, is banks and financial institutions.

When it comes to estimating the size of the market for data protection devices, the companies in the business take to heart their pronouncements about corporate secrecy. Fred Kinch of Datotex says the market is relatively small now, less than \$1 million a year, but he expects it to rise to over \$10 million by 1975. Cliff Leventhal, director of marketing at ITT's Data Equipment and Systems division, East Rutherford, N.J., declines to disclose any market figures whatsoever. He describes the market as "not a large

Probing the news

one and quite narrowly defined," involving industries such as oil and banking which must rely on long-distance communications.

According to Maitland, there are four types of data theft: masquerading, in which one terminal claims it is the authorized one; wiretapping; breaking into a line; and violating the computer room security itself.

Passwords or "handshaking" can provide protection against masquerading (though not if the masquerader knows the code word), and so can the automatic transmission of a terminal's identity. But neither of these techniques is useful against the other forms of data theft.

Protector. Scrambling, on the other hand, can protect the files, and software scrambling at the computer (or at a remote intelligent terminal), or hardware scrambling (at the remote unit) can be used.

One problem with data scrambling is that the data must be unscrambled before computations can be performed on it, as for payroll or tax information. This can be accomplished by a software program, or possibly a "firmware" routine, in the computer. Alternatively, numerical data can remain unscrambled, but obscured in meaning by scrambling of all associated text and headings.

Protection of point-to-point communications over teletypewriter line is a bit simpler, since there's no need to compute anything from the message. Here, the main problem other than security is to keep addresses and control keys clear.

Scrambling techniques range from the simple, to discourage cas-

ual intruders like messengers or computer room operators, to the complex, which will baffle international spies.

Massaging the message. All techniques modify certain bits in each character in a predetermined way. The most straightforward is substitution, where, for example, the first, third and fifth bits in each eight-bit character are interchanged. Easy to implement, it is also easy to decode.

Much more secure, and a technique apparently used in most of the data scramblers on the market, is a rotating code. Here the message is compared with a long rotating code sequence, generally obtained from a pseudo-random sequence generator. This generator is a modified shift register, with feedback connections that are changed to give different code sequences.

The sequence length in the Ground/Data data scrambler uses 23 shift register stages, yielding a maximum sequence length of about 8 million characters. It takes nearly 10 days of transmission at 100 words per minute before a sequence is repeated. Of the 8 million possible codes with the 23-stage register, 4.3% or 360,000 codes are full length. (A 24-stage register would yield only 1.6% full length sequences—270,000 codes—but provides twice the time before repetition.) The starting point of the code is established by the first few characters transmitted.

Who's scrambling. Data scrambling equipment on the market includes units made by Datotek, Ground/Data, ITT Data Equipment and Systems and Crypto AG. Tautron in Boston, Mass., has developed some very wide-band equipment for

satellite and laser communications, but is not going after the lower-cost commercial market at this time.

ITT Data Equipment and Systems has been selling their Cryptel, at \$2,700 a terminal. The shoe-boxed-sized Cryptel can be used in a relatively small high-security area, in which equipment cuts five-level coded tape that's fed into teletypewriter equipment. The tape comes out scrambled.

ITT's Leventhal emphasizes that the scrambler is suitable only for situations where information may appear "in clear" to prying eyes. It can't be used to safeguard confidential data when the thief is a sophisticated one. "There's no way anybody's several thousand dollar scrambler is going to beat a multi-million dollar computer programed to beat the scrambler's code," he says. "At best you might gain several hours of time, as the computer riffles through the 300 million possible code combinations."

Models. Datotek makes three units, one for use with teletypewriters in timesharing computer systems, the Datocoder DC-110. It's rated to 150 baud. The other devices, the models 105 and 108, are for point-to-point communication with teletypewriters, and sell for about \$3000.

Ground/Data makes units, called data sequestors, that can be used for point-to-point communication (\$975) and for computer time-sharing (\$1,275). They use fixed codes that can be changed only by replacing a plug-in module. A programmable read-only memory sets the code. Ground/Data claims a data rate up to 1 MHz, making it suitable for relatively high-speed equipment.

Crypto makes mostly off-line machines. Their hardware operates at six to eight characters per second, so routine on-line use for all Telex messages—important or not—isn't feasible. Prices for the off-line machines run from \$1,000 for a hand-operated machine to \$5,200 for a machine that works with punched tape.

Current models are electromechanical, and are built around six encoding-decoding wheels that offer up to 10^{100} different combinations. Fenn says an electronic version will be ready in three or four months. □

Security benefits. For data transmitted point to point via teleprinter networks, Datotek Inc. has developed its Datocoder 105. This unit works with five-level systems, such as Telex.



This new "See-Through" mask will more than double your present production yields of usable semiconductor devices.

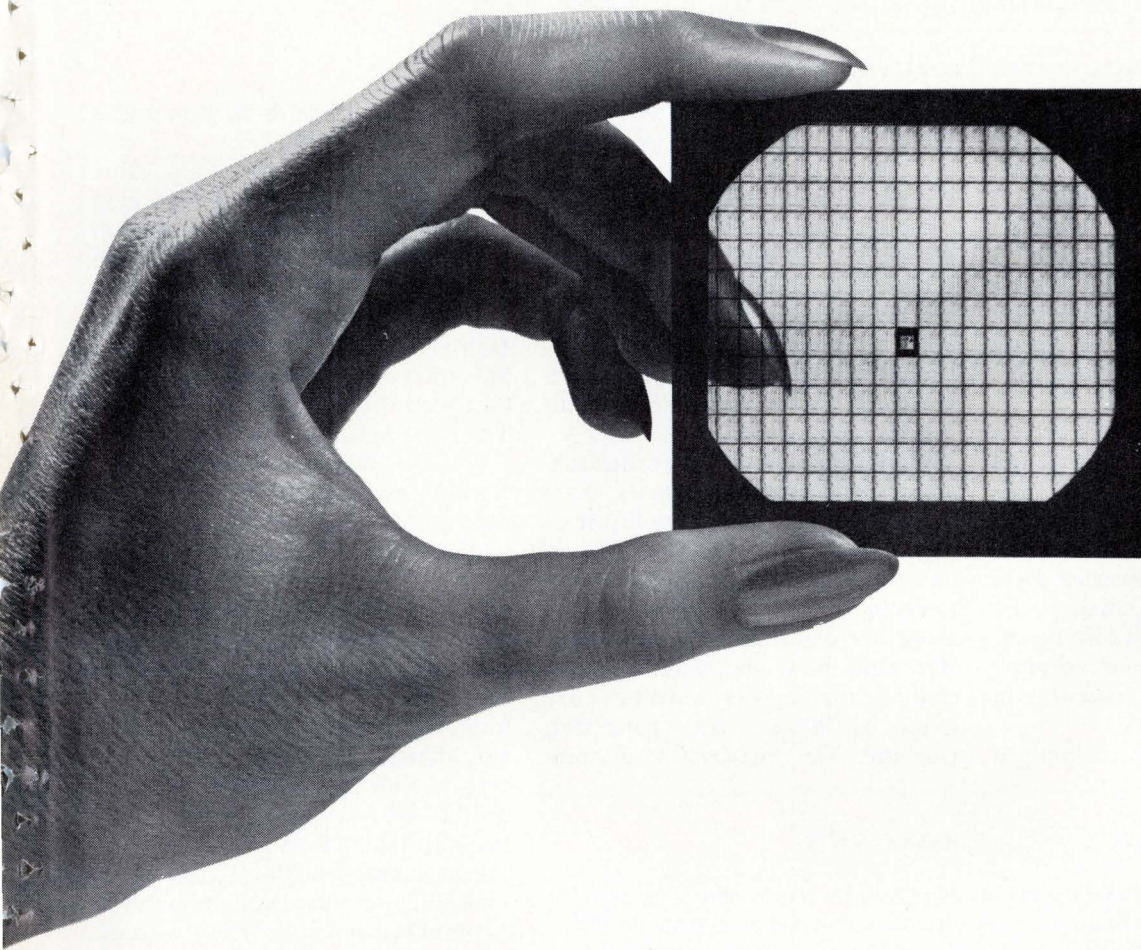

Your yields will increase.

Dry processing eliminates residue, swelling and contamination which account for most rejects in finished chips. Also, GAF® Microline® "See-Through" Plates eliminate rejects due to misalignment.

Your production costs will decrease.

Photomasks are made right "on-site" on low-cost equipment thereby saving you time and outside costs. Also, these masks last about 10 times longer than conventional emulsion photomasks.

The resolution characteristics of new GAF®

Microline® Plate are without match. Micron line-widths are easily obtained.

(Manufacturers in commercial production have resolved 2000 lines/mm using the United States Air Force resolution target in the photorepeater.)

New wafer photofabrication system.

The processing of silicon wafers using GAF® Microline® positive-working photoresists and GAF® Microline® plates results in a simplified, positive high yield system for producing usable semiconductor devices.

If high reject rates are the problem in your com-

pany, just fill out the coupon. We'll gladly send you full technical data on these new products and/or phone for an appointment to demonstrate just how great the savings can be in your own plant.

Available Plate Sizes:

- 2"x2"x0.060"
- 2½"x2½"x0.060"
- 3"x3"x0.060"
- 3½"x3½"x0.060"



353A-2100

GAF Corporation
Commercial Development Dept. 606.012
140 West 51 Street, New York, New York 10020

Gentlemen:

- Please send complete technical information on GAF® Microline® High-Resolution Plate.
- Please send complete technical information on GAF® Microline® positive-working photoresists.
- Have a representative phone for an appointment to demonstrate this new product in my plant.

Name _____ Title _____

Company _____ Phone _____

Address _____

City _____ State _____ Zip _____

Communications & Microwave

FET low-noise R&D heats up

Developments in 5–15-GHz range promise higher gain and lower noise, with potential performance beyond capabilities of bipolar devices

By Lyman J. Hardeman, *Communications and Microwave Editor*

Field-effect transistors, termed a "red-hot technology area," threaten the future of bipolar devices in low-noise applications in the 5–15-gigahertz range. Although the performance of gallium arsenide FETs now available—operating at 3 GHz—can be matched readily by bipolar transistors, the potential for lower noise and higher gain promises rapid development.

With bipolar transistors, "you have to spend a lot of money to get marginal improvements," says James Kesperis, a researcher at the U.S. Army Electronics Command, Fort Monmouth, N.J. Because FETs are inherently high-frequency devices, he is hopeful that FET development will progress more rapidly and at lower cost than advances in bipolar technology.

"Microwave FETs are certainly a

red-hot technology area," says Walt Gelnovatch, who heads microwave integrated circuit development at the Electronics Command. In support of their interest, the command plans to let contracts this year to study the feasibility of using FETs in low-noise microwave amplifiers. Possible military applications include telemetry, electronic countermeasures, and radar and communications receivers.

Optimism Shared. Other researchers at semiconductor houses share Kesperis' optimism for the future of FETs. Several companies already have developed prototype low-noise FETs in the 5–15-GHz range, and more are expected early this year. But right now, the only commercially available microwave FETs are made by Plessey Ltd., Towcester, England. The Plessey GAT-2 oper-

ates at 3 GHz, with 8-dB gain and a noise figure of 5 dB.

At Fairchild Corp., Palo Alto, Calif., FETs have yielded 8-dB gain at 8 GHz with a noise figure of less than 4 dB—about 2 dB less than the best bipolar devices at that frequency, according to Fairchild. At Hewlett-Packard, also in Palo Alto, an experimental FET has been demonstrated with 10 dB gain at X band. The noise figure is said to be "low".

Charles Leichti, H-P engineer working on the project, says that no date has been set for the device to be put into production, but that details will be available at next month's Solid State Circuits Conference in Philadelphia.

At that same conference, Werner Baechtold of IBM's Zurich laboratories will describe two low-power amplifiers: one operating at 8.2 GHz with 17.5 dB gain and 1.3 GHz bandwidth, and a device covering 9.5 to 14.3 GHz with 8.3 dB gain.

FETs evaluated. John Isenberg, responsible for advanced microwave communications at Watkins-Johnson Co., Palo Alto, Calif., is evaluating GaAs FETs for use in low-noise amplifiers. "We have tested the devices of several different vendors," says Isenberg, "and within limits, have observed similar characteristics for all devices."

Compared with conventional transistors, he agrees, the FETs have higher gains and lower noise figures at frequencies above 3 GHz. But a few circuit problems will have to be overcome to make FETs practical in wideband circuits. For bipolar low-noise transistors, typical input and output reflection coefficients are 0.75 when placed in 50-ohm circuits. For the FET, according to Isenberg,

What does the FET compete with?

One way to determine what the microwave GaAs FET has to offer is to take a quick look at its alternatives for use in a typical 4-to-8 GHz octave bandwidth low-noise receiver. For this application the FET's chief competitors are the tunnel diode, the parametric amplifier, the traveling-wave tube, and of course, the bipolar transistor.

■ Tunnel diodes. These devices have low noise figures, but their noise performance can just about be matched by the FET. Tunnel diodes, however, can only handle low-level signals and saturate at about -20 dBm.

■ Parametric amplifiers. These circuits can achieve better noise figures than the field effect transistor but are sometimes costly and are not capable of octave bandwidths without considerable strain.

■ Traveling-wave tubes. TWT's offer just about all the performances advantages of a low-noise amplifier about 7 dB noise figure across the band with signal handling capabilities of up to +10 dBm. But a typical C-band TWT may weigh 17 pounds with dimensions of 6 inches in diameter by 18 in. long.

■ Bipolar transistor. F_{max} , the frequency at which gain goes to unity, is about 12 to 15 GHz for the bipolar transistor, or about one-third that of the GaAs FET. This firmly limits the practical operating frequency of the bipolar transistor to about 6 GHz, and at this frequency the noise figure of the bipolar device begins to skyrocket.

this number increases to about 0.9 for the same circuits.

The higher FET mismatch means that only about 1 dB of gain is achieved when the FET is placed in a 50-ohm line, continues Isenberg, but the available gain in a matched circuit is more like 20 dB. The bipolar device can yield practical gains of about 8 dB simply by placing the device in a 50-ohm circuit.

Therefore, proper FET matching will require circuit techniques that differ from those presently used. For example, it may turn out to be easier to match the FET to a slot-line or

Schottky FET cross-section. A typical microwave FET uses a Schottky junction between the electrodes and the substrate. The gate length (L) determines the maximum device cut-off frequency. The gate controls charge flow between source and drain, giving transistor amplification.

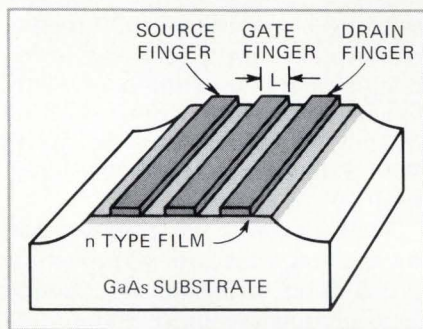

waveguide circuit rather than the 50-ohm stripline or microstrip circuits now commonly used.

A large majority of the gate contact fabrication techniques reported to date use Schottky junctions on doped GaAs substrates. An alternate gate fabrication approach has been developed by Rainer Zuleeg, Solid State Electronic branch chief at McDonnell-Douglas Astronautics Co., Huntington Beach, Calif. McDonnell-Douglas is using a diffused-gate junction instead of the Schottky junction.

"One advantage of this technique," says Zuleeg, "is that the device is radiation hardened. Our device has operated in an environment of 10^{15} neutrons per square centimeter without any measurable degradation in performance." Zuleeg also reports a record 1.3 dB noise figure for a cryogenically cooled FET operating at 1 GHz. The operating temperature in this case is 77°K. □

Design tomorrow's circuits...today...

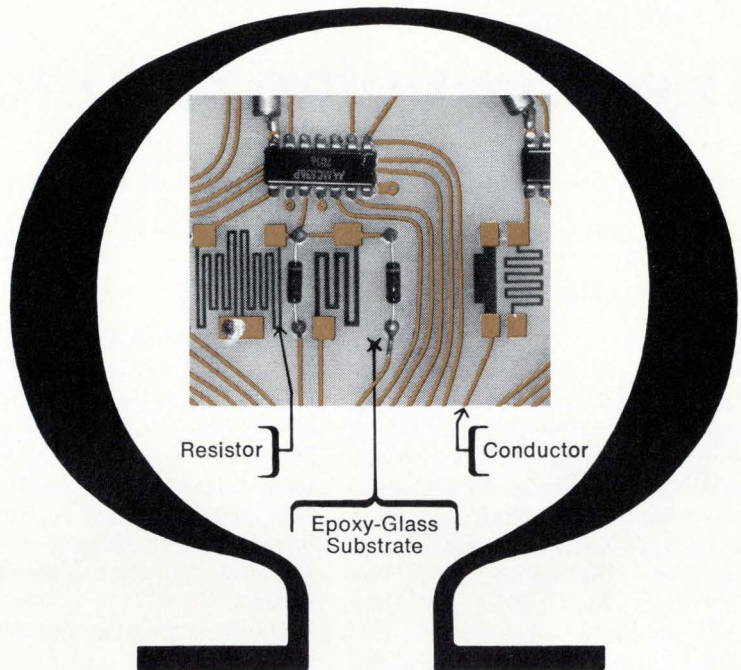

with Micaply Omega— A new resistive-conductive circuit board laminate that extends PC technology to thick and thin film applications

After years of developmental effort, Micaply Omega affords circuit designers and fabricators exciting **new dimensions** in combining conductors and resistors in the same circuit. And it's available now in 8" x 12" min. sheets.

This unique new material is an epoxy-glass substrate completely covered on one or both sides with a bi-layer cladding. The layer against the substrate is resistive, the top layer is conductive. Using conventional printed circuit production techniques, patterns of conductors and re-

sistors can be etched to produce circuits complete with integral resistors. The entire process is subtractive — no screening, firing, or vacuum equipment is required!

For many printed circuit board applications it means the cost of discrete resistors can be eliminated. For many thick and thin film circuits it eliminates the cost of expensive substrates and deposition techniques, and enables the use of economical step-and-repeat methods on large sheets of Micaply Omega.

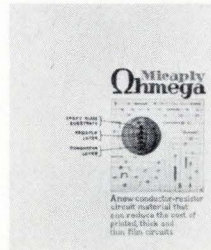

Find out more about how Micaply Omega saves time and money. Call Don Loundy at (213) 870-6861 or request our new brochure shown above.

Micaply Omega™

The Mica Corporation / 4031 Elenda St., Culver City, Ca. 90230 / (213) 870-6861
TWX: 910-340-6365, Cable: Micaply
Micaply International / Silloth, Cumberland, England / Silloth 571
Telex: 85164120 / Cable: Micaply Silloth

* Trademark for polyfunctional laminates made by The Mica Corporation.

Government electronics

The computerized drugstore

Two billion prescriptions will be written in 1975, many under health insurance programs, and pharmacies will need computer aid, says HEW

by William F. Arnold, Washington bureau

As the cure for anticipated data congestion in the nation's drugstores, the Department of Health, Education and Welfare is prescribing computerization. The plans being formulated at HEW would place computer terminals in each of the nation's 57,000 pharmacies or drug dispensing agencies, and link them to doctor's offices and data banks containing prescriptions and health information for the entire population.

HEW planners say the system will be essential to meet America's medical needs in the next five to seven years. While no definitive policy has been laid down, HEW regards implementation of the network as a matter of "when," not "if," because:

- The more than 1 billion prescriptions dispensed last year is expected to double by 1975.
- The 50,000 or so drugstore and hospital drug counters will remain about the same, as will the number of qualified pharmacists.
- Only an electronic network will be able to cope with the paperwork as more persons become covered by health insurance drug plans.

Interest in computerizing pharmacies also comes from health insurers, drug companies, and drug suppliers and wholesalers. Thomas M. Collins, vice president of Smith Kline & French Laboratories, Philadelphia, Pa., recently predicted that by the late 1970s, "we will have a computer network based on terminals transmitting from the nation's major pharmacies, with large Government-funded, regional centers processing prescription claims."

"It will take the Government's active involvement to bring the network about," explains James D.

Hawkins, assistant executive director of the American Pharmaceutical Association, because the key is money and only the Government has it. Drug companies, insurance companies and drug wholesalers are "all looking toward such a system, but no one can bring it off by themselves, yet all want to benefit by it," he says.

Hawkins foresees the network as an incremental set up, beginning with a claims payment mechanism when the Government underwrites all Medicare prescription drugs. From this national system, "other things will come along, such as patient records, automatic ordering for the pharmacist, communications between the physicians and the

pharmacist, and the like," he says.

What will clinch creation of the network is Congress's decision to extend out-patient prescription drug benefits to the Medicare public health program. The provision has been proposed for several sessions, and is expected to pass within the next few years. If it does pass, "we estimate an additional 425 million prescriptions in the first year of operations and that additional Federal expenditures for drugs will be roughly \$2 billion," says M. Keith Weikel, director of HEW's division of health evaluation.

Weikel expects the proposed network to lower the costs of processing prescription claims and reimburse local pharmacists quickly and fairly

Cure for congestion. One HEW proposal for a computerized drug information system would provide not only prescription services, but also drug health records, and inventory control.

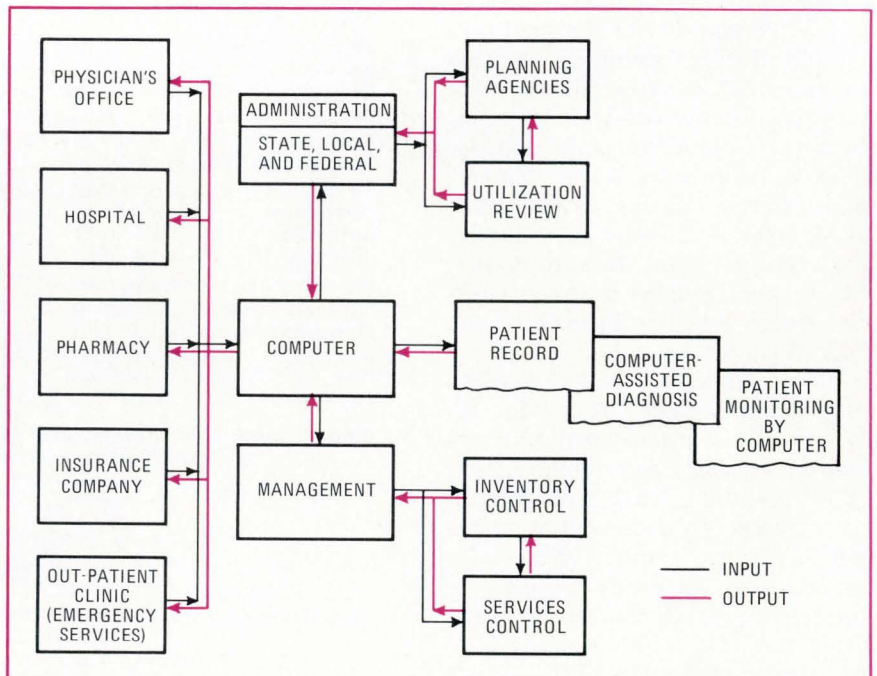

for filling a request. According to his estimate, the cost of processing would average under 20 cents per prescription and ultimately save the Government up to 35% in operational costs. Some state health plans, have processing costs of \$1.00, unduly high when the average prescription costs only \$4.05.

Specifications. Although precise system requirements are some time off, HEW is tentatively specifying terminals that would accept complete data in 15 seconds or less, record it with a .01% or lower error rate, and automatically number the prescription, date the order, and perhaps even print the label for the bottle.

One pilot terminal being studied by HEW features a magnetic cassette recorder, which would feed the day's transactions into the network on demand overnight, a light pen, a printer, and an acoustic coupler, says Joseph A. Higgins, drug task force director for HEW's Social Security Administration, Baltimore, Md. This terminal would use standardized, encoded plasticized paper for prescriptions.

The pharmacist would pass the light pen over the encoded information and automatically record the doctor's name, the drug, and the patient's name, address, identification or social security number and other data. Such a terminal not only eliminates the extra paperwork of claim forms but ensures accuracy, because the pharmacist scans the information while passing the pen over it and so should spot any errors. Higgins says he's talked with IBM, Pitney-Bowes, NCR, and Emerson Electric about terminal technology, and says that several companies have the necessary hardware.

Terminal pay. Just how and who will pay for the terminals remains a question. Higgins suggests that the Government may lease them from manufacturers. Even though the terminal part of the system might be \$40 a month, Higgins says that the savings would justify the cost.

If private industry gets involved, the Government may find itself sharing its terminals through a Government-owned agency, a Government-chartered corporation like the Communications Satellite Corp., or private companies.

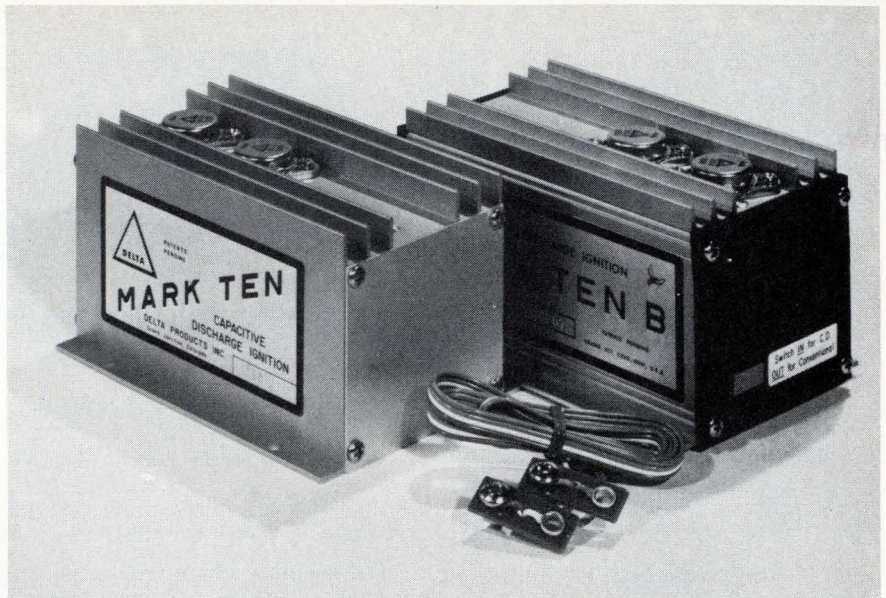

Save money and improve car performance at the same time.

Maintenance costs go down and performance increases when you put a Delta Mark Ten Capacitive Discharge Ignition System on your car.

For eight years we've been telling you about the tremendous advantages of CDI systems. We've promised and delivered better performance for cars, boats and trucks. Hundreds of thousands of satisfied customers testify to that fact. However during these eight years, we've been asked over and over again, "If CDI systems are so great, why doesn't Detroit adopt them?" It's taken a long time, but finally Detroit has recognized the value of the CDI system. Chrysler, long noted for excellence in engineering, is now installing CDIs in new cars. Have you seen their ads? Heard their commercials? They're repeating what we've said for eight years. *CDI systems not only improve performance, but eliminate the need for most tune-ups.* If you're not buying a new car, but want new car performance, put a Mark Ten or Mark Ten B on your present automobile. If you're purchasing a new car with no CDI system, install a Mark Ten or Mark Ten B and enjoy the benefits of low maintenance and increased performance.

HERE'S WHAT A MARK TEN WILL DO FOR YOU:

Mark Ten and Mark Ten B — up to 20% increase in gasoline mileage
 Eliminates 3 out of 4 tune-ups Installs in only 10 minutes Spark plugs last 3 to 10 times longer Dramatic increase in performance Promotes more complete combustion Instant starts in all weather.

Mark Ten B—Improves combustion, reducing contaminants Handy switch with redundant contacts for instant return to standard ignition Applicable to ANY 12 volt negative ground engine Eliminates starting and idle problems Longer spark duration during cranking and idling.

Mark Ten (Assembled) \$44.95
ppd

Mark Ten (Deltakit) \$29.95
ppd

Kit available in 12 volt only,
positive or negative ground

Mark Ten B \$59.95 ppd
(12 volt negative ground only)

ORDER TODAY!

Superior Products at Sensible Prices



Dept. E
DELTA PRODUCTS, INC.

P.O. Box 1147 / Grand Junction, Colo. 81501
(303) 242-9000

Please send me literature immediately:

Enclosed is \$_____ Ship ppd. Ship C.O.D.

Please send:

___ Mark Ten B @ \$59.95

___ Standard Mark Ten (Assembled) @ \$44.95

___ 6 Volt: Neg. Ground Only ___ Positive Ground

___ 12 Volt: Specify ___ Negative Ground

___ Standard Mark Ten (Deltakit®) @ \$29.95

(12 Volt Positive Or Negative Ground Only)

Car Year _____ Make _____

Name _____

Address _____

City/State _____ Zip _____

**ACT FAST —
YOURS COULD BE
THE FIRST
ELECTRONICS FIRM
IN RANGELY,
COLORADO.**

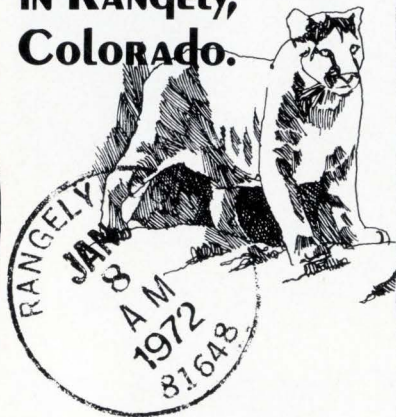

More than 100 electronics firms have located in Colorado in the past decade. None has looked seriously at Rangely. Perhaps the map scared them off. There's a clean, clear water stream running through the heart of town which some old-timer misnamed Stinking Creek. And there are peaceful little towns nearby called Dinosaur and Dragon.

But maps don't tell you the important things about Rangely and other Colorado communities: About the low prices for the unspoiled land, and for power and water; about the good, fresh air and the great hunting and fishing; or about the educated, productive workers who sincerely want your firm to move to their town.

Learn about 127 Colorado communities — including Rangely — that have prime industrial sites to suit your business. Send for our free, 83-page Executive Portfolio. Write William C. Hacker, Colorado Division of Commerce and Development, 1240 State Capitol Annex, Denver, Colorado 80203.

COLORADO

where there's room to live and breathe

Probing the news

Commercial electronics

Voiceprints have won a hearing

Though courts are beginning to accept voiceprints as evidence, the technology needs to develop more before it is widely used

by Larry Armstrong, Washington bureau

Voiceprints—which some say are almost as foolproof as fingerprints—are winning recognition as valid courtroom evidence. And once the technique is developed for intelligence and industrial security systems, industry experts say the market for such equipment may amount to millions of dollars annually. Much depends on how accurately a person can be matched to his voiceprint.

Legality. The turning point for the scientific and legal acceptance of voiceprints as proof of a speaker's identity may be reached when the findings of a new Law Enforcement Assistance Administration report

are published in March. Meanwhile, convictions based on voiceprints were obtained late last month in a U.S. district court in Washington D.C.—and that was the first time voiceprints were admitted in a Federal court. In November, the Minnesota Supreme Court approved their use to establish probable cause for search and arrest warrants, to corroborate aural voice identification at a trial, and also for impeachment purposes [*Electronics*, Jan. 3, p. 26].

The LEAA report, to be published by the National Technical Information Service, concludes that “given a sufficient quantity and quality of

Seeing speech. Voiceprints show the frequency, pitch and intensity of speech sounds. The contours of each voiceprint depend on the physiology of a person's vocal tract.

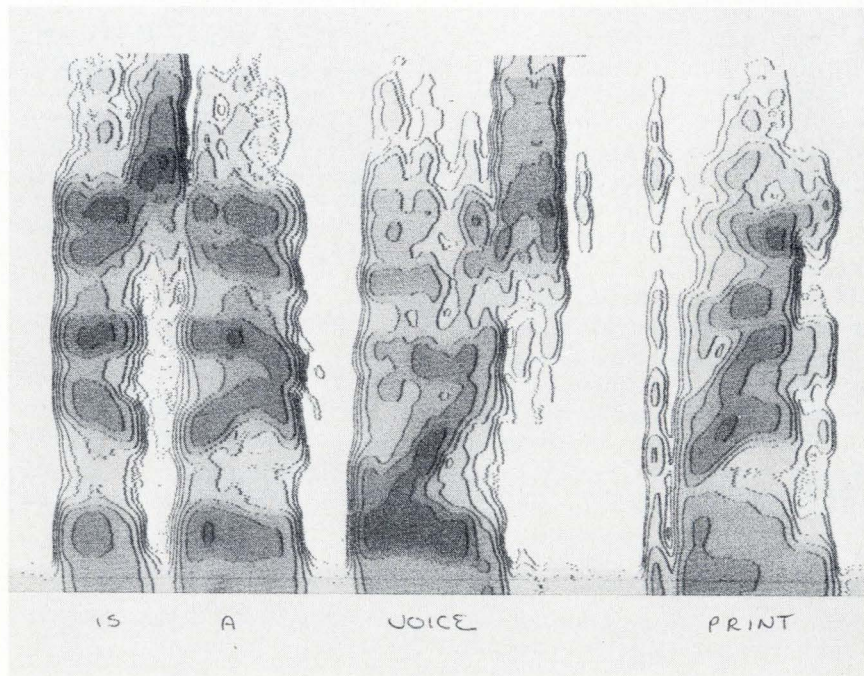



Introducing Two Great New Families of Minicomputers

GA introduces nine great new minicomputers in two related families. They work harder, act faster, learn quicker.

SPC-16 Family — The Power Leaders (Quantity of 10 price \$2,923)*

The all-new SPC-16 family are the power leaders. These 16-bit minis feature four times the processing power of any other minis you can buy. They're available in an SPC-16/40, /60, /80 series that features integral input/output and memory expansion to 16K for most systems applications ... and in an SPC-16/45, /65, /85 series featuring external I/O and 4K memory expandable to 64K for the "bare bones" OEM buyer or for larger

systems requiring extra memory and I/O capacity. All six models are fully hardware and software compatible with each other and with existing SPC-16's.

SPC-12 Family — The Price Leaders (Quantity of 10 price \$2,205)*

The all-new SPC-12 family are the price leaders. Three ultracompact models — the SPC-12/20, /15 and /10 — are available with standard 4K memory expandable to 16K and in I/O capacities to 19 minicontrollers. With fully compatible computer, I/O, interface and Real Time Executive modules, an SPC-12 system can be quickly and easily assembled to solve just about any industrial automation

problem. At a bedrock price.

Send today for descriptive literature on our two new families of "smart minis." We've tried to put our power/price story in plain English.

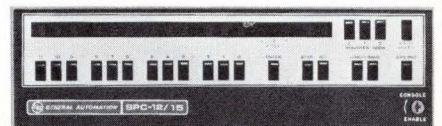

General Automation, Inc.



1055 South East Street
Anaheim, California 92805
(714) 778-4800 TWX 910-591-1695

'We Make The Smart Minis'

*Ask About Our Big New Discount and Easy-Buy OEM Policies.

Circle 95 on reader service card

Probing the news

known and unknown voice recording to work with, a qualified voice identification examiner can arrive at opinions that have an accuracy level comparable to other types of subjective examinations now made in forensic laboratories."

In tests conducted by two of LEAA's experts in the voiceprint project, Detective Sgt. Ernest Nash of the Michigan state department of police, and Oscar I. Tosi of Michigan State University's department of audiology and speech sciences, fewer than one in a hundred errors were recorded in matching speakers to voiceprints of isolated words. Still, the LEAA report is careful to point out that "this group of trials does not fit any type of forensic model and has no direct application" to law enforcement. Other trials, using voiceprints taken as much as a month apart and clue words extracted from fixed and random contexts, yielded total error rates of 15% to 18%. Such evidence in court is on a par with that of handwriting experts or eyewitnesses.

Getting personal. Voiceprints are obtained from sound spectrographs, tracings that indicate the pitch, frequency and intensity of spoken words. These features are based on highly individual physiological characteristics, such as the shape of a person's vocal tract, tongue, teeth, and palate. To identify speakers, trained observers match the long, undulating plots of frequency, time, and amplitude to a contemporary group of reference spectrograms. In a Michigan State University experiment headed by Tosi 240 speakers and observers were trained in three months.

Current LEAA funding is focused on automating the identification process. Almost \$500,000 will be used for studies at Stanford Research Institute, Menlo Park, Calif., to develop specifications for speaker recognition by machine. The automatic approach may prove to be "more promising" than human analysis of voiceprints because even experts are not as objective in their observations as machines, according to the report.

"We hope to see scientific and

practical payoffs within a year," says Karl D. Kryter, project director at SRI. He contends that the theory lags the hardware capabilities. The answer does not lie with large computers, he says. "Analyzing the hell out of the spectral data just doesn't provide useful information," he contends.

Automating the analysis. There are two common approaches to speaker recognition by machine, according to SRI. By using a spectrum analyzer consisting of a bank of bandpass filters, rectifiers, and smoothing circuits, the machine can generate and examine time-frequency-amplitude matrices of specific speech samples—a kind of "digital spectrogram." It then compares the sample to a reference matrix for each speaker, stored in the machine. Alternatively, the computer could run a statistical analysis of speaker-dependent parameters extracted from the speech signal.

Current SRI research is mainly directed toward specifying criteria for speaker recognition by machine, and only secondarily to the problems of building a device, although a researcher there adds that the program could well result in hardware specifications. But Texas Instruments in Dallas has been awarded a \$25,000 subcontract to study hardware instrumentation and questions of data management, such as the practicality of a central bank of information with access by telephone.

Some sources estimate that industry would be willing to pay up to \$500 million a year for a tool providing security identification beyond the law enforcement and forensic applications. However, "looking at industry's losses due to identification breakdowns shows that the market probably isn't that big," is Kryter's qualification. "Voiceprint systems would cost more than those losses."

Pure gold? Most other sources agree that the size of the potential market—which includes law enforcement, intelligence, and security buyers—would be millions of dollars annually, provided a practical, fairly economical approach can be advanced. "Everyone assumes there's gold there," an industry source says. "Whether it's 24-carat or not is another question." □

Look for your nearest Raytheon Oscilloscope Representative:

Avionics Liaison, Inc.
6770 Perimeter Rd.
Seattle, Washington 98108
(206) 767-3870

Coherent Mktg. Associates, Inc.
1890 Embarcadero Rd.
Palo Alto, California 94303
(415) 327-2217

FLW, Inc.
10760 Burbank Blvd.
N. Hollywood, Ca. 90601
(213) 877-5518

Instrument Associates, Inc.
175 Middlesex Tpke.
Bedford, Mass. 01730
(617) 275-0700

Klein Aerospace
PO Box 1056
Englewood, Colorado 80110
(303) 781-4967

KLS Associates, Inc.
387 Passaic Avenue
Fairfield, N.J. 07006
(201) 227-2900

K-G Electronics, Inc.
11151 Veirs Mill Rd.
Wheaton, Md. 20902
(301) 946-4055

RJC Associates
26 Morningside Drive
Cortland, N.Y. 13045
(607) 753-3909

Scientific Devices-Midwest
3300 S. Dixie Drive, Suite 212
Dayton, Ohio 45439
(513) 298-9904

Scientific Devices-Philadelphia
PO Box 201
Plymouth Meeting, Pa. 19462
(215) 825-2841

Scientific Devices-Southeast
707 E. Colonial Dr. Suite 6
Orlando, Florida 32803
(405) 424-6792

Scientific Sales Company
777 S. Central Expressway
Richardson, Texas 75080
(214) 231-6541

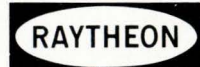

Why buy the Star of India? When you really need a little gem.

Overbuying can be princely fun. If you're the Aga Khan.

But now, with the current budget squeeze, common sense has entered the picture. So has Raytheon's CDU-150 scope.

A top quality, general-purpose oscilloscope with price/performance second to none. DC to 35MHz at 5 mV/cm. Dual channel. Big, bright 8x10 cm display. Stable triggering over the full bandwidth.

Time-base delay.

Plus light weight for honest portability. Ruggedness that can easily take hundreds of miles in the trunk of your car without a flutter. At a price of only \$1495.

Think about it. The uncompromising quality of the CDU-150. And the money you save by not buying more than you need. Send us the coupon. Or contact the nearest sales reps on the opposite page.

Raytheon Company
Instruments Operation
175 Middlesex Turnpike
Bedford, Mass. 01730

Gentlemen: Send information on the CDU-150.

Name _____

Company _____

Address _____

City _____

State _____ Zip _____

RAYTHEON

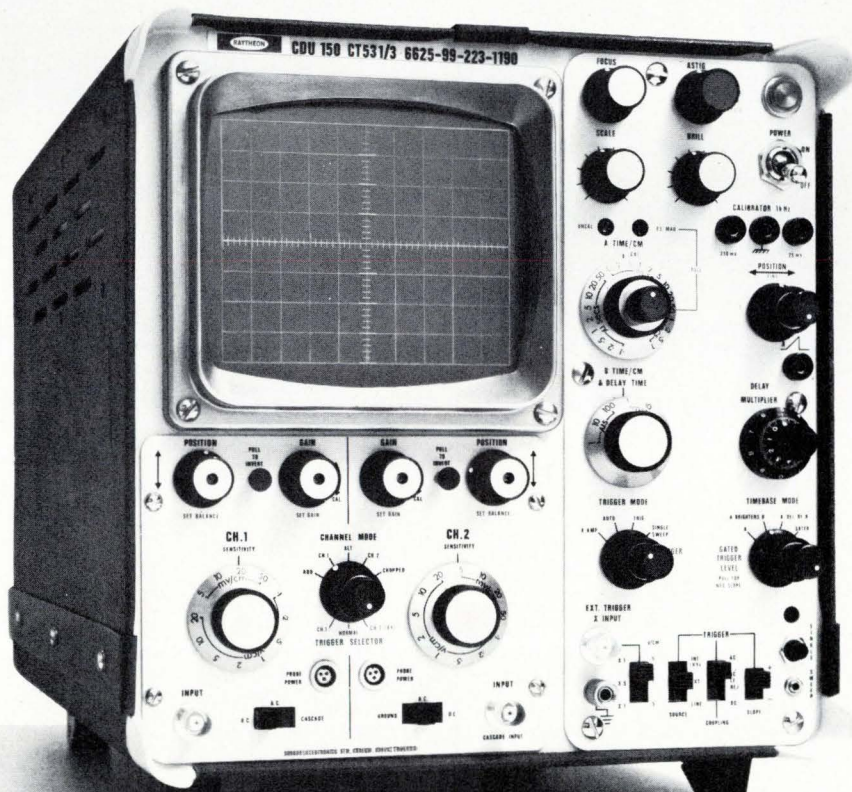

(Our little jewel.)

Dial direct and save.

Remember the old sweep function generators? If you wanted frequency modulation, amplitude modulation, frequency shift keying, or any other exotic waveform, you needed two generators, right? And an oscilloscope. Plus you had to make lots of complex control adjustments.

Well, that was before we introduced the Model 146 Multi-function Generator. The 146 gives you all of those features because it's really two complete generators in one box. You can use each one independently, or you can use one to control the frequency and amplitude of the other.

Note that the 146 has caliper-type dials. This unique calibrated system allows center frequency, sweep width, amplitude and frequency modulation limits to be set and read without an oscilloscope.

The Model 146 has a frequency range of 0.001 Hz to 10 MHz and sells for \$1495. That's a bargain price, considering the time and oscilloscopes you'll save.

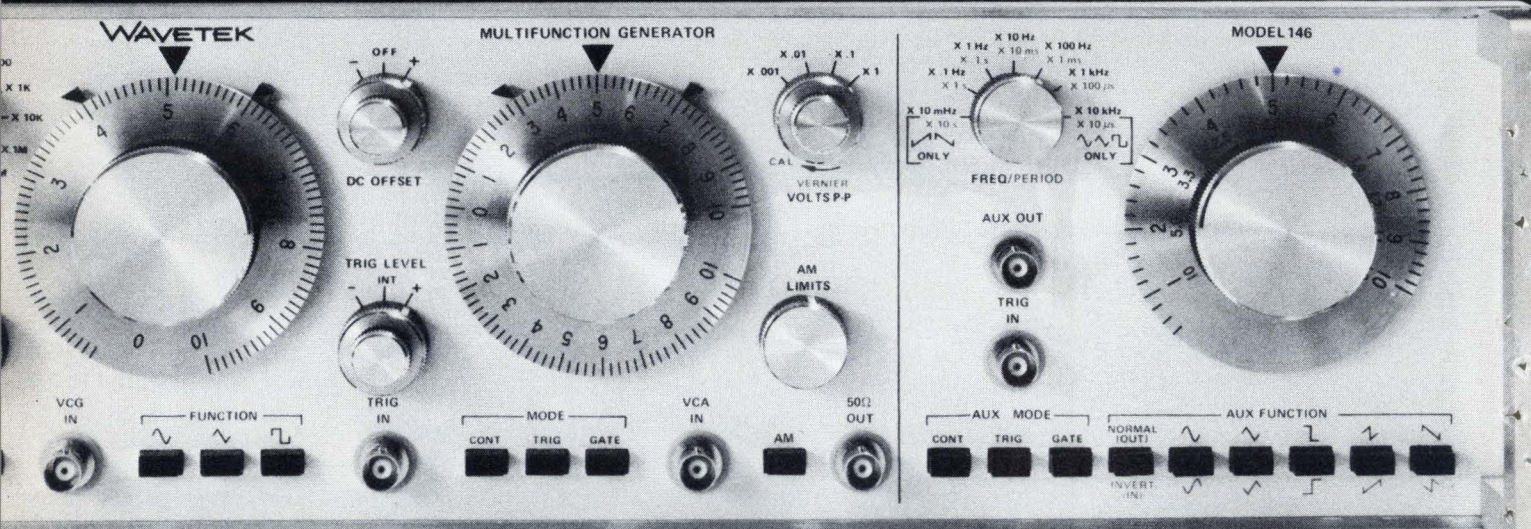

WAVETEK®

P.O. BOX 651, SAN DIEGO, CALIFORNIA 92112
TELEPHONE (714) 279-2200, TWX 910-335-2007

Digital multimeter has LED display built into probe

Autoranging 3½-digit unit has a \$325 price tag, runs three months on one set of alkaline batteries

With new digital multimeters practically springing up out of the woodwork, it takes a fairly significant improvement in price and/or performance to make a knowledgeable user sit up and take notice of a new entry into the field. Keithley Instruments engineers were well aware of this problem when they sat down to design their 167 Auto-probe digital multimeter. And the instrument they came up with reflects their determination to produce something really novel in the DMM field.

Perhaps the instrument's most impressive feature is its price—\$325 for a portable, battery-operated, autoranging, ac-dc, 3½-digit DMM. This price includes a set of six alkaline D-cells, a ground lead, and the attached probe.

The probe is the instrument's other outstanding feature. In addition to being the probe, it is also the housing for the instrument's custom-designed light-emitting diode display module. Thus, while poking around inside a chassis with the probe, the user has the numbers he's looking for right in front of him, instead of being displayed on a bench where he can't see them.

Long life. Less spectacular sounding, but also very important, is the instrument's long battery life. By including a push-to-read switch in the probe, the meter's designers gave its batteries a typical life expectancy of

three months. This corresponds to a continuous-use lifetime of about 20 hours.

Rechargeable nickel-cadmium batteries are available as an extra-cost option, along with a combination recharger/battery eliminator. Called the 1671, this rechargeable-battery kit adds \$65 to the unit's price. When the nickel-cadmium batteries are used, the typical lifetime is one month per charge.

Accuracy. Basically, the meter measures three quantities: dc volts, ac volts, and ohms. Current-measur-

ing capability can be added with an optional current shunt. As a dc voltmeter, the 167 covers the range from ± 1 millivolt to $\pm 1,000$ volts with an accuracy of $\pm 0.2\%$ of reading ± 1 digit. Its input impedance is 55 megohms shunted by approximately 200 picofarads.

As an ac voltmeter, the unit spans the range from 1 mv to 500 v rms. For voltage below 200 v, the ac accuracy is $\pm 1\%$ of reading ± 2 digits for the frequency range from 20 hertz to 10 kilohertz. For frequencies up to 20 kHz, the accuracy

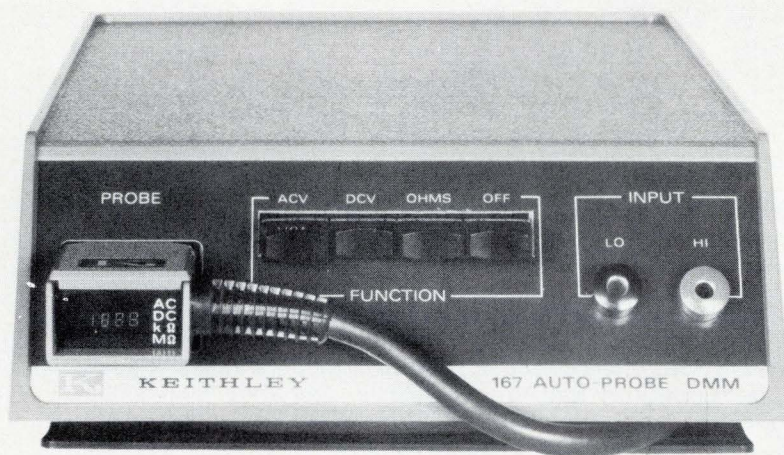

Two in one. The 167 can be used as a portable digital multimeter with a display in its probe, or as a benchtop instrument with the probe inserted into its receptacle on the front panel.

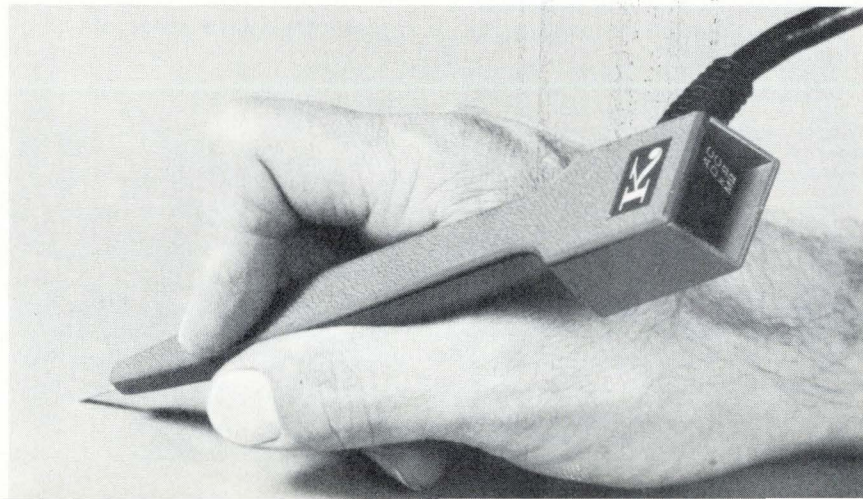

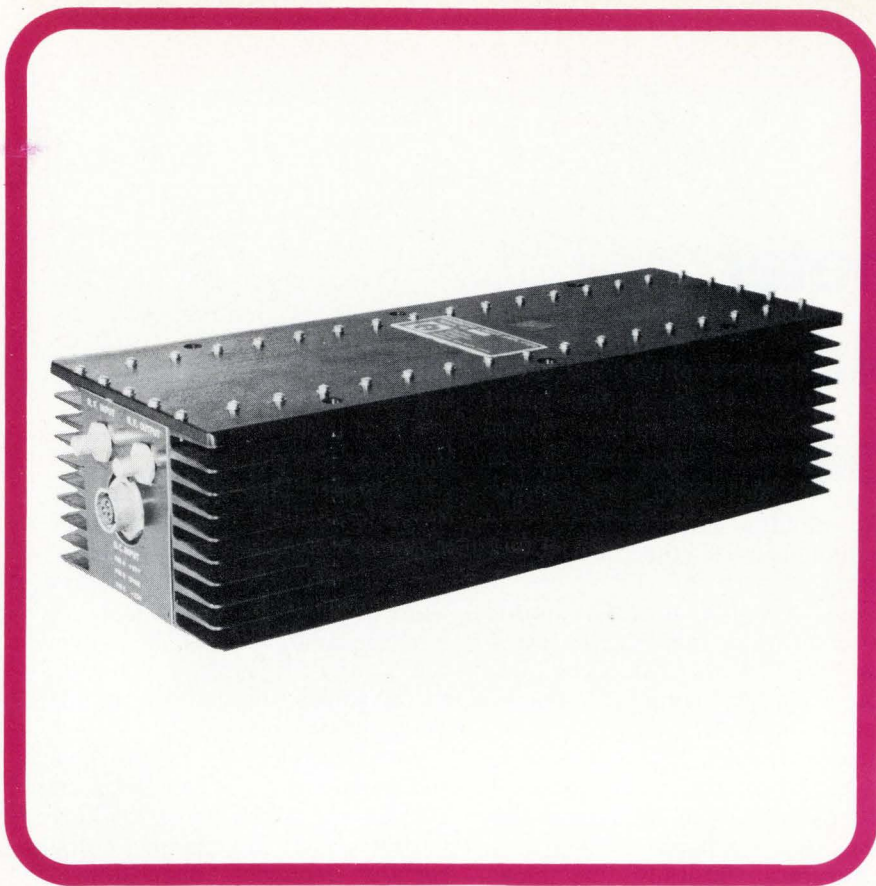

KEEP PLUGGING

A highly reliable solid state high frequency transmitter — 'build it in the field'.

Hermes Electronics Limited manufactures a 100W Broadband linear amplifier which replaces tubes in power output stages.

The 100W modules may be used singly or in groups to provide power output levels from 100 watts to many kilowatts. The amplifier has interface compatibility with the transmitter used in the majority of MANPACK systems, and with most mobile, airborne and fixed ground transmitter exciters.

It covers the frequency range 2MHz to 32 MHz and in combination can achieve power outputs to 5KW.

★ unique cooling system gives high reliability under adverse conditions

★ constructed for vehicular use

★ embodies overload protection

Hermes Electronics Limited can plug you into a wide range of HF equipment.

ASK US



Hermes Electronics Limited

Suite 315
2020 F. St., N.W.
Washington, D.C. 20006
Telephone 202 296 2978
TWX 710 822 1106

is $\pm 2\%$ of reading ± 4 digits. The ac input impedance is $50 \text{ M}\Omega$ shunted by approximately 200 pF .

For voltages between 200 v and 500 v, the ac accuracy is $\pm 2\%$ of reading ± 2 digits over the frequency range from 20 Hz to 1 kHz. This degrades to $\pm 5\%$ of reading ± 4 digits for frequencies up to 20 kHz.

As an ohmmeter, the instrument has a range of 1 ohm to $20 \text{ M}\Omega$ with an accuracy of $\pm 0.3\%$ of reading ± 1 digit $\pm 1\Omega$. The test current will vary from 1 milliampere to 0.1 microampere depending upon the resistance range. The output voltage is 5 v maximum into an open circuit.

Benchtop. When the probe is stored in its receptacle in the front panel, the push-to-read bar is automatically held down and the instrument becomes a standard benchtop DMM. Two banana jacks are available on the front panel for attaching test leads or an optional current shunt. The shunt, which sells for \$35, allows the meter to measure current on the voltage scales. It can be switched from 1Ω to 10 kilohms in five-decade steps, allowing the instrument to measure currents from $1 \mu\text{A}$ to 2 amperes.

The 167 is powered by a highly efficient dc-to-dc converter that will handle any input voltage from 6 v to 15 v. A test point for monitoring the battery voltage is available at the back of the instrument, so the meter can be used to check the condition of its own batteries.

If the batteries are allowed to run down, the dc-to-dc converter automatically turns off, thus avoiding inaccurate readings and preventing destruction of the rechargeable batteries, if they are being used.

Ruggedness has been insured through use of high-quality components. A glass-epoxy circuit board is sturdy and lends itself to servicing. Trimmer capacitors in the 167 are glass-piston types, and the potentiometers are sealed Cermet multi-turn devices. The number of discrete components is minimized by use of thick-film resistor networks which have good stability over wide temperature ranges.

Keithley Instruments, Inc., 28775 Aurora Road, Cleveland, Ohio 44139 [338]

Semiconductors

Stripline hybrid puts out 15 W cw

Power amplifier module, first in uhf line, offers 20-dB gain, 35% efficiency for land mobile radio

When the Federal Communications Commission added a 42-megahertz band to the private land mobile radio spectrum, the agency not only acknowledged the crowded condition that exists today but anticipated expanded future usage by such organizations as police departments, taxicab companies, and delivery services.

To take advantage of this growing market, and relying on the experience it has gained as a major supplier of discrete silicon power transistors, the Solid State division of the RCA Corp. is developing a line of uhf hybrid power circuits, in both thick and thin film versions.

First in the family is the TA8425, a power amplifier module that delivers 15 watts cw in the 440-470 megahertz range. It is similar in design to TRW's MK-12 module, which puts out 12 w.

"Good thermal management of the power chip permits power densities of 10,000 watts per square inch, and provides improved transient capability," says Norman C. Turner, manager of hybrid and rf devices in the RCA division. A key element in thermal management is the heat spreader, a copper or silver disk between the power transistor and the substrate that conducts the highly concentrated heat at the chip to a larger heat sink area on the substrate.

In hopes of gaining a healthy por-

tion of the \$45 million market for semiconductors in the \$500-million-a-year land mobile radio field, RCA is getting ready to supply the power amplifier module in sample quantities at \$49.50 each. Turner says the price goal for production quantities is \$15, and full-scale production should start about the end of the year or early next year.

The broadband amplifier has flat response over the range of 440-470 MHz. It has three cascaded stages for a minimum overall power gain of 20 dB, and operates at 35% efficiency. Supply voltage is 12.5 volts, as from a vehicle battery. Size of the package is 2.5 by 0.82 by 0.317 inches.

Construction of the amplifier is based on thin film technology, with gold striplines evaporated on an alumina substrate and subsequent bonding of thick film capacitors and transistor chips. The TA8425 can be used as a power amplifier connected

directly to the antenna, or as a driver for higher-power transistors.

Eventually, says Turner, his group will develop similar amplifiers for adjacent uhf bands, including the new 450-512 MHz assignment, and then will try for a power hybrid module for vhf (156-176 MHz) operation. Gain and power are easier to obtain at these lower frequencies, says Turner, but load pull due to output impedance mismatch—as when the antenna brushes against a tree branch—is more difficult to overcome at low frequencies. The challenge will be to design a circuit that handles this kind of fault condition safely.

Also eventually, commercial uhf power hybrids will use lumped-element techniques, devised for military products. These techniques will reduce both size and cost.

RCA Solid State Div., Rte. 202, Somerville, N.J. 08876 [339]

Broadband power. In 15-watt uhf hybrid amplifier, the power transistor chip mounts on the metal base rather than on the stripline substrate for more effective heat dissipation.

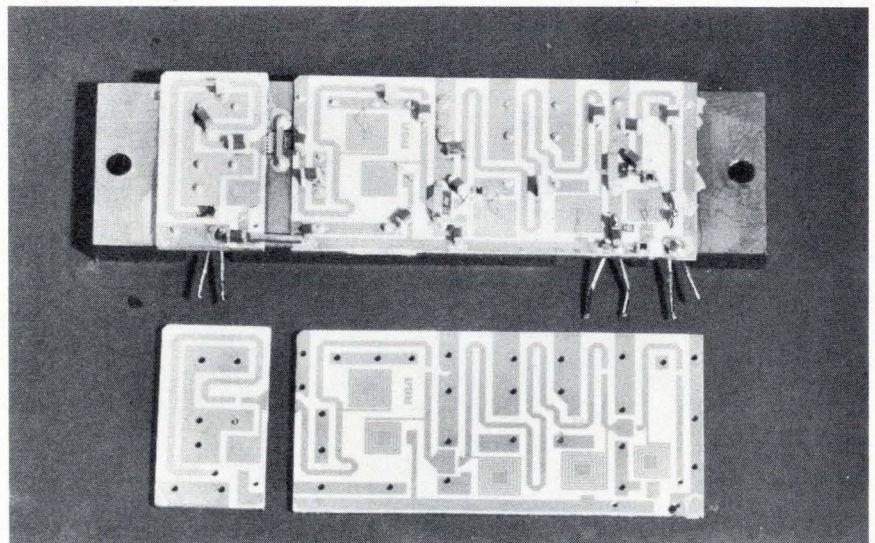

fact

this fully loaded, high-performance DMM equals or exceeds the performance of any other comparable DMM,



yet costs you 50% to 80% less.

The three major circuit advances incorporated into our Tri-Phasic™ Digital Multimeter eliminates 3 of the 4 principal sources of error found in all conventional dual-slope DMM's. Taken together, these circuits offer a sophisticated simplicity that dramatically reduces the cost of producing high-performance DMM's . . . and provide an *order-of-magnitude improvement* over previous techniques.

Very briefly, here's what the three circuit advances do:

TRI-PHASIC™ A/D CONVERSION — prevents any component or circuit, except the internal voltage standard, from affecting the accuracy of the A/D converter.

ISOPOLAR™ REFERENCE STANDARD — delivers both positive and negative reference potentials by using only a *single*, unipolar reference source. The premium-grade, aged, current-servoed zener reference is optimally stabilized by a temperature-controlled oven.

RATIOHMIC™ 4 — WIRE RESISTANCE MEASUREMENT — eliminates expensive, error-contributing constant-current sources. By comparing the drop across the unknown to that across internal precision standards, under identical current conditions, the circuit is rendered insensitive to current variations.

Our fully loaded, top-of-the-line 5½-digit, high-performance DMM — Model 2540 — sells for \$1195 (*that's 50% to 80% less than all comparable DMM's*). And it's one-half the size, one-half the weight, and consumes one-half the power. Standard features include:

DC Volts; AC Volts; 2 and 4-wire resistance; Voltage Ratio; Auto Ranging; Auto Polarity; Isolated BCD Outputs; Remote Triggering; and Remote Ranging. Basic accuracy ($\pm 0.001\%$ f.s. $\pm 0.007\%$ of reading ± 1 LSD) is guaranteed for 6 months.

There's a Tri-Phasic™ DMM for every purpose. Every useful combination of capabilities and optional features is available as a *standard*. There are 8 models to choose from: four 5½'s from \$995 to \$1195; and four 4½'s from \$580 to \$675.

Now you can buy two or three 5½'s with what you would have spent for any other comparable DMM. If you were planning to buy a high performance 4½, you can now afford a high performance 5½ . . . and still get the most advanced DMM available.

Call Bob Scheinfein at (617) 246-1600 to arrange for a demonstration . . . or, for complete specifications, write Data Precision Company, Audubon Road, Wakefield, Massachusetts 01880. We'll give you the facts. They'll speak for themselves.

 **DATA PRECISION**
...years ahead

Components

Converters offer speed, accuracy

Low-priced a-d units use a parallel-serial circuit method, give 0.1% accuracy

High-speed, high-performance converters are usually priced at \$900 and up. But now, two analog-to-digital units selling for \$250 and \$350 have been brought to market by Cycon Inc., a recently formed Sunnyvale, Calif., company. The CY-08, an eight-bit converter, and the CY-10, a 10-bit unit, offer throughput rates of greater than 4 megabits per second. The CY-10, selling for \$350, converts an analog signal to its 10-bit binary equivalent in less than 2.5 microseconds. The CY-08, which is priced at \$250, requires less than $2\mu\text{s}$ to make an eight-bit conversion.

Both converters are modules, measuring 4.6 by 4.2 by 0.4 inches. The CY-10 consists of 15 linear devices including 11 comparators, 10 digital medium-scale integrated devices, and 66 precision thin film resistors. The CY-08 has the same digital logic, nine comparators, and 55 resistors. Included in both units is a precision zener reference.

Instead of the commonly used successive-approximation technique, Cycon employs a parallel-serial circuit conversion method. The comparators simultaneously see the input. They compare all levels with the unknown and select the combination that approximates the binary code to within $\pm\frac{1}{2}$ least-significant-bit. Each comparator has a different bit weight—1,2,4,8,16, etc. If the analog input is 14, for example, the switches 2, 4, and 8 would be turned on while the other switches would shut off.

If the analog input signal changes by more than $\pm\frac{1}{2}$ LSB, the system is self-tracking—it automatically initiates another conversion. Accuracy is 0.1% at 18 volts per millisecond.

If the input signals are changing faster than that, thus exceeding the tracking speed, the accuracy will be off but not catastrophically, Cycon engineers say. At 30 v/ms, for example, the error would be less than 3 LSB.

The CY-08 and CY-10 are aimed at applications in equipment for spectral analysis, studies of non-uniform signals, and analysis of vibration, stress, and evaporation. They are also suited to applications in data transmission and in instrumentation for pollution control and medical electronics.

A track-and-hold feature is optional with both units. In quantities of less than 10, the converters are available from stock. OEM quantities will be ready in February.

Cycon Inc., 1080 East Duane Ave., Sunnyvale, Calif. 94086 [341]

'Logic-powered' meters trim price, size, wattage

A family of small, low-priced digital panel meters developed by Analogic Corp. operate directly from a single 5-volt supply, allowing them to be powered from the same source as integrated logic circuits.

Three models are currently being offered: the AN2525, a $2\frac{1}{2}$ -digit meter that consumes only 1.5 watts; the AN2535, $3\frac{1}{2}$ digits, 2 w; and the AN2545, $4\frac{1}{2}$ digits, 2.5w. Single-quantity prices are \$69, \$100, and \$200, respectively, dropping to \$48, \$68, and \$140 for OEM-quantity orders. All use flat-plane, seven-segment incandescent readouts, and come in a compact case measuring 1.4 inches high by 1.4 in. deep by 3.4 in. wide.

Rather than the dual-slope integrator used by most DPMS, the new meters have a three-stage integrating converter that eliminates the largest source of DPM error. After every measurement, a zero correction is made, effectively doing away with all offsets and offset drifts in the integrator/comparator chain.

Other features include BCD outputs, a full complement of computer interfaces, overrange blanking,

bipolar operation, and push-through mounting. Moreover, both power and signal inputs are supplied as screw terminations so that connectors are not needed.

Accuracy is $\pm 0.25\%$ of reading (± 1 count) for the AN2525, $\pm 0.05\%$ of reading (± 1 count) for the AN2535, and $\pm 0.02\%$ (± 1 count) for the AN2545. Evaluation prototypes will be available in approximately six weeks, and OEM quantities in about 120 days.

Analogic Corp., Audubon Rd., Wakefield, Mass. 01880 [342]

Feed-through capacitors suppress emi to 1,000 MHz

Monolithic and tubular-dielectric feed-through capacitors, designated Ceralam, are for general purpose applications, and have an emi suppression to 1,000 MHz. The 50-, 100- and 200-volt FLA Ceralam and 50-,

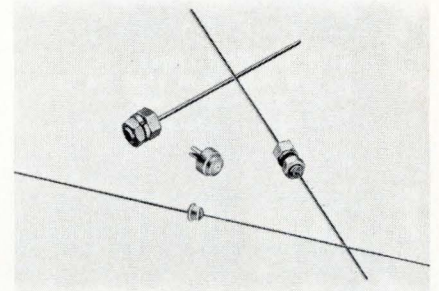

1,000-, and 1,500-volt tubulars are available in capacitances ranging from 10 pF through 140,000 pF. Capacity tolerances of $\pm 5\%$, $\pm 10\%$, and $\pm 20\%$ are available for FLA types, and tolerances of $\pm 10\%$ and $\pm 20\%$ are offered in the general-purpose units.

Aerovox Corp., New Bedford, Mass. 02741 [347]

Cascadable amplifier operates from 5 to 400 MHz

A cascadable amplifier operates in the range from 5 to 400 MHz without bandwidth shrinkage. Additionally, it has usable gain through 1,000 MHz. Packaged in a TO-12 transistor can, the unit features flat response

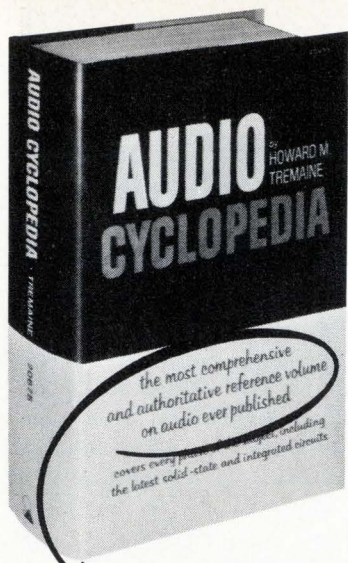

Worth repeating:

"The most comprehensive and authoritative reference volume on audio ever published!"

Updated 2nd Edition

AUDIO CYCLOPEDIA

By Dr. Howard M. Tremaine

- 1758 fact-filled pages
- Covers more than 3500 topics
- Over 1800 illustrations
- Completely updated content

It's a library in one handy volume! Fully updated to include latest developments, right down to the newest solid-state and integrated circuits. Gives you concise, accurate explanations of all subjects in the fields of acoustics, recording and reproduction... with each subject instantly located by a unique index and reference system.

It's the indispensable, complete reference book for anyone associated with or interested in the audio field. 20675—\$29.95

25 sections! Contents include: basic principles of sound; acoustics, studio techniques and equipment; constant-speed devices, motors and generators; microphones; attenuators; equalizers; wave filters; transformers & coils; sound mixers; VU meters; tubes, transistors & diodes; amplifiers; disc recording; cutting heads; recording & reproducing styli; pickups; magnetic recording; optical film recording; motion picture projection equipment; speakers, enclosures, headphones & hearing aids; power supplies; test equipment; audio-frequency measurements; installation techniques; special charts & tables.

10-day FREE EXAMINATION

Howard W. Sams & Co., Inc.
4300 West 62nd St.
Indianapolis, Indiana 46268

E 012

Send me AUDIO CYCLOPEDIA (20675) for 10-day examination, without cost or obligation. I will send \$29.95, or will return the book within 10 days. (Include sales tax where applicable.)

I enclose \$29.95 payment. Send my copy postpaid with full 10-day refund privilege. (Include sales tax where applicable.)

Name (Print) _____

Address _____

City _____ State _____ Zip _____

New products

across its six-octave bandwidth. Applications include commercial communications equipment, uhf and vhf television, and test equipment markets. Called GPDs, the amplifiers are available with either 9 or 13 dB of gain with noise figures ranging from 6 to 9 dB. Price is less than \$30 in production quantities.

Avantek Inc., 2981 Copper Rd., Santa Clara, Calif. 95051 [343]

Low-noise crystal oscillator provides 20 mW output at vhf

A crystal oscillator provides a 20 mW (+13 dBm) output with a stability of 1×10^{-8} per day at any fixed frequency in the 25 to 150 MHz range. Output signal to noise is better than 110 dB/Hz, 100 Hz from the carrier and 130 dB/Hz, 1 kHz from the carrier. The model CO-224 is

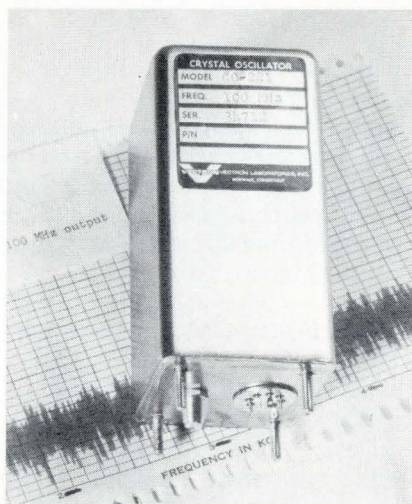

suitable for multiplication to microwave frequencies as well as for use directly at its output frequency. Options include voltage frequency control.

Vectron Laboratories Inc., 121 Water St., Norwalk, Conn. 06854 [346]

Heat sinks designed for vertically mounted devices

The series 6027 High Rise heat sinks offer an alternative to extrusion units for cooling vertically mounted power semiconductors. Lighter and

lower-priced than extrusion types, they provide natural convection cooling with thermal resistance running as low as 2.3°C per watt. The

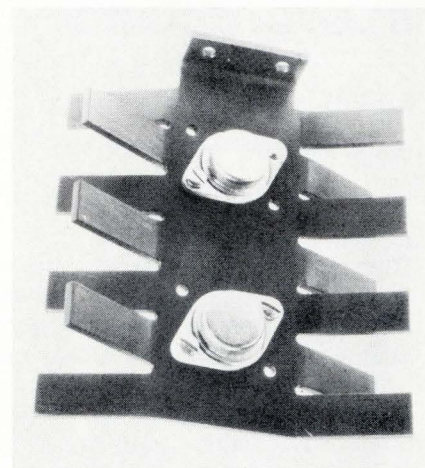

series 6027 offers three one-piece heat sinks for mounting one to three power semiconductors in a vertical plane. Semiconductors are mounted on a central web, and heat is conducted to the alternating vanes.

Thermalloy Inc., 8717 Diplomacy Row, Dallas, Texas 75247 [345]

Resistor with radial leads is sealed in a fluid bed

A thick film resistor, designated Flatso, has radial leads and is encapsulated in a fluid bed. The unit measures 0.1 in. and 0.125 in. for 0.25- and 0.5-watt types respectively, making it suitable for high-density packaging applications. The 0.25-w units have a maximum voltage rating of 350 v with a resistance range of 50 ohms to 1 megohm, while the 0.5-w units are rated at 750 v maximum with a resistance range of 1 kilohm to 25 megohms.

Pyrofilm Corp., 60. S. Jefferson Rd., Whippany, N.J. 07981 [344]

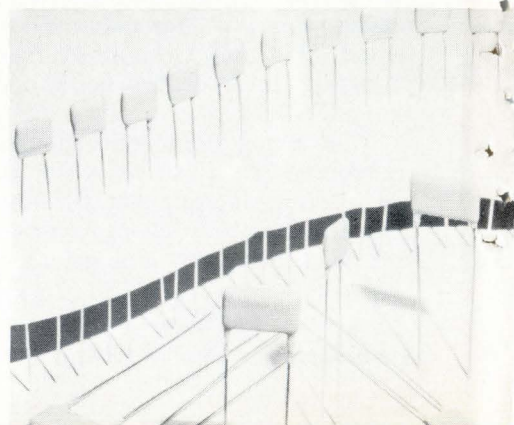

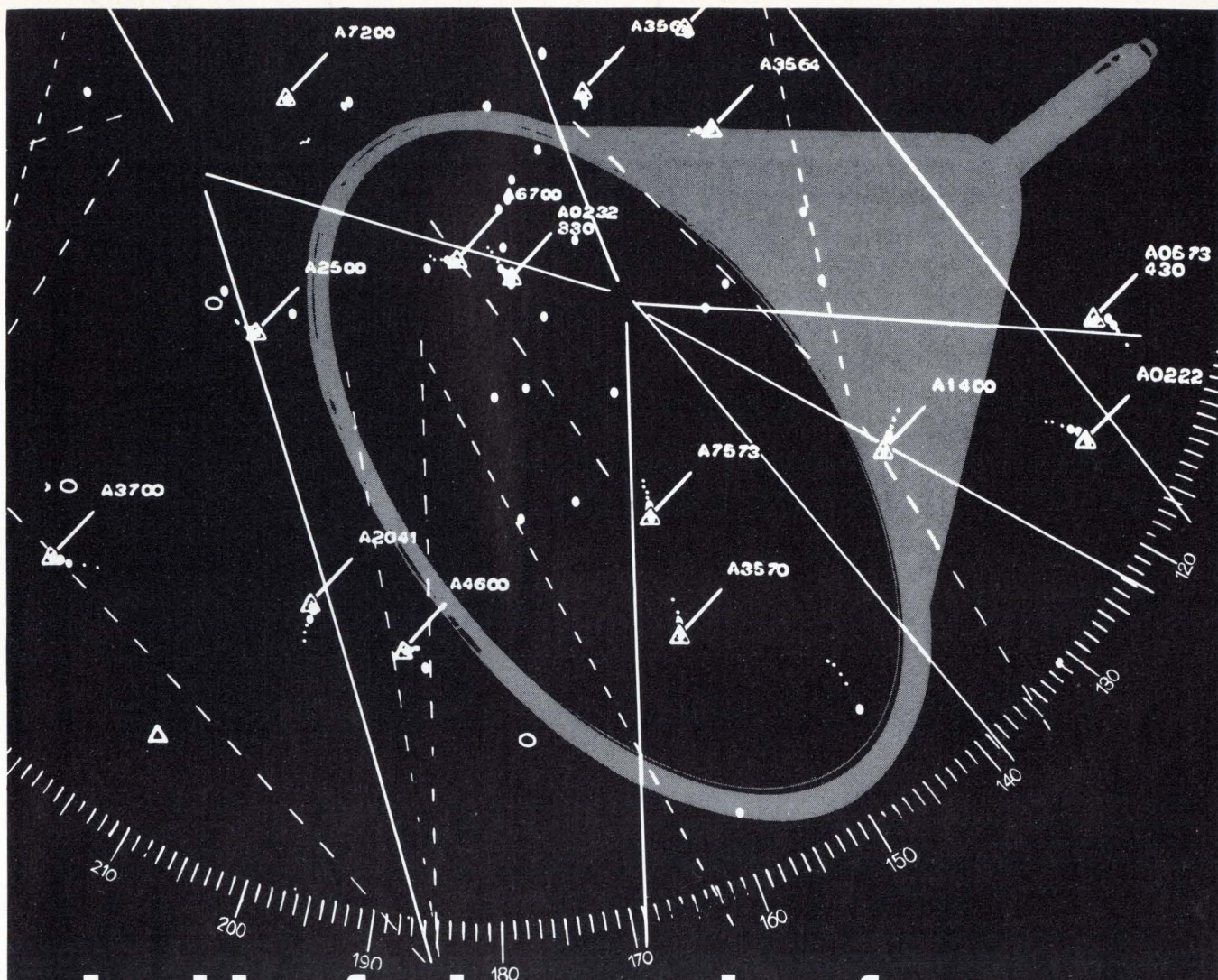

Looking for improved performance in your 22" CRT display...

THOMSON-CSF, can provide 22" metal-cone CRT's which are backed up by many years of manufacturing experience and technical know-how in this field. As compared with all-glass CRT's, these metal-cone tubes offer a parallax-free display, due to their flat, constant-thickness faceplate, and they're lightweight (34 lbs). They do not require any mu-metal shield, thus reducing initial equipment cost. Three production models are shown below:

Our unique OME 1184 features dynamic focus which provides higher and more uniform resolution across the screen diameter, thus allowing the presentation of flight data in alpha-numeric characters as small as 0.2" x 0.3". Greatly improved readability is achieved

Type	Diameter	Overall length	Deflection angle
OME 1489*	22"	29"	53°
OME 1490**	22"	31"	53°
OME 1184	22"	30"	53°

* interchangeable with R 6182
** interchangeable with R 6263

even in highly lighted ambient conditions.

For more information on these, our 16" CRT's, and our full line of radar display CRT's for air traffic control, please circle the appropriate number on the Reader Service Card, or contact us direct.



THOMSON-CSF

THOMSON-CSF ELECTRON TUBES, INC. / 50 ROCKEFELLER PLAZA / NEW YORK, N.Y. 10020 / (212) 489-0400

France - THOMSON-CSF Groupement Tubes Electroniques / 8, rue Chasseloup-Laubat / 75 PARIS 15° / Tél. 566.70.04

Germany - THOMSON-CSF Elektronenröhren GmbH / Am Leonhardsbrunn 10 / 6 FRANKFURT/Main / Tel. 70.20.99

Italy - THOMSON-CSF Tubi Elettronici SRL / Viale degli Ammiragli 69, / ROMA / Tel. 63.80.143

Sweden - THOMSON-CSF Elektronrör AB / Box 27080 / S 10 251 STOCKHOLM 27 / Tel. 08/60.09.90

United Kingdom - THOMSON-CSF Electronic Tubes Ltd / Bilton House, Uxbridge Road, Ealing / LONDON W5 2TT/Tel. 01-579.1857

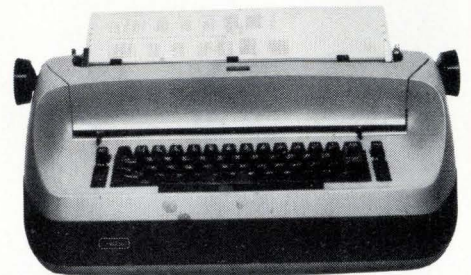

If you need more than just a simple answer

Any calculator can give you answers. But if you need more — if you need solutions — then bring on your toughest problems and see what Wang calculators have to offer.

Power, for one thing. Power to whiz you through interest rates or static values of pre-stressed concrete bridges. Or just about anything in between.

Versatility: each Wang calculator is field-expandable to fit your changing needs, to handle more difficult challenges.

And value: each Wang calculator has the greatest price/performance ratio in its respective class.

Wang is the largest American calculator manufacturer and offers the most extensive line of calculators in the world. We've earned a reputation for excellence and we intend to protect that reputation with superior products and factory-direct service.

So think about it: do you need answers?
Or do you really need us instead?



WANG
LABORATORIES, INC.

836 North Street
Tewksbury, Massachusetts 01876
Telephone: (617) 851-7311
TWX 710-343-6769
Telex 94-7421
Dept. E-1

New products

Subassemblies

Plug-in extends oscillator range

Amplifier head converts 10 kHz-2MHz low-level signals to 20-50-watt range

Amplifiers that provide 50 watts at 10 kilohertz for testing equipment susceptibility to electromagnetic radiation at the low-frequency end of the spectrum have typically cost from \$5,000 to \$20,000. But the Instrumentation division of Microdot Inc. has put a price tag of \$1,150 on a plug-in amplifier head for its model 445 power oscillator that extends that instrument's capability downward to the 10 kHz-2MHz range. The plug-in gives the 445 the ability to cover from 10 kHz to 2,500 MHz.

Thomas Eccles, division manager of instrument products, says the nearest competitive power oscillator

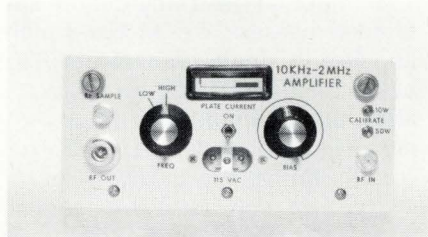

to the model 445 reaches only as low as 200 MHz, and is a much bulkier instrument.

With the model 3201 head added to its plug-in options, the Microdot oscillator is applicable not only for susceptibility testing of military hardware, but also for checking the susceptibility of commercial microwave ovens and, in the automotive industry, such devices as automatic speed controls and braking systems to assure that the silicon controlled rectifiers in these units don't fail because of radio-frequency interference.

Eccles adds that the 3201 adapts the model 445 for wattmeter and attenuator calibration, for power transistor testing, and for antenna pat-

tern measurement. The amplifier accepts inputs typically as low as 200 to 500 milliwatts from any conventional function generator or oscillator, and amplifies a-m, fm, pulse, square-wave and other input signals. Power output at 10 kHz is typically 50 w, with 40 w minimum; at 2 MHz, it's 20 w, with a minimum of 10 w. Power stability is ± 0.2 decibel per hour after two hours.

No tuning is required, and power output monitored by the 3201 can be read directly on the instrument.

Instrumentation Division, Microdot Inc., City of Industry, Calif. 91744 [381]

Infrared night viewer provides visible images

An active night viewer for photography, remote detection and surveillance uses an infrared searchlight and a high-resolution image converter. The model IRV 7500 has a range of greater than 200 feet, weighs 2.5 pounds, and provides visible images with a resolution of 50 line pairs per millimeter. Power for the searchlight is obtained from a pocket-sized 12 volt rechargeable battery; alternately, a cable with an automobile lighter plug may be used. Photographs can be taken with a standard 35mm single-lens reflex camera. Price is \$540.

ElectroPhysics Corp., 48 Spruce St., Nutley, N.J. 01110 [384]

Voltage comparator offers impedance of 50 megohms

An input impedance of greater than 50 megohms has been designed into the model 535 Voltensor, a voltage comparator module. It can be used directly with high-impedance sources to detect voltage levels and provide alarm or control signals without loading the source. In addition, it can monitor high impedance voltage dividers. According to the company, voltages as high as 20,000 v have been monitored to 0.05% of absolute value, using the Voltensor

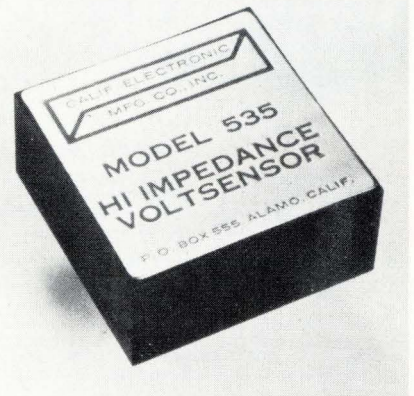

and a high-impedance voltage divider string. Price is \$58 in single quantities. Delivery of the units is from stock.

California Electronic Manufacturing Co. Inc., P.O. Box 555, Alamo, Calif. 94507 [383]

Digital-to-synchro converters accept 12-bit binary words

Digital-to-synchro converters used in remote control of antennas, indicators, and servo systems will accept up to 12-bit binary words and translate this data into three- or four-wire 400-hertz synchro or resolver information. Depending on the input reference voltage, the synchro equivalent can be produced to yield 11.8-, or 90-v output voltages at 3 voltamperes maximum. The digital input is TTL-compatible or DTL-compatible, and the required input power is 5 v dc at 250 mA and ± 15 v dc at 200 mA.

Northern Precision Laboratories Inc., 202 Fairfield Rd., Fairfield, N.J. 07006 [387]

Binary-to-decimal decoder uses pc board relay

Built for industrial applications, a new line of modules uses a printed-circuit board relay to perform a variety of switching functions. First product is a binary-to-decimal decoder that combines the simplicity of ceramic magnet latching relays with the reliability of pc boards. The relays plug directly into the board without sockets or soldering. The

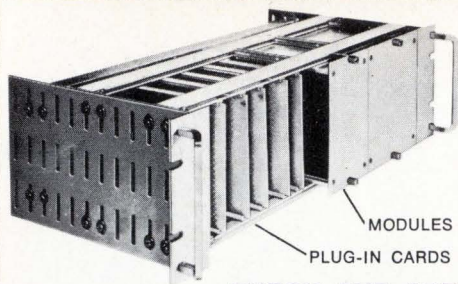

Vector-strut Cages Have Universal Adjustability

- STRENGTH
- HANDSOME APPEARANCE
- QUICK ASSEMBLY
- LOW COST

CHECK THE SPECS AND SEE:

THE VECTOR-STRUT CAGE provides an adjustable aluminum frame which through customer test has proven to be more versatile than other competitive units on the market.

- Mountable on 10", 19" or 24" racks.
- Three standard heights - 3 $\frac{1}{2}$ ", 7 $\frac{1}{2}$ ", 8 $\frac{3}{4}$ ".
- Three standard depths - 8.975", 11.975", 15.725".
- Prototype quantities shipped from stock. Production quantities in minimum time.
- Vertically slotted side walls and adjustable cross member end brackets allow universal height and depth adjustability for cards and module cases.
- Infinite adjacent positioning capability for modules, cards and connectors with extruded fastener holding ducts.

"EFP" ALUMINUM MODULE CASES[®] to fit Vector-Strut Cages

- Sixty (60) standard sizes for circuit cards, featuring $\frac{1}{16}$ " extruded grooves on .150" centers across case width for easy card mounting — no holes required in circuit board.
- Slide out side covers for quick access to cards.
- Front panels with captive thumb screws and rear panels either slotted or closed for user's connector design.

FOR HIGH FREQUENCY Vector Pak plug-in cases provide 90 to 100 DB of shielding with optional side panel gasketing.

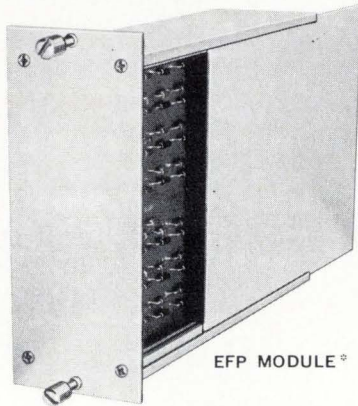

EFP MODULE[®]

[®] Patented Features

Write the factory for specification data and prices.



Vector ELECTRONIC COMPANY, INC.
12460 Gladstone Ave., Sylmar, Calif. 91342

Circle 142 on reader service card

decoders take any 6-, 12-, or 24-volt binary dc logic input and convert it to decimal output. They can be used as buffer registers, and, therefore, multiplexing is easy. Contacts of the

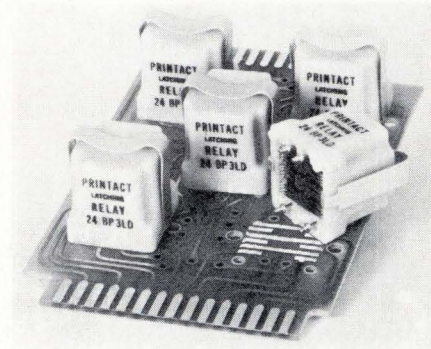

standard model, designated PD-5LD, are rated for 1 ampere at 24 volts dc and 0.5 A at 0.115 v ac resistance load. Price is \$25.

Printact Relay Division, Executone Inc., P.O. Box 1430, Long Island City, N.Y. 11101 [386]

Instrumentation amplifiers are low in drift and noise

Two modular instrumentation amplifiers measure 1.5 inches square and 0.4 in. high. The model 310J has a maximum drift of $\pm 3 \mu\text{V}/^\circ\text{C}$ and a maximum noise of $10 \mu\text{V}$ root-mean-square, while the 310K has corresponding specifications of $\pm 1 \mu\text{V}/^\circ\text{C}$ and $3 \mu\text{V}$ rms. Both models have an input range of ± 10 v, and 10-megohm input impedance, and a minimum common mode rejection ratio of 100 dB from dc to 100 Hz. Price for the model 310J is \$29, and for the 310K, \$59, in quantities of one to 24.

Function Modules Inc., 2441 Campus Dr., Irvine, Calif. 92664 [388]

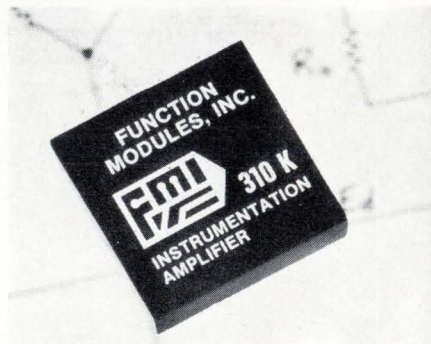

Minnesota

"The Lake country can become a kind of addiction with men, a deep and private gut feeling." *

Here's fair warning. Minnesota is one of the most difficult states in the country to ask people to transfer from. They like it here and stay. Result: a stable, productive, well-adjusted work force. That means profit!

*Quoted from an article in "Western's World"

FACTS IN 48 HOURS

STATE OF MINNESOTA Dept. of Economic Development
Industrial Development Division, Suite 211
51 E. 8th Street, St. Paul, Minn. 55101

I'm interested in Minnesota. Send me facts.

NAME _____ TITLE _____

FIRM _____

ADDRESS _____

CITY _____ STATE _____ ZIP _____

All inquiries held in strict confidence.

It's good to be in Minnesota

Data handling

Smart terminal has low price

Remote batch unit with minicomputer can emulate wide range of machines

As computer networks grow, so does the demand for remote batch terminals that can operate effectively with more than one mainframe. The result: more companies are entering the field, and competition means lower prices.

The newest entry is Intelec Inc., Garland, Texas. The machine, an intelligent terminal with an internal minicomputer for added versatility, is called the model 3000. The terminal leases for \$500 to \$600 a month, but C. Michael Bowen, vice president for sales, says it can do the job of terminals that lease for \$800 to \$1,500 a month.

The integral minicomputer enables the Intelec terminal to be programmed for different jobs and to operate with different mainframes. Among the advantages of the model 3000 are error screening, reduction of line costs through compression of data to eliminate redundancy, and local job queuing.

The Intelec terminal can emulate such equipment as the IBM 360/20 computer, and the IBM 2780, Univac 1004/9000, and Control Data Corp. 200 terminals. The RACE microprocessor, programmed in RPG language, has stand-alone processing capability through software, with symbolic assembler, debug and edit, program load and dump, diagnostic routines, and mathematics. Programs can be run first in random-access memory, then stored in read-only memory for fast, convenient reuse as needed. Additional programs on ROMs can be added by the user.

The Model 3000 is built around the RACE microprocessor. The basic system includes the RACE minicomputer with 4,096 words of memory, a 300-card-per-minute

card reader, a 100-character-per-second printer, the communications console and cabinet, synchronous communications adapter, automatic answer, interval timer, and emulation package. Typical options available include faster readers and printer, CRT terminal, Teletype, integral modem, asynchronous adapter, magnetic and disk drives. The computer can handle up to 32 input/output channels.

The microprocessor is an 8-bit machine using standard transistor-transistor-logic MSI chips. There are 190 instructions sets, either 8- or 16-bit instructions, and optional-direct-memory access. The MOS RAM is expandable to 16,384 words and has a 1.25-ms cycle time. The 96 words of ROM, expandable to 2,048, has a 250-ns cycle time. The system can communicate as fast as 9,600 bits per second, either synchronously or asynchronously.

A typical model 3000 sells for \$14,950 or leases for \$510 per month on a one-year lease. Delivery time is 60 days.

Intelec Inc., 2612 National Circle, Garland, Texas 75041 [361]

Time-division multiplexer channels share memory

Time-division multiplexers are usually more expensive than the frequency-division type, mainly because TDMs require a memory for every channel, while analog FDMS require no memory at all.

But now, to give users the benefits of TDMs without high price tags, Timeplex Inc., has introduced the Timeplexer. Its price is \$10 per channel per month per end on a two-year lease for a 16-channel basic unit, which includes modem and 16-channel cards.

The secret of the low cost is the sharing of memory and logic among several channels. Besides the 16-channel version, four- and 20-channel models are available. All provide character-interleaved multiplexing of any number of asynchronous data channels from 50 to 1,200 bits per second or synchro-

nous data channels from 600 to 7,200 bits per second. And, unlike other multiplexers that insert a sync character of bit after every scan cycle, the Timeplexer inserts an ASCII sync character after every 12 cycles.

Standard features include automatic midpoint channel feedthrough, a test character generator-comparator, military standard or current interfaces, remote loopback, provision for sharing intercity party lines, and three full-duplex control signals. Options available include adaptive speed channel cards, software demultiplexing formats, and redundant common logic and power supply. With this last feature, the second supply assumes the load in the event of a power alarm and, if there is a hardware alarm, the modem is switched to the alternate set of cards.

Timeplex Inc., Box 202, 65 Oak St., Norwood, N.J. [362]

Punched-tape reader uses minimum of panel space

A photoelectric punched-tape reader called the Mini-Reader TRM9300B, requires 5¼ by 7 inches

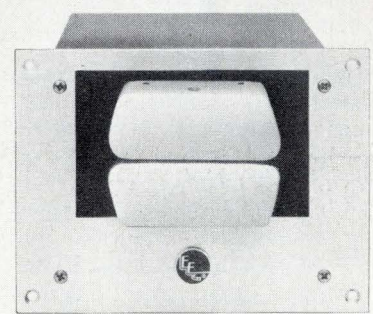

of front panel space, and reads standard five-, six-, seven-, and eight-level tapes with up to 60% light transmittivity without adjustment. The reader uses light-emitting diodes as lamps, and input and output signals are DTL-, RTL-, and TTL-compatible. Other features include a self-cleaning read head, and a stepping motor for stop-on-



An Export Opportunity

Australian Electronic Importer with national sales coverage, full warehousing and servicing facilities interested in handling additional electronic lines that fit into existing sales pattern.

We are part of an Electronics Group with turnover in excess of \$10,000,000 and well established contacts with Australian Government Departments and utilities, Education Authorities and private industry. Only interested in products on an exclusive agency basis, that are non-competitive with existing range.

We currently handle:—

Component Division

- Integrated Circuits • Precision Resistors • Trimming Potentiometers • Printed Circuits.

Instrument Division

- Miniature Chart Recorders • Multimeters • Signal Generators • High Voltage DC Power Supplies • Gaussmeters • Panel Meters • Signal Processing Instruments • Electrometers • Tunable Filters • Vibration Instruments.

If you do no business in this vital expanding continent or are disappointed with your current results, please send three copies of your literature and an export price list by air. We will advise you of the market potential, local tariff rates and as we already import from over 20 American and European principals we can advise on export documentation.

This offer is appearing once only so why not write today to:

Murray & Ogle Pty. Ltd.
255 Castlereagh Street,
Sydney, N.S.W. 2000.
Australia.

New products

character reading at 300 characters per second.

Electronic Engineering Co. of California, Electronic Products Div., 1441 E. Chestnut Ave., Santa Ana, Calif. 92701 [364]

Transport offers data rate

of 4,500 characters a second

The series 1700 magnetic tape transport provides the interfacing simplicity of an asynchronous incremental recorder at the data rate of a continuous recorder. In its minimal configuration of 800 characters per inch, 512-character records of asynchronous data may be applied at average data rates up to 4,500

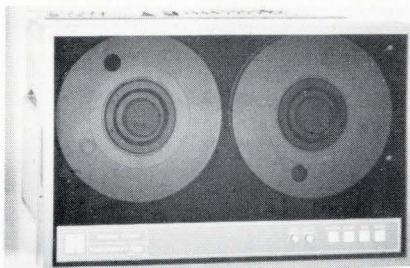

characters per second. Character separation may be as little as 4 microseconds. Increased record lengths of up to 2,048 characters are available as options, resulting in maximum average uninterrupted rates of up to 26,000 characters per second. Prices start at \$4,300.

Kennedy Co., 540 W. Woodbury Rd., Altadena, Calif. 91001 [365]

Remote terminals transmit

up to 50,000 bits a second

A line of remote computer terminals designated the COPE 1200 series, allows data to be transmitted in the range of 2,000–50,000 bits per second. The I model in the family has a 1-microsecond core memory with 4,096 12-bit words, field-upgradable in increments of 4,096 or 8,192 words to a maximum of 16,384 words. The II model has a similar memory that is field-upgradable in the same increments to a maximum of 65,536 12-bit words. Monthly rental of a terminal equipped with a

minimum 4,096-word memory, communications interface, card reader and line printer ranges upward from \$665.

University Computing Co., 1500 UCC Tower, P.O. Box 6288, Dallas, Texas 75222 [363]

Add-ons can replace PDP-11 or Nova 1200 memories

Two add-on memories, designated the PM-1100 and PM-1200, can replace or interchange with the PDP-11 memory MM11-E or MM11-F and the Nova 1200 memory 8103 respectively. The add-ons require no additional electronics, power, or mechanical support. The PM-1100 is equipped with a mounting block that holds two basic modules for a total capacity of 16,384 words. The PM-1200 can also be used for modular expansion and can increase memory capacity from 16,384 to 32,768 words without modification.

Plessey Memories Inc., Santa Ana, Calif. [366]

Modems can operate over private line or dial network

Two modems that provide communications over telephone lines between remote terminals and a central computer are designated the model 3872 and model 3875. The 3872 operates at 2,400 bits per second over either private communications lines or the public dial network; the 3875 transmits at 7,200 bits/s, primarily over private communications lines. Both help keep the system functioning by switching to the dial network during private-line failures, and by providing half-speed transmission over temporarily deteriorated lines. Monthly rental for the 3872 is from \$85 to \$100, depending on features selected, and for the 3875, it is \$240 to \$315. Purchase prices are \$2,975 to \$3,570 and from \$8,400 to \$11,375, respectively.

IBM Corp., Data Processing Div., 1133 Westchester Ave., White Plains, N.Y. 10604 [368]

Semiconductors

IC aimed at consumer jobs

2-watt audio amplifier for phonographs requires only 4 external connections

For the past two years, the major integrated circuit manufacturers have been saying that the consumer IC area will offer one of the largest growth potentials in the 1970s. Now, some products are starting to emerge, among them a 2-watt audio amplifier from National Semiconductor Corp.

The new LM 380 amplifier, aimed at the children's phonograph market, will sell for \$1.50 in quantities of 100. According to Albert Howard, manager of consumer linear ICs at National, most of the inexpensive phonograph motors have an additional motor winding that provides about 18 volts ac for use by an amplifier. "All you need is a single diode for the dc power supply, and you are in business—the LM 380 will operate well," he says. If there is a need to reduce the ripple level, a single 0.047-microfarad capacitor can be used. Power supply range is 8 to 22 v.

Howard says that, in its simplest form, all that's needed in the way of external components is a volume control, a 500 μ F series output capacitor and an 8-ohm speaker. If a tone control is desired, all that's required is the addition of the control and a 0.05 μ F capacitor.

"Most of the current amplifier designs are just op amps that need external components to turn them into useful audio amplifiers," Howard says. "What the people really want is an amplifier that has an input with respect to ground and an output with respect to ground, and that's what the LM 380 is." The amplifier can be operated with just four external connections: input, output, power supply, and ground.

The gain of the LM 380 is fixed at

50 (34 dB), and the input impedance is 150 kilohms, resistively terminated on the die. Input signal range is ± 0.5 v, and the full power bandwidth is dc to 65 kHz, with power 2 w. Total harmonic distortion is 0.1%. The output is short-circuit-proof, and the die has built-in thermal protection.

In previous audio amplifier designs, strange packages have been used to get the heat out of the IC package. National, on the other hand, is using a standard 14-pin dual in-line package, and pins 3, 4, 5, 10, 11, and 12 are the heat sink. Adequate heat sinking is provided when these pins are soldered to foil on a pc card; thermal derating is 50°C per watt when the pins are soldered to 6 square inches of 2-ounce foil.

If more than 2 w are needed, Howard says that two amplifiers can be "cross-connected and the speaker connected between the two output pins. This produces a gain of 100." For the same power supply voltage, this arrangement produces four times the output power of a single amplifier.

National Semiconductor Corp., 2900 Semiconductor Drive, Santa Clara, Calif. 95051 [411]

Silicon-on-sapphire offered in 2-inch-diameter wafers

To satisfy the high-speed requirements of new data processing equipment, some manufacturers are turning to silicon-on-sapphire, a material that yields high isolation and low capacitance, in turn providing improved speed and performance. And Inselek of Princeton, N.J., is now offering 2-inch-diameter SOS wafers. There's no reason why a 3-in. or larger wafer cannot be made, says the company.

Virtually all resistivities of SOS films are available. The company's standard wafer line includes two resistivities of p-type films and four resistivities of n-type films. Surface smoothness is 250 angstroms, and typical variation in carrier concentration is about 20%. The company

is offering the wafers on a resale basis to semiconductor houses that manufacture their own components. Prices range from \$59.80 for 1 to 10 down to \$33.10 for 500. The company expects prices of larger wafers to be competitive with bulk silicon-epitaxial layers by 1973.

Also being offered is a p-channel enhancement-mode transistor, the Quad SOS L01. This device provides total isolation and the elimination of capacitances associated with components fabricated in bulk silicon. The result is not only higher speeds but lower power dissipation in both discrete and monolithic devices. The transistors are designed for voltage matching and switching characteristics, with applications in linear rf amplifiers, tetrodes, and mixers. Price is \$19.50 each for 1 to 9, and \$10 for 100 to 999.

Inselek, University Park Plaza, 743 Alexander Rd., Princeton, N.J. 08540 [412]

High-voltage transistors built to drive displays

Designed specifically to drive gas-discharge and plasma displays, high-voltage silicon transistors are available as complementary npn and pnp discrete components in TO-5 cans or as complementary pairs in TO-78 cans. They are also available in chip form for hybrid circuit applications. Designated the DTN 200, DTP 200, and DTNP 200 series, the units can develop voltages as high as 225 v. Prices start at 65 cents each.

Dionics Inc., 65 Rushmore St., Westbury, N.Y. 11590 [417]

Reprogrammable ROM offers 50-nanosecond access time

A field-alterable read-only memory on a single printed circuit board offers capacities ranging from 256 bits to 26,000 bits or more per board. Access time is 50 ns. The pc card system comes with a storage array, input buffering, timing and control (synchronous or asynchronous), ad-

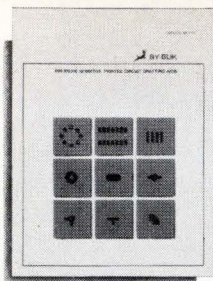

NEW

**Catalog of
pressure
sensitive
electronic
component drafting aids**

Time saving electronic component shapes, patterns and conductor line tapes are listed by the thousands in By-Buk's new P-50 catalog. This easy to use, cost-saver index of pressure sensitive printed circuit drafting aids is the source book of ideas for engineers, designers and draftsmen interested in faster, more accurate artwork layouts. Find new ways to reduce the tedium of repetitive artwork with individually die cut artwork patterns in opaque black, transparent red and transparent blue materials.



**FREE CATALOG
FREE SAMPLES**

Send today for a free copy of the new P-50 catalog and a selection of samples.



BY-BUK COMPANY

4326 W. Pico Blvd.
Los Angeles, Calif. 90019
(213) 937-3511

Circle 112 on reader service card

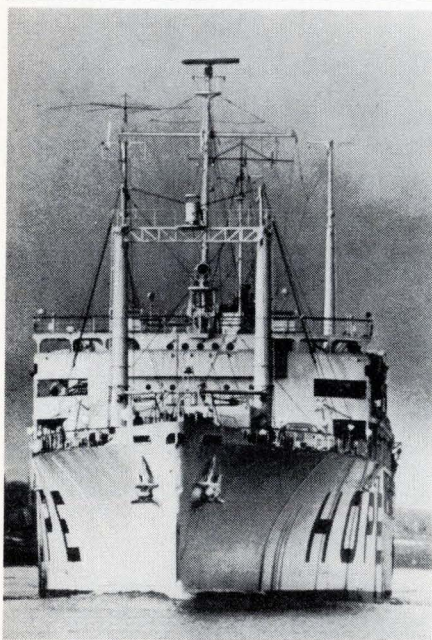

S.S. HOPE, M.D.

Doctor . . . teacher . . . friend to millions on four continents—this floating hospital is a symbol of America's concern for the world's disadvantaged. Keep HOPE sailing.



Dept. A, Washington, D.C. 20007

New products

dress decoding, output data registers, and a DTL and TTL compatible interface. Information is alterable in two ways: 100% of the information can be reprogrammed repeatedly for less than 0.1 cent per bit, or any discrete bit can be repeatedly changed from a 1 to a 0 and back again within one minute.

Integrated Memories Inc., 260 Fordham Rd.,
Wilmington, Mass. 01887 [414]

**Low-priced solid state
relays are optically coupled**

Two solid state relays for control applications are priced at \$6.50 each in 1,000-piece quantities. Designated the TIH501 and TIH502, they have triac outputs with optically coupled isolation between input and output, resulting in 1,500-volt isolation. The devices have zero-crossing detec-

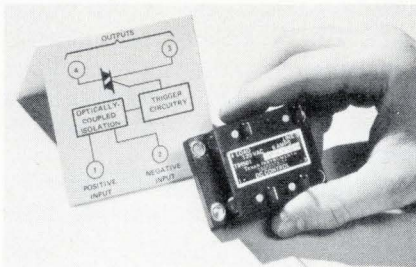

tion, preventing the output from turning on until voltage crosses zero, and not turning off until the current reaches zero. The relays are rated for 140 V ac and 8 amperes, with operation possible down to 15 V ac and 10 mA.

Texas Instruments Inc., Inquiry Answering Service, P.O. Box 5012, MS/308, Dallas, Texas 75222 [416]

**C/MOS logic family
is compatible with TTL**

A family of low-power C/MOS logic elements designated the MC14000AL and CL series allows equipment design processes to proceed smoothly, mixing and matching logic functions as needed. Uniform output drive current specifications permit direct interface with low-power TTL. Propagation delay is consistent for

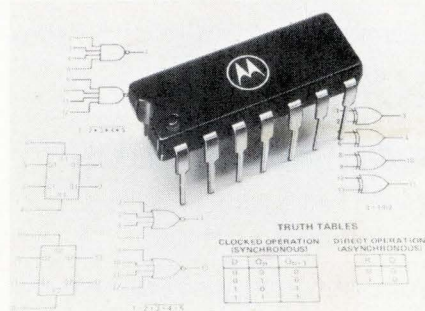

all gates, and temperature range is from -55°C to $+125^{\circ}\text{C}$. Seven logic devices are being offered. Prices in 100-lots range from \$1.18 to \$12.65 each.

Motorola Inc., Semiconductor Products Div.,
P.O. Box 20924, Phoenix, Ariz. 85036 [418]

**Optically coupled pair
isolates against 1,500V**

Two optical isolators contain a gallium arsenide infrared LED and a silicon npn phototransistor optically coupled in a 16-pin DIP. The devices maintain high electrical isolation between equipment or circuits while coupling ac and dc signals. The model Iso-Lit 12 has a minimum breakdown voltage of 1,000 V, and the Iso-Lit 16, 1,500 V. Typical current transfer ratios are 10% and 14% respectively, and the photo-transistor outputs will directly drive the inputs of standard 930 DTL and 7400 TTL circuits. Price is \$1.70 for the 12 in 100-lots and \$3.05 for the 16.

Litronix Inc., 10440 N. Tantau Ave., Cupertino, Calif. [413]

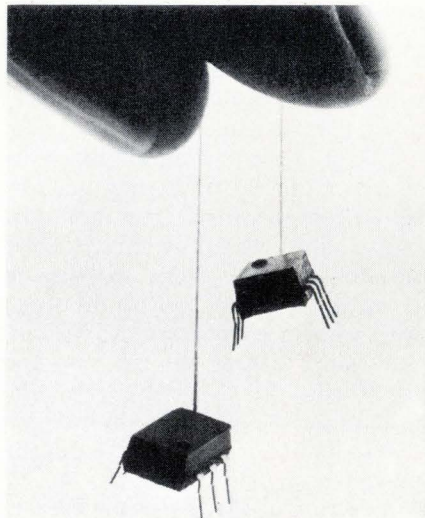

meeting ground



where
medicine and
electronics
come together

The 4th National Conference on Electronics in Medicine provides a major forum for the interchange of ideas and information between the men who make and the men who use electronic equipment for one overriding purpose—the betterment of worldwide health care.

Sponsored by McGraw-Hill's *Medical World News*, the focus of this year's conference will be on what is available and *practical* in the diagnostic, therapeutic and monitoring phases of medicine.

Neither physician nor engineer can afford to miss this 3-day dialogue. Both electronics and medicine are two of the fastest changing and growing professions in the world—and today's physician, nurse and hospital administrator must have every available input.

And engineers and manufacturers need the information exchange that comes from these invaluable conferences in order to develop the kind of sophisticated equipment necessary for modern health care. Only through knowledge of the medical profession's needs can industry develop and produce that equipment.

Speakers and panel members will include Howard Rusk, M.D., Director NYU Rehabilitation Center; Tom Bird, Manager, Monitoring Systems, General Electric; William Kerr, Director Medical Division, IBM; Merlin K. DuVal, M.D., Assistant Secretary for Health and Scientific Affairs; Dwight E. Harken, M.D., Clinical Professor of Surgery, Emeritus, Harvard Medical School; J. Willis Hurst, M.D., Professor and Chairman, Dept. of Medicine, Emory University School of Medicine, President American Heart Association; Thelma Schorr, R.N., Editor, American Journal of Nursing.

Date: March 27, 28, 29, 1972

Place: Chicago, Drake Hotel

Take advantage of the pre-registration price of \$165 (registration at Conference—\$200) by filling out the coupon and mailing today. The Drake Hotel has a number of rooms reserved—please make your room reservation directly with the Drake, and indicate that you will be attending the Conference.

Conference Highlights

- Applications of instrument and computer technology
- Hardware obsolescence and problems of repair, maintenance and cost
- Continuing government role in developing device legislation
- The trend toward minicomputers
- Emergency care: growing role for electronics
- Applications of space technology to medicine
- Multiphasic screening—demonstration session
- New Problems in Liability and Malpractice—what does the increased use of electronics portend?
- Man and machine—is dehumanization a problem?
- Problem-oriented Medical Record—getting ready for the computer
- Meet-the-experts (evening session)

Medical World News, 299 Park Avenue, New York, N.Y. 10017

Yes, I would like to be pre-registered at the 4th National Conference on Electronics in Medicine at the special advance rate of \$165. Please make checks payable to Donald Ruben, Conference Chairman.

Check enclosed

Please bill me

Name _____ Title _____

Company (Hospital) _____

Address _____

City _____ State _____ Zip _____



SEARCHLIGHT SECTIONBUSINESS OPPORTUNITIES
USED OR SURPLUS EQUIPMENT

John R. Sauer, Pres.

**HOW TO BECOME FINANCIALLY INDEPENDENT!**TMInterested in a prestige and profitable business of your own? Write for valuable new, 50-page **FREE** booklet, **NEW ROADS TO OPPORTUNITY AND WEALTH.**E.L.E.R. INTERNATIONAL, P.O. Box 1637
Englewood, Colorado 80110 (303) 770-1121

CIRCLE 951 ON READER SERVICE CARD

**One Story
83,000 Sq. Ft.
Air Conditioned**

Acreage . Truck . rail.

SOUTH CAROLINA

**BINSWANGER
Company**Div. of Binswanger/Herman Company
1420 Walnut St., Phila. 19102
215-735-0202
New York, N. Y. • Charlotte, N. C.

CIRCLE 952 ON READER SERVICE CARD



**Radio-Research
Instrument Co.**
3 Quincy Street, Norwalk,
Connecticut 06850
Tel: (203) 853-2600

CIRCLE 953 ON READER SERVICE CARD

POSITIONS VACANT**Multilingual Consultant, with experience** of microelectronic industry, available for development of overseas industries. Replies to P-5889, Electronics.**Dir. of Research and Development**—An excellent opportunity with expanding eastern manufacturer of Optical Fibers and Fiber Optic electronic devices, seeks individual with extensive experience in electronics, optics, and optical fibers. Position requires development of fiber optic applications as well as interface with sales organization on design and industrial application of optical fibers for OEM manufacturers. Send resume including salary requirements to: P-5886, Electronics.**New products/Materials****Circuit-board laminate** for hybrid circuits is an epoxy-glass substrate completely covered on one or both sides with a two-layer cladding: the layer against the substrate is resistive, and the top layer is conductive. Conventional masking and etching techniques produce resistors and conductive patterns.

The Mica Corp., 4031 Elenda St., Culver City, Calif. 90230 [476]

One-component gold epoxy solder, called the 412, is a flowable paste that is room-temperature-stable and cures as low as 250°F in 30 minutes. It is 100% solids and contains no solvents or dilutants. Price is \$60 for a ½-ounce evaluation kit.

Dynaloy Inc., 7 Great Meadow Lane, Hanover, N.J. 07936 [477]

High-purity chrome and nickel chromium alloys are designed for sputtering and vapor deposition in integrated circuits and thin film hybrid resistors. Iochrome is a 99.997% pure form of chromium and is used

as an adhesive layer or in the manufacture of chrome masks.

Materials Research Corp., Orangeburg, N.Y. 10962 [478]

Transparent photomask blank is for the fabrication of thin-film circuits. The hard surface plate, designated C grade, can be contacted 1,000 times or more and can be cleaned for re-use by most stripping solutions. Price for a 2½-in. plate is \$4.50.

Teller Industries Inc., 2323 Teller Rd., Newbury Park, Calif. 91320 [479]

Epoxy resin called the Eccoseal W19, may be used either as a casting resin or an impregnant. For the latter and in small castings, W19 is used directly with either Catalyst 9 or 11. In larger casting applications, Filler A21, a surface-treated inorganic powder, is first poured and vibrated into place around the component to be cast.

Emerson & Cuming Inc., Dielectric Materials Div., Canton, Mass. 02021 [480]

New literature**Display-memory units.** A 10-page illustrated brochure from Owens-Illinois Inc., P.O. Box 1035, Toledo, Ohio 43651, describes the company's line of Digivue display-memory units. Features discussed include inherent memory, selective write, rear projection, and hard-copy potential. Circle [421] on reader service card

systems. Descriptions of the J263 and J261 systems are included. [424]

Analog converter. A six-page data sheet describing the monoDAC-01 series, a six-bit digital-to-analog converter on one chip, is available from Precision Monolithics Inc., 1500 Space Park Dr., Santa Clara, Calif. 95050. [425]**Variable resistors.** Allen-Bradley Co., 1201 South Second St., Milwaukee, Wis. 53204, has issued an eight-page bulletin describing Type GD hot-molded variable resistors for rheostat or potentiometric applications. Operating and mechanical characteristics, dimensions and performance specs are detailed in text and charts. [423]**Pc boards.** The Institute of Printed Circuits, 1717 Howard St., Evanston, Ill. 60202, is making available the proceedings of a meeting on "An Analysis of the Additive Process." Included are the reports of five industry specialists. [426]**IC test systems.** A 30-page brochure published by Teradyne Inc., 183 Essex St., Boston, Mass. 02111, describes the applications of its computer-operated linear IC test**Equipment cleaning.** M.P. Odell Co., 26612 Center Ridge Rd. Cleveland, Ohio. A 12-page booklet, "The Whys and Hows of Cleaning Electronic Equipment," reviews the effects of dirt and air pollution on electronic equipment and describes cleaning methods and systems. [427]

PUERTO RICO NOW.

ELECTRICAL CIRCUITRY DEVICE MANUFACTURERS CAN INCREASE RETURN ON SALES BY 154%.

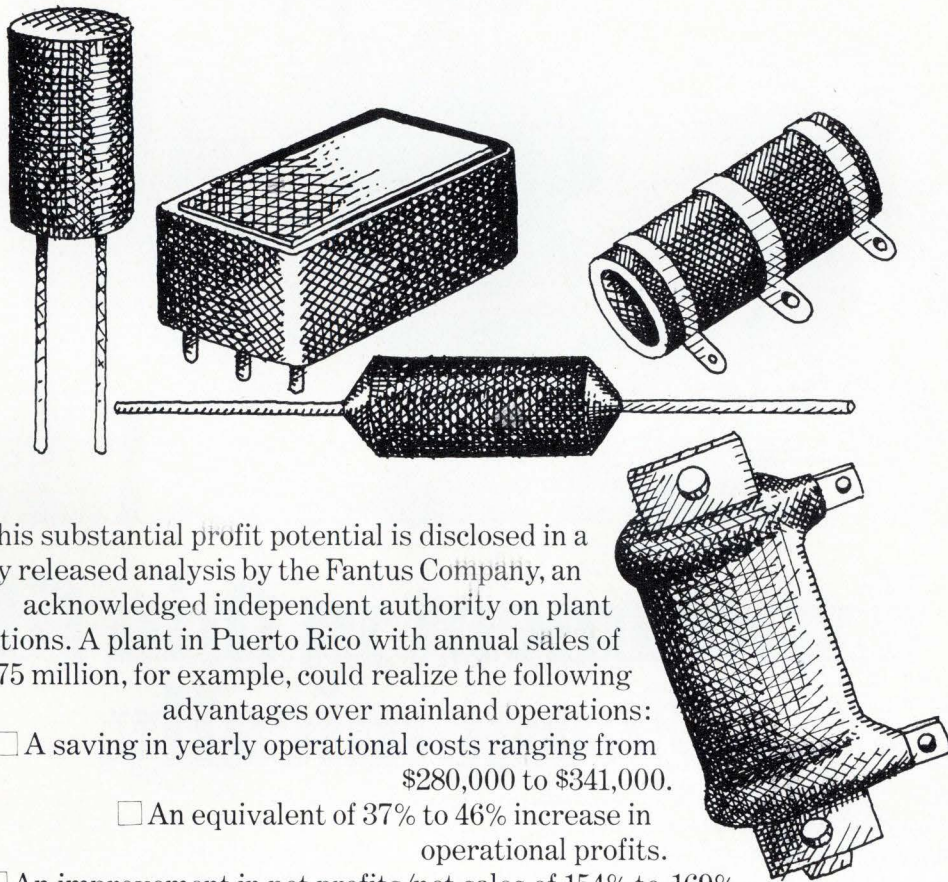

This substantial profit potential is disclosed in a newly released analysis by the Fantus Company, an acknowledged independent authority on plant locations. A plant in Puerto Rico with annual sales of \$8.75 million, for example, could realize the following advantages over mainland operations:

- A saving in yearly operational costs ranging from \$280,000 to \$341,000.
- An equivalent of 37% to 46% increase in operational profits.
- An improvement in net profits/net sales of 154% to 169% with full exemption from state, federal and local taxes.

A complete executive summary of this study is available to interested manufacturers by simply mailing a request to:

Commonwealth of Puerto Rico
Economic Development Administration (Dept. F-4)
666 Fifth Avenue, New York, N.Y. 10019



PUERTO RICO, U.S.A.

© 1971 Commonwealth of Puerto Rico



Experiment in thin film. Economically.

At last. A thoroughly practical, extremely compact reactor specifically built for thin film deposition in the laboratory or in production. Applied Materials' self-contained, radiant heated AMH-704 Mini Reactor™.

It occupies half the space you'd normally use for a deposition-system and even the budget fits in the lab. Priced at \$15,900 vs. the \$60 — \$70,000 you expect to pay for a production line model, this unit is an even match for the high technology specs and performance of a production line reactor.

Thin film technologies get put through their paces with incredible control and repeatability. Silicon epitaxy, refractory metals, dielectric films. All the way to and through Tungsten or Alumina. Remarkably hard. Remarkably easy with the AMH-704 Mini Reactor.

Because it is radiant heated, there is no RF Noise. That's important in a lab. Also because of radiant heating, you get fast heat-up and cool-down. And our Mini uses a thermocouple for precise temperature control. You can process four 2" wafers or one 3" wafer at a time. Range from 400° to 1200° C under full, automatic control.

If you're ready to push thin film technologies and your own capabilities around in a small way, call collect to Applied Materials Technology, Inc., 2999 San Ysidro Way, Santa Clara, California 95051. John Baker has a literature pack ready for the asking at (408) 738-0600.

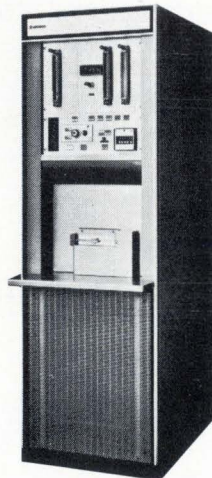

Applied Materials 

International Newsletter

January 17, 1972

Sescosem talking early 1972 delivery for 1,024-bit ROM

Several major European computer builders are dickering for early 1972 delivery of Sescosem's new 1,024-bit bipolar read-only memory which is now ready to be marketed. The circuit is pin-for-pin compatible with Intel's 301 ROM, but Sescosem, France's largest semiconductor maker, is emphasizing its European advantage of being on the spot for custom design and six-week delivery.

Andre Rodin of Sescosem says his company's version is being offered at less than a penny a bit in large quantities. "Tens of thousands of units are being negotiated now," he adds. Meanwhile, Sescosem is finishing up design work on a 4,096-bit circuit, due for production by year-end.

Small radar used to monitor patients' breathing

Miniature radars now mass produced for burglar alarms are likely to find a worthwhile new market outlet in medicine as a means of sounding an alarm if a patient stops breathing. London physiology researcher Colin Caro of Imperial College has found that a standard twin-antenna, Gunn-diode-powered radar made by Memco Electronics Ltd., with power and bandwidth reduced, produces a reliable doppler shift when mounted 1 foot or more over the chest of a breathing patient. Disappearance of the shift generates an alarm. Power density required at chest level is only 1 microwatt per square centimeter, which is considered safe by a factor of several thousands. The technique has a big advantage over existing alarm systems in that it does not touch the patient. A pilot batch of instruments is being built by S.E. Laboratories Ltd.

Sweden to push government role in electronics

Look for the Swedish government to expand its role as an owner or partner in electronics firms. While Minister of Industry Rune Johansson names no specific projects, he emphasizes that electronics has been earmarked as a prime area for government-supported expansion.

The state already is a partner of Saab-Scania and Standard Radio in Stansaab, a maker of air traffic control and medical systems, and owns Sonab, the fast-expanding consumer electronics firm. And, as part of an agreement with European Satellite Research Organization, Sweden has agreed to take over operation of the Esrange launching facilities north of the Arctic Circle, in July. At the same time, the Ministry of Industry is negotiating with Saab-Scania and L M Ericsson over Swedish participation in future ESRO applications projects.

Japan's color TV production may sag in 1972

Japan's leading TV manufacturers are producing two to three times as many color sets now as they did early in 1971. Despite this good start, though, industry estimates for total color TV production in 1972 range from about 5% below last year to only about equal to 1971's final figures. Two factors account for this lack of optimism. First, about 60% of all households now have color TV. Then, the commodity tax on transistor color sets, the only kind now produced in Japan, will rise from 10%, the tax levied during the last phase of a program to promote manufacture of transistorized color, to the normal 15% of production cost for 19-inch and smaller sets and to 20% for larger sizes.

The reason that production is soaring despite this static market is that manufacturers are starting the year with little to no inventory, a far

International Newsletter

cry from the start of 1971, when the industry had a large unsold inventory caused by a consumers' boycott that had dampened sales. Also manufacturers had not yet set new prices to eliminate a dual pricing system that had customers up in arms [*Electronics*, Feb. 1, 1971 *Electronics Newsletter*.]

Honeywell to buy computer peripherals in Yugoslavia

Watch for intensifying cooperation between Yugoslavia and computer equipment makers in the West. Honeywell Information Systems of Italy, working through its West German agent, Lalex GmbH, has signed an agreement with Elektronska Industrija of Nis under which that Yugoslav firm will produce high-speed printers for Honeywell computers. It's likely, Lalex says, that the deal will later provide for Yugoslav production of other Honeywell peripherals as well. The printers EI will manufacture are MB-3 models intended primarily for Honeywell G-100s.

Britain's avionics makers worry about next foreign deal

Fearful for their future, British avionics makers are teaming up to pressure the government into insisting on much greater priority for British avionics in any future collaborative aircraft projects with other countries. The companies maintain that in the Concorde and Jaguar projects with France, and now in the multirole combat aircraft (MRCA) project with Germany and Italy, the government has sacrificed British avionics interests in order to ensure that the airframe companies and engine-maker Rolls-Royce Ltd. get a good share of the original work.

They are saying that if this policy is not substantially reversed in the next such project—if one develops—so much British avionics know-how will have passed to Continental countries that Britain's technological lead will cease to exist. Because this know-how is helping to establish a European avionics industry far bigger than the market can support, British avionics men believe the government has been making them cut their own throats. Nobody knows how the government will respond, but the growing avionics content of modern airframes plus Rolls-Royce's troubles suggest the government may pay more attention to the avionics men than in the past.

Japanese offer LSI memory tester to Asian customers

Semiconductor memory users and manufacturers in Japan and Southeast Asia will soon be able to purchase a versatile but relatively inexpensive LSI tester designed specifically for checking memory arrays. Kyoto Ceramic Co. has received approval from the Ministry of International Trade and Industry to purchase the technology needed to build the tester from Computer Microtechnology Inc. Kyocera expects to be able to start sales this summer at a price in the order of \$58,000 or less.

Kyocera, which manufactures ceramic packages and substrates for the electronics industry, is trying to expand its range of products without competing with its customers—which rules out manufacture of semiconductor devices. About the middle of last year it entered into agreement with CMI to act as Japanese agent for CMI's memory devices. Now it will also manufacture and sell the tester, developed for in-house use by CMI, that has been modified to meet needs of Japanese users. The tester will make both parametric and dynamic tests of MOS, bipolar, and hybrid memories—including static and dynamic ROMs, RAMs, and shift registers—but is still a lot less costly than universal LSI testers.

Fuel injection system uses read-only memory

With injection the likely answer to air pollution regulations, Lucas develops an MOS-based control unit

One way that car makers might meet upcoming exhaust-emission laws is to switch from carburetors to fuel injection. Though it costs more, a good injection system more accurately matches the amount of gasoline pumped into the cylinders to the engine requirements. That means less wasted fuel and fewer partially burned pollutants.

In England, Joseph Lucas (Electrical) Ltd., Britain's largest maker of auto electrical equipment, has developed a prototype electronic controller for an injection system around an MOS digital memory. Last week project engineer Malcolm Williams described the system in Detroit.

Read-only memory. Lucas has got the system running in an otherwise standard 150 cubic inch, six-cylinder Triumph sedan. Williams says that the prototype system gives emission levels just short of the proposed 1975 U.S. Federal legislation. A production system would include developments that better the prototype performance, but Williams acknowledges that further exhaust cleaning techniques may have to be included to meet fully the proposed U.S. legislation.

The basic idea in the Lucas system is that each word in a read-only memory can represent a different quantity of fuel. By reading out the right word at the right time, the right quantity of fuel is injected into

the induction ports. To get the right word, the outputs from all the sensors that monitor the engines condition and the driver's commands are fed into the memory to select the word. The fuel is injected into the ports at constant pressure, triggered by the crankshaft angle, and varying quantities are obtained by varying the time the injector valve is open.

In fact, each word in the memory corresponds to an interval of time. The intervals are, of course, discrete steps in a scale, whereas what is wanted is a continuous smooth curve, so that a means of interpolating between steps is provided.

Inputs to the memory are taken from the angle of the throttle butterfly valve in the air intake, which indicates the driver's intention, and from the distributor, which indicate engine speed. It's also necessary to take account of air temperature and pressure and, for starting, engine temperature, but these parameters are constant enough to be fed into the system after the memory read-out. Both major inputs follow a similar path to the memory.

Interpolation. Briefly, each analog output is digitally converted and operates a four-bit up-and-down counter. The counter outputs feed the memory, which consists of seven parallel planes of 16-by-16 matrix crosspoints, some insulated to store a 0, others conducting through an MOS transistor to store a 1. A seven-bit word is obtained by reading out corresponding crosspoints simultaneously.

The throttle output selects one axis, the engine speed output the other axis. A digital-to-analog converter and a voltage-to-time con-

verter set the injector opening period. To select a period between exact word intervals, the words each side of the required point read out alternatively for periods proportional to their distance from the required point. The resulting signal is averaged and smoothed in the d-to-a converter.

The prototype controller is built from readily available TTL, MOS, and analog integrated circuits, mounted on three boards in a box 10.25 by 6.75 by 2.25 inches. In the Triumph, this is mounted in the trunk. Williams says a production system would be much more highly integrated, probably into three ICs plus peripherals.

Sweden

Heat-scanning microscope checks ICs under load

When AGA of Sweden developed realtime thermography—and introduced its system known as Thermovision in 1965—the first major industrial application was in checking for hot spots in high-tension lines and power switchyards.

Now, AGA has developed a Thermovision microscope—whose first major application is at the other end of the power scale: checking for "hot spots" in integrated circuits and other electronic components. The object being studied is placed under a microscope lens—enlarged up to 125 times—and its heat image is displayed on an oscilloscope screen. According to AGA, engineers can study dynamic changes in circuits as power is varied. First two

users of AGA's microscope are ASEA of Sweden, which is using it for non-destructive testing of thyristors, and Toshiba of Japan, which is believed to be using it for testing of ICs.

The thermovision microscope is essentially the same as the standard Thermovision camera, except that the usual infrared optics have been changed for a new IR microscope attachment. Three different lenses are offered today, with power being 15 \times , 50 \times , and 125 \times . The heat patterns in objects as small as 0.026 by 0.026 inch can be studied. This resolution compares with the 1.6-by-1.6-inch areas that can be studied in the standard camera. The minimum detectable temperature difference is 0.6°C, when the object temperature is 70°C and when using the 15 \times magnification lens. With the 125 \times



Heat image. AGA's heat-scanning microscope can display IC temperature patterns.

lens the minimum detectable temperature difference is 2.5°C.

The heat picture is presented almost flicker-free, at a repetition rate of almost 16 complete fields per second. The scanning line frequency is 1,600 lines per second. As in the standard Thermovision camera, a dual-isotherm function permits narrow temperature ranges to be selected for closer examination or determining specific temperature differences.

AGA feels that the major applications for the microscope will be in studies of hot spots in prototype ICs, to study bonding, in nondestructive

testing, checking thin film resistors, infrared emitters, and other discrete components, and in failure analysis. They feel there could be applications in microbiology, although no units have been sold yet for such purposes.

The microscope, complete with display unit, costs about \$25,000 in Sweden. Compared with about \$18,000 for the standard unit.

Japan

Planar Schottky diodes for quasi-millimeter-wave gear

Planar Schottky diodes fabricated on an insulating substrate of gallium arsenide show great promise as mixers in hybrid integrated circuits and other stripline applications at microwave and quasi-millimeter-wave frequencies. Devices making use of the semi-insulating properties of doped gallium arsenide, fabricated by the Mushashino Electrical Communication Laboratory of the Nippon Telegraph & Telephone Public Corp., are being life-tested for possible use in quasi-millimeter-wave repeaters [*Electronics*, July 6, 1970, p. 130].

The technique makes use of windows etched in silicon dioxide to provide the n⁺ GaAs connections to the semiconductor portion of the diode, ohmic contact to the n⁺ region, and a titanium rectifying junction in the n region. This configuration provides a diode with both leads on one surface, which facilitates circuit adjustment for diode matching. This placement opens the way to more convenient mounting methods, including flip-chips.

The life tests will ascertain if diodes fabricated by this technique can indeed operate without being affected by the ambients in their intended environments. If the method proves successful, it can be extended to many other units, including field-effect and logic devices.

Top and bottom. Schottky diodes for use at microwave frequencies are conventionally fabricated with a sandwich configuration and

mounted in a pill-shaped case with contacts at top and bottom. Both diode and package are suitable for waveguide circuits. In microwave IC and stripline circuits, the diodes are generally mounted by tabs attached to top and bottom contacts on the package, and circuit adjustment to match the diodes often becomes difficult.

Planar techniques of the type used in silicon transistors cannot be used directly in diodes for this frequency because the capacitance of the metalization over the passivating layer to the substrate would be excessive. It is possible, though, to use a property of doped GaAs to enable fabrication of planar diodes.

Impurities. GaAs doped with chromium becomes semi-insulating, with a resistivity of 10⁸ ohm-centimeters, which provides good isolation. Unfortunately, the impurity content of this layer is too high to permit forming p or n regions by local diffusion of dopants. This impurity problem is solved by selective epitaxial growth, through a window in a thin film overlying the substrate, of semiconducting GaAs to form the actual diode region.

Several refinements must be included in this process to give high-performance planar diodes. The usual thin film semiconductor materials are silicon dioxide and silicon nitride. Obviously, the silicon dioxide cannot be thermally grown, as in silicon transistors, but thermal decomposition of ethyl silicate is relatively simple. Unfortunately, during this process, the chromium near the surface of the gallium arsenide diffuses into the silicon dioxide, and the surface of the gallium arsenide becomes conducting. Degradation of the insulating properties of the GaAs layer is prevented by sputtering fused quartz—which is pure silicon dioxide—onto the substrate at a low temperature.

Window etching. The silicon dioxide film can be etched to produce windows of desired size and location by standard techniques. The etchants used for GaAs will not grow epitaxially on silicon dioxide. Thus, the film around the window serves as a mask for the processes in which

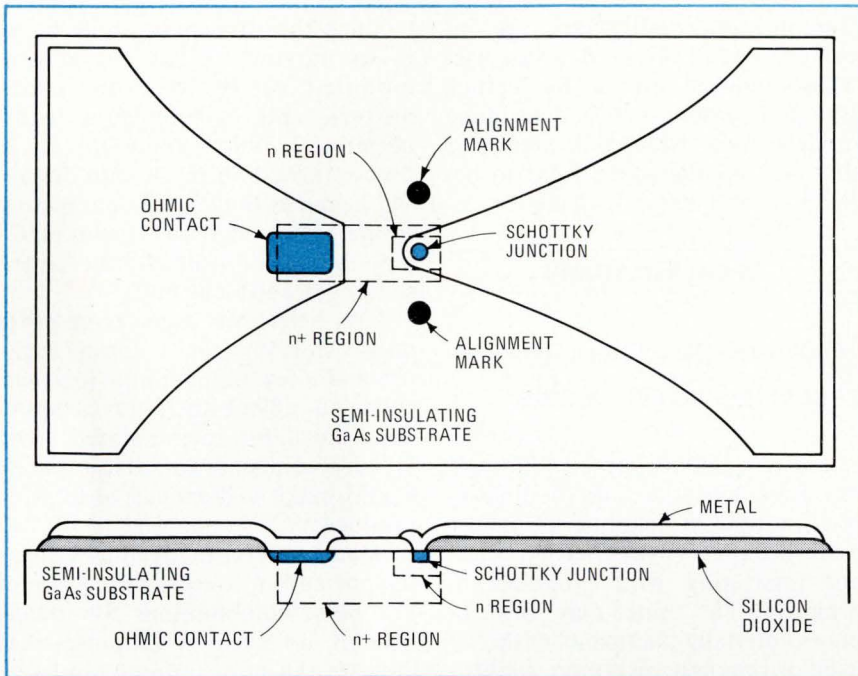

a moat is etched in the substrate and then filled in with epitaxially grown GaAs.

The crystal structure of GaAs has directional characteristics not found in silicon or germanium. Depending on the crystal surface used, the shape of the moat etched in the substrate may not conform to the shape of the window through which it is etched. The 1-0-0 plane gives the most satisfactory results because it allows rectangular moats with vertical sides to be etched, rather than the round or triangular moats produced when other planes are used.

Moats. A rectangular moat is the most convenient shape to fill by the selective epitaxial process. Ideally, the process is continued until the material reaches the same level as the silicon dioxide film. But since the epitaxial material may not be absolutely level, it is often grown until slightly higher than the film and then ground down level.

In fabrication of the diode, the process of etching a moat and filling it in by selective epitaxial growth of semiconducting doped GaAs is carried out twice. The first time, a rectangular region of n^+ GaAs is grown to connect to the semiconductor portion of the diode. The second time, a much smaller region of GaAs is grown in a moat at one end

of the n^+ region. Each time, a silicon dioxide film serves as the mask.

More contacts. Ohmic contact is made to the n^+ region through a window in the silicon dioxide by evaporating an alloy of gold, germanium, and nickel onto the chip at a temperature of about 150°C . Then the temperature of the wafer is raised to about 500°C to alloy the ohmic contact. After that, the unwanted coating—which doesn't stick very well—is removed mechanically.

Titanium to form the rectifying junction to the n region is sputtered onto the chip to make contact through a microscopic window only 5–10 micrometers in diameter. Titanium also firmly attaches bonding pads to the silicon dioxide film. The diode is completed by evaporating gold and then etching the metalization to form two bonding pads—one connected to the ohmic contact and one to the rectifying junction. This metalization system, similar to that used in beam leads, should form a seal over the diode, preventing degradation by contamination.

Nickel. In a variation of this process, a nickel rectifying junction can be electroplated onto the n region. This is followed by titanium and gold evaporations and etching. It is thought that the diodes with nickel rectifying contacts have higher relia-

bility than those with the titanium rectifying contact.

Diodes of this type have been operated experimentally in balanced mixer circuits using stripline on fused quartz substrate, with diodes attached face-down to the stripline by solder. The mixer has a conversion loss of 5.5 decibels and bandwidth of ± 500 megahertz throughout the entire 18–26-gigahertz band. This performance is comparable to results with waveguide circuits.

France

RTC jumps into miniradar market

So far, it's been the British who have made the most of tiny "industrial" radars. A half-dozen companies in the United Kingdom are selling burglar alarm systems built around Gunn-diode radars.

Now a French company is going into the miniradar market in a fairly big way. RTC La Radiotechnique-Compelec, an affiliate of Philips Gloeilampenfabrieken, put on the market last month the first units of a pilot batch of 5,000 radars small enough to fit into the palm of a hand. Like their British predecessors, many of the RTC radars will find their way into burglar alarms.

Variety. But Serge Guennou, the engineer in charge of the miniradar project, sees all sorts of other possible applications. One of the first will be in a system that sends animated displays into action when window shoppers approach. Another possibility is door openers. And RTC's radars quite likely will go into service soon in an anticollision system—for overhead cranes.

RTC has set an initial single-unit price of \$207 for the radar. For orders of 100 units, the price drops to \$111. For the money, the buyer gets a complete doppler radar that works off 12 volts dc. The range varies from a minimum of 50 feet on out to 165 or 200 feet. Operating frequency is 8,875 megahertz.

In order to keep the miniradar small and simple, RTC makes the



Tiny. Serge Guennou holds miniradar in left hand, pre-production prototype in right.

Gunn-diode/horn combination serve as both transmitter and receiver. The diode works in a tunable three-quarter-wave cavity and is powered through a 33-ohm load from a stabilized converter that boosts the supply to 15 V.

When there is nothing to reflect back transmitted power, then, there's an equilibrium set of voltage drops across the load and the diode-cavity combination. Any return wave upsets the voltage standing wave ratio in the cavity and as a result the voltage drop across the load changes. The change is detected by a monolithic differential amplifier, which drives a monostable multivibrator. It, in turn, switches a relay that has contacts rated at 30 watts.

Doppler shift. The output power from the Gunn diode is, of course, low—15 milliwatts continuous. However, there is a workable output when the VSWR is upset by a change in doppler frequency. When 6.5 feet away from the horn, an 8-by-8-inch metal plate reflects enough radiated power back to cause a 15-mV change in the drop across the 33-ohm load. Without the horn, the figure is 2 mV.

The shift in frequency is about 66 hertz per meter per second of "target" movement. To avoid false alarms that might be caused by parasitics from Europe's 50-Hz power lines, RTC has limited the passband in the amplifier to 45 Hz. This means the system can not handle targets moving faster than 3 or 3.5 miles an hour. This is no drawback for applications where

slow-moving pedestrians are involved, but it is too slow for uses where vehicles have to be spotted. For that reason, RTC is developing models with wideband amplifiers that will up the speed limit to between 95 and 190 miles per hour.

West Germany

Transmission system displays accurate time on TV sets

For a few dollars more, radio and television sets soon may be able to provide time indications—of atomic clock accuracy—every second without interfering with programs in progress. The time may be displayed digitally on a panel of the set itself or remotely on a more conventional-appearing clock.

The system, developed by Wolfgang Hilberg at the AEG-Telefunken Research Laboratories in Ulm, West Germany, soon will be ready for public exhibition. First proposed by Hilberg in 1967, it has triggered similar proposals elsewhere. In the United States, the National Bureau of Standards in 1970 suggested a system that would at the push of a button replace the television program in progress with a display of the correct time.

Pulse train. AEG-Telefunken's approach, which it calls the "time distribution system," does not interfere with television signals because the time signals are transmitted simultaneously with them on a band only 30 hertz wide. Every second, a time signal consisting of a train of 25 binary pulse combinations is transmitted from a source of high accuracy, such as an atomic clock at a standards bureau.

The clock-receiver, called the Telechron, can be operated either by battery or ac power. AEG-Telefunken suggests that it could therefore be used in mobile applications, such as cars or boats, as well as in the home. The company's experimental version is mounted in a radio receiver. Cold-cathode tubes, liquid crystal elements, or other display devices are suitable readouts.

Since the time pulse-train signal is so narrow, it can be accommodated easily by radio transmitters, and in television transmitters it would simply slip, as a time-information pulse, into the no-signal gap at the end of each picture frame. That method would eliminate the need for filters either at the sending or receiving end.

The Telechron receiver requires only a shift register, a storage register, and a few other simple logic circuits—all off-the-shelf TTL components available in integrated form. Hilberg points out that its simplicity would make it inexpensive to mass produce.

Square waves. Each time-indicating pulse train consists of a group of five pulse combinations for identification, followed by 20 pulses that indicate the hour, minute, and second. Each 1 or 0 is represented by a positive or negative square-wave pulse of 20-millisecond duration, and each train is separated by a 20-ms buffer.

After polarity inversion of negative pulses in the Telechron's receiver circuitry, the signals are applied to the shift register. When this register contains all 25 pulses, the 20 time-information signals are transferred in parallel into the storage register.

This transfer is timed so that it occurs during the interval between two clock pulses derived from the incoming train. When the transfer into the storage register has been completed, the clock pulse following the interval initiates another shifting process.

Steady state. During the time that the shift register is serially loaded, the content of the storage register remains unaltered. Because this register is directly connected through decoding-driver circuits to the indicating devices, the viewer sees a steady time display, which lasts 1 second.

Since the time is sent as a series of digital pulses, the Telechron is virtually immune to temporary interference. Should the time signals be garbled, the next train of interference-free pulses would again produce the correct display.

Distributors

Alabama: Compar, Huntsville (205) 539-8476
Arizona: Hamilton, Phoenix (602) 269-1391
 Compar, Scottsdale (602) 947-4336
California: Hamilton, Mountain View (415) 961-7000
 Culver City (213) 570-7171
 San Diego (714) 279-2421
 Compar, Burlingame (415) 347-5411
 Burbank (213) 843-1772
Colorado: Intermark Electronics, Denver (303) 936-8284
 Compar, Littleton (303) 799-5915
Connecticut: Compar, Hamden (203) 288-9276
Florida: Hamilton, Hollywood (305) 925-5401
Illinois: Hamilton, Schiller Park (Chicago) (312) 678-6310
 Compar, Des Plaines (312) 824-0104
Kansas: Hamilton, Prairie Village (Kansas City) (913) 363-3250
Maryland: Hamilton, Hanover (Baltimore) (301) 796-5000
 Micro-comp, Inc., Towson (301) 823-3603
 Compar, Baltimore (301) 484-5400
Massachusetts: Electrical Supply, Cambridge (617) 491-3300
 Hamilton, Burlington (617) 272-3061
 Compar, Newton Highlands (617) 969-7140
Michigan: Hamilton, Detroit (313) 538-1000
Minnesota: Hamilton, Minneapolis (612) 920-5866
 Compar, Minneapolis (612) 922-7011
Missouri: Hamilton, Hazelwood, St. Louis (314) 731-1144
 Compar, St. Louis (314) 567-3399
New Jersey: Hamilton, Cherry Hill (609) 662-9337
 Cedar Grove (201) 239-0800
 Compar, Clifton (201) 546-3660
 Haddonfield (609) 429-1526
New Mexico: Compar, Albuquerque (505) 242-3633
New York: Semiconductor Concepts, Inc., Hauppauge (516) 273-1234
 Hamilton, Syracuse (315) 437-2642
 Westbury, L. I. (516) 333-5812
 Compar, Albany (518) 489-7408
North Carolina: Compar, Winston-Salem (919) 723-1002
Ohio: Compar, Rocky River (Cleveland) (216) 333-4120
Texas: Compar, Dallas (214) 638-2850
 Hamilton, Dallas (214) 638-2850
 Houston (713) 524-6641
Washington: Hamilton, Seattle (206) 624-5930
 Compar, Kirkland (206) 822-4191
Canada: Preico Electronics, Montreal (514) 389-8051
 Electro Sonic Ind. Sales, Toronto (416) 924-9301
 Hamilton, Montreal (514) 381-9127
 Toronto (416) 789-1338

Representatives

Arizona: Erskine Associates, Scottsdale (602) 263-7654
California: Bertrand-Zoolalian, Downey (213) 927-4406
 Celtec, Inc., San Diego (714) 279-7961
 Trident Assoc., Mountain View (408) 967-7031
Colorado: R. G. Enterprises, Denver (303) 744-2464
Florida: W. M. & M. Assoc., Clearwater (813) 446-0075
 Melbourne (305) 727-7474
Illinois: Compar, Des Plaines (312) 824-0104
Massachusetts: Contact Sales, Inc., Lexington (617) 861-1550
Michigan: Greiver Assoc., Grosse Pointe Park (313) 499-0188
Minnesota: Comstrand, Inc., Minneapolis (612) 560-5300
Missouri: Compar, St. Louis (314) 567-3399
New Jersey: P.A.L. Components, Fort Lee (201) 871-4020
 Thomas Associates, Haddonfield (609) 854-3011
New Mexico: Electronic Marketing, Albuquerque (505) 265-7837
New York: P.A.L. Components, Greenvale (516) 484-4900
 Compar, Albany (518) 489-7408
 Cicero (315) 471-3356
 Fairport (716) 271-2230
 Endwell (607) 723-8743
Ohio: Compar, Fairview Park (216) 333-4120
 Compar, Dayton (513) 890-9260
Texas: Carter Associates, Garland (214) 276-7151
Washington: Compar, Kirkland (206) 822-4191
Canada: Cantronics, Montreal (514) 733-0749
 Ontario (416) 636-8311

International Representatives & Distributors

Japan: Electro Marketing Corp., Tokyo 359-4521
Germany: Omni Ray GmbH, Munich (0811) 513-2059
 Omni Ray GmbH, Brevell (02153) 3261
Holland: Klaasing Electronics, Amsterdam 928444 or 928445
Sweden: Stenhardt Komponentbolag, Bromma 08/37-29-45
Switzerland: Dimes AG, Zurich (051) 626140
Australia: Auriema Pty. Ltd., Sydney (02) 296-144

BLESS YOU MONSANTO

We're not in the business of throwing bouquets to the competition. We are in the business of making popular LED products. Pin for pin, package for package we add the best of the best into our own bright line. Modestly speaking, we build them a little brighter, but they don't cost any more. So we thank Monsanto for building some very popular LEDs. But we'd like to show you wonderful LED users a great second source line. Send for our free opto-guide.

Bright, 7 segment DIP display 0.27"
 Tag-along-overflow +1
 End-to-end stackable 0.125 display
 64 ASCII Character Display
 in one little ol' 14 pin DIP

Solid state lamp,
 panel mount—red diffused LED

Solid state lamp,
 panel mount—red clear LED

Solid state lamp,
 panel mount—white diffused LED

Solid state lamp,
 panel mount—clear LED

Point source in TO-18 LED

Solid state lamp
 in 10 inch coaxial header

Big, big radiating area LED in TO-18
 Molded plastic, axial leads LED

Infrared LED, TO-46 package
 Infrared LED axial lead

Opto-isolator,
 20% min. current transfer ratio

Opto-isolator,
 6% min. current transfer ratio

**Our "Skinny DIP" package has leads on .100" centers for easy mounting. For calculators, we have 3 and 4 digits for end-stackable DIP packages.*

**The
Bright
Guys**

**The
Other
Guys**

DL-10
 DL-101
 DL-30*
 DL-57

MAN-1
 MAN-1001
 MAN-3A
 MAN-2

RL-2
 RL-2-02

MV5023
 & MV5024

RL-2-02

MV5022

RL-2-03

MV5021

RL-2-04

MV5020

RL-4-05

MV10B

RL-5

MV10A

RL-7

MV10C

RL-50

MV50

IRL-40

ME4

IRL-60

ME60

IL-1

MCT-2

IL-16

MCT-26

**The
bright guys
litronix**

Litronix, Inc. • 19000 Homestead Road • Cupertino, California 95014 • (408) 257-7910 • TWX: 910-338-0022

Electronics advertisers

January 17, 1972

Advertising Sales Staff

Pierre J. Braudé [212] 971-3485
Advertising Sales Manager

Atlanta, Ga. 30309: Joseph Lane
1375 Peachtree St., N.E.
[404] 892-2868

Boston, Mass. 02116: James R. Pierce
607 Boylston St. [617] 262-1160

Chicago, Ill. 60611: Robert W. Bartlett
Kenneth E. Nicklas, 645 North Michigan
Avenue, [312] MO 4-5800

Cleveland, Ohio 44113: William J. Boyle
[716] 586-5040

Dallas, Texas 75201: Richard P. Poole
1340 Republic National Bank Building
[214] RI 7-9721

Denver, Colo. 80202: Harry B. Doyle, Jr.
Tower Bldg., 1700 Broadway
[303] 266-3863

Detroit, Michigan 48226: Robert W. Bartlett
2600 Penobscot Building
[313] 962-1793

Houston, Texas 77002: Richard P. Poole
2270 Humbre Bldg. [713] CA 4-8381

Los Angeles, Calif. 90017: Robert J. Rielly
Bradley K. Jones, 1125 W. 6th St.,
[213] HU 2-5450

Minneapolis, Minn. 55402: Kenneth E. Nicklas
1104 Northstar Center [612] 332-7425

New York, N.Y. 10036
330 W. 42nd St.
Warren H. Gardner [212] 971-3617
Michael J. Stoller [212] 971-3616

Philadelphia, Pa. 19103: Warren H. Gardner
6 Penn Center Plaza,
[215] 971-3617

Pittsburgh, Pa. 15222: Warren H. Gardner
4 Gateway Center, [212] 971-3617

Rochester, N.Y. 14534: William J. Boyle
9 Greylock Ridge, Pittsford, N.Y.
[716] 586-5040

St. Louis, Mo. 63105: Kenneth E. Nicklas
The Clayton Tower, 7751 Carondelet Ave.
[314] PA 5-7285

San Francisco, Calif. 94111: Don Farris
Robert J. Rielly, 425 Battery Street,
[415] 362-4600

Paris: Alain Offergeld
17 Rue-Georges Bizet, 75 Paris 16, France
Tel: 720-73-01

Geneva: Alain Offergeld
1 rue du Temple, Geneva, Switzerland
Tel: 32-35-63

United Kingdom: Keith Mantle
Tel: 01-493-1451, 34 Dover Street, London W1

Milan: Robert Saidel, Roberto Laureri
1 via Baracchini Phone 86-90-656

Brussels: Alain Offergeld
22 Chaussee de Wavre
Brussels 1040, Belgium
Tel: 13-65-03

Stockholm: Brian Bowes
Office 17, Kontor-Center AB, Hagagarten 29,
113 47 Stockholm. Tel: 24 72 00

Frankfurt/Main: Fritz Krusebecker
Liebigstrasse 27c
Phone 72 01 81

Tokyo: Masaru Wakeshima, McGraw-Hill
Publications Overseas Corporation,
Kasumigaseki Building 2-5, 3-chome,
Kasumigaseki, Chiyoda-Ku, Tokyo, Japan
[581] 9811

Osaka: Ryji Kobayashi, McGraw-Hill
Publications Overseas Corporation, Kondo
Bldg., 163, Umegae-cho Kita-ku [362] 8771

Australasia: Warren E. Ball, IPO Box 5106,
Tokyo, Japan

Business Department

Stephen R. Weiss, Manager
[212] 971-2044

Thomas M. Egan,
Production Manager [212] 971-3140

Carol Gallagher
Assistant Production Manager [212] 971-2045

Dorothy Carter, Contracts and Billings
[212] 971-2908

Frances Vallone, Reader Service Manager
[212] 971-6057

Electronics Buyers' Guide

George F. Werner, Associate Publisher
[212] 971-3139

Regina Hera, Directory Manager
[212] 971-2544

Abbott Transistor Labs., Inc. Technical Adv. Agency	6	# Philips GAD	17E-18E
Alco Electronic Products, Inc. Marketronics Advertising	D-3	# Philips N. V. Pit/T & M Division Marsteller International S.A.	24
Allen-Bradley Company Hoffman-York, Inc.	52	Powertec, Inc. Warren C. Wilson & Associates	9
Amphenol Connector Division, Bunker Ramo Corporation Marsteller, Inc.	45	Raytheon Company, Industrial Components Operation Provandie Eastwood & Lombardi, Inc.	96-97
Applied Materials Hall Butler Blatherwick, Inc.	116	RCA Electronic Components Al Paul Letton Company	86
Babcock Control Products, Babcock Electronics Corp. Jansen Associates, Inc.	40	# RCL Electronics, Inc. Morvay Advertising Agency	14
Bourns, Inc. Marlborough Assoc., Inc.	35	# Rohde & Schwarz	3E
Brand-Rex Creamer, Trowbridge, Case & Basford, Inc.	2nd cover	Scanbe Manufacturing Corp. Warren C. Wilson & Associates	42
By-Buk Company, Sub. of Webtek Corp. J. R. Bloome Company	112	# Schneider R.T. Noirclerc Publicite	15E
# Cherry Electrical Products Corp. Kolb/Tookey and Assoc., Inc.	39	# S. E. Laboratories, Ltd. Graphic Publicity, Ltd.	12E
# Cialrex Corporation Michel-Cather, Inc.	4th cover	Signetics Corp., Sub. of Corning Glass Works Hall Butler Blatherwick, Inc.	20-21
Colorado, State of Commerce and Development Division Frye-Sills, Inc.	94	Sollitron Devices, Inc. Sol Advertising Agency	37
Commonwealth of Puerto Rico Young & Rubicam, Inc.	115	Sollitron Devices, Inc., Transistor Division Haselmire Pearson Advertising, Inc.	71
Data Precision Allied Advertising Agency, Inc.	102	Spectrol Electronics Corp. J M R, Inc.	17
Delta Products, Inc. The William Loughran Company	93	SRC Division/Moxon, Inc. Ron Jenner & Company	21
Digital Equipment Corporation Kalb & Schneider, Inc.	10-11	Standard Microsystems Regis McKenna, Inc.	12-13
DuPont de Nemours & Company, Freon Division N. W. Ayer & Son, Inc.	23	State of Minnesota-Dept. of Economic Development-Industrial Development Chuck Ruhr Associates Advertising, Inc.	108
Electronics	50-51	Systron Instruments, Inc. Moody & Harrison, Inc.	D-3
GAF Corporation Michel-Cather, Inc.	89	# Systron Donner Concord Instruments Bonfield Associates	15
General Automation, Inc. Jordan Advertising & Marketing Services, Inc.	95	T-Bar, Incorporated The Robert A. Paul Advertising Agency, Inc.	8
# General Electric Company - Lamp Glass Dept. Dix & Eaton, Inc.	7	Tecnico Electronics Boxall, Clayton & Associates Pty. Ltd. Advertising	110
General Radio Co. GRAD Associates	41	# Tektronix, Inc. Dawson, Inc.	33
Gould, Inc./Instrument Systems Div. Carr Liggett Adv., Inc.	27	# Teledyne Relays S. Michelson Advertising	6E
# Heath/Schlumberger Scientific Instruments Advance Advertising Services	78	Teradyne Components Quinn & Johnson, Inc.	40
Hermes Electronics, Ltd. Public & Industrial Relations Limited	100	Thomas & Betts Company McCarthy, Scelba, DeBiasi Advertising Agency, Inc.	16
# Hewlett Packard Tallant Yates Advertising, Inc.	18-19	Thomson CSF Bazaine Publicite	105
# Hewlett Packard Tallant Yates Advertising, Inc.	46-47	Triangle Electronics Mfg. Co., Inc. Daniel Heilman and Associates, Inc.	22
Howard W. Sams & Co. Aitkin-Kynett Co., Inc.	104	United Systems Corp. Advertising & Merchandising, Inc.	D-3
Ingersoll-Rand Beaumont, Heller & Sperling, Inc.	48-49	Vector Electronic Co., Inc. Buck Advertising	108
International Electronics Research Corporation Van Der Boom, McCarron, Inc., Advertising	85	Wang Laboratories, Inc. WLI Associates Advertising	106
# Kepeco, Incorporated Weiss Advertising	5	Wavetek Chapman Michetti Advertising	98
# Lambda Electronics Corporation Michel-Cather, Inc.	3rd cover		
Litronix, Inc. Regis McKenna, Inc.	D-1		
Materials Analysis Co.	38		
Medical World News Friedrich Fearon & Strohmeier	113		
The Mica Corporation Robert A. White Advertising	91		
3M Electro Products Division Batten, Barton, Durstine & Osborn, Inc.	24		
Mostek Corporation Continental Communications, Inc.	28		
Nortec Electronics Corporation Paul Pease Advertising	1		
North Atlantic Industries, Inc. Helme Associates, Inc.	2		
# Philips Gad Elcoma Tag-Intermarco delaMar	4E-5E, 11E		

Classified & Employment Advertising

F. J. Eberle, Manager 212-971-2557

EQUIPMENT (Used or Surplus New) For Sale
Binswanger114
Radio Research114

For more information on complete product line see advertisement in the latest Electronics Buyer's Guide
Advertisers in Electronics International