

SIGNALLING NETWORK STRUCTURE

CONTENTS

Contents	i
List of Figures	ii
List of Tables	iii
1. INTRODUCTION	1
2. NETWORK COMPONENTS	1
2.1 Signalling Links	1
2.2 Signalling Points	1
3. STRUCTURAL INDEPENDENCE OF INTERNATIONAL AND NATIONAL SIGNALLING NETWORKS	2
4. CONSIDERATIONS COMMON TO BOTH INTERNATIONAL AND NATIONAL SIGNALLING NETWORKS	2
4.1 Availability of the Network	2
4.2 Message Transfer Delay	3
4.3 Message Sequence Control	3
4.4 Number of Signalling Links Used in Load-Sharing	3
4.5 Satellite Working	4
5. INTERNATIONAL SIGNALLING NETWORK	4
6. SIGNALLING NETWORK FOR CROSS-BORDER TRAFFIC	4
6A. SIGNALLING NETWORK FOR INTER-NETWORK TRAFFIC	4
6A.1 General	4
6A.2 Integrated Numbering of National Signalling Networks	4
6A.3 Interworking of National Signalling Networks	4
6A.4 Inter-Network Signalling Network Structure	4
6A.5 Routing in the absence of Failures	5
6A.6 Routing Under Failure	5
7. NATIONAL SIGNALLING NETWORKS	6
7.1 General	6
7.2 Network Structure	6
7.3 Routing	9
7.4 Address Structure	21

SIGNALLING NETWORK STRUCTURE

LIST OF FIGURES

Figure 1/Q.705	- International and national signalling networks	3
Figure 1A1/Q.705	- Inter-network interconnection of Network 1 and Network 2	5
Figure 1A2/Q.705	- STP pair from Network 1 interconnecting with an STP pair from Network 2 - (consistent with Red Book Figures A3-1/Q.705 and A3-2/Q.705)	5
Figure 1A3/Q.705	- Mesh structure (Red Book Figure A2-1/Q.705)	6
Figure 1A4/Q.705	- Two level STP hierarchy (Red Book Figure A1-2/Q.705)	7
Figure 1A5/Q.705	- A-link access (Red Book Figure A1-4/Q.705)	8
Figure 1A6/Q.705	- E-link access (Red Book Figure A1-5/Q.705)	9
Figure 1A7/Q.705	- F-links (Red Book Figure A1-6/Q.705)	9
Figure 1A8/Q.705	- SLS rotation for load-sharing (Red Book Figure A1-7/Q.705)	10
Figure 1A9/Q.705	- Model to illustrate alternate link sets (Red Book Figure A1-8/Q.705)	12
Figure 1A10/Q.705	- Failure of link set AF, F-link (Red Book Figure A1-9/Q.705)	14
Figure 1A11/Q.705	- Failure of E-link set AE (Red Book Figure A1-10/Q.705)	14
Figure 1A12/Q.705	- Failure of E-links set AE and AD (Red Book Figure A1-11/Q.705)	15
Figure 1A13/Q.705	- Failure of link set AB (A-link) (Red Book Figure A2-5/Q.705)	15
Figure 1A14/Q.705	- Failure of link sets DF and EF (Red Book Figure A2-11/Q.705)	16
Figure 1A15/Q.705	- Failure of link set BD (Red Book Figure A2-6/Q.705)	16
Figure 1A16/Q.705	- Failure of link set BC, C-links (Red Book Figure A2-7/Q.705)	17
Figure 1A17/Q.705	- Failure of link sets DE and DF (Red Book Figure A2-8/Q.705)	17
Figure 1A18/Q.705	- Failure of link sets BD and BE (Red Book Figure A2-9/Q.705)	18
Figure 1A19/Q.705	- Failure of link sets DF and DB (Red Book Figure A2-10/Q.705)	18
Figure 1A20/Q.705	- Failure of STP D (Red Book Figure A2-12/Q.705)	19
Figure 1A21/Q.705	- Failure of signalling point F (Red Book Figure A2-13/Q.705)	20
Figure 1A22/Q.705	- Failure of signalling transfer points B and D (Red Book Figure A2-14/Q.705)	20
Figure 1A23/Q.705	- Failure of signalling transfer points D and E (Red Book Figure A2-15/Q.705)	21
Figure 1A24/Q.705	- Address structure	21
Figure 1A25/Q.705	- Model to illustrate addressing of signalling points	22

SIGNALLING NETWORK STRUCTURE

LIST OF TABLES

TABLE 0A1/Q.705 - Alternate link sets (combination of Red Book Tables A1-1/Q.705 and A2-1/Q.705)	13
TABLE 0A2/Q.705 - Addressing of signalling points	23

SIGNALLING NETWORK STRUCTURE

1. INTRODUCTION

This Recommendation describes aspects that are pertinent to, and should be considered in, the design of international signalling networks. Some or all of these aspects may also be relevant to the design of national networks. Some aspects are dealt with for both international and national networks (e.g., availability), whereas others are discussed only in the context of the international network (e.g., number of "Signalling Transfer Points" in a signalling relation). The United States national networks are described in Section 7. Section 6A describes the interconnection of networks. *

The national and international networks are considered to be structurally independent and, although a particular "signalling point" may belong to both networks, signalling points are allocated "signalling point codes" according to the rules of each network.

The signalling network procedures are provided in order to effectively operate a signalling network having different degrees of complexity. They provide for reliable message transfer across the network, and for reconfiguration of the network in the case of failures.

The most elementary signalling network consists of "originating and destination signalling points" connected by a single "signalling link." To meet availability requirements, this may be supplemented by additional links in parallel that may share the signalling load between them. If, for all signalling relations, the originating and destination signalling points are directly connected in this way in a network, the network then operates in the "associated mode."

For technical or economic reasons, a simple associated network may not be suitable and a "quasi-associated network" may be implemented in which the information between originating and destination signalling points may be transferred via a number of Signalling Transfer Points. Such a network may be represented by a "mesh network" such as that described in Section 7, as other networks are either a subset of the mesh network or are structured using this network or its subsets as components. *

2. NETWORK COMPONENTS

2.1 Signalling Links

Signalling links are basic components in a signalling network connecting signalling points. The signalling links encompass the level 2 functions that provide for message error control (detection and subsequent correction). In addition, correct message sequence maintenance is provided (see Recommendation Q.703).

2.2 Signalling Points

Signalling links connect signalling points at which signalling network functions, such as message routing, are provided at level 3, and at which the user functions may be provided if it is also an origin or destination point (see Recommendation Q.704, Section 2.4).

A signalling point that transfers messages from one signalling link to another at level 3 serves as a Signalling Transfer Point (STP). *

The signalling links, Signalling Transfer Points, and signalling (origin or destination) points may be combined in many different ways to form a "signalling network."

An asterisk '*' indicates a change from the CCITT Red Book, Vol. VI, that is specific to U.S. Networks

A bar '|' indicates a change from Issue 1 of Bell Communications Research Specification of Signalling System Number 7, Vol. 1 and 2.

3. *STRUCTURAL INDEPENDENCE OF INTERNATIONAL AND NATIONAL SIGNALLING NETWORKS*

The worldwide signalling network is structured into two functionally independent levels: international and national, as illustrated in Figure 1/Q.705. This structure makes possible a clear division of responsibility for signalling network management, and allows the international and national network signalling point numbering plans to be independent of one another.

A Signalling Point (SP), including a Signalling Transfer Point (STP), may be assigned to one of three categories.

- National signalling point (Signalling Transfer Point) which belongs only to the national signalling network (e.g., NSP₁) and is identified by a signalling point code (OPC or DPC) according to the national signalling points numbering plan.
- International signalling point (Signalling Transfer Point), which belongs only to the international signalling network (e.g., ISP₃), and is identified by a signalling point code (OPC or DPC) according to the international signalling points numbering plan.
- Node: that functions both as an international signalling point (Signalling Transfer Point) and a national signalling point (Signalling Transfer Point) and, therefore, belongs to both the international signalling network and a national signalling network; and is accordingly identified by a specific signalling point code (OPC or DPC) in each of the signalling networks.

If a discrimination between international and national signalling point codes is necessary at a signalling point, the national indicator is used (see Recommendation Q.704, Section 13.2.2).

4. *CONSIDERATIONS COMMON TO BOTH INTERNATIONAL AND NATIONAL SIGNALLING NETWORKS*

4.1 *Availability of the Network*

The signalling network structure must be selected to meet the most stringent availability requirements of any user served by a specific network. The availability of the individual network components (signalling links, signalling points and Signalling Transfer Points) must be considered in determining the network structure.

SIGNALLING NETWORK STRUCTURE

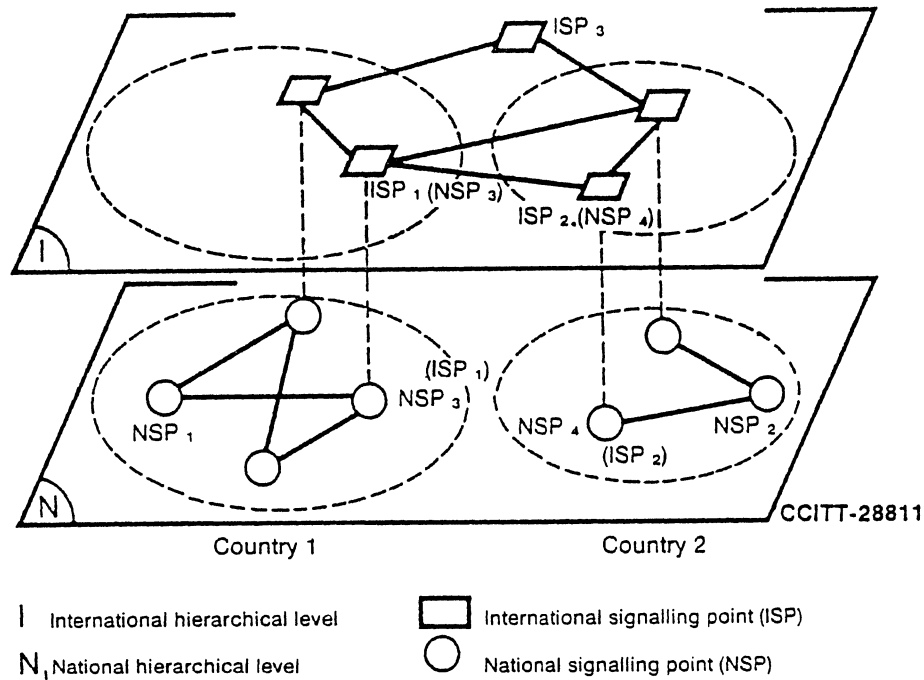

Figure 1/Q.705 - International and national signalling networks

4.2 Message Transfer Delay

In order to take account of signalling message delay considerations, regard should be given, in the structure of a particular signalling network, to the overall number of signalling links (where there are a number of signalling relations in tandem) related to a particular user transaction (e.g., to a specific call in the telephone application).

4.3 Message Sequence Control

For all messages for the same transaction (e.g., a telephone call), the Message Transfer Part will maintain the same routing; provided that the same "signalling link selection" code is used in the absence of failure. However, a transaction does not necessarily have to use the same signalling route for both forward and backward messages.

4.4 Number of Signalling Links used in Load-Sharing

The number of signalling links used to share the load of a given flow of signalling traffic typically depends on:

- the total traffic load,
- the availability of the links,
- the required availability of the path between the two signalling points concerned, and
- the bit rate of the signalling links.

Load-sharing requires at least two signalling links for all bit rates, but more may be needed at lower bit rates.

SIGNALLING NETWORK STRUCTURE

When two links are used, each of them should be able to carry the total signalling traffic in case the other link fails. When more than two links are used, sufficient reserve link capacity should exist to satisfy the availability requirements specified in Recommendation Q.706.

4.5 *Satellite working*

Due to the considerable increase in overall signalling delay, the use of satellites in Signalling System No. 7 connections is not recommended. *

In international operation, when the network served by the signalling network is routed on terrestrial circuits, only in exceptional circumstances should a satellite circuit be employed for the supporting signalling connection.

5. *INTERNATIONAL SIGNALLING NETWORK*

(Not applicable.) *

6. *SIGNALLING NETWORK FOR CROSS-BORDER TRAFFIC* *

(To be specified.)

6A. *SIGNALLING NETWORK FOR INTER-NETWORK TRAFFIC* *

6A.1 *General* *

For inter-network traffic between signalling points, the need for special capabilities and configurations is likely. New protocol capabilities (to be defined) should provide for appropriate screening and measurement. *

6A.2 *Integrated Numbering of National Signalling Networks* *

By this arrangement, the signalling points and gateways that serve inter-network traffic should be identified by common national signalling point codes. *

6A.3 *Interworking of National Signalling Networks* *

At the inter-network signalling network interface, special capabilities will be needed to provide reasonable security (to be specified). *

6A.4 *Inter-Network Signalling Network Structure* *

The United States network structures provide access to each other via link sets with a minimum of 3 diverse facilities between CCS networks. Where mated STPs are used, the configuration could be as in Figure 1A2/Q.705. Connections should be made between the highest level STP pairs in each network for efficiency. This does not, however, preclude connections to a lower level STP pair in cases of a high community of interest. *

The above interconnection scenarios are shown in Figures 1A1/Q.705 and 1A2/Q.705. *

SIGNALLING NETWORK STRUCTURE

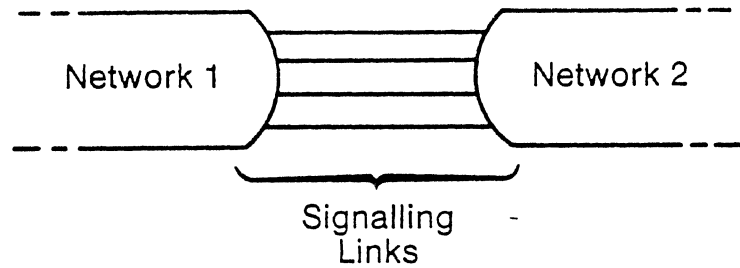

Figure 1A1/Q.705 -
Inter-network interconnection of Network 1 and Network 2

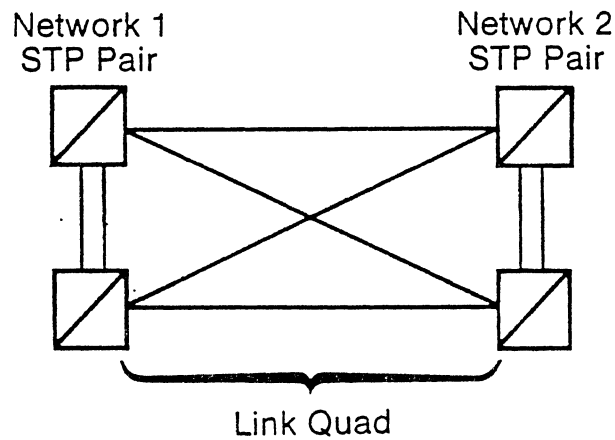

Figure 1A2/Q.705 -
STP pair from Network 1 interconnecting with an STP pair from Network 2 (consistent with Red Book
Figures A3-1/Q.705 and A3-2/Q.705)

6A.5 Routing In The Absence Of Failures

All United States networks use the SLS field for load-sharing. To ensure a balanced mix of SLS codes, the method of SLS rotation is used. Other methods of load-sharing are for further study. The SLS field is five bits. SLS rotation is described in Section 7.

6A.6 Routing Under Failure

If a signalling link in the United States inter-network structure fails, its traffic will be rerouted to one or more signalling links within the same combined link set using the standard changeover procedure described in Recommendation Q.704, Section 5. The traffic from the failed links is load-shared over the working links in the combined link set.

When a United States inter-network signalling link recovers from a failure, its traffic will be changed back using the changeback procedure. The changeback procedure is described in Q.704, Section 6.

SIGNALLING NETWORK STRUCTURE

7. NATIONAL SIGNALLING NETWORKS

7.1 General

This section describes the basic network structure used in common channel signalling networks. This structure is the framework upon which United States CCS networks should be based.

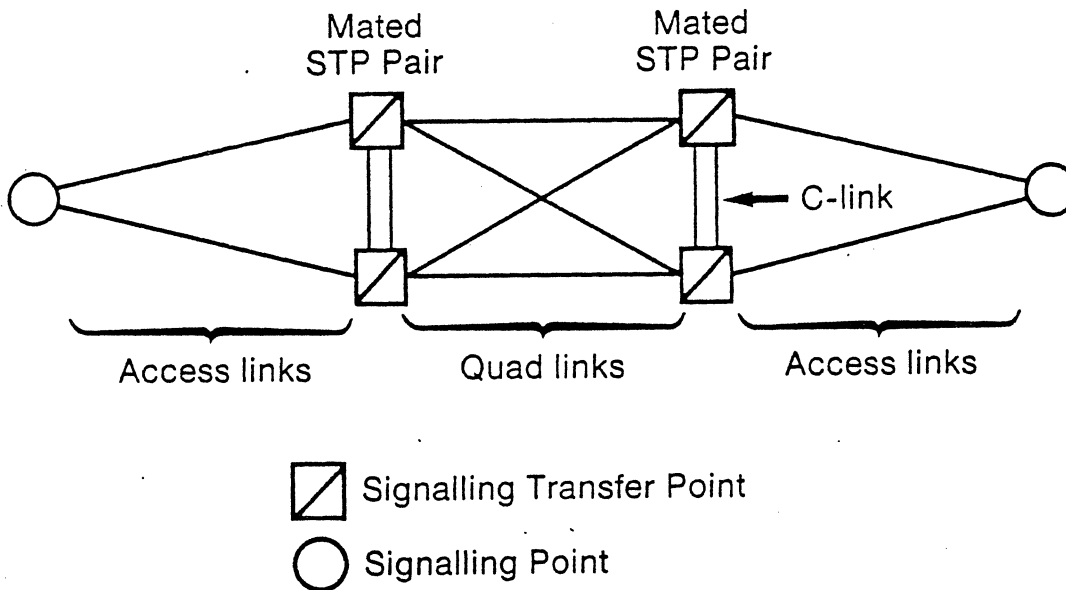

Figure 1A3/Q.705 - Mesh structure (Red Book Figure A2-1/Q.705)

The network structure is built from the basic mesh network shown in Figure 1A3/Q.705. Signalling Transfer Points (STPs) are joined by with signalling links (called C-links) to form mated STP pairs. These STP pairs are connected to other STP pairs with a signalling link quad structure designed to provide high reliability. Each signalling link quad is composed of four links between the STP pairs. Several of these STP pairs are joined in the network to form the "backbone" STP network.

Signalling points, not serving as STPs, use pairs (layers) of Access links, called A-links, to access an STP pair. A-links will always be installed in pairs from signaling points, with one link to each mate STP.

7.2 Network Structure

7.2.1 One Level Hierarchy

Figure 1A3/Q.705 can also be used to illustrate a one level STP hierarchy. A signalling network can consist of a single STP pair or multiple STP pairs. Each STP pair and the signalling points accessing that STP pair can be viewed as a sub-network. Such a mated STP pair is designated as a Primary STP pair.

All Primary STP pairs in a single signalling network will be fully interconnected via signalling link quads with all other Primary STP pairs in that signalling network. These links are called B-links. Interconnection of signalling networks is discussed in Section 6A. The number of Primary STP pairs will depend on STP capacity, sub-network, network and inter-network traffic levels, and individual company policies.

SIGNALLING NETWORK STRUCTURE

7.2.2 Two Level Hierarchy

A two level STP hierarchy is an extension (or growth) of the one level hierarchy. Some networks, typically those with high levels of sub-network traffic volume, may have another level of STP pairs, designated as the Secondary STP pairs (Figure 1A4). As with Primary STP pairs, Secondary STPs always occur in mated pairs and interconnect with other STP pairs via link quads.

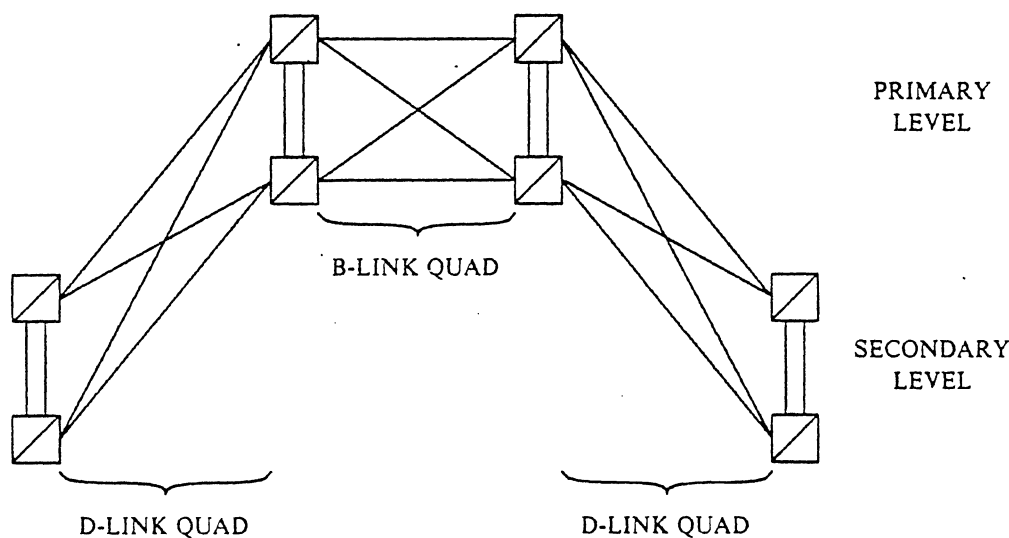

Figure 1A4/Q.705 - Two Level STP Hierarchy

Secondary STP pairs are always homed to specific Primary STP pairs. There may be more than one Secondary STP pair connected to any particular Primary STP pair. The connection is made via signalling link quads called D-link quads.

Within a sub-network, Secondary STP pairs may be connected to each other via B-link quads. If no connection exists, signalling between Secondary STP pairs is routed through the Primary STP pair.

Connections between Secondary STP pairs in one Primary region and Secondary or Primary STP pairs in a different Primary region are for further study.

7.2.3 Clustering

Procedures in Q.704 and the network address structure are designed to support clustering of network signalling points. A signalling point is any addressable node in the signalling network. A cluster of signalling points is defined as a group of signalling points that directly home on a mated pair of STPs and that are addressable as a group. The address plan allows the cluster address to refer to the cluster as a whole for network management.² In addition, each STP could be a single node cluster by itself so that it is uniquely addressable by the information in the Network Cluster field.

One level and two level clustering (addressing) can be supported by the network address. Two level clustering (addressing) requires the Network Cluster field to be sub-divided and sub-clusters to be defined.

2. An alias point code may be assigned to an STP pair only to access the SCCP global title translation function. The alias point code is not necessarily a cluster address.

SIGNALLING NETWORK STRUCTURE

All signalling networks, at a minimum, support one level of addressing. The use of two level clustering (addressing) should be a network option. Those STPs that support one or two level clustering (addressing) should be capable of communicating to signalling points and networks that support the other method of clustering (addressing).

Two level clustering (addressing) requires the definition of large and small clusters. Cluster boundaries are defined around Primary and Secondary STP groupings. A small cluster is defined as a set of signalling points that directly home on an STP pair. This is the same as the definition used in one level clustering (addressing) for a cluster. Multiple small clusters can be defined to be homed on a single STP pair. The large cluster is composed of a set of small clusters that directly home on the Primary STP pair and/or home on its associated Secondary STP pairs (i.e., a large cluster is a group of small clusters).

7.2.4 Signalling Point Access

Signalling points in the network are normally connected to their home STP pair via Access link (A-link) pairs. These A-links must be provided on diverse routes to each STP in the mated pair. The signalling point may be a switching office, a data base, or any other signalling node (except an STP).

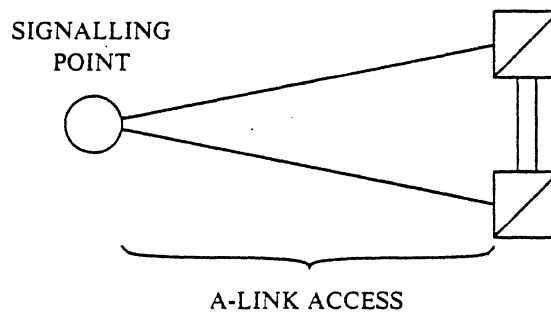

Figure 1A5/Q.705 - A-link Access

In addition to A-link access to a SP's home STP pair, a SP may have a pair of link sets to any other STP pair in the signalling network. These extended access links are called E-links and must also be provided on diverse routes to both STPs in the target STP pair. These links may be used by network planners to alleviate traffic load in regional STPs.

Signalling points may also communicate with each other directly from point to point. Such signalling is called associated signalling and uses F-links.

Associated signalling using F-links may be used between any two signalling points within or outside of the STP homing groups (clusters). Provision for alternate routing of F-link traffic into the backbone network upon link set failure is a network option, in which case, single F-link link-sets would be allowed.

SIGNALLING NETWORK STRUCTURE

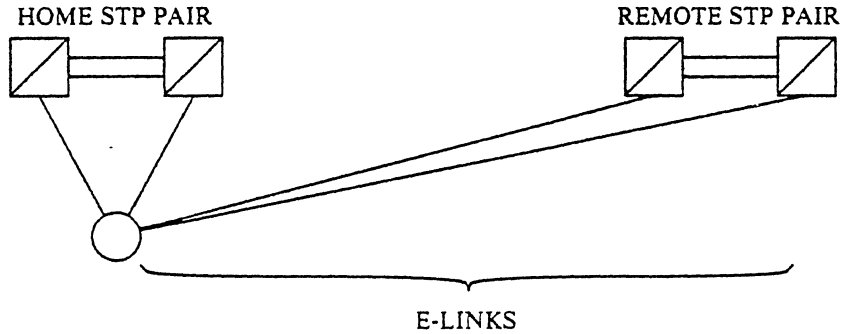

Figure 1A6/Q.705 - E-link Access

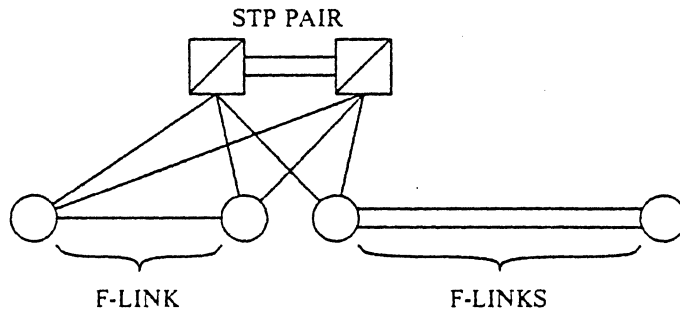

Figure 1A7/Q.705 - F-links

7.3 Routing

7.3.1 Routing in the Absence of Failures

7.3.1.1 Load Sharing#

Load sharing of messages between routes (links) is done using a five bit SLS code as described in Section 2.2.4 of Q.704. In this aspect of routing, the traffic load is distributed evenly over the links of a link set or combined link set (whichever is applicable). All signalling points load share among those link sets at the same priority level which move the traffic in the direction of the message's destination. Many load sharing methodologies use a technique called bit rotation, illustrated in Figure 1A8a.

The T1X1 draft has been updated and is consistent with this section.

SIGNALLING NETWORK STRUCTURE

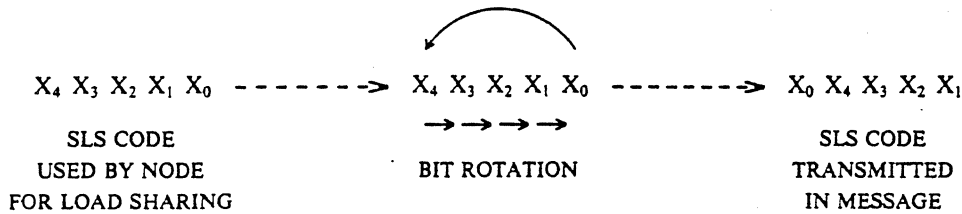

Figure 1A8a/Q.705 - Bit Rotation

In Figure 1A8a, an X_i represents a bit (0 or 1) of the SLS code. Prior to transmission, the SLS code is rotated right, i.e., shifting all bits one position to the right and placing the first bit into the fifth bit position. Rotation is done prior to transmission on all link sets except C-links. Bit rotation is necessary for all load sharing methodologies that use the least significant bit for selecting a link set from a combined link set. Bit rotation is used so that information used to load share at any subsequent signalling point is independent of the information used at the previous signalling point.

An example of a load sharing methodology is called modified SLS rotation and is described by the remainder of this section. This methodology uses bit rotation since it uses the least significant bit for link set selection. This methodology also specifies that when a link set selection is not necessary, the least significant bit is included in the link selection. This feature of the methodology allows access link sets (e.g., A-links and E-links) to contain 16 links. All other link sets are limited to 8 links.

When load sharing over a combined link set of more than one link set, the least significant bit is used to choose a link set. The remaining 4 most significant bits are used to choose a link from the chosen link set. The selection of the link set and then link is illustrated in Figure 1A8b.



Figure 1A8b/Q.705 - Load Sharing over a Combined Link Set

In Figure 1A8b, an X represents a uniform distribution of 0's and 1's in all cases and a Y represents a uniform distribution of 0's and 1's only in the case where the signalling point is generating the SLS codes for the messages. Figure 1A8c illustrates the link set selection on a model of a combined link set of more than one link set. The figure shows that when the least significant bit is a 0, the upper link set is selected. When the least significant bit is a 1, the lower link set is selected. The SLS codes that appear in the messages on the links are the codes that were formed after the sending node has performed the bit rotation.

SIGNALLING NETWORK STRUCTURE

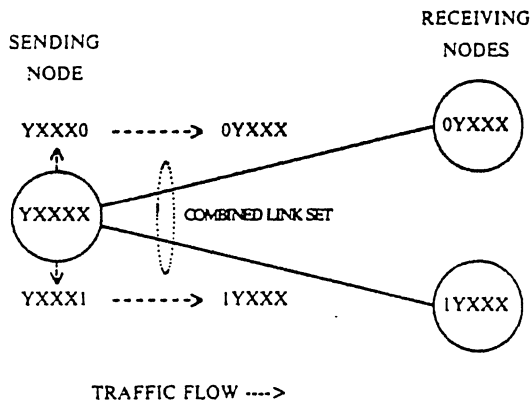

Figure 1A8c/Q.705. Combined Link Set Model - Load Sharing

When load sharing over a single link set, the 4 *least* significant bits are used to choose the link from the single link set. The most significant bit (Y) is not used because it does not provide any additional information in the selection of the link (i.e., the most significant bit is not always a uniform distribution of 0's and 1's). The selection of a link from a single link set is illustrated in Figure 1A8d/Q.705. Figure 1A8e/Q.705 illustrates the link selection on a model of a single link set.

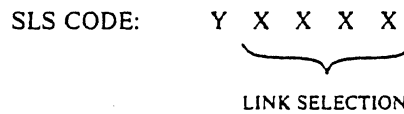

Figure 1A8d/Q.705. Load Sharing over a Single Link Set

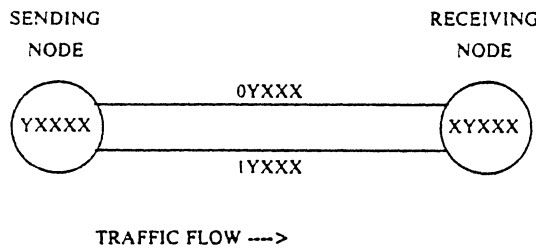

Figure 1A8e/Q.705. Single Link Set Model - Load Sharing

Figure 1A8f/Q.705 illustrates an example of an end-to-end connection between two signalling points. For simplicity, all link sets contain only one link. The figure shows the SLS codes that the signalling points use for load sharing and the SLS codes that are transmitted in the messages on the links (i.e., bit rotation is performed by the sending node).

SIGNALLING NETWORK STRUCTURE

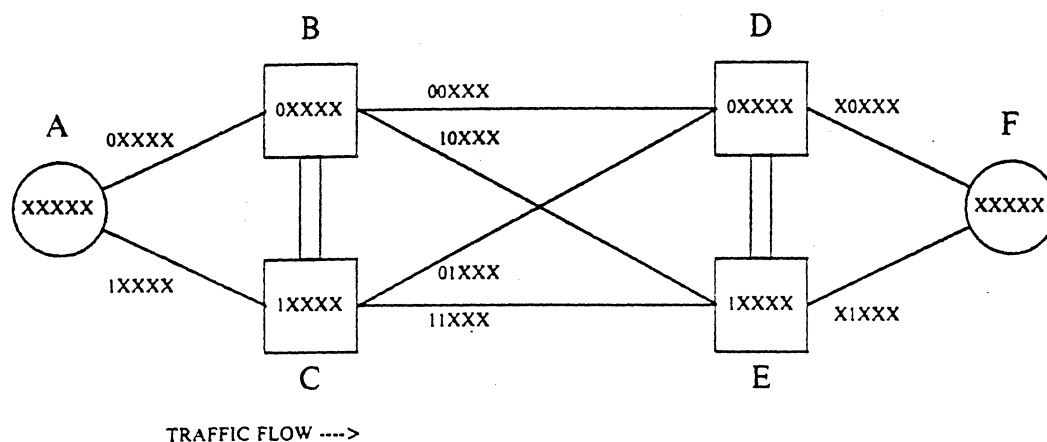

Figure 1A8f/Q.705. End-to-End Load Sharing Example

In the example illustrated in Figure 1A8f/Q.705, office A is sending messages to office F. For these messages, office A load shares the messages over the combined link set to STPs B and C. If the least significant bit of the SLS code in the message is a 0, then office A chooses the link set to STP B (i.e. SLS type XXXX0, where X = 0 or 1). Similarly, office A chooses the link set to STP C on SLS type XXXX1. Prior to transmission, bit rotation is performed on the SLS code.

STPs B and C use the same load sharing procedure to send the messages to STPs D and E. STP B chooses the link set to STP D on SLS type YXXX0. The link set to STP E from STP B is chosen on SLS type YXXX1. Similarly, STP C chooses the link set to STP D on SLS type YXXX0 and the link set to STP E on SLS type YXXX1.

Having the link sets to STP D chosen on SLS type YXXX0 ensures that STP D will have a uniform distribution of the 4 least significant bits (i.e., 0XXXX) for load sharing (i.e., receiving SLS types 00XXX from STP B and 01XXX from STP C to form SLS type 0XXXX). This is also the case for STP E (i.e., receiving SLS types 10XXX and 11XXX to form SLS type 1XXXX). This method ensures that each subsequent signalling point will have, at least, a uniform distribution of the 4 least significant bits of the SLS code available for load sharing.

Both STPs D and E have a single link set to reach office F. Since a link set selection is not needed, STPs D and E will use the 4 least significant bits to choose a link from the link set.

This load sharing methodology is sufficient to handle any number of STPs in the signalling route.

7.3.1.2 Normal Routing

Offices may use F-links, E-links, or A-links to route traffic to a destination point. The preferred route shall always be the most direct one. Therefore, if an office has F-links to a destination, the F-link link-set shall be the preferred route. If F-links do not exist and the office has E-links to the destination STP, then the E-links shall be the preferred route. If E and F-links do not exist, A-links shall be used. Alternatives under failure are discussed in the next section.

STPs may use B-link quads, D-link quads, E-links or A-links to route traffic to a destination point. If A-links exist to a specific destination, they shall be the preferred route. If A-links do not exist, any E-links to the destination shall be the preferred route. If the message must be routed to another STP, the "homing" STP pair of the destination is preferred, followed by the Primary STP pair of the destination followed by the Primary STP pair of the originating point.

SIGNALLING NETWORK STRUCTURE

7.3.2 Routing Under Failure Conditions

7.3.2.1 Alternate Routing of Traffic From Failed Links

This section considers the alternate routing of traffic when links fail, but the corresponding link sets have not failed. Link set failures are discussed in the next section.

When a link fails, the load it was carrying that was being routed over a combined link set is load shared over all remaining links in the combined link set. This is done by reassigning the SLS codes that were previously assigned to the failed link to the remaining links in the combined link set. The load the failed link was carrying that was being routed only on the corresponding link set is load shared over the remaining links in that link set.

7.3.2.2 Alternate Routing of Traffic From Failed Link Sets

In order to handle failure conditions that may develop, each signalling point has alternative routing information which specifies alternate link set(s) to be used when the normal link set becomes unavailable (see Recommendation Q.704, Section 4.2).

Table 0A1/Q.705 gives, as an example, a list of alternative link sets for all normal links at signalling point A and at Signalling Transfer Point B for the network model illustrated in Figure 1A9/Q.705. In the basic mesh network, all link sets except those between Signalling Transfer Points of the same pair are normal links that carry signalling traffic in the absence of failures. Alternate link sets may be assigned a priority based upon the order of their use during failure conditions. A priority 1 alternate is first choice (i.e., a normal link set), followed by a priority 2 alternate (e.g., link sets between Signalling Transfer Points of the same pair) which is used only when there are no priority 1 link sets available.

- Sections 7.3.2.2.1 to 7.3.2.2.5 present some typical examples of the consequences of faults in signalling links and signalling points on the routing of signalling traffic. For simplicity, link sets are assumed to consist of only one link each.

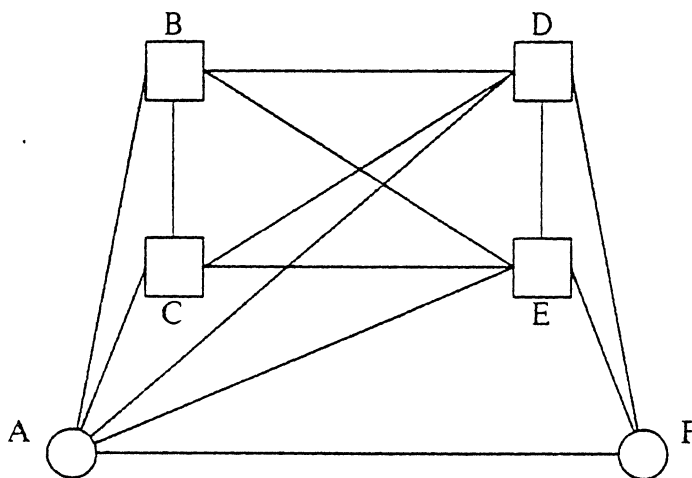

Figure 1A9/Q.705. Model to illustrate alternate link sets

SIGNALLING NETWORK STRUCTURE

Table 0A1/Q.705 - Alternate link sets (combination of Red Book tables A1-1/Q.705 and A2-1/Q.705)

AT SIGNALLING POINT	NORMAL LINK SET	ALTERNATIVE LINK SET	PRIORITY LEVEL
A	AF#	AD AE	2 2
	AC	AB	1
	AB	AC	1
	AE#	AD	1
	AD#	AE	1
B	BD	BE BC	1 2
	BE	BD BC	1 2
	BA	BC	2
	BC	NONE	—

Additional alternate routing for F-links and E-links is possible but not necessary to meet performance requirements and is, therefore, not included here.

SIGNALLING NETWORK STRUCTURE

7.3.2.2.1 Non-Backbone Link Set Failure Examples

Example 1: Failure of a link set between two signalling points.

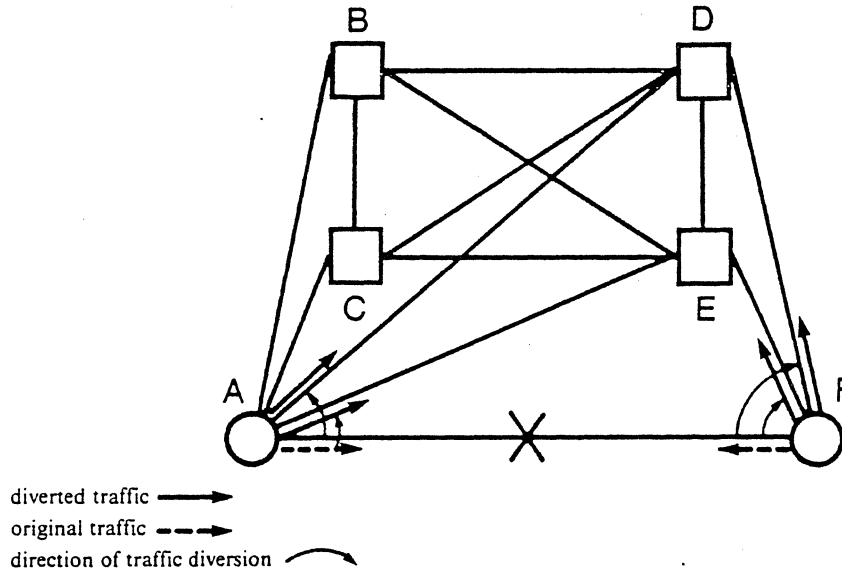

Figure 1A10/Q.705 - Failure of link set AF, F-link (Red Book Figure A1-9/Q.705)

As indicated in Table 0A1/Q.705, signalling point A diverts traffic from the failed link set AF (F-link) to the alternate link sets AD and AE (load-sharing). [Note that the use of link sets AB and AC at priority 3 is not required based on performance requirements, but may be specified as a network option.] This provides a back up route for F-link traffic through the backbone STP network. Similarly, SP F diverts traffic from link set AF to link sets FE and FD.

Example 2: Failure of E-link between a signalling point and an STP pair.

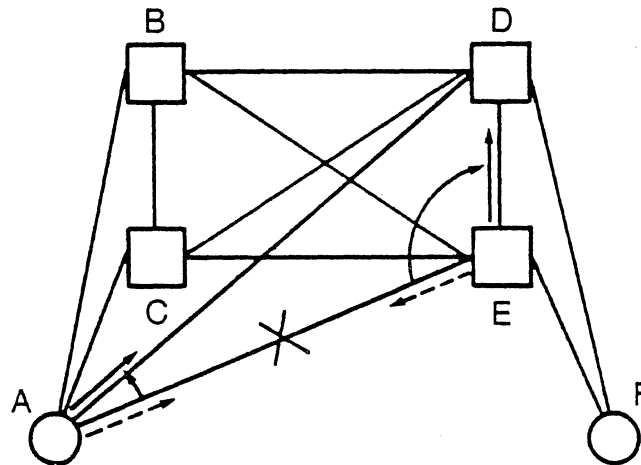

Figure 1A11/Q.705 - Failure of E-link set AE (Red Book Figure A1-10/Q.705)

On the failure of link set AE (E-link), SP A diverts traffic to the other priority 1 link set AD. STP E diverts traffic to the link set ED (C-link).

SIGNALLING NETWORK STRUCTURE

Example 3: Failure of both E-links between a signalling point and an STP pair. *

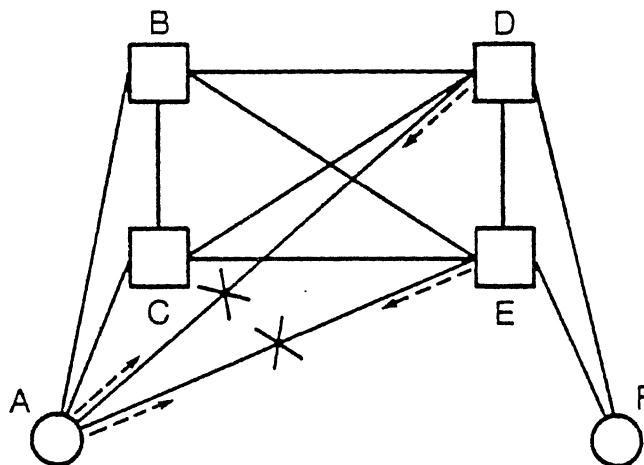

Figure 1A12/Q.705 - Failure of E-links AE and AD (Red Book Figure A1-11/Q.705) *

If both link sets (E-links) from SP A to STP pair D/E fail, traffic is blocked from originating point A to those destinations that home on STP pair D/E. Similarly, traffic is blocked from STP pair D/E to signalling point A. No other alternate routes are needed as system availability requirements are met without them. As a network option, link sets AB and AC could be specified as alternate routes with priority 2. *

Example 4: Failure of an A-link between an SP and an STP pair. *

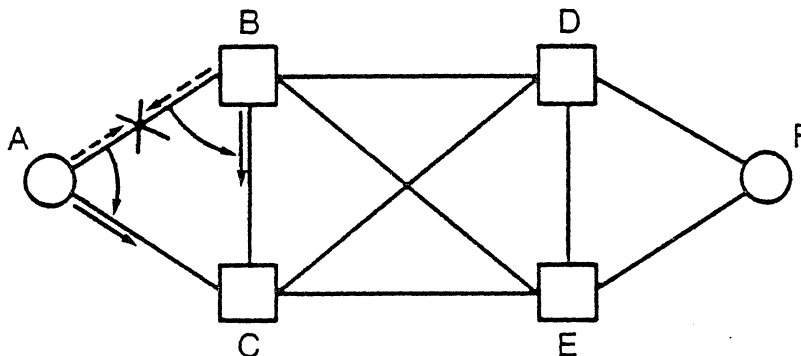

Figure 1A13/Q.705 - Failure of link set AB. A-link (Red Book Figure A2-5: Q.705) *

SP A diverts traffic from link set AB to link set AC. STP B diverts traffic from link set BA to link set BC. It should be noted that the number of STPs traversed by signalling messages from SP F to SP A, which pass through STP B, is increased by one and becomes three in this case. *

The principle to minimize the number of intermediate STPs is applied in this case at STP B to get around the failure. In fact, the procedures defined in Q.704 assume that traffic is diverted at a signalling point only in the case of a link set being unavailable on the route outgoing from that signalling point. Should the failure exist for greater than X minutes¹, an indication is sent from STP B to STPs D and E to divert traffic on link sets DB and EB destined to SP A to link sets DC and EC, respectively. *

¹ To be specified, see Recommendation Q.704.

SIGNALLING NETWORK STRUCTURE

Example 5: Failure of both A-links between an SP and an STP pair.

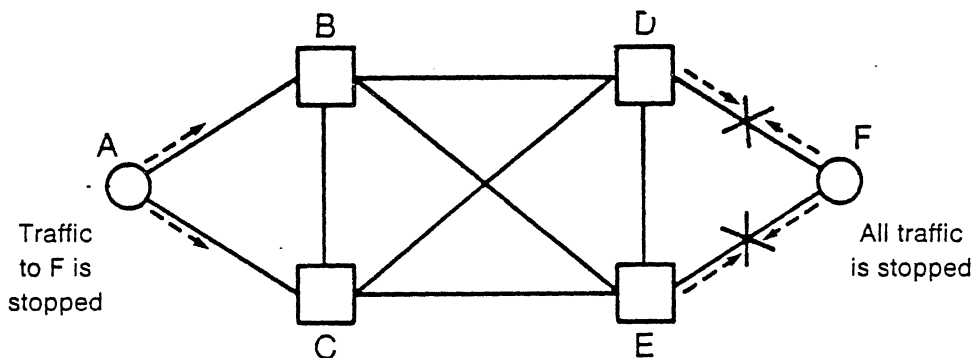

Figure 1A14/Q.705 - Failure of link sets DF and EF (Red Book Figure A2-11/Q.705)

This example is very similar to Example 3 above. SP F is inaccessible by any other SP of the network. Therefore, SP F stops all outgoing signalling traffic, while SP A (and any other SP) stops its traffic destined to SP F.

7.3.2.2 Backbone Link Set Failure Examples

Example 1: Failure of an inter-Signalling Transfer Point link set.

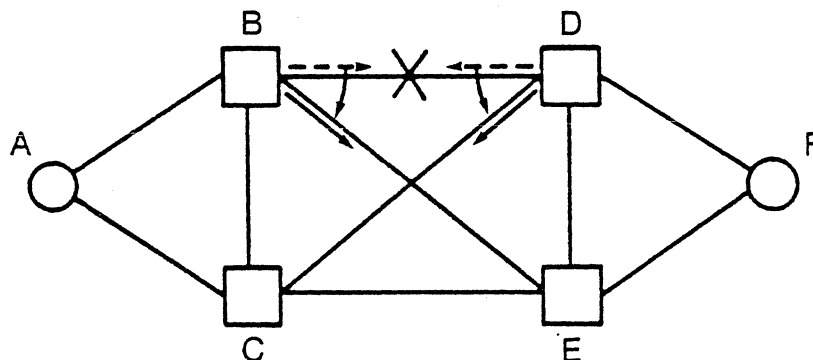

Figure 1A15/Q.705 - Failure of link set BD (Red Book Figure A2-6/Q.705)

As indicated in Table 0A1/Q.705, STP B diverts traffic from link set BD to link set BE. Similarly, STP D diverts traffic from link set DB to link set DC.

Example 2: Failure of C-links between an STP pair.

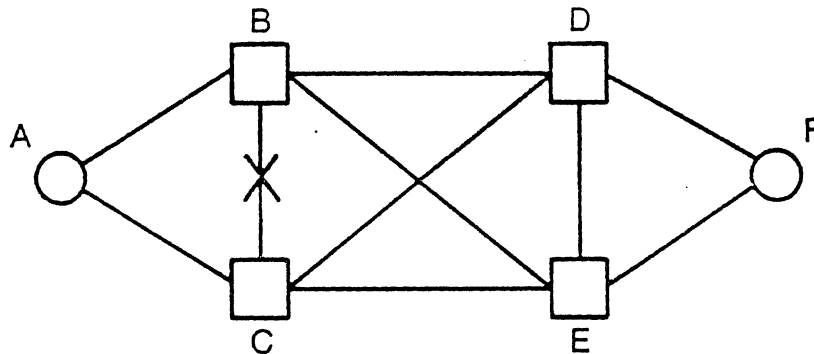

Figure 1A16/Q.705 - Failure of link set BC, C-link (Red Book Figure A2-7/Q.705)

No routing change is required as a result of this kind of failure. Only STPs B and C take note that the link set BC has become unavailable.

7.3.2.2.3 *Multiple Link Set Failure Examples* Since there are many cases in which more than one link set becomes unavailable, only some typical cases are given as examples.

Example 1: Failure of an A-link and C-link link set.

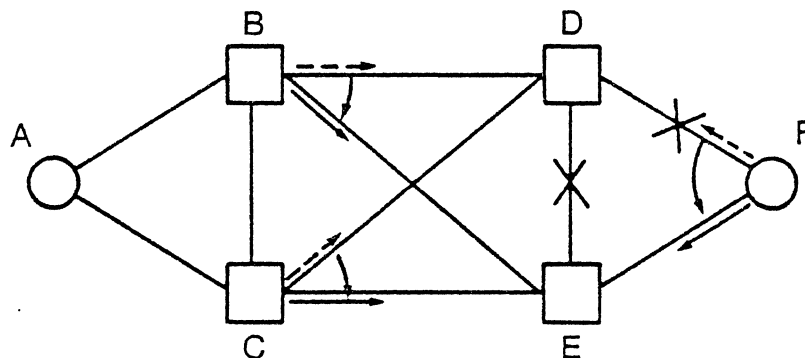

Figure 1A17/Q.705 - Failure of link sets DE and DF (Red Book Figure A2-8/Q.705)

STP B diverts traffic destined to SP F from link set BD to link set BE because destination F is inaccessible via STP D. It should be noted that not all traffic is diverted from link set BD to link set BE. Only the traffic destined to SP F is diverted from link set BD to link set BE. Similarly, STP C diverts traffic destined to SP F from link set CD to link set CE. SP F diverts all the traffic formerly carried by link FD to link FE in the same way as the single link set failure in Example 4, Section 7.3.2.2.1.

SIGNALLING NETWORK STRUCTURE

Example 2: Failure of two inter-Signalling Transfer Point link sets.

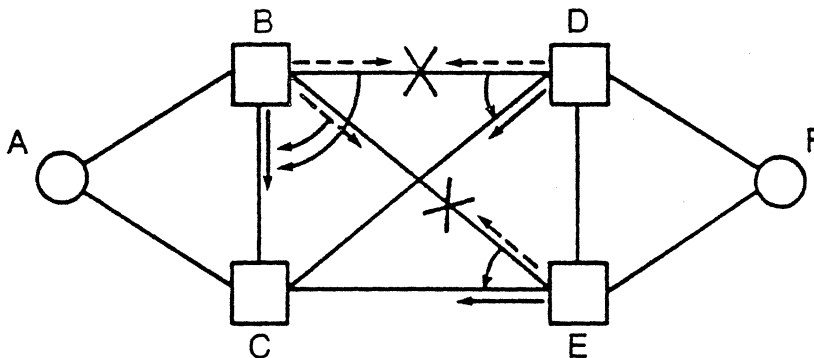

Figure 1A18/Q.705 - Failure of link sets BD and BE (Red Book Figure A2-9/Q.705)

STP B diverts traffic formerly carried by link set DB to link set BC. This is because alternate link set BE, priority 1, is also unavailable. The same applies for the traffic formerly carried by link set BE. STPs D and E divert traffic formerly carried by link sets DB and EB to link sets DC and EC, respectively.

Should the failures exist for greater than X minutes¹, an indication is sent from STP B to SP A to divert traffic destined to SP from link set AB to link set AC.

Example 3: Failure of an A-link link set and an inter-STP link set.

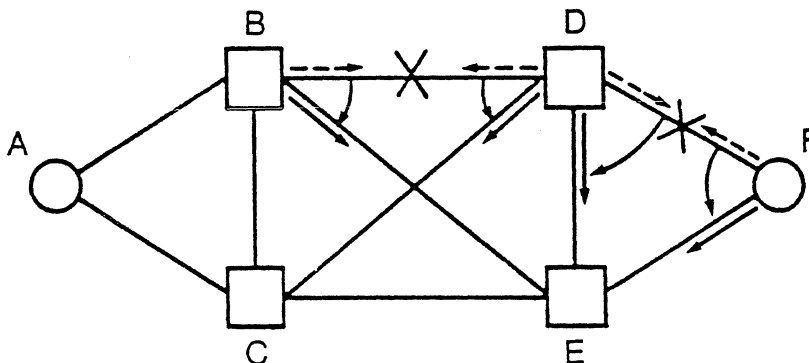

Figure 1A19/Q.705 - Failure of link sets DF and DB (Red Book Figure A2-10/Q.705)

This example is a combination of Examples 4 and 1 in Sections 7.3.2.2.1 and 7.3.2.2.2, respectively. STP D diverts traffic formerly carried by link set DF to link set DE. Similarly, SP F diverts traffic from link set FD to link set FE. Also, STP D diverts traffic formerly carried by link set DB to link set DC (this traffic is generated by all SPs connected to STP D). In the same way, STP B diverts traffic carried by link set BD to link set BE.

¹ To be specified, see Recommendation Q.704.

SIGNALLING NETWORK STRUCTURE

It should be noted that, in this case, only the portion of traffic sent by STP C to SP F via STP D transverse three STPs (C, D, and E), while all other portions continue to transverse two. Should the failure of link set DF exist longer than X minutes¹, an indication is sent from STP D to STP C to divert traffic destined for STP F from link set CD to link set CE.

7.3.2.2.4 Single Signalling Point Failure Examples

Example 1: Failure of an STP.

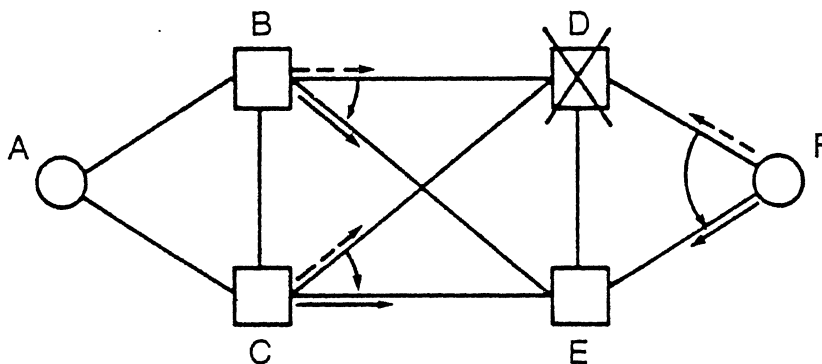

Figure 1A20/Q.705 - Failure of STP D (Red Book Figure A2-12/Q.705)

STP B diverts all the traffic formerly carried by link set BD to link set BE. Similarly, STP C diverts all traffic carried by link set CD to link set CE. SP F diverts all traffic carried by link FD to link set FE. It should be noted that all SPs homed on STP pair D/E, of which SP F is one, must divert traffic from STP D to STP E.

Attention is drawn to the difference from Example 1 in Section 7.3.2.2.3 where only a portion of the traffic previously carried by links sets BD and CD was diverted.

¹ To be specified, see Recommendation Q.704.

SIGNALLING NETWORK STRUCTURE

Example 2: Failure of a signalling point.

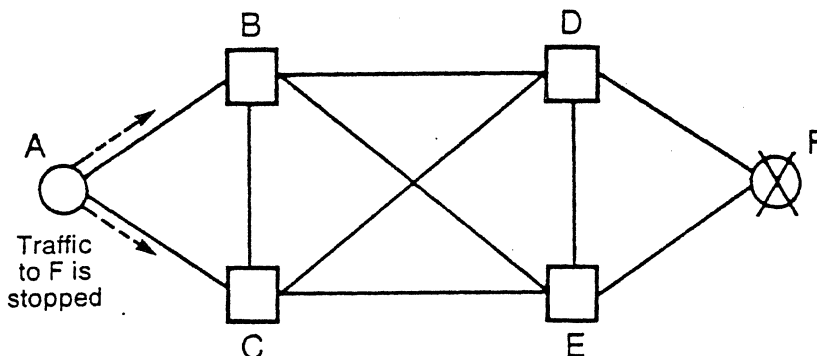

Figure 1A21/Q.705 - Failure of signalling point F (Red Book Figure A2-13/Q.705)

In this case, SP A stops all the traffic destined for SP F formerly carried by link sets AB and AC.

7.3.2.2.5 Multiple Signalling Transfer Point Failure Examples

Two typical cases of two Signalling Transfer Points failing together are presented in the following examples.

Example 1: Failure of two non-mate STPs.

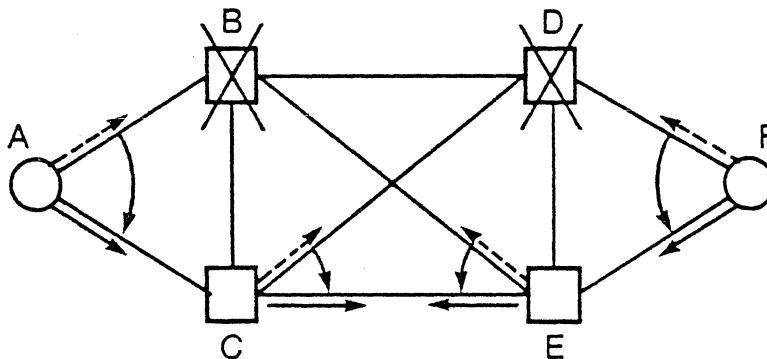

Figure 1A22/Q.705 - Failure of signalling transfer points B and D (Red Book Figure A2-14/Q.705)

As a result of the failure of STP B, SP A diverts traffic formerly carried by link set AB to link set AC, while STP E diverts traffic formerly carried by link set EB to link set EC. Similarly, as a result of the failure of STP D, SP F diverts traffic formerly carried by link set FD to link set FE, while STP C diverts traffic formerly carried by link set CD to link set CE.

It should be noted that, in this example, all the traffic between SPs homed on STP pairs B/C and D/E is concentrated on only one inter-Signalling Transfer Point link set (failure of a Signalling Transfer Point is equivalent to a simultaneous failure of all the signalling link sets connected to it). Under normal engineered load, link set CE will congest in this case and notification of this may be sent to the SPs homing on the STP pairs B/C and D/E.

SIGNALLING NETWORK STRUCTURE

Example 2: Failure of mated pair of Signalling Transfer Points.

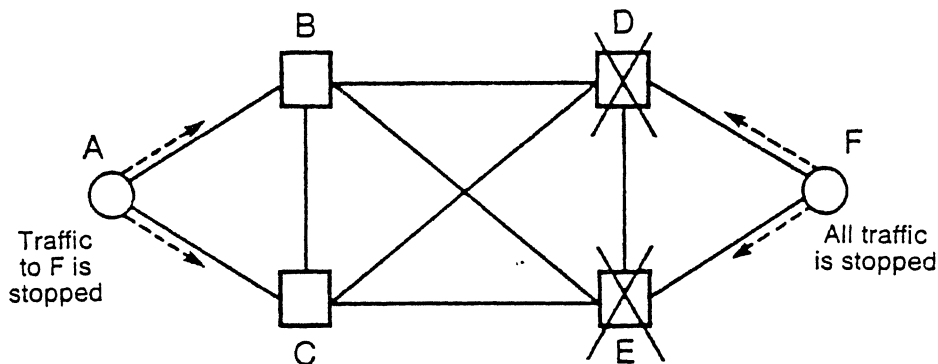

Figure 1A23/Q.705 - Failure of signalling transfer points D and E (Red Book Figure A2-15/Q.705)

This example is equivalent to Example 5 in Section 7.3.2.2.1 as far as the inaccessibility of SP F is concerned but, in this case, all SPs homed on the STP pair D/E (e.g., SP F) are inaccessible. In this case, all SPs homed on other STP pairs (e.g., SP A and STP pair B/C) stop all signalling traffic destined to SPs homed on the failed STP pair D/E (e.g. SP F). SPs homed on the failed STP pair D/E stop all outgoing signalling traffic.

7.4 Address Structure

The signalling point code structure is the same as described in Section 2.2.3A of Q.704 and is illustrated below in Figure 1A24/Q.705.

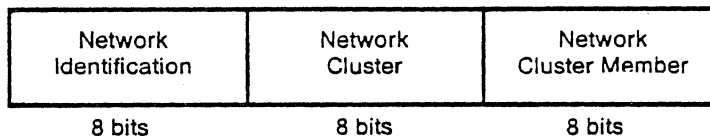

Figure 1A24/Q.705 - Address structure

The Network Identification field identifies United States signalling networks. A few (see Recommendation Q.708) of the Network Identification field codes have been reserved as an escape mechanism so that the Network Cluster field can also be used to identify smaller signalling networks.

The Network Cluster field identifies groups of signalling points and individual STPs of a signalling network. This field could also be subdivided to support two levels of addressing and clustering, but this is left as a network option.

The Network Cluster Member field identifies individual signalling points within a cluster. There is a maximum of 255 members to a cluster, where the "all zeros" member code is left unassigned to identify all members of the cluster.

Table 0A2/Q.705 gives, as an example, the signalling point code assignments for the signalling points in the network model illustrated in Figure 1A25/Q.705. An arbitrary network identification code assignment of 00011010 was chosen for the network in this example.

SIGNALLING NETWORK STRUCTURE

Q.705

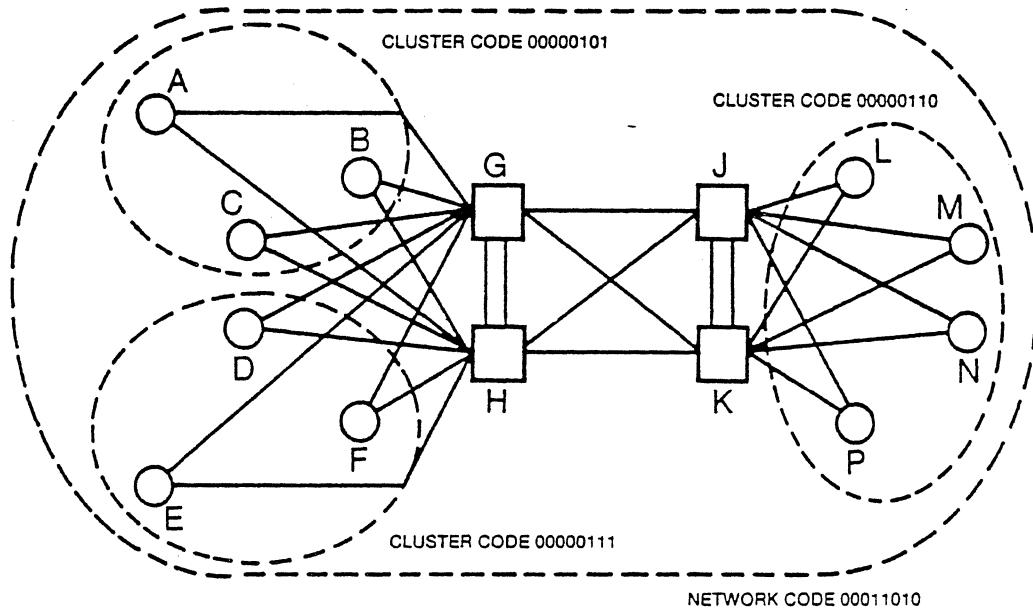

Figure 1A25/Q.705 - Model to illustrate addressing of signalling points

*
*

SIGNALLING NETWORK STRUCTURE

TABLE 0A2/Q.705 - Addressing of signalling points

SIGNALLING POINT	SIGNALLING POINT CODE		
	NETWORK	CLUSTER	MEMBER
G	00011010	00000001	00000000
H	00011010	00000010	00000000
J	00011010	00000011	00000000
K	00011010	00000100	00000000
A	00011010	00000101	00000001
B	00011010	00000101	00000010
C	00011010	00000101	00000011
L	00011010	00000110	00000001
M	00011010	00000110	00000010
N	00011010	00000110	00000011
P	00011010	00000110	00000100
D	00011010	00000111	00000001
E	00011010	00000111	00000010
F	00011010	00000111	00000011

*
*
*
*
*
*
*
*
*
*
*
*
*
*
*
*
*
*
*
*
*
*

ROUTING METHODS

CONTENTS

A.1 Introduction	1
A.2 Routing Method Description	1
A.3 Routing Model	1
A.4 Minimal Routing Status Information For Signalling Points	2

LIST OF FIGURES

Figure A-1/Q.705 - Routing Data Base Example for Node A	4
Figure A-2/Q.705 - Routing Data Base Example for STP J	5

ROUTING METHODS

A.1 Introduction

A signalling point may maintain an explicit MTP routing table entry for the full 24 bit signalling point code of every signalling point to which it routes messages. Alternatively, it may maintain only enough information to determine the proper outgoing route for a message. For example, it may route all messages to points within a given network via the same route and, therefore, not maintain explicit entries for individual signalling points within that network. The remainder of this Appendix describes this second routing method and explains how it can be used to minimize the routing data that must be administered at each signalling point. Examples are given based on the CCS network model illustrated in Figure 1A25/Q.705 and Table 0A2/Q.705.

The use of any particular routing method within a network, as well as the administration of routing data within a network, is solely at the discretion of the network operator. Different Bellcore Client Companies may have different requirements in this area.

A.2 Routing Method Description

The routing method discussed in this Appendix provides the ability to route signalling messages on part of the Destination Point Code (DPC) instead of using the entire point code in all cases. This routing method is very similar to the method used by Switching Offices for call setup. For example, in call setup, the trunk groups towards a destination are selected based on part of the called address (i.e., the dialed digits). Initially, some Switching Offices may examine only the NPA (i.e., area code), others may examine only the NXX (i.e., central office code), and the terminating Switching Office may only need to examine the XXXX (i.e., station number).

Similarly, in this method, CCS network nodes only need to examine parts of the "address" (i.e., DPC) until there is sufficient information to route the message in the direction of its final destination. Examining the whole address is not needed in the majority of cases.

This routing method also allows some signalling points to substantially reduce their routing data base (and status data base). Since the method only requires the examination of part of the DPC for routing, nodes may not need to maintain routing status information for entire point codes. If a node does not maintain the complete status for an entire point code, it is sometimes said that the point code is "unknown" to the node. But a signalling message may still be routed to an unknown point code from a node if the node has a default route associated with either the unknown point code's network or cluster.

A.3 Routing Model

The following is a brief model of the routing method described above. The model assumes that if a Global Title Translation was needed, then it was performed first. It should be stressed that this is a logical model of the routing process and is not meant to imply a particular implementation.

Step 1: The Network code of the DPC is examined.

If a routing is not identical for all points within the Network, then proceed to the next step. Otherwise, the message is routed based on the Network code's route (i.e., a default route for all nodes of a network).

Step 2: The Cluster code of the DPC is examined.

If routing is not identical for all points within the Cluster, then proceed to the next step. Otherwise, the message is routed based on the Cluster code's route (i.e., a default route for all nodes of a cluster). At this point some cluster status information may be known.

Step 3: The Member code of the DPC is examined.

ROUTING METHODS

At this point, some Member codes (of a network cluster) may have some routing status information and a route associated with them. The rest of the Member codes may either 1) have a default route associated with them (node does not maintain any routing status information for these specific members of this network cluster) or 2) be invalid (node does maintain routing status information for the members of this network cluster), in which case, the current routing error procedures are initiated.

In Step 1, it may be required of the STPs to verify that the network code is an "assigned" or authorized network code. If the network is not an assigned or authorized code and the message is being routed at the MTP level, the message should be discarded. The verification of network codes can be optional at Signalling End-Points (SEPs), i.e., SPs with no STP function.

For example, in Step 1 at an SEP all network codes could have a default route except for the SEP's own network code. In this case, more of the DPC needs to be examined (i.e., the cluster code) to determine if the message is destined for one of the SEP's home STPs.

The routing model is further illustrated in Figures A-1/Q.705 and A-2/Q.705. These figures also illustrate the "minimal routing status information" need by signalling nodes. This topic is discussed in the next section. Figures A-1/Q.705 and A-2/Q.705 use the network model illustrated in Figure 1A25/Q.705. Figure A-1/Q.705 illustrates an example of a routing data base at a signalling end-point. Figure A-2/Q.705 illustrates an example of an routing data base at an STP. These figures are only examples and they do not represent all of the possible cases. The route numbers used in the examples have no significance.

A.4 Minimal Routing Status Information For Signalling Points

In the sections above, it was mentioned that by using this routing method, signalling points may be able to maintain a smaller routing data base. This section proposes a minimal set of network, cluster, and signalling point routing status information needed by every signalling point. This minimal set of routing status information differs for each type of signalling point in the network. The "rule-of-thumb" used is that a minimal set of routing status information must contain at least all of the signalling points that are connected to a node.

The following is a list of the different signalling point types and their minimal set of routing status information. This list merely illustrates the minimal set of information needed at each signalling point and should not be taken as a requirement that implementations retain only this minimal information.

1. Signalling End-Points (SEPs) - Switching Offices:
 - The Switching Office's home STP pair.
 - All STPs (including their alias point code) that directly provide Global Title Translation services for the node. If the home STP pair provides all of the nodes direct Global Title Translation needs, then only the status of the STP pair's alias point code is needed.
 - Desirable but optional - All other Switching Offices that have a direct signalling relation with the node. For example, the other Switching Offices that have trunks directly connecting to the node.
 - Optional - Other members of the node's cluster.
 - Optional - Other clusters of the node's network.
 - Optional - Other networks.
2. Signalling End-Points (SEPs) - Network Data Bases:
 - The Network Data Base's backup (if applicable).
 - The Network Data Base's home STP pair.
 - All STPs (including their alias point code) that directly provide Global Title Translation services for the node. If the home STP pair provides all of the nodes direct Global Title Translation needs, then only the status of the STP pair's alias point code is needed.

ROUTING METHODS

- Optional - Other members of the node's cluster. *
- Optional - Other clusters of the node's network. *
- Optional - Other networks. *
- 3. Signalling Transfer Points (STPs): *
- All signalling points (Switching Offices, Network Data Bases and other STPs) that directly connect to the STP via signalling links. *
- All "assigned" networks that the STP network is authorized to have signalling communication with. *
- All other STPs (including their alias point code) that may provide some additional Global Title Translation services for the STP (e.g., Global Title traffic bound for other networks). *
- Optional - Other clusters of the STP's network. *

ROUTING METHODS

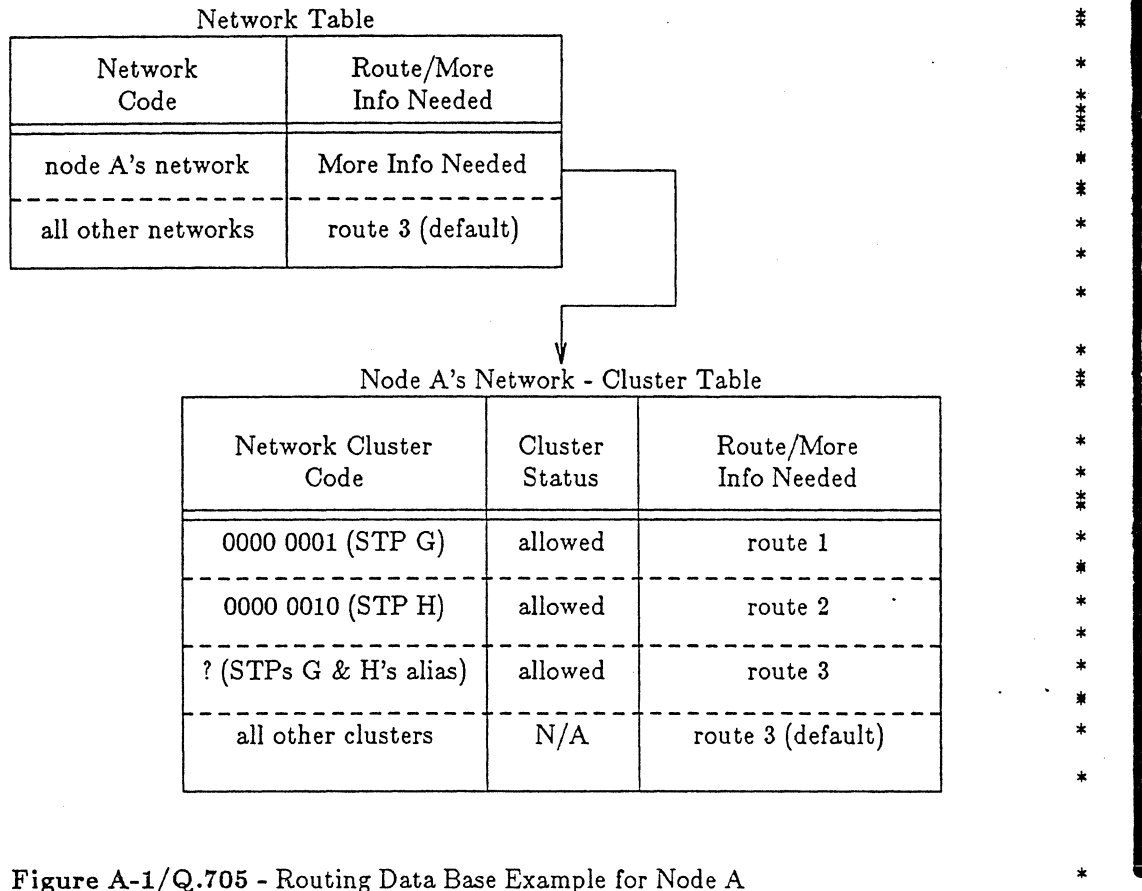
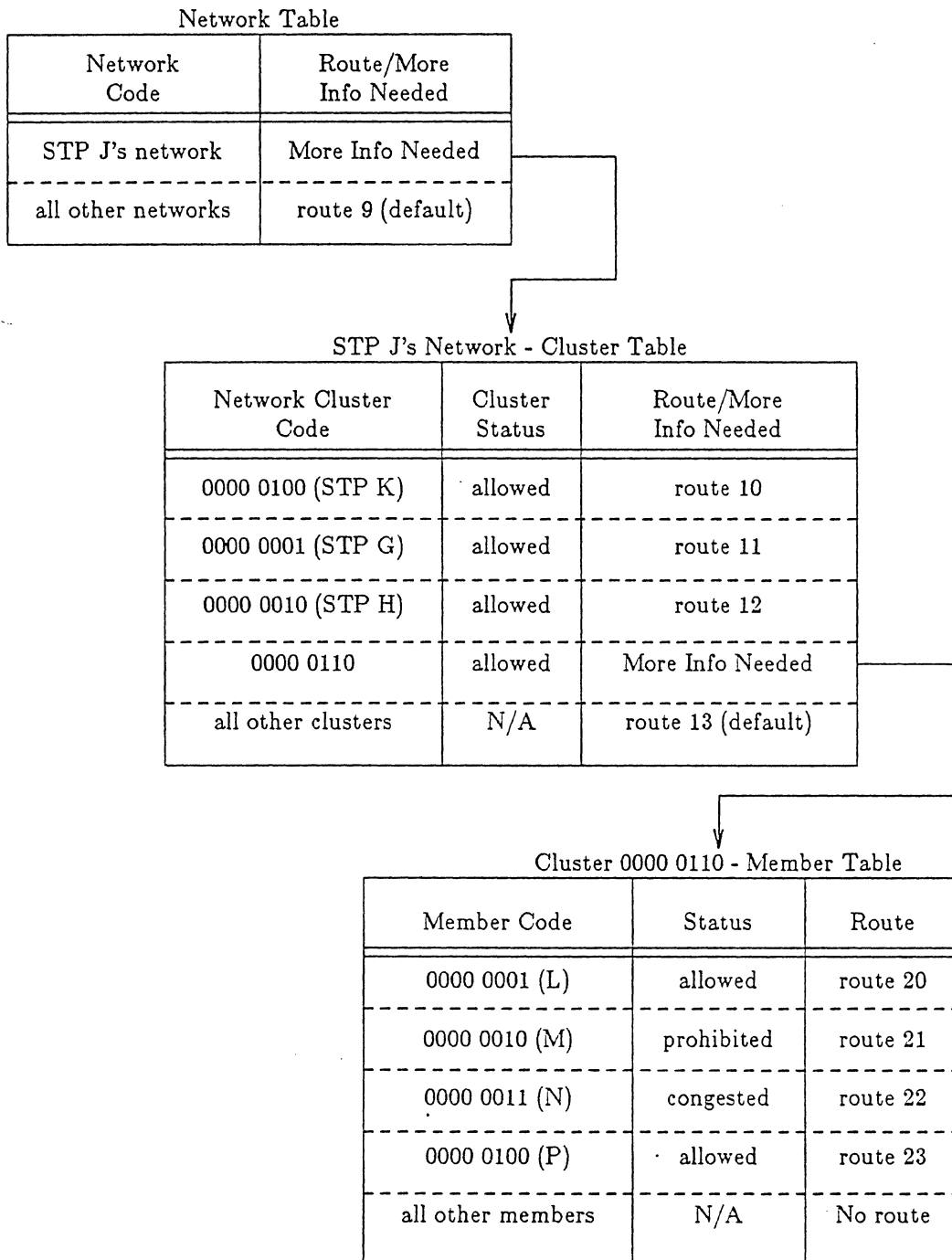

Figure A-1/Q.705 - Routing Data Base Example for Node A

ROUTING METHODS



*

*

*

*

*

*

*

*

*

*

*

*

*

*

*

*

Figure A-2/Q.705 - Routing Data Base Example for STP J