

**PUBLICATIONS
RELEASE**

1100 Series

8405/8430/8433
Disc Subsystem
Operator Reference

UP-8323

This SPERRY UNIVAC™ 1100 Series Library Memo announces the release and availability of "SPERRY UNIVAC 1100 Series 8405/8430/8433 Disc Subsystem Operator Reference", UP-8323. This is a Restricted Distribution Item (RD). Please order where required.

This manual provides the information and procedures for operating the SPERRY UNIVAC 8405/8430/8433 Disc Subsystem. Many subsystem configurations are possible with the three types of discs and two types of control units (unbuffered or buffered).

Section titles in the manual are:

1. Introduction
2. Description
3. Controls and Indicators
4. Operating Procedures
5. Operator Performed Maintenance

Copies of the manual may be requisitioned by your Sperry Univac representative.

To Mailing Lists
217, 630 (less 631E,
634, 635A), 692,
37, 38, 62, 63, 64,
81, and 83.

Library Memo plus UP-8323 (44 pages and covers)
to Mailing Lists 631E, 634, 635A, and 82.

Library Memo
for UP-8323

September 1975

SPERRY UNIVAC

1100 Series

8405/8430/8433

Disc Subsystem

Operator Reference

This document contains the latest information available at the time of publication. However, Sperry Univac reserves the right to modify or revise its contents. To ensure that you have the most recent information, contact your local Sperry Univac representative.

Sperry Univac is a division of Sperry Rand Corporation.

AccuScan, FASTRAND, PAGEWRITER, SPERRY UNIVAC, UNISCOPE, UNISERVO, and UNIVAC are trademarks of the Sperry Rand Corporation.

Contents

PAGE STATUS SUMMARY

CONTENTS

1. INTRODUCTION	1-1
1.1. GENERAL	1-1
1.2. SCOPE OF MANUAL	1-1
1.3. OPERATOR'S RESPONSIBILITIES	1-1
2. DESCRIPTION	2-1
2.1. GENERAL	2-1
2.2. CONFIGURATION	2-3
2.2.1. 8405 Fixed Head Disc (FHD)	2-5
2.2.2. 8430/8433 Disc Units	2-5
2.2.2.1. 8430 Disc Pack (F1230)	2-5
2.2.2.2. 8433 Disc Pack (F1223)	2-6
2.2.3. 5039 Storage Control Unit (Unbuffered)	2-7
2.2.4. 5039 Storage Control Unit (Buffered)	2-7
2.3. OPTIONAL FEATURES	2-7
2.4. INTERFACE	2-7
3. CONTROLS AND INDICATORS	3-1
3.1. GENERAL	3-1
3.2. 8405 FIXED HEAD DISC	3-1
3.2.1. Operator Control Panel	3-2
3.2.2. Power Control Panel	3-2
3.3. 8430/8433 DISC UNITS	3-5
3.3.1. Operator Control Panel	3-5

3.4. 5039 STORAGE CONTROL UNIT (UNBUFFERED)	3-7
3.4.1. Operator Control Panel (Control Portion)	3-7
3.4.2. Maintenance Panel (MSA Portion)	3-8
3.4.2.1. Display Clear (DISP CLR) Switch	3-9
3.4.2.2. Display Select (DISP SEL) Switch	3-9
3.4.2.3. DA/BOOT ADDRESS Pushbutton Indicator Switches	3-10
3.4.3. DC Regulator Panel (MSA Portion)	3-10
3.5. 5039 STORAGE CONTROL UNIT (BUFFERED)	3-12
3.5.1. Operator Control Panel (Control Portion)	3-13
3.5.2. Operator Control Panel (MSA Portion)	3-13
4. OPERATING PROCEDURES	4-1
4.1. GENERAL	4-1
4.2. SUBSYSTEM POWER TURN ON	4-1
4.2.1. 8405 Fixed Head Disc	4-1
4.2.2. 8430/8433 Disc Units	4-2
4.2.3. SCU (Unbuffered)	4-2
4.2.3.1. SCU Control Portion	4-2
4.2.3.2. SCU MSA Portion	4-2
4.2.4. SCU (Buffered)	4-2
4.2.4.1. SCU Control Portion	4-2
4.2.4.2. SCU MSA Portion	4-2
4.3. SUBSYSTEM POWER TURN OFF	4-3
4.3.1. 8405 Fixed Head Disc	4-3
4.3.2. 8430/8433 Disc Units	4-3
4.3.3. SCU (Unbuffered)	4-3
4.3.3.1. SCU Control Portion	4-3
4.3.3.2. SCU MSA Portion	4-3
4.3.4. SCU (Buffered)	4-4
4.3.4.1. SCU Control Portion	4-4
4.3.4.2. SCU MSA Portion	4-4
4.4. DISC UNIT OPERATION	4-4
4.4.1. Loading The Disc Unit	4-4
4.4.1.1. Loading Precautions	4-4
4.4.1.2. Loading The Disc Pack	4-5
4.4.2. Unloading The Disc Unit	4-5
4.4.2.1. Unloading Precautions	4-5
4.4.2.2. Unloading The Disc Pack	4-7
4.5. PLACING DISC UNIT OR SUBSYSTEM ONLINE	4-7
4.5.1. 8405 Fixed Head Disc	4-7
4.5.2. 8430/8433 Disc Units	4-8
4.5.3. SCU (Unbuffered)	4-8
4.5.3.1. SCU Control Portion	4-8
4.5.3.2. SCU MSA Portion	4-8
4.5.4. SCU (Buffered)	4-9
4.5.4.1. SCU Control Portion	4-9
4.5.4.2. SCU MSA Portion	4-9

4.6. PLACING DISC UNIT OR SUBSYSTEM OFFLINE	4-9
4.6.1. 8405 Fixed Head Disc	4-9
4.6.2. 8430/8433 Disc Units	4-10
4.6.3. SCU (Unbuffered)	4-10
4.6.4. SCU (Buffered)	4-10
4.7. RECOVERY PROCEDURES	4-10
4.7.1. 8405 Fixed Head Disc Recovery Procedure	4-10
4.7.2. 8430/8433 Disc Unit Recovery Procedure	4-11
4.7.3. SCU Recovery Procedure	4-11
5. OPERATOR PERFORMED MAINTENANCE	5-1
5.1. GENERAL	5-1
5.2. 8405 FIXED HEAD DISC	5-1
5.3. 8430/8433 DISC UNIT	5-1
5.4. SCU	5-1
5.4.1. SCU Control Portion	5-2
5.4.2. SCU MSA Portion	5-2
5.4.2.1. Indicator Lamp Removal and Replacement	5-2
5.4.2.2. Air Filter Removal, Replacement, and Cleaning	5-2

USER COMMENT SHEET

FIGURES

2-1. SPERRY UNIVAC 5039 Storage Control Unit	2-1
2-2. SPERRY UNIVAC 8405 Fixed Head Disc	2-2
2-3. SPERRY UNIVAC 8430/8433 Disc Unit	2-2
2-4. SPERRY UNIVAC 8405 Fixed Head Disc Subsystem Configuration	2-3
2-5. SPERRY UNIVAC 8405/8430/8433 Disc Subsystem Configuration	2-4
2-6. SPERRY UNIVAC Disc Pack - F1230 for 8430 Disc and F1223 for 8433 Disc	2-6
3-1. SPERRY UNIVAC 8405 Fixed Head Disc, Front View	3-1
3-2. SPERRY UNIVAC 8405 Fixed Head Disc Operator Control Panel	3-2
3-3. SPERRY UNIVAC 8405 Fixed Head Disc Power Control Panel	3-4
3-4. SPERRY UNIVAC 8405 Fixed Head Disc, Rear View	3-4
3-5. SPERRY UNIVAC 8430/8433 Disc Unit	3-5
3-6. SPERRY UNIVAC 8430/8433 Operator Control Panel	3-6
3-7. SPERRY UNIVAC 5039 Storage Control Unit (Unbuffered)	3-7
3-8. Operator Control Panel (Control Portion)	3-8
3-9. MSA Portion of SCU (Rear View Doors Open)	3-8
3-10. Maintenance Panel (MSA Portion)	3-9
3-11. Power Control (Rear View Doors Open)	3-10
3-12. DC Regulator Panel	3-11
3-13. SPERRY UNIVAC 5039 Storage Control Unit (Buffered)	3-12
3-14. Operator Control Panel (Control Portion)	3-13
3-15. Operator Control Panel (MSA Portion)	3-13

4-1. Disc Unit With Operator Cover Open for Disc Pack Access	4-6
4-2. Disc Pack Well in Disc Unit	4-6

TABLES

3-1. SPERRY UNIVAC 8405 Fixed Head Disc Operator Control Panel, Switches and Indicators	3-3
3-2. SPERRY UNIVAC 8430/8433 Disc Operator Control Panel, Switches and Indicators	3-6
3-3. Operator Control Panel, Switches and Indicators	3-8
3-4. DC Regulator Switches and Indicators	3-11
3-5. Operator Control Panel, Switches and Indicators	3-13
3-6. Operator Control Panel, Switches and Indicators	3-14
4-1. SPERRY UNIVAC 8405 Fixed Head Disc Operator Recovery Procedures	4-11
4-2. SPERRY UNIVAC 8430/8433 Disc Unit Operator Recovery Procedures	4-12
4-3. SCU Operator Recovery Procedures	4-12

1. Introduction

1.1. GENERAL

The SPERRY UNIVAC 8405/8430/8433 Disc Subsystem (disc subsystem) when part of a SPERRY UNIVAC 1100 Series System provides real time, rapid access operation to a large quantity of online data storage in the subsystem. The disc subsystem consists of a 5039 Storage Control Unit (SCU) that interfaces with 1100 Series Systems and controls 8405 Fixed Head Discs (8405 FHD), 8430 Disc Units (8430 disc), 8433 Disc Units (8433 disc) or a combination of the three disc units. The data is densely packed on the disc packs which are sensitive to handling. Correct handling procedures for the disc packs are outlined in this manual.

1.2. SCOPE OF MANUAL

This manual contains operator information and procedures required for operation of the disc subsystem only. Operator information for the host 1100 Series System and various other subsystems is available in the current versions of the appropriate operator reference or programmer/operator reference manuals. These manuals are listed in the hardware section of the SPERRY UNIVAC 1100 Series Summary of Current Documentation, UP-7893 (current version).

The remaining information in this manual is divided into the following four sections:

- Description
- Controls and Indicators
- Operating Procedures
- Operator Performed Maintenance

1.3. OPERATOR'S RESPONSIBILITIES

The operator is responsible for preparing the disc subsystem for operation and for performing the procedures required for efficient operation.

To assume these responsibilities the operator must know the location and function of all operator-oriented controls and indicators, and be able to perform the operating and maintenance procedures given in this manual.

2. Description

2.1. GENERAL

The basic SPERRY UNIVAC 8405/8430/8433 Disc Subsystem (disc subsystem) consists of a 5039 Storage Control Unit (SCU) and from one to eight 8405 Fixed Head Discs (8405 FHD) or an SCU and from two to eight 8430 Disc Units (8430 disc) and/or 8433 Disc Units (8433 disc). Figure 2-1 shows the SCU, Figure 2-2 shows the 8405 FHD, and Figure 2-3 shows the 8430 and 8433 discs.

Two versions (buffered and unbuffered) of the SCU are available to operate with a SPERRY UNIVAC 1100 Series System and to control various configurations and mixes of the three types of disc units.

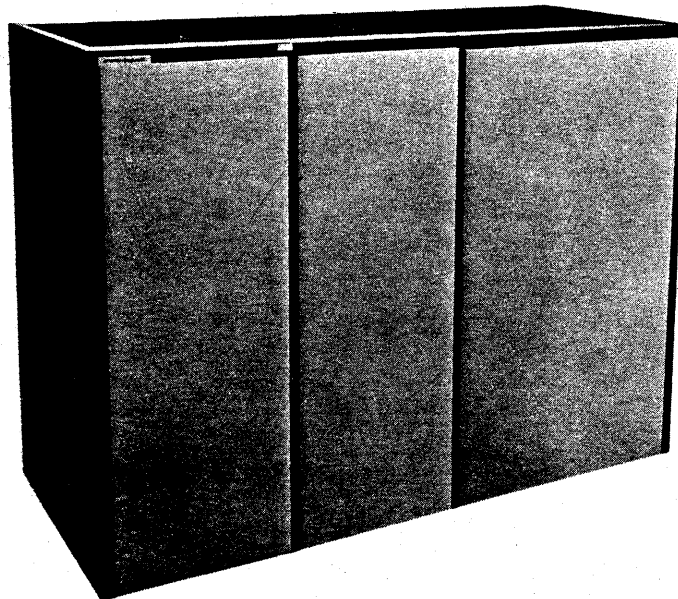

Figure 2-1. SPERRY UNIVAC 5039 Storage Control Unit

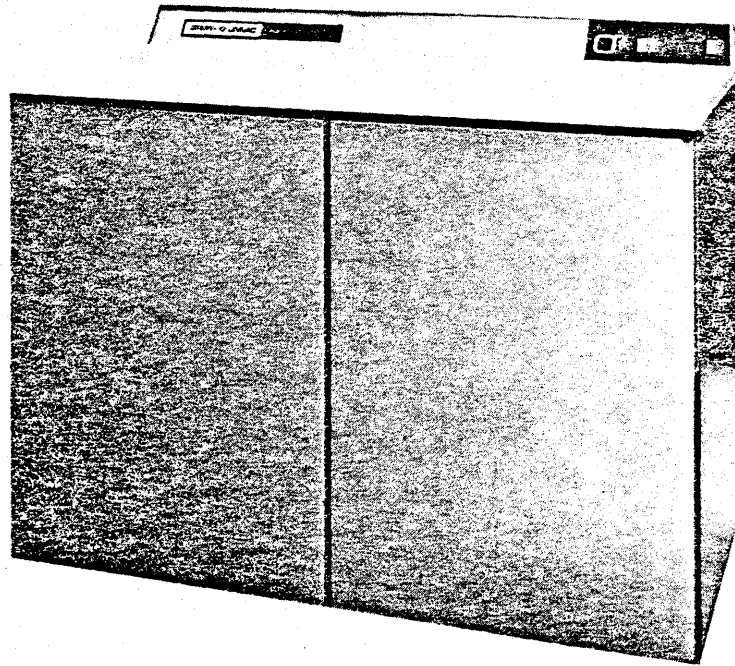

Figure 2-2. SPERRY UNIVAC 8405 Fixed Head Disc

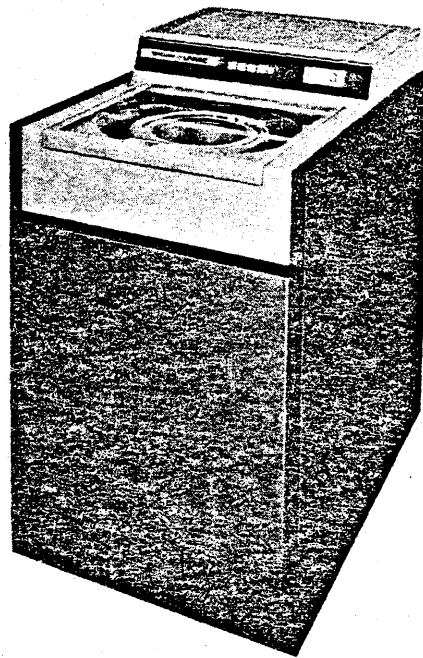

Figure 2-3. SPERRY UNIVAC 8430/8433 Disc Unit

2.2. CONFIGURATION

The disc subsystem includes two types of SCUs and three types of disc units that can be configured in different ways, see Figures 2-4 and 2-5 for the configurations. The buffered SCU and the unbuffered SCU are equipped with an integral Multi-Subsystem Adapter (MSA) feature for compatibility between the word and byte interfaces. The addition of a second SCU and appropriate features allows simultaneous read/read, read/write, write/read, or write/write operations on two disc units of the subsystem. With a 16 Drive Address feature installed, an additional eight 8430 disc and/or 8433 disc units can be added to the eight 8430 disc and/or eight 8433 disc units for a total of 16 disc units per subsystem. The 16 Drive Address feature excludes the use of the 8405 Capability feature. With the 8405 Capability feature installed, one to eight 8405 FHDs can be used alone as a subsystem (Figure 2-4) or be combined with up to eight 8430 disc and/or 8433 disc units in the subsystem. The 8405 FHD Capability feature excludes the use of the 16 Drive Address feature. With the proper shared peripheral interface (SPI) features installed, each SCU in the subsystem may interface with two to four Input/Output (I/O) channels.

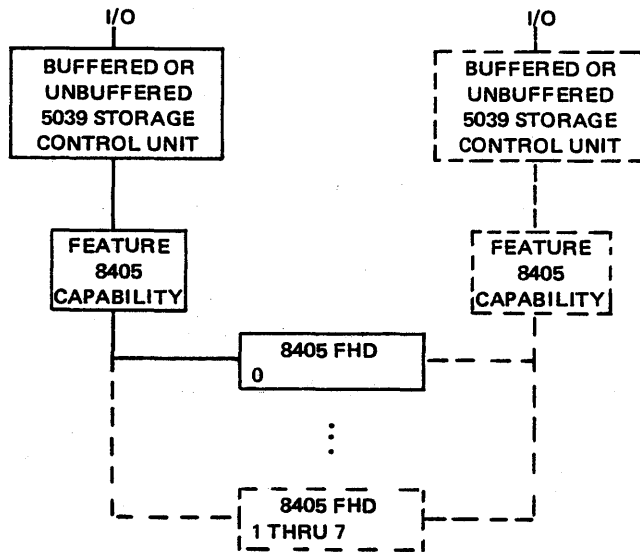
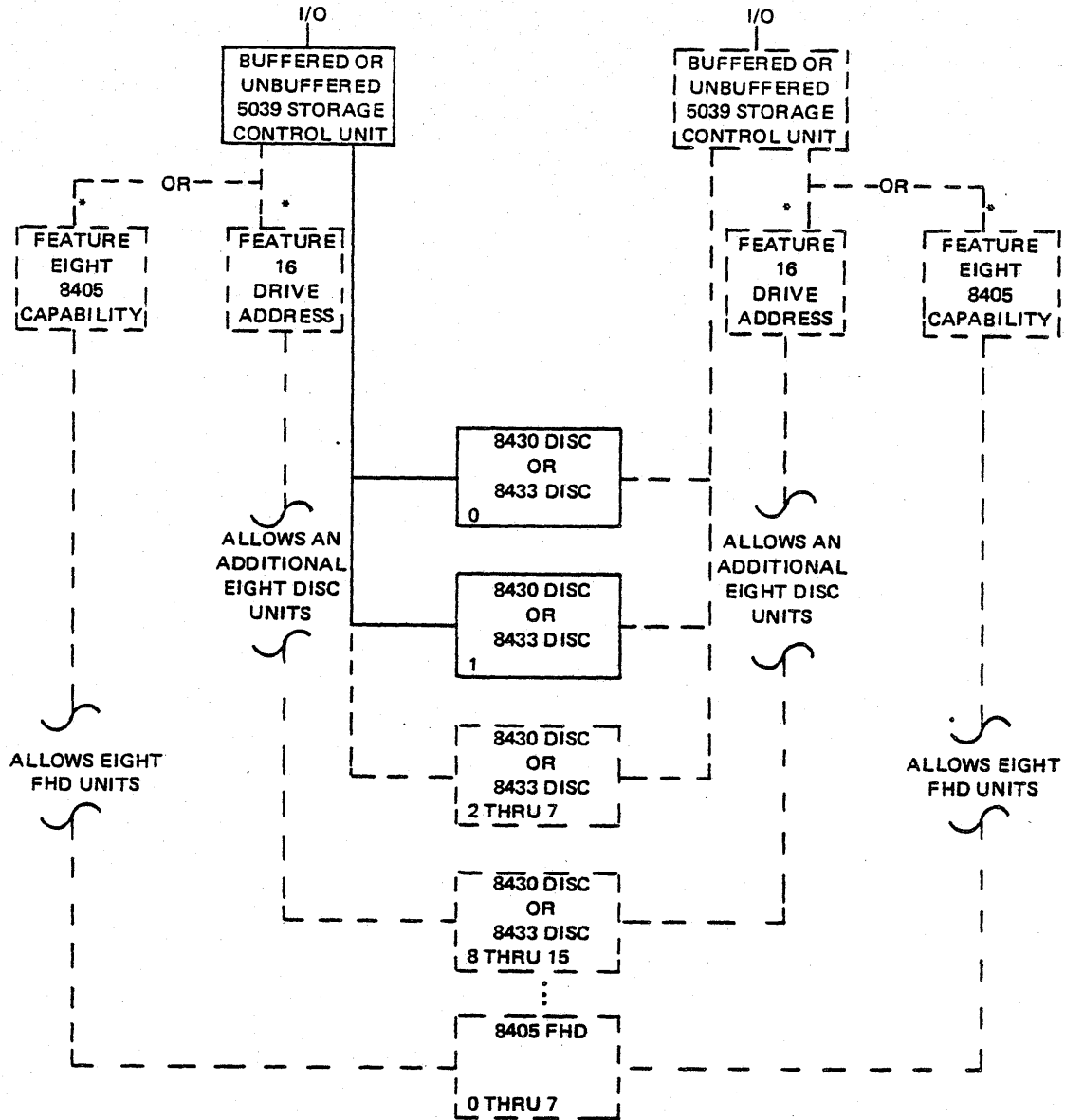

Figure 2-4. SPERRY UNIVAC 8405 Fixed Head Disc Subsystem Configuration



*Features are mutually exclusive.
--- OPTIONAL

Figure 2-5. SPERRY UNIVAC 8405/8430/8433 Disc Subsystem Configuration

2.2.1. 8405 Fixed Head Disc (FHD)

The 8405 FHD permits the 1100 Series Systems to retrieve specific records without the requirement for time consuming positioning of read/write heads. This retrieval method permits rapid direct access to active files and gives more efficient throughput for the processor. Random inquiries can also be made while records are being processed, or the records can be supplied sequentially for processing. Data transfers to and from the subsystem are made at a rate of 138K 36-bit words per second.

Two models of the 8405 FHD are available. One has six nonremovable discs in the disc stack and can store up to 1.37 million 36-bit words of data (up to 11.0 million 36-bit words of data can be stored in an eight unit subsystem), and the other has three nonremovable discs in the disc stack and can store up to 0.68 million 36-bit words of data (up to 5.5 million 36-bit words of data can be stored in an eight unit subsystem).

Fixed heads are used in the 8405 disc. Each disc surface has eight read/write head pads, each pad contains nine read/write elements (or channels). This arrangement provides 72 read/write channels per disc surface. There is a read/write channel for each track in the disc stack. Discs turn at the rate of 3600 revolutions per minute (rpm). Because the heads are fixed and switched electronically, access time is reduced to an average of 8.34 milliseconds.

2.2.2. 8430/8433 Disc Units

The 8430/8433 disc units are high speed direct or random-access storage devices containing a single removable disc pack. The upper portion of the disc unit cabinet contains the operator controls and removable disc pack, as well as the head access assembly of the unit. The center and bottom portions of the cabinet include the read/write and control circuitry, the drive motor, air filtration system, the power control panel, and the power supplies.

Twenty heads are mounted on a single access mechanism, 19 for writing and reading data, and one for reading servo information. The 20 heads move in unison between the periphery and the central area of each disc. Each data recording surface is assigned one of the 19 read/write heads; the servo surface has its own read head. The servo surface allows precise location and fast access to any of the 411 cylinder positions on the 411 data tracks of the 19 data recording surfaces. The accessing arm on the 8433 disc can assume any of the 815 positions on the 815 data tracks on each of the 19 data recording surfaces.

2.2.2.1. 8430 Disc Pack (F1230)

The F1230 disc pack installed by the operator on the drive is the storage medium of up to 17 million 36-bit words in 112-word record format. The F1230 disc packs are interchangeable between all 8430 disc units. Each disc pack weighs approximately 20 pounds and contains 10 discs (Figure 2-6). Nineteen of the 20 disc surfaces are used for data recording; one surface is used for servo reference information required in head positioning. Circular protective plates are mounted above the top disc, and under the bottom disc.

CAUTION

Damage to the spindle or the disc pack is possible if an attempt is made to mount an 8430 disc pack (F1230) in an 8433 disc unit.

2.2.2.2. 8433 Disc Pack (F1223)

The F1223 disc pack installed by the operator on the drive is the storage medium of up to 34.3 million 36-bit words in 112-word record format. The F1223 disc packs are interchangeable between all 8433 disc units. Each disc pack weighs approximately 20 pounds and contains 10 discs (Figure 2-6). Nineteen of the 20 disc surfaces are used for data recording; one surface is used for servo reference information required in head positioning. Circular protective plates are mounted above the top disc and under the bottom disc.

CAUTION

Damage to the spindle or the disc pack is possible if an attempt is made to mount an 8433 disc pack (F1223) in an 8430 disc unit.

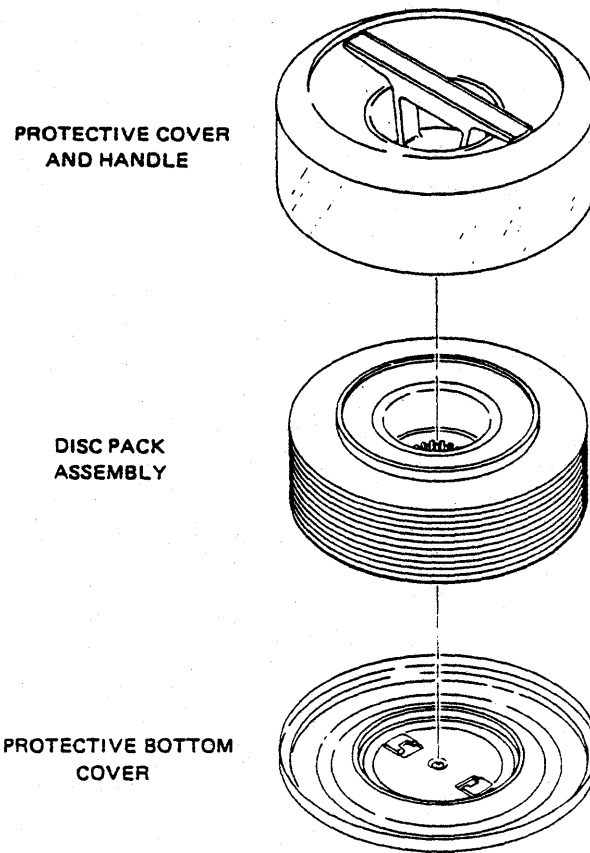

Figure 2-6. SPERRY UNIVAC Disc Pack — F1230 for 8430 Disc and F1223 for 8433 Disc

2.2.3. 5039 Storage Control Unit (Unbuffered)

The SCU provides the data, control interface, and byte to word compatibility between the disc units and the 1100 Series System I/O interface.

2.2.4. 5039 Storage Control Unit (Buffered)

The SCU provides the data, control interface, byte to word compatibility, and 1024 words of buffer storage between the disc units and the 1100 Series System I/O interface.

2.3. OPTIONAL FEATURES

The many different configurations possible with this disc subsystem require many optional features, some of the features are as follows:

- 16 Drive Addressing
- 8405 Capability
- Shared Peripheral Interface (SPI)
- Dual Access 8405
- Dual Access 8430
- Dual Access 8433

2.4. INTERFACE

The disc subsystem is attached to the 1100 Series Systems through general purpose I/O channels. Up to three SPI features may be added to provide a maximum of four shared channel access paths per SCU. Data is transferred between the 1100 Series Systems and the disc subsystem one word at a time. The SCU also provides for function chaining and command chaining.

3. Controls and Indicators

3.1. GENERAL

Operating controls and indicators of the SPERRY UNIVAC 8405/8430/8433 Disc Subsystem (disc subsystem) are located on the operator and control panels of the 8405 Fixed Head Disc (8405 FHD), the 8430 Disc Unit (8430 disc), and the 8433 Disc Unit (8433 disc) and on the operator, maintenance, and power control panels of the 5039 Storage Control Units (SCU).

3.2. 8405 FIXED HEAD DISC

The 8405 FHD (Figure 3-1) contains an operator control panel and power control panel.

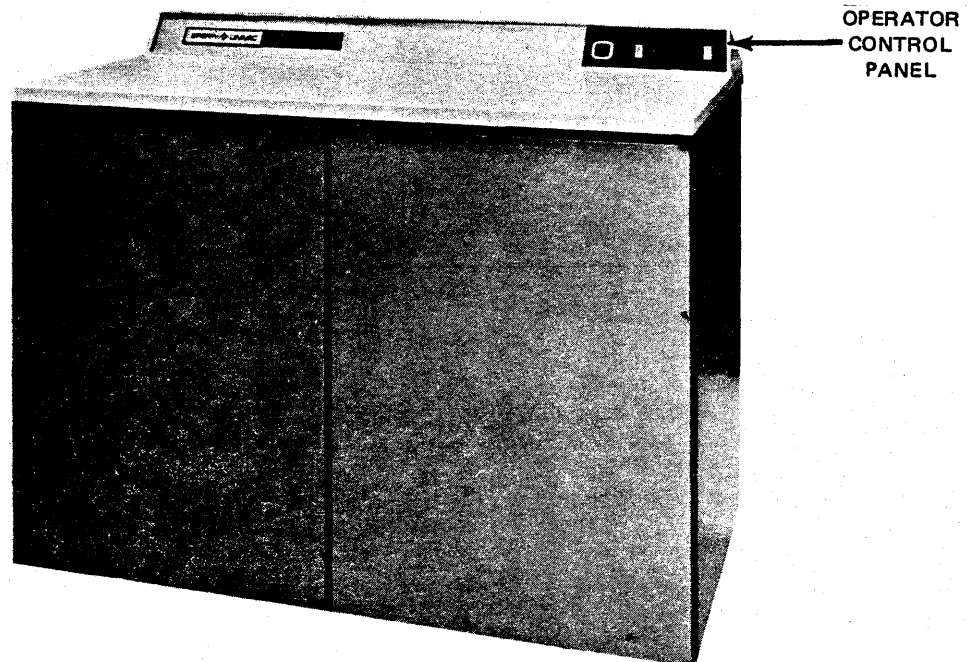

Figure 3-1. SPERRY UNIVAC 8405 Fixed Head Disc, Front View

3.2.1. Operator Control Panel

The operator control panel (Figure 3-2) is located at the top right of the 8405 FHD. The function of each switch and indicator on the operator control panel is described in Table 3-1.

3.2.2. Power Control Panel

Main power for the 8405 FHD is turned on at the power control panel (Figure 3-3). The power control panel is located on the lower left at the rear of the FHD (Figure 3-4). A circuit breaker (CB1) on the power control panel is set to the ON position to apply operating power to the unit, and an associated indicator adjacent to the circuit breaker illuminates to indicate that power is on.

In normal operation, the circuit breaker on the 8405 FHD power control panel is left in the ON position, and operation is controlled at the operator control panel.

There is an elapsed time meter located on the power control panel. The meter indicates the total time, in hours, that ac power has been applied to the 8405 FHD. The meter is for the use of Sperry Univac customer engineer.

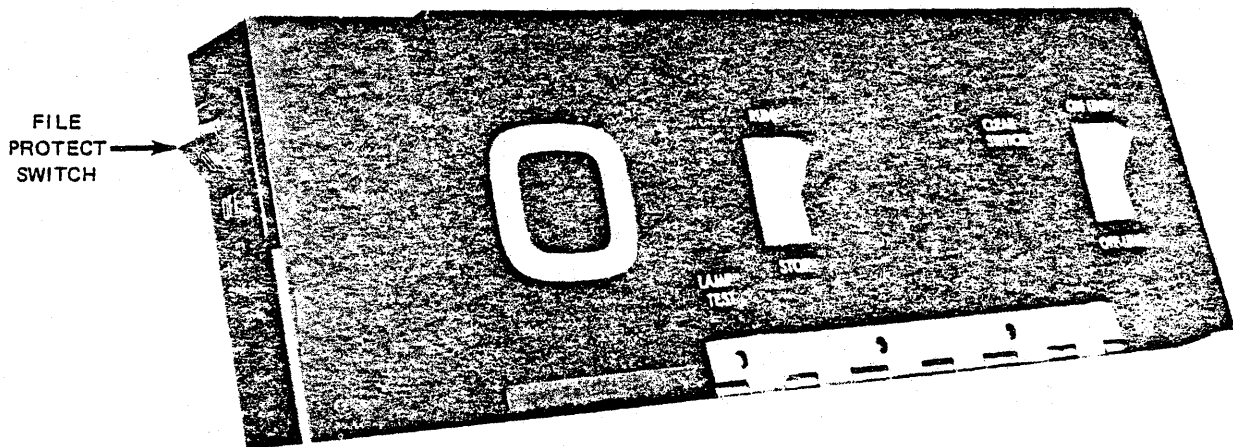

Figure 3-2. SPERRY UNIVAC 8405 Fixed Head Disc Operator Control Panel

Table 3-1. SPERRY UNIVAC 8405 Fixed Head Disc Operator Control Panel, Switches and Indicators

Switch/Indicator	Function
Device number indicator	Removable panel assembly indicates logical number assigned to FHD unit.
LAMP TEST pushbutton switch	When pressed, causes all indicator lamps to light for a lamp test.
RUN/STOP rocker switch	<p>Two-position rocker switch:</p> <ul style="list-style-type: none"> ■ When set to RUN position, causes FHD unit to start unit sequence operation. ■ When set to STOP position, causes read/write heads to be unloaded from the disc and the disc drive motor to be de-energized (disc stops turning).
RUN indicator (green)	Illuminates after read/write heads are loaded into a flying position near disc surface. Indicates that FHD is available for commands from SCU, and remains lit until RUN/STOP switch is placed in STOP position or unit power is turned off; visible only when lit.
STOP indicator (red)	When lit indicates RUN/STOP switch is placed in STOP position and circuit breaker on FHD power control panel is set to ON position. Indicates that power is present in FHD, visible only when lit.
FILE PROTECT indicator (yellow)	Indicates that FILE PROTECT switch has been placed in ON position to inhibit write operations on FHD. Indicator is visible only when lit; for use only by Sperry Univac customer engineer.
DEVICE CHECK indicator (red)	Indicates that an unsafe condition is detected in the FHD circuits. Safety circuits are reset by pressing CLEAR switch, and DEVICE CHECK indicator is extinguished. If indicator does not extinguish, maintenance is required; visible only when lit.
CLEAR pushbutton switch	Resets safety circuits when pressed and released. DEVICE CHECK indicator is extinguished.
TEMP CHECK indicator (red)	Illuminates when temperature in card library exceeds limit of normal operating range. Indicator warns of an overheat condition, which causes power in the FHD to go off. Indicator remains lit until the FHD has cooled or power is turned off; visible only when lit.
OFF-LINE indicator (white)	When lit indicates ON-LINE/OFF-LINE switch is set to OFF-LINE position to prevent processor access to data in the FHD; visible only when lit.
ON-LINE/OFF-LINE rocker switch	<p>Two-position rocker switch:</p> <ul style="list-style-type: none"> ■ When set to ON-LINE position, permits data in the FHD to be accessed by processor for read/write operations. ■ When set to OFF-LINE position, alerts SCU that the FHD is not available for normal use.
FILE PROTECT rocker switch	<p>Two-position rocker switch, located on the left side of the operator control panel; accessible only when top cover is open; for use only by Sperry Univac customer engineer:</p> <ul style="list-style-type: none"> ■ When set to ON position, inhibits write operations on the FHD. ■ When set to OFF position, permits normal operation.

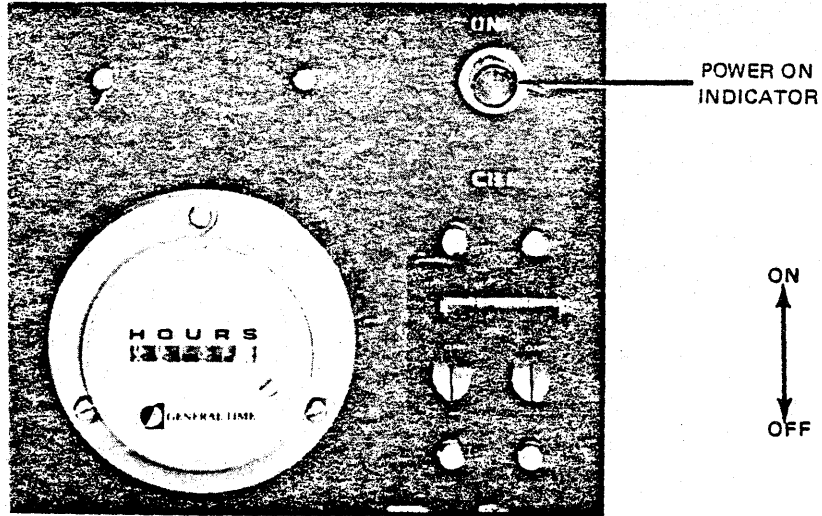

Figure 3-3. SPERRY UNIVAC 8405 Fixed Head Disc Power Control Panel

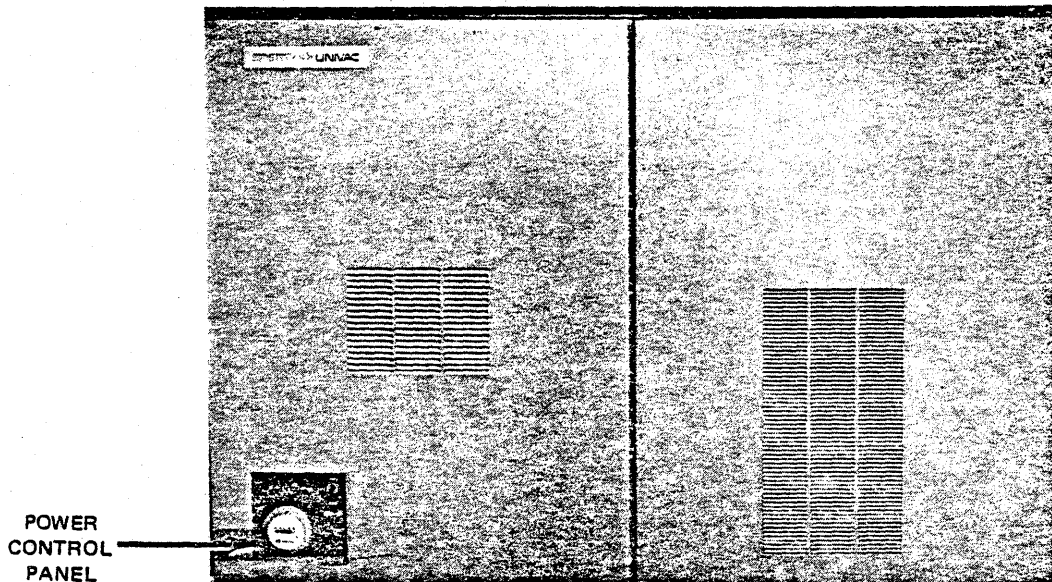

Figure 3-4. SPERRY UNIVAC 8405 Fixed Head Disc, Rear View

3.3. 8430/8433 DISC UNITS

The 8430/8433 discs (Figure 3-5) each contain an operator control panel. The panel is located on the top of the cabinet, and includes a module select plug which establishes the logical address of the disc. Selection is made by inserting a plug with the appropriate address of the disc.

OPERATOR CONTROL PANEL

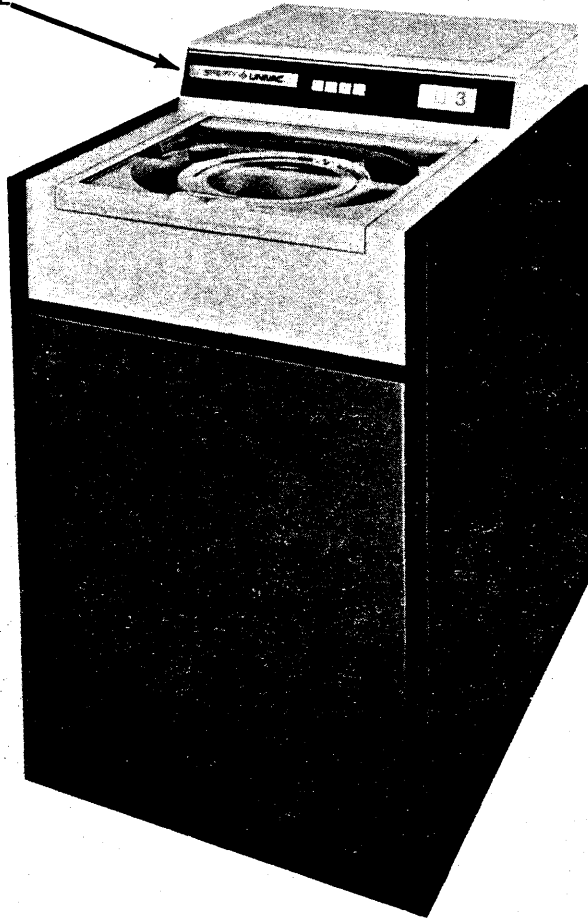

Figure 3-5. SPERRY UNIVAC 8430/8433 Disc Unit

3.3.1. Operator Control Panel

The operator control panel (Figure 3-6) is located on the top of the disc unit (Figure 3-5). The function of each of the switches and indicators is described in Table 3-2.

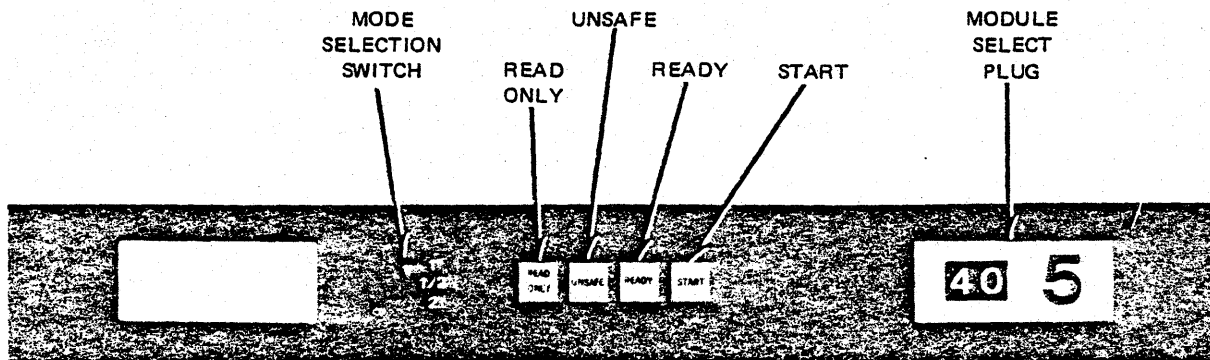

Figure 3-6. SPERRY UNIVAC 8430/8433 Operator Control Panel

Table 3-2. SPERRY UNIVAC 8430/8433 Disc Operator Control Panel, Switches and Indicators

Switch/Indicator	Function
START switch/indicator	<p>Switch functions only when source power is available, enabling signals are supplied, a disc pack is installed, and the operator access cover is closed.</p> <p>In the backlighted START position, the switch enables power to the spindle motor, initiating the brush cycle. At 70 percent of speed, the SEQUENCE ENABLE signal is provided for the next disc to start. At full speed, the heads are loaded.</p> <p>In the off (stop) position, the heads are unloaded, power is removed from the spindle motor, and the disc comes to a halt.</p>
READ ONLY switch/indicator	<p>In the backlighted READ ONLY position, the switch prohibits execution of write commands.</p> <p>In the off (read/write) position, the switch permits execution of both read and write commands.</p>
<p>Mode Selection switch (used with dual access feature):</p> <p>1/2 (Middle Position)</p> <p>1 (Up Position)</p> <p>2 (Down Position)</p>	<p>Accesses 1 and 2 of the disc unit are enabled, permitting dynamic operation from two SCUs.</p> <p>Access 1 is enabled, and access 2 is disabled.</p> <p>Access 2 is enabled, and access 1 is disabled.</p>
READY indicator	<p>When lit, indicates the power-on sequence is complete, the module select plug is installed, and the disc unit is ready to accept commands.</p>
UNSAFE indicator	<p>When lit, indicates the disc safety circuits detected an unsafe condition, and blocks the disc unit from accepting commands or performing write operations. (Certain unsafe conditions also cause the heads to retract from the pack.)</p>

3.4. 5039 STORAGE CONTROL UNIT (UNBUFFERED)

The unbuffered SCU is configured in a double cabinet with the control portion in one part and the Multi-Subsystem Adapter (MSA) portion in the other. The control portion contains an operator control panel for operator use, and a maintenance panel and power control panel for Sperry Univac customer engineer use. The MSA portion contains a maintenance panel and a power control panel. (See 3.4.2 and 3.4.3 for operator-oriented descriptions of the use of the switch/indicators on these panels.)

The operator control panel of the control portion of the SCU is located on the top of the maintenance panel next to the hinged side (Figure 3-7). By lifting the latch handle the operator can then swing open the gate assembly and gain access to the operator panel. The maintenance panel for the SCU is behind the front doors of the control portion of the unit, on the back of the hinged gate assembly; a latch releases the gate so it can swing open.

The maintenance panel and the power control panel of the MSA portion of the SCU is located behind the rear doors.

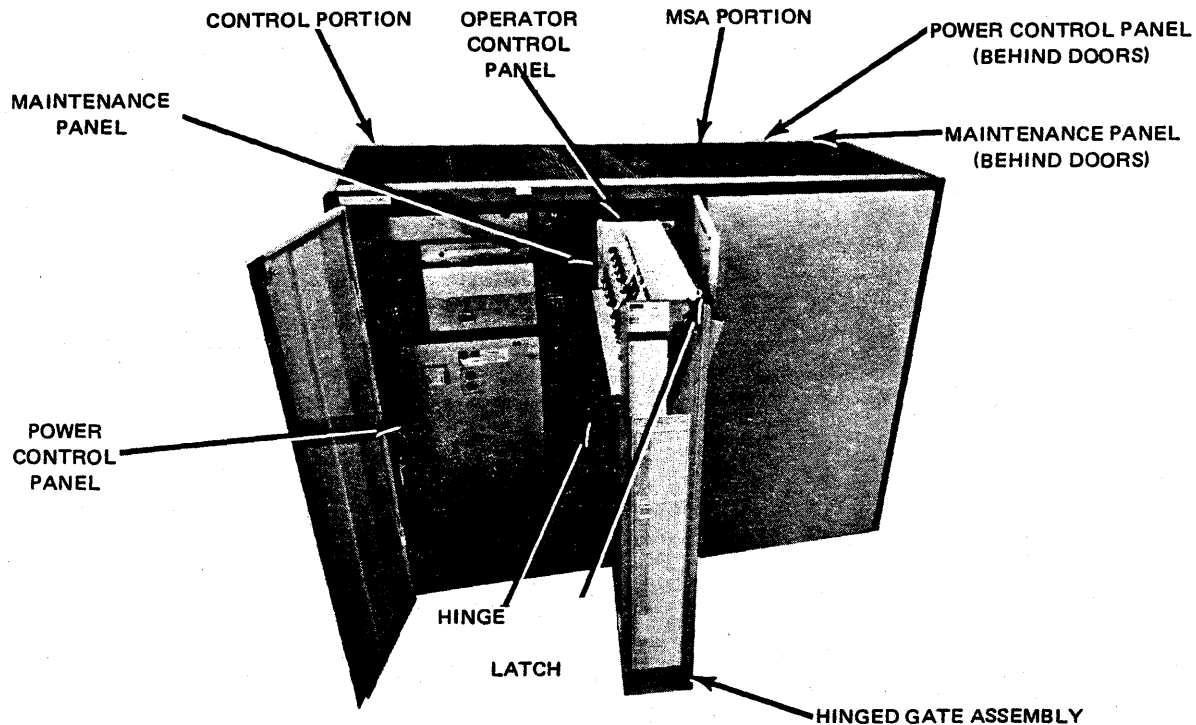

Figure 3-7. SPERRY UNIVAC 5039 Storage Control Unit (Unbuffered)

3.4.1. Operator Control Panel (Control Portion)

The operator control panel (Figure 3-8) includes up to four backlit switches and an indicator. The panel is located on the top of the hinged gate and is accessible by opening the hinged gate assembly. The functions of the switches and indicator are described in Table 3-3.

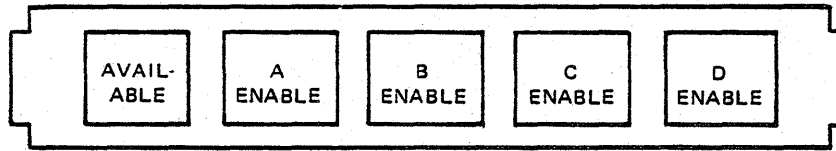

Figure 3-8. Operator Control Panel (Control Portion)

Table 3-3. Operator Control Panel, Switches and Indicators

Switch/Indicator	Function
ENABLE switch/indicator	<p>There is one switch for each channel interface (e.g., ENABLE A, ENABLE B, etc).</p> <p>In the backlighted ENABLE position, the switch establishes an online mode with the indicated I/O channel for the SCU and associated disc units after a software stop or wait state at the processor.</p> <p>In the off (Disable) position, the switch establishes an offline condition with the indicated I/O channel for the SCU, and associated disc units after a software stop or wait state at the processor.</p>
AVAILABLE indicator	<p>When on, indicates that SCU power is on; there is no internal check that prevents it from operation, and at least one channel interface is enabled.</p>

3.4.2. Maintenance Panel (MSA Portion)

The rear of the MSA portion of the SCU is shown with cabinet doors open in Figure 3-9. The small maintenance panel is at the upper rear center of the module (Figures 3-9 and 3-10). This panel, except for the DISP SEL (display select) thumbwheel, the DISP CLR (display clear), and the DA/BOOT ADDRESS pushbutton indicators, is for use by Sperry Univac customer engineers only.

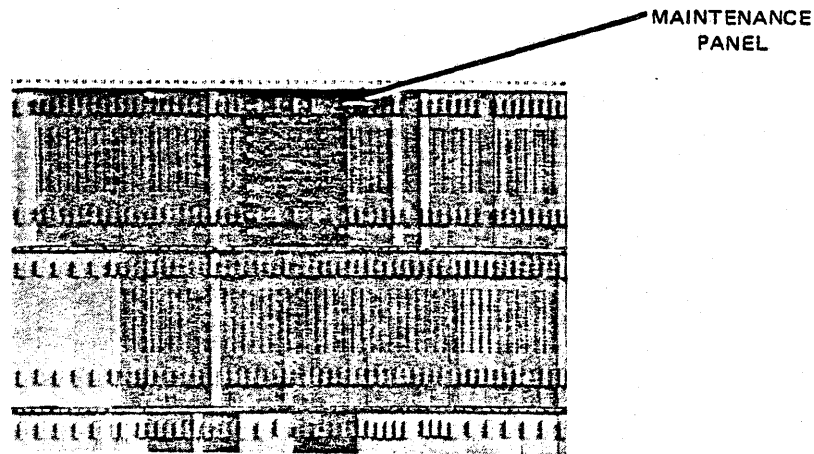

Figure 3-9. MSA Portion of SCU (Rear View Doors Open)

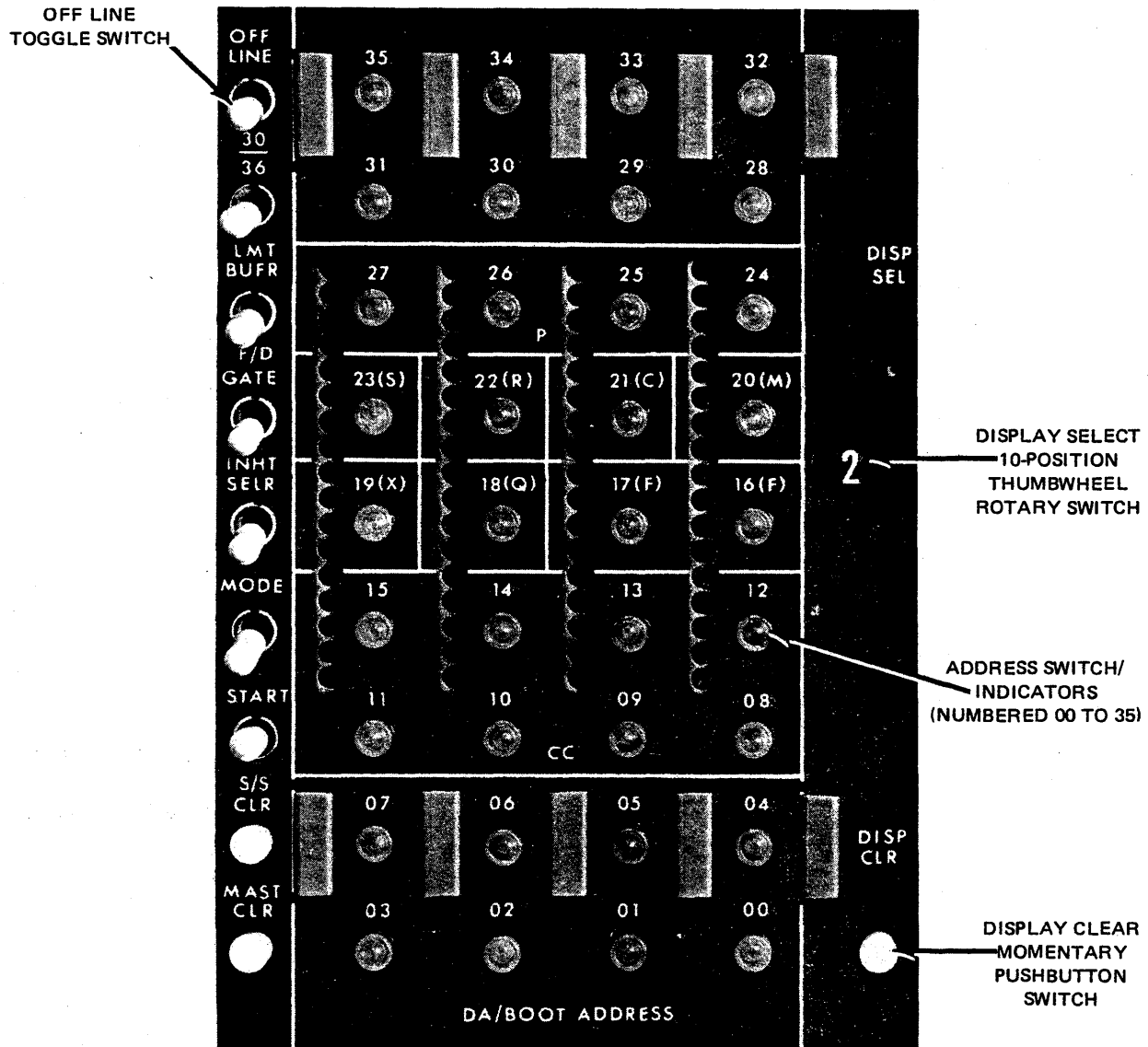

Figure 3-10. Maintenance Panel (MSA Portion)

3.4.2.1. Display Clear (DISP CLR) Switch

When the MSA is online, pressing the DISP CLR switch illuminates all indicators for a lamp test, and upon release, displays the register selected by the position of the DISP SEL thumbwheel.

3.4.2.2. Display Select (DISP SEL) Switch

The DISP SEL switch is a 10-position thumbwheel rotary switch using only positions 0 through 4. Each position selects a group of 36 signals for display. This thumbwheel, in conjunction with the 36 display indicators and 9 control switches, is used for maintenance by the Sperry Univac customer engineers. The operator only uses this switch when it is in position 0.

3.4.2.3. DA/BOOT ADDRESS Pushbutton Indicator Switches

The eight DA/BOOT ADDRESS pushbutton indicator switches (located in the center portion of the maintenance panel) permit the operator to set into the MSA the address of the peripheral device with which the MSA is to communicate. These switches are used for bootstrap operation; that is, to initially load or reload the address of the device into the MSA.

3.4.3. DC Regulator Panel (MSA Portion)

The rear of the MSA portion of the SCU is shown with cabinet doors open in Figure 3-11. Figure 3-12 shows the power supply panel and Table 3-4 describes each switch and indicator; the panels on the two regulators are identical.

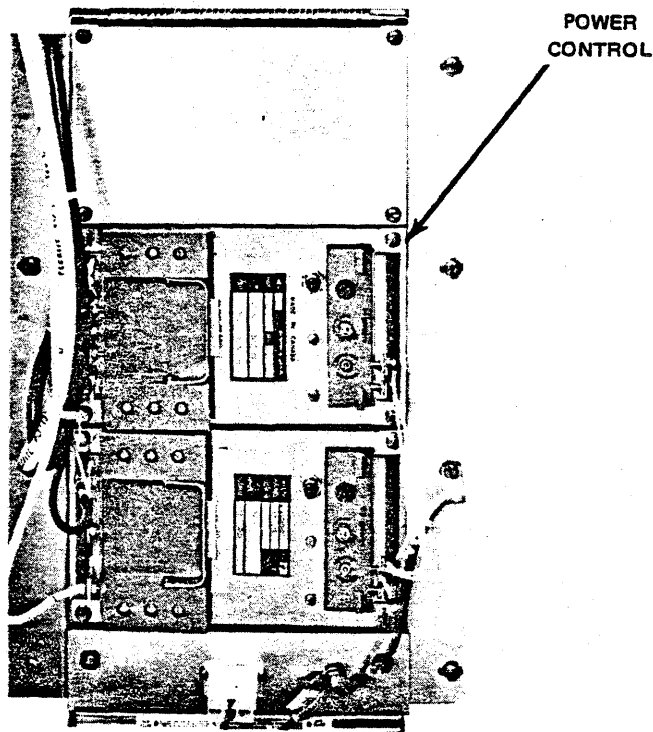

Figure 3-11. Power Control (Rear View Doors Open)

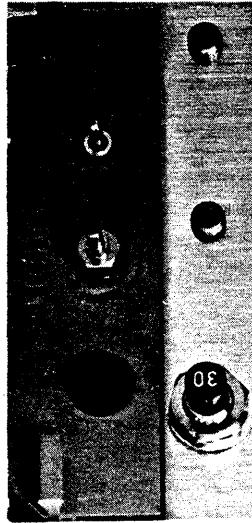

Figure 3-12. DC Regulator Panel

Table 3-4. DC Regulator Switches and Indicators

Switch/Indicator*	Function
DS01 ON indicator (green)	When lit, indicates that the regulator is on.
S01 marginal check switch	When up, causes the regulator output to assume a marginal high voltage. When centered, causes normal output voltage. When down, causes a marginal low output voltage. This switch is for Sperry Univac customer engineer use.
CB01 ON-OFF switch (circuit breaker)	When pressed to ON position, applies DC to the input of the regulator. Over-current causes circuit breaker to open and remove input DC voltage.
Voltage Adjustment	For adjusting DC output voltage. This adjustment is for Sperry Univac customer engineer use.

*Controls are the same on both regulators.

3.5. 5039 Storage Control Unit (Buffered)

The buffered SCU is configured in a double cabinet with the control portion in one part and the Multi-Subsystem Adapter (MSA) portion in the other. The control portion contains an operator control panel for operator use and maintenance panel and power control panel for Sperry Univac customer engineer use. The MSA portion contains an operator panel for operator use and maintenance panel and power supply panel for Sperry Univac customer engineer use.

The operator control panel of the control portion of the SCU is located on the top of the maintenance panel next to the hinged side (Figure 3-13). By lifting the latch handle the operator can then swing open the gate assembly and gain access to the operator panel. The maintenance panel is behind the front doors of the control portion of the unit, on the back of the hinged gate assembly; a latch releases the gate so it can swing open.

The operator control panel of the MSA portion of the SCU is located behind the front doors on the front of a hinged panel (Figure 3-13). The maintenance panel is located behind the front doors on the rear of a hinged panel; a latch releases the panel so it can swing open.

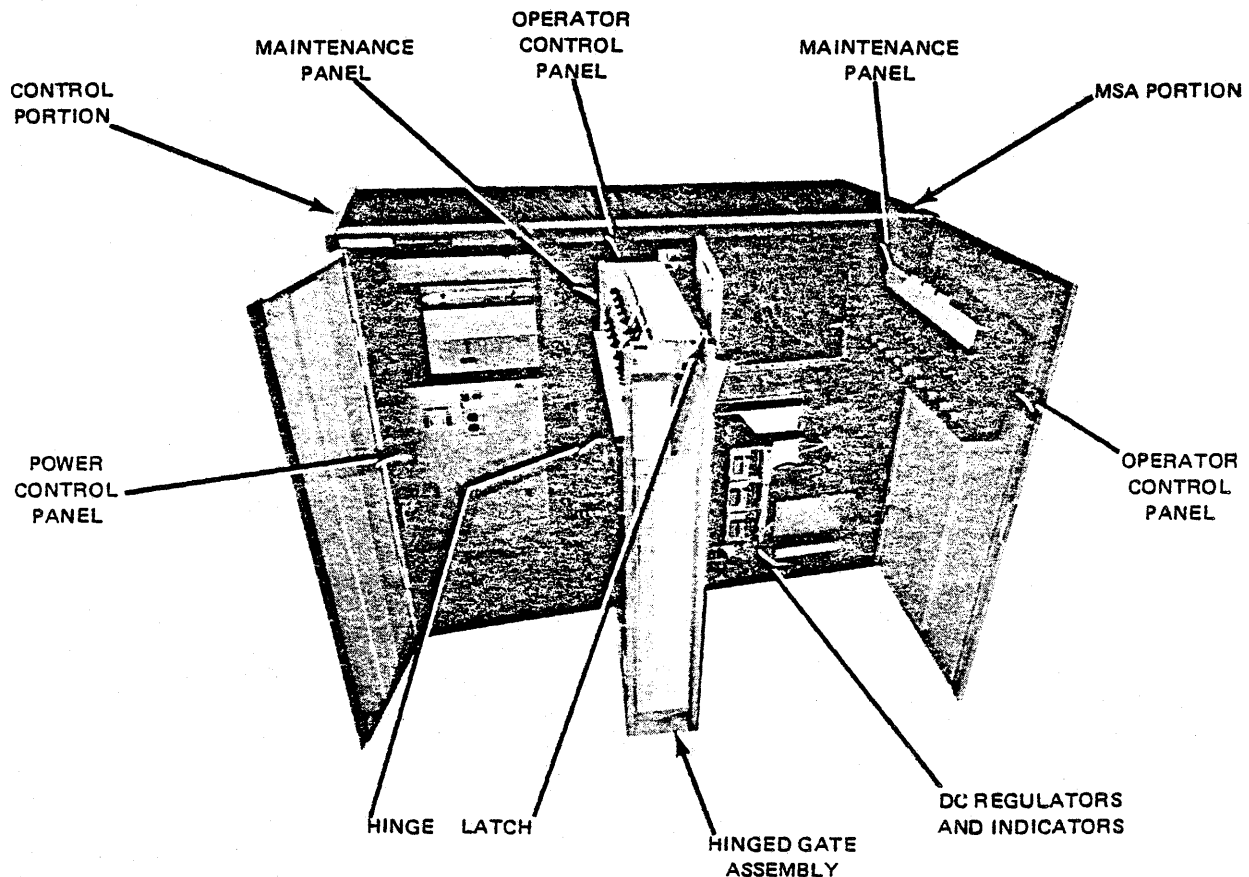

Figure 3-13. SPERRY UNIVAC 5039 Storage Control Unit (Buffered)

3.5.1. Operator Control Panel (Control Portion)

The operator control panel (Figure 3-14) includes up to four backlighted pushbutton switches and an indicator. The panel is located on the top of the hinged gate by the hinge and is accessible by opening the hinged gate assembly. The functions of the switches and indicator are described in Table 3-5.

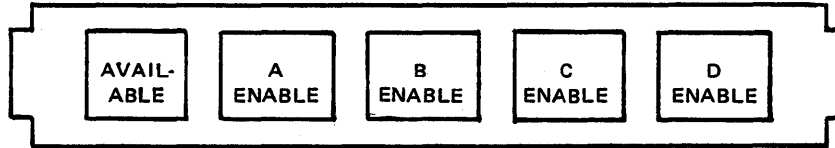

Figure 3-14. Operator Control Panel (Control Portion)

Table 3-5. Operator Control Panel, Switches and Indicators

Switch/Indicator	Function
ENABLE switch	<p>There is one switch for each channel interface (e.g., ENABLE A, ENABLE B, etc.).</p> <p>In the backlighted ENABLE position, the switch establishes an online mode with the indicated I/O channel for the SCU and associated disc units after a software stop or wait state at the processor.</p> <p>In the off (Disable) position, the switch establishes an offline condition with the indicated I/O channel for the SCU and associated disc units after a software stop or wait state at the processor.</p>
AVAILABLE indicator	<p>When on, indicates that SCU power is on; there is no internal check that prevents it from operation, and at least one channel interface is enabled.</p>

3.5.2. Operator Control Panel (MSA Portion)

The operator control panel (Figure 3-15) is accessed by opening the front doors of the MSA portion of the SCU. The panel includes two rotary switches for device address, one rotary switch for command code for initial load operation, two indicators for MSA run and MSA offline, five toggle switches for offline control and one push button switch for MSA clear. The functions of the switches and indicators are described in Table 3-6.

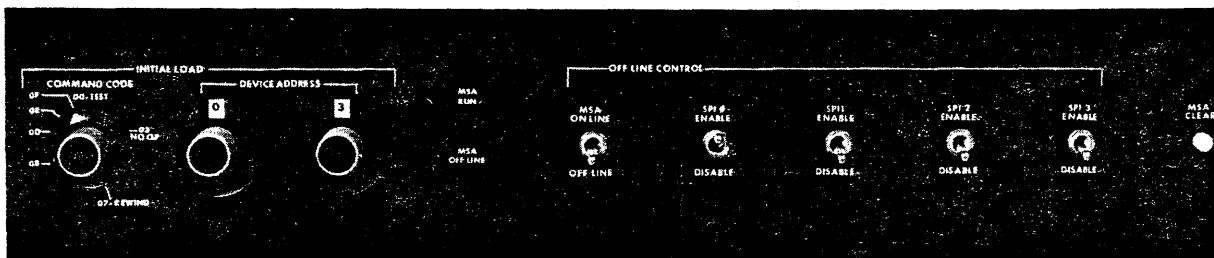

Figure 3-15. Operator Control Panel (MSA Portion)

Table 3-6. Operator Control Panel, Switches and Indicators

Switch/Indicator	Function
<p>Initial Load</p> <p>COMMAND CODE* rotary switch:</p> <p>00 TEST</p> <p>03 NO OP</p> <p>07 REWIND</p> <p>OB</p> <p>OD</p> <p>OE</p> <p>OF</p> <p>DEVICE ADDRESS 2 rotary switches</p>	<p>Used with SCU to test device prior to initiation of the bootstrap operation.*</p> <p>Not used</p> <p>Not used with disc subsystem (rewind for tape subsystem).</p> <p>Not used with SCU.</p> <p>Not used with SCU.</p> <p>Not used with SCU.</p> <p>Not used with SCU.</p> <p>These switches provide the Device Address for the devices to be initial loaded.</p>
<p>MSA RUN indicator</p> <p>MSA OFFLINE indicator</p>	<p>When lit indicates that the MSA is operating online.</p> <p>When lit indicates that the MSA is in an offline condition.</p>
<p>Offline Control</p> <p>MSA ONLINE OFFLINE toggle switch</p> <p>SPI 0 ENABLE DISABLE toggle switch</p> <p>SPI 1 ENABLE DISABLE toggle switch</p> <p>SPI 2 ENABLE DISABLE toggle switch</p> <p>SPI 3 ENABLE DISABLE toggle switch</p>	<p>In the up position, places the MSA in an online condition. In the down position, places the MSA in an offline condition.</p> <p>In the up position, enables the SPI. In the down position, disables the SPI.</p> <p>Same as SPI 0.</p> <p>Same as SPI 0.</p> <p>Same as SPI0.</p>
<p>MSA CLEAR push button switch</p>	<p>Press switch momentarily to clear the MSA in offline condition.</p>

*The bootstrap operation will not be initiated if other than I/O Test is selected when loading from disc units.

4. Operating Procedures

4.1. GENERAL

Operation of the SPERRY UNIVAC 8405/8430/8433 Disc Subsystem (disc subsystem) includes turning power on and off (as required), placing individual units (or the subsystem itself) online and offline, loading and unloading disc packs in the disc units, system initial loading (bootstrap) and SCU microprogram loading of the 5039 Storage Control Unit (SCU), and observing and responding to any fault conditions that occur during daily operation.

4.2. SUBSYSTEM POWER TURN ON

Normally, the disc subsystem will have been disabled (not completely turned off) as in an end-of-day operation. To return the disc subsystem to operational status, the operator should reset the power switches.

If the disc subsystem is in a completely turned-off condition (no power is present in either the SCUs or the disc units), it should be placed in the offline condition by the Sperry Univac customer engineer. At times, however, the operator may be required to initiate operations from a completely shutdown condition (see following paragraphs by individual unit). In the offline condition, power is present in all units. The procedure to place an offline disc subsystem online is described further in 4.5.

The following paragraphs provide power turn-on procedures for the disc units and SCU.

4.2.1. 8405 Fixed Head Disc

If the 8405 FHD is in a completely turned-off condition, it should be placed in the offline condition by the Sperry Univac customer engineer. At times, however, the operator may be required to initiate operations from a completely shutdown condition.

With all power to the 8405 FHD off, the recommended turn-on procedure is as follows:

1. Ensure that no maintenance is being performed on the unit and all covers are closed.
2. At the power control panel (Figures 3-3 and 3-4), set the circuit breaker to the ON position. The indicator will light to indicate that power is on.
3. Press the RUN switch on the operator control panel.

4.2.2. 8430/8433 Disc Units

If the 8430/8433 disc is in a completely turned-off condition, see 4.2.3 or 4.2.4. Power is supplied to the 8430/8433 disc from the SCU power control panel which is used only by the Sperry Univac customer engineer.

4.2.3. SCU (Unbuffered)

If the SCU is in a completely turned-off condition, it should first be placed in the offline condition, (see 4.6.4).

4.2.3.1. SCU Control Portion

The power control panel is for use of the Sperry Univac customer engineer only.

4.2.3.2. SCU MSA Portion

Initial unit power turn on is usually performed by the Sperry Univac customer engineer. At times, however, the operator may be required to initiate operations from a partially shutdown condition.

With all dc power to the MSA portion of the SCU off, the recommended turn-on procedure is as follows:

1. Ensure that no maintenance is being performed on the unit and all covers are closed.
2. Ensure that power is still on in the control portion of the SCU.
3. At each dc regulator panel (Figures 3-11 and 3-12):
 - a. On the upper dc regulator panel, set CB01 circuit breaker to ON (press button).
 - b. Green indicator DS01 lights.
 - c. On the lower dc regulator panel, set CB01 circuit breaker to ON (press button).
 - d. Green indicator DS01 lights.

4.2.4. SCU (Buffered)

If the SCU is in a completely turned-off condition, it should be placed in the offline condition, (see 4.6.5).

4.2.4.1. SCU Control Portion

The power control panel is for use of the Sperry Univac customer engineer only.

4.2.4.2. SCU MSA Portion

The power control panel is for use of the Sperry Univac customer engineer only.

4.3. SUBSYSTEM POWER TURN OFF

Only partial power turn off of the disc subsystem is required at the close of regular day-to-day operations. For partial power turn off, ensure that the ac power controls located on the power control and power distribution panels of the disc subsystem units remain off.

Complete power turn off (accomplished by the Sperry Univac customer engineer) is necessary only when extensive maintenance is to be performed or when the subsystem is to be shut down for a prolonged period.

The following paragraphs provide power turn-off procedures for the disc units and the SCU.

4.3.1. 8405 Fixed Head Disc

The turn off of the 8405 FHD is performed by reversing the order of the turn-on procedure. This procedure removes power from the 8405 FHD cabinet. If the 8405 FHD is turned off because of some abnormal condition, check the power indicator light on the power control panel. If the indicator light is out and the circuit breaker is in the ON position, move the circuit breaker to OFF and then to ON, if indicator lights remains OFF, call the Sperry Univac customer engineer.

4.3.2. 8430/8433 Disc Units

Power turn off is accomplished by the Sperry Univac customer engineer at the SCU.

4.3.3. SCU (Unbuffered)

Power turn off to a completely turned-off condition should be accomplished by the Sperry Univac customer engineer.

4.3.3.1. SCU Control Portion

The power control panel is for use of the Sperry Univac customer engineer.

4.3.3.2. SCU MSA Portion

The turn off of dc power is performed by reversing the order of the turn-on procedure. This procedure will remove dc power from the MSA portion of the SCU cabinet. If dc power is turned off because of some abnormal condition, check the DS01 indicator lights (Figure 3-11 and 3-12) on both dc regulator panels. If an indicator light is out, check the corresponding CB01 circuit breaker, set circuit breaker switch to OFF (out) then set to ON (in). If breaker trips again, perform turn-off procedure and then call Sperry Univac customer engineer.

4.3.4. SCU (Buffered)

Power turn off to a completely turned-off condition should be accomplished by the Sperry Univac customer engineer.

4.3.4.1. SCU Control Portion

The power control panel is for use of the Sperry Univac customer engineer only.

4.3.4.2. SCU MSA Portion

The power control panel is for use of the Sperry Univac customer engineer only.

4.4. DISC UNIT OPERATION

The 8430 and 8433 discs utilize removable disc packs and are loaded and unloaded as described in the following paragraphs. The disc packs for the 8430 disc units are interchangeable with all other 8430 disc units. The disc packs for the 8433 disc units are interchangeable with all other 8433 disc units. A disc pack for 8430 disc units cannot be used on 8433 disc units, likewise a disc pack for 8433 disc units cannot be used on 8430 disc units.

CAUTION

Damage to the spindle or the disc pack is possible if an attempt is made to mount the wrong disc pack in a disc unit.

4.4.1. Loading The Disc Unit

Disc packs must be protected against improper handling and environmental abuse. The operator should use the instructions provided by the disc pack manufacturer as a reference source.

The disc pack, conditioned to room temperature before installation, is carried by the built-in handle on the top cover. A self-locking device in the handle permits removal of the disc pack top cover only when the pack is mounted on the drive. Other precautions are listed in subsequent paragraphs.

4.4.1.1. Loading Precautions

Observe the following loading precautions.

1. Do not drop the disc pack onto the disc drive spindle; the first threads of the spindle may be damaged.
2. Ensure that the protective cover is completely released from the disc pack before attempting removal; an upward pull applied to the driveshaft lock can damage the threads.
3. Avoid excessive loading torque; extra clockwise twisting to ensure that the disc pack is locked on the shaft is not necessary and can damage the spindle threads.

4.4.1.2. Loading The Disc Pack

Loading the disc pack in preparation for operation requires operator attention to both the operator controls and the disc pack. Load the disc pack as follows:

1. Press the START switch to its unlatched position. Note that the switch backlight goes out.

NOTE:

A solenoid-operated latch locks the operator cover closed until the disc pack rotation stops.

2. Push and release the disc unit cover latch. The cover will spring open (Figure 4-1). Slide the cover straight back to fully expose the spindle area (Figure 4-2).
3. Remove the disc pack bottom cover by squeezing the bottom cover release mechanism in the top-cover handle.
4. Place the disc pack on the spindle.
5. Turn the disc pack top-cover handle in a clockwise direction until it comes to a full stop. Continue to turn the handle, even though the cover may disengage, to ensure that the full stop point is reached and the pack-on switch is closed.
6. Remove the disc pack top cover.
7. Close and latch the disc unit cover. Store the disc pack top and bottom covers in a designated clean area.
8. Press the START switch to its latched-down (backlighted) position.

4.4.2. Unloading The Disc Unit

4.4.2.1. Unloading Precautions

Observe the following unloading precautions.

1. To prevent damage to the threads, do not attempt to lift the disc pack from the spindle threads until the pack is completely disengaged.
2. A clicking sound can be heard when the spindle releases the disc pack (after the pack is turned counter-clockwise for removal); do not permit more than one or two clicks before removing the pack or damage to the threads can result.
3. Store the disc pack in the same environment as the disc unit.

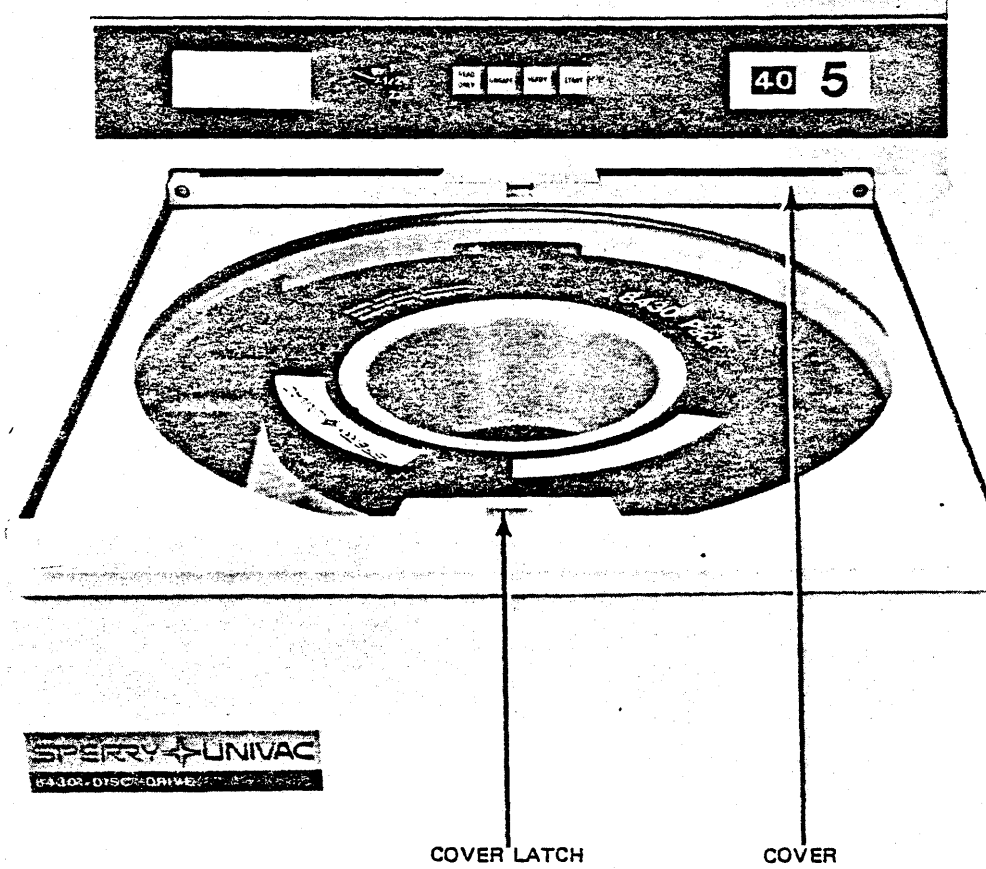

Figure 4-1. Disc Unit With Operator Cover Open for Disc Pack Access

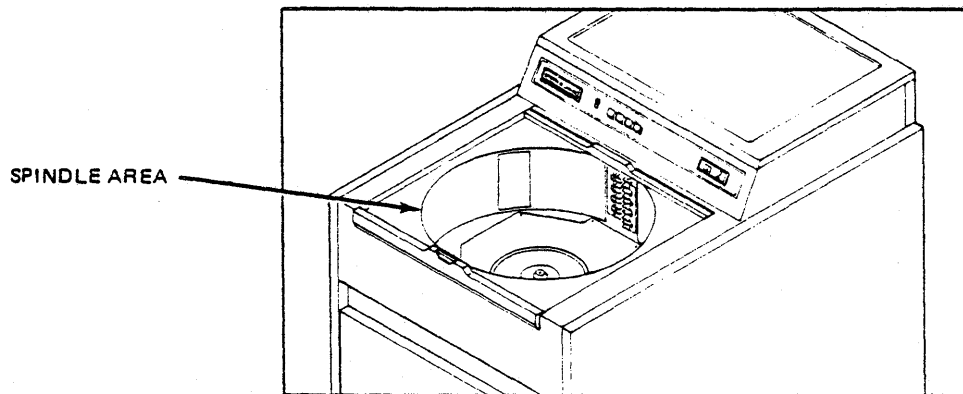

Figure 4-2. Disc Pack Well in Disc Unit

4.4.2.2. Unloading The Disc Pack

Unload the disc pack as follows:

1. Press the START switch to its unlatched position. Note that the switch backlight goes out.

NOTE:

A solenoid-operated latch locks the operator cover closed until the disc pack rotation stops.

2. When pack rotation stops, release the operator cover latch and push the cover straight back to fully expose the spindle area.
3. Position the disc pack cover over the pack.
4. Turn the cover counterclockwise for two full turns so that the cover becomes securely fastened to the disc pack, thus forming an integral unit.
5. Remove the disc pack by its top-cover handle.
6. Immediately attach the bottom cover to create a positive dust seal, and store in a designated area.
7. Close and latch the operator cover.

4.5. PLACING DISC UNIT OR SUBSYSTEM ONLINE

When the disc subsystem is online, a single disc unit may be placed online by the following procedures for the specific disc unit.

4.5.1. 8405 Fixed Head Disc

With the disc subsystem online, a single 8405 FHD is placed online as follows:

1. Press RUN/STOP rocker switch, located on the FHD operator control panel, to the RUN position. Note that the RUN indicator is illuminated and the blowers have started.

CAUTION

The FHD must operate with all cabinet doors and top covers closed to maintain a clean-air atmosphere in the cabinet. It is recommended that all covers be closed and blowers operated for at least 20 minutes prior to placing the FHD unit online.

2. Press ON-LINE/OFF-LINE rocker switch, located on the FHD operator control panel, to the ON-LINE position.

4.5.2. 8430/8433 Disc Units

With the disc subsystem online, a single 8430/8433 disc is placed online as follows:

1. At a disc unit, remove the module select plug.
2. Install the correct disc pack (see 4.4), if necessary, close and latch the sliding operator cover, then press the START switch to its latched-down (backlighted) position.

CAUTION

Damage to the spindle or disc pack is possible if an attempt is made to mount the wrong disc pack in a disc unit.

3. At the processor console, provide the Executive System with the address of the disc unit as notice that the unit will be placed online.
4. At the disc unit, reinstall the module select plug. Note that the READY indicator lights.

4.5.3. SCU (Unbuffered)

To place an offline, powered-up disc subsystem online:

1. Place the disc units online as described in 4.5.1 and 4.5.2.
2. At the processor console, provide the Executive System with the addresses of the SCUs and each disc unit to be placed online.

4.5.3.1. SCU Control Portion

After address loading of the MSA portion of the SCU, press the ENABLE switch for each channel to be used to its latched-down (backlighted) position. Note that the AVAILABLE indicator lights.

4.5.3.2. SCU MSA Portion

For initial loading or bootstrap operation the operator must insert into the MSA the address of the device with which it is to communicate. This is accomplished at the maintenance panel (MSA portion of the SCU cabinet).

1. Set display select (DISP SEL) thumbwheel to 0.
2. Press DISP CLEAR pushbutton.
3. Select desired device address and set into DA/BOOT ADDRESS switches in binary code by momentarily pressing the required pushbutton indicators.

4.5.4. SCU (Buffered)

To place an offline, powered-up disc subsystem online:

1. Place the disc units online as described in 4.5.1 and 4.5.2.
2. At the processor console, provide the Executive System with the addresses of the SCUs and each disc unit to be placed online.

4.5.4.1. SCU Control Portion

After address loading of the MSA portion of the SCU, press the ENABLE switch for each channel to be used to its latched-down (backlighted) position. Note that the AVAILABLE indicator lights.

4.5.4.2. SCU MSA Portion

For initial loading or bootstrap operation the operator must insert into the MSA the address of the device with which it is to communicate. This is accomplished at the operator's panel (MSA portion of the SCU cabinet).

1. Set MSA toggle switch to OFFLINE.
2. Set the COMMAND CODE rotary switch to 00 TEST.
3. Select desired device address by using DEVICE ADDRESS rotary switches.
4. Set SPI toggle switches to ENABLE for each channel to be used.
5. Operate the MSA CLEAR pushbutton.
6. Set MSA toggle switch to ONLINE.

4.6. PLACING DISC UNIT OR SUBSYSTEM OFFLINE

To place an online disc unit offline, follow the procedures discussed below for the specific disc unit.

4.6.1. 8405 Fixed Head Disc

To place an online 8405 FHD offline:

1. At the processor console, provide the Executive System with the address of the disc to be placed offline.
2. Press ON-LINE/OFF-LINE rocker switch, located on the disc unit operator control panel to the OFF-LINE position. Note that the OFF-LINE indicator lights.
3. Press RUN/STOP rocker switch to STOP position. Note that the STOP indicator lights.

4.6.2. 8430/8433 Disc Units

To place an online 8430/8433 disc offline:

1. At the processor console, provide the Executive System with the address of the disc to be placed offline.
2. At the disc unit, press the START switch to its unlatched position. Note that the START and READY indicators go out.

4.6.3. SCU (Unbuffered)

To place an online disc subsystem offline:

1. At the processor console, provide the Executive System with the addresses of the SCUs, and disc units to be placed offline.
2. At the control portion of the SCU, press the ENABLE switch for each channel interface to its unlatched position. Note that the ENABLE and AVAILABLE indicators go out.
3. At each disc unit, place the unit offline as described in 4.6.1 and 4.6.2.

4.6.4. SCU (Buffered)

To place an online disc subsystem offline:

1. At the processor console, provide the Executive System with the addresses of the SCUs and disc units to be placed offline.
2. At the control portion of the SCU press the ENABLE switch for each channel interface to its unlatched position. Note that the ENABLE and AVAILABLE indicators go out.
3. At the MSA portion of the SCU place the MSA toggle switch to OFFLINE.
4. At each disc unit, place the unit offline as described in 4.6.1 and 4.6.2.

4.7. RECOVERY PROCEDURES

Operator response to an indicated fault is limited to observing the indications and, in most cases, making one or more efforts to restart the halted operation.

4.7.1. 8405 Fixed Head Disc Recovery Procedure

The fault indications an operator can observe, and the causes and recommended operation actions for the 8405 FHD are listed in Table 4-1.

Table 4-1 does not call out faults resulting solely from burned out indicator bulbs or lamp drivers. If the indicator does not light, but the proper function occurs, notify the Sperry Univac customer engineer of the condition so it can be corrected at a convenient time.

Table 4-1. SPERRY UNIVAC 8405 Fixed Head Disc Operator Recovery Procedures

Indication	Probable Cause	Operator Actions
RUN indicator does not light (after 2-minute delay) when RUN/STOP switch is set to RUN position (Lamp test indicates bulb is good.)	An unsafe condition exists in the power-up sequencing of the subsystem.	Notify Sperry Univac customer engineer.
STOP indicator does not light before placing unit in RUN mode (Lamp test indicates bulb is good.)	Main circuit breaker on disc unit power control panel is not set to ON position; or circuit breaker has tripped.	If blower motors on disc unit are not operating, set main circuit breaker to ON position. Check facility circuit breakers supplying power to subsystem in this installation, and set to ON position, if necessary. If main circuit breaker on disc unit has tripped, contact Sperry Univac customer engineer.
FILE PROTECT indicator lit	FILE PROTECT switch beneath top cover has been left to ON position.	Inform Sperry Univac customer engineer of lit FILE PROTECT indicator and check whether maintenance is being performed on disc unit.
DEVICE CHECK indicator lit	An unsafe condition has been detected in the subsystem.	Press CLEAR switch and note that DEVICE CHECK indicator extinguishes. If it does not extinguish, contact Sperry Univac customer engineer.
TEMP CHECK indicator lit	Temperature within the unit is approaching an overheat condition.	<ol style="list-style-type: none"> 1. Set STOP/RUN switch to STOP position. 2. After approximately 15 minutes, press CLEAR switch. 3. If TEMP CHECK indicator remains lit, or becomes lit after a short period, contact Sperry Univac customer engineer.

4.7.2. 8430/8433 Disc Unit Recovery Procedure

The fault indications an operator can observe, and the causes and recommended operator actions for the 8430/8433 disc are listed in Table 4-2.

Table 4-2 does not call out faults resulting solely from burned out indicator bulbs or lamp drivers. If the indicator does not light, but the proper function occurs, notify the Sperry Univac customer engineer of the condition so it can be corrected at a convenient time.

4.7.3. SCU Recovery Procedure

Recovery procedures to be performed by the operator are limited to those making use of the switches and controls within the SCU cabinet. Table 4-3 lists the operator action required to return the SCU to online operation after a malfunction.

Table 4-2. SPERRY UNIVAC 8430/8433 Disc Unit Operator Recovery Procedures

Indication	Probable Cause	Operator Action
SCU AVAILABLE indicator off (and no communication with processor)	Control unit-channel interface disabled.	<ol style="list-style-type: none"> 1. Attempt to enable interface with ENABLE switch. 2. Notify Sperry Univac customer engineer.
READY indicator off	Disc unit is turned off, system power is down, seek incomplete occurred, or module select plug is removed.	<ol style="list-style-type: none"> 1. Check module select plug for proper installation. 2. Restart drive with START switch. 3. Notify Sperry Univac customer engineer.
UNSAFE indicator on	One of several possible unsafe conditions in disc.	<ol style="list-style-type: none"> 1. Restart disc with START switch. UNSAFE indicator will go out and stay off if problem is corrected. 2. Notify Sperry Univac customer engineer.

Table 4-3. SCU Operator Recovery Procedures

Indication	Probable Cause	Operator Action
Control Portion of SCU		
POWER MAINS Circuit Breaker tripped	Current capacity of circuit breakers (20 amperes) exceeded	Ascertain, if possible, why the breaker tripped. Perform turn-off procedure. Restore circuit breaker by first setting to OFF (down) and then to ON (up). If nothing obvious appears to have caused the circuit breaker to be tripped, set POWER MAINS circuit breaker switch to position OFF (down); then set to position ON (up). If circuit breaker trips again, call Sperry Univac customer engineer. If circuit breaker does not trip, continue with turn-on procedure. If, when performing turn on procedure, breaker trips, determine and note which switch, when set to ON position, caused breaker to trip. Perform turn-off procedure and call Sperry Univac customer engineer.
EARLY WARNING alarm sounding	(Early Warning) Cabinet internal temperature exceeds 50°C (Over Heat) Cabinet internal temperature exceeds 57°C	Move ALARM OVERRIDE switch (down) to silence alarm. Check blower system filters to ascertain possible cause of overheating. If alarm continues after 30 seconds, perform turn-off procedure and call Sperry Univac customer engineer.
MSA Portion of SCU		
CB01 Circuit Breaker tripped Upper	Current capacity of circuit breaker is exceeded.	Set circuit breaker switch to OFF (out) then set to ON (in). If breaker trips again, perform turn-off procedure and call Sperry Univac customer engineer.
CB01 Circuit Breaker tripped Lower	Current capacity of circuit breaker is exceeded.	Set circuit breaker switch to OFF (out) then set to ON (in). If breaker trips again, perform turn-off procedure and call Sperry Univac customer engineer.

5. Operator Performed Maintenance

5.1. GENERAL

Preventive maintenance is performed by Sperry Univac customer engineers on a periodic scheduled basis for the SPERRY UNIVAC 8405/8430/8433 Disc Subsystem (disc subsystem). Therefore, involvement of operating personnel in maintenance is limited as specified in the following paragraphs.

5.2. 8405 FIXED HEAD DISC

Preventive maintenance is performed by Sperry Univac customer engineers on a periodic scheduled basis for the 8405 FHD. Therefore, operating personnel are not required to adjust, clean, or replace any internal items in the disc. External cleaning may be performed as suggested by the local Sperry Univac maintenance organization.

Operator performed maintenance of the disc is limited to attempting to restart the disc when the indications stated in Table 4-1 occur.

5.3. 8430/8433 DISC UNIT

Preventive maintenance is performed by Sperry Univac customer engineers on a periodic scheduled basis for the 8430/8433 disc unit. Therefore, operating personnel are not required to adjust, clean, or replace any internal items in the disc. External cleaning may be performed as suggested by the local Sperry Univac maintenance organization.

Operator performed maintenance of the disc is limited to attempting to restart the disc when the indications stated in Table 4-2 occur.

5.4. SCU

Preventive maintenance is performed by Sperry Univac customer engineers on a periodic scheduled basis for the SCU. Therefore, involvement of operating personnel in maintenance is limited as specified in the following paragraphs.

5.4.1. SCU Control Portion

External cleaning may be performed as suggested by the local Sperry Univac maintenance organization.

Operator performed maintenance of the SCU is limited to attempting to restart the SCU when the indications stated in Table 4-3 occur.

5.4.2. SCU MSA Portion

External cleaning may be performed as suggested by the local Sperry Univac maintenance organization.

The operator may replace defective indicator lamps and air filters. The operator may also attempt restarting the SCU when the indications stated in Table 4-3 occur. Maintenance other than these items requires a Sperry Univac customer engineer.

5.4.2.1. Indicator Lamp Removal and Replacement

The following indicator lamps may be replaced by the operator:

- At upper dc regulator panel, DS01 indicator lamp
- At lower dc regulator panel, DS01 indicator lamp

To remove indicator lamp:

1. Press face of indicator and turn counterclockwise 1/8 turn.
2. Grasp tip of indicator and pull out.
3. Grasp flange on lamp base and remove lamp from indicator cap.

To replace indicator lamp:

1. Slide lamp into indicator cap.
2. Align indicator cap with lamp socket. Press lightly and rotate clockwise until bayonet tips fall into grooves in the socket. Continue to press lightly and rotate 1/8 turn. Do not use tools such as pliers on the indicator cap.

5.4.2.2. Air Filter Removal, Replacement, and Cleaning

There is one air filter located below the fans at the bottom of the module.

1. Remove air filter as follows:
 - a. Make sure unit is in a powered-down condition.
 - b. Open front cabinet doors.
 - c. Grasp edge of filter and pull out.

2. Clean air filter as follows:
 - a. Vacuum the glass fiber air filter from the intake side only to remove dust.
 - b. Wash filter under flowing water. Do not use solvent, cleaners, or oil to wash filter.
 - c. Rinse filter under flowing water, warm or cold. Tap filter lightly to remove excess water. Do not bang filter.
3. Replace air filter as follows:
 - a. Slide filter into channel, with air flow arrow pointing up, at bottom of air chamber assembly.
 - b. Close front cabinet doors.

USER COMMENT SHEET

Comments concerning this manual may be made in the space provided below. Please fill in the requested information.

System: _____

Manual Title: _____

UP No: _____ Revision No: _____ Update: _____

Name of User: _____

Address of User: _____

Comments:

FOLD

BUSINESS REPLY MAIL
NO POSTAGE NECESSARY IF MAILED IN THE UNITED STATES
POSTAGE WILL BE PAID BY

FIRST CLASS
PERMIT NO. 21
BLUE BELL, PA.

SPEERY  **UNIVAC**

SYSTEMS SUPPORT
ATTN: INFORMATION SERVICES M.S. 4533
P.O. BOX 3942
ST. PAUL, MINNESOTA 55165

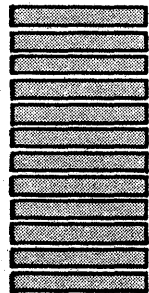

FOLD