

Panasonic

3.5" Flexible Disk Drives One Inch High Series

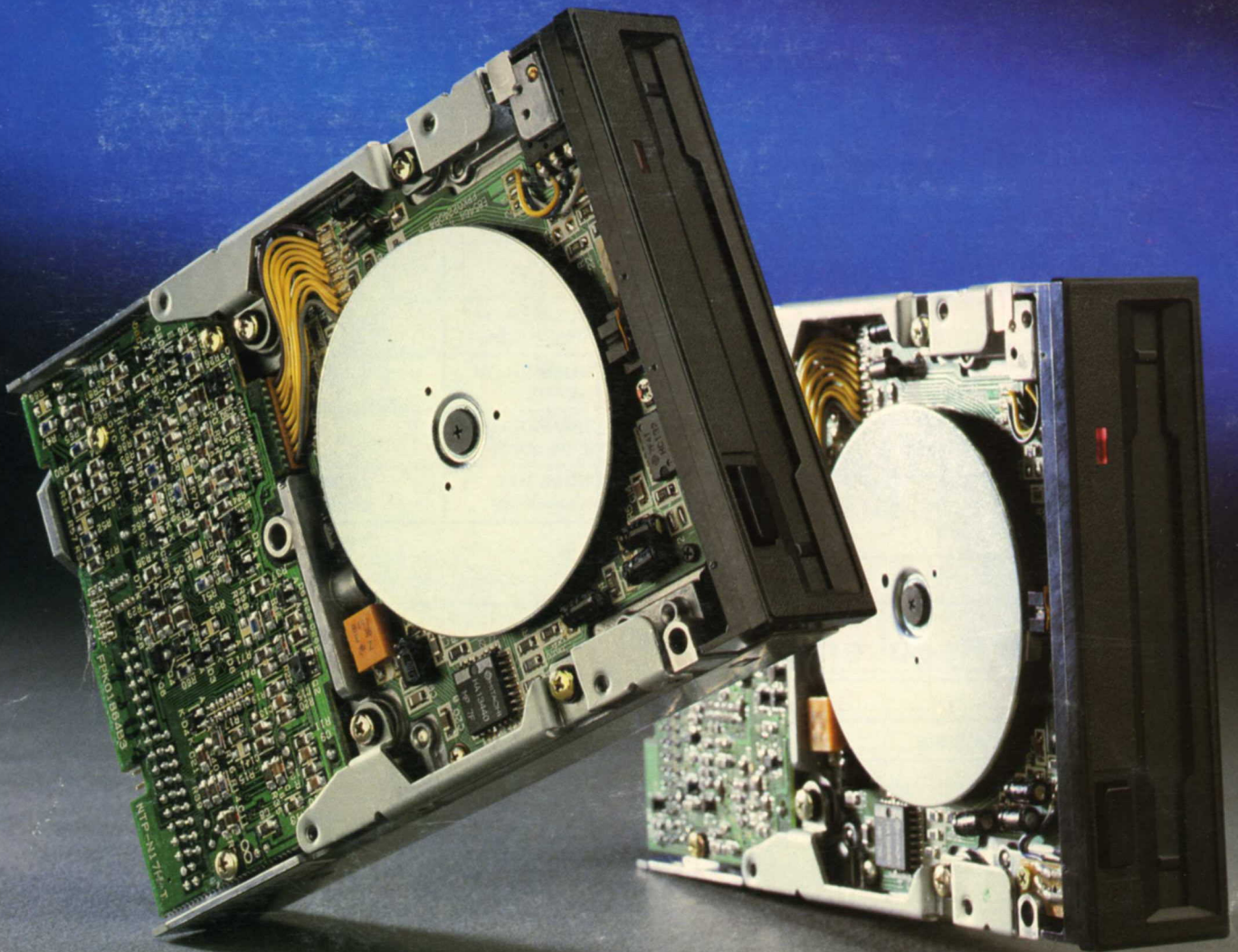

**Panasonic Industrial Co.
Memory Systems Division**

Key Features

- Low Profile (only 1.0", 25.4 mm)
- Lightweight: Suitable for portable and desktop equipment as well. Only 440 grams (approximately 1 pound).
- Compatible with industry standard 5.25" floppy interface.
- High performance: access time of 3 msec.
- State of the art: Surface mount technology, newly developed LSI.
- Quiet operation.
- Low power consumption.
- High reliability: Direct drive brushless digitally controlled motor.
- Customer installable options.

Specifications

Performance

		JU-253	JU-257
CAPACITY UNFORMATTED	Per Disk	1.0 Mbyte	2.0 Mbytes 1.0 Mbytes
	Per Track	6.2 Kbytes	12.5 Kbytes 6.2 Kbytes
Transfer Rate		250 Kbits/sec	500/250 Kbits/sec
ACCESS TIME	Track to Track	3 msec	
	Settling Time	15 msec	
	Motor Start Time	500 msec	300 msec

Functional

ROTATIONAL SPEED	300 RPM	300 RPM
RECORDING DENSITY	8717 BPI	17434 BPI 8717 BPI
TRACK DENSITY	135 TPI	
NUMBER OF TRACKS/SIDE	80	
NUMBER OF HEADS	2	
TEMPERATURE (Operating)	5 C to 45 C	
HUMIDITY (Operating)	20% to 80% (Non-condensing)	

Power Requirements

			JU-253	JU-257	
DC POWER REQUIREMENTS	Voltage		12V±10%, max ripple: 100mVp-p		
	12V	Current (Operating)	Seek	0.25A (Max) / 0.21A (Typ)	0.25A (Max) / 0.21A (Typ)
			Read	0.10A (Max) / 0.08A (Typ)	0.12A (Max) / 0.10A (Typ)
			Write	0.10A (Max) / 0.08A (Typ)	0.13A (Max) / 0.11A (Typ)
		At motor start		0.22A	0.33A (Max) / 0.30A (Typ)
	Voltage		5V±5%, max ripple: 50mVp-p		
	5V	Current (Operating)	Seek	0.31A (Max) / 0.28A (Typ)	0.19A (Max) / 0.17A (Typ)
			Read	0.29A (Max) / 0.26A (Typ)	0.18A (Max) / 0.16A (Typ)
			Write	0.33A (Max) / 0.30A (Typ)	0.18A (Max) / 0.16A (Typ)
		Power Dissipation	Seek Motor/ Start	4.9W (Max) / 3.9W (Typ)	5.4W (Max) / 4.5W (Typ)
	Read		2.9W (Max) / 2.3W (Typ)	2.3W (Max) / 2.0W (Typ)	
	Write		3.1W (Max) / 2.6W (Typ)	2.5W (Max) / 2.1W (Typ)	
	Standby		70mW (Max) / 60mW (Typ)	70mW (Max) / 50mW (Typ)	

Interface Connections

JU-253

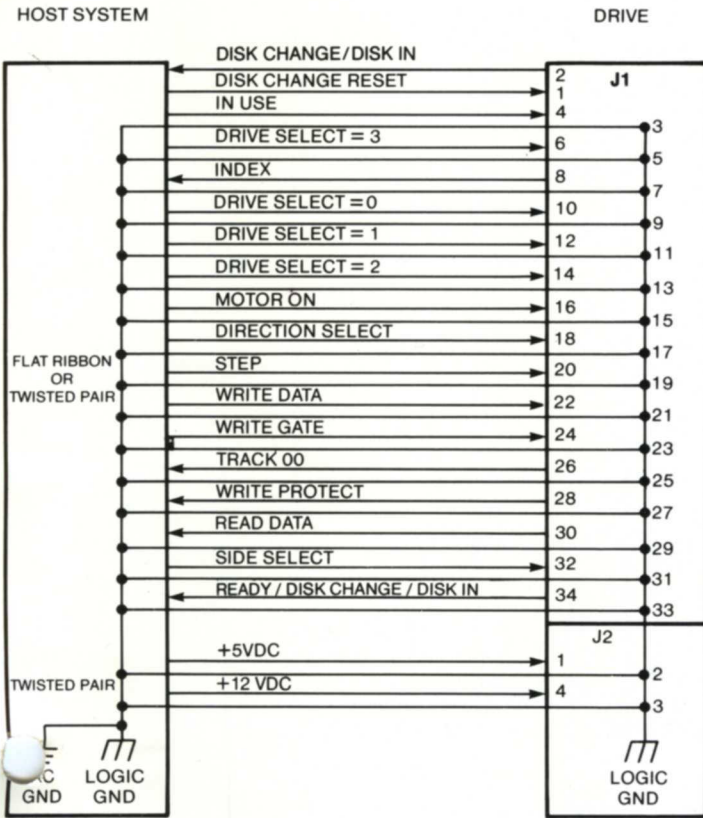

JU-257

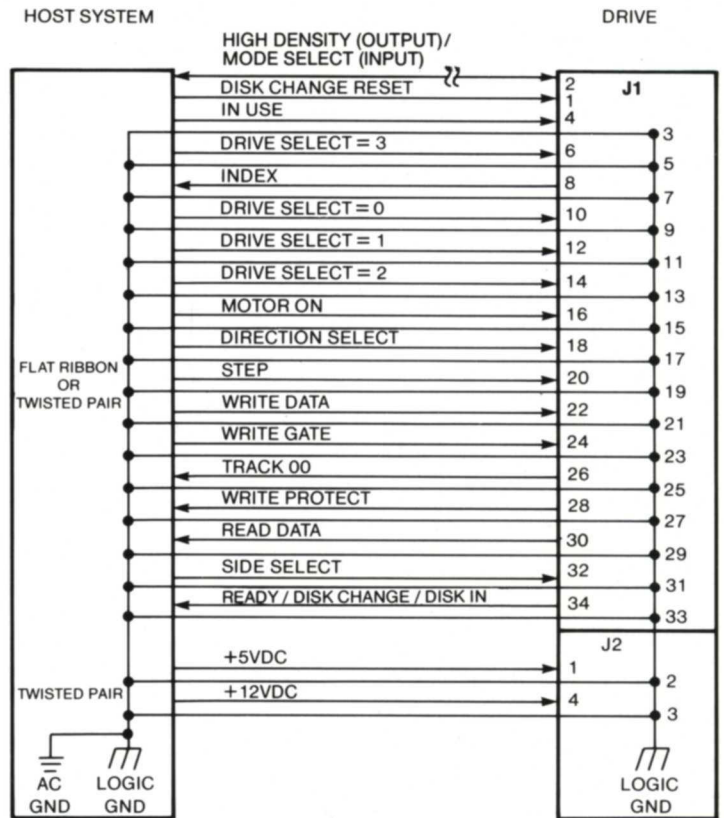

Power Consumption

JU-253

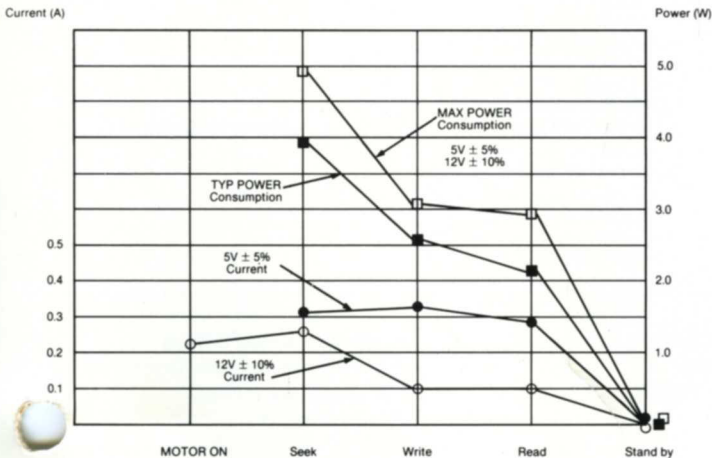

DC POWER PROFILE

JU-257

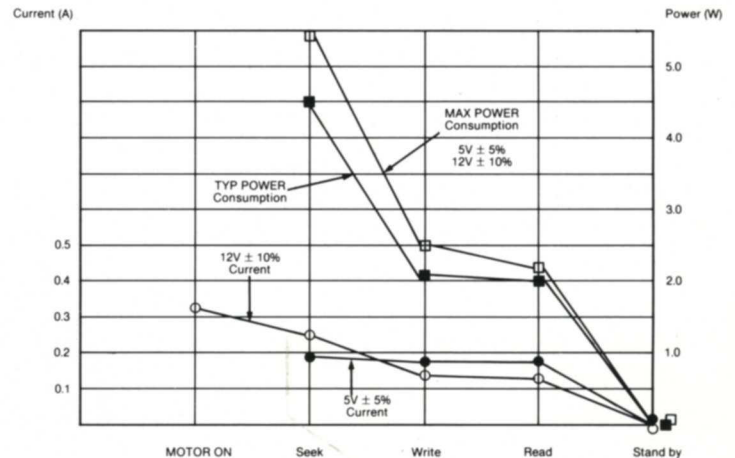

DC POWER PROFILE

Interface Signal Driver/Receiver

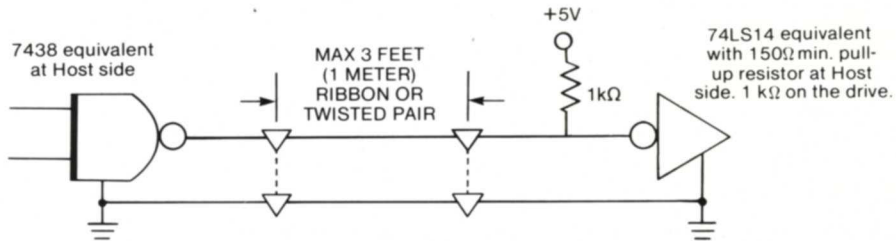

Physical Interface

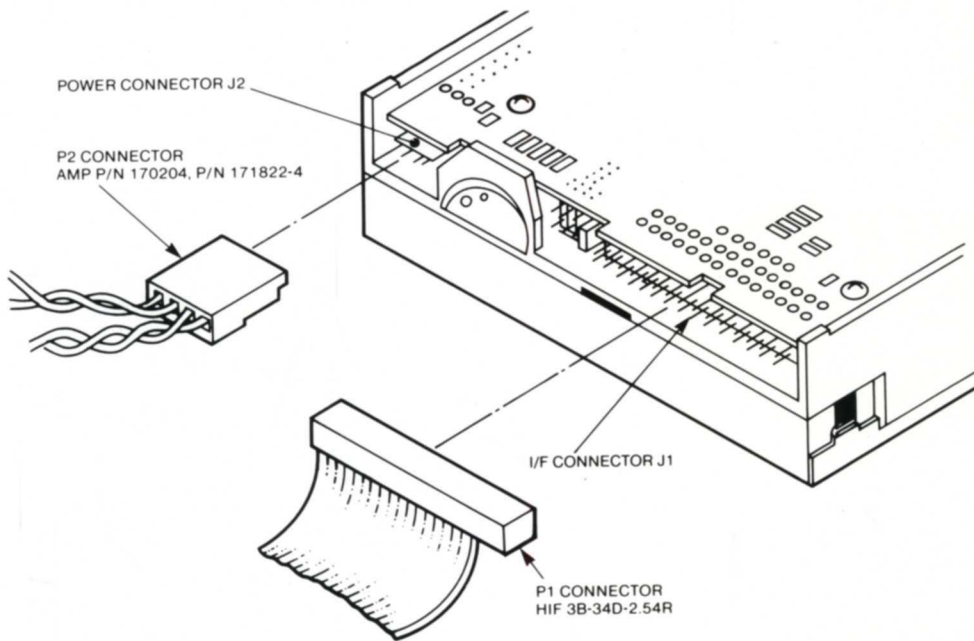

Timing Requirements

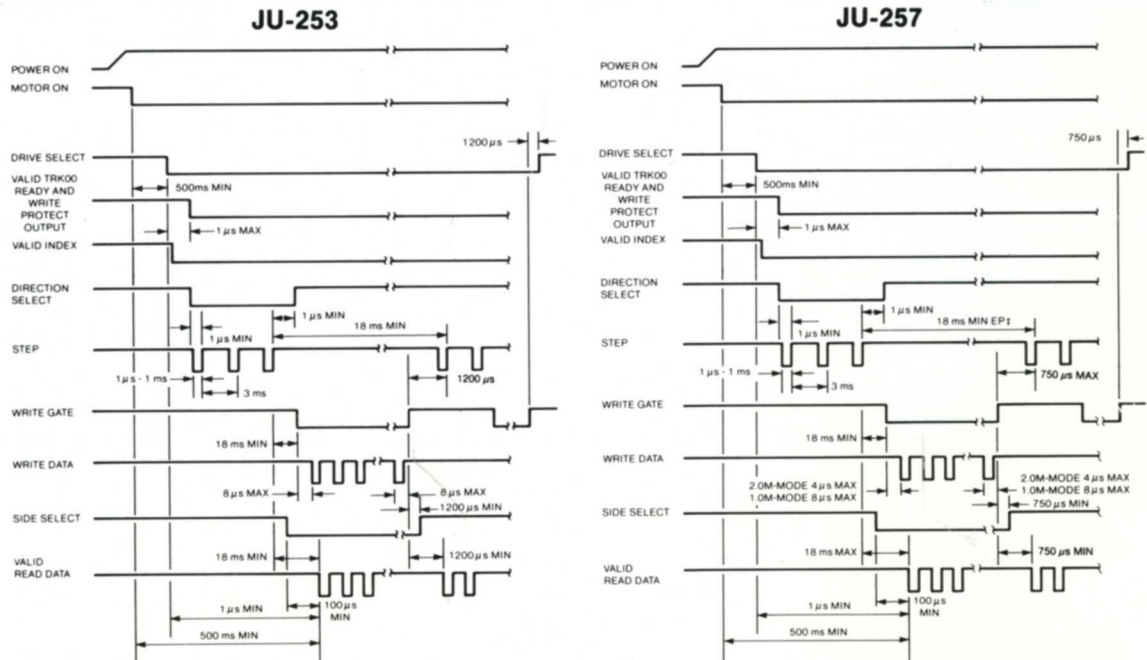

† The delay from the step to read, write or direction change is 18ms minimum in normal mode.

Pin Assignments

Rear View

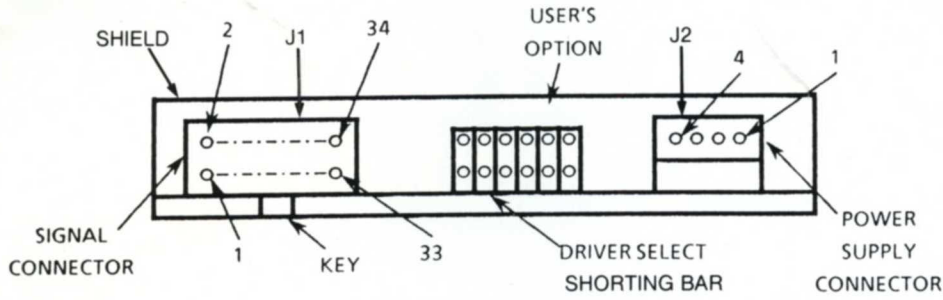

1	+5 VDC
2	+5 RETURN
3	+12 RETURN
4	+12 VDC

J1/J2 CONNECTOR

Shorting Plug Options

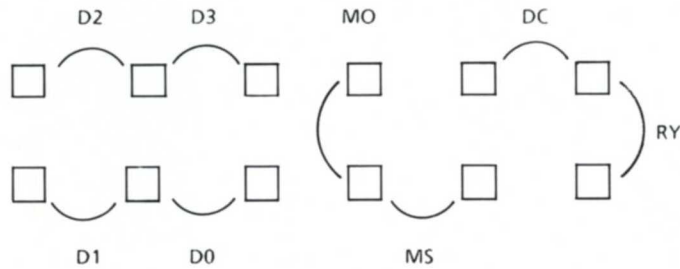

Jumper Designation	Description	Shipped from Factory
D0	DRIVE SELECT 0 input line	Open
D1	DRIVE SELECT 1 input line	Plugged
D2	DRIVE SELECT 2 input line	Open
D3	DRIVE SELECT 3 input line	Open
MO	SPINDLE MOTOR is ON and OFF with MOTOR ON SIGNAL	Plugged
MS	SPINDLE MOTOR is ON and OFF with DRIVE SELECT SIGNAL	Open
DC	Pin #34 is DISK CHANGE SIGNAL	Plugged
RY	Pin #34 is READY SIGNAL	Open
TM	TM provides termination of 1KΩ on all input lines. "DRIVE SELECT" is always terminated through a 1KΩ pull up resistor regardless of TM.	Plugged

Mechanical Dimensions

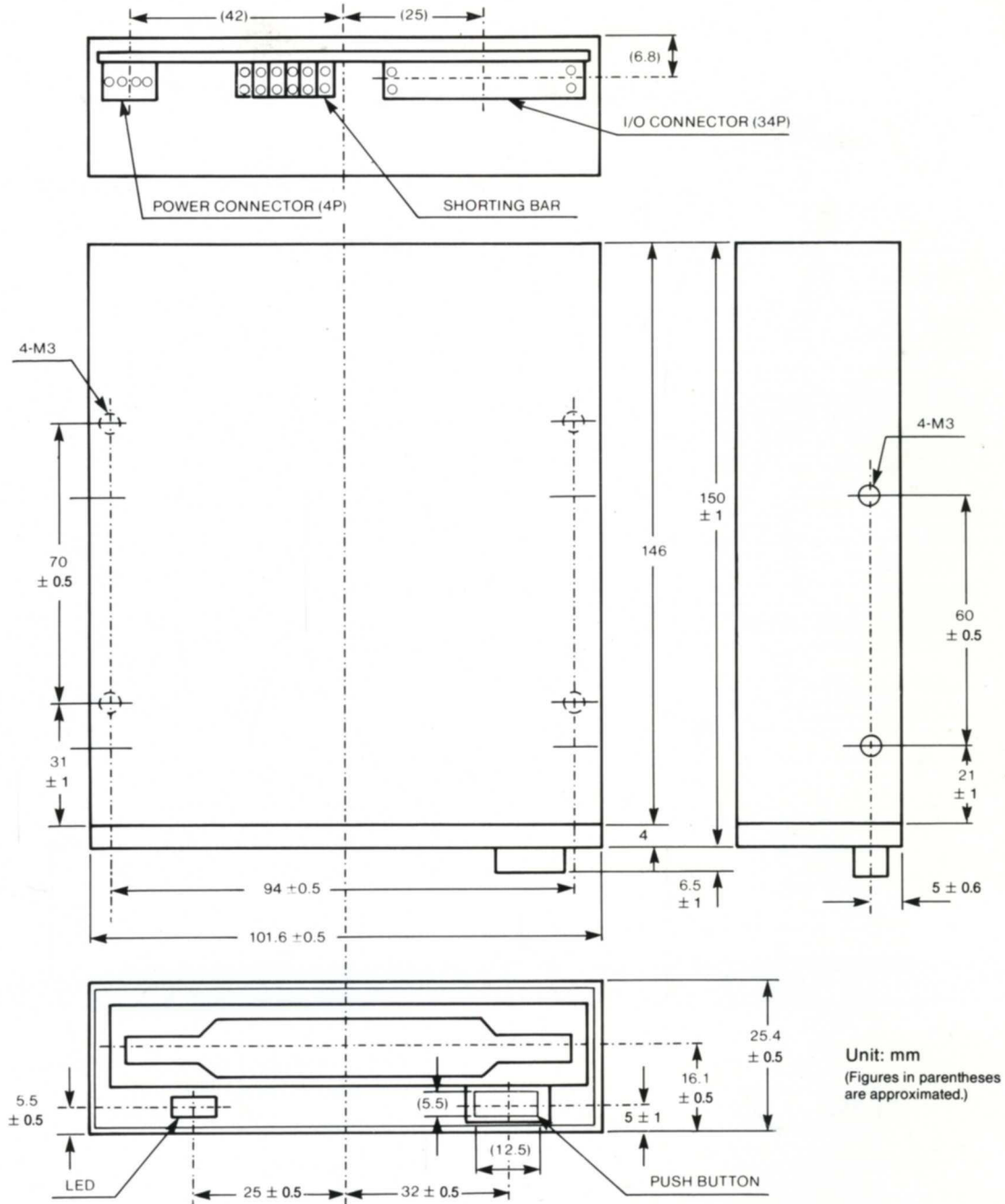

Unit: mm
(Figures in parentheses are approximated.)

NOTE: 1) 32mm high bezels available.
2) 5.25" mounting kit with bezel and adapter kit is also available.

Panasonic Industrial Co. Memory Systems Division

Headquarters
1600 McCandless Drive
Milpitas, CA 95035
408-262-2200

Southwest Sales Office
6550 Katella Avenue
Cypress, CA 90630
714-895-7379

North Central Sales Office
425 E. Algonquin Road
Arlington Heights, IL 60005
312-981-7327

South Central Sales Office
1825 Walnut Hill Lane
Irving, TX 75038
214-580-0518

Northeast Sales Office
Lakeside Office Park, Door #16
Wakefield, MA 01880
617-246-6200

Southeast Sales Office
1854 Shackelford Court, #210
Norcross, GA 30093
404-925-6848