

# Interleaf

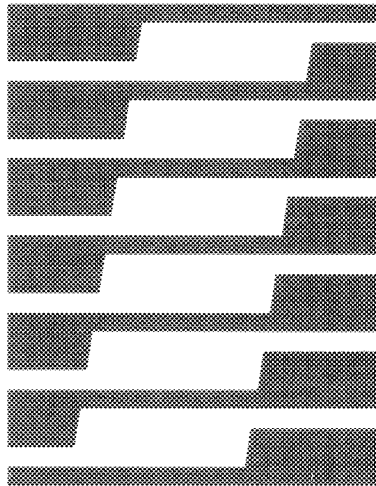

# Technical Publishing Software

*Reference Manual*

*Volume 2*

Sun / Release 3.0

---

This manual was prepared using Interleaf  
Technical Publishing Software.

---

Interleaf reserves the right to make changes in specifications and other information contained in this publication without prior notice, and the reader should in all cases consult Interleaf to determine whether any such changes have been made. This manual may not be reproduced and is intended for the exclusive use of Interleaf's customers.

The terms and conditions governing the sale of Interleaf hardware products and the licensing and use of Interleaf software consist solely of those set forth in the written contracts between Interleaf and its customers. No statement contained in this publication, including statements regarding capacity, suitability for use, or performance of products, shall be considered a warranty by Interleaf for any purpose or give rise to any liability of Interleaf.

In no event will Interleaf be liable for any incidental, indirect, special, or consequential damages (including lost profits) arising out of or relating to this publication or the information contained in it, even if Interleaf has been advised, knew, or should have known of the possibility of such damages.

The software programs described in this document are copyrighted and are confidential information and proprietary products of Interleaf. The copyright laws prohibit the copying of this manual or the software programs without the written consent of Interleaf, except in the normal use of the software or to make a backup copy. This exception does not allow a copy to be made for others. Copying, under the law, includes translating into another language or format.

© 1986 Interleaf, Inc.  
Ten Canal Park  
Cambridge, Massachusetts 02141  
(617) 577-9800

All rights reserved.  
Printed in U.S.A.  
First Printing: December 1986

Interleaf, the Interleaf logo, , Workstation Publishing Software, Technical Publishing Software, and Flexifonts are trademarks of Interleaf, Inc. Times Roman and Helvetica are trademarks of Allied Linotype Corp. Unix is a trademark of Bell Telephone Laboratories, Inc.

---

## About the Reference Manuals

There are two *Reference Manuals*. Volume 1 is a comprehensive guide to the document preparation and desktop management aspects of the publishing software. Volume 2 describes the graphic capabilities of the software as well as printing procedures. Each volume contains a combined index to the two *Reference Manuals*.

In most cases, you need to read only the chapters that apply to a particular task. But we urge you to read the *Introduction* section in Volume 1 before you proceed to other chapters. It describes essential aspects of the Interleaf publishing software and gives information not repeated in later chapters.

### Volume 1

The *Introduction* describes the basic user interface. *Fundamentals* presents and defines the objects — menus, icons, windows — with which you will work. *Basic Procedures* explains methods used throughout the software; they are presented here as the basis for more advanced procedures. *The Keyboard* lists the special commands available through function keys and key sequences.

*Text Processing* addresses the features that allow you to enter and format text. You will also find information about spell checking, hyphenation, search and replace, autonumbering and autoreferencing in this section.

The third section, *Page Makeup*, provides you with the means for determining and implementing an overall structure and design for your documents. Frames, which allow you to reserve space on a page for graphics or specially formatted text, are discussed in this section, as are the procedures for using the main document text editor in frames. The last chapter of this section, *Document Templates*, describes methods for creating templates from your standard page designs and for making the templates available to other users of the publishing software.

*Managing Documents* presents tools and in-depth discussions concerning document management issues. You will learn to access automatically created backup and checkpoint documents, to organize your documents on the desktop, to manage large documents, and to create indexes and tables of contents.

*Upgrade Alerts* contains brief descriptions of the new features of the Interleaf publishing software in Release 3.0. If you have used the Interleaf publishing software before, read this section first.

## Volume 2

The six chapters of the *Diagramming* section explain the process of creating and modifying vector graphics, from simple objects like boxes to the most complicated technical illustrations.

The *Diagramming Extras* section contains three chapters. In *The Graphics Cabinet*, you will learn about the library of illustrations provided with the publishing software. All of them can be tailored to your requirements. The *Images* chapter describes the manipulations you can perform on raster graphics and instructions for editing images you can create with the screen capture feature of the publishing software. *Equations* describes the optional equation editor.

The *Charts* chapters offer detailed instructions for creating charts and information about modifying them to present your data to suit different purposes.

The *Printing* section describes the procedures for printing Interleaf documents from within an open document, from the desktop, or from the operating system.

In the last section of Volume 2, *Appendixes*, you will find illustrations of all the popup and pulldown menus, a discussion of the virtual terminal, and techniques for combining the features of the diagramming system to produce professional illustrations.

## Graphic Aids in the Reference Manuals













Instead of numbering instruction steps, we use graphics that show you what you are going to be doing as you execute each instruction. For example, the usual instructions might look like this:

1. Move the mouse cursor.
2. Click the left mouse button.
3. Hold down the middle mouse button.
4. Release the button.
5. Type no.



In our instructions the graphics reinforce the meaning of the words and the type fonts provide emphasis.

- ☞ Move the mouse cursor.
- ☐☐☐ Click the **left** mouse button.
- ☐☐☐ Hold down the **middle** mouse button.
- ☐☐☐ Release the button.
- ☐ Type **no**.





The following list tells you what the symbols used in instructions mean.

-  Click the **left** mouse button.
-  Click the **middle** mouse button.
-  Click the **right** mouse button.
-  Hold down the **left** mouse button.
-  Hold down the **middle** mouse button.
-  Hold down the **right** mouse button.
-  Release whichever mouse button you are holding down.
-  Represents the mouse.
  -  Indicates that you should move either the mouse — as in —or the mouse cursor—as in .
  -  Indicates that you need to use the keyboard, rather than the mouse, for this action.
  -  Means that you are being asked to do something that involves a series of actions you have already learned.

Sometimes we provide alternative steps. If the alternative is a single step, this is what you will see:

-  At an operating system prompt, type **exit**.
- or  Hold down the **CTRL** key and type **d**.

If the alternative procedure consists of several steps, you will see the following:

-  **Cut** the paragraph and **Paste** the *from* icon on your desktop.
- or
-  **Copy** the paragraph and **Paste** the *from* icon on your desktop.
-  **Open** the *from* icon to make sure you really want to cut this paragraph.
-  Then **Cut** the original paragraph.

Most of the symbols used throughout the publishing software are very easy to interpret because they represent objects you can see on your screen. For example, on your desktop you can see this icon  which represents a *document*. Icons are used to make your choices simple and intuitive.

## Related Publications

In the *Documentation* drawer of the *System* cabinet, you will find the *ReleaseNotes* folder. This folder contains *DocumentationSet*, a complete list of manuals that pertain to this product. If you don't find what you need in the *Reference Manuals*, refer to this list to find the most likely source for information.



# Table of Contents

---

## *Diagramming*

<b>Basic Diagramming Concepts</b> .....	<b>19</b>
Procedures .....	19-1
Opening and Closing a Diagram .....	19-1
The Diagramming Cursors .....	19-1
Selecting and Deselecting .....	19-2
Animation and Deselection Commands .....	19-10
Selection State .....	19-10
Animation State .....	19-11
Control Points and Anchor Points .....	19-12
The Grid and GridAlign .....	19-13
GridAlign on/off .....	19-14
Grid On/off .....	19-15
Grid Front/back .....	19-15
Gravity .....	19-17
Gravity Points and Gravity Radius .....	19-17
Printer and Screen Resolution .....	19-19
The View Commands: Zoom, Center, Shift, and Reset .....	19-21
Zoom .....	19-21
Center .....	19-23
Shift .....	19-24
<b>Objects in Diagramming</b> .....	<b>20</b>
Primitive Objects .....	20-1
Creating a Primitive Object .....	20-2
Object Properties .....	20-4
The Fill Property .....	20-4
The Width Property .....	20-7
Groups .....	20-10
Groups vs. Multiple Selections .....	20-10
Group Hierarchies .....	20-11
Creating a Group .....	20-12
Modifying Groups .....	20-13
Filling Objects—Paths .....	20-14
Polys—Filled Groups of Paths .....	20-14
Objects with Holes .....	20-15
Splines .....	20-17
☞ Control Point and Anchor Point Locations .....	20-19
Control and Anchor Points on a Primitive Object .....	20-19
Control and Anchor Points on a Group .....	20-20
Control and Anchor Points on Very Small Objects .....	20-22
<b>Modifying Diagrams</b> .....	<b>21</b>
Animation and Deselection Commands .....	21-1
Moving Objects .....	21-1
Sizing Objects .....	21-4
Rotation .....	21-8

Duplicating Objects .....	21-14
Cutting and Pasting Diagramming Objects .....	21-15
Aligning Objects .....	21-18
The Undo Command .....	21-23
<b>Creating and Modifying Arcs .....</b>	<b>22</b>
Creating Arcs .....	22-3
Modifying Arcs .....	22-4
Using Standard Commands on Arcs .....	22-4
Using Props Edit to Modify Arcs .....	22-6
<b>Text as a Diagramming Object .....</b>	<b>23</b>
Microdocuments .....	23-1
How to Identify a Microdocument .....	23-2
Variable-Width Microdocuments .....	23-2
Changing from Variable-Width to Fixed-Width .....	23-4
Fixed-Width Microdocuments .....	23-4
Modifying Microdocuments as Diagramming Objects .....	23-6
Editing and Closing Microdocuments .....	23-8
Text Strings .....	23-10
<b>Advanced Diagramming Concepts .....</b>	<b>24</b>
The Edit and SubEdit Commands .....	24-1
Editing Groups .....	24-1
Using the Create SubEdit Commands .....	24-4
Moving Objects between Groups .....	24-9
Locks .....	24-10
Setting and Clearing Locks .....	24-10
The Locks Commands .....	24-11
Creating Your Own Grids .....	24-18
Grid Spacing .....	24-18
Isometric Grids .....	24-19
Isometric/Orthographic Projections .....	24-21
Defaults in Diagramming .....	24-24
Environment Defaults .....	24-24
Object Defaults .....	24-25
Popup Defaults .....	24-26
Environment and Popup Defaults in SubEdits .....	24-28
Adding CAD Drawings to Your Diagrams .....	24-30
Properties of a Plot File CAD Drawing .....	24-31
Manipulating a Plot File CAD Drawing .....	24-31
Editing an Object-Editor CAD Drawing .....	24-31

---

## *Diagramming Extras*

<b>The Graphics Cabinet .....</b>	<b>25</b>
The Graphics Documents .....	25-2
Notes .....	25-2
Sampler .....	25-2
ScratchPad .....	25-2
Arrows .....	25-3



Borders .....	25-9
Charts .....	25-14
FlowCharts .....	25-14
Fonts .....	25-17
Maps .....	25-21
Measure .....	25-21
Shapes .....	25-21
Making Your Own Graphic Symbols .....	25-25
<b>Images .....</b>	<b>26</b>
The Image Icon .....	26-1
Images and Diagramming .....	26-2
Moving an Image .....	26-2
Storing an Image .....	26-2
Creating a Screen Image .....	26-3
Functions of the Screen Capture Program .....	26-3
The Desktop Interface .....	26-4
The Operating System Interface .....	26-4
Modifying a Screen Image .....	26-5
<b>Equations .....</b>	<b>27</b>
Prerequisites .....	27-2
Creating an Equation Object .....	27-2
The Equation Edit Sheet .....	27-2
Entering and Editing Equations .....	27-4
Character Strings .....	27-4
Spaces .....	27-5
Some Important Keywords .....	27-6
Grouping Parts of the Equation .....	27-7
Quoting Characters .....	27-8
Changing the Font .....	27-8
Large Brackets: left and right .....	27-10
Creating Vertical Stacks .....	27-10
Mathematical Terms .....	27-11
Special Characters .....	27-11
Summations: from and to .....	27-12
Integrals .....	27-13
Greek Letters .....	27-13
Diacritical Marks .....	27-14
Defining Abbreviations .....	27-15
Tuning the Appearance of the Equation .....	27-15
A Summary of Keywords .....	27-17

---

## Charts

<b>Making Charts .....</b>	<b>28</b>
Charts as Part of the Diagramming System .....	28-1
The Types of Charts .....	28-2
Creating a Chart .....	28-6
Using ScratchPad .....	28-6
The Edit Chart Sheets .....	28-9

An Overview of the Edit Chart Sheets .....	28-9
The Data Sheet .....	28-12
How Changes are made on the Data Sheet .....	28-12
The Style Sheet .....	28-24
How Changes are made on the Style Sheet .....	28-24
Properties that are the Same for all Chart Styles .....	28-28
Properties that are the Same for Bar and Line Charts .....	28-30
Properties that Differ among Chart Styles .....	28-31
<b>Customizing Charts .....</b>	<b>29</b>
☞ The Customize Sheet .....	29-1
How Changes are made on the Customize Sheet .....	29-2
Properties on the Customize Sheet .....	29-5
Combining Charts with other Diagramming Objects .....	29-20
How to Use Diagramming Objects with a Chart .....	29-21

---

## Printing

<b>Printing .....</b>	<b>30</b>
The Printer Property Sheet .....	30-1
Header Page .....	30-2
Double-Sided and Manual Sheet Feed .....	30-3
Text Attributes .....	30-5
Final Output Device .....	30-5
Default Printer .....	30-5
The Print Menus .....	30-8
Printing .....	30-9
Printing Closed Documents .....	30-9
Printing an Open Document .....	30-10
Canceling a Printing Command .....	30-11
Printerleaf Files .....	30-11
Creating Printerleaf Files .....	30-11
Printing Printerleaf Files from the Desktop .....	30-13
Printing Printerleaf Files from the Operating System .....	30-13
ASCII Files .....	30-15
Printing ASCII Files from the Operating System .....	30-15
Orientation and Size of Pages .....	30-16
Page Margins .....	30-17
Following a Document through the Printing Process .....	30-18
Printer Maintenance .....	30-19

---

## Appendixes

<b>Menus .....</b>	<b>A</b>
Text Selected Menus .....	A-1
Text Location Menus .....	A-2
Text Location Menus (continued) .....	A-3
Diagramming Nothing Selected Menus .....	A-4
Diagramming Nothing Selected (continued) .....	A-5

Diagramming Object Selected Menus .....	A-6
Diagramming Object Selected Menus (continued) .....	A-7
Diagramming Object Selected Menus (continued) .....	A-8
In Component Bar .....	A-9
In Directory Windows .....	A-10
In Windows .....	A-10
Property Sheet Menus .....	A-11
Desktop Menus .....	A-12
Virtual Terminal and Clipboard Menus .....	A-12
Document Header Pulldown Menus .....	A-13
<b>The Virtual Terminal .....</b>	<b>B</b>
The Terminal Icon .....	B-1
The Terminal Window .....	B-1
Copying and Pasting Text within a Virtual Terminal .....	B-3
Copying and Pasting Text from a Virtual Terminal .....	B-4
Using the Flush Input Command .....	B-5
Exiting from the Virtual Terminal .....	B-5
<b>Diagramming Techniques .....</b>	<b>C</b>
Forcing Horizontal or Vertical Lines .....	C-2
Lengthening a Rotated Box .....	C-3
Making Concentric Circles .....	C-4
Masking Objects .....	C-5
Making a Cylinder .....	C-7
Rotating Objects around a Point .....	C-9
Making a Regular Polygon with an Even Number of Sides .....	C-11
Making a Regular Polygon with an Odd Number of Sides .....	C-13
Making a Five-Pointed Star .....	C-15
Creating Double Lines .....	C-17
Creating Double Polys .....	C-18
Dividing a Box into Equal Parts .....	C-19
Creating Objects with Curves .....	C-21
Creating a Cube .....	C-23
Creating a Cube with Curves .....	C-24
Making a Reverse Arrow .....	C-27
Creating Control and Gravity Points .....	C-28
Building a Rotate Magnify Arrow .....	C-29
Organizing Objects with Common Borders into Separate Polys ..	C-31
Creating a Floor Plan .....	C-33

---

## Index



# Figure List

19-1	Misc submenu of the Object Selected menu . . . . .	19-3
19-2	Overlapping objects . . . . .	19-3
19-3	Selecting the top object . . . . .	19-3
19-4	Using Front and Back on more than one object . . . . .	19-4
19-5	Selecting unfilled objects . . . . .	19-4
19-6	Selecting filled objects . . . . .	19-5
19-7	“Inside” of a text object . . . . .	19-5
19-8	Selection and selection box . . . . .	19-6
19-9	Using selection box to correct a selection problem . . . . .	19-6
19-10	Nothing Selected menu and Object Selected menu . . . . .	19-7
19-11	Select Wipe command . . . . .	19-8
19-12	Animation commands and deselection commands . . . . .	19-10
19-13	Selected line, flashing black, then white . . . . .	19-11
19-14	Overlapping selected objects that cancel out flashing . . . . .	19-11
19-15	Difference between selection state and animation state . . . . .	19-11
19-16	Control and Anchor points . . . . .	19-12
19-17	Using Control and Anchor points . . . . .	19-12
19-18	Misc Grid submenu . . . . .	19-13
19-19	Enlargement of the rectangular grid showing its parts . . . . .	19-13
19-20	GridAlign restrictions on the size and move commands . . . . .	19-15
19-21	Grid in front and in back of an object . . . . .	19-16
19-22	Gravity on/off command . . . . .	19-17
19-23	Effects of Gravity when GridAlign is Off . . . . .	19-18
19-24	Gravity points on an oval . . . . .	19-18
19-25	Two low resolution devices . . . . .	19-19
19-26	Circle shown on a 4 dpi and a 16 dpi device . . . . .	19-20
19-27	Zoom command . . . . .	19-21
19-28	Results of Zoom Larger . . . . .	19-22
19-29	Numeric stickup . . . . .	19-22
19-30	Center All command . . . . .	19-23
19-31	Effects of Center All . . . . .	19-23
19-32	Shift Left command . . . . .	19-24
19-33	Shift Left . . . . .	19-24
20-1	Primitive object and a group . . . . .	20-1
20-2	Default sizes of primitive objects . . . . .	20-2
20-3	Create submenu . . . . .	20-2
20-4	Control and anchor points on three objects . . . . .	20-3
20-5	Props submenu . . . . .	20-4
20-6	Fill submenu . . . . .	20-5
20-7	Printer and screen fill patterns . . . . .	20-6
20-8	Matching patterns . . . . .	20-6
20-9	Difference between and . . . . .	20-7
20-10	Examples of widths . . . . .	20-7
20-11	Width submenu . . . . .	20-8
20-12	Using widths of none . . . . .	20-8
20-13	Dashes on the Props Dashes submenu . . . . .	20-9
20-14	How changing a defined group is identical to changing three objects selected together . . . . .	20-10

20-15	How aligning a group differs from aligning a multiple selection . . . . .	20-11
20-16	Hierarchy of a group . . . . .	20-12
20-17	Group command on the Misc submenu . . . . .	20-12
20-18	Modifying a group . . . . .	20-13
20-19	Paths . . . . .	20-14
20-20	Fillable paths and unfillable objects . . . . .	20-14
20-21	Creating a poly . . . . .	20-14
20-22	An object with holes . . . . .	20-15
20-23	Creating holes in objects . . . . .	20-15
20-24	Ungrouped, overlapping, filled objects . . . . .	20-16
20-25	Using multiple objects to create a poly with a hole . . . . .	20-16
20-26	Poly and spline . . . . .	20-17
20-27	Spline octopus . . . . .	20-17
20-28	Convert command on the Misc submenu . . . . .	20-17
20-29	Changing the position of the endpoints in a spline . . . . .	20-18
20-30	Possible locations for the active control point . . . . .	20-19
20-31	Control points on a group . . . . .	20-21
20-32	Anchor and control points for sizing groups . . . . .	20-21
20-33	Anchor points for rotating groups . . . . .	20-22
20-34	Visibility of control and anchor point markers . . . . .	20-23
21-1	Move submenu . . . . .	21-2
21-2	Moving a group along a diagonal . . . . .	21-2
21-3	Move Numeric submenu . . . . .	21-3
21-4	Move numeric stickups . . . . .	21-3
21-5	Size submenu . . . . .	21-4
21-6	Using the Size animation commands . . . . .	21-4
21-7	Size to Frame submenu . . . . .	21-5
21-8	Sizing to Frame . . . . .	21-6
21-9	Reflect submenu . . . . .	21-6
21-10	Axes around which an object can be reflected . . . . .	21-6
21-11	Effects of Reflect . . . . .	21-7
21-12	Size Numeric submenu . . . . .	21-7
21-13	Size Numeric stickup . . . . .	21-8
21-14	Using Size Numeric . . . . .	21-8
21-15	Rotating objects . . . . .	21-9
21-16	Rotating arrow with 45 degree detent . . . . .	21-9
21-17	Detents are relative to the current angle . . . . .	21-9
21-18	Detent submenu . . . . .	21-10
21-19	Detent Other stickup . . . . .	21-10
21-20	Anchor point at weighted center of a poly . . . . .	21-11
21-21	Rotating groups of text strings and charts . . . . .	21-11
21-22	Rotate submenu . . . . .	21-11
21-23	Rotate Numeric stickup menu . . . . .	21-12
21-24	Anchor points and Rotate Magnified . . . . .	21-13
21-25	Two possibilities using Dup and Rotate Magnified . . . . .	21-13
21-26	Rotate Circular and Rotate Magnified . . . . .	21-14
21-27	Dup submenu on the Object Selected menu . . . . .	21-14
21-28	Diagram icon containing objects from a document called pingo . . . . .	21-15
21-29	Cut command . . . . .	21-16
21-30	Copy command . . . . .	21-16

21-31	Paste command . . . . .	21-17
21-32	Showing how paste works with a star . . . . .	21-17
21-33	Effects of Align commands . . . . .	21-18
21-34	Possible alignment axes . . . . .	21-18
21-35	Align submenu . . . . .	21-18
21-36	How the bounding box works with align . . . . .	21-19
21-37	Align to frame submenu . . . . .	21-20
21-38	Moving some objects before aligning . . . . .	21-21
21-39	The groups are aligned, not the objects in them. . . . .	21-21
21-40	Objects are centered because they are not grouped. . . . .	21-22
21-41	Box divided into two panels with two objects aligned left/right in a panel . . . . .	21-22
21-42	Undo command on the Nothing Selected menu . . . . .	21-23
21-43	Using Undo twice in a row . . . . .	21-24
21-44	Using Cut and Undo in a diagram . . . . .	21-24
21-45	Using Copy and Undo in a diagram . . . . .	21-24
22-1	One example of a conic section . . . . .	22-1
22-2	Endpoints and midpoint . . . . .	22-1
22-3	Conic and weighted centers . . . . .	22-2
22-4	Tangent points on selected arc . . . . .	22-2
22-5	Some arcs and their bounding boxes . . . . .	22-3
22-6	Create Arc submenu . . . . .	22-3
22-7	Default arcs . . . . .	22-3
22-8	Control points for moving arcs . . . . .	22-4
22-9	Control and anchor points for sizing arcs . . . . .	22-5
22-10	Control and anchor points for magnified rotation of arcs . . . . .	22-5
22-11	Control points and anchor point for rotations of arcs other than magnified rotation . . . . .	22-6
22-12	Props Edit arc control points . . . . .	22-6
22-13	Editing the extent of an arc . . . . .	22-7
22-14	Results of editing the midpoint . . . . .	22-7
22-15	Results of editing tangent points . . . . .	22-8
23-1	Microdocuments . . . . .	23-1
23-2	Variable-width microdocuments . . . . .	23-2
23-3	Microdocument alignment . . . . .	23-3
23-4	Variable-width microdocument control points . . . . .	23-3
23-5	Align submenu . . . . .	23-4
23-6	Create Misc Text command . . . . .	23-5
23-7	Empty, default microdocument . . . . .	23-5
23-8	Sizing microdocuments horizontally . . . . .	23-6
23-9	Sizing several microdocuments vertically . . . . .	23-7
23-10	Rotating microdocuments . . . . .	23-8
23-11	Props Edit command . . . . .	23-9
23-12	Open microdocuments . . . . .	23-9
23-13	Left, centered, and right text anchors . . . . .	23-10
23-14	Status line when you enter a text string aligned flush left . . . . .	23-11
23-15	Changing the font before creating a text string . . . . .	23-12
23-16	Changing the font of an existing text string . . . . .	23-13
23-17	Point size of a font . . . . .	23-13
23-18	Baseline on a text string . . . . .	23-13
23-19	Rotating text strings . . . . .	23-15

23-20	Text string control points	23-15
23-21	Text that has been entered with left, centered, and right text anchors	23-16
24-1	Edit command on the Props submenu	24-1
24-2	SubEdit stickup	24-2
24-3	Editing an object	24-3
24-4	Status line at the first subedit level	24-3
24-5	SubEdit commands	24-4
24-6	Using the Create SubEdit Group command	24-5
24-7	Creating polys with the Poly command vs. with individual lines	24-5
24-8	Plant created with Draw command	24-7
24-9	Draw control point	24-8
24-10	Linear on/off command	24-8
24-11	Locks set submenu	24-10
24-12	Status line showing locks on a newly created box	24-11
24-13	Sizing an aspect-locked object	24-12
24-14	Sizing an aspect-locked object horizontally	24-12
24-15	Select Locked command on the Nothing Selected menu	24-13
24-16	Angle locks and rotation	24-13
24-17	Control-locked objects	24-14
24-18	Using control locks as an alignment aid	24-15
24-19	Position locks	24-15
24-20	Fill lock in a flowchart symbol	24-16
24-21	Font-locking symbols	24-17
24-22	Spacing submenu	24-18
24-23	Stickup menus for creating grid units	24-18
24-25	X, Y, and Z axes	24-20
24-26	Grid Type command	24-20
24-27	Isometric grid shown with "3D" object	24-20
24-28	Isometric Move commands	24-21
24-29	Two dimensional X-Y plane	24-21
24-30	Isometric planes	24-22
24-31	Misc Convert Projection to Iso(metric) submenu	24-22
24-32	Conversion Projection stickup	24-23
24-33	Isometric Projection	24-23
24-34	Projection to Ortho submenu	24-23
24-35	Defaults submenu	24-25
24-36	Three submenus of the Defaults submenu	24-25
24-37	Invisible line width stickup	24-26
24-38	Resetting environment defaults across edit levels	24-29
24-39	Plot icon	24-30
25-1	Graphics cabinet	25-1
25-2	Arrows folder	25-3
25-3	Bouquet of linear arrows	25-3
25-4	The nine linear arrowheads	25-4
25-5	Making a clockwise curved arrow	25-5
25-6	Points in the Linear document	25-5
25-7	Some of the graphic arrows	25-6
25-8	Sizing aspect-locked and non-aspect-locked circle arrows	25-6
25-9	Extension boxes, invisible and visible	25-7
25-10	Distorting arrow's proportions	25-8



25-11	Maintaining arrow's proportions . . . . .	25-8
25-12	Lengthen the tail before you rotate. . . . .	25-9
25-13	Borders folder . . . . .	25-9
25-14	Distorting the repeated shapes borders . . . . .	25-10
25-15	Cutting original right side . . . . .	25-11
25-16	Distorting the poly borders . . . . .	25-11
25-17	Sizing poly borders . . . . .	25-12
25-18	Increasing only the length of the first divider . . . . .	25-12
25-19	Increasing the height of a curly bracket . . . . .	25-13
25-20	Filling parts of a highlighter . . . . .	25-13
25-21	Charts folder . . . . .	25-14
25-22	FlowCharts folder . . . . .	25-14
25-23	Extra gravity points on flow chart symbols . . . . .	25-15
25-24	Sample flow chart . . . . .	25-16
25-25	Fonts folder . . . . .	25-17
25-26	Samples of the fonts . . . . .	25-17
25-27	Control points on sample characters . . . . .	25-18
25-29	Samples of fonts . . . . .	25-20
25-30	Measure folder . . . . .	25-21
25-31	Shapes folder . . . . .	25-22
25-32	25 degree ellipse . . . . .	25-22
25-33	Two- and three-toned single and stacked cubes . . . . .	25-23
25-34	Stars and asterisks . . . . .	25-23
25-35	Sample of shapes and arrows . . . . .	25-24
26-1	Image icon . . . . .	26-1
26-2	Screen Capture popup menu . . . . .	26-4
26-3	Image with unwanted details . . . . .	26-6
26-4	Covering unwanted details with masking objects . . . . .	26-6
26-5	Matching image patterns and diagramming fill patterns. . . . .	26-6
26-6	Cleaning up image details with diagramming objects. . . . .	26-6
26-7	A modified screen image must be recaptured. . . . .	26-7
27-1	A display equation . . . . .	27-1
27-2	Combining equations with other graphic objects . . . . .	27-1
27-3	A chemical equation . . . . .	27-1
27-4	Create Misc Equation command . . . . .	27-2
27-5	Default equation . . . . .	27-2
27-6	Equation Edit sheet . . . . .	27-2
27-7	Character strings and separators . . . . .	27-4
27-8	Types of character strings in equation text . . . . .	27-5
27-9	Adding spaces to the final equation . . . . .	27-5
27-10	Creating super- and subscripts . . . . .	27-6
27-11	Multi-level super- and subscripts . . . . .	27-6
27-12	Using over to create fractions . . . . .	27-7
27-13	Using sqrt to create square roots . . . . .	27-7
27-14	How braces change the interpretation of text . . . . .	27-7
27-15	Multi-level braces . . . . .	27-8
27-16	Using quotation marks to prevent interpretation . . . . .	27-8
27-17	Changing the point size of an equation . . . . .	27-9
27-18	Changing the weight of the typeface . . . . .	27-9
27-19	Quote digits to make them appear in bold . . . . .	27-9
27-20	Using left and right to create large brackets . . . . .	27-10
27-21	Using pile and above to create vertical stacks . . . . .	27-11

27-22	Table of mathematical terms .....	27-11
27-23	Entering special characters .....	27-12
27-24	Using from and to .....	27-13
27-25	Creating integrals .....	27-13
27-26	Controlling the case of Greek letters .....	27-13
27-27	Entering Greek letters .....	27-14
27-28	Keywords for creating diacritical marks .....	27-14
27-29	Diacritical marks centered over character strings .....	27-14
27-30	Using define to define abbreviations .....	27-15
27-31	Using up to raise a superscript .....	27-16
27-32	The control point does not move when the equation is edited. ....	27-16
27-33	Summary of Keywords .....	27-17
28-1	Bar and surface charts .....	28-3
28-2	Line, filled line, and scatter charts .....	28-4
28-3	Pie charts .....	28-5
28-4	Create Misc submenu of the Diagramming Nothing Selected popup menu .....	28-6
28-5	Text Location popup menu .....	28-8
28-6	Diagramming Object Selected popup menu .....	28-9
28-7	A bar chart and a line chart with their Data sheets ....	28-10
28-8	A bar chart and a line chart with their Style sheets ....	28-11
28-9	A data sheet with boxes turned off and the resulting chart .....	28-13
28-10	Questions on all Data sheets .....	28-13
28-11	Questions on Data sheets of line style charts .....	28-13
28-12	Automatic entry on Data sheet when increments are different .....	28-14
28-13	Automatic entries on Data sheet when increments are the same .....	28-14
28-14	Paste data and Copy data submenus on the Edit Chart Data sheet .....	28-16
28-15	Pasting data .....	28-18
28-16	Sample data preceded by words .....	28-19
28-17	Sample data preceded by words and digits .....	28-19
28-18	Example spreadsheet in Typewriter font .....	28-21
28-19	Bar chart created from spreadsheet data .....	28-22
28-20	Examples of boxes that register information on the Style sheet .....	28-24
28-21	Data margins boxes .....	28-25
28-22	Changing data margins .....	28-26
28-23	Changing label margins .....	28-27
28-24	Chart types .....	28-28
28-25	Data borders .....	28-28
28-26	Data margins boxes .....	28-28
28-27	Textures .....	28-29
28-28	Charts with label display on and off .....	28-29
28-29	Label margin boxes .....	28-29
28-30	Background lines .....	28-30
28-31	Hash marks .....	28-30
28-32	Origin line .....	28-31
28-33	Bar settings .....	28-32
28-34	Charts with bar borders on and off .....	28-33

28-35	Scaling the size of bars and gaps .....	28-33
28-36	Fixing the size of bars and gaps .....	28-34
28-37	Two charts that have been altered using the fix settings	28-34
28-38	Line size .....	28-35
28-39	Line options .....	28-35
28-40	Stacked and unstacked lines .....	28-36
28-41	Stacked line chart converted to a bar chart and the corresponding bar placement icons .....	28-36
28-42	Partially stacked bar chart converted to a line chart and the corresponding bar placement icons .....	28-37
28-43	Line Choices .....	28-38
28-44	Properties of pie charts .....	28-39
28-45	Pie charts .....	28-40
29-1	The Chart Customize stickup .....	29-2
29-2	The Customize sheet .....	29-2
29-3	How to use the Customize sheet .....	29-3
29-4	Data margins boxes .....	29-4
29-5	Numeric values of left and right clicks .....	29-5
29-6	Sample Dow Jones chart .....	29-6
29-7	Data sheet with axis scaled and data entered .....	29-7
29-8	Chart with overlaid diagramming objects before they have been filled with black .....	29-9
29-9	DJ chart reduced with scale flags set to 0 .....	29-10
29-10	DJ chart reduced with scale flags set to 15 .....	29-10
29-11	DJ chart reduced with scale flags set to -1 .....	29-11
29-12	Chart reduced after increasing size of data border and hash marks .....	29-11
29-13	Numeric value of data border icons .....	29-12
29-14	Numeric value of origin line icons .....	29-12
29-15	Numeric value of background icons .....	29-13
29-16	Numeric value of line size icons .....	29-13
29-17	Numeric value of hash mark icons .....	29-14
29-18	Numeric value of label margins .....	29-14
29-19	Numeric value of data margins .....	29-15
29-20	Numeric value of scale icons .....	29-15
29-21	Numeric value of fix options .....	29-16
29-22	Numeric value of bar placement icons .....	29-17
29-23	Selecting Style sheet icons to position bars .....	29-17
29-24	Numeric value of icons for placement of three bars ...	29-18
29-25	Controlling bar placement by using the Customize sheet	29-18
29-26	Properties of pie charts .....	29-19
29-27	A chart with graphic objects .....	29-20
29-28	Chart B9 from the Graphics cabinet .....	29-21
29-29	Data sheet for chart .....	29-21
29-30	Chart with shapes on top of bars .....	29-22
29-31	Finished chart .....	29-23
29-32	Sample chart combined with diagramming objects .....	29-25
30-1	Printer property sheet with system defaults .....	30-2
30-2	Imagen printer header page .....	30-2
30-3	Manual feed trays on the cx and dp printers .....	30-4
30-4	Example of a Final Output Device setting .....	30-5
30-5	Relationship between the Default Printer setting and the default printer on the Printer pulldown menu .....	30-6

30-6	The Print Menus .....	30-8
30-7	Print Copies submenu .....	30-8
30-8	Interrupt stickup menu with the cursor at the default choice. ....	30-11
30-9	Printerleaf submenu .....	30-12
30-10	Portrait Orientation: Width and Height on the Page property sheet .....	30-16
30-11	Landscape Orientation: Width and Height on the Page property sheet .....	30-16
30-12	Orientation of pages .....	30-17
30-13	Line Printer Queue listing .....	30-18
A-1	Text Selected menus .....	A-1
A-2	Text Location Create and Fonts submenus .....	A-2
A-3	Text Location Misc submenus .....	A-3
A-4	Diagramming Nothing Selected Create, Select and Misc submenus .....	A-4
A-5	Diagramming Nothing Selected Create Misc Defaults submenus .....	A-5
A-6	Diagramming Object Selected Props submenus .....	A-6
A-7	Diagramming Object Selected Props, Size, Move, and Rotate submenus .....	A-7
A-8	Diagramming Object Selected Dup and Misc submenus .	A-8
A-9	Location Selected and Component Selected menus ....	A-9
A-10	Icon Selected and Nothing Selected menus in directory windows .....	A-10
A-11	Window menu in scroll bars and headers .....	A-10
A-12	Property sheet Close and Apply menus .....	A-11
A-13	Icon Selected and Nothing Selected menus on the desktop .....	A-12
A-14	Virtual terminal and clipboard menus .....	A-12
A-15	Document Header pulldown menus .....	A-13

# Methods

To enter wipe-select mode .....	19-8
To select using wipe-select .....	19-8
To deselect using wipe-select .....	19-9
To exit the wipe-select mode .....	19-9
To create a group from previously created objects .....	20-13
To ungroup a set of objects .....	20-13
To make a spline or splines from lines .....	20-18
To make polys from splines .....	20-19
To create a series of evenly spaced objects .....	21-15
To center objects between grouped lines .....	21-22
To edit an arc control point .....	22-6
To create a variable-width microdocument .....	23-2
To create a microdocument using the Create Misc Text command .....	23-5
To edit a microdocument .....	23-8
To close a microdocument edit .....	23-9
To preset text string alignment .....	23-10
To create a text string .....	23-10
To increase or decrease the line spacing between text strings ..	23-14
To connect two text strings so they print correctly .....	23-15
To change the text of one text string in a group .....	23-18
To create a group with the Group command .....	24-4
To create a poly with the Poly command .....	24-6
To suspend poly entry mode .....	24-6
To reenter poly entry mode .....	24-6
To create a spline using the Spline command .....	24-7
To create a drawing with the Draw command .....	24-8
To close a drawing .....	24-8
To move the draw control point without drawing .....	24-8
To include a straight line in a drawing .....	24-8
To move an object from one group to another .....	24-9
To lock or unlock a property on an object .....	24-11
To change the grid type to isometric .....	24-20
To project an object onto an isometric plane .....	24-22
To project an object back onto the orthographic plane .....	24-23
To move the CAD drawing into a document .....	24-30
To put a symbol into your document .....	25-2
To use a linear arrow .....	25-3
To attach a fancy tail to an arrowhead .....	25-4
To lengthen the tail of the circle arrow without enlarging the circles .....	25-6
To lengthen the tail of a two-part arrow .....	25-7
To put a frame containing a border in your document .....	25-10
To expand a repeated shape border .....	25-10
To assemble a flow chart .....	25-15
To add two or more lines of text to a flow chart symbol .....	25-15
To assemble a word .....	25-18
To use the rulers .....	25-21
To minimize the size of a Graphics document .....	25-25

To put an image in a document .....	26-1
To capture a screen image in the publishing software .....	26-4
To capture a screen image in another piece of software .....	26-4
To create large brackets around a fraction .....	27-10
To define an abbreviation for a complicated expression .....	27-15
To create a chart in ScratchPad .....	28-7
To move a chart from ScratchPad to a document .....	28-8
To open the Edit Chart sheets .....	28-9
To reverse the row and column data on a Chart Data sheet ...	28-20
To create a bar chart by selecting a horizontal row of data ....	28-21
To create a bar chart by copying a vertical column of data ....	28-23
To open the Customize sheet .....	29-1
To create and size a Dow Jones chart using scale flags .....	29-7
To change the bars to shapes and eliminate bars .....	29-22
To print double-sided copy .....	30-3
To print documents using manual sheet feed .....	30-4
To print from an open document .....	30-10
To create a Printerleaf file from an open document .....	30-12
To create a Printerleaf file from a document icon .....	30-12
To print a Printerleaf file from the desktop .....	30-13
To print a Printerleaf file on your default printer .....	30-13
To print a Printerleaf file on a printer other than your default printer .....	30-13
To print a Printerleaf file most efficiently on the default printer	30-14
To print an ASCII file from the operating system .....	30-15
To list the print queue for your default printer .....	30-18
To remove a document from the print queue of your default printer .....	30-19
To remove a document from the print queue of a printer other than your default printer .....	30-19

---

## Chapter 19

# ***Basic Diagramming Concepts***

The Interleaf diagramming system lets you create diagrams from a combination of objects such as lines, boxes, arcs, ovals, text, charts, and screen images. The diagramming system is of a type known as an **object editor**.

An object editor maintains objects separately. For instance, you can select a box that is next to an oval and resize it; or, you can select and resize both objects.

The feature which lets you modify screen capture images is a **pixel or raster editor**. This editor treats the image as a single object. If the image contains a box and an oval, there is no mechanism for selecting the two parts of the image as individual objects.

This chapter describes tools and procedures basic to selecting and modifying the objects in a diagram.

## ***Procedures***

### **Opening and Closing a Diagram**

All diagrams are contained in frames. To select and **open** an existing frame, position the mouse cursor anywhere inside of it, and click left or right mouse button twice.

There are two ways to **close** a frame: using the **Close** command on the diagramming nothing selected popup or positioning the cursor outside the frame and clicking the left or right mouse button.

Detailed information about frames can be found in the chapter *Text-Anchored Frames*.

### **The Diagramming Cursors**

In the diagramming system, the mouse cursor may assume any of six shapes:

- ↖ is the basic diagramming cursor. If you have a frame open in the active window, you will see this cursor as long as you keep the cursor in the document or component bar. If you move the cursor into the scroll or header bars, or if you move it out of the window altogether, it will assume a new shape appropriate to the situation.

- ▲ is the selection cursor. It selects the object at which it is pointing. If you hold down the left or the right button, you will see this cursor.
- ☐ is the selection box. It selects all objects that are completely contained in it. To see the selection box, move the mouse cursor while you hold down the left or right button.
- ◊ is the wipe-select mode cursor. You will see it when you execute the **Select Wipe** command. The cursor will not leave the frame while in this form.
- [ ] is the drawing cursor, or the “pen” that you use to draw with in the Subedit Draw mode.

## Selecting and Deselecting

In the diagramming system you select an object with the left button and extend or modify the selection with the right button, except when using the wipe-select mode.

There are five methods of selection and deselection:

- pointing and clicking
- using the selection box
- holding down the left or right button while clicking the other
- using selection and deselection commands on popup menus
- touching objects with the wipe-select cursor while holding the left (select) or right (deselect) button

## Diagramming Order and Selection

Diagramming objects do not all exist in the same plane; rather, if you have not done anything to change their order, they are stacked according to their order of creation. The first object you created is in back of the stack and the most recently created object is in front.

This order can have an effect on selection. If you point the cursor and click the left button and there are several objects within a few pixels of the cursor, the diagramming system will select the one that is in front.

You can change this order with the **Front** and **Back** commands.

### *Moving Objects Front and Back*

The **Front** and **Back** commands are on the Misc submenu of the Object Selected popup menu (Figure 19-1).



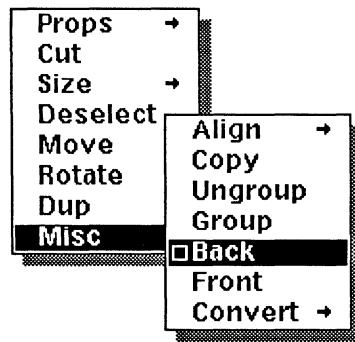

Figure 19-1. Misc submenu of the Object Selected menu

Figure 19-2 shows three overlapping objects: a box, an oval, and a triangle, created in that order. Because the box was created first, it is at the back of the order, and the other two objects cover part of it. Because the triangle was created last, it is in front of the other two objects.

If you select the oval, and execute the **Front** command on it, it will be moved to the front of the order, and it will cover part of the triangle, as shown in Figure 19-2.

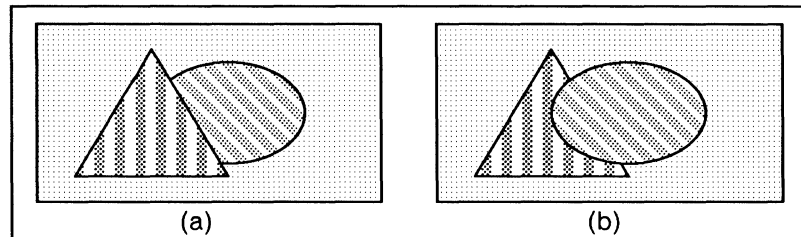

Figure 19-2. Overlapping objects

If you cannot select an object because some other object is in front of it, use the **Back** command to move the top object to the back of the stack of objects.

In Figure 19-3, the mouse cursor is within selection distance of both the text string and the box. Because the box is in front, it will always be selected unless you move it to the back.

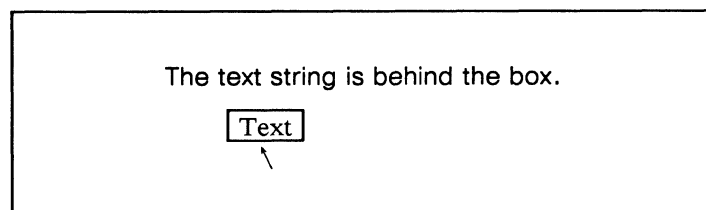

Figure 19-3. Selecting the top object

The **Front** and **Back** commands can be executed on more than one object at a time. When you change the position of several objects at once, the order of these objects in relation to each other is maintained.

If you select two objects and bring them to the front of the order, the one that was closer to the front will become the first object (Figure 19-4).

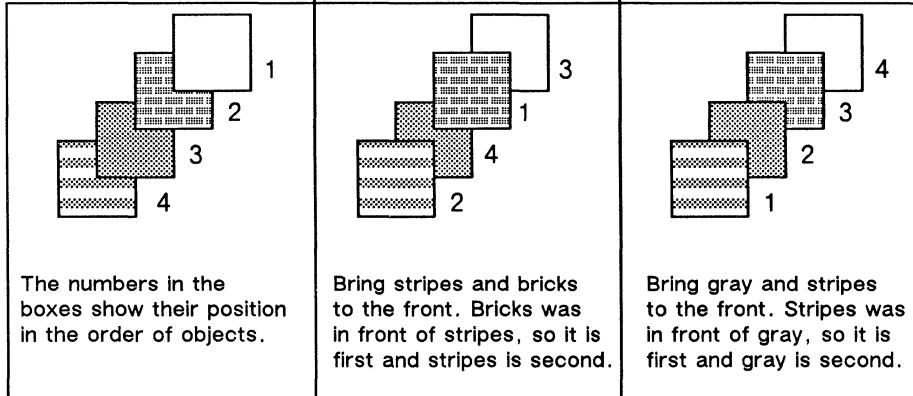

Figure 19-4. Using *Front* and *Back* on more than one object

## Pointing and Clicking

With the pointing and clicking method of selection, if the object is within a few *pixels* — that is, screen dots — in any direction of the current cursor position, it will be selected, as Figure 19-5 shows. Notice that the interior of an *unfilled* object is not considered part of the object.

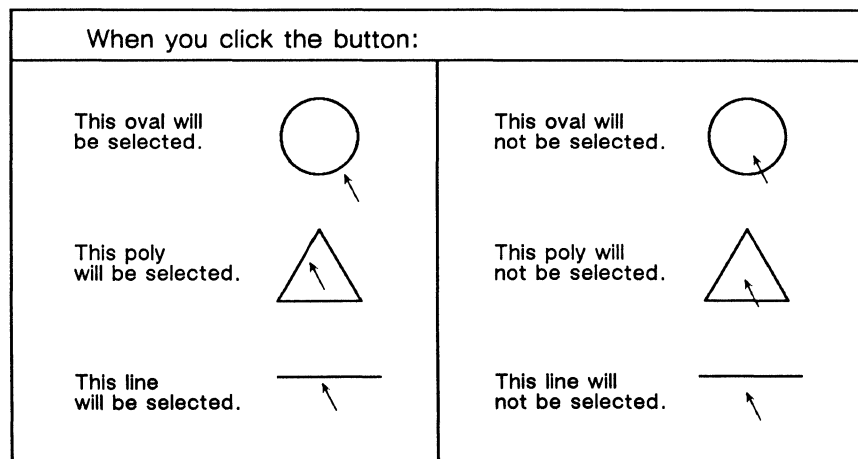

Figure 19-5. Selecting *unfilled* objects

The inside of a *filled* object is considered part of it. If you are selecting a filled object or a chart, you can point anywhere inside the object or at its border (Figure 19-6).

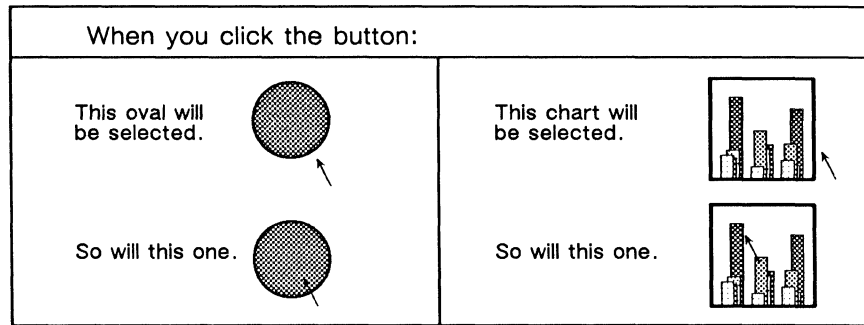

Figure 19-6. Selecting filled objects

Selecting a text string or a microdocument is like selecting a filled object: you can point the mouse cursor anywhere inside the text object and click the button to select it.

The “inside” of a text object is the region inside the *bounding box* around it. The box around a text string has no visible border or fill, whereas the box around a microdocument may have both. Figure 19-7 shows the imaginary bounding boxes on a text string and a filled, bordered box on a microdocument.

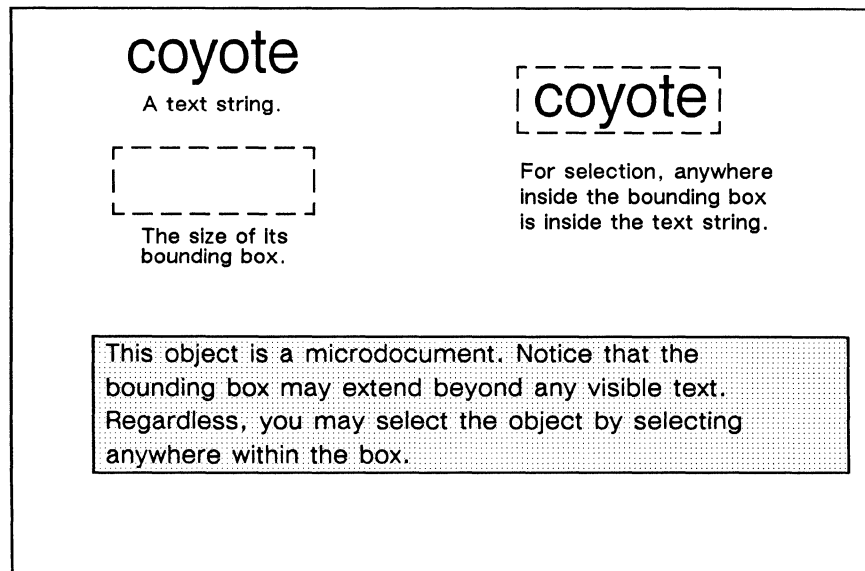

Figure 19-7. “Inside” of a text object

### Deselecting Everything

Pointing at nothing and clicking the left button is a quick way to deselect everything. Pointing at nothing and clicking the right button has no effect on selection.

## The Selection Box

If you hold down the left or right button, you will see the selection cursor. If you then move the mouse while holding down the left or right button, you will see the selection box (Figure 19-8).

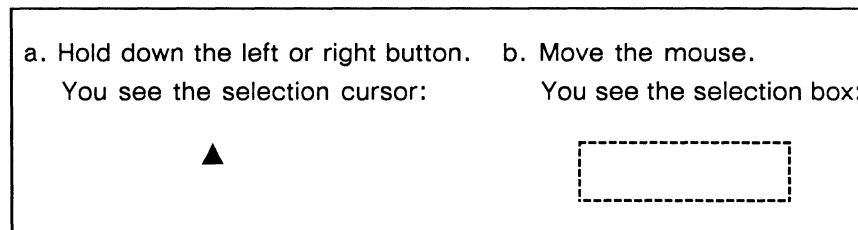

Figure 19-8. Selection and selection box

The selection box selects, deselects, or toggles selection of all objects completely contained in the box. Using the selection box is also called *drag selection*.

In Figure 19-9, when you select the three circles (step a), the shortest line also falls within the selection box. The line must then be deselected (step b).

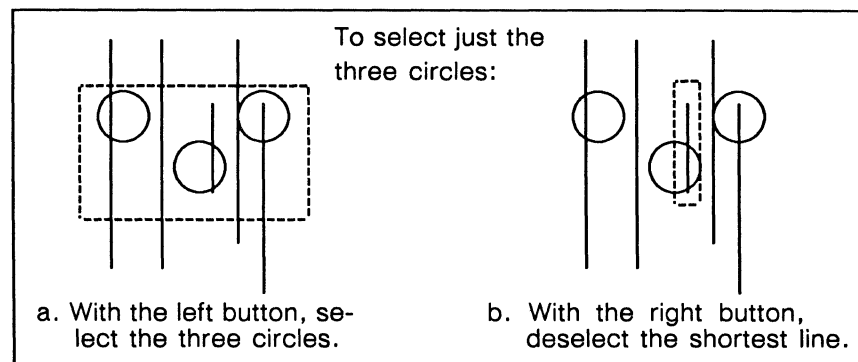

Figure 19-9. Using selection box to correct a selection problem

If you do not *completely* include an object in the selection box, the object will not be selected. This often happens with objects that are grouped together. If part of a group is outside the selection box, the group will not be selected.

## Holding and Clicking

Holding down one button and clicking the other selects all objects in a diagram or toggles the selection.

## Selection and Deselection with Popup Menu Commands

The **Select** commands are on the Select submenu of the Nothing Selected menu (Figure 19-10a). The **Select Locked** command is discussed with **Locks** in the chapter, *Advanced Diagramming Concepts*.

The **Deselect** command is the default command on the Object Selected menu (Figure 19-10b).

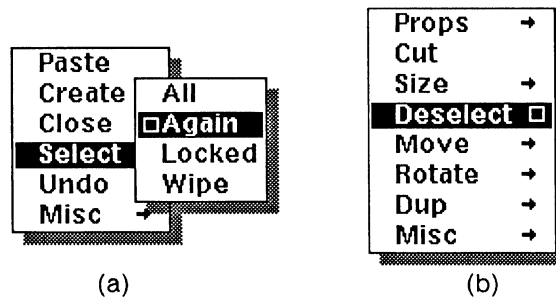

Figure 19-10. Nothing Selected menu and Object Selected menu

### Select All

The **Select All** command on the popup menu selects every object in the diagram. It has exactly the same effect as holding down the left button and clicking the right button.

### Select Again

The **Select Again** command is the most efficient way to repeat a complicated selection. It reselects the last object or group of objects that you changed. For example, if you have just changed the width of a line, **Select Again** will reselect that line. **Select Again** is the default command on the Select submenu.

Sometimes **Select Again** is the only efficient way to achieve a selection. For example, if you have moved one set of objects on top of another set and you want to select the bottom set, use **Select Again** to select the objects you moved. Then, make a selection box around both sets by holding down the right button. When you release the button, the objects you moved will be deselected, and the objects underneath them will be selected.

The diagramming system keeps a record of which objects to reselect when you execute the **Select Again** command. The record of what should be reselected is kept until you close the document that contains the diagram, even if you close the diagram and work in another.

Merely selecting an object is not performing an action on it and does not affect the record. If you have just sized a box and you select an oval and immediately deselect it, the **Select Again** command will select the box you sized because you did not perform an action on the oval.

Commands that do not affect objects — the grid commands and the commands on the Create Misc Defaults submenu, for example — do not affect the selection record.

If you execute the **Select Again** command when there is nothing in the record, nothing will be selected. This can happen after you have cut an object or when you first open a document.

### *Deselect*

The **Deselect** command deselects everything. This command is often the easiest way to deselect something because it is the default on the Object Selected menu. You just click the middle button instead of pointing at nothing and clicking the left button.

However, if you have five objects selected and you want to deselect only one, it is better to point at it and click the right button. This leaves the other four objects selected. In this case, if you were to use **Deselect**, you would then have to reselect the other four objects.

## The Wipe-Select Mode

The last choice on the **Select** submenu turns on the wipe-select mode. The cursor takes on a distinct shape ( $\diamond$ ), and you can use it to select objects by *wiping* over them. This is useful for editing drawings, where it may be difficult to select the individual lines which make up a drawing using point and click or drag select methods.

While the software is in this mode, you can also use *hold and click* methods of selecting and deselecting all objects, and you have at your disposal all of the normal diagramming menus and the commands available from them (although executing another command automatically exits the wipe-select mode).

### To enter wipe-select mode:

- ✓ Choose **Wipe** from the **Select** submenu (Figure 19-11).

*The cursor changes form.*

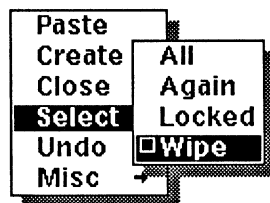

Figure 19-11. Select Wipe command

### To select using wipe-select:

- ✓ Hold down the **left** button and drag the cursor over the objects you wish to select.
- or ✓ Point the cursor at object you wish to select and click the **left** button.

**To deselect using wipe-select:**

- ✓ Hold down the **right** button and drag the cursor over the objects you wish to deselect.
- or ✓ Point the cursor at object you wish to deselect and click the **right** button.
- or ✓ Use the **Deselect** command on the Object Selected popup.

Any combination of pointing and clicking and dragging may be used in the wipe-select mode, since any object touched by the cursor while the left button is down will be added to the selection. Note that using the left button and the cursor only adds to the selection; it does not deselect other objects. To deselect objects, you must use the cursor and the right button or the **Deselect** command.

**To exit the wipe-select mode:**

- ✓ If you have made a selection, any operation, including **Deselect**, will return the software to the normal selection mode.
- ✓ If nothing is selected, you can either display and cancel the Nothing Selected menu, or execute the diagramming **Refresh** command.

## Animation and Deselection Commands

There are two kinds of commands on the Object Selected popup menu: animation commands and deselection commands.

- When you execute an **animation command**, the object is ready to be changed and stays selected until you deselect it. If you then hold down the middle button without deselecting the object, you see the Object Selected popup menu.
- When you execute a **deselection command**, the object is changed and then automatically deselected. If you then hold down the middle button, you see the Nothing Selected popup menu.

As examples, consider **Move All** (an animation command) and **Props Fill** (a deselection command).

After you execute **Move All**, the object is not changed, but it is ready to be changed. You have to move your mouse to change the position of the object. When you are satisfied with the position, you must deselect the object.

In contrast, after you execute **Props Fill**, the pattern with which the object is filled is immediately changed to the pattern you chose and the object is deselected.

Figure 19-12 shows the animation and deselection commands. The animation commands are the ones in boxes with a dashed border. All other commands are deselection commands.

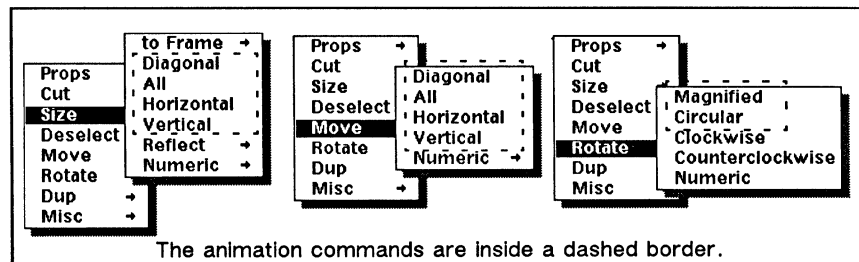

Figure 19-12. Animation commands and deselection commands

There is one command that bridges the two groups: **Dup(licate)**. **Dup** is neither strictly an animation command nor a deselection command. When you duplicate an object, the original object is deselected and the duplicate is in animation state.

## Selection State

When you select an object, it flashes to show that it is selected. The borders of the object display alternately in white and black. You will also be able to see the



pattern it is filled with. Figure 19-13 shows a black line and below it, the image of it you would see alternating with the line if you selected it.

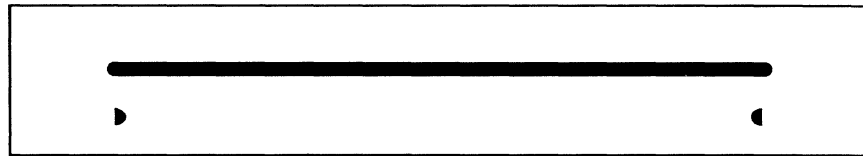

Figure 19-13. Selected line, flashing black, then white

If you select two objects that overlap, the blinking will not always be apparent because, when one is white, the other will be black, and they will cancel each other (Figure 19-14).

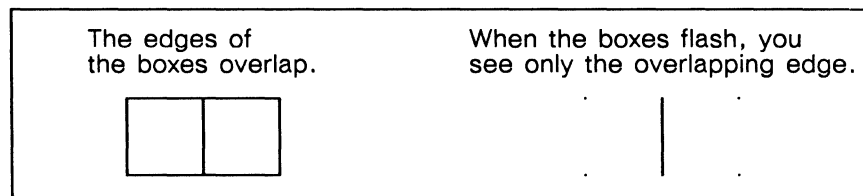

Figure 19-14. Overlapping selected objects that cancel out flashing

## Animation State

After you execute certain commands, the objects you have selected are put in animation state. It is easy to tell the difference between an object in animation state and an object that is just selected.

- If an object is in animation state, you will see only its outline. The outline will not flash, and you will see the *active control point marker* (□). The *active control point* is the point on the object through which changes (moving, sizing, rotating) are controlled.

Figure 19-15 shows an object, the same object when it is selected, and the same object in animation state.

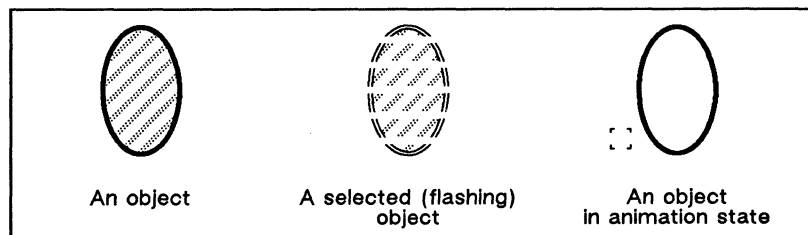

Figure 19-15. Difference between selection state and animation state

## Control Points and Anchor Points

Control and anchor points are used with the three animation commands, **Size**, **Move**, and **Rotate**. They allow you to predict and control the changes to an object you are moving, sizing, or rotating.

- **Control points** are places on an object that can be used to control changes to the object.
- The **active control point** is the particular point on an object through which changes are being controlled. The active control point is determined by the position of the mouse cursor when you *execute* an animation *command*.
- The **anchor point** marks the point on the object that is fixed when you size or rotate an object. An object that is being moved has no fixed point, so it has no anchor.

The active control point is marked with a box, shown on the left in Figure 19-16. The anchor point is marked by the four small lines shown on the right in Figure 19-16.

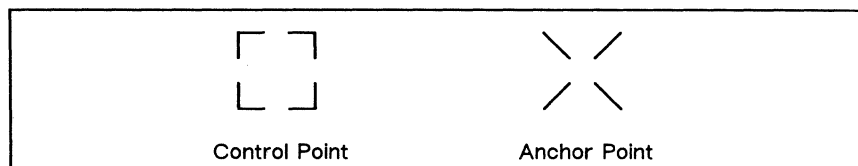

Figure 19-16. Control and Anchor points

Figure 19-17 shows how the control and anchor points help you control changes to an object.

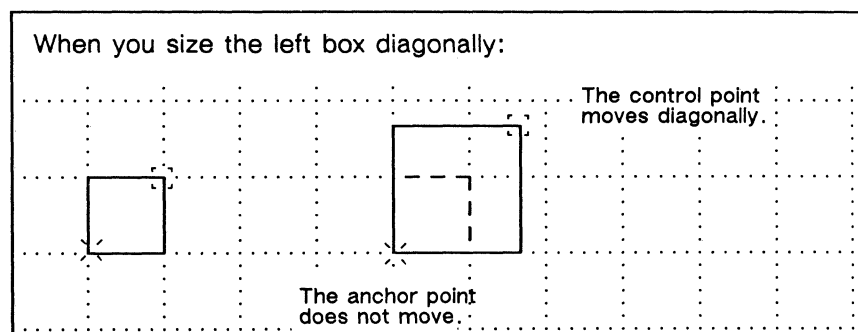

Figure 19-17. Using Control and Anchor points

## The Grid and GridAlign

The *grid*, like the squares on graph paper, marks off even segments of a diagram and helps you create neat and uniform objects. You can make the grid visible or invisible. By default, the grid is invisible.

The **Grid Type** command lets you specify either a rectangular (two-dimensional) or isometric (three-dimensional) grid. This section deals with the default rectangular grid, which has 2.5 major grid units per inch and 6 minor grid units per major grid unit. With the **Spacing** command on the Grid submenu (Figure 19-18), you can create your own grids. See the chapter *Advanced Diagramming Concepts* for a discussion of isometric and user-defined grids.

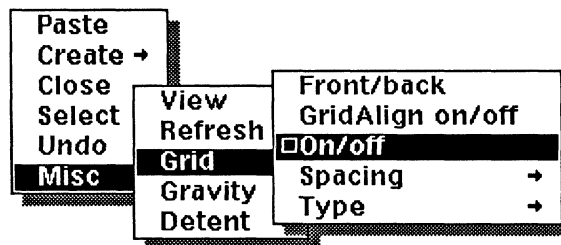

Figure 19-18. Misc Grid submenu

Figure 19-19 shows the rectangular grid and some of the terms associated with it.

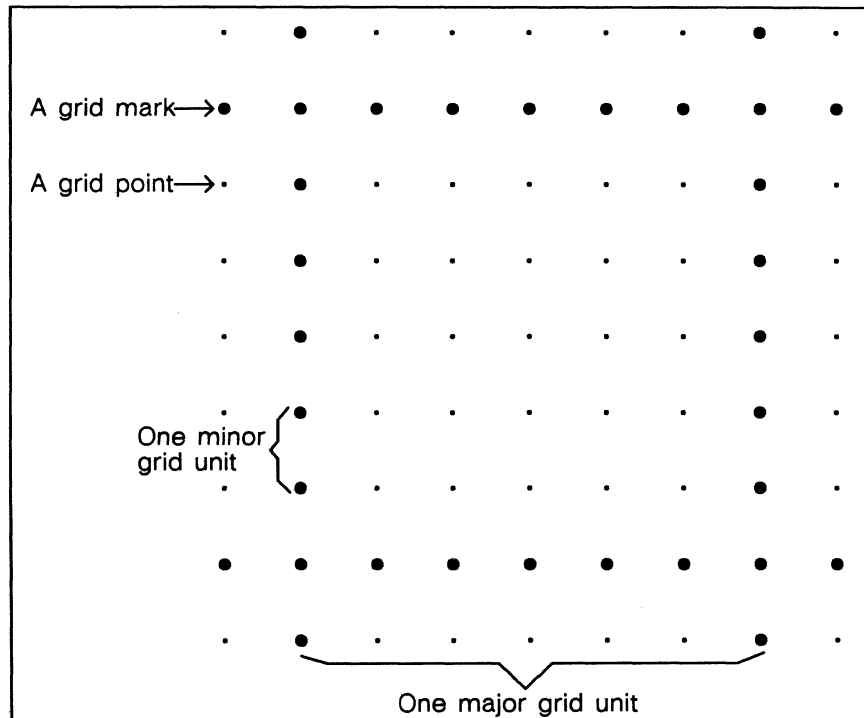

Figure 19-19. Enlargement of the rectangular grid showing its parts

Each of the dots you see on the screen is called a *grid mark*. All of the grid marks along one horizontal or vertical line make up a *grid line*.

Inside each of the squares on the grid there are invisible *grid points* (represented in Figure 19-19 by the smaller black dots).

The distance between one grid mark and another along a grid line is called a **minor grid unit**. When you are using the default grid, a minor grid unit is one-fifteenth of an inch long. The distance between one grid line and another is called a **major grid unit**; when you are using the default grid, it is six-fifteenths of an inch. Five grid squares are equal in length to two inches.

The grid does not print, whether it is visible on the screen or not.

All of the commands on the Misc Grid submenu, except **Spacing** and **Type**, are toggle commands. By default the grid is *off* (that is invisible) and **GridAlign** is *on*.

When you change any of the settings with the commands on this menu, the system records the new settings. If you close the frame or close and save the document, the next time you open the frame, these will be the settings for the frame.

## GridAlign on/off

**GridAlign** forces objects to align themselves to the grid when you are moving or sizing them. When **GridAlign** is *on*, you can move objects only in such a way that their control points line up with the grid, and you can size objects only in minor grid unit increments. Figure 19-20 shows restrictions on size and on movement.

**GridAlign** can be restrictive, but for much technical illustration, it is indispensable. Use it when you want to:

- draw horizontal and vertical lines easily
- create uniformly sized objects
- draw to scale

Even when you work with **GridAlign** off, you will usually want to work with **Gravity** on.

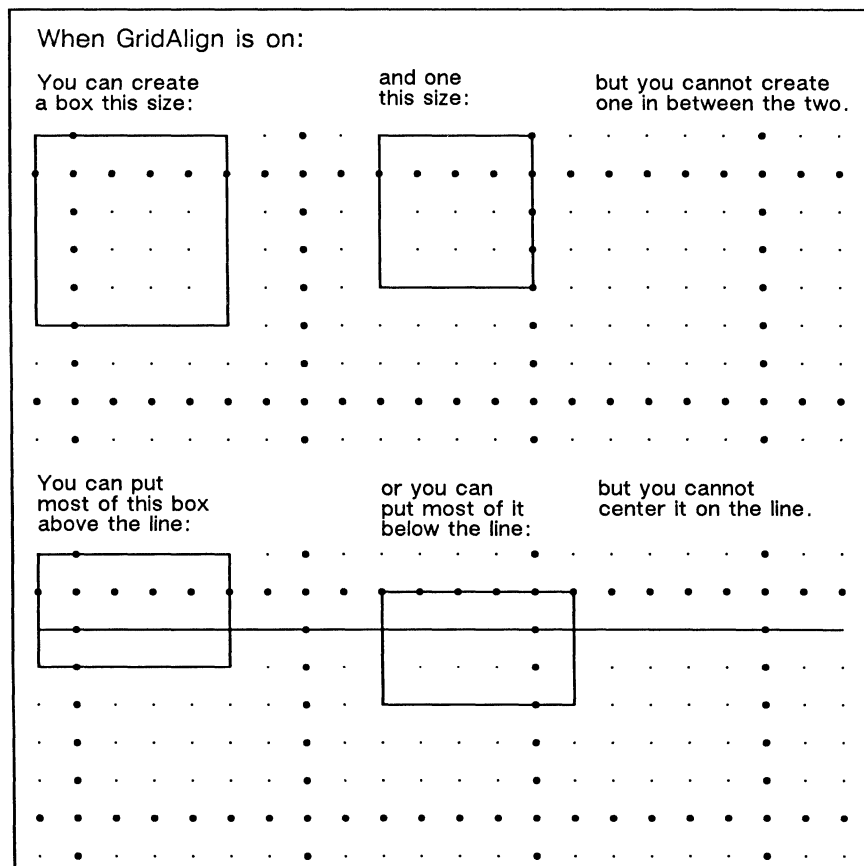

Figure 19-20. GridAlign restrictions on the size and move commands

## Grid On/off

**On/off** is the default command on the Grid submenu. It changes the visibility of the grid, but it does not affect **GridAlign** at all.

In the following circumstances, turn **Grid on** to make it visible:

- with **GridAlign on** when you want to see what objects are aligning to
- with **GridAlign off** when you want to position objects between grid points, but you want to use the grid as a guide

If the **Grid** is distracting you, turn it *off* and make it invisible.

## Grid Front/back

The **Front/back** command changes the position of the grid in relation to the objects in the diagram. The grid can be behind the objects or in front of them. By

default, the grid is in front of objects. Figure 19-21 shows a grid in front of the oval on the left and behind the oval on the right.

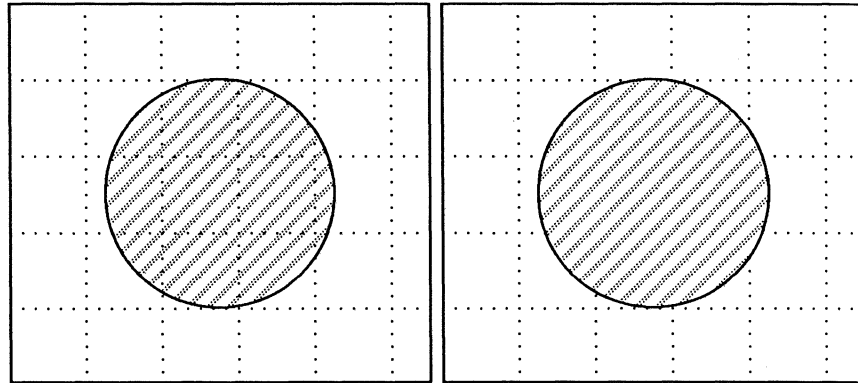

Figure 19-21. Grid in front and in back of an object

Objects in diagramming have their own order, which has nothing to do with the position of the grid. If the grid is in front and you create a new object, that new object will be put at the top of the stack of objects, but in back of the grid. If the grid is in back and you put an object at the back of the stack, that object will still be in front of the grid.

Place the grid:

- in *front* to see the grid when creating objects on top of existing objects
- in *back* to prevent the grid from obscuring your diagram

## Gravity

Gravity is an attraction objects have for each other when they are close. In diagramming, it has two main uses.

- It helps you overcome the differences between screen and printer resolutions.
- It makes it possible to connect objects easily.

By default, Gravity is *on*. If you do not want objects to be attracted to each other, you can turn Gravity *off*. The default choice on the Misc Gravity submenu toggles gravity on and off (Figure 19-22).

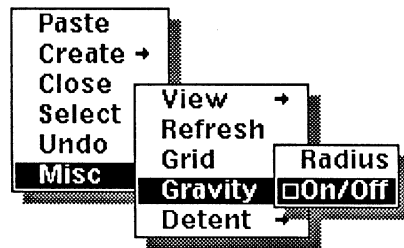

Figure 19-22. Gravity on/off command

## Gravity Points and Gravity Radius

Gravity points are the points on an object to which the control point on another object is attracted. Not every point on the border of an object is a gravity point.

Gravity radius is the distance (measured in pixels) that the control point of one object can be from a point within another object's gravity radius without snapping to the other object. The default gravity radius is four pixels. The Gravity Radius command (Figure 19-22) produces the Gravity Radius stickup (Figure 19-23), which lets you specify a gravity radius of between 1 and 8 pixels.

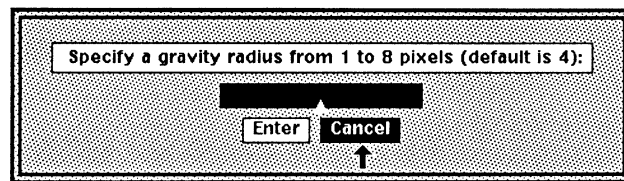

Figure 19-23. Gravity Radius stickup

When you move the control point of an object in animation state within the gravity radius of another object, the control point snaps onto the gravity point so that the two occupy the same position (Figure 19-24).

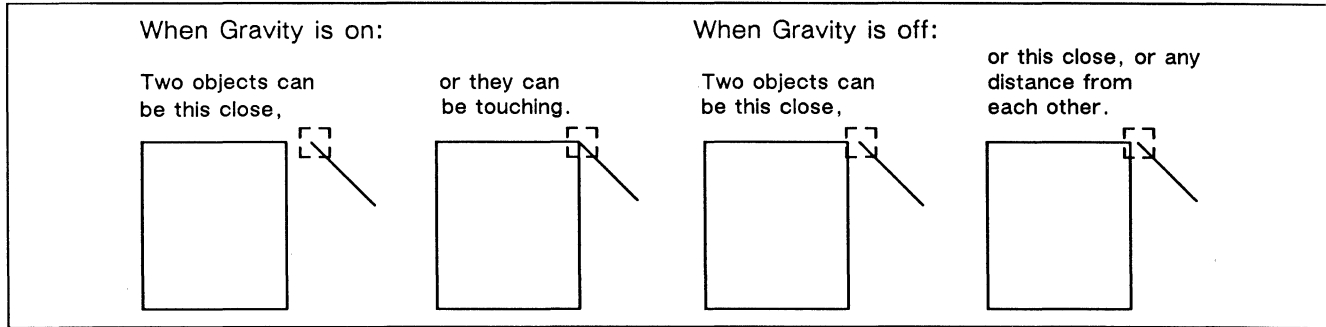









Figure 19-23. Effects of Gravity when GridAlign is Off

Objects have gravity points in the following places:

-  Lines have gravity all along their lengths. At their endpoints, they have stronger gravity so that you can easily attach lines together to make polys.
-  Arcs have equal gravity at their endpoints and midpoints.
-  Polys have the gravity points associated with the objects they are made of. They have gravity all along their edges with stronger gravity at the endpoints.
-  Splines have gravity points only at the ends of the lines they are made of.
-  A newly created box has gravity all along its border and stronger gravity at its corners.
-  A chart, like a box, has gravity along its edges and stronger gravity at its corners.
-  Ovals have eight gravity points, one at each of the four corners of the bounding box and one at each of the points that touch the bounding box. Figure 19-24 shows the gravity points on an oval.

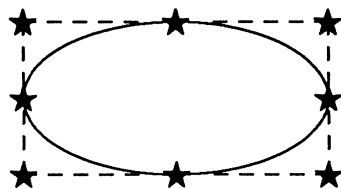



Figure 19-24. Gravity points on an oval

-  Text strings have strong gravity at the ends of their baseline.



: Microdocument :

A microdocument has gravity all along its border and stronger gravity at its corners.

## Printer and Screen Resolution

As you work with the Interleaf software, you will probably notice that your printed copy looks *better* than the screen copy. This is because printers have a higher resolution than screen displays. **Resolution** is the number of dots per linear inch that a device uses to display information. For instance, some screen displays have a resolution of 75 dots per linear inch (dpi), while the printer being used may have a resolution of 300 dpi. Screen dots are also known as **pixels**.

In the publishing software, information about illustrations is stored at a high resolution: one million dots per inch. Then the illustrations are shown — on the screen or on the printer — at the best resolution that is available.

Many features in the diagramming system exist to help you use the full resolution of the printer even though they produce no visible change on the screen. For example, the *gravity* feature ensures that lines that look connected on the screen also look connected when printed. Another example is the **Rotate Numeric** command that allows you to distinguish between angles that look the same on the screen, but look subtly different when printed.

### An Example of Resolution Differences

Imagine two hardware devices, one with a resolution of four dots to an inch (dpi) and one with sixteen dots per inch. Figure 19-25 shows one square inch on each of these imaginary devices.

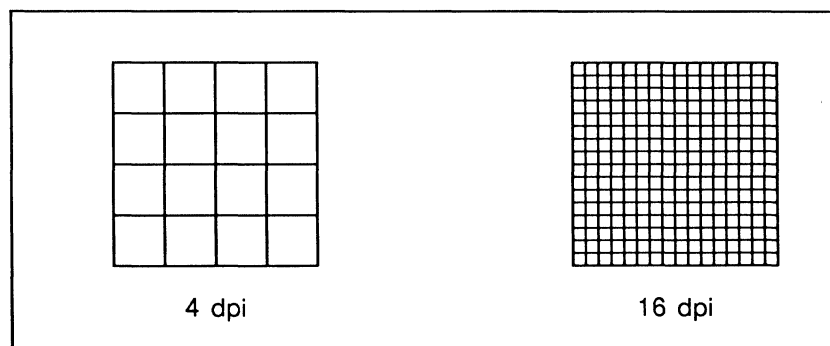

Figure 19-25. Two low resolution devices

Suppose you wanted to draw a circle on each of these devices. Figure 19-26 shows how a circle would look on a 4 dpi device and on a 16 dpi device. On the 16 dpi device, you have many more dots to work with, and, therefore, you can get a much closer representation of the circle.

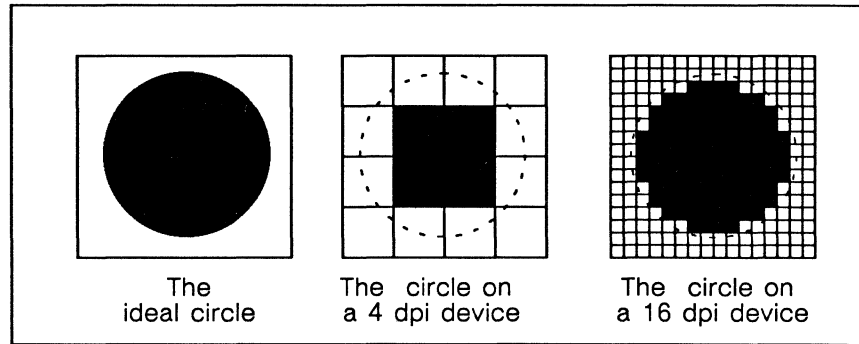

Figure 19-26. Circle shown on a 4 dpi and a 16 dpi device

The circle still isn't perfect, but if you had a 32 dpi device you could improve it, and on a 64 dpi device it would look even better. For that reason, most people want to use screen displays and printers that have the highest resolution possible.

## The View Commands: Zoom, Center, Shift, and Reset

The **Zoom** feature lets you increase and decrease the display size of a diagram and center the part of the diagram which is under the cursor. It also allows you to toggle the size of the display from the actual size to the size chosen in the last Zoom command.

The **Center** feature allows you to shift a diagram so that the point under the cursor is moved to the center of the frame.

The **Shift** feature allows you to move the diagram up, down, left, or right by half of the frame.

**Reset** lets you restore the diagram to its original size and position.

If you save and close a document in which a diagram has been adjusted by any of the view commands, the diagram will still be adjusted when you reopen it. In addition, the diagram will always be printed exactly as it appears on the screen, even if it has been adjusted. This means that objects which have been zoomed, centered, or shifted out of the frame will not be printed.

### Zoom

You access the Zoom command from the diagramming Nothing Selected popup menu (Figure 19-27).

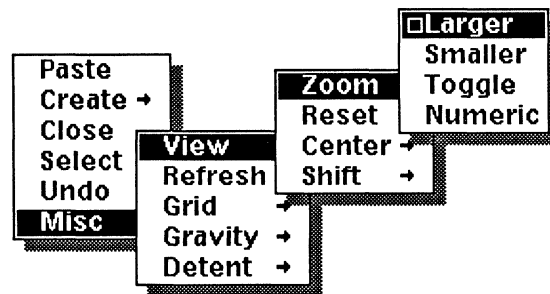

Figure 19-27. Zoom command

**Larger** increases the size of the diagram by one multiple of the original size each time the command is executed, to a maximum of 16 times original size. For instance, if the diagram is at original size and you execute **Larger**, the diagram is doubled (Figure 19-28). If you execute **Larger** with the diagram at 14 times original size, it is magnified to 15 times original size.

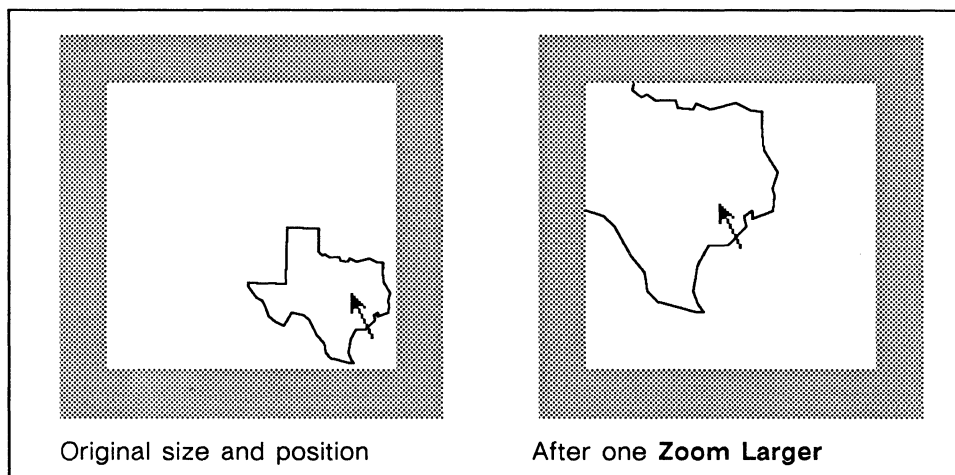

Figure 19-28. Results of Zoom Larger

**Smaller** decreases a diagram by one multiple of the original size. For instance, if the diagram were at 15 times original size, it would be reduced to 14 times original size. **Zoom** will not reduce a diagram to less than one half its original size.

The software always remembers the original size of the diagram, and the last zoomed size. **Toggle** switches from the original size to the last zoomed size, or from the current zoomed size to the original size.

**Numeric** lets you specify the display size of a diagram (Figure 19-29).

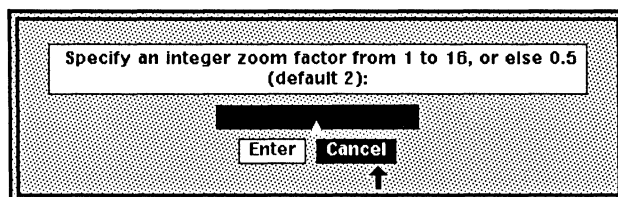

Figure 19-29. Numeric stickup

The number you enter is the multiple of the *original size* regardless of the current size. For instance, if the diagram is at 3 times original size and you type 10, the diagram will be adjusted to 10 times its original size.

When a diagram is zoomed, text strings and microdocuments move proportionally to the rest of the diagram, but do not change size. Line widths do not change when a diagram is zoomed.

## The Grid and Zoom

When you change the size and location of a diagram with the **Zoom** command, the grid is resized and repositioned accordingly. That is, the grid zooms along with the diagram.

## Center

Center appears on the Diagramming Nothing Selected Misc submenu (Figure 19-30).

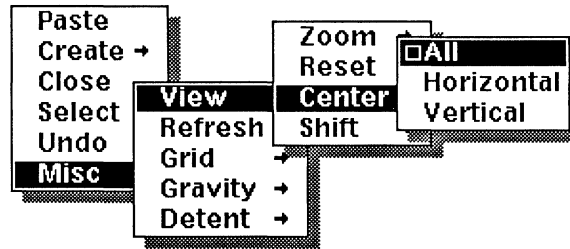

Figure 19-30. Center All command

**Center All** repositions the diagram so that the point which is under the cursor when the command is executed is moved to the center of the frame (Figure 19-31).

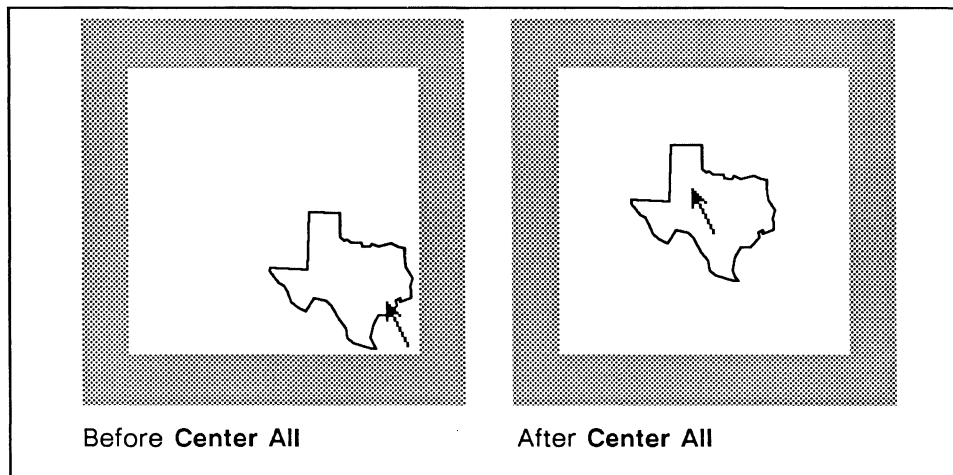

Figure 19-31. Effects of Center All

**Center Horizontal** moves the diagram horizontally so that the point under the cursor when the command is executed lines up with the horizontal center; likewise, **Center Vertical** shifts the document to the vertical center.

### Using Center for Fine Alignment Adjustments

When you use any of the **Center** commands, the cursor is moved along with the diagram so that it ends up on the appropriate center line of the frame. You can then move the cursor slightly away from this position and use the **Center** command again to make finer adjustments than you can using the Shift command.

## Shift

The **Shift Left**, **Right**, **Up**, and **Down** commands move the diagram by half the width of the frame in their respective directions (Figure 19-32).

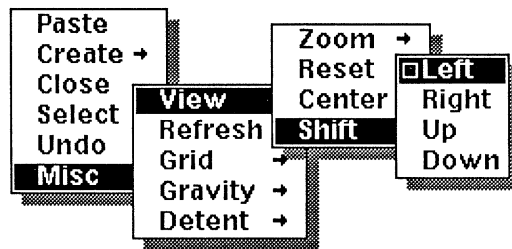

Figure 19-32. Shift Left command

These commands ignore the position of the cursor in the frame, and leave the cursor in the same position when done (Figure 19-33).

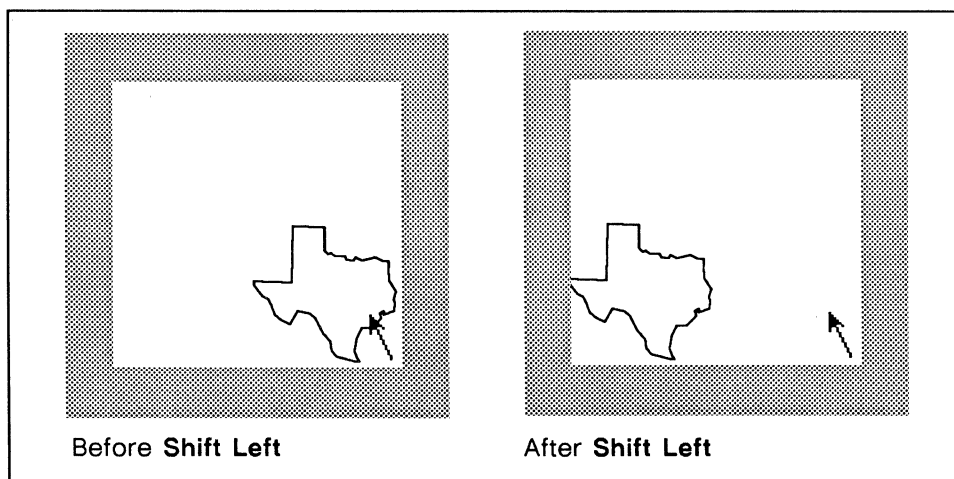

Figure 19-33. Shift Left

The **Shift** commands can be used repeatedly to provide a fast method of scrolling a diagram. This is useful when objects have been moved out of the frame by **Zoom** or **Center** commands.

---

## Chapter 20

# Objects in Diagramming

An **object** in the diagramming system is one functional unit. There are two kinds of objects: *primitive objects* and *groups*.

- A *primitive object* is one that you can create with a single command or with keyboard entry.
- A *group* is a collection of objects that can be selected as a single unit. A group may contain both primitive objects and other groups.

Figure 20-1 shows one of the primitive objects (a line) and a group (a triangle) constructed from three primitive objects.

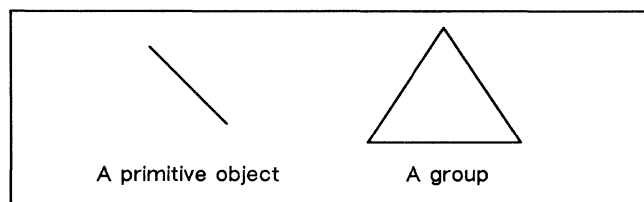

Figure 20-1. Primitive object and a group

You cannot tell by looking whether a set of objects is a group or not. The only way to tell whether the triangle in Figure 20-1 is a group or just a set of three lines is to point at one of the lines and select it. If the other two lines are also selected, then the triangle is a group.

## Primitive Objects

There are six primitive objects: arcs, ovals, lines, charts, text strings, and microdocuments. Boxes, which are actually groups of lines, are discussed as primitive objects because the group that makes up a box is prefabricated by the system.

There are a few references to charts and text objects in this chapter, but since these objects have some unique properties, they are discussed in the chapters, *Making Charts* and *Text as a Diagramming Object*. For similar reasons, arcs are discussed in the chapter, *Creating and Modifying Arcs*.

## Default Properties

A newly created object has a set of default properties associated with it.

### Size

When you create a primitive object, it has a default size. Figure 20-2 shows the default sizes for the box, the line, and the oval.

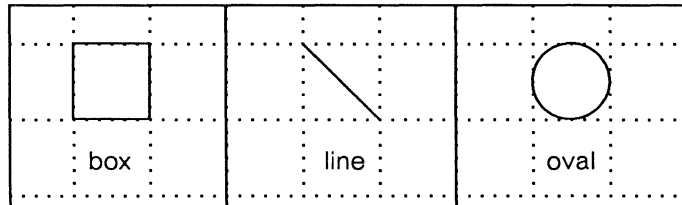

Figure 20-2. Default sizes of primitive objects

The default sizes for three of the primitive objects are based on one *default* grid square. The box is exactly the size of a grid square. The line is just long enough to run from one corner of a major grid square to the opposite corner. The oval fits exactly into a grid square.

### Fill, Width, and Dashes

The edges of boxes, lines, and ovals all have *width*. When you create one of these objects, the width will be narrow and black (—), unless you have changed the default. By default, all primitives except microdocuments have a solid pattern.

Arcs, boxes, ovals, and microdocuments also have *fill* patterns. The default fill for a newly created object is **None**. You can change the fill, width, or dash pattern defaults using the **Create Misc Defaults** command on the Nothing Selected popup menu as discussed in the chapter, *Advanced Diagramming Concepts*.

## Creating a Primitive Object

All primitive objects in the diagramming system (except text strings) are created through the Create submenus on the Nothing Selected popup menu (Figure 20-3). (Microdocuments can also be created directly from the keyboard.)

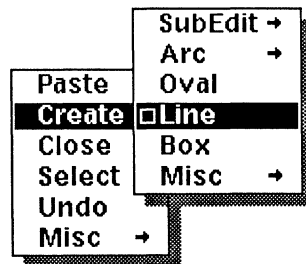

Figure 20-3. Create submenu



Most commands on the Create submenu are linked to the **Size** command. When you create an oval, line, or box, the **Size** command is automatically executed so that you can immediately change the size of the object.

The anchor point (:) of a newly created object is positioned where your mouse cursor was when you created the object. The control point (::) is below and usually to the right of the anchor point. If the object is close to the right border of the frame, the control point will be to the left of the anchor point.

The actual position of the object will be affected by **Gravity** and **GridAlign**. If **Gravity** is *on* and if the mouse cursor is within the gravity radius (four pixels by default) of a gravity point on another object, the anchor point of the new object will be superimposed on that gravity point. If **GridAlign** is *on*, the anchor point of the object will be superimposed on the nearest grid point.

An oval will be centered over the cursor position because the anchor point of a newly created oval is at the center of the oval. Figure 20-4 shows the anchor and control points on a box, a line, and an oval. The control and anchor points for a chart are the same as those for a box.

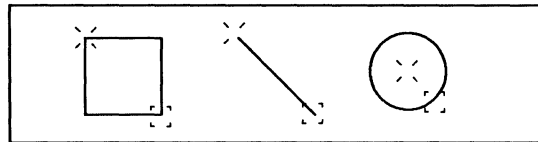

Figure 20-4. Control and anchor points on three objects

## Object Properties

Properties are the characteristics that identify an object. Many of the properties are controlled through the Props submenu of the Object Selected menu (Figure 20-5).

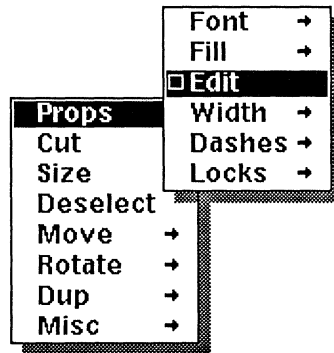

Figure 20-5. Props submenu

The default command on the Props submenu is **Edit**. The **Edit** command temporarily breaks complex objects into their component parts, so that you can change the properties of the parts independently of the whole. This use of **Edit** is discussed in the chapter, *Advanced Diagramming Concepts*. **Edit** also lets you control the shape and extent of an arc. This use of **Edit** is described in the chapter, *Creating and Modifying Arcs*.

The other commands on the Props submenu can be divided into two categories: hidden properties and basic properties. The hidden property commands are on the **Locks** submenu. They control such things as whether or not you can change the fill pattern and whether or not the object prints. Locks are discussed in the chapter, *Advanced Diagramming Concepts*.

The basic property commands are **Fill**, **Width**, and **Dashes**. They control:

- the pattern with which an object is filled
- the width of the line (or border)
- the dash pattern of the object or its border

## The Fill Property

The interior pattern of an object is changed through the Fill submenu (Figure 20-6).

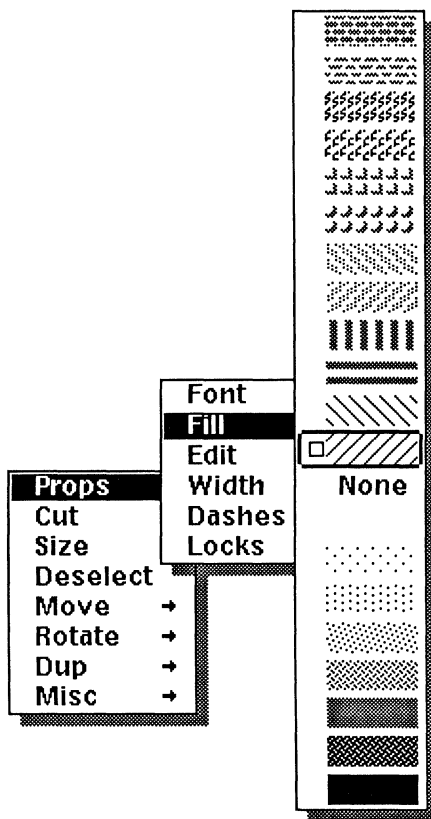

Figure 20-6. Fill submenu

Because of the difference between the resolution of the screen and of the printer, the patterns that are printed will look better than the ones you see on the screen. Figure 20-7 shows the patterns you see on the screen and the corresponding printed patterns.

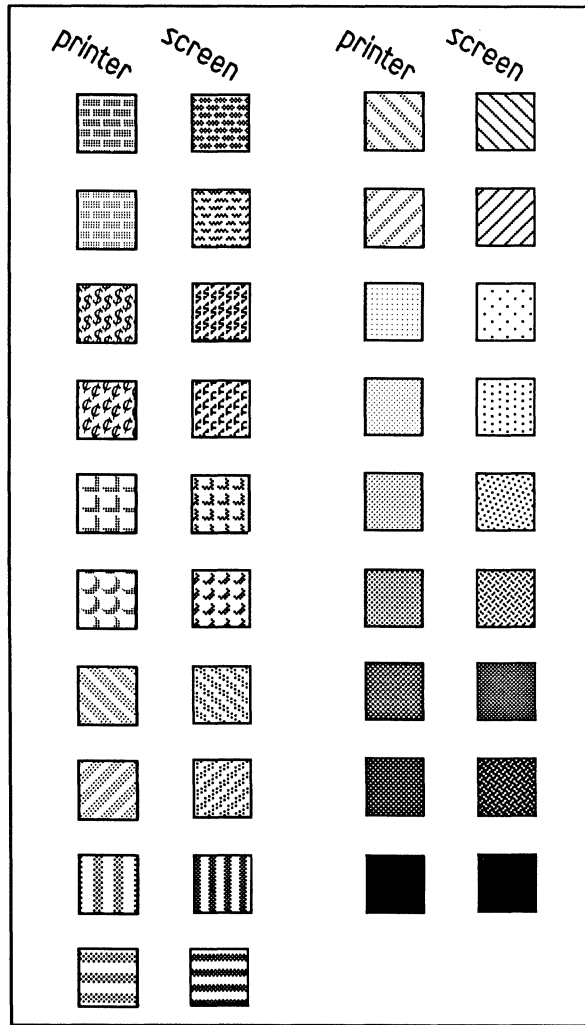

Figure 20-7. Printer and screen fill patterns

The fill patterns are laid out relative to the screen of your workstation and to the printed page, not the boundaries of the window or the object. As a result, if two objects filled with the same pattern are overlaid, the patterns will match up (Figure 20-8).

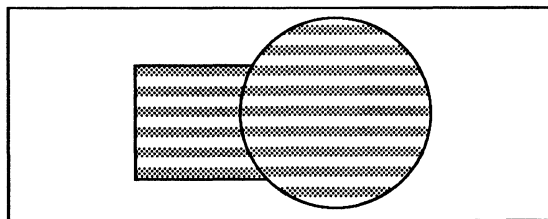

Figure 20-8. Matching patterns

Figure 20-9 shows the difference between  and .

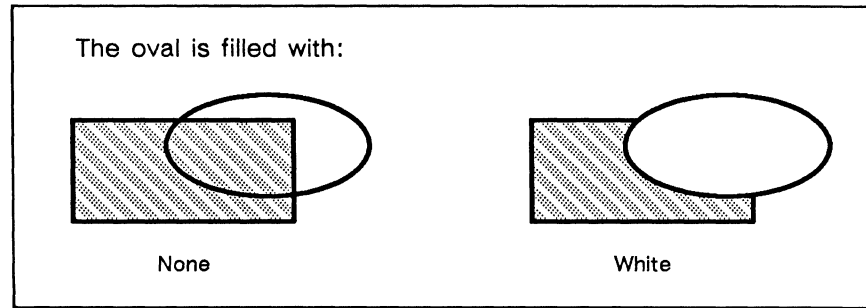

Figure 20-9. Difference between  None and

## The Width Property

Lines, ovals, arcs, microdocuments, and groups containing these objects can have width. There are thirteen possible widths, from thick black to thick white and including None. Each width is one screen pixel wider or narrower than its neighbor. Figure 20-10 shows twelve lines, one of every width.

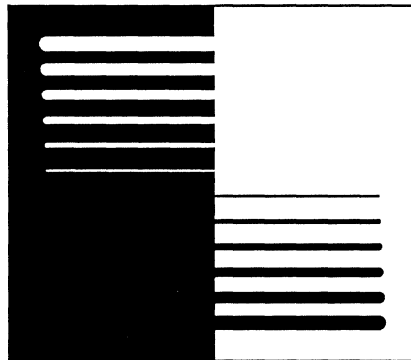

Figure 20-10. Examples of widths

The width of a line or border is changed through the Width submenu (Figure 20-11). The top half of the menu shows the white lines that are available; the bottom half shows the black lines.

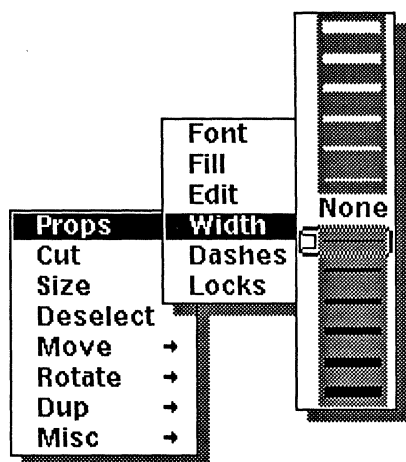

Figure 20-11. Width submenu

### Using Invisible Lines

A line width of **None** is used to allow two objects to appear to flow together. Figure 20-12 shows two pictures of a ring, the one on the left with narrow lines, the one on the right with lines that have a width of **none**.

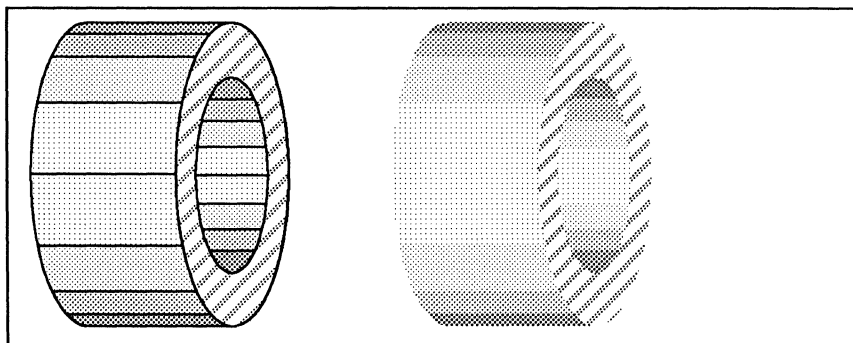

Figure 20-12. Using widths of none

### Dashes

Objects with width can have any of nine dashed and dotted patterns. The dash pattern of an object is changed through the Dashes submenu (Figure 20-13).

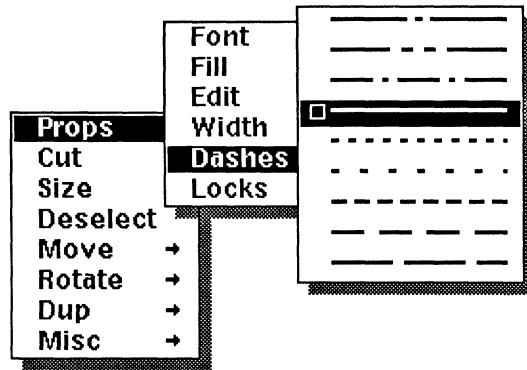

Figure 20-13. Dashes on the Props Dashes submenu

---

Note: On some printers, dashed lines are printed as solid lines. If objects that have a dashed or dotted width on the screen have a solid pattern when printed, check your *Release Notes* to see if your printer is one of those known to print dotted and dashed objects as solid.

---

## Groups

The diagramming system allows you to associate primitive objects in groups, and even to associate the groups together. You can work on a group without affecting any other group or primitive object in the diagram.

### Groups vs. Multiple Selections

Any command you execute on a group is executed on all of the objects in the group. For most operations, this is also true of any collection of objects that is selected but not grouped (Figure 20-14).

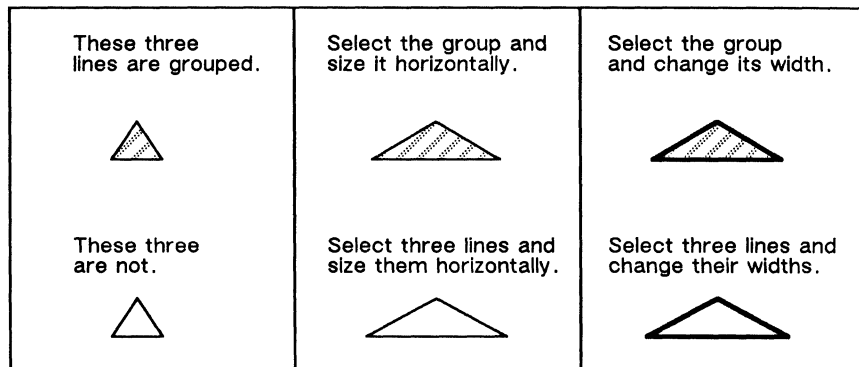

Figure 20-14. How changing a defined group is identical to changing three objects selected together

One operation which does *not* have the same effect on groups and multiple selections is **Align**. Unlike a multiple selection, when a group is aligned, all of the objects in the group retain their positions relative to one another (Figure 20-15).



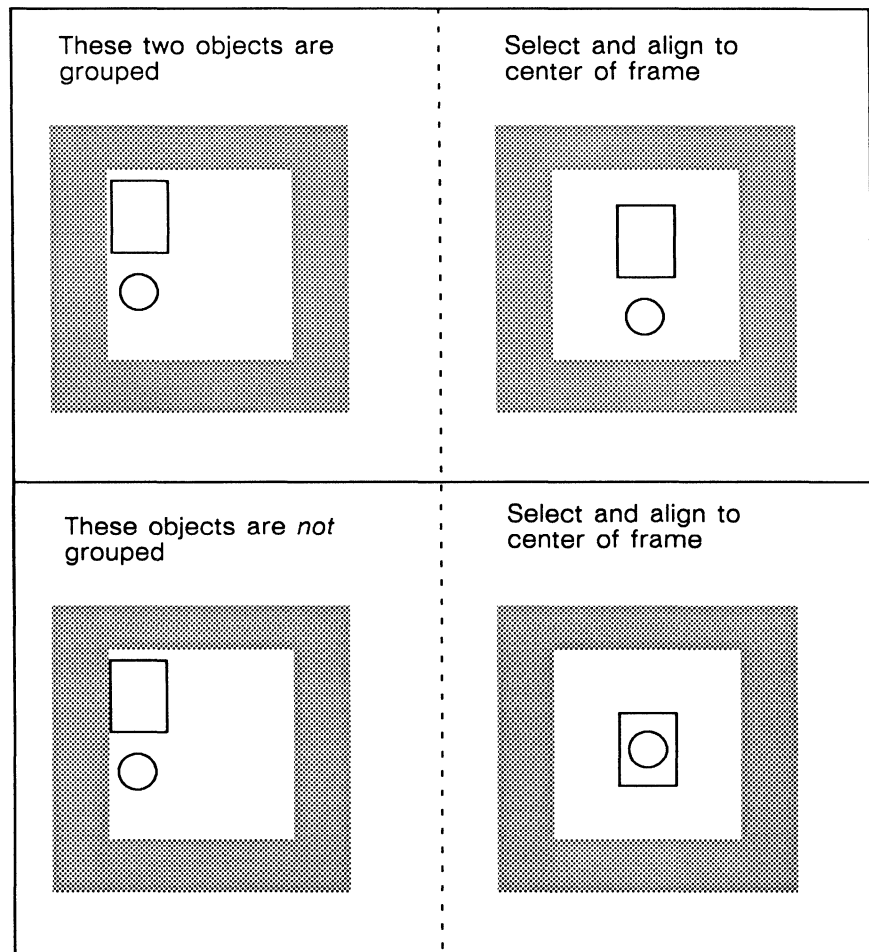

Figure 20-15. How aligning a group differs from aligning a multiple selection

## Group Hierarchies

A group can contain other groups, which in turn can contain groups, and so on.

Think of the objects and groups in a diagram as being arranged in an upside-down tree structure. This arrangement has nothing to do with the physical location of the objects in a diagram. Figure 20-16 shows the tree structure for one object.

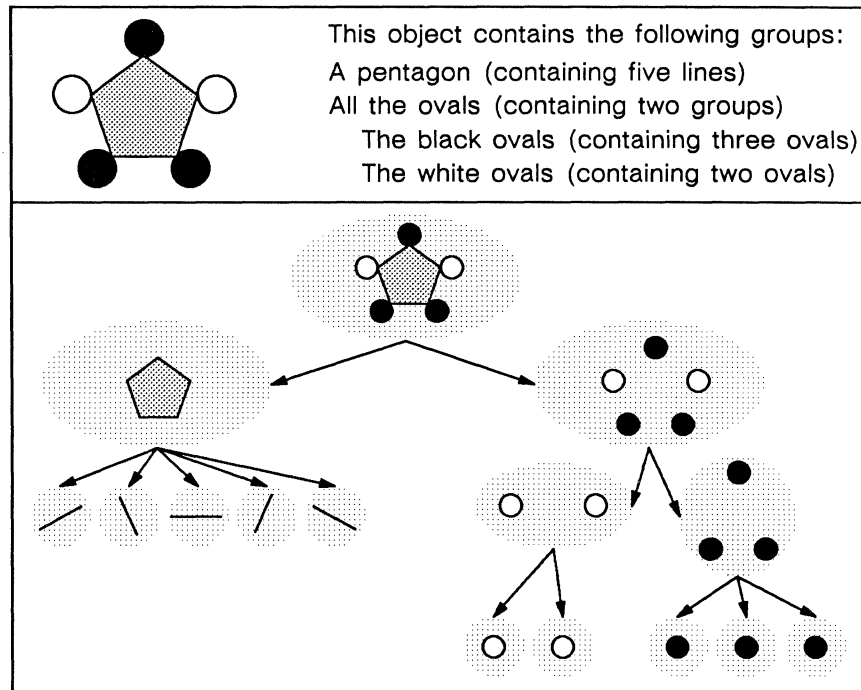

Figure 20-16. Hierarchy of a group

If you group a set of objects, you are adding a level to this tree structure. If you ungroup a group, you are removing one level.

## Creating a Group

There are two ways to create a group:

- by using the **Group** command on the Create SubEdit submenu of the Nothing Selected popup menu, and then creating the objects
- by creating the objects and then grouping them using the **Group** command on the Misc submenu of the Object Selected popup menu (Figure 20-17)

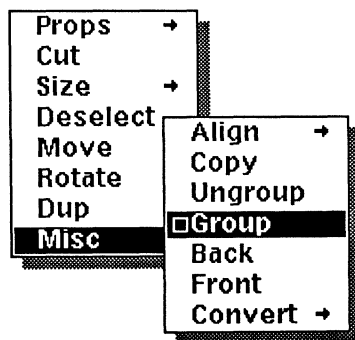

Figure 20-17. Group command on the Misc submenu

The first method is the more efficient way to create groups; but, because it is more difficult to understand until you have some experience with the diagramming system, we present the second method here. See the chapter, *Advanced Diagramming Concepts*, for a discussion of the Create Group command and the other SubEdit commands.

#### To create a group from previously created objects:

- ✓ Select the objects you want in the group and execute the **Group** command.

If you decide that you do not want a set of objects to be grouped, you can always dismantle it by using the **Ungroup** command, which is also on the Misc submenu of the Object Selected menu.

#### To ungroup a set of objects:

- ✓ Select the group and execute the **Ungroup** command.  
*If you select more than one group, each group will be broken down into its parts.*

If you select some groups and some primitive objects, the groups will be disassociated, and the primitive objects will be left intact.

If you try to ungroup the objects in a group and nothing happens, the group may be locked. See the chapter, *Advanced Diagramming Concepts*, for information on locking and unlocking.

## Modifying Groups

You can execute any of the diagramming commands on a group. You can change the width of the lines in it, you can size it, move it, rotate it, and duplicate it. You can also change the group's fill.

The changes you make will affect all of the objects in the group (Figure 20-18).

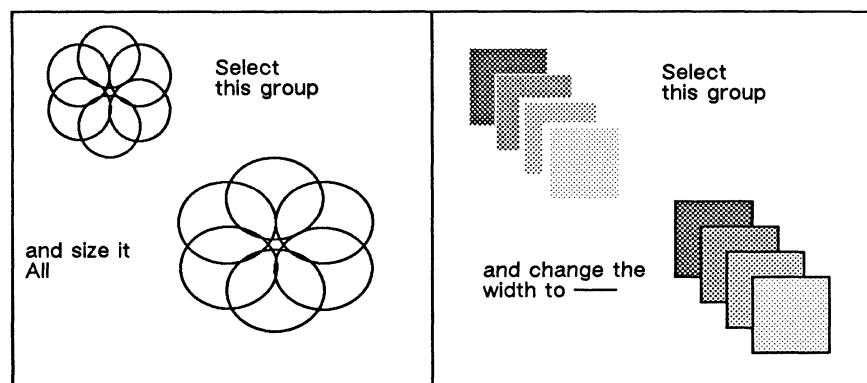

Figure 20-18. Modifying a group

## Filling Objects – Paths

The following primitive objects can be filled: arcs, ovals, and boxes. Each of these objects can be thought of as a **path** that partially or fully surrounds the area to be filled. (A line is also a path, but since a *single* straight line encloses no area, it cannot be filled.) Figure 20-19 shows some fillable paths and a line.

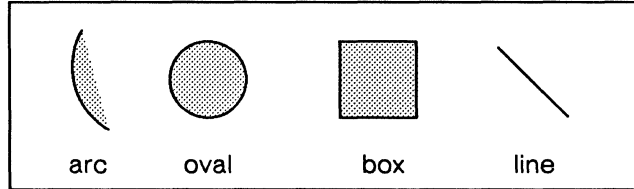

Figure 20-19. Paths

Figure 20-20 shows that paths can be connected to form larger paths. Paths made of more than one object can be filled *when no more than two objects are joined at any vertex (intersection)*.

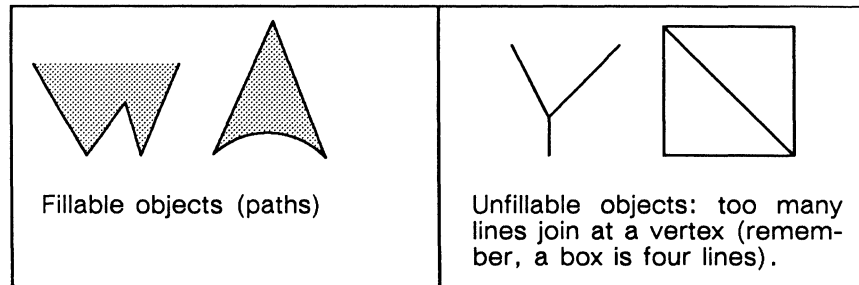

Figure 20-20. Fillable paths and unfillable objects

## Polys – Filled Groups of Paths

A poly is a *filled* group of paths. The most basic type of **poly** is a single path made of two or more connected paths that are filled (Figure 20-21). Another example of a poly is a filled box.

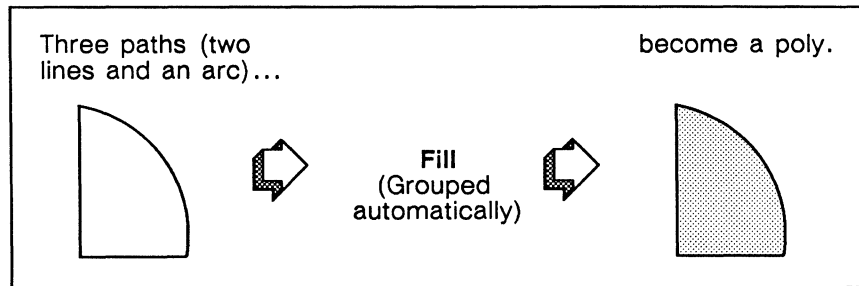

Figure 20-21. Creating a poly

---

Note the distinction between a poly and a textbook *polygon* (a closed shape bounded by three or more straight edges). A poly may be, but is not necessarily, a polygon.

The concept of paths and polys is helpful in predicting what will happen when you attempt to fill a multiple selection of objects, especially when you want to create objects with holes.

## Objects with Holes

Figure 20-22 shows an object with several holes in it.

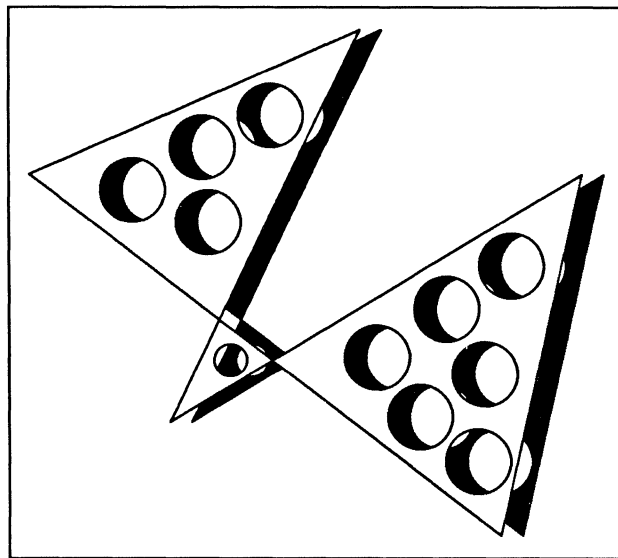

Figure 20-22. An object with holes

You can create an object with one or more holes in it by grouping paths which overlap, then filling the group (Figure 20-23). The areas where the paths overlap will become holes.

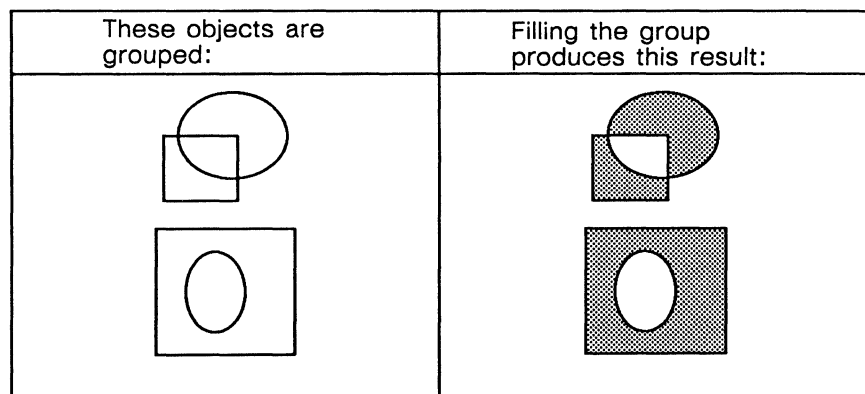

Figure 20-23. Creating holes in objects

Note that if you fill overlapping paths which are *not* grouped, the result is merely a collection of filled objects (Figure 20-24).

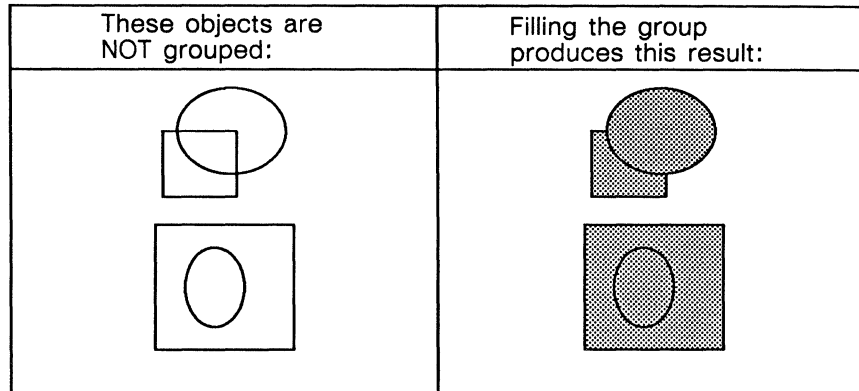

Figure 20-24. Ungrouped, overlapping, filled objects

Figure 20-25 shows that paths made of more than one object, in this case a series of connected lines, can also be used to create an object with a hole in it.

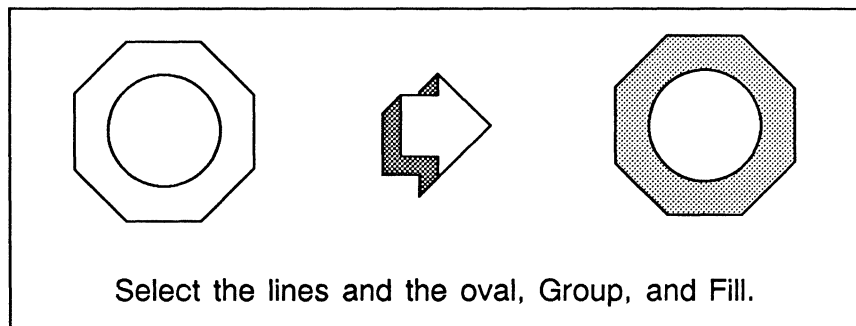

Figure 20-25. Using multiple objects to create a poly with a hole

## Using Thick Lines in Polys

The control point of a line is always at the center of its width, not along the edge. One result is that when you are using thick lines, you may think two objects are matched up that are not, which may make it difficult to create polys. For this reason, it is better to create a poly with thin lines and then change its width than to begin with thick lines.

## Splines

A spline is a poly in which any intersection of two lines forms a smooth, curved corner. You can think of a spline as a poly with curved edges and rounded corners instead of straight edges and pointed corners (Figure 20-26).

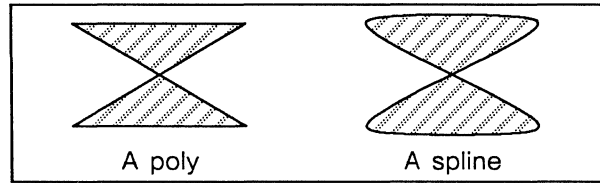

Figure 20-26. Poly and spline

Figure 20-27 shows an octopus created with splines.

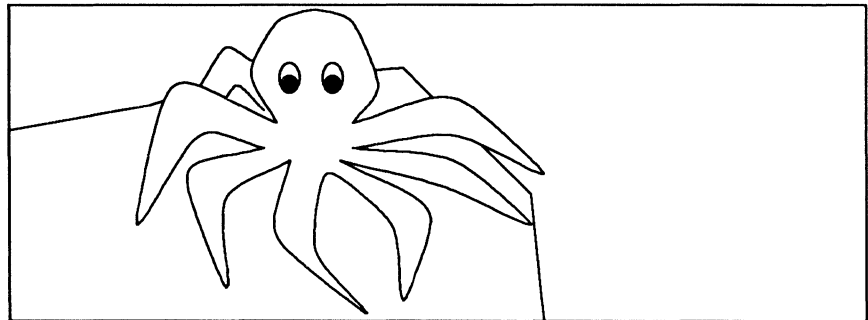

Figure 20-27. Spline octopus

As with groups and polys, there are two ways to create splines:

- use the command **Create → SubEdit → Spline** on the Nothing Selected popup menu
- create one or more polys, and use the command **Misc → Convert → to Spline** on the Object Selected popup menu (Figure 20-28)

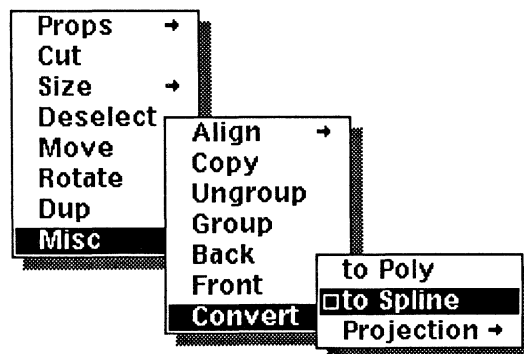

Figure 20-28. Convert command on the Misc submenu

As with groups and polys, the first method is the more efficient way to create splines, but we present the second method here because it requires less experience. Please see the chapter, *Advanced Diagramming Concepts*, for a discussion of the **Create Spline** command and the other **SubEdit** commands.

**To make a spline or splines from lines:**

- ✓ Select the lines, or the object containing the lines, and execute the **Convert to Spline** command.

*Any intersection of two lines will be smoothed.*

You can convert any poly — or any set of objects that could be made into a poly by grouping and filling — into a spline. If you convert a connected set of lines to a spline, they will automatically be grouped together.

If you try to convert a selection of objects containing intersections of lines and arcs, (which cannot be converted), only intersections of lines are converted to splines, but *all* of the selected objects are grouped. If you try to convert a set of objects that contains no intersections which can be converted to splines, nothing happens.

All of the diagramming commands except **Font** can be performed on a spline. When you change the size of a spline, you change the size of the whole object without changing the relative positions of the endpoints of the curves.

There are two ways to change the relative positions of the endpoints of the curves. You can edit the spline (as described in the chapter, *Advanced Diagramming Concepts*), change the lines, and then close the edit. Or, you can convert the spline to a poly, ungroup it, change the lines, select all of the lines again, and convert them back to a spline (Figure 20-29).

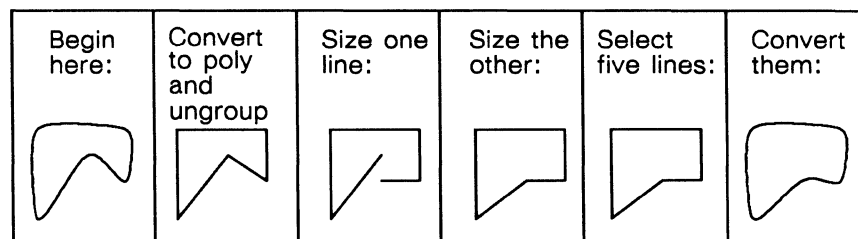

*Figure 20-29. Changing the position of the endpoints in a spline*

A spline has gravity and control points at the corners of the object it was made from.

The **Convert to Poly** command on the Misc submenu turns splines into polys.



To make polys from splines:

- ✓ Select the polygon and execute the **Convert to Poly** command.

*Any smoothed intersections of lines will be converted to sharp angles.*

## ◆ **Control Point and Anchor Point Locations**

Knowing exactly which control point and anchor point will be chosen helps you to predict how you can change an object. If you need to move, size, or rotate an object precisely, the information in this section may be helpful.

Whenever you move, size, or rotate an object, the diagramming system chooses one point from the set of possible control points to be the *active control point*.

The *anchor point* is chosen to complement the active control point. It is usually another of the control points on the object or group, but in the case of **Rotate** commands it may not be.

The two factors that determine the positions of the active control point and the anchor point are the animation command you choose and the position of the mouse cursor just before you issue the command.

---

Note: Control and anchor points for arcs are discussed in the chapter, *Creating and Modifying Arcs*.

## Control and Anchor Points on a Primitive Object

The active control point can be at either end of a line or at any one of the corners of a box or chart. The active control point on an oval can be at any one of the four corners of the oval's bounding box or in the center of the oval. See Figure 20-30.

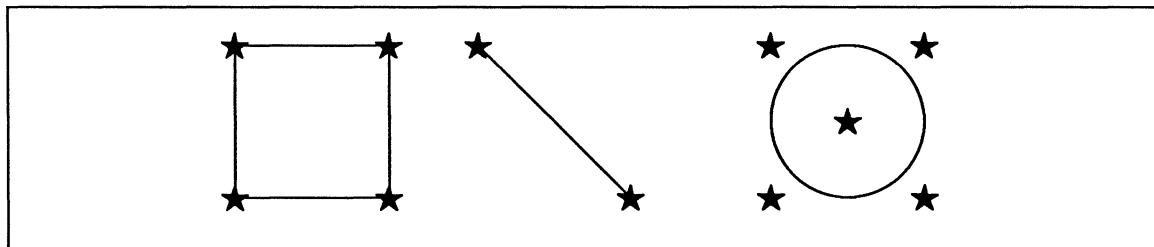

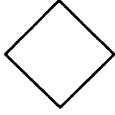



*Figure 20-30. Possible locations for the active control point*

## Predicting Control and Anchor Points

The anchor point is also limited to a few positions. Its location is further restricted by the active control point, which is always determined first. The anchor is chosen to complement the control point, according to the rules described in the following table.

To allow smooth rotations, the distance between the control and anchor point during a rotation must be at least 60 pixels (approximately one inch). Therefore, when you rotate a small object, the active control point may appear at a point beyond the normal location.

Object	Operation	Active control point	Anchor point
Line 	<b>Size, Rotate Magnify</b>	Endpoint closest to cursor.	Opposite endpoint.
	All other <b>Rotate</b> commands	Endpoint closest to cursor.	Midpoint.
Box 	<b>Size</b>	Corner of box closest to cursor.	Opposite corner.
	<b>Rotate Magnify</b>	Control point closest to cursor.	Opposite corner.
	All other <b>Rotate</b> commands	Corner of box closest to cursor.	Center of box.
Rotated Box 	<b>Size</b>	Corner of bounding box closest to cursor.	Opposite corner of bounding box.
	<b>Rotate Magnify</b>	Corner of box closest to cursor.	Opposite corner.
	All other <b>Rotate</b> commands	Corner of box closest to cursor.	Center of box.
Oval 	<b>Size</b>	If cursor is closest to center point, then center point. Otherwise, nearest of the corners of the bounding box.	Center or corner of bounding box opposite the active control point.
	<b>Rotate Magnify</b>	Same as for <b>Size</b> operations.	Same as for <b>Size</b> operations.
	All other <b>Rotate</b> commands	Corner of bounding box closest to cursor.	Center of oval.

## Control and Anchor Points on a Group

All of the control points for individual objects in a group are also control points for the group. Figure 20-31 shows the control points on a group consisting of three boxes. There are twelve control points in this group because each of the boxes has one at each of its corners.

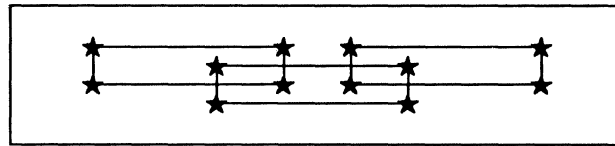

Figure 20-31. Control points on a group

The location of the active control point and the anchor on a group depend on the command and the position of the mouse cursor when the command is executed.

When you **Move** a group, the active control point is the control point on a primitive object nearest the cursor, and there is no anchor point.

When you **Size** a group, the diagramming system draws an imaginary bounding box around the group, through the four outermost control points. Then it chooses the corner of the bounding box nearest the cursor as the active control point and the corner that is farthest from the cursor as the anchor point. Figure 20-32 shows the control and anchor points that would be used for sizing a simple group.

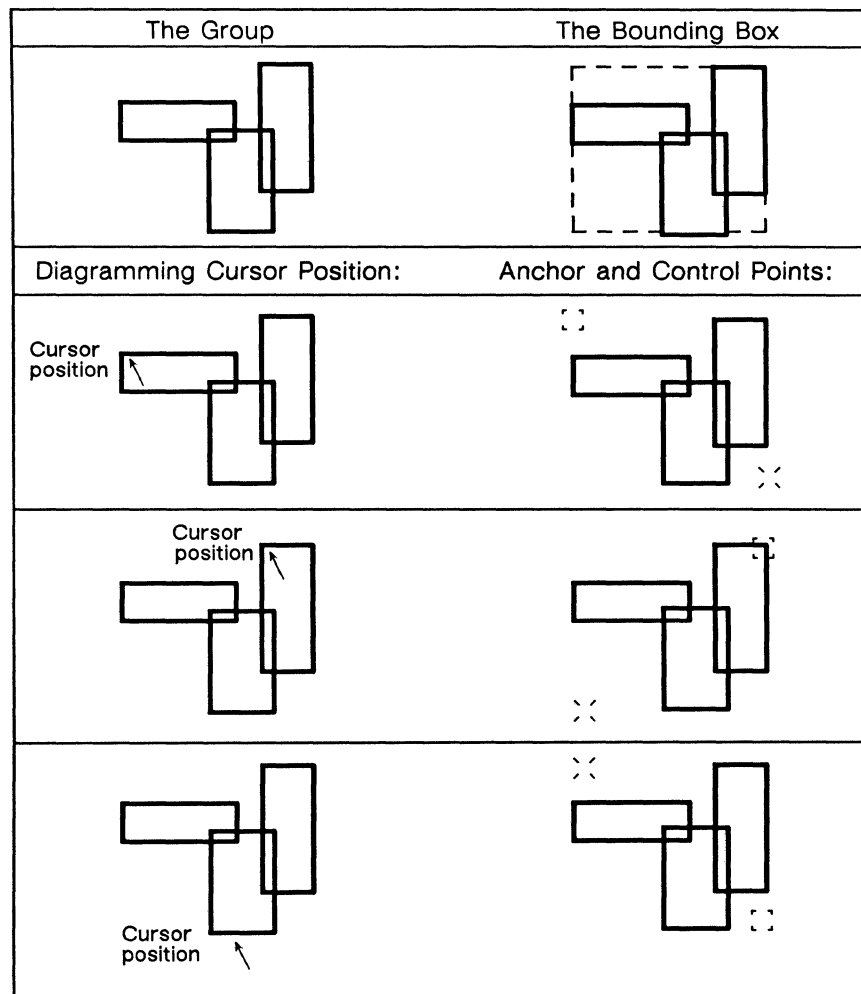

Figure 20-32. Anchor and control points for sizing groups

When you *rotate* a group, the active control point is the control point on a primitive object nearest the cursor when you execute the **Rotate** command. When you *rotate and magnify* a group, the anchor point is the control point on a primitive object that is farthest away from the cursor.

For the other **Rotate** commands, the diagramming system chooses for the anchor point a point near the center of the group, based on the distribution of control points in the group. If the control points are evenly distributed, the anchor point is in the middle. If more of the control points are on one side, the anchor point is closer to that side. Figure 20-33 shows some groups, and the anchor points around which they rotate.

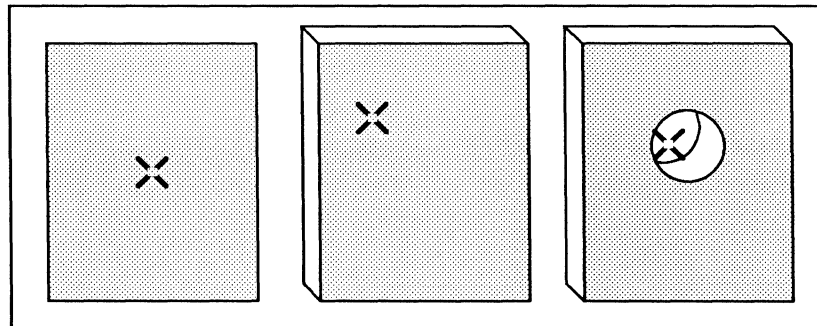

Figure 20-33. Anchor points for rotating groups

### The Effect of Gravity and GridAlign on the Active Control Point

All of the restrictions on motion in the diagramming system affect the active control point. The active control point is:

- attracted to grid points
- attracted to the gravity points of other objects

### Control and Anchor Points on Very Small Objects

When you size, move, or rotate a very small object, the markers for the control and anchor points are not displayed. Beyond a certain point, the markers obscure the object rather than highlight it. For that reason, the markers are displayed only if the active control point and the anchor point are at least three minor default grid units apart either horizontally or vertically (Figure 20-34).

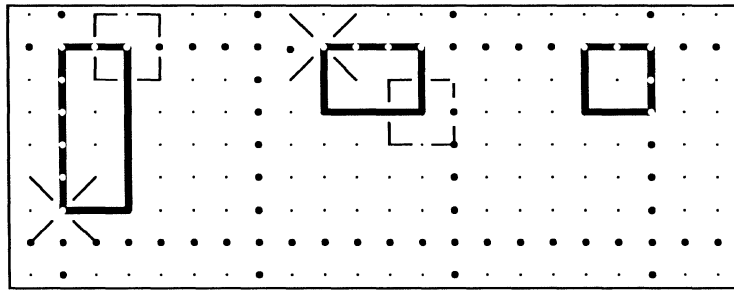

*Figure 20-34. Visibility of control and anchor point markers*



---

## Chapter 21

# Modifying Diagrams

This chapter presents some of the commands that allow you to manipulate objects in a diagram. These commands are the:

- Move commands
- Size commands
- Rotate commands
- Dup commands
- Align commands
- Undo command

## Animation and Deselection Commands

Many of the commands covered in this chapter are *animation commands*. Using these commands involves four steps: selecting the object, executing the command, moving the mouse until the object is the correct size or in the correct position, and deselecting it.

Some of the other commands (*deselection commands*) may require you to type numeric information on a stickup menu. On a stickup you can enter as many as nineteen digits including a decimal point.

The first time you see each stickup menu after opening your desktop, a default value will appear. If you type a new number, that number will be the default the next time you see this stickup. The new value will reappear each time you see the stickup until you change the value or until you close the desktop.

## Moving Objects

Figure 21-1a shows the Move submenu of the Object Selected menu. If you see the menu in Figure 21-1b the grid type has been changed to isometric. For a discussion of using the isometric grid and this menu, see the chapter *Advanced*

*Diagramming Concepts.* To get the normal Move submenu, just change the grid type back to rectangular, using the Misc Grid Type submenu.

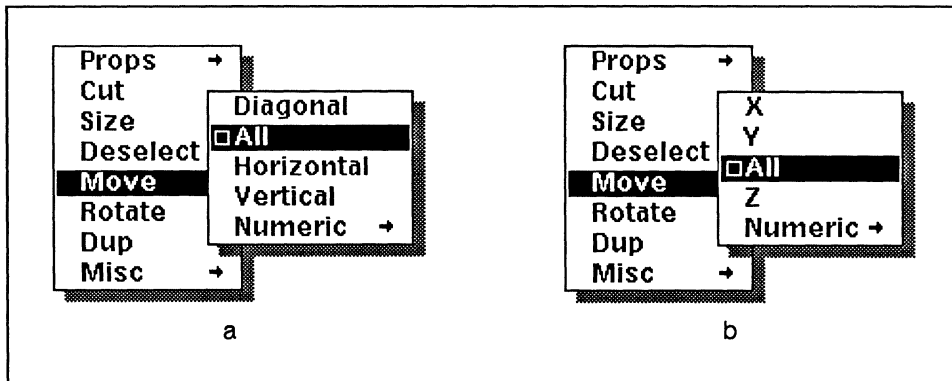

Figure 21-1. Move submenu

The first four Move commands are animation commands. Move Numeric is a deselection command.

### Move Diagonal

Move Diagonal allows you to move an object or group of objects along an imaginary diagonal line drawn through two corners of an imaginary bounding box around the objects. The corner of the bounding box that is closest to the mouse cursor when the command is executed becomes the active control point.

Figure 21-2 shows some of the lines along which you can move a simple group.

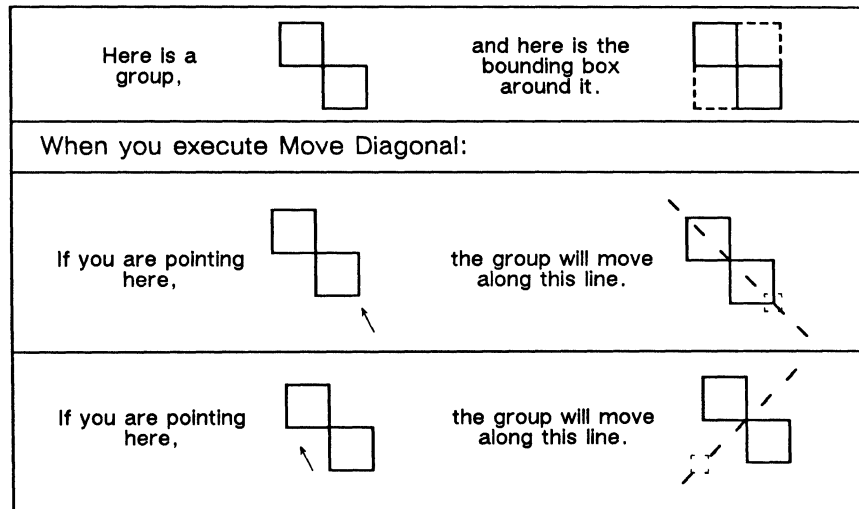

Figure 21-2. Moving a group along a diagonal

### Move All

Move All allows you to move an object in any direction. It is the default command on the Move submenu.



## Move Horizontal and Move Vertical

**Move Horizontal** allows you to move an object left or right only. **Move Vertical** allows you to move an object up or down only. The two commands are useful when the position of an object is correct along one axis, but you want to change its position along the other axis.

## Move Numeric

You use the commands on the **Move Numeric** submenu to move an object a specific number of minor grid units left, right, up or down. The default minor grid unit is one-fifteenth of an inch.

Using this information, you can determine exactly how far apart you want two objects to be. You might decide to move an object exactly half an inch (7.5 default minor grid units) to the right, or you might prefer to set up your own grid. See the section, *Creating Your Own Grids*, in the chapter, *Advanced Diagramming Concepts*.

Figure 21-3 shows the Move Numeric submenu. (This menu will look different if the grid type is isometric.)

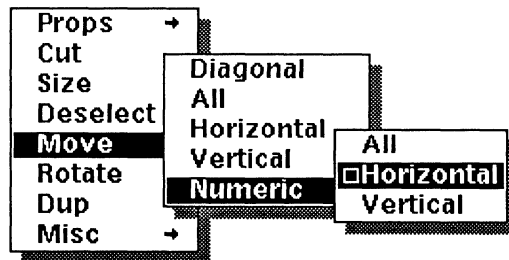

Figure 21-3. Move Numeric submenu

**Move Numeric Horizontal** allows you to move an object to the left or right. When you execute **Move Numeric Horizontal**, the stickup in Figure 21-4a appears. **Move Numeric Vertical** allows you to move an object up or down. When you execute **Move Numeric Vertical**, the stickup in Figure 21-4b is displayed. The default value on these stickups is *6 minor grid units*.

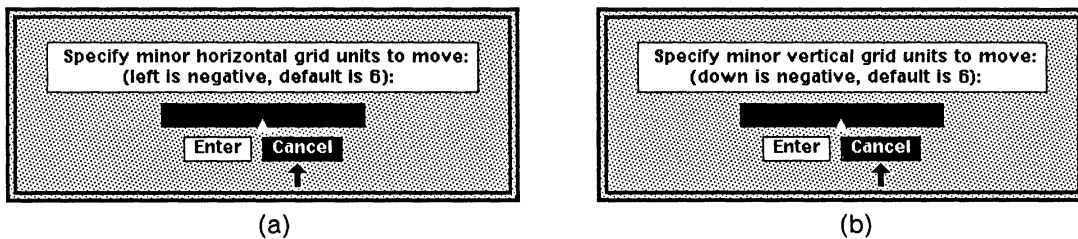

Figure 21-4. Move numeric stickups

To move an object to the right or up, type a positive number in the stickup. To move an object to the left or down, type a negative number. Then execute the **Enter** command on the stickup, or press **Return**.

**Move Numeric All** allows you to move an object both horizontally and vertically in one operation. First you will see the Move Numeric Horizontal stickup; after you have entered a value in it, you will see the Move Numeric Vertical stickup.

## Sizing Objects

The **Size** command allows you to change the size and proportional shape of an object. Figure 21-5 shows the Size submenu of the Object Selected menu.

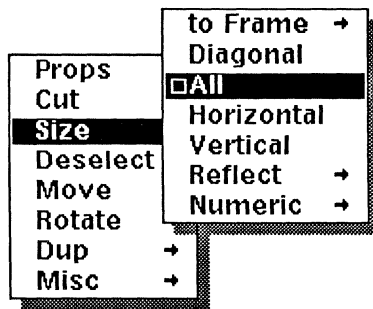

Figure 21-5. Size submenu

There are four animation commands on the Size submenu: **Size Diagonal**, **Size All**, **Size Horizontal**, and **Size Vertical**. Figure 21-6 shows a square and the kinds of changes each of the animation commands would allow you to make to it.

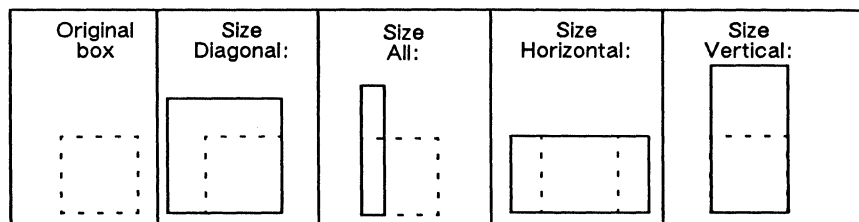

Figure 21-6. Using the Size animation commands

### Size Diagonal

Sizing an object diagonally preserves its proportions — it doesn't change the relative height and width of the object.

### Size All

**Size All** allows you to change the size of an object both horizontally and vertically. It does not preserve the proportions of the object. **Size All** is the default on the Size submenu.

## Size Horizontal and Size Vertical

**Size Horizontal** allows you to change the width of the object without changing its height. **Size Vertical** allows you to change the height of the object without changing its width.

There are three deselection commands on the Size submenu: **Size to Frame**, **Size Reflect**, and **Size Numeric**. The deselection commands change the size of an object by some specified amount and then deselect the object.

### Size to Frame

The **Size to Frame** commands change the size of the object so that the outermost points on it touch the edges of the frame. If you have more than one object selected, the **Size to Frame** command will use the outermost points of the whole set, not of the individual objects in the set. Figure 21-7 shows the Size to Frame submenu.

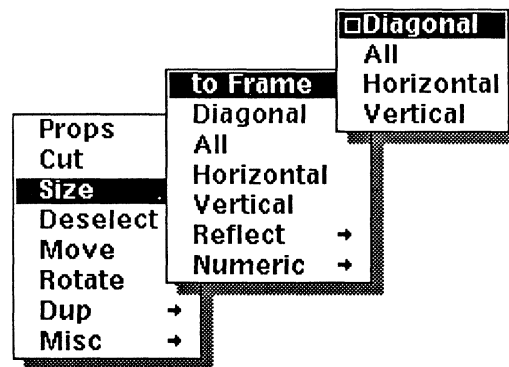

Figure 21-7. Size to Frame submenu

There are four choices on the Size to Frame submenu.

- **Size to Frame Diagonal** preserves the proportions of the objects on which it is executed. Depending on the shape of the frame and of the object, only the left and right edges will touch the frame, or only the top and bottom edges. This is the default command on the Size to Frame submenu.
- **Size to Frame All** does not preserve the proportions of the object. The points on the object that are left-most, right-most, top-most, and bottom-most will touch the edges of the frame.
- **Size to Frame Horizontal** does not preserve the proportions of the object. The left-most point on the object will touch the left edge of the frame, and the right-most point will touch the right edge.
- **Size to Frame Vertical** does not preserve the proportions of the object. The top-most point on the object will touch the top edge of the frame, and the bottom-most point will touch the bottom edge.

Figure 21-8 shows the differences among these commands.

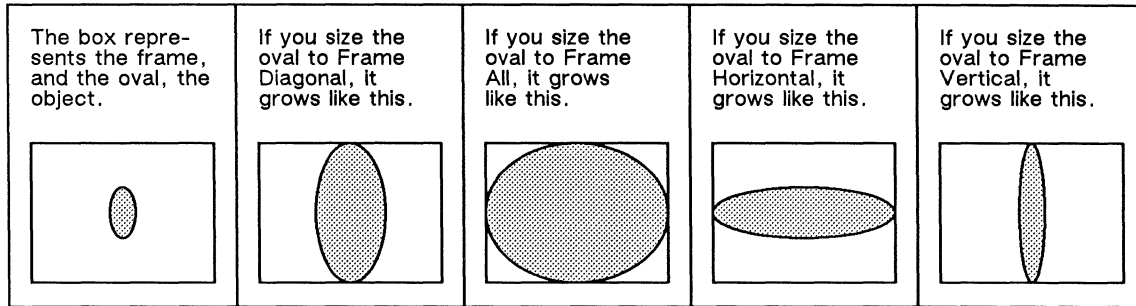

Figure 21-8. Sizing to Frame

### Size Reflect

**Size Reflect** flips the object around its center. The **Reflect** command flips selected object(s) around either the vertical, the horizontal, or the diagonal axis depending on which command you choose on the Reflect submenu (Figure 21-9).

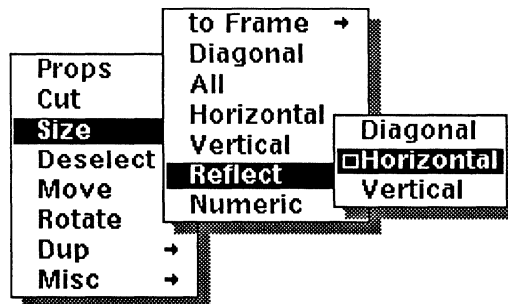

Figure 21-9. Reflect submenu

The default command on the Reflect submenu is **Horizontal**.

Figure 21-10 shows the horizontal, vertical, and diagonal axes through which a sample object would be reflected. When you reflect an object, its center does not move.

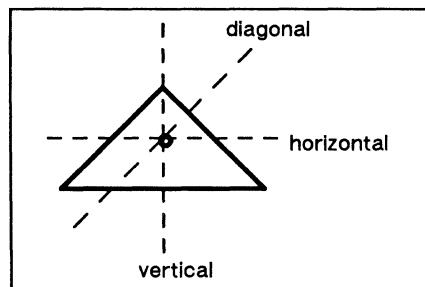

Figure 21-10. Axes around which an object can be reflected

Reflecting an object diagonally gives you the same results that reflecting an object *both horizontally and vertically* would give. Figure 21-11 shows the result of each reflection on a simple object.

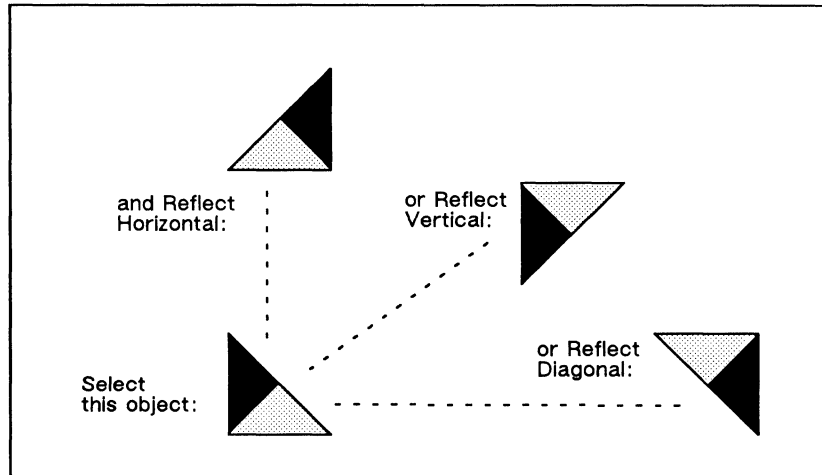

Figure 21-11. Effects of Reflect

## Size Numeric

**Size Numeric** allows you to change the size of an object by a multiple of its current size. For example, with **Size Numeric**, you can make an object exactly three times bigger than it originally was — or only half as big.

There are three choices on the **Size Numeric** submenu (Figure 21-12).

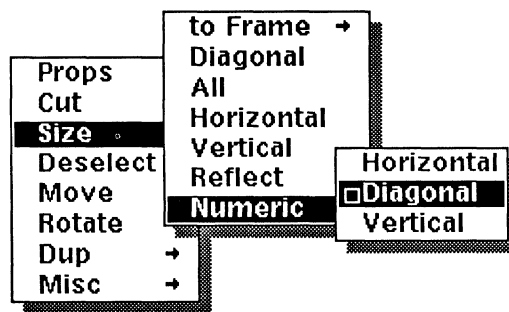

Figure 21-12. Size Numeric submenu

- **Size Numeric Horizontal** changes the width of an object, but not its height.
- **Size Numeric Diagonal** allows you to change the height and width of an object proportionally.
- **Size Numeric Vertical** changes the height of an object, but not its width.

Figure 21-13 shows the Size Numeric stickup. The initial default is 2, but it is dynamic and changes to the last number you enter. If you select **Enter** without typing any value, the selected objects will be changed by the default value.

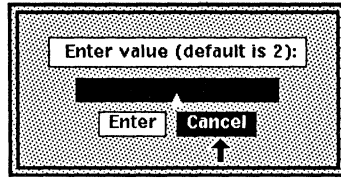

Figure 21-13. Size Numeric stickup

Figure 21-14 shows some of the changes you could produce in an object using Size Numeric.

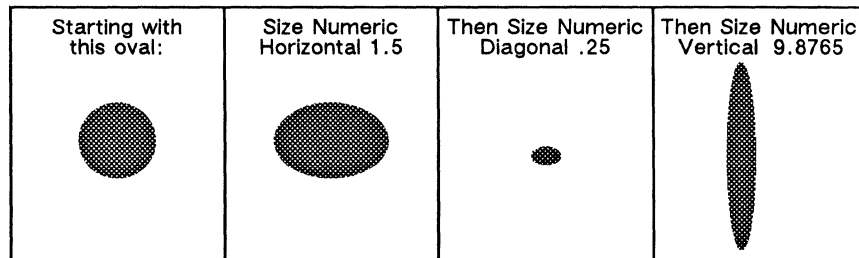

Figure 21-14. Using Size Numeric

## Control Points and the Size Command

When you size an object, a single point on it, the *active control point*, is attracted to gravity or grid points.

When you size more than one object at a time, the control points on the bounding box around the group — not necessarily the control points on the objects in the group — are attracted to the grid points. Therefore, control points on some objects that used to be on grid points can move away from them.

## Rotation

When you **rotate** an object, its center stays fixed, and the control point nearest the mouse cursor moves around the center in a circle. Figure 21-15 shows some examples of objects that were rotated 45 degrees, clockwise.

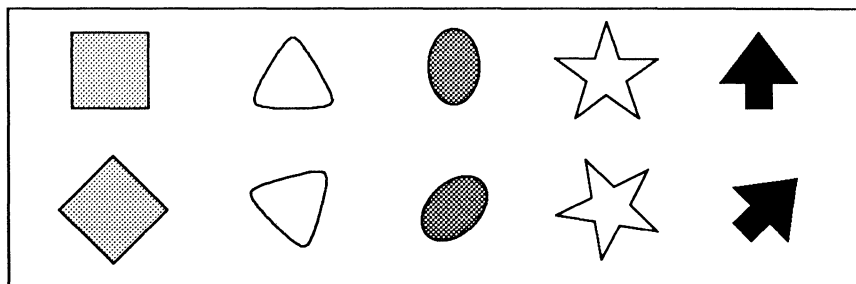

Figure 21-15. Rotating objects

### Detents

Most of the **Rotate** commands use detents. A **detent** is a constraint on the rotation of objects. In the diagramming system, a detent is one of the places to which you can turn an object. Detents are expressed in numbers of degrees. For example, if the detent is set to 45 degrees, then an object you are rotating will be attracted to every point at 45 degrees in a circle around the object (Figure 21-16).

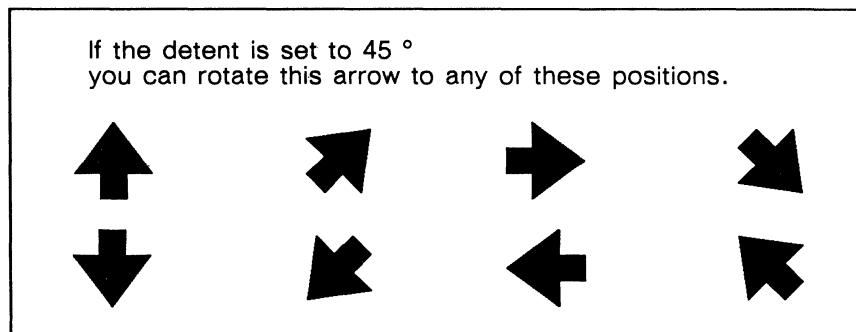

Figure 21-16. Rotating arrow with 45 degree detent

Detents are not set absolutely. Instead, they are measured from the current angle of the object (Figure 21-17).

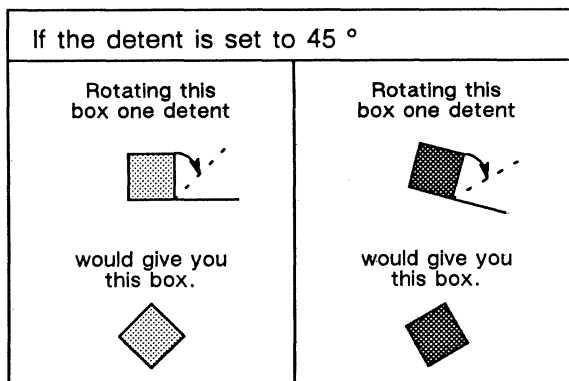

Figure 21-17. Detents are relative to the current angle

The default detent is 15 degrees. If you want another detent, you must set it using the Misc Detent submenu of the Nothing Selected popup menu (Figure 21-18).

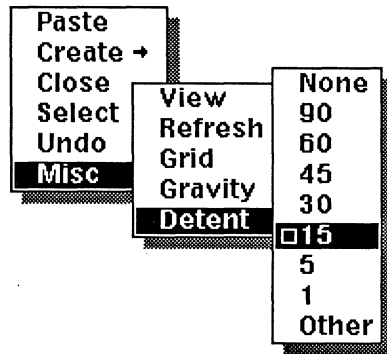

Figure 21-18. Detent submenu

If you choose **None**, you will be able to rotate the object freely to any angle.

If you want to set the detent at a specific number other than those on the submenu, choose **Other**. You will see the stickup in Figure 21-19.

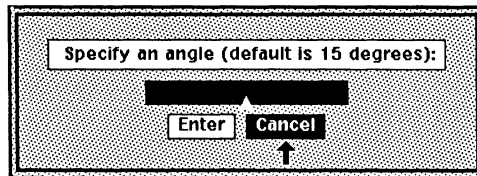

Figure 21-19. Detent Other stickup

You can specify an angle with as many as nineteen digits (including the decimal point).

## Rotation and the Weighted Center

The **Rotate** commands allow you to change the angle of an object and its position by turning it around a single point (the anchor point). The critical question is, where is this point?

All of the **Rotate** commands except **Rotate Magnified** use the same principle to determine the anchor point. It is chosen by weighing the distribution of control points in the object and then finding the point that is closest to the most control points. This point is called the **weighted center**.

If you have a poly, for example, that has one control point on the left side and nine on the right, the weighted center will be much closer to the right than the left (Figure 21-20).



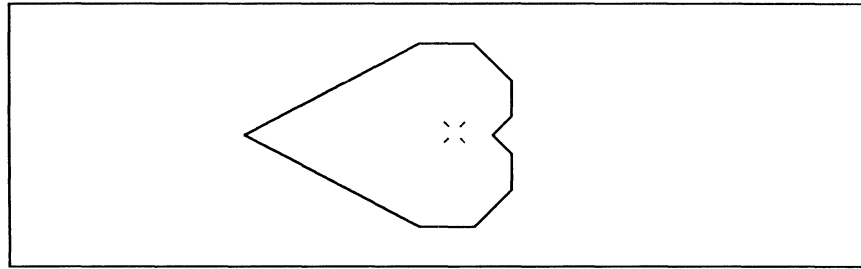

Figure 21-20. Anchor point at weighted center of a poly

### Objects that do not Rotate

Charts, text strings, and microdocuments cannot be rotated. Groups that contain charts, microdocuments or text strings can be rotated. The non-rotating object in a group will keep its angle, but change its position (Figure 21-21).

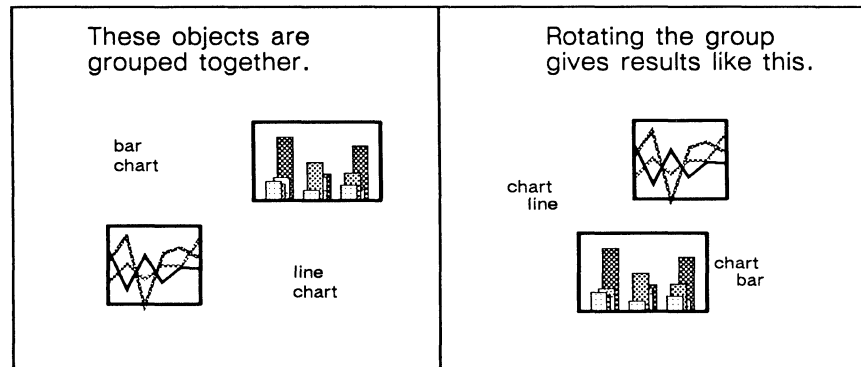

Figure 21-21. Rotating groups of text strings and charts

### The Rotate Submenu

Figure 21-22 shows the Rotate submenu.

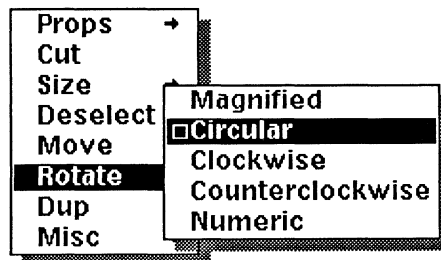

Figure 21-22. Rotate submenu

There are two animation commands on the Rotate submenu: **Circular** and **Magnified**. The animation commands allow you to rotate the object any number of detents and to move both clockwise and counterclockwise until you have the angle you want.

There are three deselection commands on the Rotate submenu: **Clockwise**, **Counterclockwise**, and **Numeric**. The deselection commands rotate the object a specific amount in a specific direction and then deselect it. All three are variations on **Rotate Circular**

### *Rotate Circular*

**Rotate Circular** allows you to rotate an object in either direction using the mouse, in detent-sized steps around the object's weighted center. **Circular** is the default command on the Rotate submenu.

### *Rotate Clockwise and Counterclockwise*

**Rotate Clockwise** rotates the object one detent setting clockwise. **Rotate Counterclockwise** rotates the object one detent setting counterclockwise.

### *Rotate Numeric*

**Rotate Numeric** allows you to specify a rotation numerically. When you use the **Rotate Numeric** command, you will see a stickup. Enter the number of degrees you want to rotate the selected object (Figure 21-23). The default is 90 degrees.

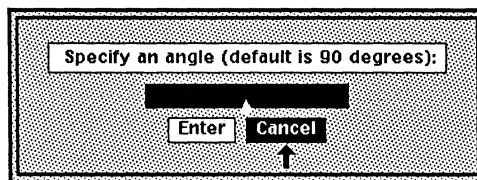

Figure 21-23. Rotate Numeric stickup menu

You can type any angle, using up to nineteen digits. Positive numbers rotate the selected object clockwise; negative numbers rotate it counterclockwise.

### *Rotate Magnified*

**Rotate Magnified** allows you to change the angle and the size of the object at the same time. When you select the **Rotate Magnified** command, the diagramming system chooses as the active control point the control point closest to the mouse cursor *when you execute the command*, and chooses as the anchor point the control point farthest from the active control point. Figure 21-24 shows two objects and how choosing different anchor points affects rotation.

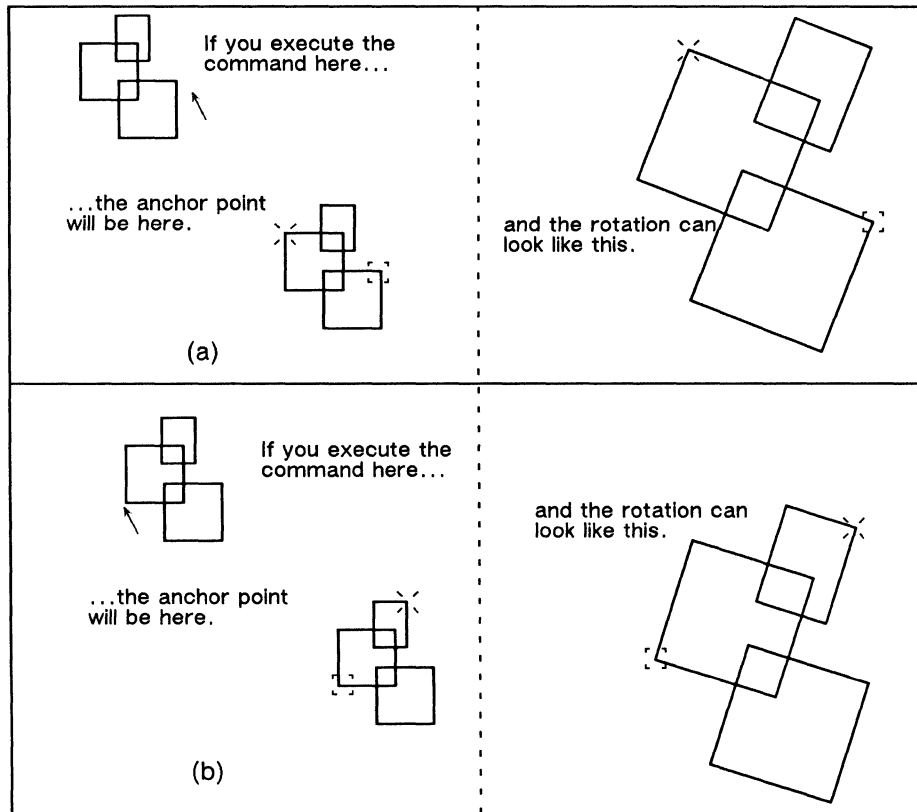

Figure 21-24. Anchor points and Rotate Magnified

Depending on where the mouse cursor is when you execute it, the **Rotate Magnified** command can have widely differing effects. Figure 21-25 shows two objects you can create from one basic shape, using **Rotate Magnified** and **Duplicate**.

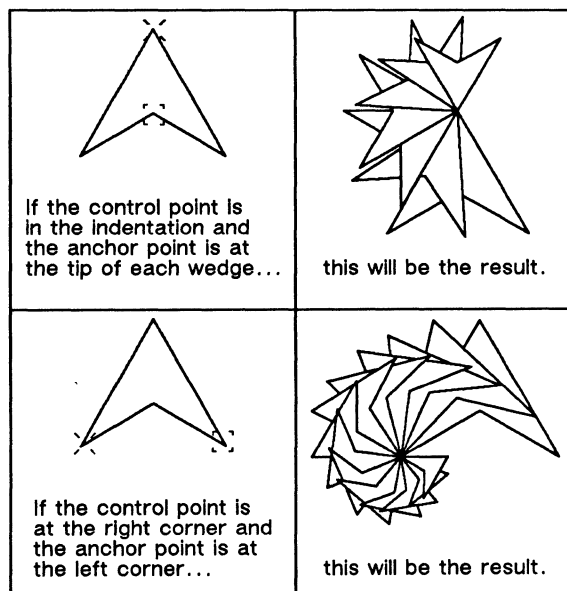

Figure 21-25. Two possibilities using Dup and Rotate Magnified

Figure 21-26 shows the differences between **Rotate Magnified** and the other **Rotate** commands when they are used with **Dup(licate)**.

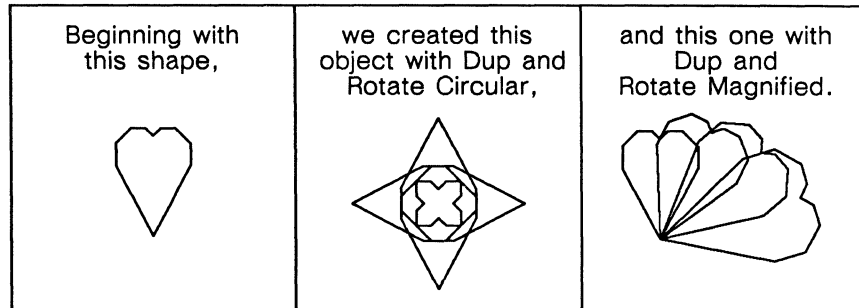

Figure 21-26. Rotate Circular and Rotate Magnified

## Duplicating Objects

The **Dup(licate)** command makes a duplicate of the selected object. Figure 21-27 shows the **Dup** submenu.

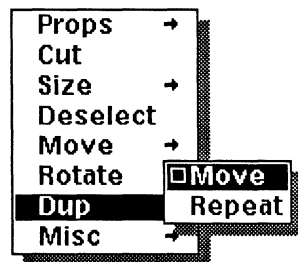

Figure 21-27. Dup submenu on the Object Selected menu

### Dup Move

When you execute the command, the duplicate will be exactly overlaid on the original, but it will be in animation state, and by moving the mouse, you will be able to move the duplicate in any direction. **Move** is the default command on the **Dup** submenu.

### Dup Repeat

**Dup Repeat** is useful whenever you want to make the same change to a series of objects.

When you use **Dup Repeat** you are using a combination of **Dup** and a **Move**, **Size**, or **Rotate** command. In essence, you are making a duplicate and then repeating a previously executed command. If you have not previously executed a **Move**, **Size**, or **Rotate** command, the **Move All** command will be invoked by default. You can use a combination of **Move Numeric Horizontal** and **Dup Repeat** to create a series of evenly spaced objects.

To create a series of evenly spaced objects:

- ✓ Create a **Box**.
- ✓ Without deselecting it, execute the **Dup** command.
- ✓ Execute the **Move Numeric Horizontal** command.
- ☐ Type **8** in the stickup.
- ✓ Select the duplicate, then **Dup Repeat**.
- ✓ Use **Select Again** to select the latest duplicate, and use **Dup Repeat** until you have as many boxes as you want.

## Cutting and Pasting Diagramming Objects

With the **Cut**, **Copy**, and **Paste** commands, you can:

- delete objects you do not want any more
- transfer objects between diagrams and between documents

### Diagram Icons

When you cut or copy an object in a diagram, it is placed in a diagram icon on the clipboard. When you execute the **Paste** command in a diagram, the contents of a diagram icon (assuming it is the selected object on the clipboard) are moved from the clipboard into the open frame.

The name of the diagram icon consists of the word *from* and, in quotation marks, the name of the document the objects came from (Figure 21-28).



Figure 21-28. Diagram icon containing objects from a document called pingo

The diagram icon cannot be opened or printed. To look at or print its contents, you must paste it into a document.

### Cutting and Copying

When you cut or copy an object, the diagramming system checks the clipboard to see if it contains a diagram icon whose name begins with "from". If there is no icon, one is created, and the cut or copied object is placed in it. The "from" icon is selected, and any previously selected icons on the clipboard are deselected.

If there is already a “from” icon on the clipboard, its old contents are erased, and the newly cut or copied object is placed in it. *There is no way to retrieve the old contents.*

If you want to preserve an object in a diagram icon so that it is not overwritten the next time you cut or copy from a diagram, paste it into a folder or drawer or onto your desktop before cutting or copying another object.

### The Cut Command

The **Cut** command is on the Object Selected popup menu (Figure 21-29).

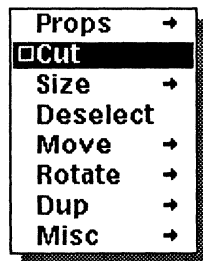

Figure 21-29. Cut command

When you use the **Cut** command, the object is removed from the diagram and becomes the current contents of the diagram icon on the clipboard.

### The Copy Command

The **Copy** command, on the Misc submenu of the Object Selected menu (Figure 21-30), makes a copy of whatever objects you have selected and puts it in a diagram icon on the clipboard.

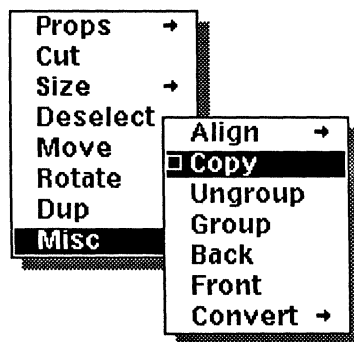

Figure 21-30. Copy command

The **Copy** command works like the **Cut** command, except that it makes a copy of the object and moves the copy to the clipboard instead of moving the object itself to the clipboard. The previous contents of the diagram icon on the clipboard are erased, just as they are when you cut an object.

## The Paste Command

The **Paste** command moves the objects in the selected graphic icon on the clipboard into the diagram and deletes the icon. The **Paste** command is on the Nothing Selected popup menu (Figure 21-31).



Figure 21-31. Paste command

The diagramming **Paste** command is linked to the **Move All** command.

When you paste an object in a diagram, it is in animation state so that you can move it. The diagramming system draws an imaginary box around the object. The upper left corner of this box is placed where the mouse cursor was pointing when you pasted. The active control point is the control point on the object that is nearest to the upper left corner of the imaginary box (Figure 21-32).

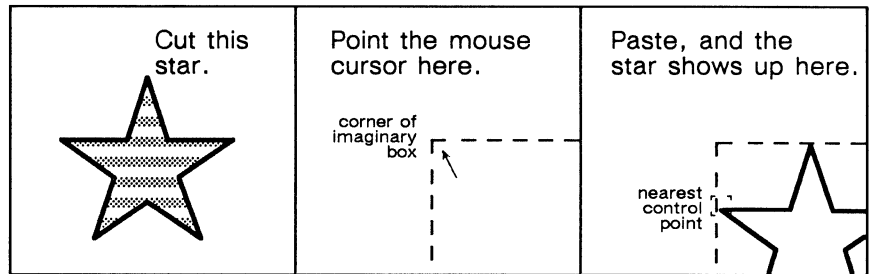

Figure 21-32. Showing how paste works with a star

If the mouse cursor is too close to the lower right corner of the diagram, you may not see the pasted object at all until you move the mouse up and to the left.

Only graphic objects or text can be pasted in a diagram. If you execute the **Paste** command when an icon representing another kind of object is selected on the clipboard, neither the diagram nor the clipboard will be changed.

You can also paste a diagram icon in text, and a frame will be created for it automatically. The position and type of the new frame are determined by the position of the mouse cursor when you execute the **Paste** command. For example, if you are pointing at the component bar, an empty component will be created at the location of the component caret, and the diagram icon will be pasted in it in an **At Anchor** frame. The size of the frame is determined by the size of the object in the diagram icon. For more information about frames, see the chapter, *Text-Anchored Frames*, in the *Reference Manual*, Volume 1.

## Aligning Objects

The **Align** commands arrange selected objects along the axis you choose. Figure 21-33 shows three objects and the positions they have after three of the **Align** commands have been executed on them.

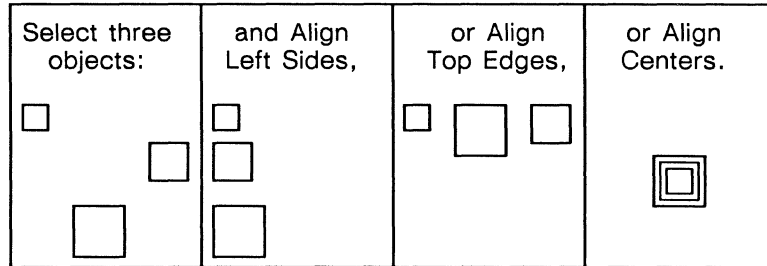

Figure 21-33. Effects of Align commands

With the **Align** commands you can line up objects along any of six axes, or at their centers. Figure 21-34 shows the possible axes on a rectangle along which other objects could be aligned.

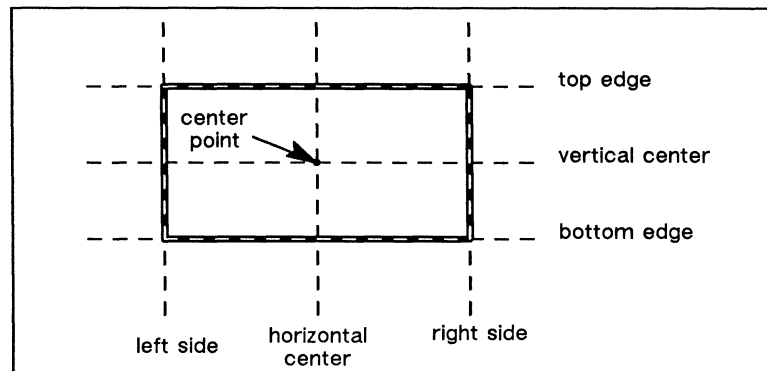

Figure 21-34. Possible alignment axes

To use the **Align** commands, select the objects you want and choose the appropriate command from the **Align** submenu (Figure 21-35).

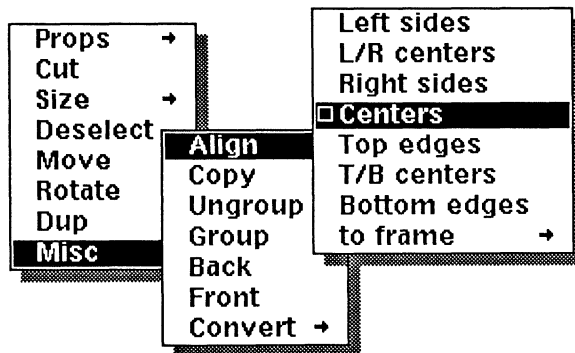

Figure 21-35. Align submenu



## How Align Works

The diagramming system uses an imaginary bounding box around the objects you select in order to determine the position of the objects after the **Align** command is executed.

For example, if you align the top edges of a set of objects, the diagramming system finds the object that is furthest up. That object does not move; the other objects move up until their top edges are lined up with it.

If you choose to align the centers of some objects, the diagramming system finds the center of the bounding box and moves the centers of the objects onto the center of the bounding box.

Figure 21-36 shows this bounding box, and its effect on the position of some objects.

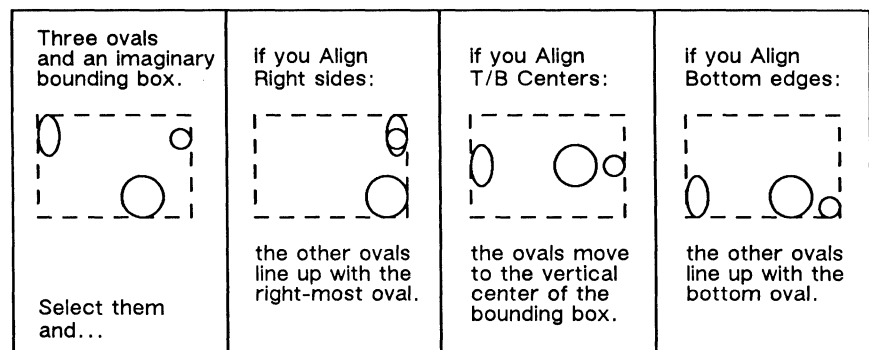

Figure 21-36. How the bounding box works with align

Here is the effect on position that each of the **Align** commands, except the commands on the to Frame submenu, can be expected to have:

- Left sides** The other objects line up with the left side of the left-most object.
- L/R centers** All of the objects line up along a vertical line that is half way between the left-most and the right-most objects.
- Right sides** The other objects line up with the right side of the right-most object.
- Centers** All the objects are centered around a point that is the center of an imaginary bounding box drawn around all the objects.
- Top edges** The other objects line up with the top edge of the upper-most object.
- T/B centers** All of the objects line up along a horizontal line that is half-way between the top-most and bottom-most objects.
- Bottom edges** The other objects line up with the bottom edge of the lower-most object.

### Align to Frame Submenu

The commands on the Align to frame submenu (Figure 21-37) work in essentially the same way as the other **Align** commands except that they treat the frame as a stationary box and align objects to it rather than to each other.

These commands are useful when **GridAlign** is *on*, and you want to ensure that objects are in a specific place in relation to the frame. For example, when you want the text in a header or footer frame exactly at the right-hand margin and centered between the top and bottom of the frame, you can enter the text and then use the **Align to frame Right** and **Align to frame T/B center** to put the text in the right place. You do not even need to enter the text **flush right** since the **Align to frame Right** command will convert it to flush right text if necessary.

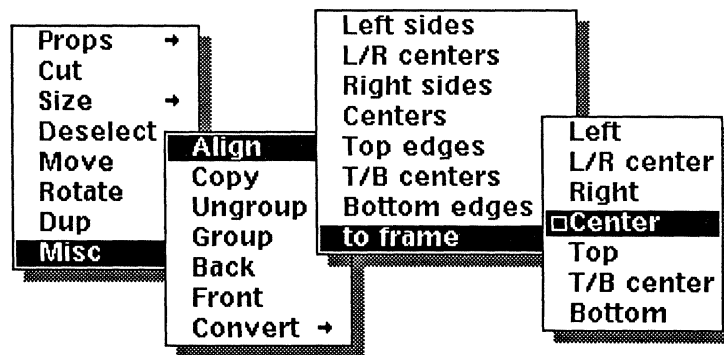

Figure 21-37. Align to frame submenu

### Alignment Aids

You can use the information in the previous section about positioning to build alignment aids that force objects to line up, not only along a specific axis, but at a specific point.

There are four kinds of alignment aids.

- You can choose the most appropriate command from the Align submenu.
- You can move some of the objects you want to align before you align them.
- You can create new objects whose only purpose is to change the size of the bounding box around the objects you want to align.
- You can use **Control** and **Position Locks**. This approach is explained under *Locks* in the chapter, *Advanced Diagramming Concepts*.

## Moving Objects Selectively

Suppose you have a text string that you want to center in a box, but you do not want the box to move. The way to get this result is to move the text string so that it is completely contained in the box. Then, when you execute the **Align Centers** command, the bounding box will be the size of the box, and therefore the center of the bounding box will be the center of the box (Figure 21-38).

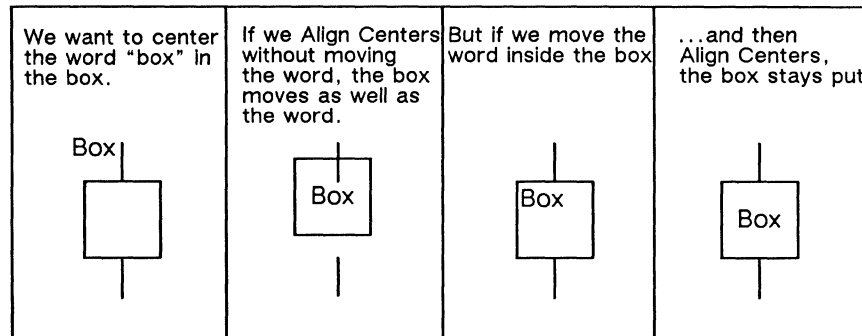

Figure 21-38. Moving some objects before aligning

## Alignment of Groups

Although commands executed on a group affect all the objects in it, no command affects the relative spatial relationships of the objects in the group.

This is one of the real advantages of groups. You can set up a fancy alignment and be sure that it will not be destroyed later. Figure 21-39 shows one example.

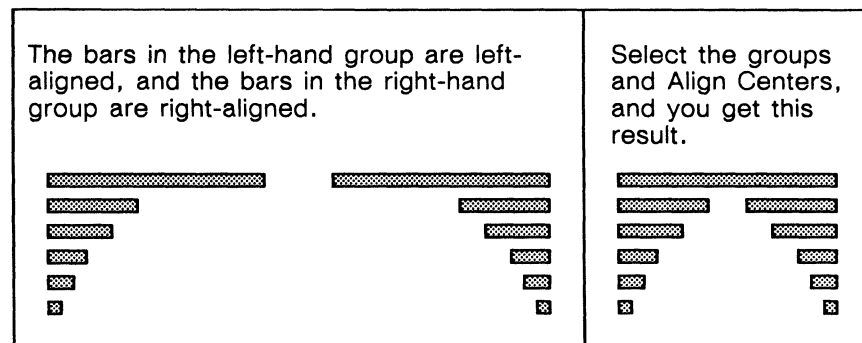

Figure 21-39. The groups are aligned, not the objects in them.

Figure 21-40 shows the diagram you would get if the bars in NO TAG were not grouped when you aligned centers.

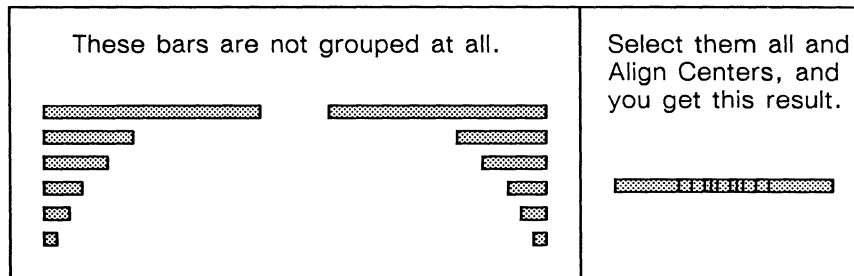

Figure 21-40. Objects are centered because they are not grouped.

One of the effects of this preservation of alignment is that it is impossible to destroy a poly by changing its size, angle, or position.

### Creating Alignment Objects

You can create objects to use as tools for controlling the positions of other objects. This is particularly useful for centering columns of objects, such as those in Figure 21-41. Many figures in this manual are divided into panels, each of which shows one aspect of a problem or a step in a solution. To center the information in each panel, we used a pair of lines as described in the following procedure. (You may also want to refer to the technique, *Dividing a Box into Equal Parts*, Appendix C, if you need to know how to create panels of equal size.)

#### To center objects between grouped lines:

- ✓ Duplicate the line that is dividing the box into two panels, and immediately execute the **Dup** command again.
- ✓ Move the new duplicate so that it exactly overlaps the side of the box.
- ✓ Select the two duplicates and **Group** them.
- ✓ Select the group and the objects you want to center.
- ✓ Execute the **Align L/R centers** command.

*If you have more than one column and the columns are all the same size, you can then select the grouped lines again, move them to the next column, and align again. When you finish, cut the new group of lines.*

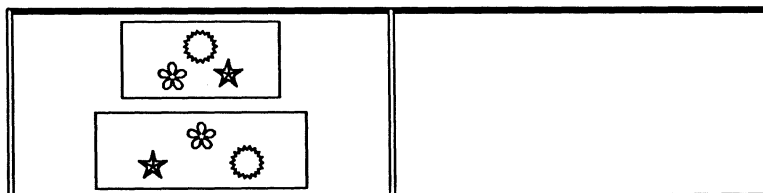

Figure 21-41. Box divided into two panels with two objects aligned left/right in a panel

## The Undo Command

The **Undo** command reverses all changes you have made to the last set of objects that you changed. **Undo** is on the Nothing Selected popup menu (Figure 21-42).

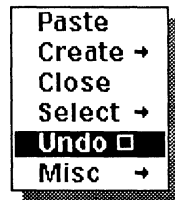

Figure 21-42. Undo command on the Nothing Selected menu

### How Undo Works

At all times, the diagramming system has a record of what would be undone if you executed the **Undo** command. There are two refinements to the **Undo** command.

- If you execute more than one command on a set of objects without deselecting them, those commands are *added* to the system's record of what to undo. If you execute **Undo**, the system will undo all of the commands.
- **Undo** works only on changes made to objects. If you execute a command that does not change an object (if you change the default pattern fill or make the grid visible, for example), you do not affect the system's record of what to undo. If you select an object, size it, move it, and duplicate it before you deselect it, when you undo, the object will be resized to its original size and moved back to its original position, and the duplicate will be removed.

The commands that do not change an object — and, therefore, do not change the record of what to undo — are **Deselect** on the Object Selected menu and the commands on the Misc and Defaults submenus of the Nothing Selected popup menu.

Here is an example. If you **Size** a box, then turn **GridAlign off**, then **Undo**, you will return the box to its original size. **GridAlign** will not be turned *on* again because **GridAlign on/off** does not change an object and, therefore, does not affect the record of what to undo.

The record of what to undo is kept until you close the document that contains the diagram. You can even close the diagram, open another, and work in it, and when you go back to the first, you can still undo the last set of changes.

Because **Undo** reverses the *last* changes you made, executing the **Undo** command twice in a row leaves the diagram as it was before you executed **Undo** for the first time. The effects of the first **Undo** are undone (Figure 21-43).

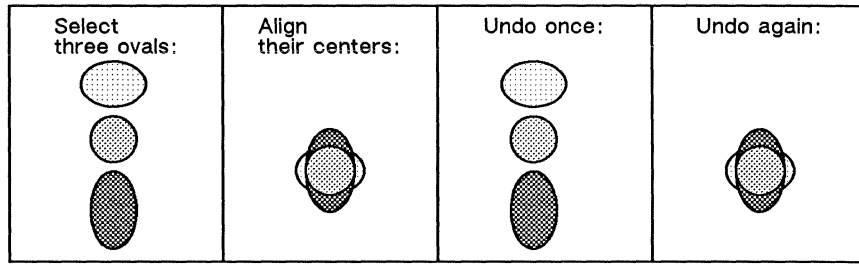

Figure 21-43. Using Undo twice in a row

## Undo and Cutting and Pasting

When you cut an object from a diagram, it is moved onto the desktop clipboard. If you then execute the **Undo** command, the object you cut will be redisplayed, but a copy of the object remains on the clipboard. If you then execute the **Paste** command, the copy of the object will appear in the diagram (Figure 21-44).

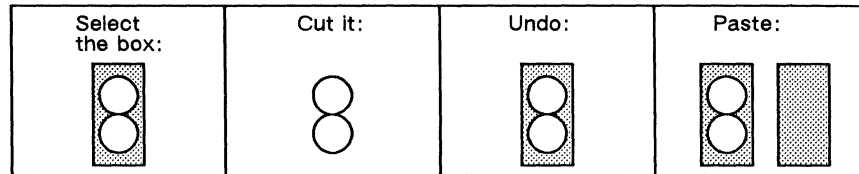

Figure 21-44. Using Cut and Undo in a diagram

Because the **Copy** command causes no changes to the diagram you are working in, if you execute **Undo** after you have copied something, the command that you executed in the diagram just prior to using the **Copy** command is the one that will be undone. If, for example, you change the fill in one of the circles in Figure 21-44 to black and then **Copy** the box in back of the circles, when you execute **Undo**, the circle will become white again. If you then **Paste**, you will be pasting the copy you made of the box (Figure 21-45).

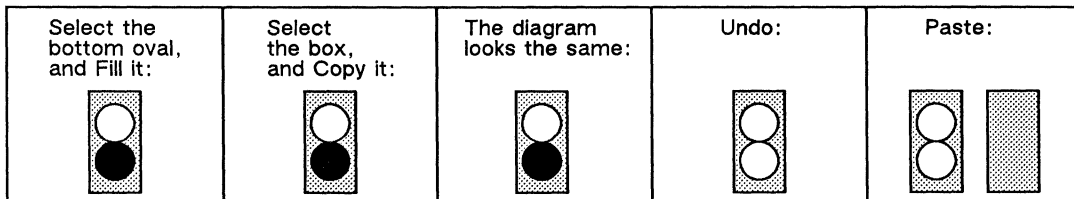

Figure 21-45. Using Copy and Undo in a diagram

---

## Chapter 22

# Creating and Modifying Arcs

An arc is part of a *conic section*. A conic section is the intersection of a plane and a cone (Figure 22-1).

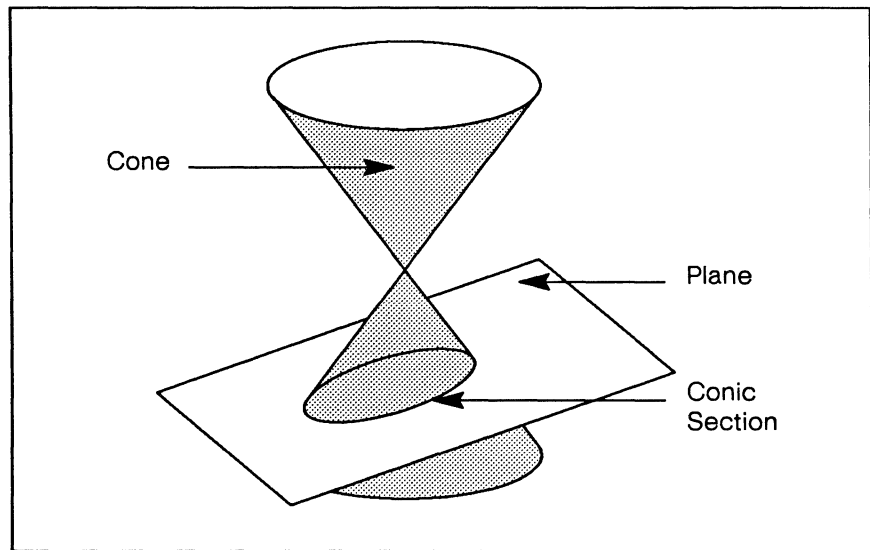

Figure 22-1. One example of a conic section

The **endpoints** of an arc define the portion of the conic section which is included in the arc. The **midpoint** is the point on the arc centered between the endpoints (Figure 22-2).

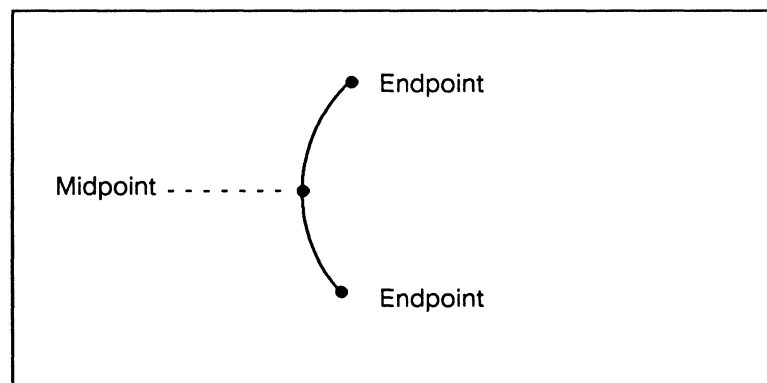

Figure 22-2. Endpoints and midpoint

The center of the underlying conic section is called the arc's **conic center**. The **weighted center** of the arc is a point that is determined to be central to the two endpoints and the midpoint (Figure 22-3).

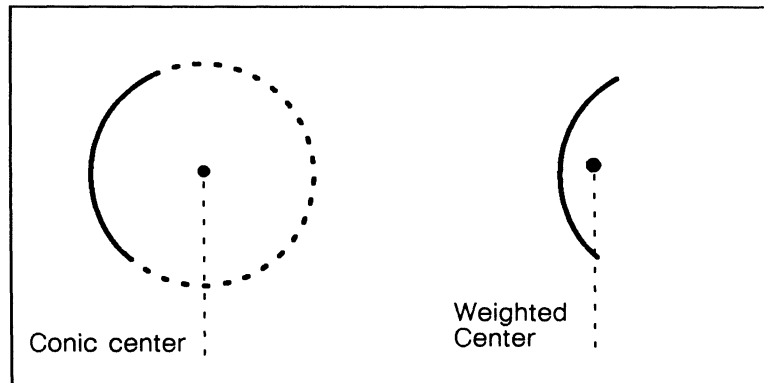

Figure 22-3. Conic and weighted centers

For every point on an arc, you can draw a tangent line that has the same slope as the arc at that point. To let you modify the slope at the endpoint of the arc, the software maintains control points on the lines which are tangent to the arc at the endpoints. When you select an arc, you will see the endpoint tangent lines as shown in Figure 22-4.

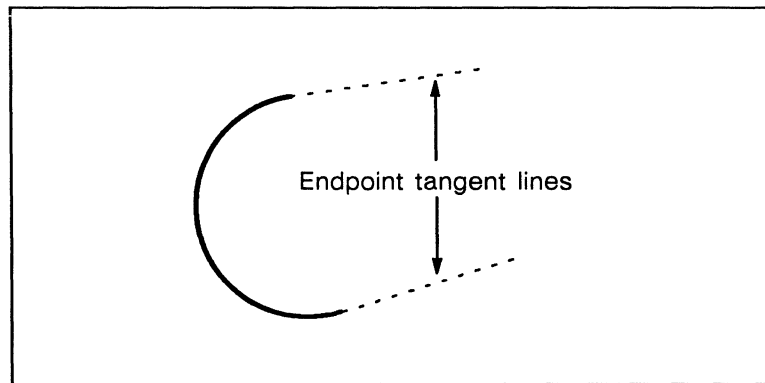

Figure 22-4. Tangent points on selected arc

Like other diagramming objects, an arc has an invisible **bounding box** that the software uses to position the arc when you perform alignment operations. The points at which the box and the arc itself touch depend on the shape of the arc. Figure 22-5 shows some arcs and their bounding boxes.



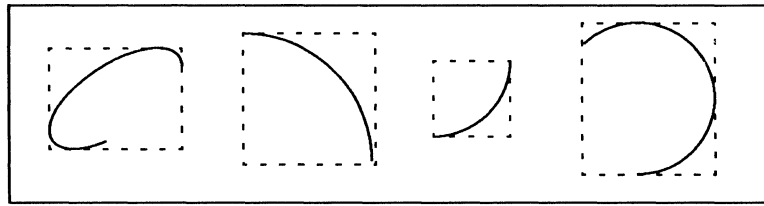

Figure 22-5. Some arcs and their bounding boxes

## Creating Arcs

You can create an arc in one of two positions: clockwise or counterclockwise (Figure 22-6).

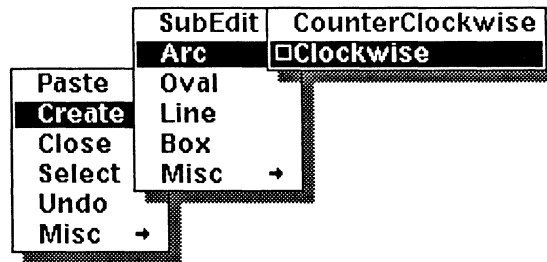

Figure 22-6. Create Arc submenu

A newly created arc is circular; that is, the underlying ellipse of a new arc is a perfect circle. The distance between endpoints of the default arc is the same as the distance between opposite corners of a default grid square.

The anchor point of a newly created arc appears at the cursor location. Figure 22-7 shows where the control point will appear on a clockwise arc and a counterclockwise arc.

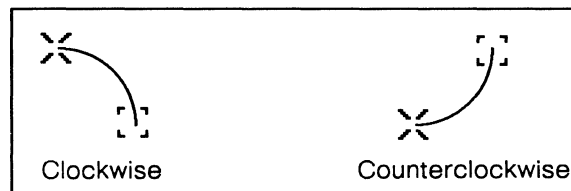

Figure 22-7. Default arcs

When you create an arc, **Rotate Magnified** is executed so that you can change the position and size of the arc without changing its shape.

## Modifying Arcs

There are two basic types of modifications you can perform on arcs. The first type includes the standard diagramming commands: **Size**, **Rotate**, **Move**, **Width**, **Fill**, and **Dashes**.

The second type involves using the **Props Edit** command to manipulate certain control points.

### Using Standard Commands on Arcs

For moving, sizing, and rotating operations, the active control point on an arc can be at one of the following locations:

- the endpoints
- the midpoint
- the corners of the bounding box
- the *weighted center* of the arc

Not all of these control points are eligible to be active for all operations. The active control point used is the eligible control point closest to the cursor when the command is executed.

For many applications, you may not care which control point is made active. But if you are having trouble precisely aligning an arc to another object, or if you want a thorough understanding of arcs, you should read the following sections.

### Moving Arcs

When you move an arc, one of the following control points will be used as the active control point: either endpoint, the midpoint, or the conic center (Figure 22-8).

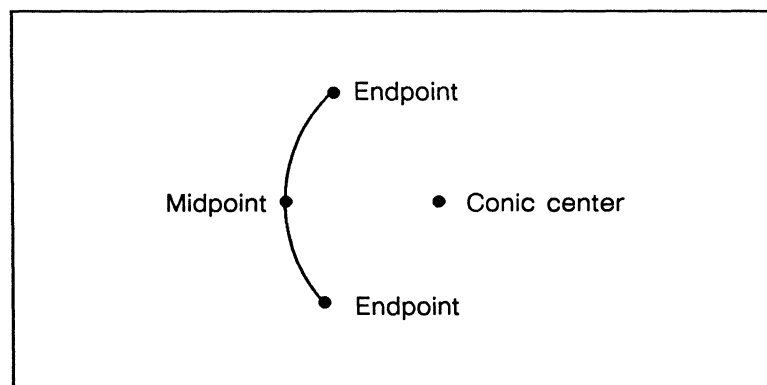

Figure 22-8. Control points for moving arcs

## Sizing Arcs

The corners of the arc's bounding box are the possible active control points for sizing operations. The active control point is the corner closest to the cursor when the command is executed, and the anchor point is the opposite corner (Figure 22-9).

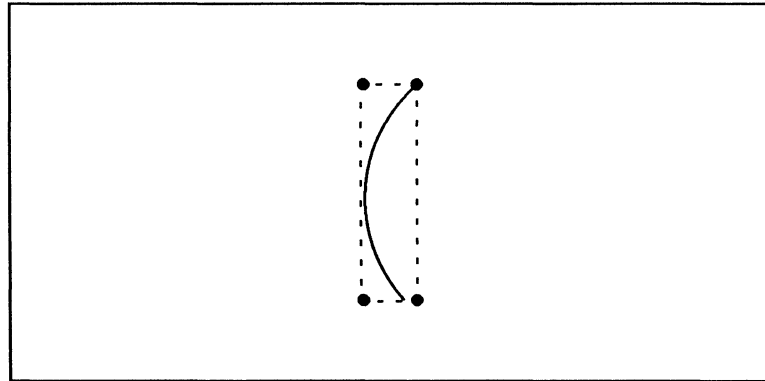

Figure 22-9. Control and anchor points for sizing arcs

## Rotating Arcs

If you use **Rotate Magnified**, the control point is chosen from among the endpoints, the midpoint, and the conic center. The anchor point is the point opposite the active control point: if the active control point is the midpoint, the anchor is the conic center and vice-versa; if the active control point is an endpoint, the anchor is the opposite endpoint (Figure 22-10).

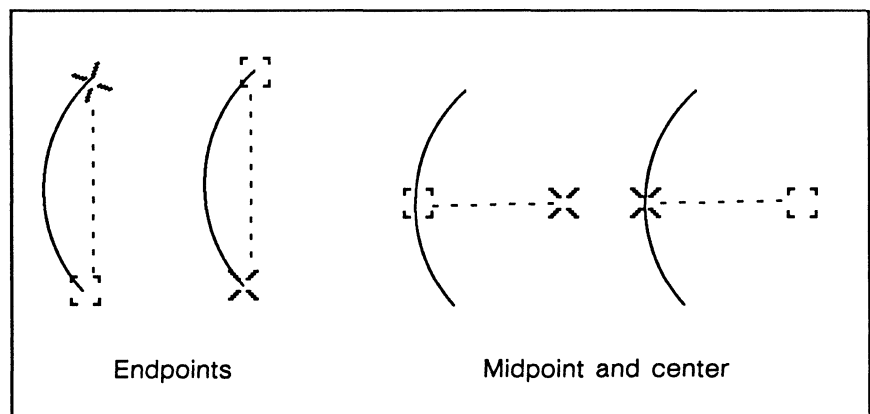

Figure 22-10. Control and anchor points for magnified rotation of arcs

If you use any other **Rotate** command, the active control point is chosen from the endpoints and the midpoint, and the anchor is always the weighted center (Figure 22-11). If the arc is small, the software will choose a point beyond the endpoint as the active control point, to allow a smooth rotation.

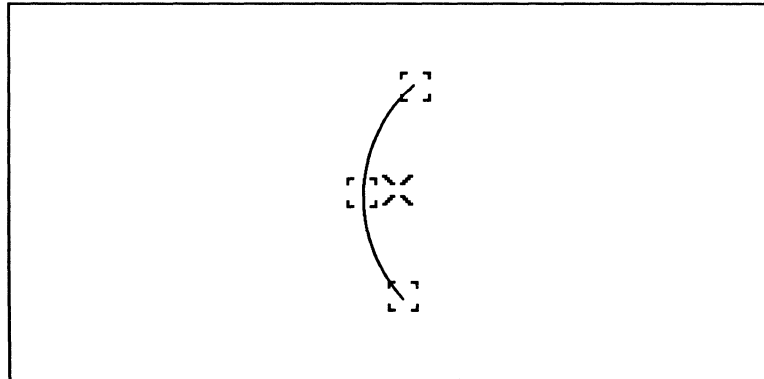

Figure 22-11. Control points and anchor point for rotations of arcs other than magnified rotation

## Using Props Edit to Modify Arcs

You can use the **Props Edit** command to further control the arc's **eccentricity** (shape) and **extent**. The extent of an arc is the amount of the underlying conic section which is included in it.

The **Props Edit** command lets you move any of five control points (Figure 22-12). Three of these — the two endpoints and the midpoint — are also in the set of control points used for move, size, and rotate operations. The other two, the arc's **tangent points**, are used only with the **Props Edit** command.

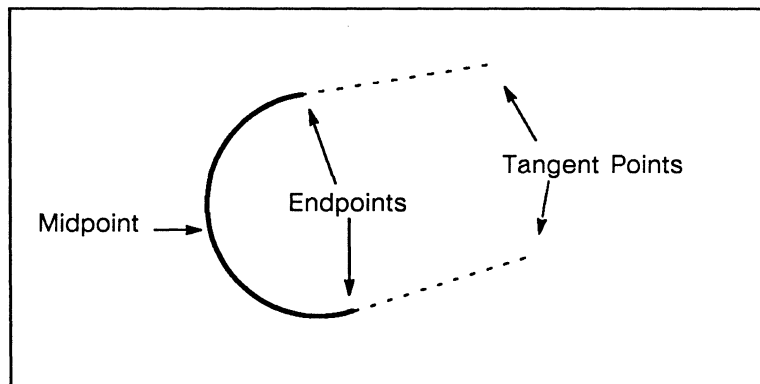

Figure 22-12. Props Edit arc control points

### To edit an arc control point:

- ✓ Select the arc.
- ✓ Position the cursor near or on the point which you wish to edit.

If you position the cursor within a few pixels of the arc before executing the **Props Edit** command, the closest editing control point on the arc will be chosen. Otherwise, the closest tangent control point will be chosen.

- ✓ Execute the **Props Edit** command.
- ✓ Move the mouse until the control point is where you want it and click the **middle** button.

The arc will be deselected. Notice that it is not necessary to take special steps to close the editing operation.

### Editing the Extent and Eccentricity of an Arc

Figure 22-13 shows how editing the endpoint of an arc changes the arc's extent.

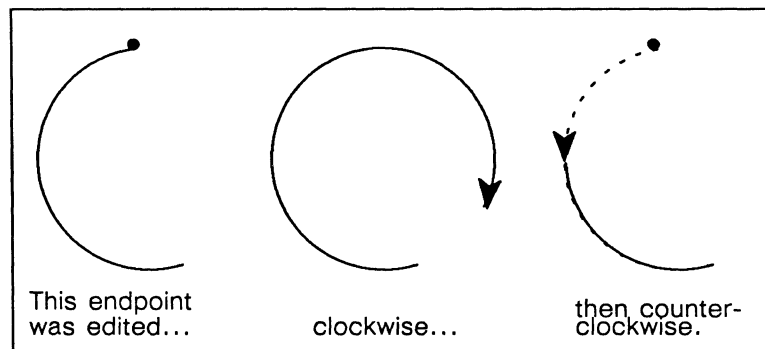

Figure 22-13. Editing the extent of an arc

You can use **Detent** to edit the extent of the arc in exact degree increments. For instance, if **Detent** is on and set to **45** degrees, the endpoint will move only in increments of 45 degrees.

Figure 22-14 shows that editing an arc's midpoint changes its eccentricity.

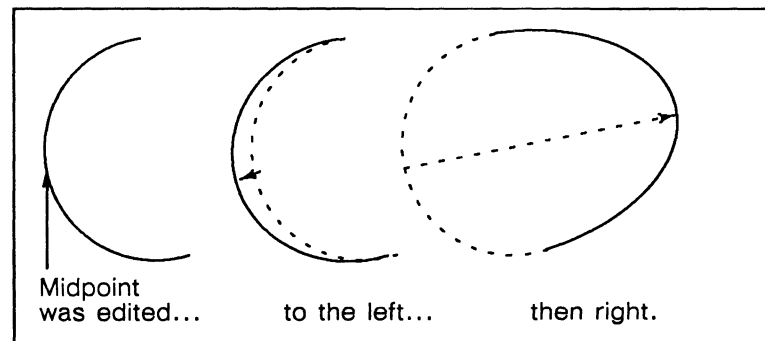

Figure 22-14. Results of editing the midpoint

You can also control eccentricity by editing the tangent points (Figure 22-15).

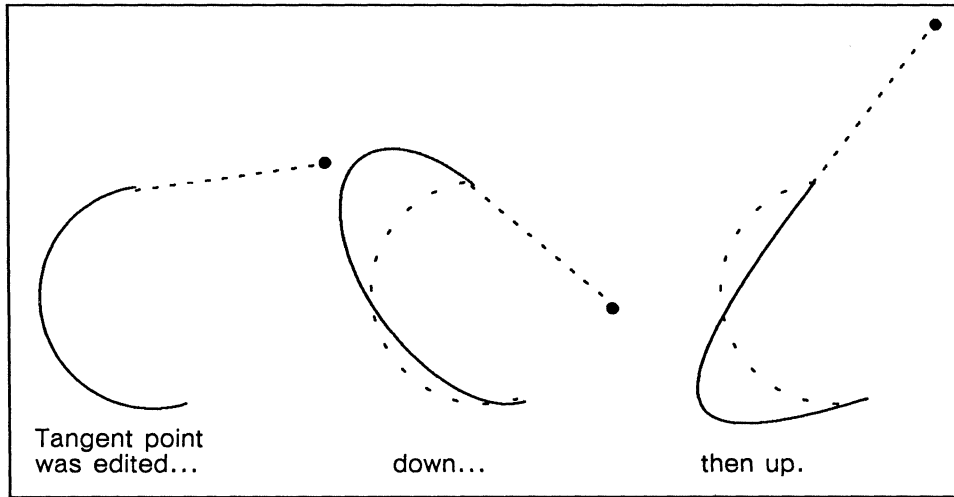

Figure 22-15. Results of editing tangent points

---

## Chapter 23

# Text as a Diagramming Object

There are three kinds of text that can be used in a diagram:

- microdocuments,
- text strings, and
- graphic text

The three types are fundamentally different from other diagramming objects and from each other. Text strings and microdocuments have their own sections in this chapter. The discussion of microdocuments in this chapter focuses on what can be done with them as diagramming objects; for information on editing *within* microdocuments see the chapter *Text in Frames*.

Graphic text, which consists of letters created from diagramming lines and polys, is discussed in the chapter *The Graphics Cabinet*.

## Microdocuments

A microdocument is a complete document within a frame. When you are editing one, you have all of the text processing capabilities available in the publishing software. When you are not editing a microdocument, the diagramming system views it as an object on which you can perform most diagramming operations, including **Size**, **Dup**, and **Move**. Each microdocument is enclosed in a bounding box. You can change the **Width**, **Fill** and **Dashes** pattern of this box (Figure 23-1).

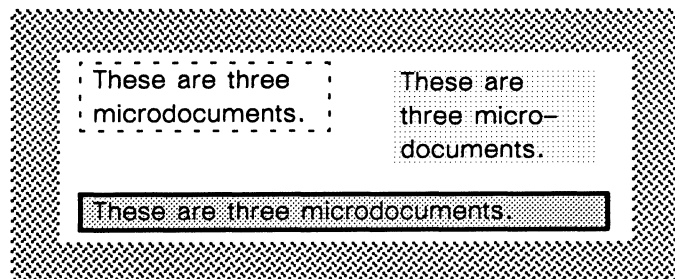

Figure 23-1. Microdocuments

Microdocuments exist in one of two states: variable-width and fixed-width. A variable-width microdocument is a single-line document which expands and contracts automatically as you add and delete text. A fixed-width document may contain multiple lines; its width remains the same even when you add or delete text.

## How to Identify a Microdocument

An unselected microdocument with no fill or border width looks the same as a text string or column of text strings. When you select a text string, the text blinks on and off. When you select a microdocument, its bounding box and the text within are displayed in alternate blinks.

The bounding box of an empty microdocument is always displayed in an open frame. Display of the bounding box when the frame containing it is closed can be switched on and off using the Text Location, Misc Show Text Anchors menu.

## Variable-Width Microdocuments

A variable-width microdocument is always a one-line microdocument. Its width adjusts as you add or delete text. Figure 23-2 shows six filled microdocuments. The first three are variable-width; notice that the bounding boxes of these three microdocuments are the same width as the text within. The next three are examples of fixed-width microdocuments; the widths of their bounding boxes are not necessarily related to the amount of text within.

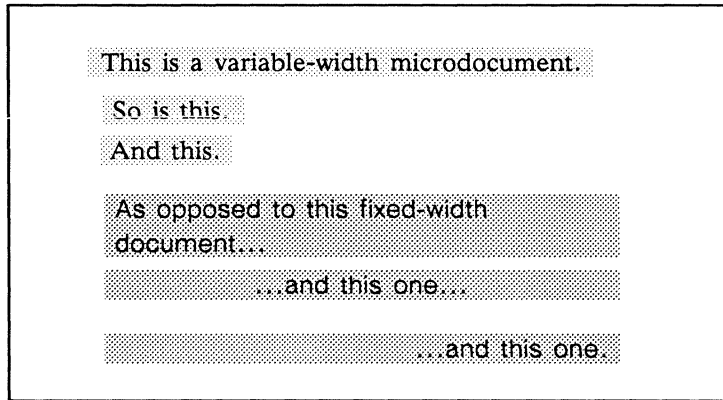

Figure 23-2. Variable-width microdocuments

### To create a variable-width microdocument:

- ✓ Position the cursor where you want the baseline of the text to appear, and begin typing.

*The font of the text will be the font specified in the document header Font box.*

## Alignment of Variable-Width Microdocuments

The initial default alignment for new variable-width microdocuments is left-justified. Microdocuments can also be centered or right-justified (Figure 23-3).



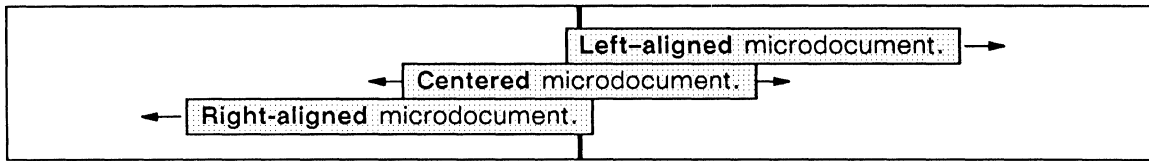

Figure 23-3. Microdocument alignment

## Control Points on Variable-Width Microdocuments

When you move a variable-width microdocument, its control point is at the baseline of the text. Its horizontal position depends on the object's alignment: left-aligned, centered, or right-aligned. Figure 23-4 shows the control point on each kind of text.



Figure 23-4. Variable-width microdocument control points

If **GridAlign** is *on*, the control point is attracted to grid points. If **Gravity** is *on*, the control point is attracted to other objects.

A microdocument also exerts gravity on other objects. Objects are attracted to the baseline. Objects moving horizontally are attracted to a variable-width microdocument at the endpoints of the baseline. Objects moving vertically are attracted along the length of the baseline.

## Changing Alignment of Variable-Width Microdocuments

You can reset the alignment default for new microdocuments (and text strings) by entering one of the following keyboard commands:

- CTRL-l for flush left alignment
- CTRL-c for centered alignment
- CTRL-r for flush right alignment

There are three ways to change the alignment of a selected variable-width microdocument: using the keyboard alignment commands, the popup menu **Align** commands, and any **Size** command which horizontally resizes the microdocument in a multiple selection. The popup menu align commands are shown in Figure 23-5.

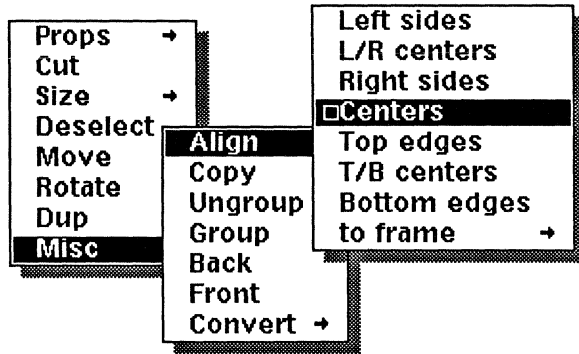

Figure 23-5. Align submenu

**Left sides** changes the alignment of the microdocument you have selected to flush left. **L/R centers** and **Centers** both change the alignment to centered. **Right sides** changes the alignment to flush right.

You can reverse the alignment of a left- or right- aligned variable-width microdocument by selecting it and executing **Size Reflect Horizontal**. When you horizontally size a selection of objects which includes a right- or left-aligned microdocument, the microdocument's alignment is reversed, if the resizing causes the text to move fully past the microdocument's control point.

## Changing from Variable-Width to Fixed-Width

A variable-width microdocument becomes a fixed-width microdocument whenever it becomes more than one line long. This can happen when any of the following events occurs.

- You enter a **RETURN** or a **LINE FEED** in the microdocument. (Its width is then the distance between the first character on the first line and the character position where you entered the **RETURN** or **LINE FEED**.)
- You enter enough text to make the document more than 24 inches wide. (The excess text scrolls onto the next line, and the width is fixed at 24 inches.)

A variable-width microdocument also becomes a fixed-width microdocument whenever you open a component or page property sheet in the microdocument.

A fixed-width microdocument cannot be changed to variable-width.

## Fixed-Width Microdocuments

There are two ways to change the width of a fixed-width microdocument, either by using one of the **Size** commands or by changing the page width using the Document Page property sheet (described in the chapter *Text in Frames*.)

There are three ways to create a fixed-width microdocument:

- use the **Create Misc Text** command
- **Paste** a selection of main document or microdocument text, a component, or a document into a diagram
- convert a variable-width document

Executing the **Create Misc Text** command creates an empty microdocument (with a fixed width of three inches), which you can immediately manipulate as a diagramming object.

To create a microdocument using the **Create Misc Text** command:

- ✓ Choose **Text** from the **Create Misc** submenu (Figure 23-6).

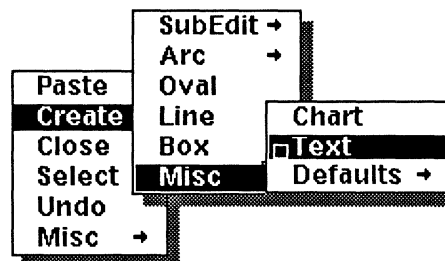

Figure 23-6. Create Misc Text command

The microdocument appears as a bounding box (Figure 23-7).

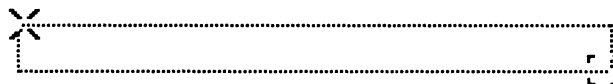

Figure 23-7. Empty, default microdocument

The microdocument is in a **Size Horizontal** mode. When you deselect an empty microdocument, the box remains visible while the frame is open. Display of microdocument bounding boxes in closed frames can be turned on and off using the **Misc → Show → Text Anchors** command on the Text Location menu. The bounding box does not print.

## Control and Anchor Points on Fixed-Width Microdocuments

A fixed-width microdocument has four possible control points: one on each corner of the bounding box. The way these control points are used in **Align**, **Size**, and **Move** commands is different for each operation.

## Modifying Microdocuments as Diagramming Objects

Most diagramming operations can be performed on microdocuments. Some of the operations affect fixed-width microdocuments differently than they affect variable-width microdocuments.

### Sizing Fixed-Width Microdocuments

When you **Size** a fixed-width microdocument, the control point closest to the mouse cursor when you execute the command becomes the *anchor point*. The opposite corner becomes the *active control point*.

The height of a microdocument changes as necessary when you add to or delete from its contents, or when horizontal sizing expands or contracts the text vertically (Figure 23-8).

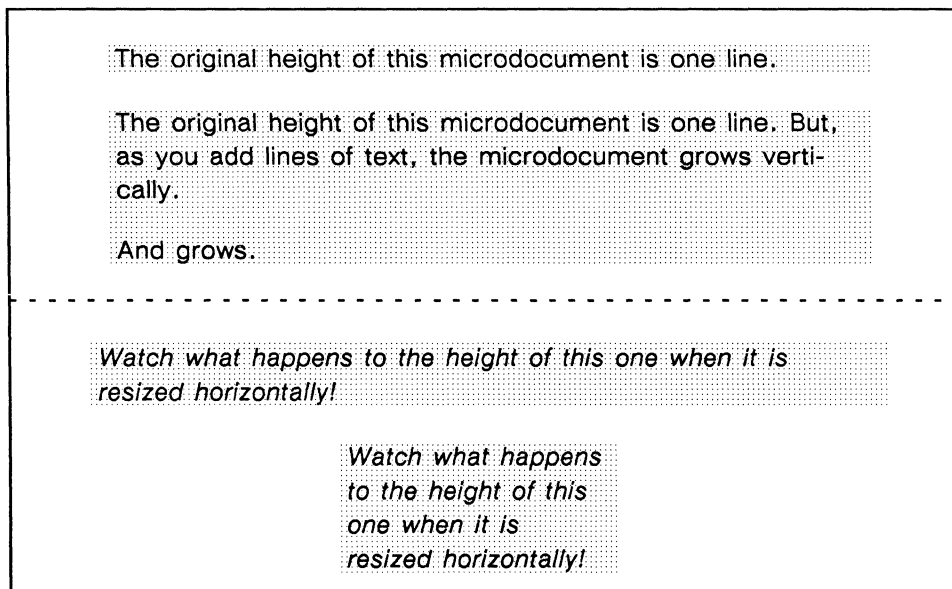

Figure 23-8. Sizing microdocuments horizontally

When you size a single microdocument vertically, an active control point and an anchor point are chosen, but the object moves as if you had executed a **Move Vertical** command.

When you vertically size a multiple selection or group of microdocuments, the space you add is distributed *between* the microdocuments (Figure 23-9).

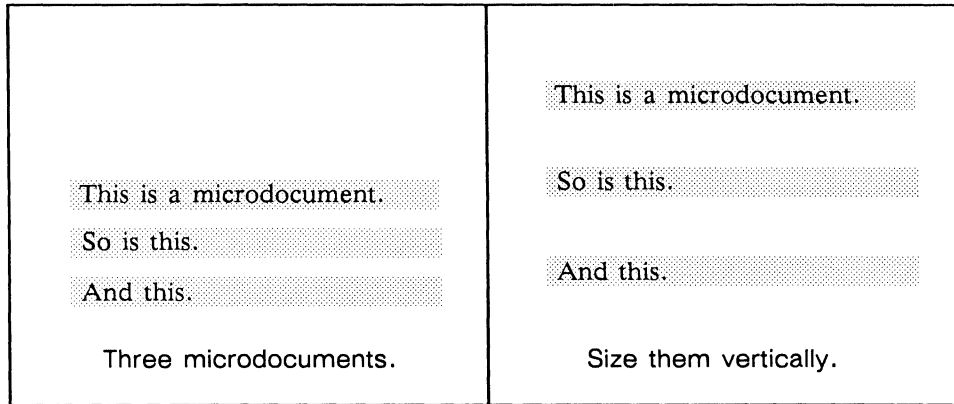

Figure 23-9. Sizing several microdocuments vertically

### Sizing Variable-Width Microdocuments

When you vertically size a single variable-width microdocument or a selection of them, the results are the same as for fixed-width microdocuments.

#### *Realigning with Size Commands*

You can reverse the alignment of a left- or right-aligned variable-width microdocument by selecting it and executing **Size Reflect Horizontal** or **Size Reflect Diagonal**, or by sizing it horizontally or diagonally with other selected objects.

### Moving Fixed-Width Microdocuments

When you **Move** a microdocument, the control point closest to the mouse cursor when you execute the command becomes the active control point. This point is attracted to grid points and gravity points on other objects.

### Moving Variable-Width Microdocuments

When you **Move** a variable-width microdocument, the control point is attracted to grid points and gravity points on other objects.

### Rotating Microdocuments

A single microdocument cannot be rotated, but you can rotate a multiple selection of microdocuments. Figure 23-10 shows three microdocuments before and after they had been rotated  $-45$  degrees.

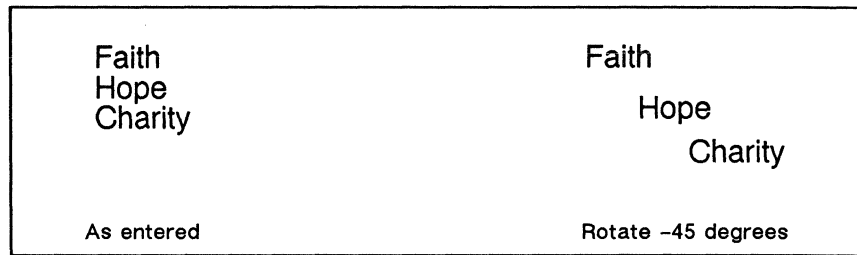

Figure 23-10. Rotating microdocuments

## Changing the Font of a Microdocument

To change the font of an entire microdocument or selection of microdocuments, select the microdocument(s) and execute the desired font command on the **Props Font** submenu. Changing the font in this manner changes the default font in all of the components in the microdocument. For more information on changing fonts in a microdocument, see the chapter *Text in Frames*.

## Undoing Editing Changes to Microdocuments

If you execute **Undo** after closing a microdocument edit, all of the changes made during that editing session will be undone.

## Cutting, Copying, and Pasting Microdocuments

You can **Cut** or **Copy** a closed microdocument. You can then **Paste** it into a frame or into a main document. You cannot paste a microdocument, or any diagramming object, into an open microdocument. For more information on cutting, copying, and pasting microdocuments and their contents, and on pasting text *into* microdocuments, see the chapter *Text in Frames*.

## Editing and Closing Microdocuments

There are two ways open a microdocument so that it can be edited.

### To edit a microdocument:

- ✓ Select the microdocument and execute the **Props Edit** command (Figure 23-11).

*The editing cursor will appear where you had the diagramming cursor.*

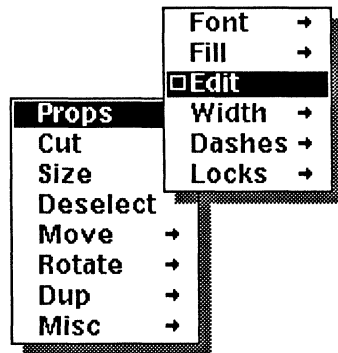

Figure 23-11. Props Edit command

- or ✓ Select the microdocument, place the diagramming cursor where you want to enter new text, and begin typing.

*Not all characters can be used for opening a microdocument edit. For instance, pressing the TAB key will not open an edit.*

Whether it is empty or not, a microdocument will appear in a bounding box while it is being edited. In addition, you will see the editing caret (Figure 23-12).

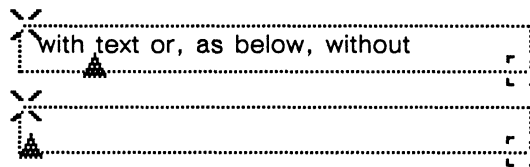

Figure 23-12. Open microdocuments

While a microdocument is being edited, the component bar displays the names of components in the microdocument, and the message: *Microdocument Edit* appears in the status line. All operations performed in the component bar and some operations performed in the document header boxes while a microdocument is open affect the microdocument only, rather than the main document. For more information on editing microdocuments, see the chapter *Text in Frames*.

#### To close a microdocument edit:

- ✓ From the microdocument Text Location popup menu, choose the **Close** command.
- or ✓ Move the diagramming cursor outside the microdocument and click the **left** button.

## Text Strings

A text string is a single line of text that you create differently from a microdocument. With text strings you have editing capabilities that are different from the main text processing capabilities of the publishing software.

The initial default alignment for text strings (and microdocuments) is flush left. You can change this default.

### To preset text string alignment:

- Type **Ctrl-l** for left-justified text; **Ctrl-c** for centered text; or **Ctrl-r** for right-justified text.

### To create a text string:

- ↖ Point the diagramming cursor where you want the text string.
- Type **Ctrl-o**.
- Begin typing.

*As soon as you begin typing, the cursor position at which you pointed is marked with an invisible text anchor.*

## Text Anchors

Each text string is attached to a **text anchor**. Each anchor is composed of a vertical line whose lowest point marks the precise cursor position and an arrow head pointing in the direction that text will move as you type.

There are three kinds of anchors: one for flush left text, one for centered text, and one for flush right text. Figure 23-13 shows the text anchors much larger than they appear on your screen.

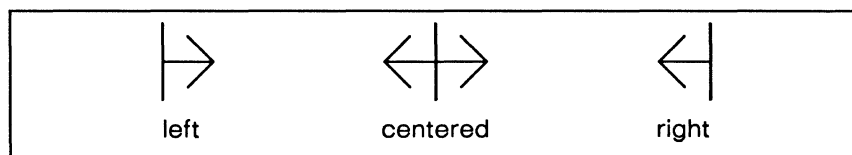

Figure 23-13. Left, centered, and right text anchors

The text anchor is invisible as long as there are characters in the text string. If you delete the text characters, you will see the anchor on the screen. However, if you **Cut** the text string by executing the **Cut** command, you are cutting everything, including the text anchor. Text anchors do not print.

Each text anchor can have only one text string associated with it. If you enter text, press the **TAB** or **RETURN** key, and enter more text, you create two separate text strings.



Each text string can have only one font. Thus, each time there is a change of font in a line of text, there is a separate text string.

## Editing Text Strings

While you are entering or editing a text string, the diagramming system will display a message in the status line to indicate that you are working in a special mode. The exact wording of the message will depend on the alignment of the text string you are working on. Figure 23-14 shows the message you will see if you are working on a text string that is aligned flush left.

entering flush left text (ctrl-R flush right, ctrl-C centered)

*Figure 23-14. Status line when you enter a text string aligned flush left*

If the mouse cursor is outside the diagram when you begin to type a text string, the diagramming system will position the anchor inside the border of the frame, as close to the cursor as it can get.

A text string you are entering is automatically selected, so that you can move it around or change its font if you want to. The text does not flash while you type. If you stop typing and move the diagramming cursor, the text will begin to flash. As long as the text string is selected, you can edit it.

All of the deselection methods you have learned will work with text strings. In addition, all of the keyboard editing commands described in the next section, except the **DEL** key and **CTRL d**, will also deselect the text string when applied.

### *Text String Editing Commands*

All of the characters in each font are available to you in diagramming. However, in diagramming you can only use the keyboard editing commands listed below.

- DEL** deletes the right-most character in the selected text string. If you delete the last remaining character in the text string, the text anchor becomes visible.
- CTRL d** deletes the entire contents of the selected text string, but leaves the text anchor.
- RETURN** deselects the current text string and moves the cursor down to the next line. The diagramming cursor is vertically aligned with the anchor of the previous text string.
- LINE FEED** does exactly the same thing that **RETURN** does.
- CTRL n** does exactly the same thing that **RETURN** does.

- CTRL p** deselects the current text string and moves the cursor *up* the page a distance that is equivalent to the point size of the current font. The diagramming cursor is vertically aligned with the anchor of the text string below it. If no text string is selected, the cursor just moves up a distance that is equivalent to the point size of the current font.
- TAB** deselects the current text string and moves the diagramming cursor right to the next major grid point after the text string. The cursor does not move up or down.

## Font and Line Spacing

Each text string can have only one typeface and one point size (type size).

### Font

The default font for a text string is the font that is displayed in the Font box in the document header. The default font changes every time you select a text string in a different font.

There are three ways to change the font *before* you enter a text string:

- select a text string of the correct font and deselect it
- use the Font submenu on the Defaults submenu
- set the font in the Font box in the document header

Figure 23-15 shows the Font submenu of the Create Misc Default submenu. All of the fonts used in text are available in the diagramming system through this submenu.

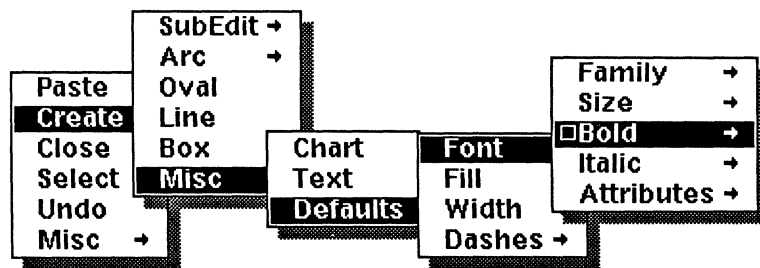

Figure 23-15. Changing the font before creating a text string

There is no way to establish a font to which all newly created text strings will default. The Fonts submenu only sets the font for the next text string you create. If, after you have changed the default, you select a text string that has a different font, you will have changed the default again to the font of the selected text string.

There is no default on the Fonts submenu. If you try to execute the **Fonts** command without displaying the submenu, nothing will happen. However, if you display the submenu, **Bold** is the default.

To change the font of an *existing* text string, use the Props Font submenu of the Object Selected menu (Figure 23-16).

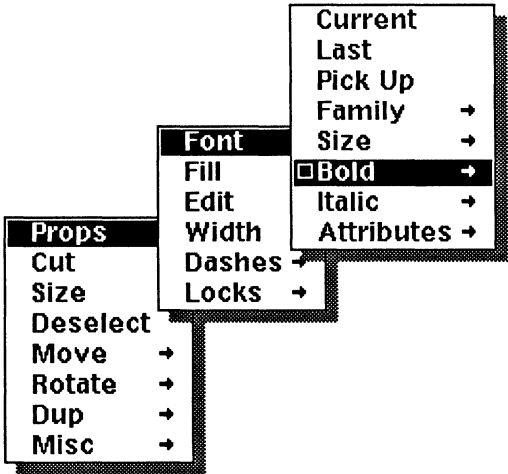

Figure 23-16. Changing the font of an existing text string

*Line Spacing*

Figure 23-17 shows approximately the height of the *point size* for a text string that is 24 point.

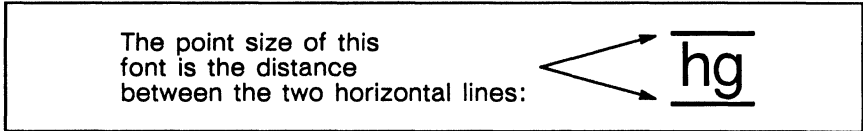

Figure 23-17. Point size of a font

When you enter text strings, the distance from one line to the next (measured baseline to baseline) following a carriage return is equal to the height of the current font. However, if you change the size of an existing text string, the space, baseline to baseline will remain the same.

**Baseline** is the typographer's name for the imaginary line on which a text string sits. The descenders on certain lower-case letters (the tail on a *q* or *y* is a descender) go below the baseline. The horizontal line in Figure 23-18 marks the baseline on a text string.



Figure 23-18. Baseline on a text string

It is best to enter all text strings in a diagram first, and then adjust the line spacing so that it is the same for every text string. If you enter and size first two and then three text strings, you cannot be sure that you have adjusted the line spacing of all five text strings by the same amount.

**To increase or decrease the line spacing between text strings:**

- Enter all of the text strings.
- ✓ Select all of the text strings.
- ✓ Execute the **Size Vertical** command.

*The Size Vertical command increases the amount of vertical space between text strings rather than changing the type size of the text strings themselves.*

## **Modifying Text Strings as Diagramming Objects**

Not all diagramming commands have an effect on a single text string. You can **Cut**, **Copy**, **Dup**, or **Paste** a text string, and you can move it around, but you cannot size or rotate it.

You can **Size** or **Rotate** a group that contains text. You can also **Size** or **Rotate** two or more text strings. These commands do not affect the text strings themselves, only their relation to each other.

### *Sizing Text Strings*

When you execute **Size Vertical** a multiple selection of text strings, the space you add to the size is distributed *between* the text strings. For example, if two text strings are sized vertically a distance of two grid units, the two grid units will be added to the space between the two strings.

You can reverse the alignment of a left- or right-aligned text string by selecting it and executing **Size Reflect Horizontal** or **Size Reflect Diagonal**. If you horizontally or diagonally size a selection of objects that contains a left- or right-aligned text string, and the resizing causes the text to move fully past its anchor, the alignment of the text string will be reversed.

### *Rotating Text Strings*

A single text string cannot be rotated. When you rotate a multiple selection of text strings, the text strings move, as shown in Figure 23-19.

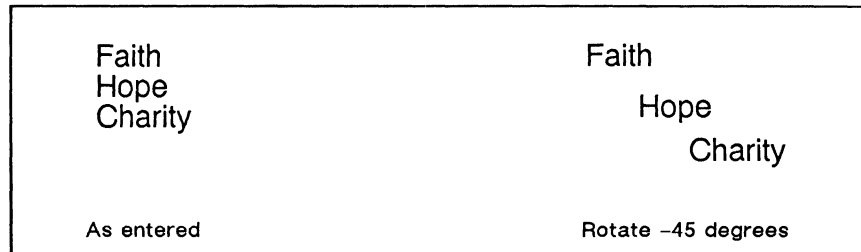

Figure 23-19. Rotating text strings

### Text String Control Points and Gravity

When you move a text string, its control point is at the bottom of the vertical line in the text anchor. Figure 23-20 shows the control point on each kind of text.

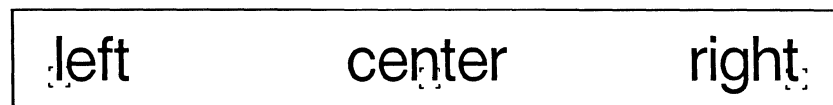

Figure 23-20. Text string control points

The text anchor control point is like a control point on any other object. If **GridAlign** is *on*, the control point is attracted to grid points. If **Gravity** is *on*, the control point is attracted to other objects.

A text string also exerts gravity on other objects. Objects are attracted to the baseline of the text string. Objects moving horizontally are attracted to a text string at the endpoints of the baseline. Objects moving vertically are attracted along the length of the baseline.

Gravity on one text string in relation to another text string is not useful because the screen and printer widths of fonts are different. Even if the control point of one text string lines up with the gravity point at the end of the baseline of another text string on the screen, the text in one may overlap the other when they are printed.

The only point in a text string that you can count on printing exactly where it is displayed is the point marked by the text anchor. You can use this fact to make two text strings line up correctly and print as if they were one object.

### To connect two text strings so they print correctly:

- ✓ Turn **GridAlign** *off*.
- ✓ Make the first text string right aligned.
- ✓ Make the second text string left aligned.
- ✓ Select the second text string again.

- ✓ Execute the **Move** command and allow gravity to bring the anchor points of the two objects together.

*You can be sure that the two text strings will print as one.*

There is no way to be sure that more than two text strings on a line will be spaced correctly. If you must use three separate text strings on a single line in a diagram, you will have to adjust the spacing by eye. A microdocument is usually the best text object to use when you want to change fonts within a line.

## Realigning Text Strings

Starting at the position marked by the text anchor, text characters can grow in one of three directions:

- If the text anchor is flush left, the text will grow to the right.
- If the text anchor is centered, the text will grow in both directions from the center.
- If the text anchor is flush right, the text will grow to the left.

Figure 23-21a shows where the text anchor is placed. Figure 23-21b shows how text grows when aligned. In this figure the vertical dashed line marks where the diagramming cursor was placed when the writer started typing each of the words.

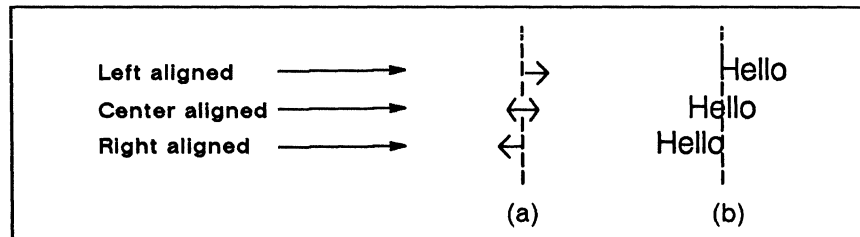

*Figure 23-21. Text that has been entered with left, centered, and right text anchors*

There are four ways to adjust the alignment of a text string:

- with keyboard commands
- with commands on the **Align** submenu
- with the **Size Reflect Horizontal** or **Size Reflect Diagonal** command
- by sizing the text string horizontally or diagonally with a selection of other objects

### Keyboard Align Commands

To change the alignment of an existing text string or anchor, select the object and enter the appropriate keyboard command:

- CTRL-l changes the alignment to flush left
- CTRL-c changes the alignment to centered
- CTRL-r changes the alignment to flush right

When you change the alignment of an existing text string, the *text anchor* remains stationary, while the *text* repositions itself.

The keyboard commands can be used on only one text string at a time. If you select several text strings and enter a keyboard command, only the last string you selected will be changed.

---

*Use the keyboard commands when you do not want the text anchor to move (if you have lined it up with something else in your diagram, for example).*

### Popup Menu Align Commands

Each of the first four **Align** commands on the Align submenu to change the alignment of a text string:

- **Left sides** changes the text string you have selected to flush left.
- **L/R centers** and **Centers** both change the text string to centered.
- **Right sides** changes the text string to flush right.

When you change the alignment of a text string using an **Align** command, the text will not reposition itself as it does when you use a keyboard command. Instead, the text anchor will move so that, when you begin to type additional characters, they will grow from the repositioned text anchor in the appropriate direction.

The **Align** commands will work on more than one text string at a time. If you align several text strings at once, the text will move as well as the text anchor, but the movement will be minimized.

The **Align Centers** command will align the top/bottom as well as the left/right centers of text strings. In other words, it will put all of the text strings on top of one another. For this reason, it is really only useful when you are working with a single text string. The **Align L/R centers** command changes only the horizontal alignment, so it is useful when you want to align a column of text strings.

The first four commands on the **Align to Frame** submenu also change the position of text; but since they have other effects as well, they are discussed with alignment in the chapter *Modifying Diagrams*.

## **Editing Text Strings in Groups**

Even when several text strings are grouped together you can change the text that each one contains.

### **To change the text of one text string in a group:**

- ☞ Point the mouse cursor at the line you want to edit.
- ☐☐☐ Click the **left** button to select the group.
- ☐ Begin editing.

However, you cannot change the *font* of a single text string in a group that contains more than one object: you must either change the font of all text strings in the group or execute the **Edit** command on the group (see the chapter *Advanced Diagramming Concepts*), select the single text object, and change its font.



---

## Chapter 24

# Advanced Diagramming Concepts

In this chapter, the following advanced diagramming concepts are discussed:

- the **Edit** command
- the commands on the SubEdit submenu
- the commands on the Lock and Unlock submenus
- customized grids
- isometric/orthographic conversions
- diagramming defaults
- adding CAD drawings to a document

## The Edit and SubEdit Commands

You can use the **Edit** command on the Props submenu to edit individual parts of a group. You can use the **SubEdit** commands on the Create submenu to create groups, polys, splines (smoothed polys), and free-hand drawings.

## Editing Groups

The **Edit** command allows you to change individual parts of a group while preserving the association among the parts. When you execute this command on a group, you are placed in a special mode called a **subedit** in which you cannot select anything that is not part of the group.

Figure 24-1 shows the **Edit** command on the Props submenu.

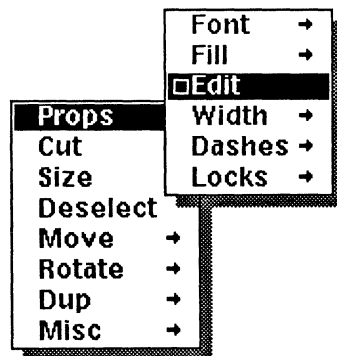

Figure 24-1. Edit command on the Props submenu

To edit a group, select it and execute the **Edit** command. You will see the Sub-Edit stickup (Figure 24-2).

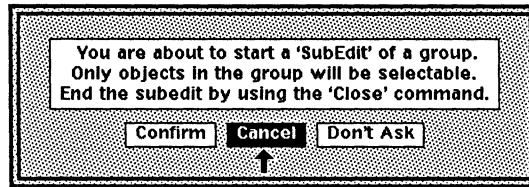

Figure 24-2. SubEdit stickup

If you choose **Confirm** on this stickup, you will enter a subedit level. The next time you execute the **Edit** command, you will be asked again to confirm.

If you choose **Don't Ask**, you will also enter a subedit level, but if you later open other subedits, the diagramming system will not ask you to confirm your action again until you have closed and reopened your desktop.

## SubEdit Levels

Since groups are hierarchical, edit levels are also hierarchical.

The top level is the diagram itself. When you edit a group, you move into the first subedit level. If, while in the first subedit level, you edit a group that is part of the first group, you move into the second subedit level, and so on. You can move down a total of ten subedit levels.

You enter the next subedit level with the **Edit** command. You exit to the previous level with the **Close** command. If you are already at the top level, the **Close** command closes the frame you are working in.

## Working in a SubEdit

At a particular edit level, you can manipulate only the objects that are part of that level. You can execute any of the commands on the diagramming popup menus on the objects at the current level (Figure 24-3).





	<p>This group consists of two groups—the pentagon and the ovals. On the top level, you can change the object as a whole.</p>
	<p><i>Level 1 SubEdit</i> Edit the object, and you can change the ovals or the pentagon as wholes.</p>
	<p><i>Level 2 SubEdit</i> Edit the pentagon, and you can add a side. But you can't change the ovals.</p>
	<p><i>Level 2 SubEdit</i> Close the hexagon, edit the ovals, and you can cut the black ovals. But you can't change the hexagon.</p>
	<p><i>Level 1 SubEdit</i> Close the ovals and you can move the group of ovals back over to the hexagon.</p>

Figure 24-3. Editing an object

When you enter a subedit level, the level is displayed in the status line. Figure 24-4 shows the status line as it would look if you were at the top level when you executed the **Edit** command.

**Level 1 SubEdit (Use 'Close' to exit): GridAlign on, Gravity on, Detent 15.0 degrees**

Figure 24-4. Status line at the first subedit level

If you were already at level 1 when you executed the **Edit** command, you would be entering the second subedit level, and the status line would read “Level 2 Sub-Edit...,” and so on.

As you move through subedit levels, the diagramming environment and popup defaults may be affected. For more information on defaults in subedits, see the *Defaults in Diagramming* section later in this chapter.

## Editing and Undo

If you **Edit** a group, **Close** it, and then execute the **Undo** command, the diagramming system restores the group to the way it was before you edited it. In other words, you are completely undoing the **Edit**. You can even change a group within a group and then undo all your changes at the top level.

## Using the Create SubEdit Commands

The **Create SubEdit** commands allow you to:

- create a poly or spline with fewer commands
- create a poly or spline when **Gravity** is off
- create objects in temporary isolation from the rest of your diagram
- create a free-hand drawing

Figure 24-5 shows the **SubEdit** menu with the default command.

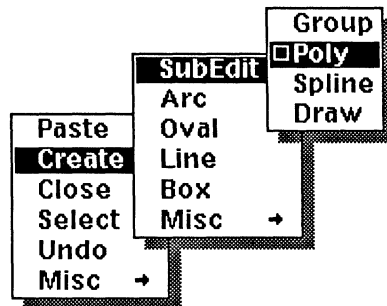

Figure 24-5. *SubEdit* commands

When you execute one of the **SubEdit** commands, you will see the **SubEdit** stickup. Use the **SubEdit** levels that follow in the same way you would use the **SubEdit** levels that follow the **Edit** command.

When you use any of the **SubEdit** commands (other than **Draw**), all of the commands on the diagramming popup menus are available to you. You can create another group within the group, in which case, the status line will be changed to read “Level 2 SubEdit: ....”

### The SubEdit Group Command

You use the **Group** command on the **Misc** submenu of the **Objected Selected** menu to group objects or groups you have already created. When you use the **Create SubEdit Group** command, you create a group first and then create the objects or groups in it.

**To create a group with the Group command:**

- ✓ Execute the **Create SubEdit Group** command.  
*The software enters a subedit mode.*
- ✓ Create the objects you want to include in the group.
- ✓ Execute the **Close** command.

*This returns you to the top level of the diagramming system and the objects you have created are grouped together.*

Ungroup a group created with the **Group** command the same way you ungroup any other group: select the group and execute the **Misc Ungroup** command.

In Figure 24-6, the overlaid arrow and label were created using the **Group** command so that the artist did not have to worry about accidentally selecting parts of the underlying assembly.

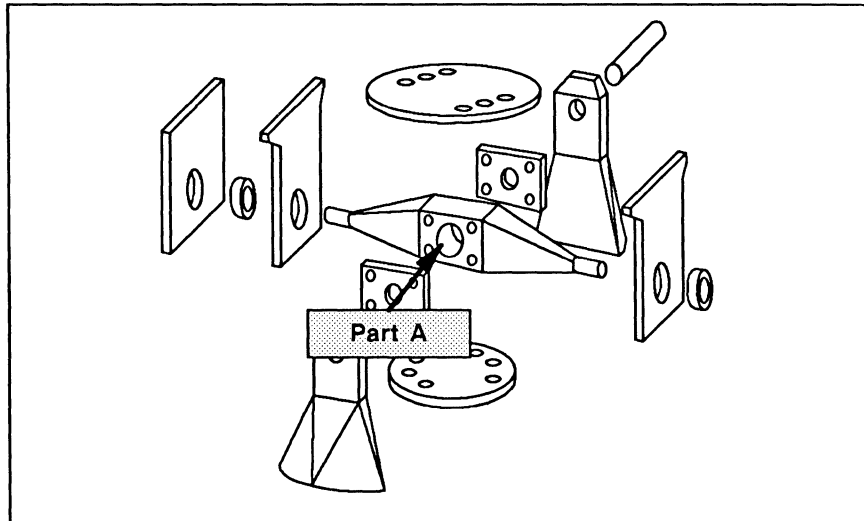

Figure 24-6. Using the Create SubEdit Group command

### The Poly Command

When you execute the **Poly** command, you are placed in a special poly entry mode in which holding down the middle button automatically deselects the line you have just created and releasing the button creates another.

Figure 24-7 shows the difference in mouse button clicks between creating polys with the **Create SubEdit Poly** command and creating a poly with individual lines.

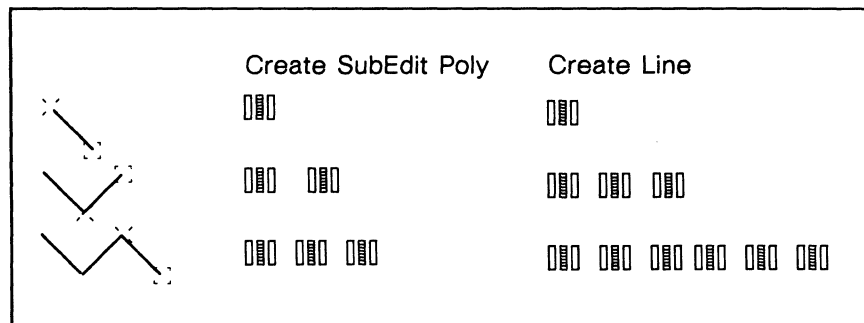

Figure 24-7. Creating polys with the Poly command vs. with individual lines

### To create a poly with the Poly command:

- ✓ Execute the **Create SubEdit Poly** command.  
*The software enters a subedit mode.*
- ☰☐ Size the line until it has the correct angle and length.
- ☐☐ Click the **middle** button to drop the line and begin a new one. Size the new line until it has the correct angle and size.  
*If you hold down the middle button instead of clicking, you will see the Create submenu with the **Line** command in reverse video.*
- ☐☐ Continue clicking the **middle** button to create new lines until your poly is complete.
- ✓ Hold down the **middle** button, select the **Close** command, and release the button.  
*The subedit level you had entered will be closed, and the lines will be grouped together. If you have set a default pattern fill, the poly will be filled automatically.*

As long as you are in poly entry mode, you will not see the Object Selected popup menu. Instead, if you hold down the middle button, you will always see the Nothing Selected menu with the **Create Line** command in reverse video.

When you first begin to use the **Poly** command, you may find that you have created lines you do not want. If this happens, you can temporarily suspend the special entry mode, correct the problems, and then re-enter poly entry mode.

### To suspend poly entry mode:

- ☐☐ Hold down the **middle** button.
- ☰☐ Slide the cursor off the menu and release the button.  
*Poly mode will be suspended, but you will still be in the subedit.*

When you suspend poly entry mode, you can execute any of the commands on the Object Selected and Nothing Selected popup menus.

When you are ready to continue with your poly, use the following procedure.

### To reenter poly entry mode:

- ☰\ Point the mouse cursor at the end of an existing line of the poly.
- ✓ Execute the **Create Line** command.

When you **Close** the subedit level, the diagramming system will group all of the objects created in the subedit.

## The Spline Command

The **Spline** command is almost identical to the **Poly** command. However, when you close the subedit level, the objects you have created are automatically smoothed.

To create a spline using the **Spline** command:

- ✓ Execute the **Create SubEdit Spline** command.
- ✓ When you have a poly you are satisfied with, execute the **Close** command.

*The poly will be smoothed, and, if you have set a default pattern fill, it will be filled.*

## The Draw Command

The **Draw** command puts the software into a subedit mode in which the mouse can be used like a pen. When you move the mouse, the software automatically creates a series of tiny lines to follow the movement. The result can be filled, to make the drawing a poly or part of a poly.

Figure 24-8a was created using the **Draw** command. The successive enlargements in Figure 24-8b and Figure 24-8c show that the seemingly curved edges in a drawing actually consist of many short, straight lines.

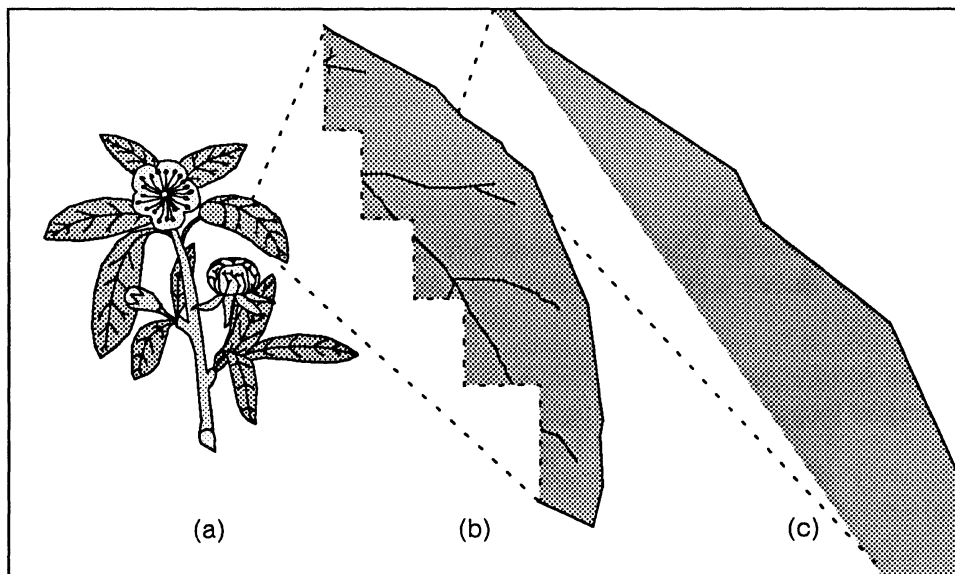

*Figure 24-8. Plant created with Draw command*

When you execute the draw command, several changes in the diagramming environment occur:

- the cursor takes on a special shape
- every movement of the cursor creates a series of lines

- a new set of menus is available
- the cursor cannot be moved out of the frame until you exit the drawing subedit mode

**To create a drawing with the Draw command:**

- ✓ Execute the **Create → SubEdit → Draw** command.  
*The cursor is replaced by a special control point (Figure 24-9).*

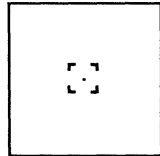

*Figure 24-9. Draw control point*

When you move the mouse you create a series of lines, which have the default width and dash pattern. To return to the normal diagramming cursor mode, you must close the drawing.

**To close a drawing:**

- ✓ Execute the **Close** command on the Draw popup menu.

You can also use the Draw menu to “turn the ink off” which allows you to move the cursor without creating any new lines. When you execute the **Ink on/off** command, it becomes the temporary default, until you execute one of the other commands on the draw popup menu.

**To move the draw control point without drawing:**

- ✓ Execute the **Ink on/off** command on the Draw popup menu.  
*When you move the mouse, lines are not created.*
- ✓ Move the control point to where you want it, then execute the **Ink on/off** command again.  
*Now when you move the mouse, more lines are created.*

**To include a straight line in a drawing:**

- ✓ Execute the **Linear on/off** command on the Draw popup menu (Figure 24-10).

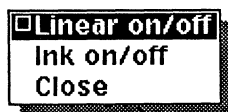

*Figure 24-10. Linear on/off command*



*This is the same as if you had executed a **Create Line** command. The line will be anchored at the point where the draw control point was when you executed the **Linear on/off** command.*

- ✓ Position the control point where you want the straight line to end, then execute the **Linear on/off** command again.

### Modifying Drawings

Once you have closed a drawing, you can modify it using the **Props Edit** command. The **View** commands, especially **Zoom**, and the **Select Wipe** command are useful for editing intricate drawings, which can contain many short lines in a small area. **Zoom** and **Select Wipe** are discussed in the chapter *Basic Diagramming Concepts*.

## Moving Objects between Groups

You may find that an object (or a copy of it) that is part of one group should be in another group. If you edit the first group and **Dup(licate)** the object, it remains associated with the first, rather than with the second group. To break the association with the first group and establish one with the second group, you must use either the **Cut** or **Copy** command.

### To move an object from one group to another:

- ✓ **Edit** the first group.
- ✓ Select the object you want to move and **Cut** it.  
*This step breaks the association between the object and the first group by putting the object on the clipboard.*
- ✓ **Close** the first group, and **Edit** the second.
- ✓ **Paste** the object.  
*This step makes the object part of the second group.*
- ✓ **Close** the second group.

This strategy will also work if you use the **Copy** command instead of **Cut**.

## Locks

There are two major kinds of locks:

- locks that protect the current state of a property (such as fill, font, and size)
- locks that remove a property (such as gravity, printing, or control)

Some of the things you can do with locks are:

- create complex objects that cannot be dismantled accidentally
- specify the point around which an object will rotate
- create your own grids that do not print and cannot be selected

## Setting and Clearing Locks

If you want to prevent a change to an object, you lock one of its properties. For example, if you do not want to be able to cut an object, you set the cutting lock. Once an object is locked, you cannot change that property of the object unless you clear the lock.

It is important to remember that simply unlocking or locking a property does not change the object. If you unlock grouping on a box, for example, the box is not ungrouped; it just becomes possible to ungroup it. You will have to execute the **Ungroup** command to actually ungroup the box.

Properties are locked (set) and unlocked (cleared) using the Locks submenu. The Set submenu (Figure 24-11) and the Clear submenu each contain a list of all the possible locks.

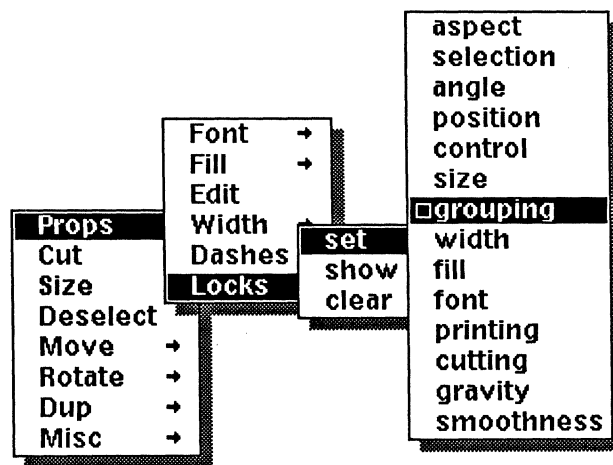

Figure 24-11. Locks set submenu

### To lock or unlock a property on an object:

- ✓ Select the object.
- ✓ Execute the appropriate **Set** or **Clear** command.

If you select several objects and **Set** the lock on a property, that property will be locked on all of the selected objects. If one of the objects already has that property locked, it will not change. Both these provisos are also true if you select several objects and **Clear** a lock.

### Showing an Object's Locks

The default command on the Locks submenu is **Show**. When you execute this command, the status line displays all of the locks on the selected objects.

For example, if you select a newly created box and execute the **Show** command on it, the status line will show that the box is grouping-locked (Figure 24-12).

Locked: grouping

*Figure 24-12. Status line showing locks on a newly created box*

If you execute the **Show** command on a group, you will see only the locks on the whole group. To see the locks that individual objects in the group might have, you must edit the group and then execute the **Show** command on each object.

## The Locks Commands

In this section, you will find a discussion of each lock and some suggestions for using it.

### Aspect Locks

When you aspect-lock an object, you are fixing its proportions. As a result, no matter which **Size** command you use, you will be able to size the object only *diagonally*. This is a protection lock. The shapes that make up some of the borders in the *Graphics* cabinet are aspect-locked so that when you change the size of a border, you do not change the proportions of those shapes.

When you size an aspect-locked object horizontally or vertically, it will grow in the other direction, too, in order to keep its proportions. It will also move and drift away from control points because it can only change proportionally, while you can move the mouse by any amount in any direction (Figure 24-13).

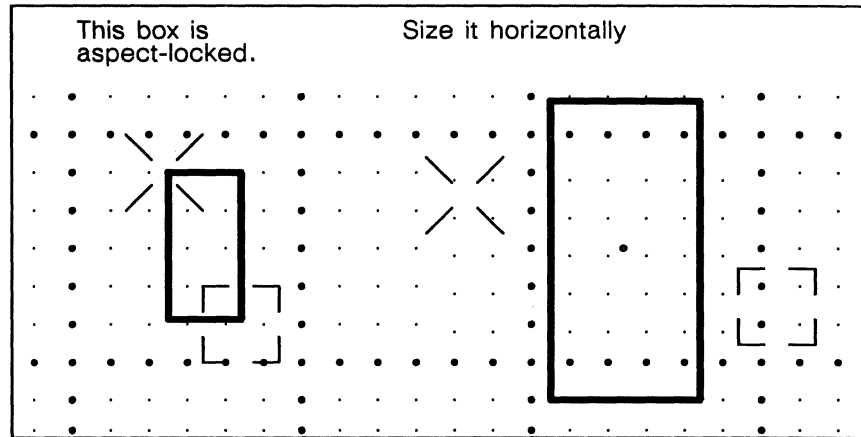

Figure 24-13. Sizing an aspect-locked object

The percentage of change in the object's size is equal to the ratio between the distance from the old anchor point to the old control point and the distance from the new anchor point to the new control point (Figure 24-14).

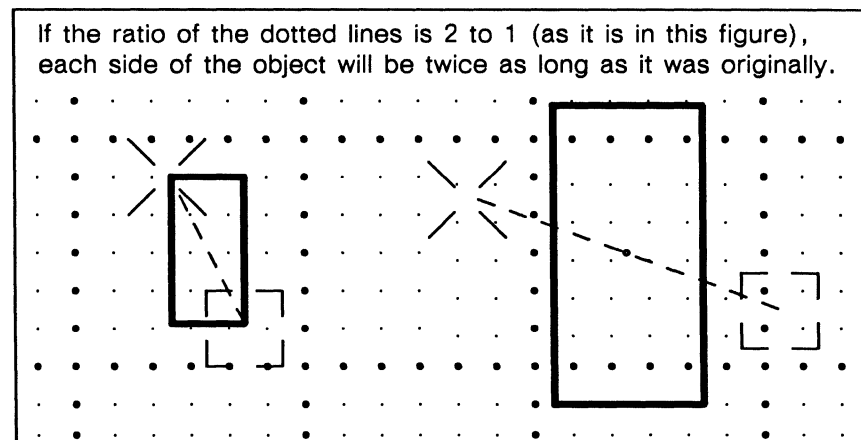

Figure 24-14. Sizing an aspect-locked object horizontally

## Selection Locks

An object that is selection-locked cannot be selected by any of the ordinary methods.

Use this lock when you create templates for forms. If you need to clear away all the data in a form, you can **Select All** and cut. Since the form is selection-locked, it will not be cut.

The documents in the *Graphics* cabinet contain annotations that are selection-locked, so that you will not accidentally select one while selecting an object.

There will be times when you do want to select an object that is selection-locked. For example, you may want to change a section on a form. In order to select se-

lection-locked objects, you must execute the **Select Locked** command on the Nothing Selected popup menu (Figure 24-15).

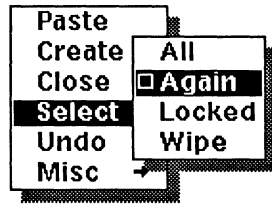

Figure 24-15. Select Locked command on the Nothing Selected menu

This command selects all selection-locked objects in a diagram. Deselect the ones you do not want to change. When you deselect the modified objects, they will again be locked against selection. If you wish to edit a set of selection-locked objects extensively, you may find it easier to **Clear** the selection locks, edit the objects, then **Set** the selection locks again.

If you make a copy or duplicate of a selection-locked object, the copy (or duplicate) will *not* be selection-locked. However, if you make a copy of a whole document or frame that contains a selection-locked object, the object *will be* selection-locked in the copy.

## Angle Locks

An angle-locked object cannot be rotated by itself. If it is part of a group, it will move around the rotation center, but its angle will remain fixed (Figure 24-16).

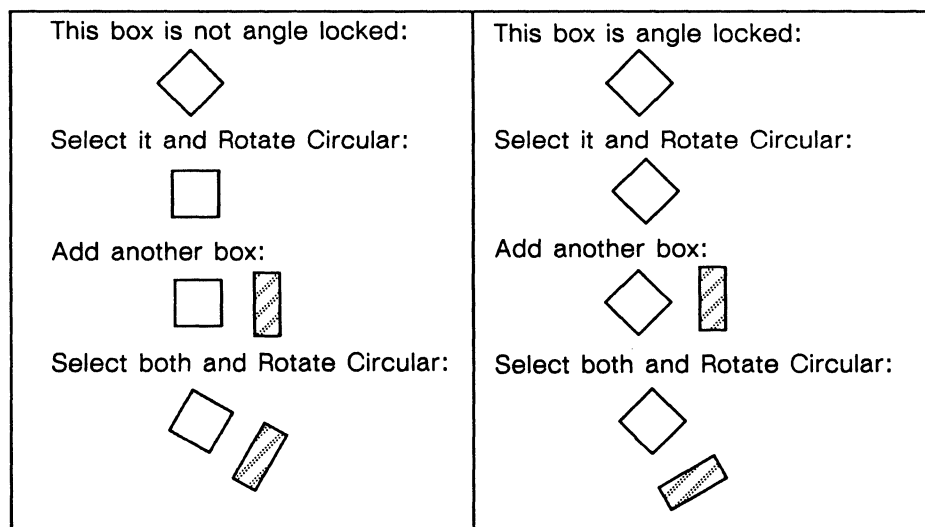

Figure 24-16. Angle locks and rotation

## Control Locks

When a control-locked object is manipulated as part of a group, or as one of several selected objects, the diagramming system *ignores* all of the control points on the other objects when choosing the active control point and the anchor point.

Control locks are used, among other things, to:

- rotate objects around a specified point
- create arrowheads that rotate and magnify correctly
- add control points to an object wherever you want them
- slide an object along a diagonal line you specify

If you control-lock an object, it will act normally as long as you are manipulating it by itself.

If you select a control-locked object and an object that is not control-locked, the diagramming system will use only the control points on the control-locked object (Figure 24-17).

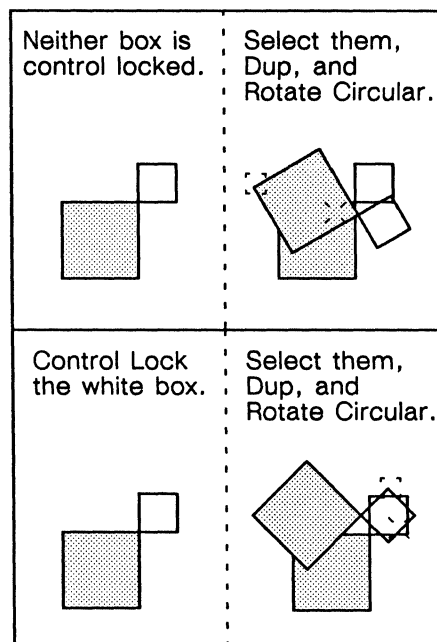

Figure 24-17. Control-locked objects

When neither box is control-locked, the diagramming system chooses the active control point and the anchor point from the control points on both. When the small white box is control-locked, the control points on the gray box are ignored.

When some of the objects you are aligning are control-locked and others are not, the diagramming system draws the bounding box it uses for alignment around *only the control-locked objects*. The other objects are aligned to that bounding box (Figure 24-18).

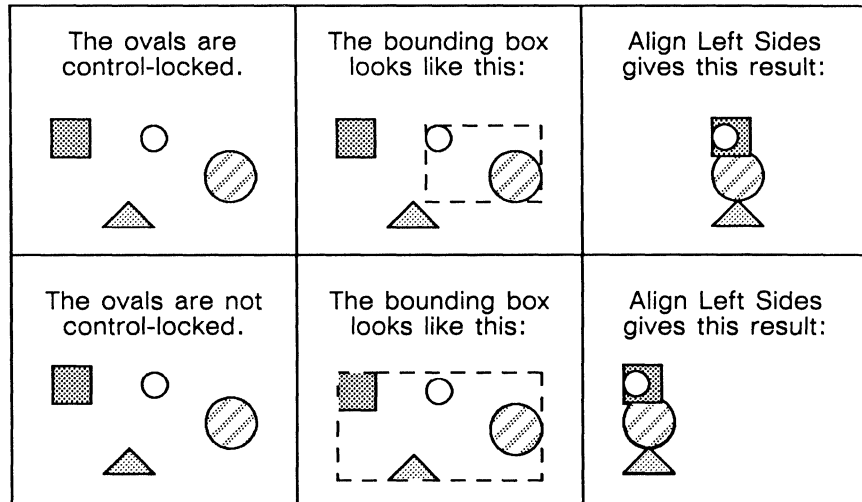

Figure 24-18. Using control locks as an alignment aid

### Position Locks

A position-locked object cannot be moved, rotated, or sized. A position-locked object is also automatically control-locked. Figure 24-19 shows how position locks can be used to control alignment.

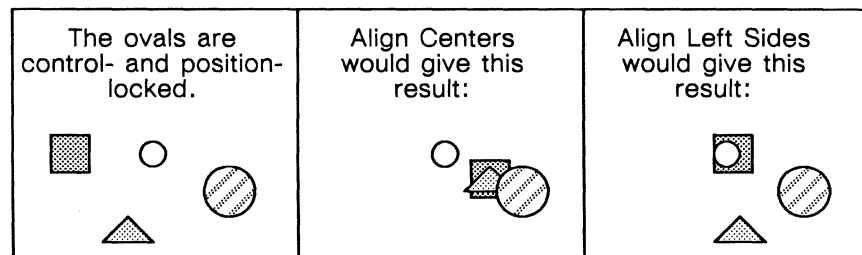

Figure 24-19. Position locks

A copy or duplicate of a position-locked object will not be position-locked. However, if you make a copy of a whole document or frame that contains a position-locked object, the object will still be position-locked in the copy.

### Size Locks

You cannot change the size of an object that is size-locked. The arrows in the *Linear* document in the *Graphics* cabinet consist of two parts: arrowheads and tails. The arrowheads are size-locked so that you can change the length of the tail while preserving the shape of the head.

If you select a size-locked object and some other objects and size them, the size-locked object will move in order to keep the distances between it and the other objects proportional, but it will remain the same size.

If a frame is automatically created for a size-locked object in a document with a page size so small that the object will not fit, the frame will be made as big as the page size allows. The object will not be shrunk to fit the frame, but it will be rotated if that will allow more of the object to fit in the frame.

## Grouping Locks

Objects that are grouping-locked cannot be ungrouped. This lock is useful when you have created complicated groups that you do not want to break up. You may also want to use the grouping lock with polys. Boxes are automatically grouping-locked. **Grouping** is the default command on the Unlock submenu.

## Width Locks

You cannot change the width of an object that is width-locked.

This lock is most often used when building complex objects that contain invisible lines. By locking the width of the invisible lines, it is possible to change the width of the whole object without changing the width of the invisible lines.

## Fill Locks

You cannot change the pattern with which a fill-locked object is filled. For example, the corner of the symbol for a file of cards in the *FlowCharts* document in the *Flowcharts* folder in the *Graphics* cabinet is fill-locked (Figure 24-20).

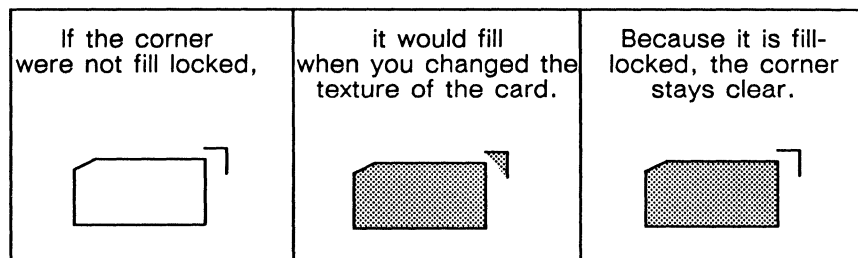

Figure 24-20. Fill lock in a flowchart symbol

## Font Locks

You cannot change the font of a text string that is font-locked. Font locks can be used to:

- preserve the math characters when you change fonts in an equation
- preserve symbols when they are mixed with ordinary text



Figure 24-21 shows a situation in which you might use font locks to preserve symbols in a text string.

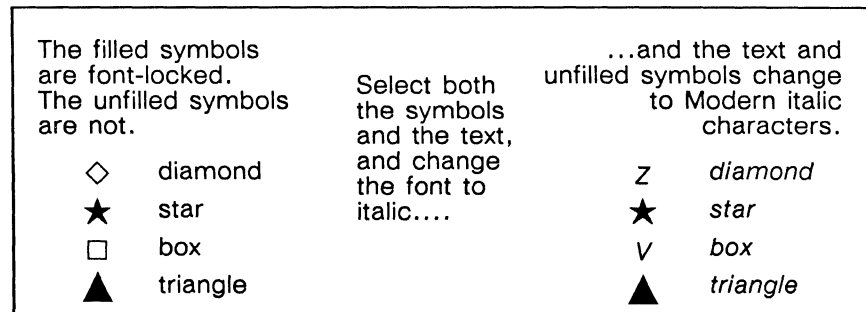

Figure 24-21. Font-locking symbols

## Printing Locks

A printing-locked object will not print. You can use printing locks to:

- create rulers or grids
- create overlays by print-locking and printing successive parts of a diagram

The printing lock is useful for constructing your own diagramming aids. The measures in the *Graphics* cabinet are printing-locked.

## Cutting Locks

An object that is cutting-locked cannot be cut. If you try to cut such an object, a copy of it will be made and placed on the clipboard. Cutting locks can be used to create palettes of objects like the ones in the *Graphics* cabinet, for instance.

The copy (or duplicate) you make of a cutting-locked object will not be cutting-locked. However, if you make a copy of a whole document or frame that contains a cutting-locked object, the object will still be cutting-locked in the copy.

## Gravity Locks

Other objects are *not* attracted to a gravity-locked object. Examples of gravity-locked objects are the graphic fonts in the documents in the *Fonts* folder in the *Graphics* cabinet. These are gravity-locked so that only the six invisible control points on the characters attract other objects.

## Smoothness Locks

An object that is smoothness-locked cannot be converted to a poly if it is a spline or converted to a spline if it is a poly.

## Creating Your Own Grids

With the **Spacing** and **Type** commands on the Grid submenu (Figure 24-22), you can create a variety of grids tailored for different kinds of diagramming work.

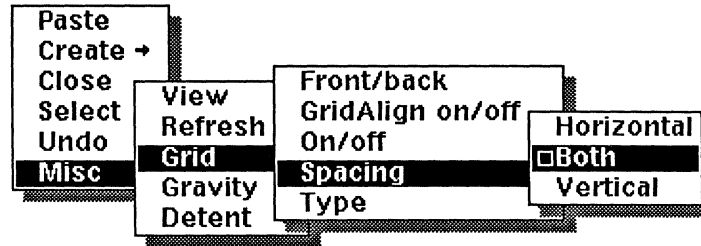

Figure 24-22. Spacing submenu

## Grid Spacing

You can create grids with the same spacing in both dimensions or with different spacing in the horizontal and vertical dimensions. Figure 24-23 shows the two stickup menus on which you enter the values for the distance (in inches) between major grid units and for the number of minor grid units per major grid unit.

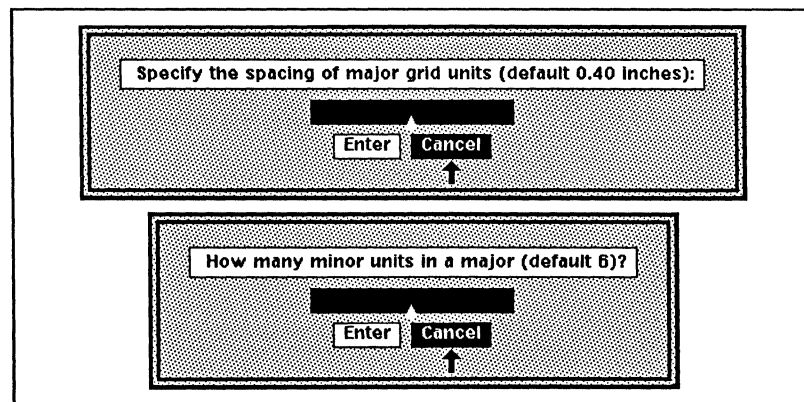

Figure 24-23. Stickup menus for creating grid units

If you want to work in millimeters or picas, you can create a grid with the appropriate spacing.

- Since there are *25.4 mm* to an inch, if you make the major grid spacing the reciprocal of 2.54 and the minor grid units per major grid unit *10*, you will have a grid made up of *1mm* increments with a major grid line every *10 mm*.
- Since there are *72.2648 points* to an inch and *12 points* to a pica, if you make the major grid spacing the reciprocal of 6.022 (*72.2648* divided by *12*) and the minor grid units per major unit *6*, you will have a grid made up of *2 point* increments and a major grid line every *pica*.

You can vary the minor grid units per major grid unit to get a more or less dense grid line without affecting the major grid's size.

When **GridAlign** is *on*, objects will be aligned to the grids you create in the same way that they are aligned to the default grid. If the grid points are very close together, you may not notice objects snapping to grid points. If the grid points are very far apart, the software will allow movement between the points.

## Screen Display of Grids

Some grids, including both the millimeter and the pica grid described in the previous section, will not be displayed perfectly on the screen because of the screen resolution of 75 dots per inch. The anomalies in the display do not affect the functionality of the grids.

If you want to know how well a grid will display on the screen or why one is not displaying perfectly, divide the number of minor grid units per major unit by the distance between major grid units. If 75 is evenly divisible by the product, the display will look perfect. Otherwise, there will be gaps in the screen display that will be more evident the closer the grid points are to each other.

## Isometric Grids

In addition to the default two-dimensional, rectangular grid, you can use an **isometric**, or three-dimensional grid, to create accurate three dimensional-looking diagrams (Figure 24-24).

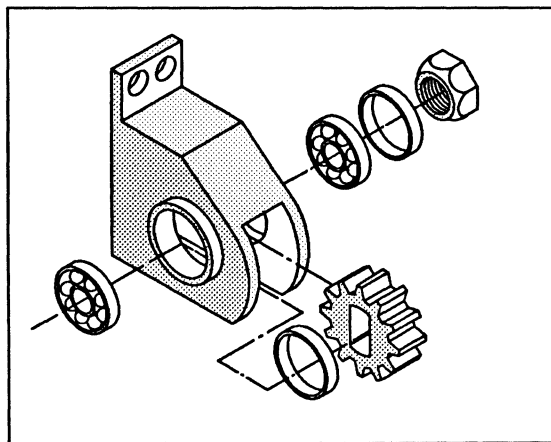

Figure 24-24. Sample isometric diagram

The isometric grid has three axes: **X**, which runs between two o'clock and eight o'clock; **Y**, which is the vertical axis; and **Z**, which runs between ten o'clock and four o'clock (Figure 24-25). The positive direction is toward two o'clock on the X axis, toward twelve o'clock on the Y axis, and toward ten o'clock on the Z axis.

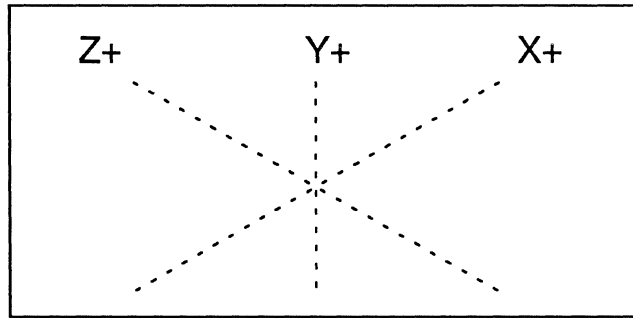

Figure 24-25. X, Y, and Z axes

To change the grid type to isometric:

- ✓ Execute the **Grid->Type->Isometric** command on the Nothing Selected popup menu (Figure 24-26).

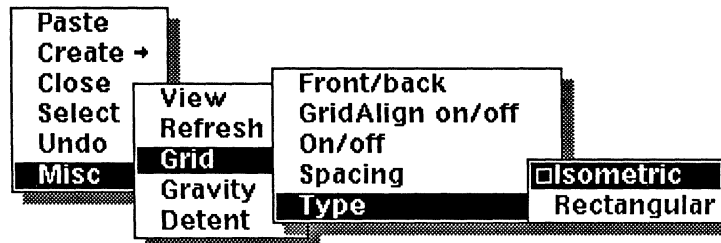

Figure 24-26. Grid Type command

Figure 24-27 shows a frame with the isometric grid displayed, and a simple object created on it.

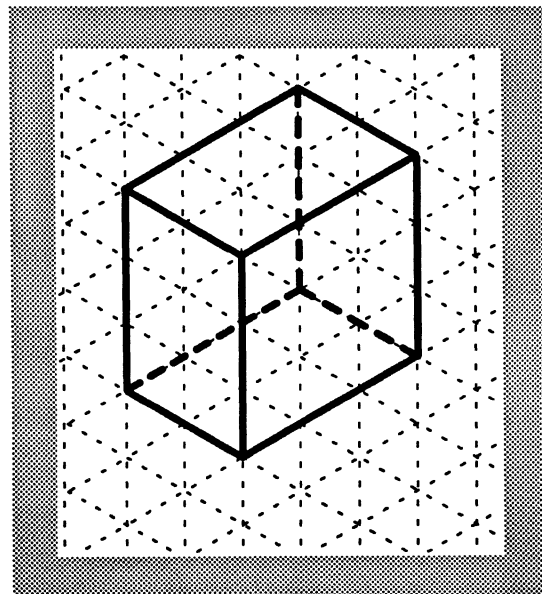

Figure 24-27. Isometric grid shown with "3D" object

## Isometric Grid Spacing

The default spacing for isometric grids is: **.4 inches** between major grid units and **6** minor grid units per major grid unit. When the grid is isometric, there is one **Spacing** command, which lets you change the spacing along the X, Y, and Z axes simultaneously. The spacing of the isometric and rectangular grids is recorded separately.

## Isometric Move Commands

When you change the grid type to isometric, the **Move** submenu is modified to allow movement parallel to any of the X, Y, and Z axes (Figure 24-28).

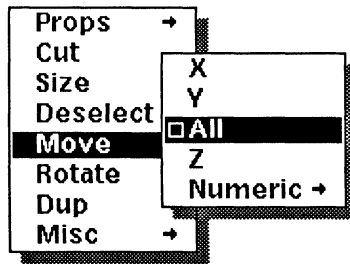

Figure 24-28. Isometric Move commands

The Move Numeric submenu also allows movement parallel to any of the axes. Entering a positive value on the Move Numeric stickup will cause the object to move in a positive direction along the axis; a negative value will cause the object to move in a negative direction.

## Isometric/Orthographic Projections

The rectangular grid defines a single plane: the X-Y plane (said “XY plane,”) defined by the X and Y axes (Figure 24-29).

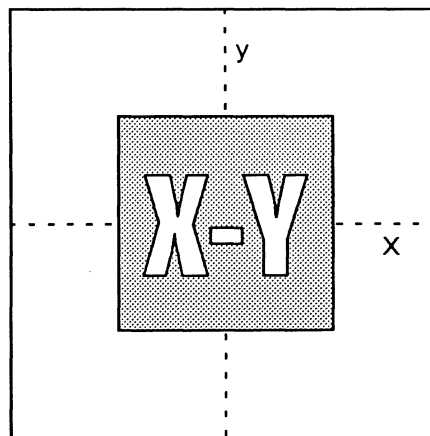

Figure 24-29. Two dimensional X-Y plane

The isometric grid defines three planes: X-Y, Y-Z, and Z-X. These planes are labeled on the sides of the cube in Figure 24-30.

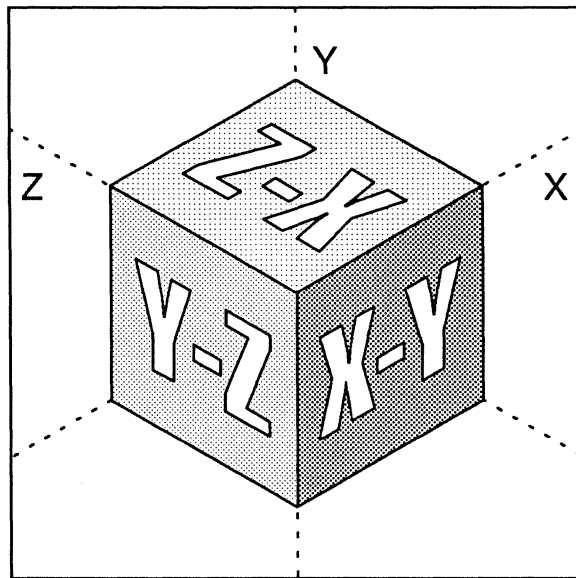

Figure 24-30. Isometric planes

The Projection commands on the Object Selected Convert submenu let you project an object onto one of the isometric planes and back onto the orthographic plane. The diagram in Figure 24-24 was created by projecting objects onto the three isometric planes.

**To project an object onto an isometric plane:**

- ✓ Select the object.
- ✓ Execute the appropriate command on the To Iso(metric) submenu (Figure 24-31).

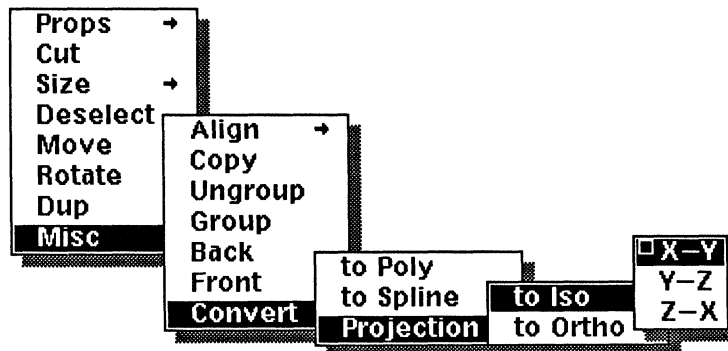

Figure 24-31. Misc Convert Projection to Iso(metric) submenu

- ✓ When the Projection stickup menu appears (Figure 24-32), select **Confirm** or **Don't Ask**.

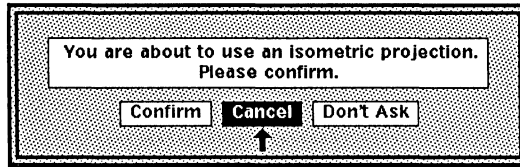

Figure 24-32. Conversion Projection stickup

Figure 24-33 shows the result of projecting an orthographic object onto the isometric X-Y plane. Since all Projection commands are linked to the Move All command, the object is in its animation state.

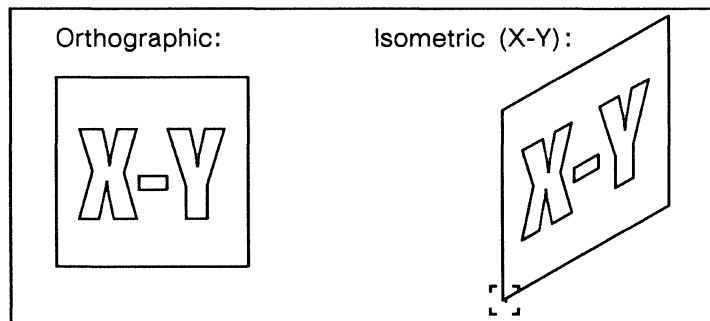

Figure 24-33. Isometric Projection

To project an object back to the orthographic plane *from* the isometric plane, use the **to Ortho**(graphic) submenu (Figure 24-34).



Figure 24-34. Projection to Ortho submenu

**To project an object back onto the orthographic plane:**

- ✓ Select the object.
- ✓ Execute the appropriate command on the **To Ortho**(graphic) submenu.

It is possible to perform any combination of projections on any object. For instance, you can use **to Ortho from Y-Z** on an object which was never projected onto the Y-Z plane. To restore an object's original shape, you must exactly reverse your steps.

## Defaults in Diagramming

The defaults in the diagramming system are divided into three classes.

- Environment defaults affect the diagramming environment and are controlled through the Misc submenu on the Nothing Selected popup menu.
- Object defaults affect the properties of the objects you create and are controlled through the Create Defaults submenu of the Nothing Selected popup menu.
- Popup menu defaults affect the actions you take by default and are automatically changed in response to your actions.

When you create or open a diagram, the popup menus are always set to the system defaults. See *Appendix A* of the *Reference Manual* for an illustration of these menus with the defaults highlighted.

Settings for both the environment and object defaults depend on several factors.

- When you begin an editing session, both the environment and object defaults are set to the system defaults.
- When you open an existing frame, its defaults will be either the defaults you have set or the system defaults if you have made no changes which reset defaults.
- When you create a diagram after you have worked in other diagrams during the editing session, the new diagram will inherit its defaults from the last frame you closed.

## Environment Defaults

The default diagramming environment is:

- **GridAlign** and **Gravity** on
- **Grid** invisible (off), rectangular, and in **Front**
- **Spacing** 2.5 major grid units per inch (or .4 inches between major grid units) and 6 minor grid units per major grid unit
- **Detent** set to **15** degrees

You can change any of the defaults, and the changes become the defaults for the diagram until you change them again. If you close a diagram which you have resized or reoriented a diagram using the **Zoom** and **Center** commands, the new size and orientation will be the default when you reopen the diagram.

Information about the environment is displayed in the status line of the document when the diagram is open, if there is nothing more important to report. It is a good idea to check this line when you open a diagram to make sure the defaults are the ones you want.



# Object Defaults

Object defaults affect the fill, the width, and border pattern associated with the objects you create. All of them can be changed using the Defaults submenu (Figure 24-35).

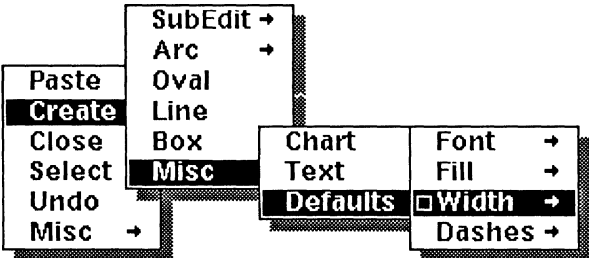

Figure 24-35. Defaults submenu

Three submenus of the Defaults submenu are shown in Figure 24-36.

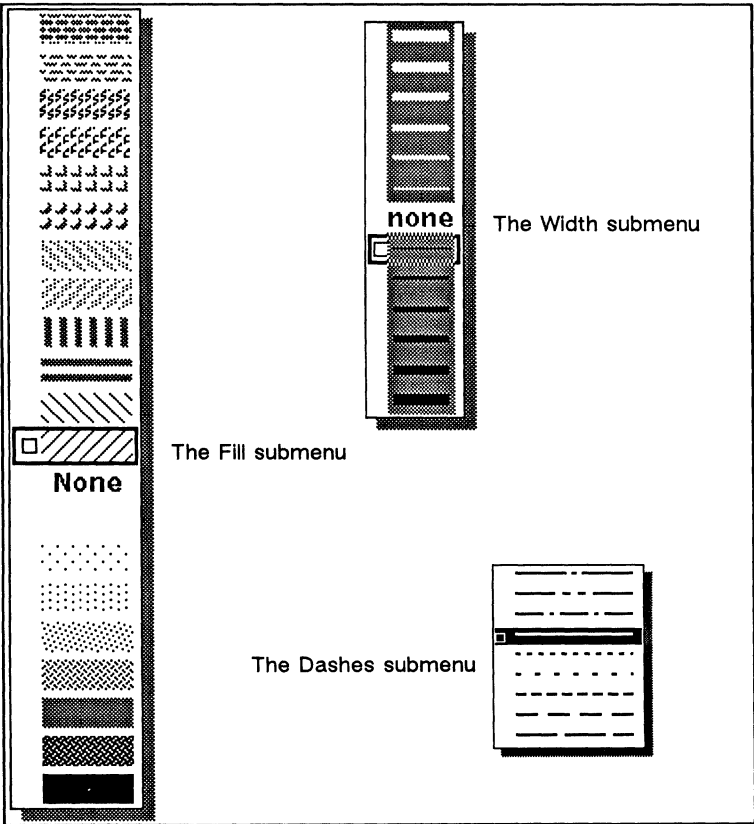
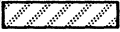

Figure 24-36. Three submenus of the Defaults submenu

## Fill, Width, and Pattern Defaults

The system default setting for **Fill** is  (the striped pattern immediately above **None**). The system default is a solid, black border of the thinnest **Width** (—).

If you set the default line width to **None**, you will be able to create completely invisible objects. To make sure you don't create invisible objects accidentally, the diagramming system will ask you to confirm your action on a stickup (Figure 24-37).

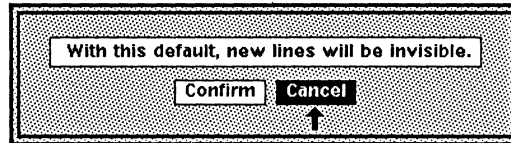

Figure 24-37. Invisible line width stickup

## Popup Defaults

The popup defaults are the commands on the popup menus that get executed if you do not specifically choose a command.

Before you begin diagramming, there is a system default for each popup menu except for the ones that change text strings. As in the rest of the diagramming system, text is a special case.

The system default on a popup menu must be a command that does not have a submenu of its own, which is the reason why **Refresh** is the system default on the Nothing Selected Misc submenu and **Edit** is the default on the Props submenu.

## Dynamic Defaults

As you work in the diagramming system, the default commands on the menus change to help you work efficiently. This is referred to as *dynamic defaulting*.

If the dynamic default is on a submenu and you switch to another branch of the popup menu tree, the default on the submenu is reset to the system default.

Unless the system defaults have been reset, the default on a popup menu is the last command you executed on that menu.

## Predicting Dynamic Defaults

Defaults on the Object Selected popup menu behave differently when the selected object is in animation state than when an object has merely been selected.

In fact, there are really two Object Selected popup menus: the *Selected* popup menu and the *Animation* popup menu.

- You see the *Selected* menu when you hold down the middle button just after selecting an object.
- You see the *Animation* menu after you execute one of the animation commands on the Selected menu, to create or to duplicate an object.

The two menus look exactly alike. The only difference between them is in the way the defaults work. (Please refer to the chapter *Basic Diagramming Concepts* for a list of the animation commands.)

#### *Patterns for Popup Menu Defaults*

The system default, that is, the default when you begin diagramming, is **Deselect** on both the Selected and the Animation popup menus. If you click the middle button after selecting an object, you will deselect it.

A command is called **sticky** if it can become the dynamic default. All of the commands on both the Nothing Selected and the Selected menus are sticky.

Defaults on the *Selected* popup menu are like the defaults on the Nothing Selected popup menu. If you select an object and execute one of these commands, that command will be the default next time you select an object.

Defaults on the *Animation* popup menu differ in two ways:

- There are only two sticky commands, **Dup Repeat** and **Deselect**. If you choose any other command, **Size**, for example, the next time you display the *Animation* popup menu, the default will still be **Deselect**.
- The default on the *Animation* popup is reset to **Deselect** as soon as you deselect the object, no matter what method of deselection you use.

Here are two examples you may want to try. They show the patterns of defaulting, first on the Object Selected menu, then on the Animation menu.

1. Select a line and hold down the middle button. If you haven't done any work yet, the default will be **Deselect**. Choose the **Rotate** command. Execute the default command, **Deselect**. Select something else. When you hold down the middle button, you see the Selected menu, and the default on it is still **Rotate**.

2. Create an oval and hold down the middle button to see the Animation menu. The default on that menu is **Deselect**. Execute the **Move Vertical** command, move the oval, and hold down the middle button again. The default is still **Deselect** because **Move Vertical** is not sticky. Now, execute the **Dup Repeat** command, and move the duplicate. If you hold down the middle button again, you will see that the default on the Animation popup is now **Dup Repeat**. You could make a whole column of ovals, just by clicking the middle button and moving the duplicates.

### *Resetting the Popup Menu Defaults*

There are four ways to reset the popups to the system defaults:

- move the cursor entirely off the popup menu
- close and reopen the frame
- close and reopen the document
- click the left button when an object is in animation state

The first method — moving off the popup menu — is designed specifically as the way to reset the default. It is faster than the second and third methods. The fourth method — clicking the left button — will reset the defaults, but only when you have an object in animation state. For that reason, it is less useful.

When you have an object in animation state, clicking the left button will deselect the object and reset the system defaults on either the Nothing Selected or the Selected popup menu, whichever preceded the Animation popup menu.

## Environment and Popup Defaults in SubEdits

When you open or close a subedit level, environment and popup menu defaults are reset according to specific rules.

### **Environment Defaults**

Each time you open a new subedit level, the environment defaults — **GridAlign**, **Gravity**, **Detent**, **Zoom**, **Shift**, and **Center** — are inherited from the previous level. You can then change the defaults for the new level.

When you close one subedit level, the environment defaults at the level above it are still set to the values they had when you previously passed through it. When you reach the top level, the environment defaults for the entire diagram are reset to the defaults at the top level. If you open a new subedit, it will inherit its defaults from the top level.

Figure 24-38 shows an example of the flow of environment defaults.

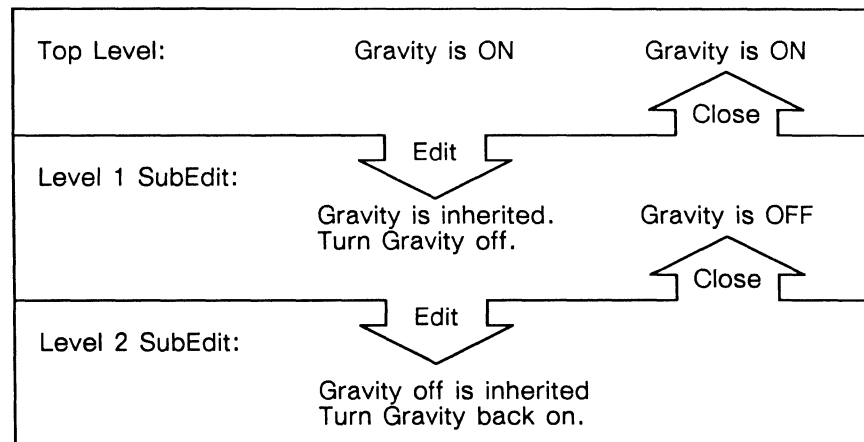

Figure 24-38. Resetting environment defaults across edit levels

This pattern allows you to set up the environment you need most of the time at the top level, then to deviate from this environment when you are working on one particular object, and to return to it as soon as you stop working on the object.

### Popup Menu Defaults in SubEdits

While you are in a subedit level, dynamic defaults are set on the popups just as they are at the top level of a diagram. However, when you close the subedit level, or if you open a new one, the default commands on the popup menus will be reset to the system defaults.

## Adding CAD Drawings to Your Diagrams

If you have a Computer Aided Design (CAD) system, you may be able to add the drawings you create on it to the documents you produce on your desktop. Two basic types of CAD drawings can be incorporated into the diagramming system: plot files and object-editor files.

If the drawing is a plot file, you can use the diagramming system to move, size, and rotate it, and to annotate it with text or other diagramming objects. If the CAD drawing is an object-editor file, you can also edit the individual objects within it.

For information about CAD drawings and how to transmit them to your desktop, see the *Data Transfer* manual.

### The CAD Drawing Icons

When you move a plot file to your desktop, you will usually see it in the upper left corner of the screen. Figure 24-39 shows the plot file icon.

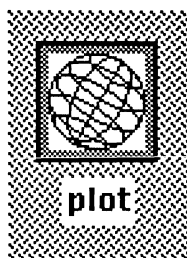

Figure 24-39. Plot icon

An object-editor file icon is the same as the diagramming icon.

### Getting the CAD Drawing into a Document

Once the CAD drawing is on your desktop, you can move it into a document.

**To move the CAD drawing into a document:**

- ✓ Cut or Copy the CAD drawing icon.
- ✓ Open the document and execute one of the **Paste** commands.

If you use the **Paste** command on the Component menu, both a component and an **At Anchor** frame will be created for the drawing. If you use the **Paste** command on the Text menu, a frame will be created for the drawing with its size dependent on the size of the drawing.

Most CAD drawings are too large to fit on an ordinary page. If you paste a large drawing into a document so that a frame is automatically created for it, it will be

automatically sized to fit the page. If the layout of the page is such that the drawing will fit better rotated 90 degrees it will automatically be rotated.

If you **Paste** into a frame, the drawing will be pasted in the diagram. It will have its original size, and it will be in animation state so that you can move it. You can then size the drawing diagonally to make it fit in the diagram.

## Properties of a Plot File CAD Drawing

A plot file CAD drawing is made up of hundreds, often thousands, of line segments. When such a drawing is brought into the diagramming system, all of the line segments are preserved, but the drawing is treated as a single object that cannot be edited.

All of the selection methods work with CAD drawings. However, to select a CAD drawing using pointing and clicking, you must point the mouse cursor at one of the line segments in the drawing. If you point at an open space and click the left button, nothing will happen.

## Manipulating a Plot File CAD Drawing

You cannot edit a plot file CAD drawing, nor can you change its fill, width, or font. The publishing software does not support any special CAD text facility (but you can add your own text using microdocuments, text strings or the fonts supplied in the *Graphics* cabinet).

You can modify the drawing in the following ways:

- annotate it, adding arrows, boxes, or ovals to emphasize parts and masking boxes to block out parts you do not want
- size it, move it, and/or rotate it
- cut or copy it and paste it in another diagram

When you perform an animation command on a plot file CAD drawing, the object is replaced by a box of the same size, to allow rapid movement of the complex object. When the command is completed, the animation box is replaced by the actual object.

## Editing an Object-Editor CAD Drawing

When you transfer an object-editor CAD drawing to your desktop, the objects within it are translated to diagramming objects. You can use all of the diagramming system commands on these objects that you can use on objects you create with the diagramming system.





---

## Chapter 25

# *The Graphics Cabinet*

The *Graphics* cabinet in the *System* cabinet contains commonly used graphic symbols: arrows, borders, flow chart symbols, and many others. When you need an arrow, for example, you do not need to make your own. Instead, you can choose an arrow you like from the *Arrows* folder in the *Graphics* cabinet.

Like other diagrams in the publishing software, the symbols in the *Graphics* cabinet are stored in documents in frames. Figure 25-1 shows the open *Graphics* cabinet.

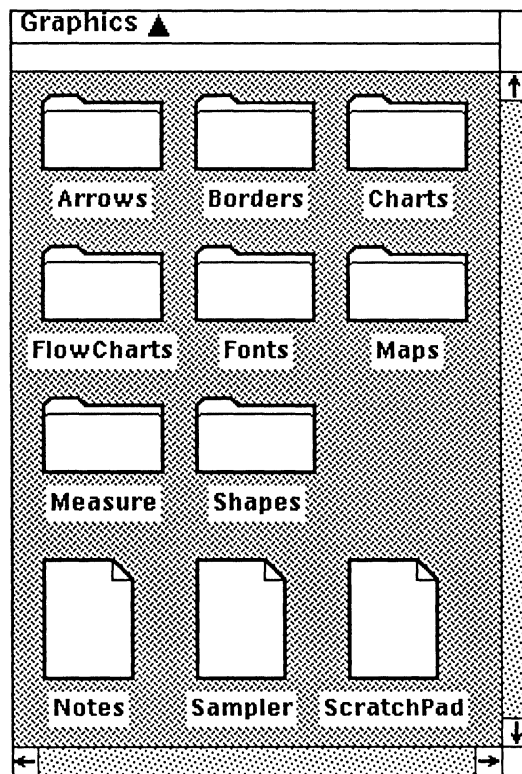

Figure 25-1. *Graphics cabinet*

Because the symbols in the *Graphics* cabinet are diagramming objects, you can adjust them to suit particular applications; you can size or rotate them; you can rotate them to get the angle you need; and you can change the width of the lines and the fill pattern.

Each *Graphics* document contains a frame as large as the document window. The component bar has been turned off so that the window can be as small as possible. In most of the documents, you will see a few lines of text. These are

annotations intended to help you use the *Graphics* symbols without referring to the documentation. The *text is selection-locked*, so that you will not copy it along with the symbols.

In the annotations, *H* stands for horizontal and *V* stands for vertical. The phrase *Edit and Customize* means that the symbol contains two or more parts, each of which can be manipulated separately.

### To put a symbol into your document:

- ✓ Open the document in the *Graphics* cabinet that contains the symbol you want.
- ✓ Select the symbol and **Cut** it.  
*All of the objects in the Graphics cabinet are cutting-locked, so the Cut command will just make a copy.*
- ✓ Open the document you want to put the symbol into, and execute one of the **Paste** commands.

## The Graphics Documents

The next sections discuss the contents of each folder and document in the *Graphics* cabinet. Special techniques for manipulating particular symbols are also described.

### Notes

The *Notes* document contains some brief hints for using the *Graphics* cabinet symbols. When you begin working with *Graphics*, you might want to leave this document open while you experiment.

### Sampler

The *Sampler* document contains one or two symbols from each of the folders except charts. If you are just beginning your exploration of the *Graphics* cabinet, the *Sampler* document is a good place to start.

You can select and use the symbols from the *Sampler* document, but the names of the folders and the dividing lines are selection-locked.

### ScratchPad

The *ScratchPad* document contains an eleven and a half inch square frame with eleven inch rulers at the top and down the left side. The rulers are selection-locked so that they will not get in your way.

Frequently, it is easier to use the *ScratchPad* document to modify symbols before you add them to your documents. If you have enough room in your destination diagram to conveniently work there, you will not need the *ScratchPad*.

If you edit a symbol and want to keep it for future use, put it in a palette on your desktop. See the section *Making Your Own Graphic Symbols* at the end of this chapter for more information.

## Arrows

The *Arrows* folder contains two documents, *Linear* and *Graphic* (Figure 25-2).

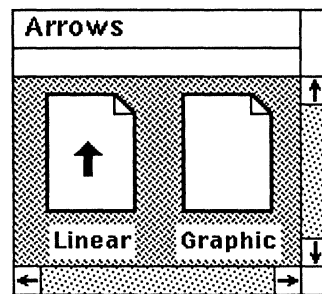

Figure 25-2. Arrows folder

### Linear Arrows

The *Linear* document contains arrows that can be **Rotate Magnified** to change the length of the tail and the angle of the arrow without changing the size of the arrowhead (Figure 25-3).

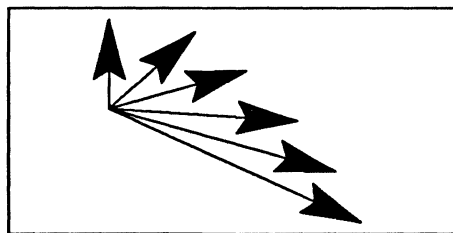

Figure 25-3. Bouquet of linear arrows

#### To use a linear arrow:

- ✓ Select the arrow you want. **Cut** it and **Paste** it in your diagram.
- ✓ Move one end of the arrow (it doesn't matter which) to where you want it.
- ✓ Select the other end and execute **Rotate Magnified**. Move the mouse cursor until that end is where you want it.

The arrows consist of two parts, the arrowhead and the tail. The arrowheads are size-locked. The arrowheads are also gravity-locked, so that the end of the tail (which goes up to the tip of the arrowhead) is the only point on the arrow to which objects will be attracted.

There are nine linear arrowheads available. There are three possible tip angles: 15°, 20°, and 30°, and three possible base angles: 30°, 0°, and -30° (Figure 25-4).

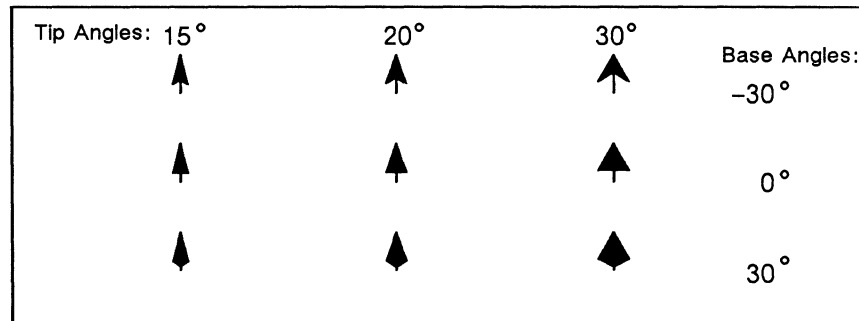

Figure 25-4. The nine linear arrowheads

Each arrowhead is available in three sizes with a straight line tail. There is also an assortment of double-headed arrows, arrows with feathered tails, with oval tails, and with curved tails. All of these are constructed using the arrowhead with the 15° tip and the -30° base and are available in three sizes. You can replace that arrowhead with any of the other linear arrowheads.

#### To attach a fancy tail to an arrowhead:

- ✓ Select the arrow that has the head you want. **Cut** it and **Paste** it in your working area.
- ✓ Select the arrow that has the tail you want. **Cut** it and **Paste** it in your working area.
- ✓ **Edit** the arrow that has the head you like, select the head, and **Cut** it. **Close** the subedit level.
- ✓ **Edit** the arrow that has the tail you like.
- ✓ **Paste** the arrowhead you **Cut**.
- ✓ Select the arrowhead you do not like and **Cut** it.
- ✓ **Move** the head you like into position. If **Gravity** is **on**, the control point at the tip of the arrowhead will snap to the end of the tail. **Close** the subedit level.
- ✓ **Close** the subedit and **Cut** the tail of the first arrow.

You will notice that all of the curved arrows have a counterclockwise orientation. If you want arrows that arch clockwise, use the **Size Reflect Horizontal** command *before* you change the angle. Because the arrowheads are size-locked, they do not reflect. For that reason, they must be pointing straight up when you reflect the arrow (Figure 25-5).

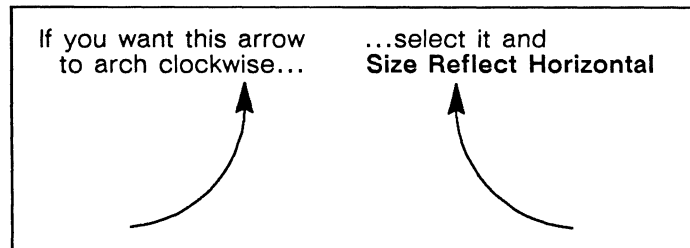

Figure 25-5. Making a clockwise curved arrow

### Points

Points are used to add control and gravity to specific positions on an object. At the top of the *Linear* document there is an assortment of points (Figure 25-6).

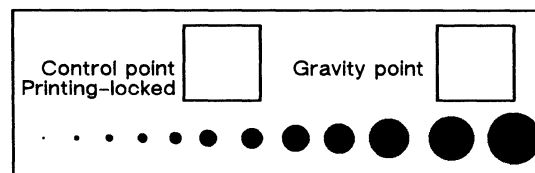

Figure 25-6. Points in the *Linear* document

There is also a point at the tip of each of the arrowheads in *Linear*, and there are points on the flow chart symbols, to provide gravity where lines and arrows should be attached.

When you want to control the location of control or gravity points, cut the points, paste them on the object wherever you want control or gravity, and group them with the object.

### How Points are Constructed

There are two kinds of points in the *Linear* document: line points and oval points.

A **line point** is a line that has been sized down to a point, and has been size- and width-locked. The gravity point in the center of the box and the first five points in the row were made this way, using different line widths.

An **oval point** consists of a line point that is size-, width-, and control-locked and grouped with an oval that is size- and gravity-locked. Because the point is control-locked, the control points on the oval are suppressed, and the whole group acts just like a line point. Oval points have the advantage that they can be larger than line points.

## Graphic Arrows

The *Graphic* document contains an assortment of decorative, or graphic, arrows. Figure 25-7 shows a few of them.

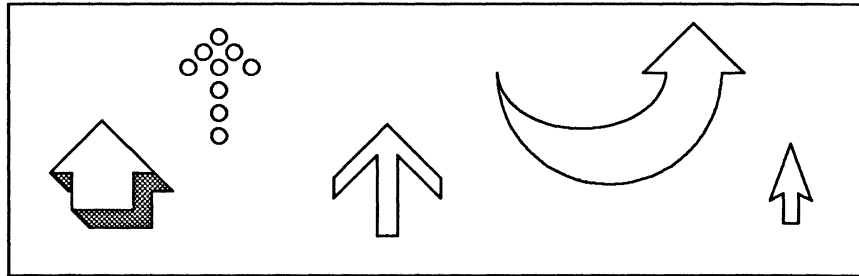

Figure 25-7. Some of the graphic arrows

You can change the fill patterns of the arrows and the widths of the borders, and you can size them diagonally. You can edit the two-tone arrows and change the fill of each part separately. There are many possibilities.

### The Circle Arrow

Towards the upper left corner of the *Graphic* document there is an arrow composed of circles. These circles are aspect-locked: if you size the arrow, the circles will get larger or smaller, but they will *remain* circles (Figure 25-8).

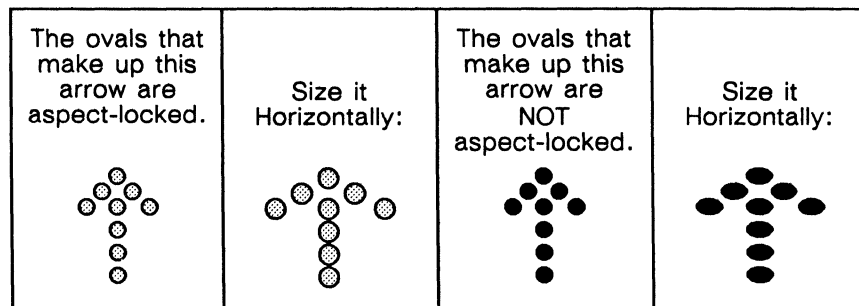

Figure 25-8. Sizing aspect-locked and non-aspect-locked circle arrows

If you want to lengthen the tail of the circle arrow without increasing the size of the circles, use the following procedure.

### To lengthen the tail of the circle arrow without enlarging the circles:

- Edit the arrow.
- Select the tail and **Dup(licate)** it.

- ✓ **Move Vertical.** Overlay one of the circles in the duplicate on top of the bottom circle in the original. (If you have trouble overlaying the circles, try turning GridAlign off.)  
*This procedure is based on the assumption that the arrow is pointing straight up or down. If the arrow is pointing to the left or right, use Move Horizontal.*
- ✓ If the tail still isn't long enough, select one or both of the tails and **Dup** and **Move** again.

### Two-Part Arrows

In the upper right quarter of the document there are thirteen arrows, each consisting of two groups, the head and the tail. The arrows are grouping-locked.

#### To lengthen the tail of a two-part arrow:

- ✓ **Edit** the arrow.
- ✓ Select the tail, and with the cursor near the bottom, **Size** it vertically.

This procedure will also work if you have rotated the arrow so that it is horizontal. Just size the tail horizontally instead of vertically.

The heads of the nine arrows farthest to the right are the same as the heads used for the linear arrows in the *Linear* document. However, the heads of the linear arrows are size-locked, and the heads of the graphic arrows are not.

### Three-Part Arrows

The arrows in the middle section of the *Graphic* document are made from three groups: the head, the tail, and an extension box. Because both the head and the tail have proportions that can get distorted by sizing, we use the extension box to increase the height of these arrows.

In some of the three-part arrows, the extension box has no height to begin with. To select the invisible extension box, edit the arrow, and drag select a small section starting at the top of the tail. Figure 25-9 shows a three-part arrow with an invisible extension box on the left, and a three-part arrow with a visible extension box on the right.

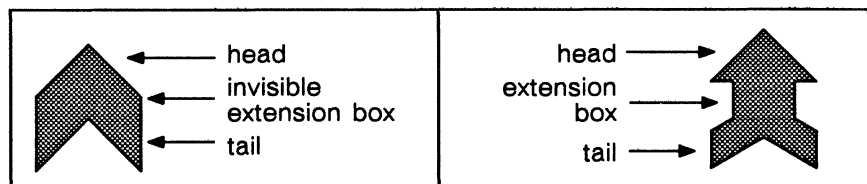

Figure 25-9. Extension boxes, invisible and visible

Suppose, for example, that you wanted to increase the height of a three-part arrow. Figure 25-10 shows an arrow twice: on the left, as it appears in the *Graphics cabinet*; and on the right, as it would appear if you sized the whole arrow vertically. Notice that the proportions of the arrow are distorted.

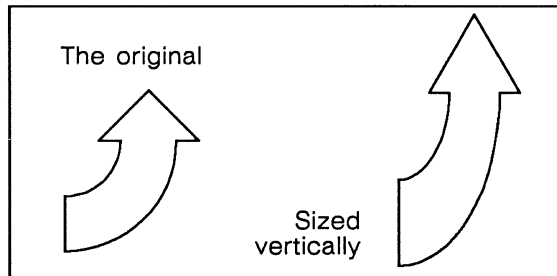

Figure 25-10. Distorting arrow's proportions

Figure 25-11 shows you how you can increase the height of the arrow and preserve the proportions of its top and bottom.

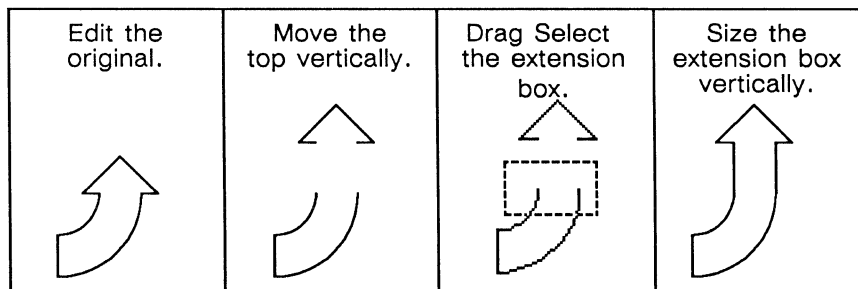

Figure 25-11. Maintaining arrow's proportions

To change the width of a horizontally oriented arrow, use the same procedure, but move and size the pieces horizontally instead of vertically.

This technique also works with other graphic symbols such as the banners, the speech balloons, the brackets, and some of the borders.

### Rotating Two- and Three-Part Arrows

Use the **Rotate** commands to change the angle of the graphic arrows. If you want to lengthen the tail, you should rotate the arrow to a horizontal or vertical position first. Figure 25-12 shows the results of lengthening the tail when the arrow is neither horizontal nor vertical.



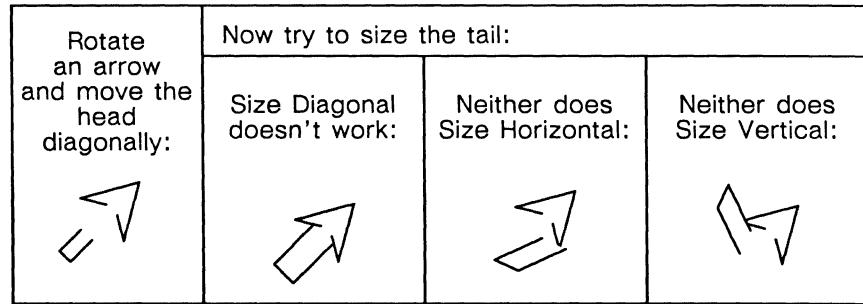

Figure 25-12. Lengthen the tail before you rotate.

### Other Arrows

The two arrows at the top left are polys with no special parts or locks and can be treated as regular polys. The two-tone arrow next to the circle arrow is similar to the two arrows above it in that it has no special locks and it can be sized and rotated as a regular poly. It is made up of several polys grouped together so you can edit the parts to change the individual polys.

The pointing hand can be sized diagonally without distortion.

## Borders

The *Borders* folder contains five documents (Figure 25-13).

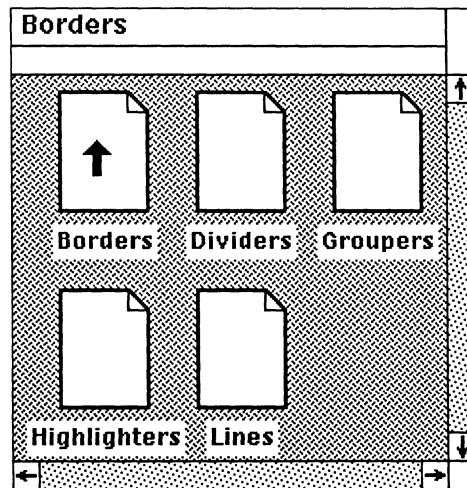

Figure 25-13. Borders folder

### Borders

The *Borders* document contains two sets of borders for your diagrams.

- The first set is made from ovals, diamonds, and squares.
- The borders in the second set are polys.

There is an easy way to make a frame that is just the right size for a border.

**To put a frame containing a border in your document:**

- ✓ Cut the border symbol and **Paste** it in *ScratchPad*.
- ✓ Make the border the size you want.
- ✓ Cut the border and **Paste** it in the component bar of your document.

*A centered component containing an At Anchor frame exactly the size of the border will be created at the component caret position.*

*Repeated Shape Borders*

You can fill the shapes in these borders with patterns and change the width of the lines around the shapes.

Since the ovals or polys that make up the border are aspect-locked, if you size a border much more in one direction than in the other, the spacing between the shapes will be distorted, but the shape of the ovals and polys will be preserved (Figure 25-14).

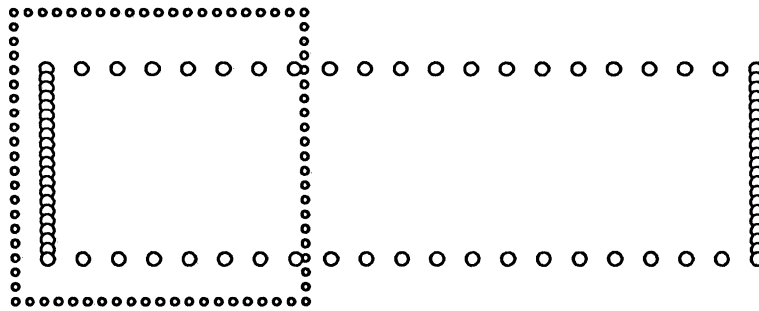

*Figure 25-14. Distorting the repeated shapes borders*

To expand a repeated shape border without distorting it, use the following procedure.

**To expand a repeated shape border:**

- ✓ Edit the border.
- ✓ Drag select the right side and as much of the length of the top and bottom as you need to expand the border.
- ✓ **Dup and Move Horizontal.** Match the pattern of the duplicate with that of the original.
- ✓ Drag select the original right side (but don't include any part of the length of the top or bottom) (Figure 25-15) and **Cut** it.

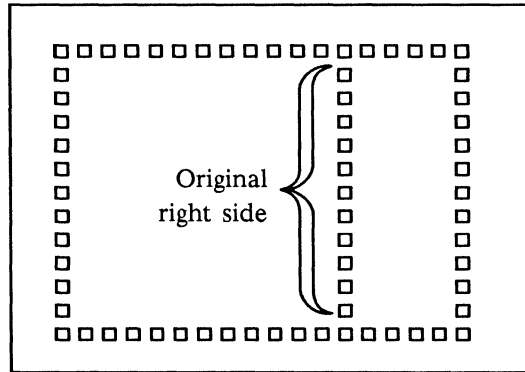

Figure 25-15. Cutting original right side

✓ Close the edit.

### Poly Borders

The poly borders can be filled, and the width of the edges can be changed. Because each border is constructed of eight polys (the four corners and the four sides), you can edit the border and fill the corners with one pattern and the sides with another.

The poly borders can be sized freely, but if you change one dimension more than the other, the curves at the corners and the width of the sides will be distorted (Figure 25-16).

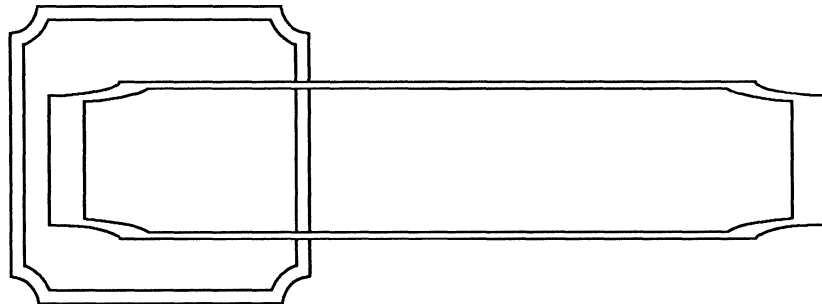

Figure 25-16. Distorting the poly borders

The following procedure will allow you to change one dimension of a poly border, while preserving the curve of the corners and the widths of the sides (Figure 25-17).

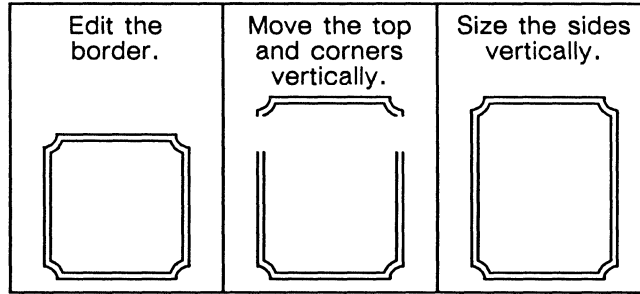

Figure 25-17. Sizing poly borders

You can change the width of a poly border instead of its height by moving and sizing horizontally instead of vertically.

## Dividers

The *Dividers* document contains three fancy dividers that you might want to use between paragraphs of text. All the dividers can be sized diagonally.

If you want to increase the length of the first divider without changing the circles into ovals, you must size each of the side objects separately (Figure 25-18).

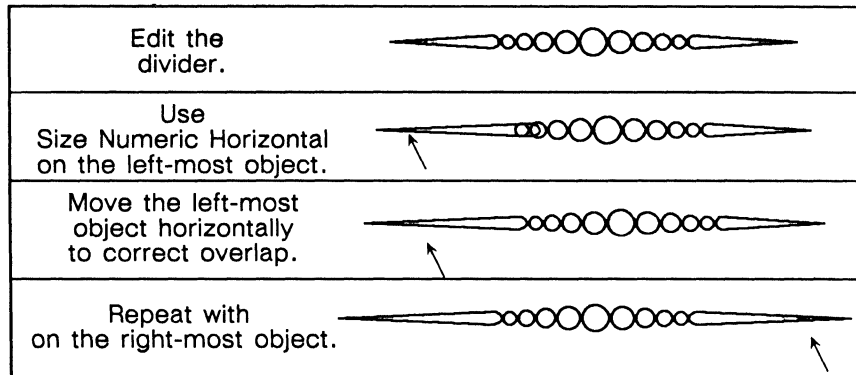

Figure 25-18. Increasing only the length of the first divider

The second and third dividers can be sized horizontally without unattractive distortion. The dividers can be filled with patterns.

## Groupers

In the *Groupers* document there are four brackets: a square bracket, a curly bracket, a parenthesis with pointed ends, and a parenthesis with squared-off ends.

Only the left bracket of each type is included. To make a right bracket, Select the left bracket, and execute the **Size Reflect Horizontal** command.

You can fill the brackets with patterns and change the widths of the edges.

The height of the brackets can be increased, using the same technique that is used for the poly borders. The only exception is the curly bracket. To preserve its

proportions, you will need to move both the top and the bottom and size the two middle pieces (Figure 25-19).

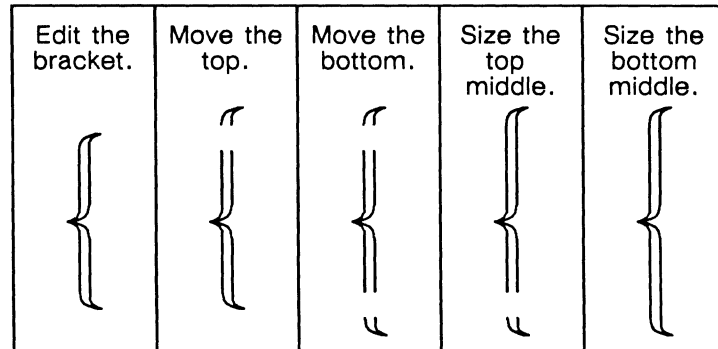

Figure 25-19. Increasing the height of a curly bracket

You can also size the brackets diagonally to increase or decrease the size of the bracket proportionally (the width of the brackets will increase or decrease as well as the height).

## Highlighters

The *Highlighters* document contains eight symbols that emphasize text. There are two banners, a box, two thought balloons, and three bursts.

The text string anchor in these banners is 18 point *Modern Bold* by default, which is too large for the highlighters as they are shown, but appropriate for the large sizes at which they are most often used. You can change the font, and also fill the highlighters or parts of them (Figure 25-20).

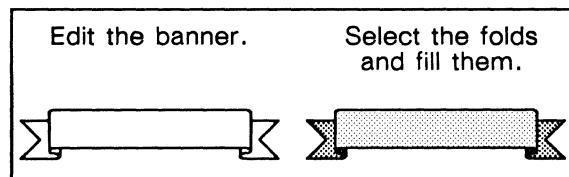

Figure 25-20. Filling parts of a highlighter

It is wise to lock the fill on the parts you change. Otherwise, you will lose the work you have done if you change the fill of the whole object. Size the highlighters diagonally to increase both dimensions, or use the procedure for increasing the height of poly borders to change only one dimension.

## Lines

The *Lines* document contains the elements used to build the repeated shape borders. These elements are useful for creating borders of other shapes and for making patterns.

To use them, drag select the length you need, **Cut**, and **Paste**. Before you deselect the line, be sure to **Group** the segments of it together — reselecting them can be difficult. It is recommended that you size the lines numerically; that way, you can easily create new lines with the same proportions later.

## Charts

The *Charts* folder contains four documents (Figure 25-21).

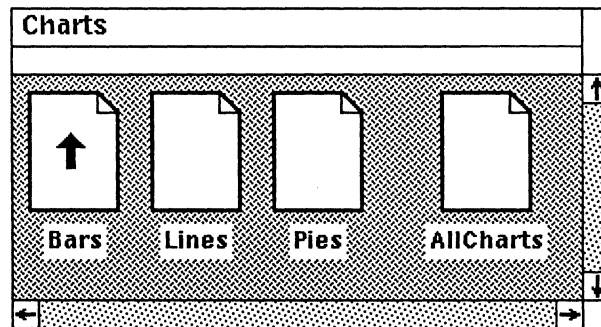

Figure 25-21. *Charts* folder

The documents contain an assortment of basic business chart styles. *Bars* contains horizontal, vertical, and 100% bar charts; *Lines* contains line charts and scatter charts; *Pies* contains pie charts; and *AllCharts* contains all of the charts from the other three documents. For detailed information about creating charts, please consult the chapter *Making Charts*.

## FlowCharts

The *FlowCharts* folder contains one document called *FlowCharts* (Figure 25-22).

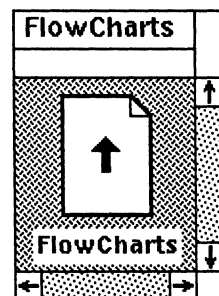

Figure 25-22. *FlowCharts* folder

This document contains all the standard flow chart symbols, plus an assortment of arrows for connecting them. Refer to the *Arrows* section for information on using the arrows.

### Creating a flow chart

The flow chart symbols have extra gravity points wherever arrowheads or lines are most likely to be placed (Figure 25-23). Because the connecting lines and the arrows snap to the gravity points, you can position your arrowheads quickly and accurately.

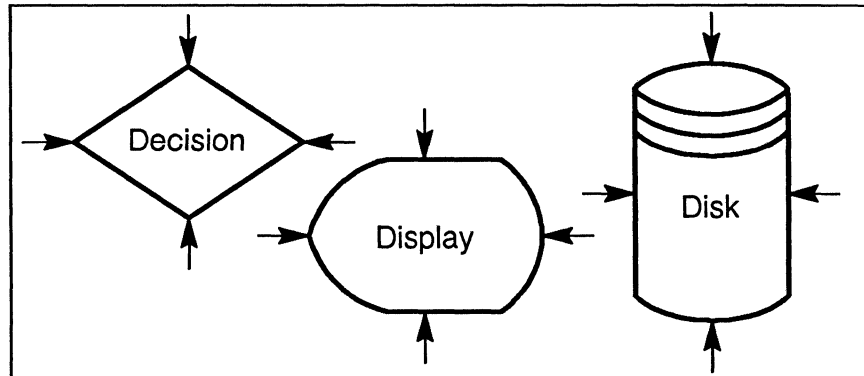

Figure 25-23. Extra gravity points on flow chart symbols

#### To assemble a flow chart:

- ✓ Cut the appropriate flow chart symbols and **Paste** them in a frame.
- ✓ With **Gravity** and **GridAlign on**, arrange the symbols.
- ✓ Turn **GridAlign off**.
- ✓ Connect the symbols with arrows and lines.

#### Adding Text to Flow Chart Symbols

All flow chart symbols contain one centered Modern 12 point text anchor, which you can change to another font if you like. If you want only one line of text in a symbol, select the symbol and type the text.

#### To add two or more lines of text to a flow chart symbol:

- ✓ Edit the symbol.
- ✓ Select the text anchor and enter the lines of text, using the **Return** key to begin new lines.
- ✓ Select all the text and **Group** it.
- ✓ Select the text group and the symbol and **Align Centers**. For the *Disk* symbol, **Align L/R Centers**.
- ✓ Close the subedit.

If you want lines of text that are longer than the symbol, enter the text and then size the symbol and the text together horizontally. The text anchor will stay centered in the symbol. Figure 25-24 shows a sample flow chart.

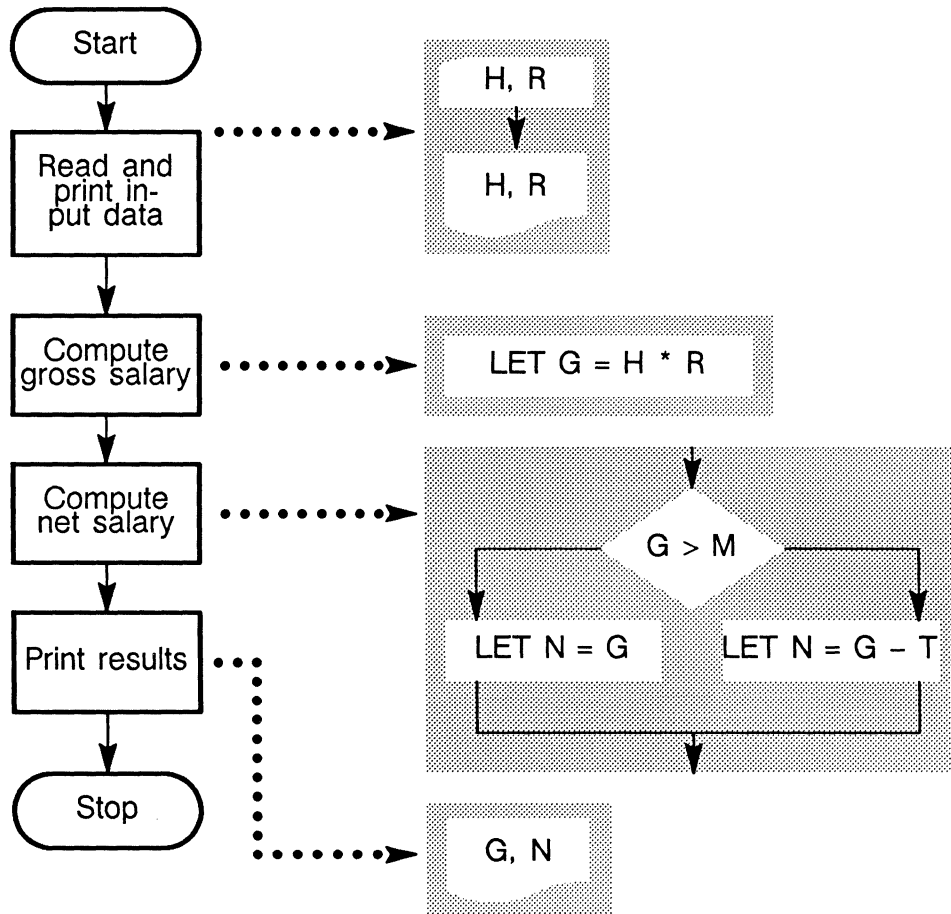

### Payroll Process

Figure 25-24. Sample flow chart



## Fonts

The *Fonts* folder contains four documents, *Line*, *Polygon*, *Serif*, and *SansSerif* (Figure 25-25).

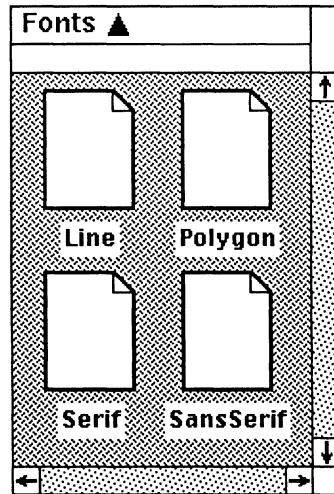

Figure 25-25. *Fonts* folder

Each of these documents contains a complete character set. The *Line* document contains characters made from lines. The *Polygon* document contains characters made from straight-edged polys that can be edited with the **Props Edit** command, and modified with most of the other diagramming commands such as **Size**, **Rotate**, and **Fill**. The *Serif* and *SansSerif* documents contain poly characters which can be changed by all diagramming commands but **Props Edit**. Figure 25-26 shows a sample of each.



Figure 25-26. *Samples of the fonts*

The initial size of each of the characters in the *Fonts* folder is 24-point.

### Construction of the Fonts

Each character in the four sets has important similarities in construction. The character itself is gravity-locked and is surrounded by six invisible control points as an aid for lining up the characters. The control points are grouped together, and then the control points and the character are grouped together and grouping-locked.

The control points describe a rectangle that is as wide as the character plus its inter-character spacing and as high as the font height (the distance between the top of a capital letter in the font to the bottom of a descender). While the width of the rectangles varies, the height is the same for every character in the font. Figure 25-27 shows a few characters with the control points around them made visible.

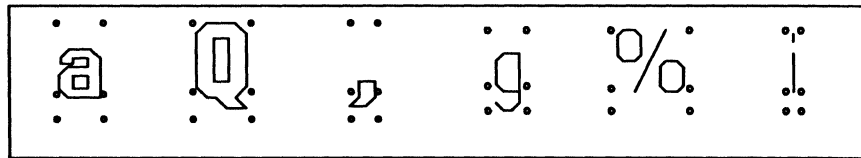

Figure 25-27. Control points on sample characters

The control points at the baseline of each character allow you to base-align characters of different point sizes.

### Using the Fonts

The characters in the *Graphics* fonts are used like any other symbol in the *Graphics* cabinet. However, there are a few tricks to getting them lined up neatly to form words.

#### To assemble a word:

- ✓ Select the characters you want. **Cut** them and **Paste** them in *ScratchPad*.
- ✓ Make sure **GridAlign** is **off** and **Gravity** is **on**.
- ✓ **Move** the first character into position.
- ✓ Select the second character. Point the mouse cursor at its upper left corner and **Move** it next to the first character. Let gravity snap the two control points together.
- ✓ Repeat until all the characters are in place.
- ✓ Select the word. **Cut** it and **Paste** it in your diagram. Before you deselect the word, **Group** the characters.

You can assemble several words at a time this way, too. Each font window contains a word spacing character ( ). Use it between words to guarantee even

spacing. Because the spacing character is printing-locked, you can leave it in your diagram, and it will not show up in the printed version.

### Modifying the Fonts

There are many changes you can make to words once you have assembled them.

- Size them diagonally to create larger or smaller sizes. Since the fonts are all 24 point, you can size them to exact point sizes. For instance, to create a 12 point character, size one of the 24 point characters by half. The Line font looks best at sizes smaller than 24 point, and the Polygon font looks best at larger sizes.
- Size them horizontally to create expanded or condensed fonts.
- Use white line widths, so text will stand out against a dark background.
- Create shadows by duplicating and moving the duplicate just a little, and then changing the fills.
- Rotate them, size them horizontally, and rotate again to create italics. The following table shows the exact amount of sizing and rotation needed to italicize the fonts to any of 18 different angles.

Italic Angle Desired	Rotate Numeric	Size Numeric Vertical	Rotate Numeric	Size Numeric Diagonal
5	45	.91633	-42.5	1.04665
6	45	.90040	-42.0	1.05675
7	45	.88473	-41.5	1.06714
8	45	.86929	-41.0	1.07781
9	45	.85408	-40.5	1.08878
10	45	.83910	-40.0	1.10006
11	45	.82434	-39.5	1.11167
12	45	.80978	-39.0	1.12360
13	45	.79544	-38.5	1.13589
14	45	.78129	-38.0	1.14853
15	45	.76733	-37.5	1.16155
17	45	.73996	-36.5	1.18877
20	45	.70021	-35.0	1.23280
25	45	.63707	-32.5	1.31604
30	45	.57735	-30.0	1.41421
35	45	.52057	-27.5	1.53137
40	45	.46631	-25.0	1.67316
45	45	.41421	-22.5	1.84776

The sample sheet in Figure 25-28 shows the changes described here and a few changes you may want to try out.



Figure 25-29. Samples of fonts

## Maps

The *Maps* folder contains two documents, each containing one map: *US* and *World*. You can use these maps whole, or you can edit them and use only parts, for instance, you can copy New York State from the *US* map, or South America from the *World* map.

## Measure

The three documents in the *Measure* folder (Figure 25-30) are three rulers, in different units: centimeters, inches, and picas.

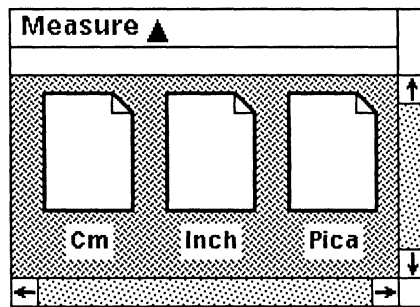

Figure 25-30. Measure folder

The rulers are size-locked and printing-locked. Each ruler is composed of segments; this enables you to select the exact length of ruler you need.

### To use the rulers:

- ✓ **Open** the document.
- ☐☐☐ Point the mouse cursor at the number that is closest to the length of ruler you want and click the **left** button.
- ✓ **Cut** the ruler and **Paste** it in your document.

*Once you have the ruler in your document, use **Rotate Magnified** to change the angle of the ruler and its position at the same time. Because the rulers are size-locked, this will not change their size.*

## Shapes

There are three documents in the *Shapes* folder: *Ellipses*, *Basic*, and *Stars* (Figure 25-31).

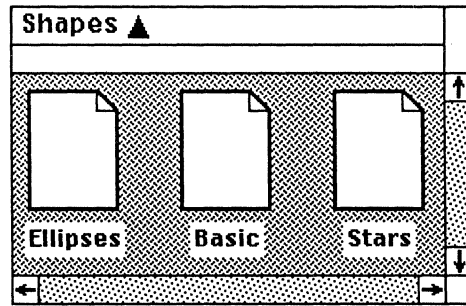

Figure 25-31. Shapes folder

## Ellipses

The *Ellipses* document contains 16 ellipses, each of which represents a circle projected onto a different plane. For instance, the ellipse labeled **25** represents the shape you would see if you held a circular disc at eye level, perpendicular to your line of vision, then tilted it to 25° from vertical (Figure 25-32). The arc in the center of the ellipse is a quarter of the same ellipse; the arc to the right of the ellipse is a semi-ellipse.

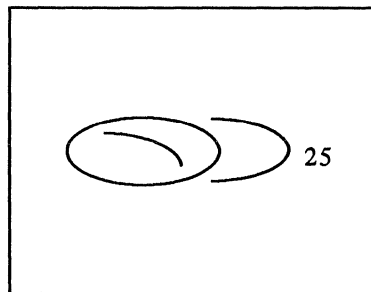

Figure 25-32. 25 degree ellipse

## Basic Shapes

The *Basic* document contains an assortment of shapes, including five-, six-, seven-, and eight-sided polys, triangles, two views of a cube, two round-cornered boxes, playing card suites, and other shapes.

You can edit the cubes, fill the faces with different patterns, and stack them (Figure 25-33).

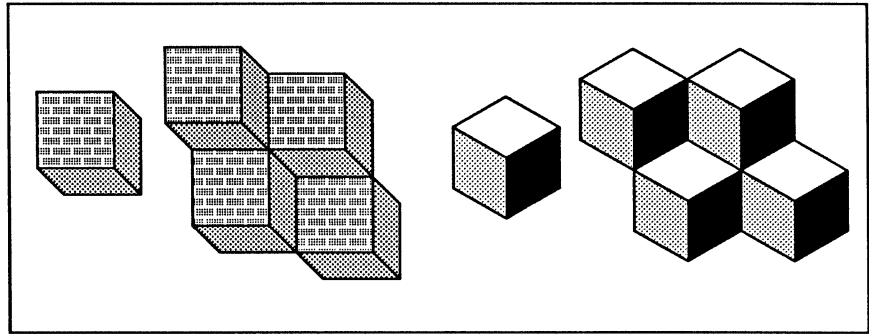

Figure 25-33. Two- and three-toned single and stacked cubes

### Stars

The *Stars* document contains an assortment of stars and asterisks. Figure 25-34 shows a few of the stars available.

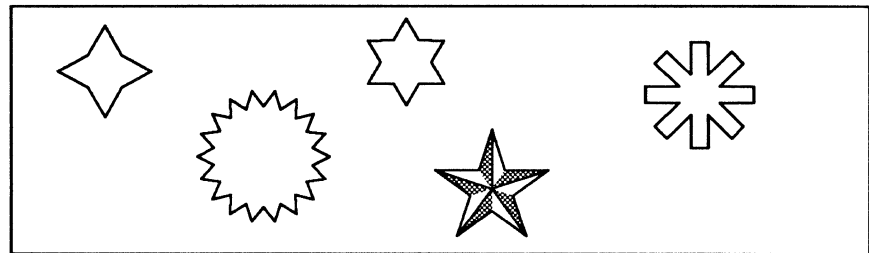

Figure 25-34. Stars and asterisks

You can fill the stars, change their widths, and perform most other diagramming operations on them. You can edit the two-toned star and fill its sections with different patterns. Figure 25-35 shows samples of arrows and shapes.

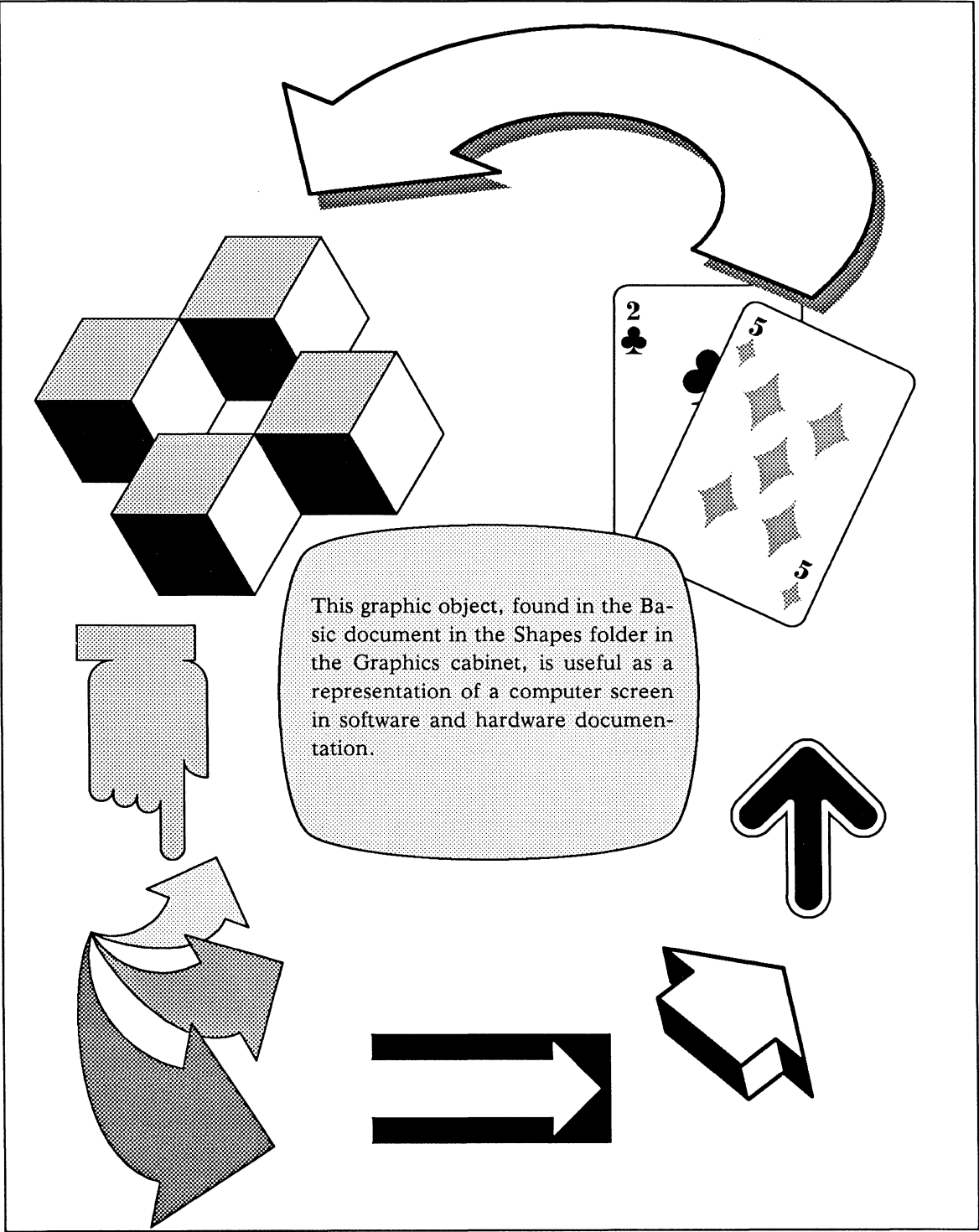

Figure 25-35. Sample of shapes and arrows



## Making Your Own Graphic Symbols

You may want to create your own palettes of symbols that are commonly used in your work. You may also want to copy the symbols in each *Graphics* palette that you use most frequently. Here are some hints for creating new *Graphics* symbols.

- Do not try to create symbols in the frame for which they are intended. Use *ScratchPad*, so that you have room to work.
- Use groups to keep parts of a symbol together. For example, make the head of an arrow one group, and the tail another.
- Use **Lock cutting** on the symbols in the new palette. That way, other users will not be able to damage the palette accidentally.

Ideally, a *Graphics* palette document should be small.

### To minimize the size of a *Graphics* document:

- ✓ Size the objects until they are small but still recognizable, and put the objects in the upper left corner of the frame.
- ✓ **Open** the property sheet for the frame.
- ✓ Make the frame as small as it can be while still showing all of its contents. Select **At Anchor** and make sure the Vertical Alignment is less than the height of the frame. **Close** the Frame property sheet.
- ✓ **Open** the *Component* property sheet.
- ✓ Set all the margins to **0** and **Close** the property sheet.
- ✓ **Open** the Page property sheet for the document.
- ✓ Set all the page margins to **0**.
- ✓ Adjust the height and width of the page to be the same size as the frame. **Close** the Page property sheet.
- ✓ Turn off the component bar using the **Misc Show Components** command, of the Text Location popup menu.
- ✓ **Resize** the window so that only a small rim of black shows around the page.
- ✓ **Move** the window on the desktop to where you would like it to open.
- ✓ Make sure the frame is open.
- ✓ **Save and Close** the document.

Graphics palettes can be printed just like any other document. However, if the objects are close to the page edge, they may not print completely.



---

## Chapter 26

# Images

This chapter describes the things you will be able to do with images using the standard publishing software. If you have purchased the Image Editing option, please refer to the manual you received with it, *The Image Editor*.

Using the standard publishing software, you will be able to paste images into documents, to move them around in a frame, to modify them with diagramming objects, and to print them. You will also be able to create a **screen image** — an exact copy of a part of the screen.

### The Image Icon

Although screen images will be the only kind of image you create, you may have access to images from several other sources. If there is a scanner attached to another workstation at your company, you may receive scanned images. You may also use a filter to bring images created using other software to your desktop.

In the desktop, any of these images will be represented by an image icon (Figure 26-1).



Figure 26-1. Image icon

The image icon is one of the graphic icons. Graphic icons cannot be opened. But they can be cut, pasted, moved, and renamed. If you want to look at the contents of a graphic icon, you will need to paste it into a document.

#### To put an image in a document:

- ✓ Select the image icon and either **Cut** or **Copy** it.
- ✓ **Paste** the image in an open frame, in text, or in the component bar.

*If you paste the image either in text or in the component bar, a frame that is exactly the size of the image will be created for it automatically.*

An image loses its association with the image icon as soon as it is pasted in a document. If you later cut the image, it will be represented by a diagram icon that is named for the document from which it came.

## **Images and Diagramming**

You can combine images with other graphic objects, and you can modify them using diagramming tools.

- You can move the image.
- You can cut or copy it and paste it in another diagram.
- You can add text, arrows, and other diagramming objects.

You cannot change the line width, fill, or font of an image, because it does not have these properties. You will not be able to size or rotate an image unless you have purchased the Monochrome option in addition to the standard publishing software.

All of the diagramming selection methods work on images. However, if you are using the point and click method, you must point at a shaded area of the image, because the white areas are actually transparent. You will be able to see and select other objects through the white areas of an image.

Like a box, an image has control points at its four corners, and gravity points along all four edges. Gravity is stronger at the corners.

## **Moving an Image**

All of the **Move** commands can be executed on an image.

Moving an image is just like moving a box. Select it, put the mouse cursor near the corner that you want to be the control point, execute the **Move** command, and move the mouse. While you are moving the image, you will see only an empty box. The details of the image will be filled in when you deselect it.

## **Storing an Image**

In order to conserve memory and disk space, the Interleaf image editor keeps one copy of an image for each frame in which it appears. If you are using the same image several times in a single frame, the image editor stores the image once, and then the changes you have made to each copy.

Once you put an image into a document, it is automatically compressed when the document is saved. It saves space, therefore, to store images in documents rather than as image icons.

## Creating a Screen Image

Screen images are created using the Screen Capture program. There are two versions of this program: the first is used when you are working in the publishing software; and the second is used to capture a screen display that appears when you are running a different program. Both give you the same capabilities.

## Functions of the Screen Capture Program

Once you have started the Screen Capture program, you will see a large box in the upper left corner of the screen.

The border of the box is two screen dots wide. The outside dot is black and the inside is white, so you will always be able to see the box, even when you are moving it over white areas.

The box is used to define the screen image you want. It can be moved anywhere on the screen, and it can be sized. When it first appears, it is in animation state, ready to be moved.

Once the box is displayed, you have four options. You can:

- move the box on the screen
- change the size of the box
- cancel the Screen Capture program
- capture an image of the part of the screen that is contained in the box

### Moving

If you move the box up against the edge of the screen, its size will change. The edge of the box cannot go beyond the edge of the screen, so it stays fixed and the opposite edge moves in toward it.

### Sizing

The first time that you size the Screen Capture box, you will notice that the change is controlled through the lower right corner. That corner is equivalent to the active control point on a diagramming object, and the upper left is the anchor point. If you size the Screen Capture box through itself, the control point will move to another corner of the box.

### Canceling

If you cancel the Screen Capture program, you will find yourself wherever you were when you first accessed it. No image will have been created.

### Capturing

When you capture, everything within the box (and the rows of dots covered by the border of the box) will be copied and placed in an image icon named *image*.

## The Desktop Interface

You will use the desktop interface to the Screen Capture program when you want to create an image of some part of the Interleaf publishing software. So that you can capture any part of the Interleaf publishing software, from desktop icons to diagramming objects, the screen image capture program is accessed through the interrupt stickup.

### To capture a screen image in the publishing software:

- ✓ Display the interrupt stickup: hold down the CTRL key and type z.
- ✓ Select the **Screen image** option, either by selecting the appropriate box with the mouse, or by typing i.
- ✓ Using the Screen Capture popup menu, **Move** and **Size** the bounding box (Figure 26-2).



Figure 26-2. Screen Capture popup menu

*The first time you see this popup menu, the default on it will be **Size**. If you execute the **Size** command, though, the default will switch to **Move**, allowing you to alternate moving and sizing easily, until the box is exactly the right size, and in exactly the right position.*

- ✓ Execute the **Capture** command on the Screen Image popup menu.

*When you execute the **Capture** command, the image icon you create will be placed on the clipboard. It will be selected so that you can immediately paste it into a document.*

## The Operating System Interface

If you want to capture an image of an operating system command line or an application window, you will use the operating system interface to the Screen Capture program.

### To capture a screen image in another piece of software:

- ✓ Display the image you want to capture.
- ✓ If you are not in the operating system, suspend your application to get there.

- ✓ Type *capture* and, if you like, a name for the image, at a prompt and press RETURN.

*The command and the name of the image should be separated by a space. You do not need to provide an extension: .img will be added automatically to the name you give the image.*

*If you do not type a name for the image, it will be given the default name image. However, if you capture another image and do not type a name for it either, the second image will replace the first one.*

- ✓ Adjust the position and size of the capture box by clicking the **middle** button and moving the mouse.

*In the operating system interface, the middle button switches you between moving and sizing the capture box. When the capture box is first displayed, it is ready to be moved. If you click the middle button, you will be able to size the box, and if you click it again, you will be back to moving it.*

- ✓ If you want to cancel the capture program, click the **right** button.
- ✓ Capture the image within the box by clicking the **left** button.

By default, the image you create will be placed in the directory you were working in when you executed the **capture** command. You can also specify the directory into which it should go.

The command you would type to put the image in your desktop would look like this:

```
 % capture -!desktop filename.img <RETURN>
```

## Modifying a Screen Image

Screen images often contain details you do not want. If you have purchased either the Monochrome or the Grayscale Image Edit option, you will be able to modify screen images using the Picture and Frame editors. If you do not have access to the Image Editor, you will be able to cover unwanted details with diagramming objects and then capture the modified image again.

It is necessary to capture the image a second time because the objects with which you modify the image are not images themselves. Information about them is stored at a very high resolution, so that a modification that looks right on the screen may not print correctly.

Figure 26-3 through Figure 26-7 show how an artist cleaned up the borders and shadows of the Select submenu, of the Diagramming Nothing Selected menu.

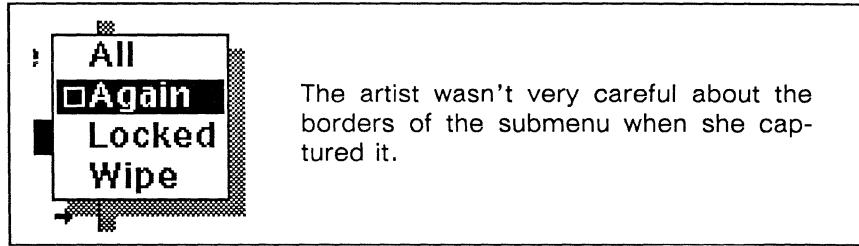

Figure 26-3. Image with unwanted details

After she pasted the screen capture in a document, she turned **Gravity** and **GridAlign** off.

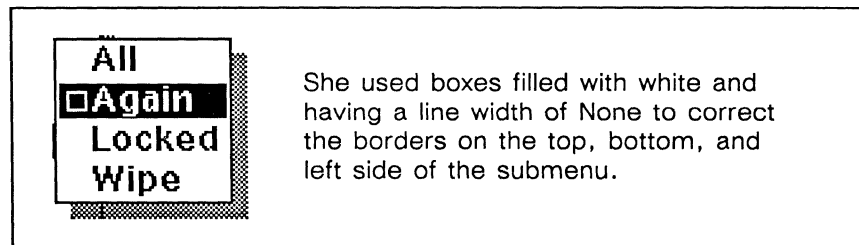

Figure 26-4. Covering unwanted details with masking objects

On the printed page, the borders of this object do not look correct. They do look correct on the screen, though: that is why the artist will capture the object again.

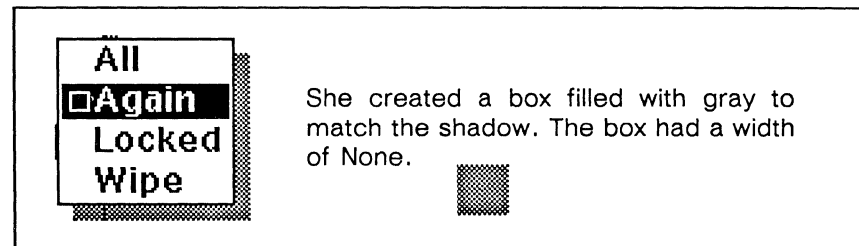

Figure 26-5. Matching image patterns and diagramming fill patterns.

Another reason the artist will recapture the image is that the gray pattern that matches on the screen looks different when printed.

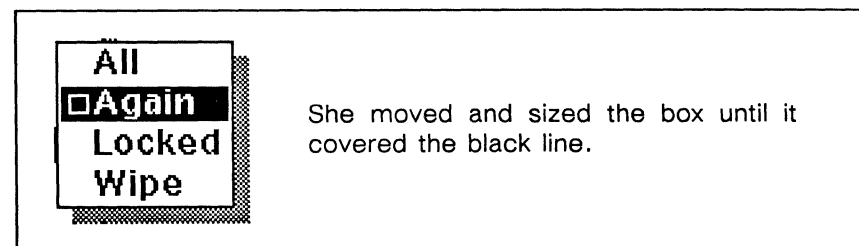

Figure 26-6. Cleaning up image details with diagramming objects.



You may find that you cannot make the gray masking box line up with the gray of the shadow. This problem results from the different ways in which fill patterns are laid out in ordinary diagramming objects and in screen images.

In an ordinary diagramming object, fill patterns are laid out relative to the screen. That makes it possible to overlap objects filled with the same pattern and make them look continuous. However, fill patterns in screen images are laid out relative to the image, not the screen, and the image can be placed anywhere.

If you have trouble lining up the masking object with an image, move the image one or two screen dots, and, by trial and error, you will quickly find a position for the image in which its pattern will line up with the pattern on the screen.

On the screen, the image in Figure 26-7 looks perfect. To make it look perfect on the printer, too, the artist captures that part of the screen again, and then pastes the new screen image in the document.

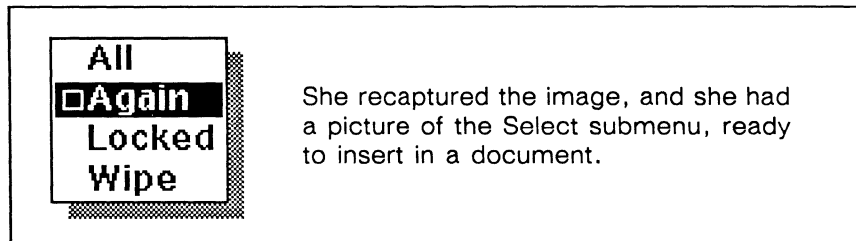

*Figure 26-7. A modified screen image must be recaptured.*



## Chapter 27

# Equations

The Interleaf equation editor allows you to enter and modify mathematical equations using English words to control the placement and font of the characters in the equation. You can create in-line equations, such as  $\sin^2 \theta + \cos^2 \theta = 1$ , and display equations (Figure 27-1).

$$x = \frac{-b \pm \sqrt{b^2 - 4ac}}{2a}$$

Figure 27-1. A display equation

You can combine equations with other graphic objects (Figure 27-2).

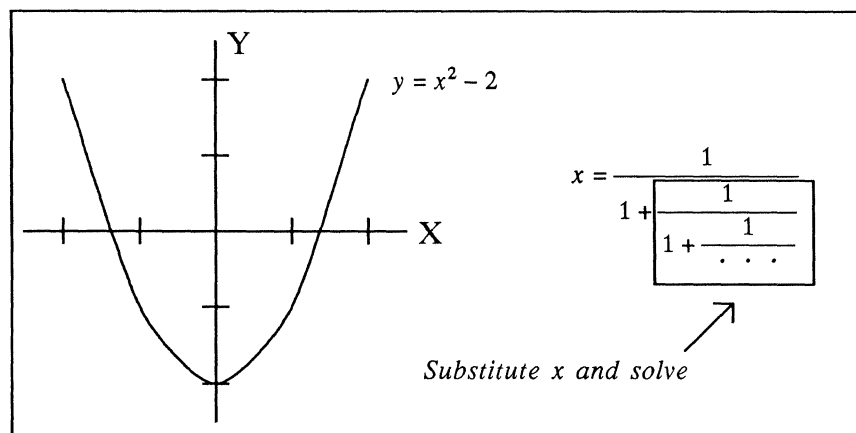

Figure 27-2. Combining equations with other graphic objects

And you can sometimes use equations in disciplines other than mathematics (Figure 27-3).

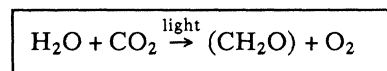

Figure 27-3. A chemical equation

The Interleaf equation editor is compatible with the UNIX **eqn** package. Equations defined using **eqn** and transferred to the publishing software can usually be displayed correctly by the Interleaf equation editor.

## Prerequisites

You will find it much easier to enter equations if you know the control-key sequences for moving the property sheet caret to the next or previous line, backward or forward one character, and to the beginning or end of a line. Please refer to the chapter, *The Keyboard*, in the *Reference Manual*, Volume 1.

## Creating an Equation Object

Equations are created in the diagramming system very much as charts are. If you execute **Create** → **Misc** → **Equation** (Figure 27-4) a default equation that contains sample mathematical text is created (Figure 27-5).

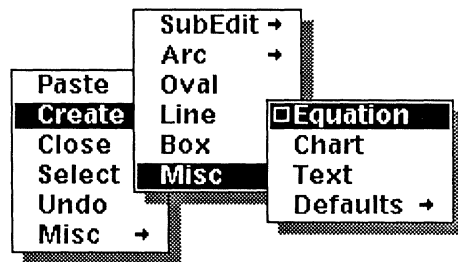

Figure 27-4. Create Misc Equation command

The equation is automatically placed in animation state so that you can move it around in the frame. The diagramming commands **Dup**, **Cut**, **Copy**, **Align**, **Front**, **Back**, **Group**, **Ungroup** and **Props Edit** can all be used on the equation.

$$E = mc^2$$

Figure 27-5. Default equation

## The Equation Edit Sheet

To change the text of the equation, select the equation and execute the **Props Edit** command. The Equation Edit sheet will open in the upper right corner of your screen (Figure 27-6).

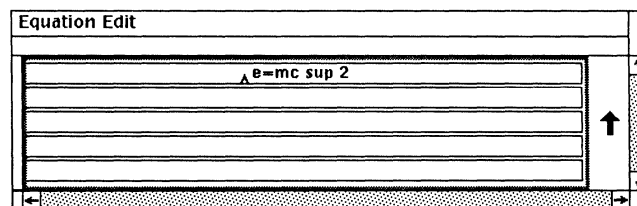

Figure 27-6. Equation Edit sheet

The text in the first line of the property sheet is the language that describes the default equation. Most of it looks like the equation itself. But to create the superscript 2, the author of this equation used the keyword *sup*.

---

The Equation Edit sheet contains a combination of characters and keywords that tell the equation editor how to place the characters.

---

The characters and keywords are typed into the five fields of the edit sheet. Unlike fields in most property sheets, the fields in the Equation Edit sheet scroll so that you can type more text into an Equation sheet than is visible at one time. Each field can hold approximately 120 characters. To see text that is currently not visible, use the control key sequences for moving the property sheet caret.

The best way to move to another field is to use the control key sequences for next line or previous line. These commands confirm the current entry as well as move the cursor to the next field.

## Entering and Editing Equations

The Interleaf equation editor is a tool for setting equations. It does not solve equations or prevent you from entering equations that might not be correct. Instead, it divides the equation into *character strings* and interprets each one either as an instruction for action or as an item to be acted on.

### Character Strings

A character string is a set of characters preceded and followed by a **separator**. The most common separators in the equation editor are spaces, tildes (~), circumflexes (^), curly braces ({}), and double quotation marks (" "). The space is the only separator that does not have any other role in an equation, so it is the most commonly used. Figure 27-7 shows the character strings in sample equation text.

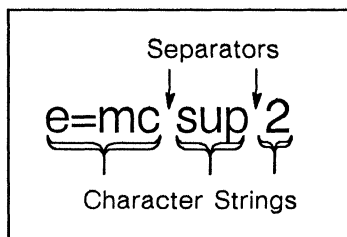

Figure 27-7. Character strings and separators

The equation editor recognizes the following different kinds of character strings:

- **Keywords** provide instructions for manipulating the character strings around them.
- The names of **mathematical symbols** and **Greek letters** are replaced with the correct character.
- The names of **mathematical terms** are displayed in roman.
- The digits, punctuation marks, parentheses, and brackets are displayed in roman.
- Any remaining letters are assumed to be **variables** and are displayed in italic.

Equation Text:	Resulting Equation:
<p>Diagram illustrating the parsing of the equation text "csc x = 1 over {sin x}":</p> <ul style="list-style-type: none"> <li><b>Mathematical Terms:</b> "csc" and "{sin x}"</li> <li><b>Variable:</b> "x"</li> <li><b>Keyword:</b> "over"</li> <li><b>Digit:</b> "1"</li> </ul>	$\csc x = \frac{1}{\sin x}$
<p>Diagram illustrating the parsing of the equation text "int a sup x log a^dx = a sup x":</p> <ul style="list-style-type: none"> <li><b>Mathematical Symbol:</b> "int"</li> <li><b>Mathematical Term:</b> "a", "x", "log a^dx", and "a sup x"</li> <li><b>Keywords:</b> "sup"</li> </ul>	$\int a^x \log a \, dx = a^x$

Figure 27-8. Types of character strings in equation text

## Spaces

Spaces have two purposes in the Equation Edit sheet:

- Spaces are used as separators, to identify character strings.
- Extra spaces can make it easier for you to understand your input.

Extra spaces typed in the Equation Edit sheet are not carried through to the final equation. Wherever you want extra spaces in the final equation, use either the tilde (~) or the circumflex (^). These characters act as separators, just as a space does, but the tilde adds one space to the final equation, and the circumflex adds half a space.

Type:	To create:
$y = ax \text{ sup } 2 + bx + c$	$y = ax^2 + bx + c$
$y^{\wedge} = \wedge ax \text{ sup } 2^{\wedge} + \wedge bx^{\wedge} + \wedge c$	$y = ax^2 + bx + c$
$y - = - ax \text{ sup } 2 - + - bx - + - c$	$y = ax^2 + bx + c$

Figure 27-9. Adding spaces to the final equation

## Some Important Keywords

Keywords affect the character strings before and after them in the equation input. They may change the font or the position, and they may add special symbols.

To be recognized, a keyword must be all lower case, and it must have a separator on either side of it.

### Superscripts and Subscripts

To create superscripts and subscripts, use the keywords *sup* and *sub*. The character string immediately following the keyword will be raised and its point size will be decreased appropriately.

Type:	To create:
x sup 2	$x^2$
4 sub y	$4_y$

Figure 27-10. Creating super- and subscripts

You can use more than one level of superscripts or subscripts. Most of the time, the second keyword will act on the first. The only exception is a subscript followed by a superscript. In this case, the superscript will be printed immediately above the subscript (Figure 27-11).

Type:	To create:
x sub y sub z	$x_{yz}$
x sub i sup 2	$x_i^2$

Figure 27-11. Multi-level super- and subscripts

You can control the way *sup* and *sub* interact by grouping parts of the equation with curly braces.

### Fractions

The keyword for creating fractions is *over*. The character string immediately before the keyword *over* will be placed above the string immediately after the keyword, and a line will be drawn between them.



Type:	To create:
a over b	$\frac{a}{b}$
a + b + c over x - y	$a + b + \frac{c}{x} - y$
a+b+c over x-y	$\frac{a + b + c}{x - y}$

Figure 27-12. Using over to create fractions

In the second example of Figure 27-12, “a + b + c” contains five character strings, therefore only the last one is part of the fraction. In the third example, “a+b+c” is a single character string, therefore all of it is part of the fraction. If you want to put more than one character string above or below the line, you can group those strings together.

## Square Roots

To create a square root symbol, use the *sqrt* keyword. The character string immediately after the keyword will be placed inside the square root symbol.

Type:	To create:
sqrt a	$\sqrt{a}$
x - sqrt a + y	$x - \sqrt{a} + y$
x - sqrt a+y	$x - \sqrt{a+y}$

Figure 27-13. Using sqrt to create square roots

## Grouping Parts of the Equation

Anything between left and right curly braces ({} ) is analyzed first, and the result of that analysis is treated as a single character string.

Type:	To create:
a sup 1 over 2	$\frac{a^1}{2}$
a sup { 1 over 2 }	$a^{\frac{1}{2}}$

Figure 27-14. How braces change the interpretation of text

You can also use braces within braces (Figure 27-15).

Type:	To create:
$x = \{ -b \pm \text{sqrt} \{ b \text{ sup } 2 - 4ac \} \} \text{ over } 2a$	$x = \frac{-b \pm \sqrt{b^2 - 4ac}}{2a}$

Figure 27-15. Multi-level braces

Since extra braces have no negative effect, you can use them freely to clarify the organization of an equation and to guarantee that keywords are interpreted in a specific order.

Braces must be used in pairs. If you have an unmatched curly brace, you will get the error message:

**Error in equation: syntax error**

If you need to put a curly brace in the final equation, you can quote it.

## Quoting Characters

Anything between double quotation marks is placed in the final equation without interpretation. So, for example, if you have a function named "sup" you can quote it to get it to appear in the equation (Figure 27-16).

Type:	To create:
$x = \text{"sup"}(y)$	$x = \textit{sup}(y)$

Figure 27-16. Using quotation marks to prevent interpretation

You will also need to quote digits, mathematical terms, punctuation, parentheses, and brackets in order to change their font.

Like braces, quotation marks must also be used in pairs. If you have an odd number of quotation marks in your equation text, you will get the error message:

**Closing quote missing.**

If you quote a string that is 400 or more characters long, you will get the error message:

**Quoted string too long.**

## Changing the Font

The keywords for changing fonts allow you to change the point size and the weight or slant of character strings in an equation. They affect only the character string immediately following them, so if you want to change the font of a whole equation, you will need to enclose it in curly braces.

## Changing the Point Size

To change the point size of a character string, enter the keyword *size* and the point size you want before the character string.

Type:	To create:
size 14 x = a over b	$x = \frac{a}{b}$
size 14 { x = sqrt 3}	$x = \sqrt{3}$

Figure 27-17. Changing the point size of an equation

If you request a point size that is not available in the current typeface, the equation editor will substitute the closest existing size.

## Changing the Weight and Slant of the Font

Use the keywords *bold*, *italic*, and *roman* to change the weight or slant of a character string.

Type:	To create:
bold x = a + b	$x = a + b$
bold {x = a + b}	$x = a + b$

Figure 27-18. Changing the weight of the typeface

To change the weight of characters or character strings that would normally appear in roman — digits, mathematical terms, punctuation, parentheses and brackets — you must quote them. Special characters, for example the ones in Figure 27-23, cannot be made bold.

Type:	To create:
bold {2a + 3c}	$2a + 3c$
bold {"2" a + "3" c}	$2a + 3c$

Figure 27-19. Quote digits to make them appear in bold

The equation editor defines the **eqn** keyword *fat* to be a synonym for *bold* so that **eqn** text you bring into the publishing software will be displayed appropriately.

## Large Brackets: left and right

To create brackets, braces, and parentheses large enough to contain fractions use the *left* and *right* keywords.

The following characters can be used with *left* and *right*: () [] {} | \ / < >.

Figure 27-20 shows some examples of *left* and *right*.

Type:	To create:
left [ a over b right ]	$\left[ \frac{a}{b} \right]$
size 14 x left ( a = b over c right )	$x \left( a + \frac{b}{c} \right)$

Figure 27-20 Using *left* and *right* to create large brackets

### To create large brackets around a fraction:

- ☐ Type the keyword **left** and then the character that goes on the left side of the fraction: **left [**
- ✓ Type the body of the fraction: **a over b**
- ☐ Type the keyword **right** and then the character that goes on the right side of the fraction: **right ]**

The characters on the left and right side of the fraction do not have to be the same kind. They also do not have to be facing the usual direction. A right brace, for example, can appear to the left of a fraction.

## Creating Vertical Stacks

To create vertical stacks of character strings use the keywords *pile* and *above*. Use the word *pile* to indicate that you want to start a stack. Enclose everything that will be part of the stack with curly braces and separate elements of the stack with the keyword *above*.

The elements of the stack will be centered one above the other. If you want the elements to be aligned on their left edges, use the keyword *lpile* instead of *pile*. If you want the elements to be right aligned, use the keyword *rpile*. The keyword *cpile* also creates a stack in which the elements are centered, but there will be more space between the elements.

Figure 27-21 shows some vertical stacks.

Type:	To create:
left [ pile {a above b above c} right ]	$\begin{bmatrix} a \\ b \\ c \end{bmatrix}$
left ( lpile {10 above 3 above 214} rpile {7 above 181 above 95} right )	$\begin{pmatrix} 10 & 7 \\ 3 & 181 \\ 214 & 95 \end{pmatrix}$

Figure 27-21 Using pile and above to create vertical stacks

## Mathematical Terms

The equation editor recognizes certain character strings as being mathematical terms. If you type one of these in the Equation Edit sheet, it will appear in the final equation in roman instead of in italic.

acos	csc	max
acsc	det	min
and	exp	mod
arc	for	sec
arg	hom	sin
asec	if	sinh
asin	ker	tan
atan	lim	tanh
cos	ln	Re
cosh	log	Im
coth		

Figure 27-22. Table of mathematical terms

## Special Characters

Most of the mathematical characters have been assigned names or codes that are easy to remember. To put the character in your equation, you type the name or code in the Equation Edit sheet. For example, to put  $\approx$  in your equation, you would type **approx** in the edit sheet. To get  $\pm$ , you would type **+-**.

The table in Figure 27-23 lists some of the most commonly used characters and the name or code you would use to produce that character.

Code	Character	Code	Character	Code	Character
>=	$\geq$	times	$\times$	member	$\in$
<=	$\leq$	del	$\nabla$	nomem	$\notin$
==	$\equiv$	grad	$\nabla$	cup	$\cup$
!=	$\neq$	nabla	$\nabla$	cap	$\cap$
+-	$\pm$	ciplus	$\oplus$	subset	$\subset$
-+	$\mp$	citimes	$\otimes$	supset	$\supset$
->	$\rightarrow$	wig	$\sim$	!subset	$\not\subset$
<-	$\leftarrow$	-wig	$\approx$	!supset	$\not\supset$
<<	$\ll$	orsign	$\vee$	sum	$\Sigma$
>>	$\gg$	andsign	$\wedge$		
...	$\dots$	oppA	$\forall$	int	$\int$
,...,	$, \dots,$	oppE	$\exists$		
<->	$\leftrightarrow$	langle	$\langle$	prod	$\prod$
<=>	$\Leftrightarrow$	rangle	$\rangle$		
->	$\mapsto$	ppd	$\perp$	union	$\cup$
	$\parallel$	ang	$\angle$		
inf	$\infty$	thf	$\therefore$	inter	$\cap$
partial	$\partial$	degree	$\circ$		
prime	$'$	circle	$\circ$	oint	$\oint$
approx	$\approx$	bullet	$\bullet$		
nothing		prop	$\propto$		
cdot	$\cdot$	empty	$\emptyset$		

Figure 27-23. Entering special characters

For a complete list of the special characters that are available, please refer to *Math Notes*, in the *Reference* folder, in the *Documentation* drawer.

Three of the special character codes act as separators — they will be interpreted correctly even if you do not put spaces on either side. The three codes are “<=” ( $\leq$ ), “>=” ( $\geq$ ), and “->” ( $\rightarrow$ ).

## Summations: from and to

The keywords *from* and *to* allow you to put character strings directly above or below another string. For example, they are used to display summations, integrals, and limits.

The keyword *from* takes the character string that follows it, decreases its point size and positions the string under the character string that preceded the keyword. The keyword *to* has the same effect, except that it puts the string following it *above* the preceding character string.

Type:	To create:
sum from i=0 to {i= inf} x sub i	$\sum_{i=0}^{i=\infty} x_i$
lim from {n -> inf} x sub n = 0	$\lim_{n \rightarrow \infty} x_n = 0$

Figure 27-24. Using *from* and *to*

If you want to use both *from* and *to* on the same initial keyword, *from* must precede *to*.

## Integrals

Integrals can be created using either *sup* and *sub* or *from* and *to*.

Type:	To create:
int sub 0 sup z sin x dx	$\int_0^z \sin x dx$
int from 0 to inf sin x dx	$\int_0^{\infty} \sin x dx$
oint sub pi sin x dx	$\oint_{\pi} \sin x dx$

Figure 27-25. Creating integrals

## Greek Letters

To put a Greek letter in an equation, type the name of the letter, entirely in the case of the letter you want. If you type the name of the letter with any mix of upper and lower case, it will be treated as a word (Figure 27-26).

If you type:	OMEGA	omega	Omega
You will see:	$\Omega$	$\omega$	<i>Omega</i>

Figure 27-26. Controlling the case of Greek letters

The following table lists the Greek letters preceded by the words you would type to put them in an equation.

ALPHA	A	RHO	P	iota	ι
BETA	B	SIGMA	Σ	kappa	κ
GAMMA	Γ	TAU	T	lambda	λ
DELTA	Δ	UPSILON	Υ	mu	μ
EPSILON	E	PHI	Φ	nu	ν
ZETA	Z	CHI	Χ	xi	ξ
ETA	H	PSI	Ψ	omicron	ο
THETA	Θ	OMEGA	Ω	pi	π
IOTA	I	alpha	α	rho	ρ
KAPPA	K	beta	β	sigma	σ
LAMBDA	Λ	gamma	γ	tau	τ
MU	M	delta	δ	upsilon	υ
NU	N	epsilon	ε	phi	φ
XI	Ξ	zeta	ζ	chi	χ
OMICRON	O	eta	η	psi	ψ
PI	Π	theta	θ	omega	ω

Figure 27-27. Entering Greek letters

Variations of the basic Greek set are available. To find the names of the variations, please refer to *Math Notes* in the *Reference* folder of the *Documentation* drawer on your desktop.

## Diacritical Marks

The keywords for creating diacritical marks affect the character strings immediately preceding them. Figure 27-28 lists the keywords and shows the marks that each one produces.

Type:	To create:	Type:	To create:
a dot	$\acute{a}$	a vec	$\vec{a}$
a dotdot	$\ddot{a}$	a dyad	$\overset{\circ}{a}$
a hat	$\hat{a}$	a bar	$\bar{a}$
a tilde	$\tilde{a}$	a under	$\underline{a}$

Figure 27-28. Keywords for creating diacritical marks

Type:	To create:
a+b+c bar	$\overline{a+b+c}$
AB hat	$\hat{AB}$

Figure 27-29. Diacritical marks centered over character strings



## Defining Abbreviations

The *define* keyword allows you to define an abbreviation for a complicated expression that appears several times in a single equation. The definition must precede any use of the abbreviation. Abbreviations affect only the equations in which they appear.

**To define an abbreviation for a complicated expression:**

- Type the keyword *define*.
- Type the character string you will use as the abbreviation.
- Between single quotation marks, type the expression that will replace the abbreviation.

Figure 27-30 shows an example of the define command.

Type:	To create:
<pre>define xs 'x sub i sub 1 sup 2' {xs} sup 2 = sqrt xs</pre>	$x_{i_1}^2 = \sqrt{x_{i_1}^2}$

Figure 27-30. Using *define* to define abbreviations

You can use one abbreviation in the definition of another abbreviation, but you cannot include the abbreviation in the definition of itself. If, for example, you enter the text “define x ‘x’ x” in the equation edit sheet, you will see the error message:

**Error in Equation: Define loop**

when you try to apply. The next time you hold down the middle mouse button you will see the Apply popup menu instead of the Close menu.

Because you cannot have an empty equation object in diagramming, you cannot apply your changes if the only text in the Equation Edit sheet is a definition. If you execute the **Apply** command and hold down the middle button again, you will see the Apply popup menu instead of the Close menu.

## Tuning the Appearance of the Equation

### Adjusting the Spacing

The Interleaf equation editor will produce attractive equations, but if you have a special requirement, you can adjust the spacing between the elements of the equation.

To move a character string a tiny bit, either horizontally or vertically, use the keywords *fwd*, *back*, *up*, and *down*. After the keyword enter the number of 1/100th's of an em to move the string. (An em is a space about the width of the "m" character.) The character following the keyword and the number will be moved according to direction. Figure 27-31 shows the use of the *up* keyword.

Type:	To create:
a sup {1 over 2}	$a^{\frac{1}{2}}$
a sup up 50 {1 over 2}	$a^{\frac{1}{2}}$

Figure 27-31. Using *up* to raise a superscript

Diacritical marks cannot be moved with the *fwd*, *back*, *up*, and *down* keywords.

## Setting the Control Point

An equation has one control point, at the left edge of its baseline. You can use the *mark* keyword to move the control point to another place on the baseline. That point will then snap to grid points or gravity points on other objects.

If you edit an equation that contains the mark command, when you apply your change, the marked position will not move. This allows you to maintain the alignment of several equations (Figure 27-32).

Type:	To create:
a + b + c mark = y over z	$a + b + c = \frac{y}{z}$
a mark = y over z - (b + c)	$a = \frac{y}{z} - (b + c)$

Figure 27-32. The control point does not move when the equation is edited.

The marked point also becomes the center of the equation: if you select several equations and execute **Misc →** **Align →** **L/R centers**, the equations will line up along their control points.

The equation editor defines the **eqn** command *lineup* to be a synonym for *mark* so that **eqn** text brought into the publishing software will be correctly formatted.

## Math Hints

Create in-line equations in a large frame, then paste them into text and have the system create an automatically sized frame for you. If you want spaces on either

side of the equation, use the space characters in text instead of centering the equation in a wider frame. The linebreaks will look better.

To create a series of equations that are horizontally aligned, create the first equation, **Dup** it and **Move Horizontal**. Then edit the duplicate equations. No matter what changes you make to the content of the equations, the baselines will continue to be aligned.

The **eqn** keywords *col*, *ccol*, *lcol*, *rcol*, *matrix*, *tdefine*, *ndefine*, *gfont*, *gsize*, and *delim* are not defined in the Interleaf equation editor. If you use one of them, you will see the following error message:

"keyword" is not implemented.

## A Summary of Keywords

Purpose:	Keyword:	Purpose:	Keyword:
adjustments to spacing	<i>fwd</i> <i>back</i> <i>up</i> <i>down</i>	defining abbreviations	<i>define</i> <i>tdefine</i> <i>ndefine</i>
changing the font	<i>size</i> <i>bold</i> <i>fat</i> <i>italic</i> <i>roman</i>	fractions	<i>over</i>
diacritical marks	<i>dot</i> <i>dotdot</i> <i>hat</i> <i>tilde</i> <i>vec</i> <i>dyad</i> <i>bar</i> <i>under</i>	large brackets	<i>left</i> , <i>right</i>
		making vertical stacks	<i>pile</i> <i>lpile</i> <i>rpile</i> <i>cpile</i>
		setting control points	<i>mark</i> , <i>lineup</i>
		square roots	<i>sqrt</i>
		sub- and superscripts	<i>sup</i> , <i>sub</i>

Figure 27-33. Summary of Keywords



---

## Chapter 28

# ***Making Charts***

This chapter explains how to create and modify charts with the Interleaf publishing software. The topics covered are:

- types of data-driven charts you can create with the software
- methods of creating and modifying charts
- organization of properties on the **Data**, and **Style** property sheets

This chapter assumes that you are already using charts in your work. If you would like more information about the relationship between data and the different kinds of charts Interleaf offers, and suggestions on how to portray your data in interesting and useful ways, we recommend two excellent books:

- *The Visual Display of Quantitative Information*  
by Edward R. Tufte (Graphics Press, Box 430,  
Cheshire, Connecticut 06410), 1983
- *Designer's Guide to Creating Charts and Diagrams*  
by Nigel Holmes (Watson Guptill Publications, New York),  
1984

## ***Charts as Part of the Diagramming System***

Charts are created and edited within the diagramming system which is discussed in the *Diagramming* section of this manual. They are treated separately from other diagramming objects because they are edited primarily by means of changes made to property sheets rather than by means of diagramming commands.

In this chapter, the diagramming commands that work with charts are referred to but are not explained. Consult the chapters on the diagramming system for detailed explanations of these commands. Note that:

- when you size a chart, the control point is at the corner of the chart closest to the cursor, and the anchor point is in the opposite corner
- charts cannot be rotated



Since it is part of the diagramming system, a chart is created in a *frame*. In this chapter, there are several brief references to the creation of frames. For a fuller explanation of frames, refer to the *Text-Anchored Frames* chapter in the *Reference Manual*, Volume 1.

## The Types of Charts

Within the Interleaf publishing software, a chart is a data-driven graphic object. On the **Edit Chart Data** sheet, you enter data from which the software *automatically* constructs a chart for you. You can let the software scale the axes or you can scale them yourself. When the software scales the axes, 0 is always one of the points. When you scale the axes, you can bypass 0.

You have much control over how the data look because you choose not only the style of the chart but also such things as the thickness of all the lines and the textures of the chart objects.

We divide data-driven charts into three basic types:

- bar charts 
- line charts 
- pie charts 

Within the bar chart category, there are:





- vertical bar charts 
- horizontal bar charts 
- 100% horizontal bar charts 
- surface charts  and 

Figure 28-1 shows an example of each type of bar chart, using the same data and the same textures for the bars, and a surface chart using negative as well as positive values.

---

In Figure 28-1, Figure 28-2 and Figure 28-3, we give the data for each of the charts. Under each chart you will see a label that contains a code in parentheses. The code refers to the chart in the *Charts* folder in the *Graphics* cabinet that we used as the basis for our chart (for example, *B10* in the labels under the bar charts in Figure 28-1). In several cases, if you want to duplicate the chart you see here, you will need to scale the axes yourself.

---

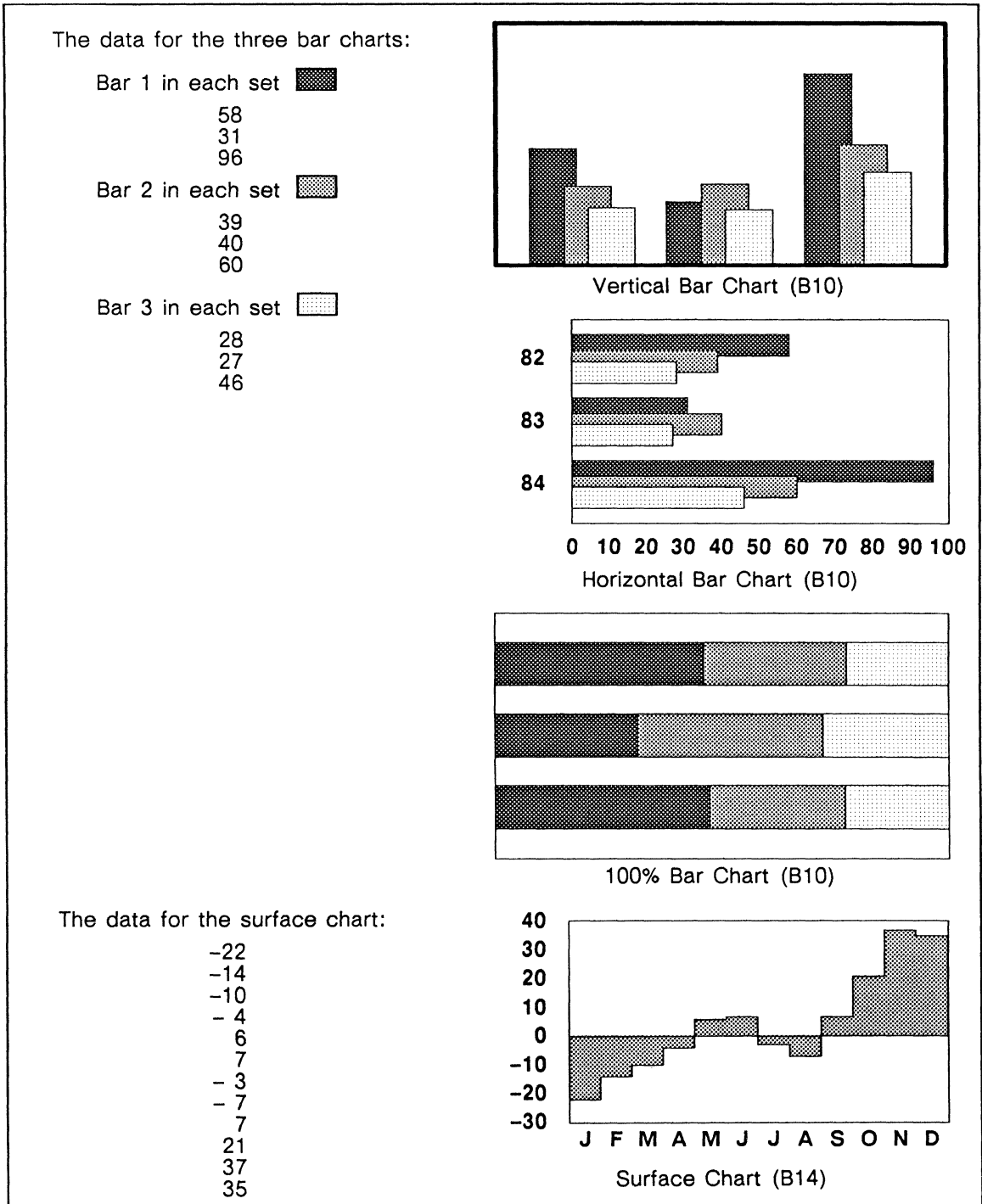

Figure 28-1. Bar and surface charts

The line chart category includes



- standard line charts 
- filled line charts 
- scatter charts 

Figure 28-2 shows examples of these three, using different data for each.

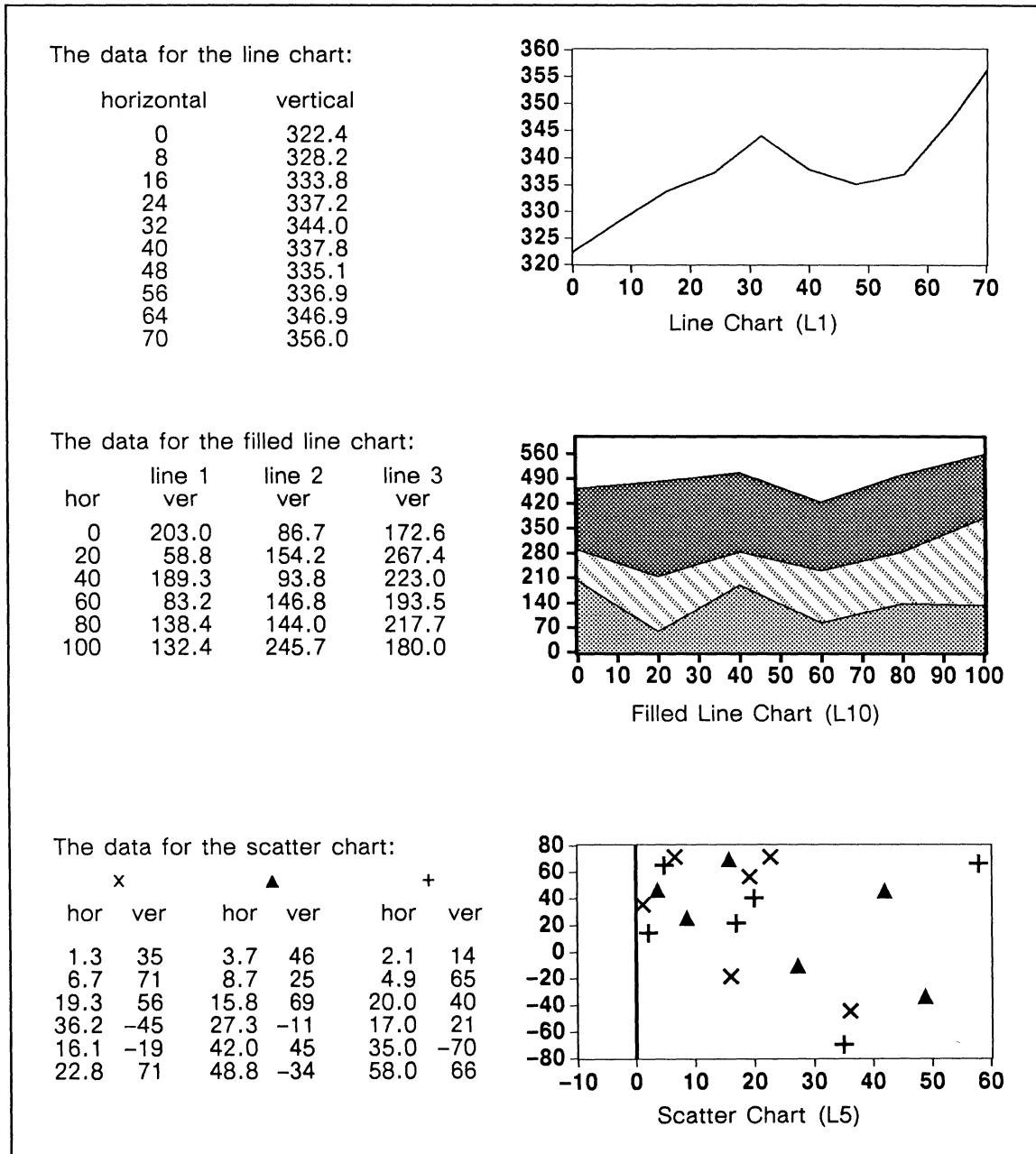

Figure 28-2. Line, filled line, and scatter charts



There is only one kind of pie chart, but a single pie chart can contain more than one pie, and each pie can have one wedge that is exploded. Figure 28-3 shows two pie charts. In the bottom chart, there are three pies, each with a different wedge exploded.

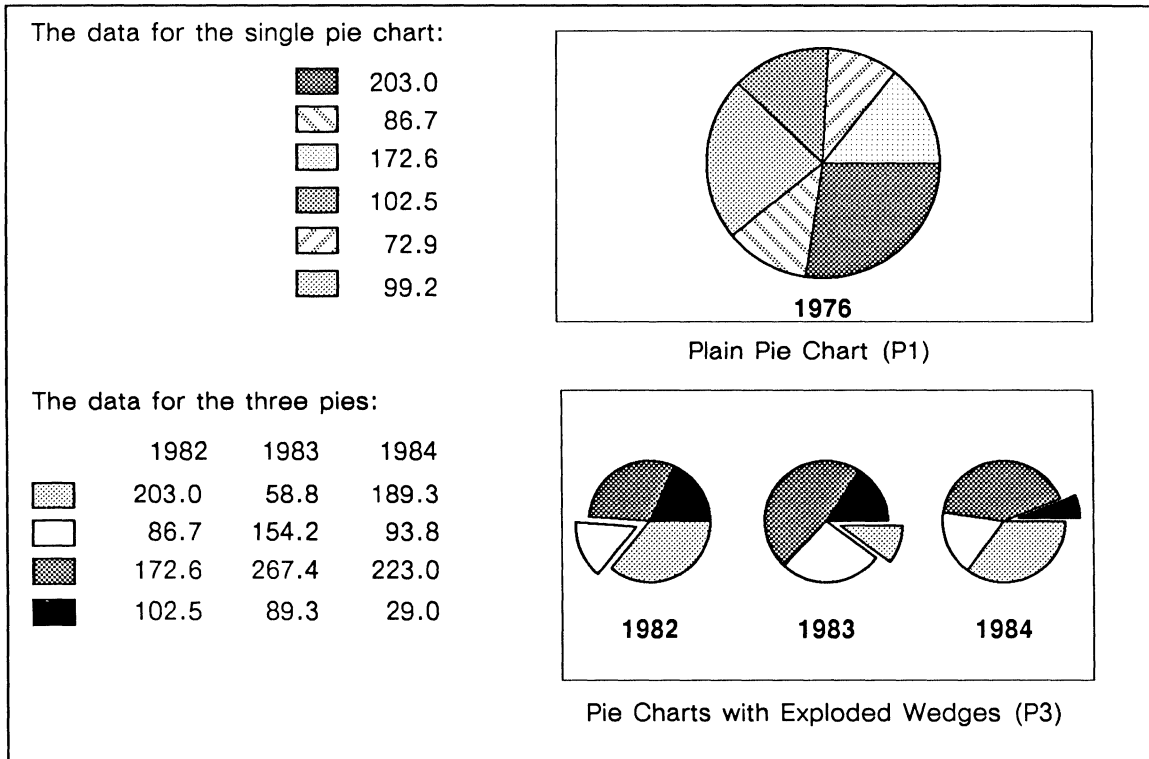

Figure 28-3. Pie charts

## Creating a Chart

There are two basic ways to create a chart.

- You can execute the **Chart** command on the **Create Misc** submenu of the **Diagramming Nothing Selected** popup menu (Figure 28-4).

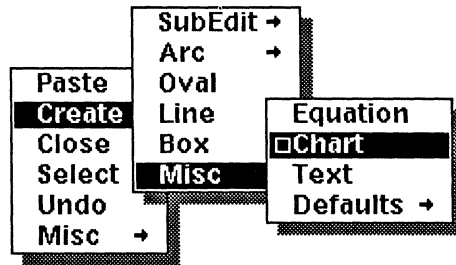

Figure 28-4. Create Misc submenu of the Diagramming Nothing Selected popup menu

- You can copy a chart from somewhere else, usually from one of the documents in the folder named *Charts* in the *Graphics* cabinet on your desktop.

The **Create** → **Misc** → **Chart** command produces a *bar chart*. The default size for this chart is three major default grid units high, and three wide, including the space that is reserved for labels. Since you can edit it, you can use this chart as the basis for any kind of chart, but it is most appropriate if you have data for a bar or pie chart.

If you have other kinds of data or you want to pick a chart to edit that most closely resembles the chart you want to construct, open the *Graphics* cabinet and the *Charts* folder.

In the *Charts* folder, there are four documents. To see the entire range of data-driven charts that Interleaf offers, open *AllCharts*. Each of the other three documents gives you a specific portion of chart types.

- Bars* contains bar charts and surface charts.
- Lines* contains line, filled line, and scatter charts.
- Pies* contains pie charts.

## Using ScratchPad

You can create charts in any document you choose. However, in the *Graphics* cabinet, Interleaf provides a document called *ScratchPad* that consists of an 11.5 by 11.5 inch frame with 11 inch rulers along the top and the left side. Because it has rulers to guide you and plenty of room in which to maneuver various elements, *ScratchPad* is the ideal place to construct a chart and get its margins, text, and legends in the right position.

When you have a chart in *ScratchPad* that pleases you, you can cut it from *ScratchPad* and paste it into your document. The software will create a frame for it that is *exactly* the right size.

The discussion of chart creation that follows assumes that you will create and edit charts in *ScratchPad* and then cut them and paste them into your documents. Most of the process is the same if you create a chart in a document, but before you begin in a document you will have to create a frame in which to put the chart.

---

Since the *ScratchPad* in the *Graphics* cabinet is a template document, the individual user cannot change it. The best thing to do is to make a copy of *ScratchPad*. This copy will belong to you, and you can do what you want in it and then save the changes you make.

---

#### To create a chart in *ScratchPad*:

- ✓ **Open** a copy of *ScratchPad*.
- ✓ **Create a Box** the size you want the entire chart to be, including space for surrounding text and legends.  
*This step and the next will make it possible for you to have all of the charts in a document exactly the same size. If your charts do not have to be the same size, you can skip these two steps.*
- ✓ Inside this box, create another box the size you want the chart itself to be.  
*At this point, do not worry about the placement of the boxes in relation to each other. Later, after you have edited the chart and when you are adding text and diagramming elements, you can position everything more precisely than you can now.*
- ✓ Use the **Chart** command on the Create Misc submenu.
- or ✓ Use the **Cut** command to copy a chart from one of the documents in the *Charts* folder, and **Paste** it into *ScratchPad*.
- ✓ **Size** the chart to the size of the smaller box, and **Deselect**.  
*A chart consists not only of the area in which the data are displayed but also of the margins around this data, so the area with the data in it is usually smaller than the box you sized. In the section on the Edit Chart Style sheet later in this chapter, we discuss how to change the data margins.*

Once you have a chart in *ScratchPad*, you can use the Edit Chart sheets to fashion it into a chart appropriate for the circumstances. When you finish editing the chart and adding text and legends to it in *ScratchPad*, move it to your document.

To move a chart from ScratchPad to a document:

- ✓ Cut the larger box and everything inside it.
- ✓ Close *ScratchPad*.
- ✓ In your document, **Create** an empty component.
- ✓ Use the **Paste** command on the Text Location popup menu (Figure 28-5) to paste everything you cut from *ScratchPad* into the text of your document.

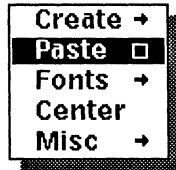

Figure 28-5. Text Location popup menu

*The software creates an At Anchor frame the correct size for the box and pastes everything you cut into this frame.*

- ✓ Select the chart and execute the **Back** command.  
*This puts the chart in back of the smaller box, so that you can select the box.*
- ✓ Select the smaller box and **Cut** it.
- ✓ If you like, **Cut** the outside box, or leave it as a border around the chart.

## The Edit Chart Sheets

There are three **Edit Chart** sheets: the **Data** sheet, the **Style** sheet, and the **Customize** sheet. The **Data** and **Style** sheets, which you will use more often, are described in this chapter.

This section provides an overview of the **Edit Chart** sheets. For detailed information refer to:

- *The Data Sheet* section for a discussion of the **Data** sheet and how to enter information
- *The Style Sheet* section for a discussion of the **Style** sheet and how to alter the way a chart looks
- The chapter *Customizing Charts* for a discussion of the **Customize** sheet and how to have more control over the way a chart looks

### To open the Edit Chart sheets:

- ✓ Select the chart.
- ✓ Execute the **Edit** command on the **Props** submenu of the **Diagramming Object Selected** popup menu (Figure 28-6).

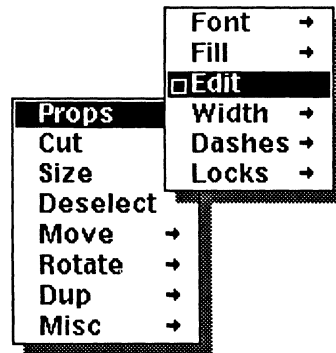

Figure 28-6. *Diagramming Object Selected* popup menu

*One of the Edit Chart sheets appears in a window in the upper right-hand portion of your desktop. The Edit Chart sheets can be very large. To see all of the choices available to you, either **Resize** the window or scroll the sheet.*

## An Overview of the Edit Chart Sheets

On the *Data* sheet, you enter the data for a chart, either by typing them in or by copying them from elsewhere and pasting them into your chart.

On the *Style* sheet, you make choices about the way your chart will look.

If the Style sheet does not provide you with sufficient choices, you can use the options on the *Customize* sheet to hand-tailor some features of your chart.

The Customize sheet is identical for all types of charts.

There are differences among the Data and Style sheets for the various types of charts. For example, some questions on the Data sheets for all types of charts, are identical. However, on the Data sheet for *line charts*, you are asked additional questions about horizontal values that are appropriate to charts of this type but not to bar or pie charts.

Figure 28-7 shows the Data sheets for a *vertical bar chart* and a *line chart*, and Figure 28-8 shows their Style sheets.

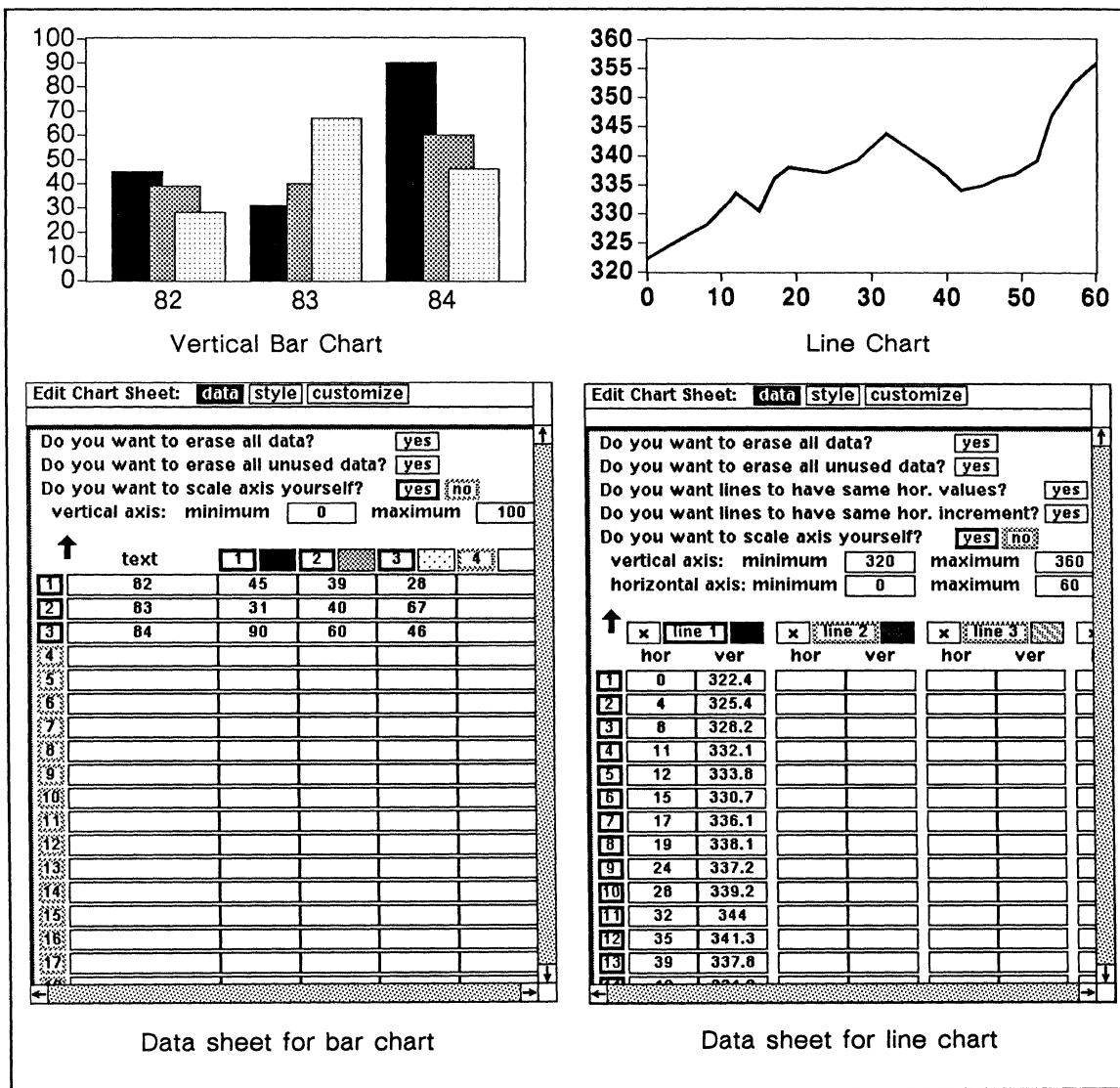

Figure 28-7. A bar chart and a line chart with their Data sheets

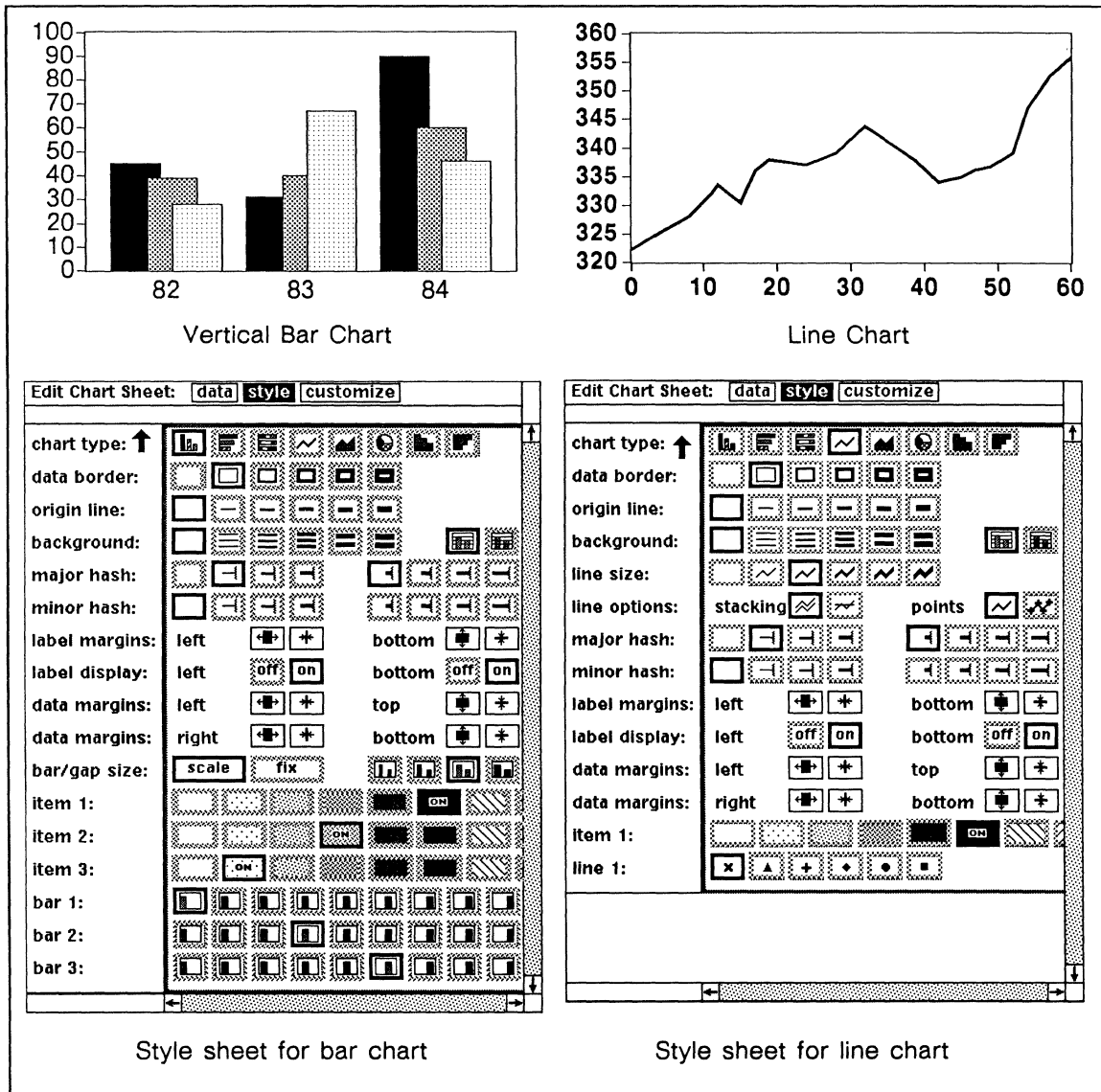

Figure 28-8. A bar chart and a line chart with their Style sheets

## The Data Sheet

Each chart you create represents data visually. The information you enter on the Data sheet determines which type of chart is most suitable and effective.

The Data sheet consists of two parts: the questions at the top and the data fields.

Next to the horizontal, numbered boxes at the top of the data columns are filled boxes. These boxes reflect the texture settings on the *Style* sheet, including the kind of points selected for a line chart (i.e., **x**, **▲**, **+**, **◆**, **●**, or **■**).

## How Changes are made on the Data Sheet

On the Data sheet, most information is entered in the same ways that it is on other property sheets, but there are also a couple of methods for registering changes that are unique to chart-making. In the following list of methods, you will be familiar with typing information and turning boxes on and off, but the other methods may be unfamiliar to you.

- Questions that are followed by a single box containing the word *yes* can be answered affirmatively by pointing the mouse cursor into the box and clicking the left or right mouse button.
- Data can be either typed in or copied from elsewhere and pasted into the Data sheet.
- Other numeric values, such as the values for axes if you choose to scale them yourself, must be typed in.

## Entering Information by Turning Boxes on or off

On the Data sheet, information is often registered by turning boxes *on* or *off*. The numbered boxes above the data columns and to the left of the data rows are examples of this kind of box. Figure 28-9 shows a Data sheet and the resulting chart. On the Data sheet, the entire entry for 82 (row 1) is turned *off* and bar 2 (column 2) is turned *off* for all entries.



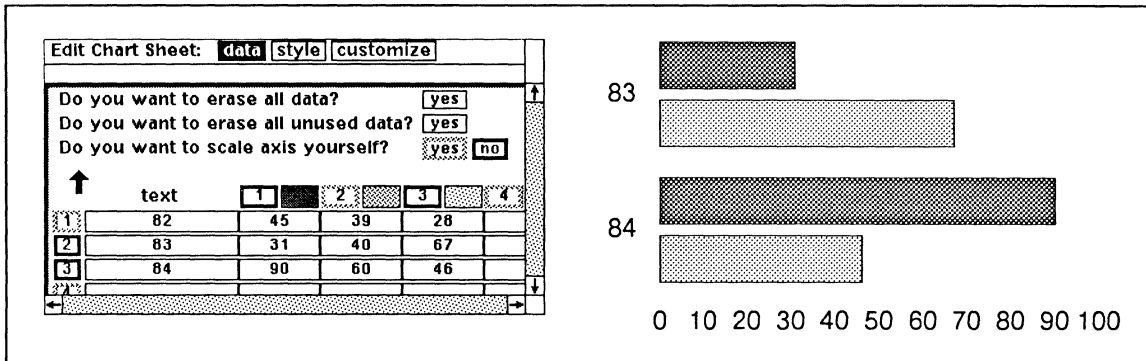

Figure 28-9. A data sheet with boxes turned off and the resulting chart

You turn a box *on* by pointing the mouse cursor into a box with a grey border and clicking the left (or right) button. You turn a box *off* by pointing the mouse cursor into a box with a black border and clicking the left (or right) button.

### Answering Questions

On the Data sheet for every kind of chart, there are questions that you need to answer only if your answer is yes. Figure 28-10 shows the two questions that appear on all Data sheets.

Do you want to erase all data?	<input type="button" value="yes"/>
Do you want to erase all unused data?	<input type="button" value="yes"/>

Figure 28-10. Questions on all Data sheets

If you point the mouse cursor into one of these boxes and click the left (or right) button, the action will occur immediately on the Data sheet. But, to see the results on the chart, you must use the **Apply** command on the Edit Chart popup menu. In the second question, “unused data” refers to data in rows and columns that are not active, that is, turned *off*.

There are two questions that appear only on the Data sheets for *line*, *filled line*, and *scatter charts* (Figure 28-11).

Do you want lines to have same hor. values?	<input type="button" value="yes"/>
Do you want lines to have same hor. increment?	<input type="button" value="yes"/>

Figure 28-11. Questions on Data sheets of line style charts

If the horizontal values for all the lines are *identical* but *randomly spaced* (5, 9, 17, and 30, for example), you can type in the values for **line 1** (Figure 28-12a) and answer *yes* to the question *Do you want lines to have same hor. values?* The software will fill in the values for the other five lines (Figure 28-12b).

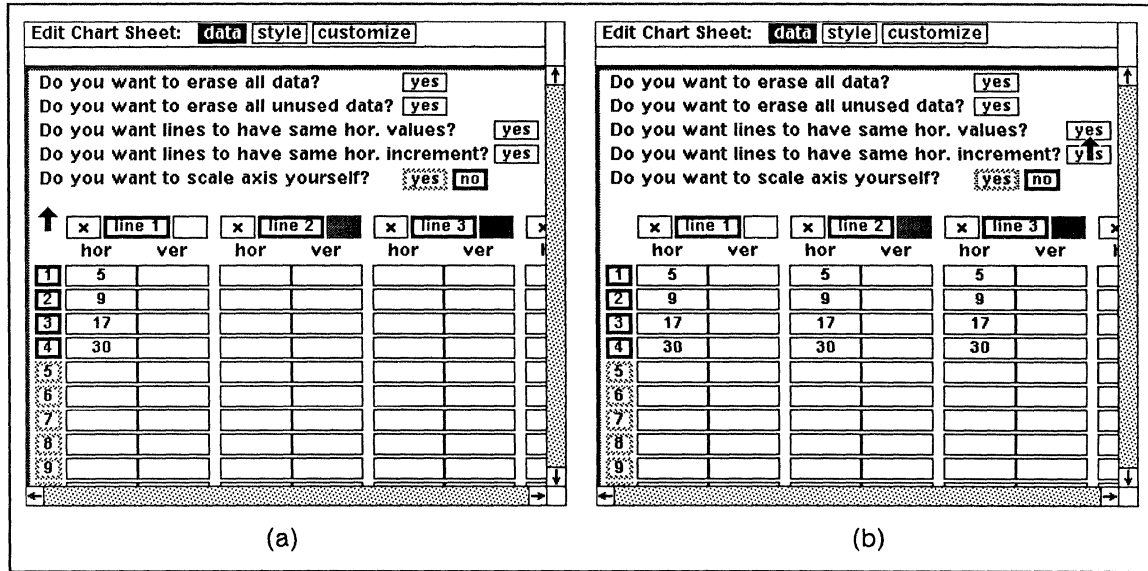

Figure 28-12. Automatic entry on Data sheet when increments are different

The other question—*Do you want lines to have same hor. increment?*—applies if you want the horizontal values for all the lines both *identical* and *evenly spaced* (e.g., 5, 10, 15, and 20). In this case, enter the first two horizontal values for **line 1** (Figure 28-13a) and answer *yes* to the question. The software will fill in the remaining values for **line 1** and all of the values for the other five lines (Figure 28-13b). Remember that values are used only if you *turn on* the left-hand, numbered boxes.

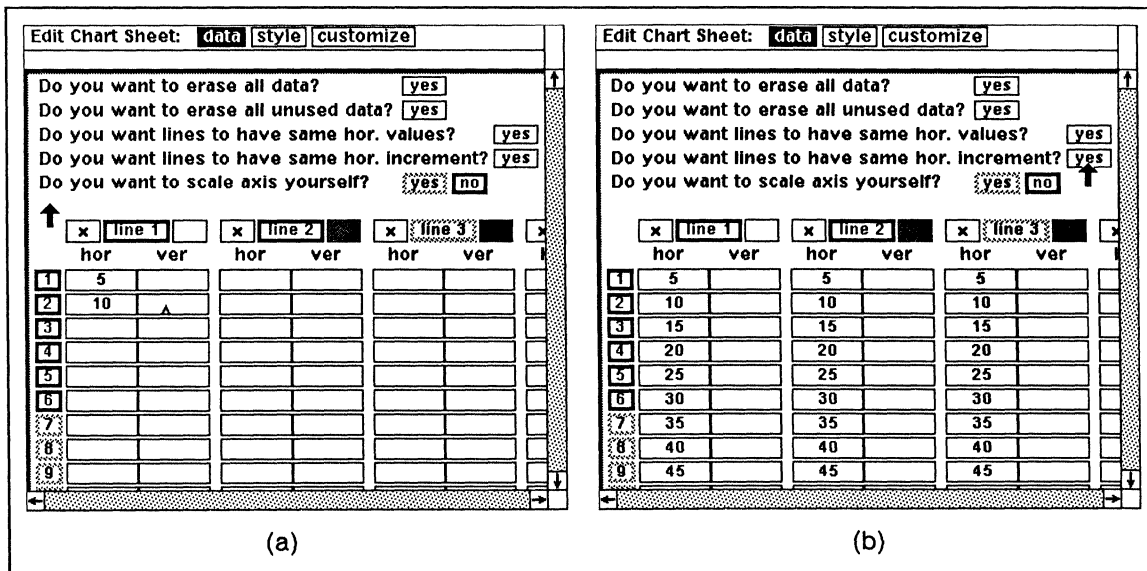

Figure 28-13. Automatic entries on Data sheet when increments are the same

## Typing Information

On the Data sheet, there are fields into which you *must* type information and fields where you have a choice whether or not to type data. For example, if you want to scale the axes yourself, you *must* type in the values you want. But you can either type in data for the chart or copy them from somewhere else.

As elsewhere on property sheets:

- When you start typing, the contents of the field are automatically erased.
- You confirm an entry by pressing the **TAB** or **RETURN** key or one of the arrow keys or Control key sequences that are explained below.

Sometimes, you may want to edit the contents of one of the boxes rather than completely change it. Using a combination of Control key sequences or the arrow keys and the **DEL** key, you can move the editing cursor and delete individual characters. Then you can type your changes and confirm.

All Control key sequences involve holding down the **CTRL** key and typing the appropriate letter.

The following keystrokes move the cursor:

- **<CTRL>f** or **▶** moves the cursor forward a character; when the cursor reaches the end of a field, **<CTRL>f** or **▶** confirms the entry and moves the cursor to the beginning of the next field.
- **<CTRL>b** or **◀** moves the cursor backward a character; when the cursor reaches the beginning of a field, **<CTRL>b** or **◀** confirms the entry and moves the cursor to the beginning of the previous field.
- **<CTRL>n** or **↓** confirms the entry and moves the cursor down to the beginning of the corresponding box in the next row.
- **<CTRL>p** or **▲** confirms the entry and moves the cursor up to the beginning of the corresponding box in the previous row.

The following keystrokes delete characters:

- **<CTRL>d** deletes the character to the right of the cursor.
- **<DEL>** deletes the character to the left of the cursor.

## Pasting and Copying Data

On the Data sheet for each of our charts, you can type in the data you want to use, but you can also copy data from text and paste it into the Data sheet. This will both save you time and reduce the possibility of error.

---

Much of the data you will want to paste into a Chart Data sheet may come from a spreadsheet program. If you have our *Communications Option*, you may be transferring data from a spreadsheet program on your personal computer to your Interleaf desktop. This section deals only with copying data that are already in a document on your desktop. For details on how to use spreadsheet data to create a chart, see *Using Spreadsheet Data to Create a Bar Chart*. For information about transferring data to your desktop from another source, please see the appropriate chapters in the *Communications* section of the *Data Transfer Manual*.

On both Data sheet popup menus, there are two related commands, **Paste data** and **Copy data**. They have the same submenu (Figure 28-14).

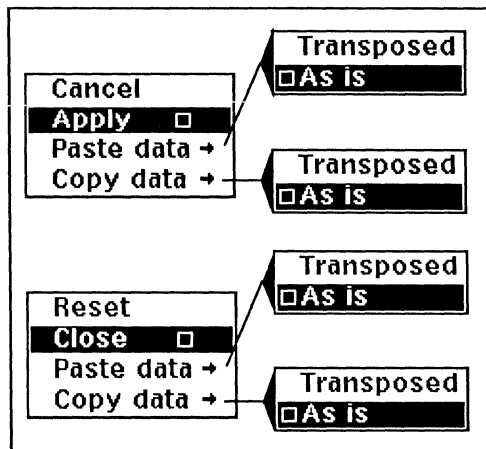

Figure 28-14. Paste data and Copy data submenus on the Edit Chart Data sheet

With these commands, you can often avoid the necessity of typing your data into the Data sheet. For example, if you have spreadsheet data in an Interleaf document, you can copy the data, using the **Copy** command on the Text Selected popup menu. Then you can paste the data into a Data sheet using the **Paste data** command. You can also use the **Copy** command within a virtual terminal window to copy data.

Similarly, if you have some data in one chart that you want to use in another chart or in the text of a document, you can use the **Copy data** command on one of the Data sheet popup menus to copy the data and then paste it elsewhere.

---

Data that you copy from a Chart Data sheet become the contents of a *from* 'documentname' document icon on the clipboard. Therefore, you can paste the data into text just as you would any other text object.

---

### *The Paste Data Command*

The **Paste data** command is used to paste data into a Chart Data sheet. Before you paste data into a data sheet, you *must* do two things and you *may want* to do another.

- If you already have some data on the sheet that you want to keep, you *must* turn off the boxes associated with these data or the data will be overwritten.
- You *must* turn on enough numbered boxes across the top and down the left side of the data sheet to accommodate the data you want to paste into the sheet. If you do not have enough boxes on, some of the data will be lost. (Because of the possibility of error here, be sure to **Copy** rather than **Cut** data from text or spreadsheets).
- You *may want* to erase all data already on the sheet. If the data are not part of the chart you are constructing, the numbers on the sheet may get in the way and make it difficult for you to see your own data and the relevant settings.

---

Rows of data, for the purpose of pasting into Chart Data sheets, must be separated by hard or force justify returns.

On the Data sheet for a line chart you must enter data for both horizontal and vertical coordinates. However, the Paste data command on the Data sheet allows you to paste data into vertical columns only. You must type in horizontal values.

---

On the **Paste data** submenu, there are two choices: **As Is** or **Transposed**. If you paste data **As Is**, the structure of the rows and columns is maintained as it was in the original. If you paste data **Transposed**, rows and columns are reversed, the rows becoming columns and the columns becoming rows. Figure 28-15 shows examples of the action of both commands.

These data are copied from the text of a document:

```

18.5    72.9    13.75   11.2
12.87   13       0        92.4
16.23   18.12   74.4     18.7
10.13   0         4.82    -16.12
    
```

When they are pasted **As Is**, this is how the Data sheet and resulting chart look:

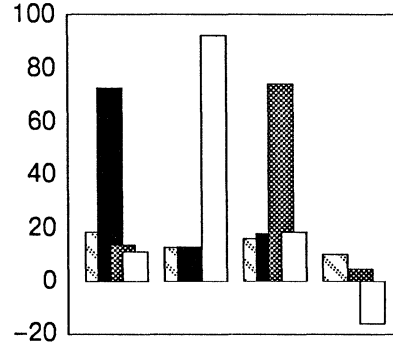
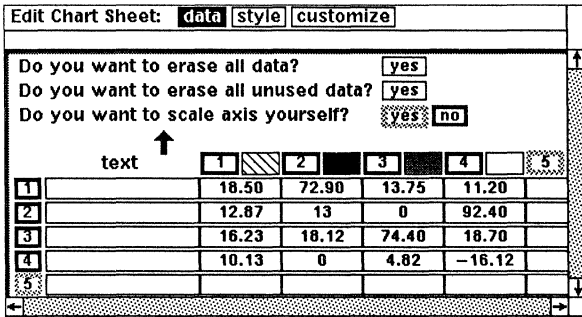

(a)

When they are pasted **Transposed**, this is how the Data sheet and resulting chart look:

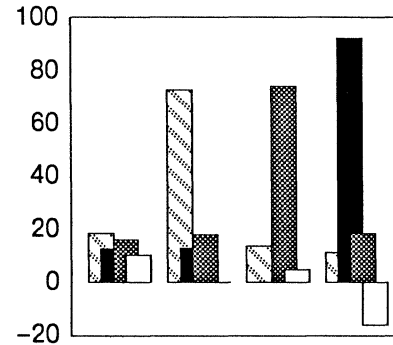
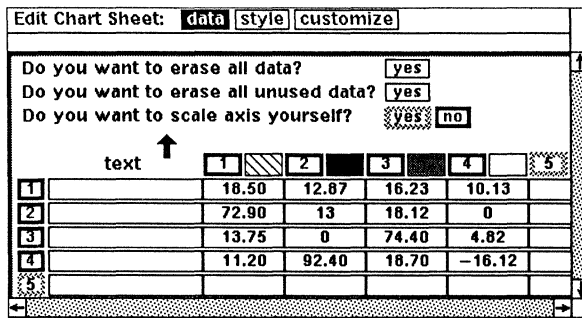

(b)

Figure 28-15. Pasting data

The data from text in Figure 28-15 are in an easy form for pasting into a Chart Data sheet because they consist of only digits (including 0's where there is no entry), tabs, and returns. There are several other forms of data that are easily handled by the **Paste data** command.

The **Paste data** command ignores words, so the data would be just as easy to paste into a Chart Data sheet if the text looked like Figure 28-16:

---

Administrative	18.5	72.9	13.75	11.2
Professional	12.87	13.	0	92.4
Research	16.23	18.12	74.4	18.7
Manufacturing	10.13	0	4.82	-16.12

---

Figure 28-16. Sample data preceded by words

You could copy all the text from *Administrative* through *-16.12* and paste it into the Chart Data sheet.

The **Paste data** command also interprets parentheses around data as indicating that the number is negative. Therefore, if the last item had been *(16.12)*, it would have been accurately pasted into the Data sheet as *-16.12*.

However, some data have to be dealt with in a different way, for example, data in the form shown in Figure 28-17:

---

Administrative 1/1/85	18.5	72.9	13.75	11.2
Professional 1/1/85	12.87		.	92.4
Research 1/1/85	16.23	18.12	74.4	18.7
Manufacturing 1/1/85	10.13	.	4.82	-16.12

---

Figure 28-17. Sample data preceded by words and digits

The **Paste data** command interprets all digits as data. Therefore, it would put the digits in the dates (*1/1/85*, for example) into separate data fields on the Data sheet. To avoid this, you can either delete the dates before copying the text or copy just the data line-by-line. The first alternative is usually preferable because it requires fewer individual steps. If you choose to copy data line-by-line, you must remember to turn off the box (row or column, depending on whether you paste *as is* or *transposed*) associated with the data you have just finished pasting.

Blank fields and decimal points with no numbers next to them are completely skipped by the **Paste data** command. When the command finds a blank field or a field with only a decimal point in it, it moves the data over on the Data sheet to fill up the field. For example, if you copied and pasted the second row of data in the example above, the blank field and the field with the decimal point would be

skipped and 92.4 would appear in the column right next to 12.87. To avoid this, before you copy the text, type 0's into the blank fields and either type 0's on one side of each decimal (i.e., 0. or .0) or substitute 0's for the decimals.

Commas are also ignored, so that 1,000 becomes 1000 and the European form 1.000,0 (one thousand) becomes 1.0000 (one).

### The Copy Data Command

The **Copy data** command is used to copy data from a Chart Data sheet, so that they can be used elsewhere, for example, in the text of a document or as the data for another chart.

Before you use the **Copy data** command, you must make sure that only the rows and columns you want to copy are turned on.

On the **Copy data** submenu, there are two choices: **As Is** or **Transposed**. If you copy data **As Is**, the structure of the rows and columns is maintained in the copy. If you copy data **Transposed**, the rows and columns are reversed in the copy with the rows becoming columns and the columns becoming rows.

If you are going to use the data in another chart, it does not matter which of these alternatives you use because you can easily reverse the choice when you paste the data into the other chart. However, if you plan to use the data you copy from a chart in the text of a document, make sure you copy them in the form you want them since the **Paste** commands on the Component and Text Location popup menus paste "as is."

When you want to paste data into the body of your document, it will usually be more convenient to paste them *as a component* rather than as text because then the software will insert decimal tabs automatically. If you paste the data as text, the software will use the current tab settings of the component.

### Using Paste and Copy on the Same Chart Data Sheet

For Figure 28-15b, the data in Figure 28-15a could have been reversed by using a combination of the **Copy data** and **Paste data** commands.

#### To reverse the row and column data on a Chart Data sheet:

- ✓ Use **Copy Data** → **As Is**.
- ✓ Make sure that the rows and columns you want to paste the data into are the *only* ones that are turned on.  
*For example, if you have copied three rows and four columns and want to paste them as four rows and three columns, turn on the fourth row and turn off the fourth column.*
- ✓ Use **Paste Data** → **Transposed**.  
*The results would be the same if you used*  
**Copy data** → **Transposed** *and then* **Paste data** → **As Is**.



## Using Spreadsheet Data to Create a Bar Chart

Much of the data you will want to paste into a Chart Data sheet may come from a spreadsheet program. In this section, we are going to create a bar chart using data from a sample spreadsheet (Figure 28-18). In the following exercise, we will copy one line of data from the spreadsheet, although we could copy several lines of data at once.

We will copy the line showing the *Total Salary* for *Months 1 to 7* and illustrate the salaries on a bar chart. This chart will contain seven bars, one for each month listed in the *Total Salary* line of the spreadsheet chart. Each bar will have the same characteristics (i.e., the same fill).

---

DISTRICT SALARY PROFILE							
**MONTHS 1 TO 7**	7	2	3	4	5	6	6 7
MANAGER	6000	6000	6000	6000	6000	6000	6000 7
CUSTOMER ENGINEER #6			6600	6600	6600	6600	6600 7
SALES REP #6			6000	6000	6000	6000	6000 7
SALES REP #6				6000	6000	6000	6000 7
MKTG SUPPORT			6600	6600	6600	6600	6600 7
ADMIN/SEC		6600	6600	6600	6600	6600	6600 7
SUBTOTAL	6000	6600	66600	66600	69600	60600	60600 7
SALARY OVERHEAD	866	6666	6666	6666	6666	6698	6698 7
TOTAL SALARY	6866	6666	66066	60666	66966	66998	66998

---

Figure 28-18. Example spreadsheet in Typewriter font

### To create a bar chart by selecting a horizontal row of data:

- ✓ Start by selecting (highlighting) the *Total Salary* line.  
*The legend (Total Salary in the example) may be selected as well as any other text on the line. Embedded dollar signs, commas, etc., can be included. However, if the legend in the line you are selecting contains a numeral (for example, Sales Rep #1), do not select the legend. If you do select it, the numeral (1) will become part of the data.*
- ✓ Copy it.
- ✓ Create a **Frame** in your document and adjust the size, if necessary.
- ✓ Create a **Chart**.
- ✓ Select the chart.
- ✓ Choose **Props** and then **Edit** and go to the Edit Chart Data sheet.

- ✓ Select box 1 on the top and boxes 1 through 7 along the left side to accommodate the data from the Total Salary line.

*Note that you must select the appropriate number of rows and columns to accommodate the data you are about to paste. Since we plan to paste the data **Transposed**, we have selected 7 rows and 1 column. Because there is a limit of 6 columns, if we selected 6 columns and 1 row and pasted **As Is**, we would lose the last piece of data.*

- ✓ To clean things up, select yes for the option *Do you want to erase all data?* at the top of the Data sheet.

*All current data will be erased from the sheet.*

- ✓ Press the **middle** button, select **Paste Data** and then slide onto the submenu and choose **Transposed**.

*Since we have chosen **Transposed** for this example, the data that was originally in a horizontal row in the spreadsheet appears vertically in a column on the Data sheet.*

- ✓ When the numbers from the spreadsheet appear on the Data sheet, **Apply** the information, and you will see a chart similar to Figure 28-19.

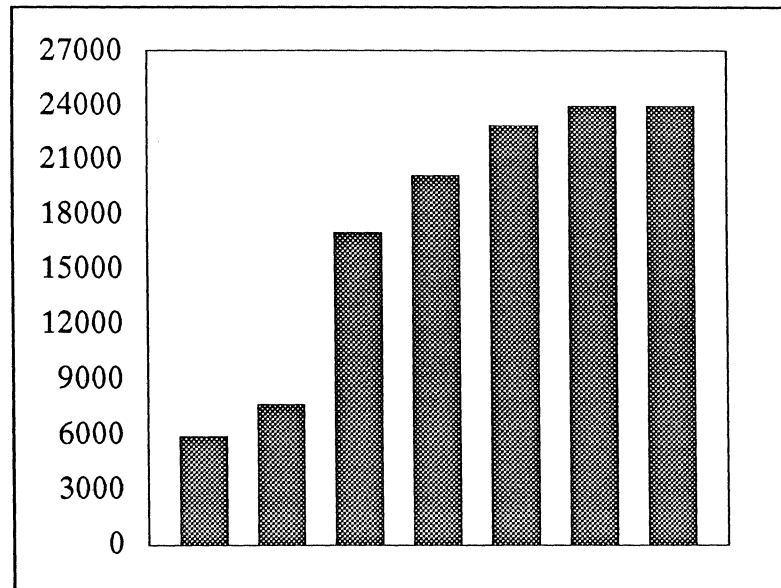

Figure 28-19. Bar chart created from spreadsheet data

**To create a bar chart by copying a vertical column of data:**

It is not possible to select and paste a column on the spreadsheet. If you want to include some of the *columns* from the spreadsheet data and paste them into a chart, considerable cutting and pasting is necessary.

One way is to do the following:

- ✓ Select the whole component containing the spreadsheet data.
- ✓ Copy it.
- ✓ Paste it into a temporary location.
- ✓ Edit out the columns you do not want.
- ✓ Copy or Cut the remainder.
- ✓ Paste it into the Chart Data sheet.

If your chart has six or fewer columns, you can do the following:

- ✓ Copy and Paste all of the columns into the Data sheet.
- ✓ Deselect the columns you do not want.
- ✓ Use **Copy Data** to put the desired columns on the clipboard.
- ✓ On the Data sheet, erase all data.
- ✓ Select just the number of needed columns (boxes across the top), starting from the left.
- ✓ Paste the data from the clipboard.

If the original data has more than 6 columns but 6 rows or fewer, you could transpose it and then follow the steps for six or fewer columns.

As illustrated above, the **Copy Data** and **Paste Data** operations can be used for reorganizing data in Edit Chart Data sheets. It is possible to insert, exchange, or delete rows or columns by properly selecting, copying, and pasting.

## The Style Sheet

The **Style** sheet is the property sheet you can use to determine how the data will be displayed.

The **Style** sheet is dynamic; that is, it changes according to the type of chart selected, and there are several elements of chart style that pertain to one kind of chart but not to the others.

This section is divided into four parts. In the first part, we discuss the ways that changes are made on the **Style** sheet. In the second part, settings that are common to all charts are presented in detail. The third part contains descriptions of settings common to line and bar charts. The fourth part provides descriptions of settings unique to a particular type of chart.

## How Changes are made on the Style Sheet

On the **Style** sheet for all types of charts (with one exception on the *pie chart* **Style** sheet), there are two ways to make changes:

- by turning boxes *on*
- by using the left and right mouse buttons to adjust the size of margins

On the **Style** sheet for *pie charts*, there are also fields in which you can type the number of the wedge that is to be exploded. These fields are discussed in the section *Pie Chart Options*.

## Entering Information by Turning Boxes on

Most of the information on the **Style** sheet is entered by pointing into a box and clicking the left button to turn one choice *on*. Turning one box on automatically turns the previous choice for the property *off*. Note that when a box is turned *on*, its border changes from grey to black. *Chart type* and *data border* are examples of this type of information (Figure 28-20).

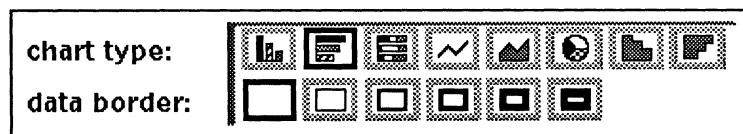

Figure 28-20. Examples of boxes that register information on the **Style** sheet

In this figure, the border around the icon for the horizontal bar chart (the second icon from the left) is black, meaning that this is the *chart type*; and the left-most box next to *data border* is black, meaning that there will be no border around the data.

## Altering Margins

Another way you change some of the information on the Style sheet is by using the left and right buttons to alter the size of something, usually a margin. The *data margins* settings are an example of information that is registered in this way (Figure 28-21).

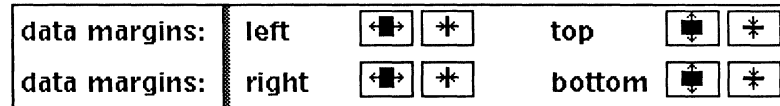



Figure 28-21. Data margins boxes

Pointing the mouse cursor into one of these boxes and clicking the *left* button causes a *large change* in the size of the margin, while pointing and clicking the *right* button causes a very *small change* and is used for making fine adjustments. One *left* button click is equal to approximately 19 *right* button clicks.

The pattern for pairs of boxes that look like the ones in Figure 28-21 is as follows:

- The left-hand box  makes the margin *larger*.
- The right-hand box  makes the margin *smaller*.

Because you need to see how the space is changing in response to your clicking, it is a good idea to use the **Apply** command of the Edit Chart popup menu after every click of the left button and every few clicks of the right button. Since **Apply** is the default, you can set up a very efficient rhythm of *click, Apply, click, Apply, click, click, Apply*.

### Data Margins

When you make a *data margin* larger, you increase the part of the chart outside of the area in which the data themselves are displayed (Figure 28-22).

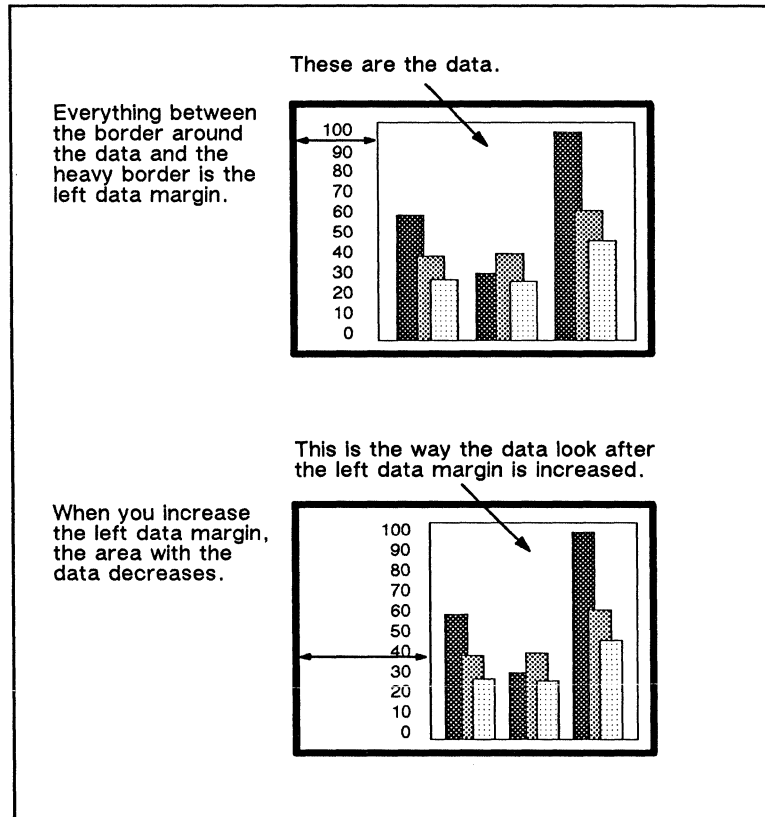

Figure 28-22. Changing data margins

You can manipulate data margins so that they disappear and the area in which the data appears is the same size as the entire chart. This can be very useful when you want all your charts to be exactly the same size.

## Label Margins

Another kind of margin is the *label margin* (Figure 28-23). A *label margin* is the distance between the label (often a number) and the data. *Label margins* are changed the same way *data margins* are. For *pie charts*, only the *bottom label margin* has any meaning.

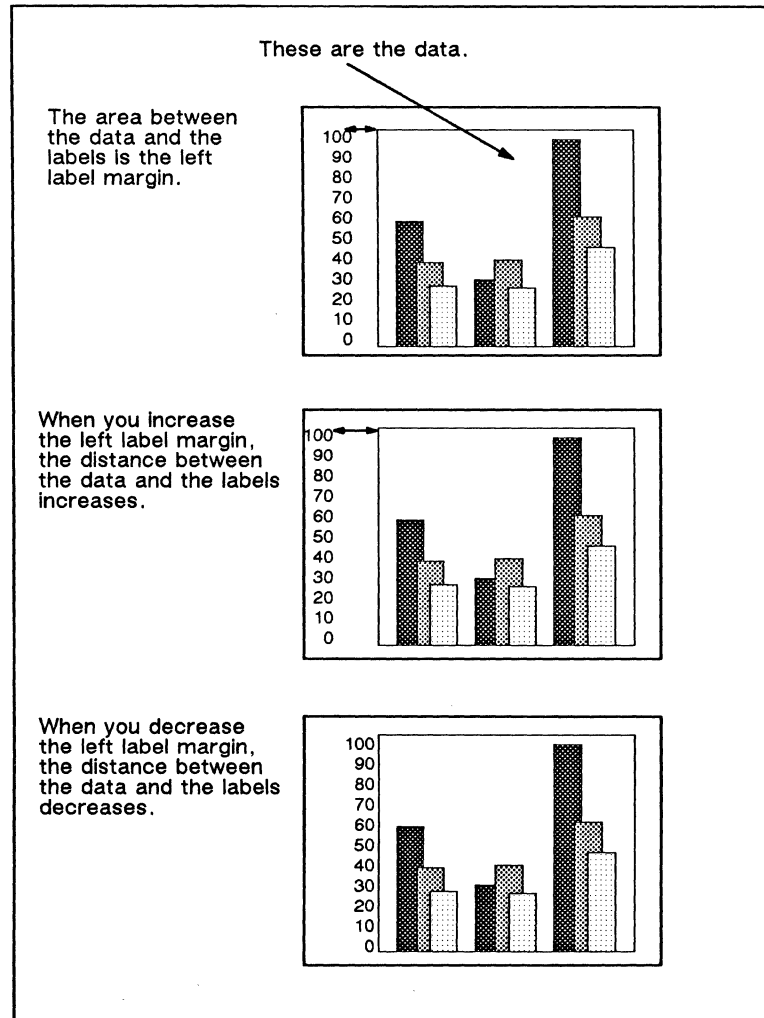

Figure 28-23. Changing label margins

You can decrease label margins so much that the labels appear on top of the data or are moved to the right side of the chart. You can also increase label margins so much that the labels disappear from your screen because they are outside of the chart. When this occurs, the labels will not appear when you print the chart. If you do not want the labels to print, it is good practice to turn *off* the *label display* settings.

## Properties that are the Same for all Chart Styles

The entries in this section are presented in the form of an alphabetical glossary.

**Chart type.** The icons represent the types of charts (Figure 28-24). It is only useful to change chart type if your data are appropriate for the new chart type. In other instances, it is better to choose a chart of the right type from the charts in the *Graphics* cabinet. Surface charts are in the *Bars* document. (For more information about scatter charts, see the *Line Chart Options* section.)

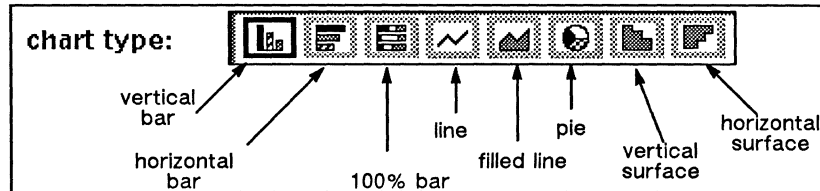

Figure 28-24. Chart types

**Data border.** The icons represent the thickness of the border around the data. Figure 28-25a shows a chart with no border and Figure 28-25b shows a chart with a medium-thick border.

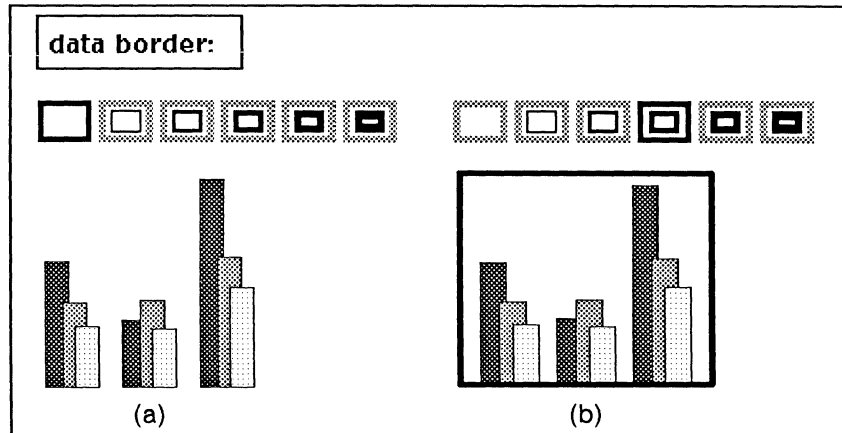

Figure 28-25. Data borders

**Data margins.** These boxes are used to alter the size of the margins around the data (Figure 28-26). *Data margins* are discussed in the *Altering Margins* section.

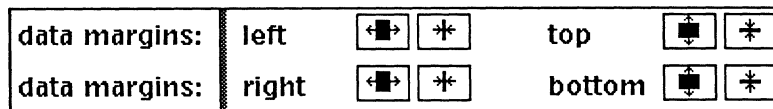

Figure 28-26. Data margins boxes



**Item [1, 2,...].** These icons represent the available textures. Figure 28-27a shows the first seven textures as you see them on your screen, and Figure 28-27b shows the same textures as they appear when printed. There are fourteen more textures that you can see by scrolling the Style sheet horizontally or by resizing the sheet. For bar charts, *item 1* corresponds to *bar 1*; for line charts, it corresponds to *line 1*; and for pie charts, it corresponds to *wedge 1*.

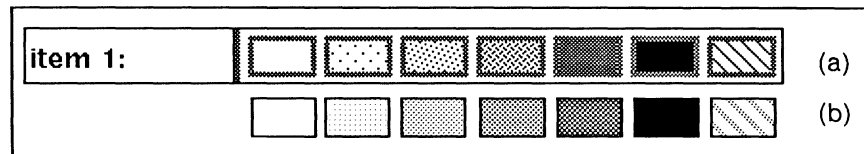

Figure 28-27. Textures

**Label display.** System-generated labels for the data can be displayed down the left side and along the bottom of most charts. You can turn the labels *off* if you want no labels or if you want to enter your own labels using the diagramming system. *Pie charts* can have only bottom labels. Figure 28-28a shows a chart with both left and bottom labels displayed, and Figure 28-28b shows a chart with neither left nor bottom labels displayed.

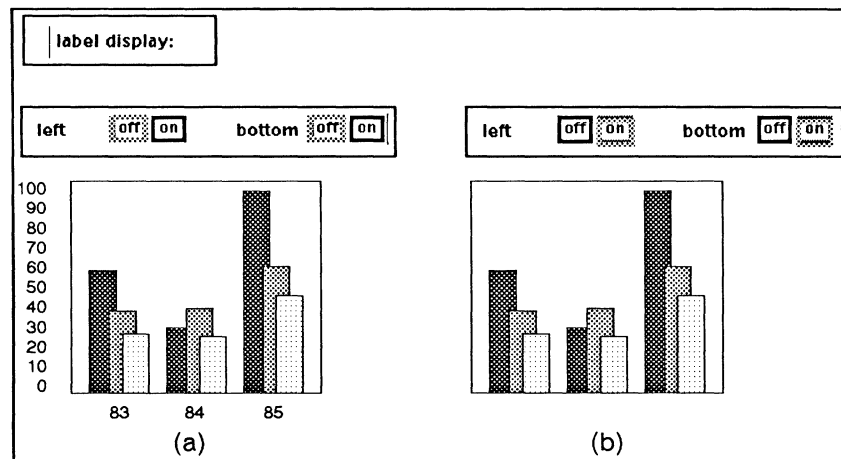

Figure 28-28. Charts with label display on and off

**Label margins.** These boxes are used to alter the distance between the data and the labels (Figure 28-29). *Label margins* are discussed in *Altering Margins*.



Figure 28-29. Label margin boxes

## Properties that are the Same for Bar and Line Charts

The entries in this section are presented in the form of an alphabetical glossary.

**Background.** If the left-most box is *on*, there are no background lines. The next five icons represent the thickness of lines if they do appear. The two icons on the right (Figure 28-30) are used for determining whether the background lines will appear behind the data (the left icon) or in front of the data (the right icon).

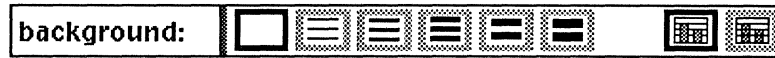

Figure 28-30. Background lines

**Major hash/minor hash.** Hash marks are lines just outside the data that help people interpret the data. They can be turned *off* or be of various lengths and thicknesses. Figure 28-31 shows two charts with different settings. Hash marks can appear to the left of *vertical bar*, *vertical surface*, *line*, and *filled line charts*. They can appear at the bottom of *horizontal bar*, *100%*, and *horizontal surface charts*. If the left-hand icon is *on*, no hash marks will appear. The next three icons in the left-hand set control the thickness of the hash marks. The right-hand set of icons controls the length of the hash marks.

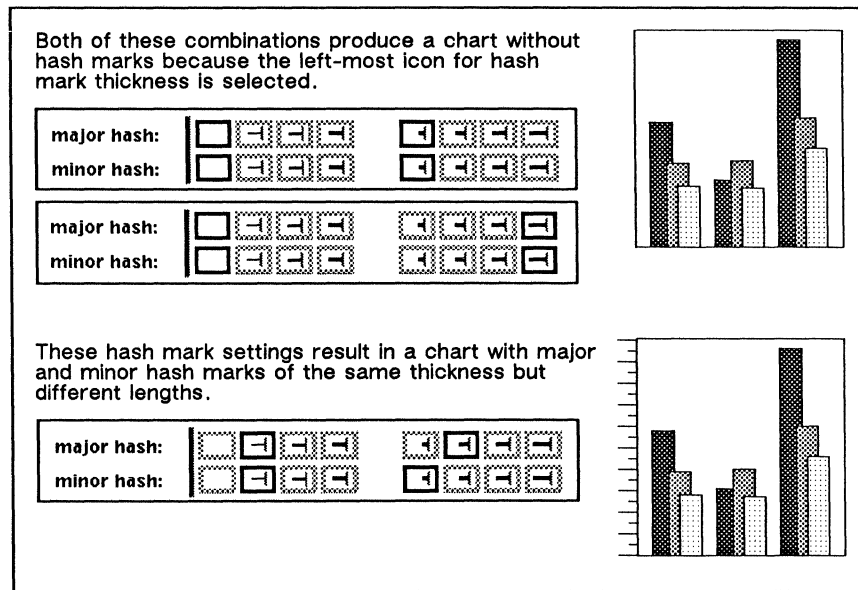

Figure 28-31. Hash marks

**Origin line.** This line has meaning only if some of the data are negative. The *origin line* is at 0. The icons represent the possible thicknesses of the line (Figure 28-32).

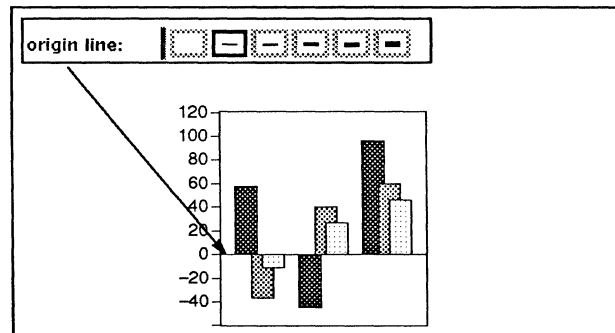

Figure 28-32. Origin line

## Properties that Differ among Chart Styles

The Style sheet is dynamic; that is, it changes according to the type of chart selected, and there are several elements of chart style that pertain to one kind of chart but not to the others. For example, the *bar [1,2...]* and *bar/gap size* properties appear only on the Style sheet for *bar charts*, *line* choices appear only on the Style sheet for *line charts*, and *pie* choices appear only on the Style sheet for *pie charts*.

### Bar Chart Options

**Bar [1, 2,...].** The nine icons next to *bar [1]* on the Style sheet for bar charts represent the placement of that particular bar in relation to the other bars in the same set. When you change the amount of overlapping, the software automatically adjusts the width of the bars. In the discussion that follows, vertical bar charts are used for the examples, but the principles are the same for horizontal bar charts and 100% bar charts.

There are several general guidelines for using these settings:

- You can select only one icon per bar in a set.
- If you do not want the bars to overlap, leave three unhighlighted icons between each of the icons you select (Figure 28-33a).
- If you want the bars to overlap, leave fewer than three unhighlighted icons between each of the icons you select. When you place the bars in overlapping positions, *bar 1* will always be in back of the other bars, *bar 2* in front of *bar 1*, and so on (Figure 28-33b).

- If you want to stack the bars, select the same icon for all of the bars. When you stack bars, *bar 1* will always be on the bottom, *bar 2* on top of *bar 1*, and so on (Figure 28-33c).

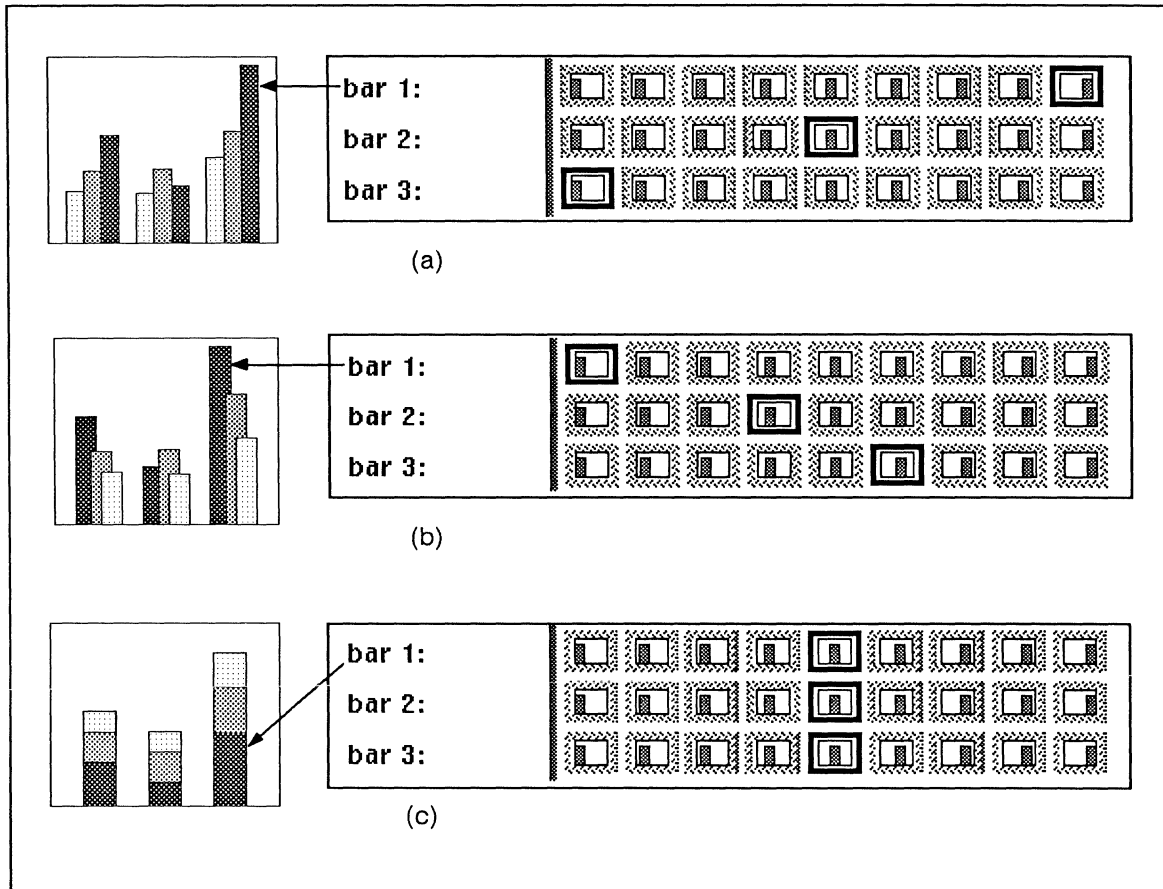

Figure 28-33. Bar settings

**Bar borders.** The bar borders option appears to the right of the nine *bar [1]* icons on the Style sheet for a bar chart. By default all bars in a bar chart are bordered by a black line (Figure 28-34a). You can turn off the border as shown in Figure 28-34b.

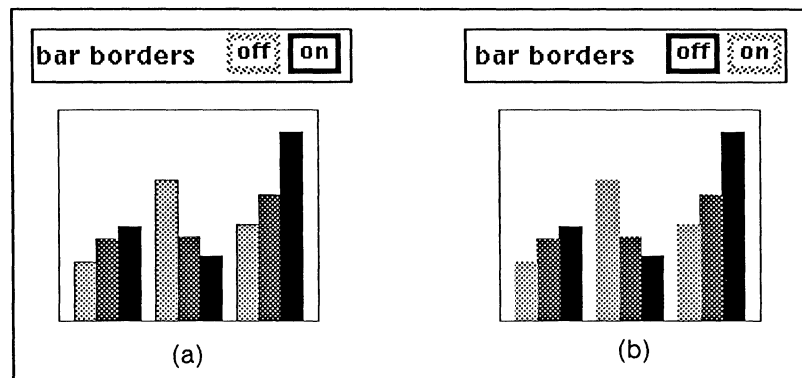

Figure 28-34. Charts with bar borders on and off

Note that if your chart contains one or more bars whose fill is white or none and you turn bar borders off, those bars are no longer visible.

**Bar/gap size.** When you are editing a bar chart, the *scale* and *fix* options will help you make the bars the size you want them and position the *sets of bars* the distance you want them from each other.

**Scale.** Scale gives you six options represented by icons. If you turn on the left-most icon, you get thin bars with wide gaps between the sets of bars (Figure 28-35a). If you turn on the right-most icon, you get wide bars with overlapping sets of bars (Figure 28-35b).

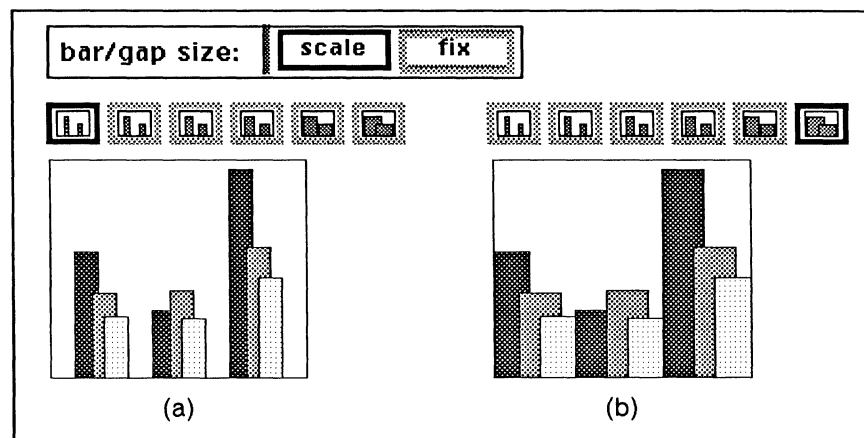

Figure 28-35. Scaling the size of bars and gaps

**Fix.** If the six *scale* options do not offer enough variety, you can use *fix* to make even finer adjustments.

---

When you switch from *scale* to *fix*, use the **Apply** command before you start adjusting the settings, so that you can see the chart you are beginning with.

---

When *fix* is on, you see three pairs of boxes on the Style sheet (Figure 28-36).

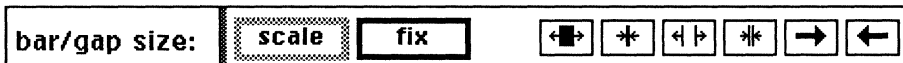

Figure 28-36. Fixing the size of bars and gaps

- Use the left-hand pair to make the bars wider or narrower .
- Use the middle pair to make the gaps between the sets of bars wider or narrower .
- Use the right-hand pair to move all the sets of bars to the right or to the left . (When you are editing a horizontal bar chart or a 100% chart, moves the bars down, and moves the bars up.)

To manipulate any of these settings, you point the mouse cursor into a box and click the left or right button. Because *fix* is used primarily for fine tuning, you will probably use the right button more than the left button. Figure 28-37 shows a chart that has been altered using these boxes.

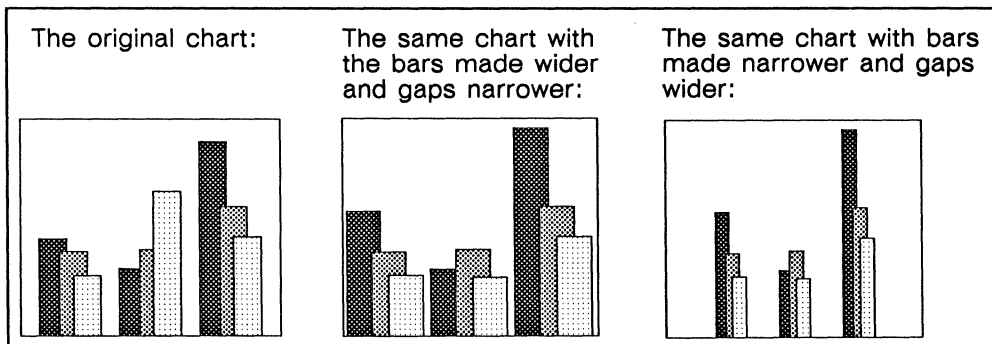

Figure 28-37. Two charts that have been altered using the *fix* settings

## Line Chart Options

There are three basic types of line charts you can produce: *line*, *filled line*, and *scatter charts*. You can also combine elements of these types to produce other results. For instance, you can create a chart that contains both lines and points.

The type of chart you should select depends on your data. If the data can be plotted regularly along the horizontal axis, the chart should usually be a *line chart*. If the data are irregular or clustered, the chart should be a *scatter chart*.

**Line size.** The six line size icons represent the possible thicknesses of data lines for both *line* and *filled line* charts (Figure 28-38). If the left-most box is on, the data lines have no thickness and are not visible.



Figure 28-38. Line size

When you create a line chart by first executing the **Chart** command on the Create submenu of the Diagramming Nothing Selected popup menu and then selecting a line or filled line *chart type*, the default *line size* is none. To produce lines showing the data, you must select another line size icon.

**Line options.** The line options item enables you to control two line chart features: *stacking* and *points*. The default line chart contains unstacked lines (without highlighted points) (Figure 28-39). Remember that you must enter data and change the *line size* setting to see these unstacked lines.



Figure 28-39. Line options

**Stacking.** The stacking options have meaning if there is more than one line in your chart. For example, if there are two lines and the left-hand box is turned *on*, each vertical value for *line 1* will be plotted. Then each vertical value for *line 2* will be added to the comparable value for *line 1*. *Line 2* will be stacked on top of *line 1* and will cross *line 1* only at points where the vertical value for *line 2* is negative. If the right-hand box is turned *on*, the vertical value of each line is plotted as is, and the lines will cross each other whenever this is appropriate to the data. Figure 28-40 shows how the same data look when the lines are stacked and when they are unstacked.

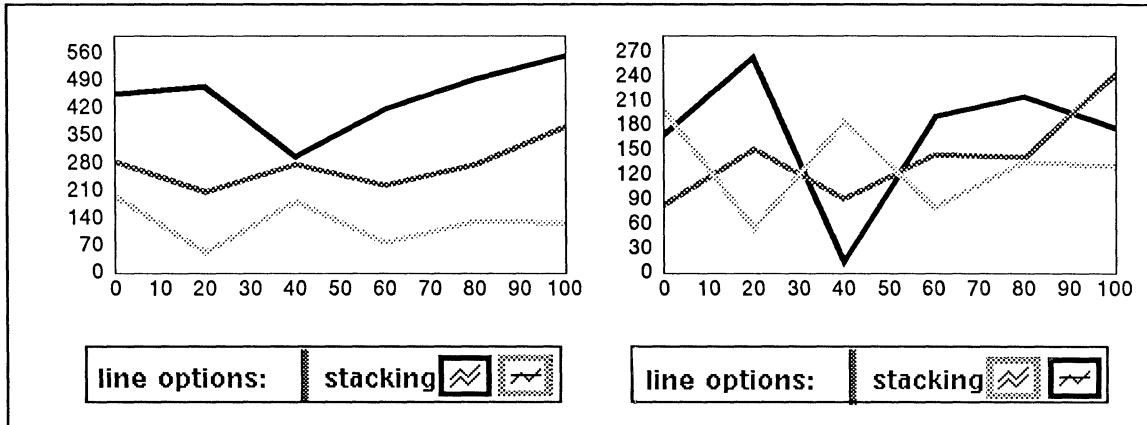

Figure 28-40. Stacked and unstacked lines

You can also produce a line chart containing both stacked and unstacked lines. To do this you must convert the chart into a bar chart and select bar placement icons to control which lines are stacked and which are not.

For example, if you selected the line chart shown in Figure 28-41 and changed the *chart type* to a vertical bar, then the data would appear as stacked bars. Once your data is in the form of a bar chart, you can control the stacking of individual bars. Any bars having the same bar placement icon selected will be stacked; any bars having different bar placement icons selected will not be stacked. The amount of overlap between bars has no bearing on the positioning of the data when it is converted into a line chart.

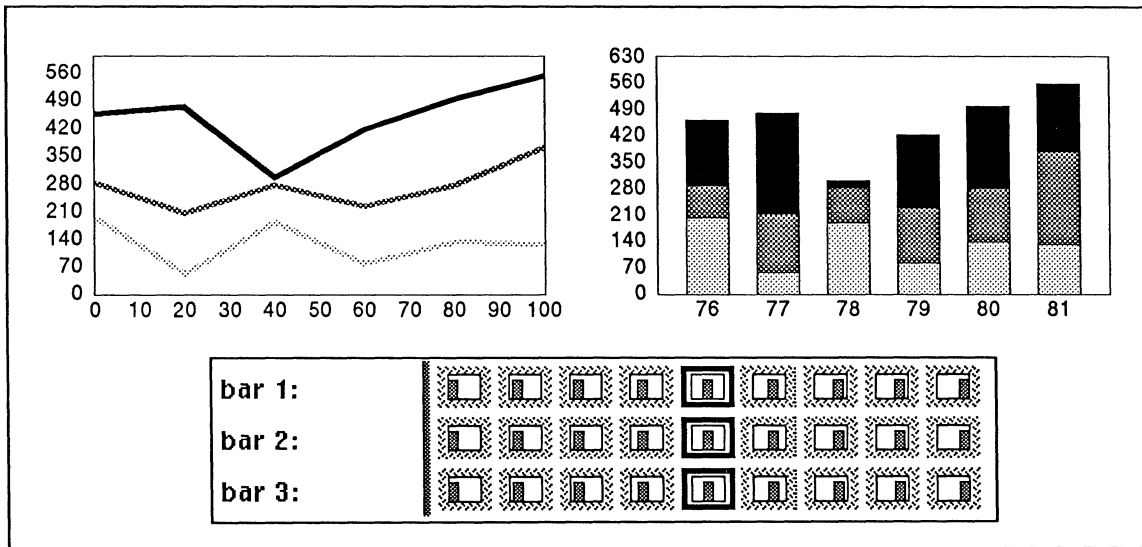

Figure 28-41. Stacked line chart converted to a bar chart and the corresponding bar placement icons

Since you can control the placement of each bar, you can leave two bars stacked but change the placement of the third to make it unstacked (Figure 28-42). To do this you must select a different bar placement icon to represent the third bar. As



long as the icon you select represents a different position from the one selected for another bar in that set, the bar will be unstacked. When you change the *chart type* back to a line chart, the resulting chart shows lines 1 and 2 stacked, and line 3 unstacked.

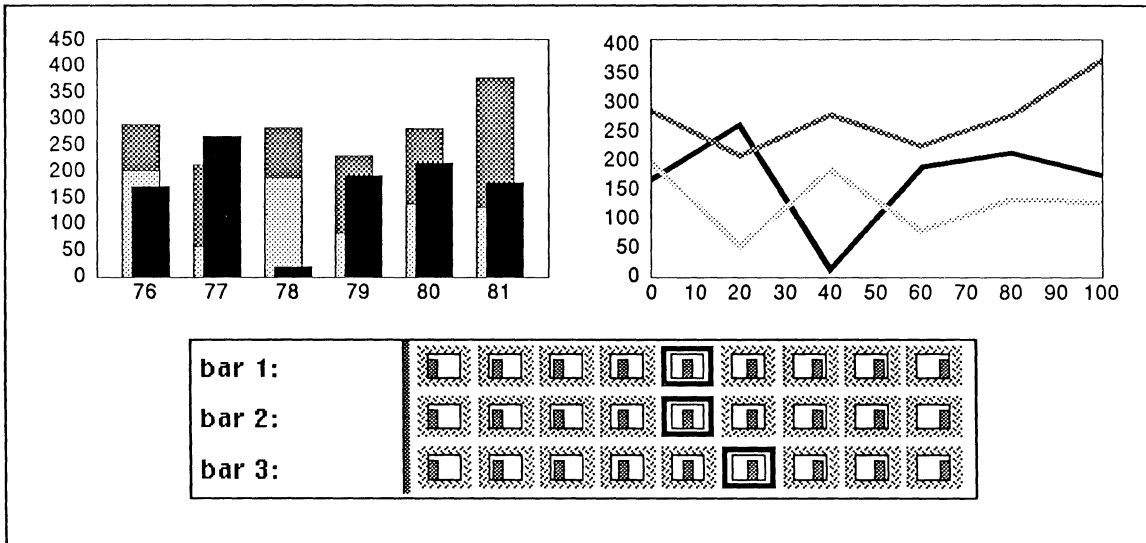

Figure 28-42. Partially stacked bar chart converted to a line chart and the corresponding bar placement icons

---

Note that the line chart Style sheet does not contain an icon representing a partially stacked chart. Once you create a partially stacked line chart, the *stacking* icons on its Style sheet no longer represent the condition of the data.

---

**Points.** It is possible to have regular data presented as discrete points rather than as a line. Figure 28-43a and Figure 28-43b are both line charts because the data they present are regular. These two charts are identical, except that the data are represented by a line in Figure 28-43a and by *x*'s in Figure 28-43b. You could create a chart containing both the line and *x*'s by setting *line size* to a thickness other than none and selecting the *points* icon .

When the data are irregular and the left-hand *line size* box and the right-hand *points* box are turned *on*, the chart will be a *scatter chart* (Figure 28-43c).

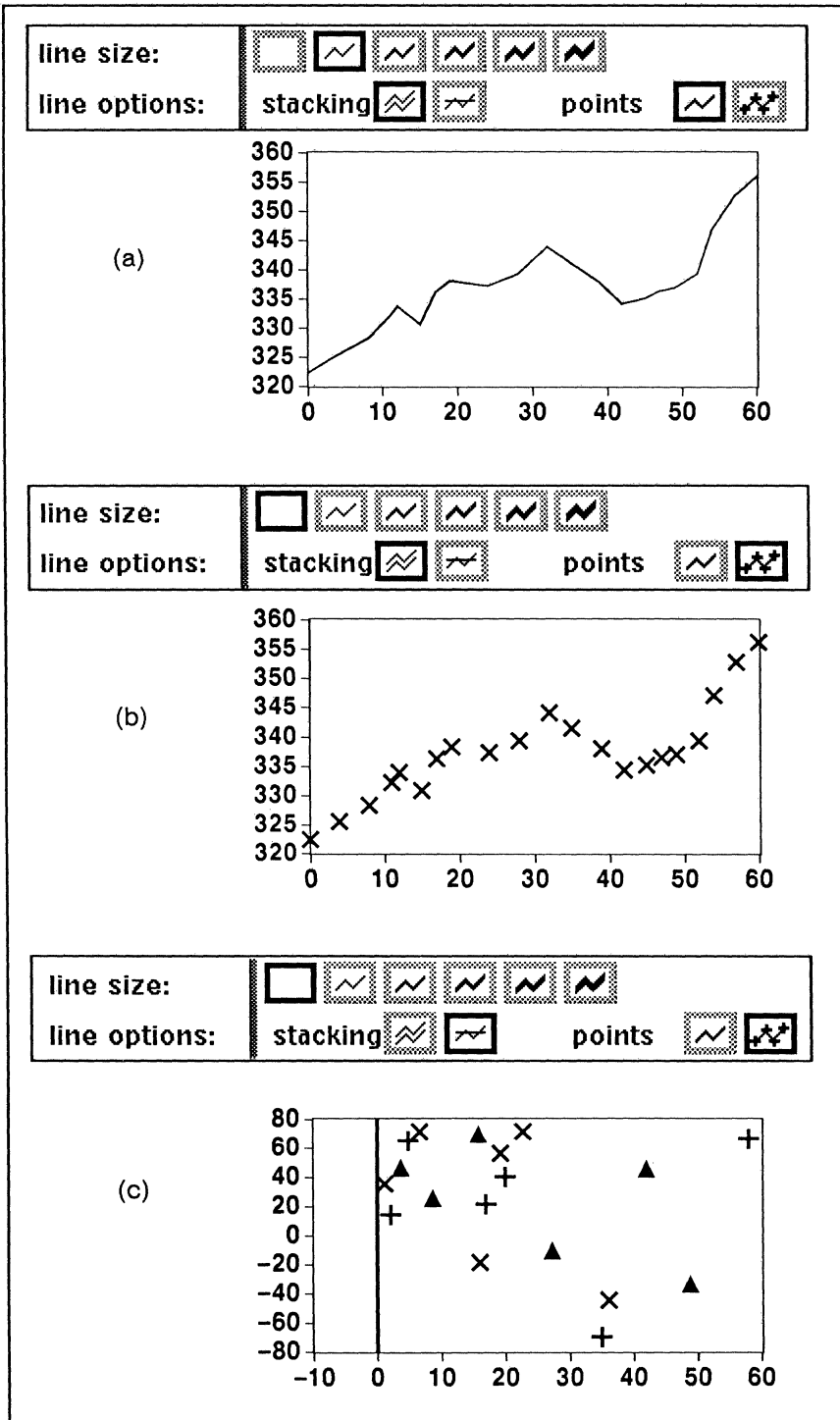

Figure 28-43. Line Choices

## Pie Chart Options

*Pie charts* have several properties that apply only to them (Figure 28-44). These settings can be combined in a variety of ways to give your data more visual impact.

pies:	radius	80	90	100	115	exploded radius	90	100	115	shift from center	0	15	25	50
which wedge:	pie 1	3												

Figure 28-44. Properties of pie charts

**Radius.** Radius refers to the radius of the whole pie. The numbers in the boxes next to *radius* represent adjustments you can make to the radius of the pie(s), depending on the overall size of the chart. The setting of *100* creates pies of the most aesthetically pleasing size, and the other settings create pies that are smaller or larger than this.

While *100* percent is not always the default *radius* setting, *100* percent is the reference value for calculating all the other *radius* settings. For example, if the radius of a pie is *1 inch* when *radius* is set to *100*, the radius will be *80%* of *1 inch* when *radius* is set to *80*, and it will be *115%* of *1 inch* when *radius* is set to *115*.

**Exploded radius.** Exploded radius refers to the radius of the wedge that can be shifted outward from the center of the pie. The *exploded radius* settings are percentages of the *radius* setting. For example, if the *radius* setting for the pie is *115* and you want the *exploded radius* the same size, make the exploded radius *100*; if the *radius* setting for the pie is *115* and you want the *exploded radius* *15%* greater, make the exploded radius *115*.

**Shift from center.** Shift from center refers to the degree of displacement of the shifted wedge. The shift is measured from the center of the pie to the tip of the wedge and is a percentage of the *radius*.

**Which wedge.** Which wedge designates the wedge of the pie that can be shifted. The wedges of the pies in a pie chart begin at 3 o'clock; therefore, in Figure 28-45, the darker grey wedge in each pie is *wedge 1*, and the wedge that is to be shifted is *wedge 4*.

### Examples of Pie Chart Combinations

Figure 28-45 shows the effect of various combinations of *radius*, *exploded radius*, and *shift from center*.

If the *radius* and *exploded radius* of a pie are *100* and the *shift from center* is *0*, there will be no distance between the center of the pie and the tip of the shifted wedge (Figure 28-45a).

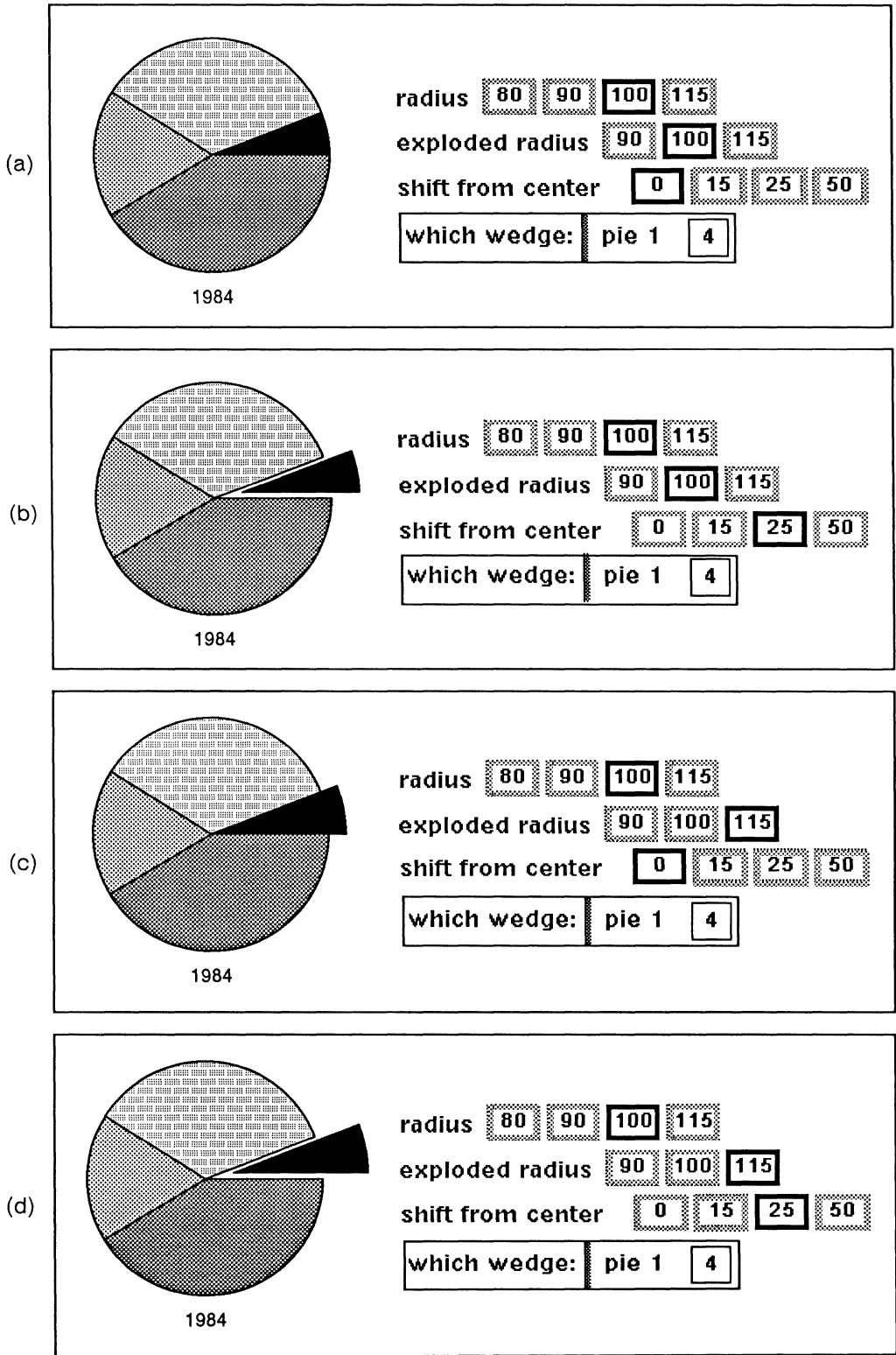

Figure 28-45. Pie charts

If the *radius* and *exploded radius* are 100 and the *shift from center* is 25, the distance between the center of the pie and the tip of the wedge will be 25% of the *radius* (Figure 28-45b).

When the settings for *radius* and *exploded radius* are different from one another, *shift from center* works basically the same way, but the effect changes. For example, when the *radius* is 100, the *exploded radius* 115, and the *shift from center* 0, the wedge with the *exploded radius* extends beyond the circumference of the pie, but there is no distance between the center of the pie and the tip of the wedge (Figure 28-45c).

When the *radius* is 100, the *exploded radius* 115, and the *shift from center* 25, the shift causes even more of the wedge with the *exploded radius* to extend beyond the circumference of the pie (Figure 28-45d).



---

## Chapter 29

# Customizing Charts

This chapter explains how to use various charts and diagramming features to tailor charts to your particular needs. The topics covered are:

- organization of properties on the **Customize** property sheet
- how to add other diagramming objects to data-driven charts

Before creating a customized chart, see the chapter *Making Charts* for fundamental information on how to create and modify charts.

### ◊ **The Customize Sheet**

For most users, the Edit Chart Style sheet provides sufficient choices for changing the way a chart looks. However, they do not represent the complete range of style choices, so we include a third Edit Chart sheet, the **Customize** sheet.

While there are different Style sheets for each type of chart, there is only one Customize sheet. With one exception, each item on the Customize sheet corresponds to an item on the Style sheet. The Customize sheet offers a far greater range of settings for these items.

If, for example, you want major hash marks that are between the shortest and the second shortest hash marks and thicker than the thickest width represented on the Style sheet, you cannot choose these settings on the Style sheet. However, you can experiment by entering different values on the Customize sheet and have hash marks exactly the length and width you want.

Use the Customize sheet only after you are very familiar with the Style sheet and have exhausted its possibilities. The descriptions of Customize sheet items assume that you know how to use corresponding Style sheet items.

#### To open the Customize sheet:

- ✓ Point the mouse cursor into the Customize box in the Edit Chart sheet header, and click the **middle** button.

*You will see a stickup asking you to confirm that you want to open the Customize sheet (Figure 29-1).*

- ✓ Point the cursor at the Yes box and click the **left** button. Figure 29-2 shows the Customize sheet.

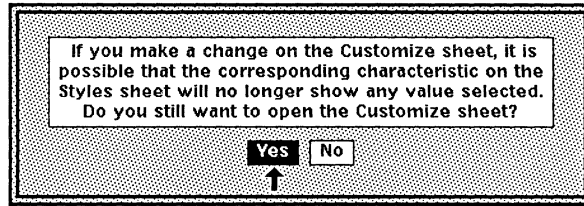

Figure 29-1. The Chart Customize stickup

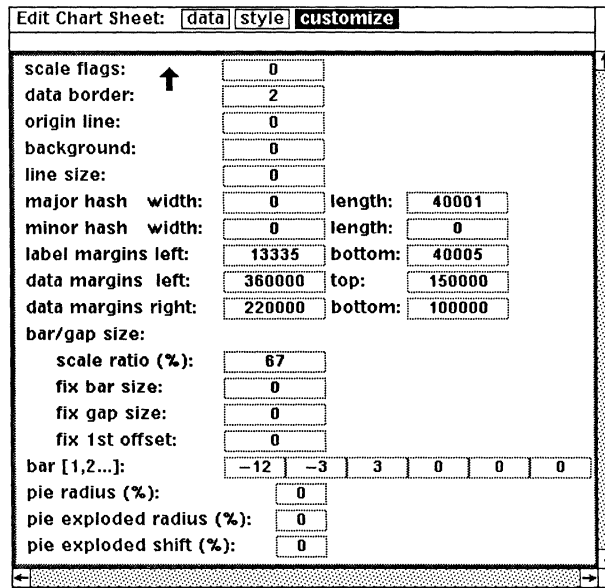

Figure 29-2. The Customize sheet

You have to confirm this process only once during an editing session. When you have access to the Customize sheet for one chart, you have access to every Customize sheet until you exit from the Interleaf publishing software.

## How Changes are made on the Customize Sheet

To change the appearance of your chart by using the Customize sheet, you must modify a numeric value on the Customize sheet. Values on this sheet are represented in one of three different units of measurement, depending on the property. The units of measurement, *ridiculously small units (rsu's)*, *percentages (%)*, and *twelfths*, are described in the following sections.

---

The *scale flags* option, first introduced on the Customize sheet, is not measured in any of the units described. See the explanation of scale flags for details.

---



## Entering Information by Changing RSU Values

The values for many of the properties on the Customize sheet are expressed in terms of what we call **ridiculously small units** (or *rsu*'s). One chart rsu is equivalent to one millionth of an inch. To better understand the value of an rsu, you may want to experiment with the numbers you enter. You can, however, limit the area of experimentation as Figure 29-3 shows.

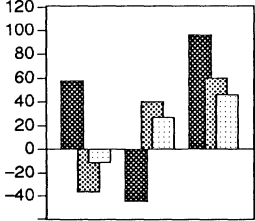

The major hash marks for this chart are represented on the Style sheet by these icons:

major hash: 

and on the Customize sheet by these numeric rsu values:

major hash width:  length:

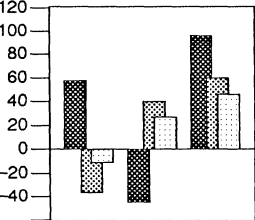

The major hash marks for this chart are represented on the Style sheet by these icons:

major hash: 

and on the Customize sheet by these numeric rsu values:

major hash width:  length:

If you want major hash marks that are longer than the ones in the top chart but shorter than the ones in the bottom chart, you can find out the appropriate range of values by subtracting 40001 from 93333 (53332). Then, if you want marks with a length exactly between the lengths in these two charts, you can divide 53332 by 2, add the result (26666) to 40001, and type this result (66667) into the length box on the Customize sheet. The chart below has the customized hash marks.

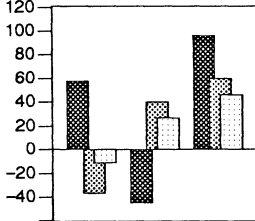

Only the width of the major hash marks for this chart is represented by an icon on the Style sheet because the value of the length no longer corresponds to the value of an icon:

major hash: 

Both the width and length are represented by numeric rsu values on the Customize sheet:

major hash width:  length:

Figure 29-3. How to use the Customize sheet

---

For there to be even a *tiny* noticeable change in printed copy, you must add or subtract at least 3500 rsu's from the current value on the Customize sheet. Because of the difference between the resolution of the screen and the printer, fine-tuning changes that will affect printed copy may not be visible on the screen.

---

Before modifying the numeric values of items on the Customize sheet, you need some reference points and a sense of the value of a ridiculously small unit. When describing each item on the Customize sheet, we provide the numeric equivalent of icons you can select on the Style sheet.

For all items expressed in rsu's, the numeric value 2 represents the thinnest line that looks good on the output device. The actual width of that line depends on the resolution of the printer used.

### Changing RSU Values by Clicking

Remember that you can change some of the information on the Style sheet by pointing the mouse cursor at the appropriate icon and clicking the *left* and *right* buttons to alter the size of something, usually a margin. The *data margins* settings are an example of information that is registered in this way (Figure 29-4)

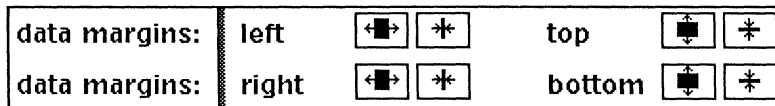

Figure 29-4. Data margins boxes

Pointing the mouse cursor into the *left* box [←] and clicking the *left* or *right* button increases the numeric value of that item on the Customize sheet, while pointing the mouse cursor into the *right* box [→] and clicking the *left* or *right* button decreases the numeric value of that item. Figure 29-5 summarizes the changes in rsu values that occur when you point the cursor at these types of icons and click the left or right button. One *left* button click equals approximately 19 *right* button clicks.













 	+		Adds 253329 rsu's to numeric value of the item.
 	+		Adds 13335 rsu's to numeric value of the item.
 	+		Subtracts 253329 rsu's from numeric value of the item.
 	+		Subtracts 13335 rsu's from numeric value of the item.

Figure 29-5. Numeric values of left and right clicks

## Changing Percentages

Four items on the Customize sheet are measured in percentages: *scale ratio*, *pie radius*, *pie exploded radius*, and *pie exploded shift*. Percentage values must be expressed as whole numbers. For all but *pie exploded shift*, you can enter values ranging from 0 through at least 9999. The numeric value of *pie exploded shift* can range from 0 through 100. For all four, negative numbers are the equivalent of 0.

## Changing Twelfths

The Customize sheet contains one set of items where the values are measured in twelfths. In other words, 12 (read as  $\frac{1}{12}$ ) is the equivalent of 100%. For a fuller explanation of the use of twelfths, please refer to the description of item *bar [1,2,...]* in the following section.

## Properties on the Customize Sheet

Individual properties found on the Customize sheet are described below in the order they appear on the Customize sheet.

**Scale flags.** This is the only item on the Customize sheet that does not correspond directly to an item on the Style sheet.

By default, when you place a diagramming object over a chart, and then group and size the object with the chart, the object does not size in exact proportion to the chart. By changing the *scale flags* setting, you can specify that you want overlaid objects that you have grouped with the chart to size in proportion to the chart. In addition, you can control whether line thicknesses for items such as the data border, hash marks, and background remain fixed or change in proportion to the size of the chart.

The default setting for scale flags is 0. You can change the setting to any number from -32768 through 32767 and affect the appearance of your chart. However, the documented values are 0, 15, and -1. When you enter 15, the grouped diagramming objects size in proportion to the chart but the line thicknesses remain

fixed regardless of the size of the chart. When you enter  $-1$ , the grouped diagramming objects and the line thicknesses size in proportion to the chart. If you want to know more about other scale flag settings, contact Interleaf Customer Support.

Scale flags is most useful when you are creating a large chart that you want to reduce afterwards. Note that when you change the scale flag setting for a chart, often you will need to adjust the data margins and label margins to make the labels fully visible. When you adjust the margins, the size of the data area changes. For this reason, be sure to change the scale flag setting *before* creating, overlaying, sizing and grouping diagramming objects with the chart. Also note that the font size does not scale with the rest of the chart, so you must be sure to change the font size to suit the chart size.

To illustrate the application of scale flags, we will show you how to create and size a Dow Jones chart (Figure 29-6). A Dow Jones (DJ) chart illustrates three data values for each day: the low, the closing, and the high. A solid bar represents the distance between the high and the low values, and a circle overlaid on the bar indicates the closing value. When creating a DJ chart, we group diagramming objects with the chart to illustrate the data. To modify the chart later, you must modify the data and size or move the corresponding diagramming objects.

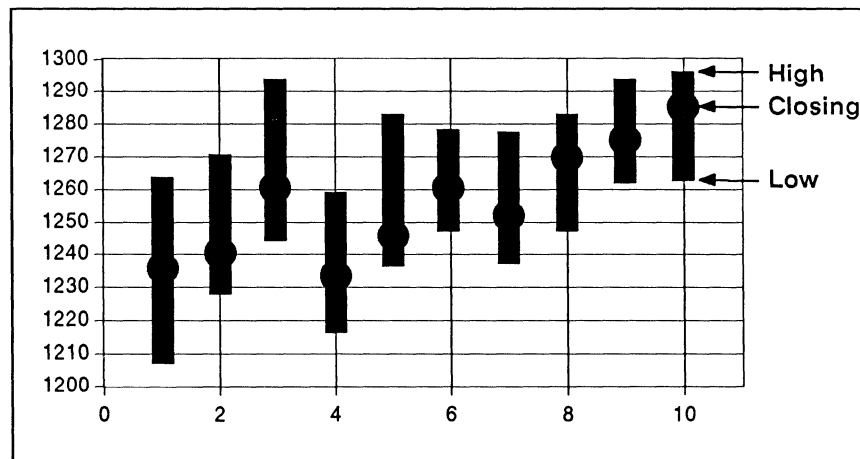





Figure 29-6. Sample Dow Jones chart

To create and size a Dow Jones chart using scale flags:

The chart we create during this exercise reflects data for five days.

- ✓ Open the *Graphics* cabinet, Copy the *ScratchPad* onto your desktop and Open it. Then select and Open the *Charts* folder and the *Lines* document. Cut the scatter chart numbered L5, Paste it into the *ScratchPad*, and Size it to a 3-inch square.
- ✓ Select the chart and reduce the font size to 6 point.  
*The font size does not scale with the rest of the chart.*
- ✓ Select the chart again and using the **Props Edit** command select the Edit Chart Style sheet.
- ✓ On the Style sheet select the following icons: the second *data border* icon from the right , and the thinnest *major hash* mark width setting . Do not change the settings for *major hash length*  or *line size* . Apply the changes.
- ✓ Select the Data sheet and erase all data. Scale the vertical and horizontal axes by entering the values shown in Figure 29-7.



vertical axis: minimum		370	maximum		620	
horizontal axis: minimum		0	maximum		6	
x line 1 		▲ line 2 		+ line 3 		x
	hor	ver	hor	ver	hor	ver
1	1	390	1	412	1	500
2	2	400	2	453	2	525
3	3	475	3	499	3	560
4	4	435	4	540	4	600
5	5	410	5	510	5	575

Figure 29-7. Data sheet with axis scaled and data entered

The chart you are creating reflects the data for five days. The first column represents the daily low, the second column represents the closing, and the third column represents the daily high.

- ✓ Turn off box 6 on the left side of the sheet. In *hor(izontal)* row 1 of line 1 enter the number 1. In *hor* row 2 of line 1 enter the number 2. Answer the questions on the sheet to automatically fill in the horizontal values so that they have the same value and increment. Enter the vertical values as shown in Figure 29-7 and **Apply** these changes.

- ✓ Select the Customize sheet and at the scale flags field enter the value of 15 or -1.

*If you enter the value 15, the line thicknesses you set when the chart is the original size will not change as you size the chart. If you enter the value -1, all line thicknesses scale in proportion to the size of the entire chart. If your line thickness settings are for thin lines, the lines may disappear altogether, in which case you must select thicker settings.*

- ✓ After you change the value of scale flags, you must adjust the data margins. If you are planning to reduce the size of the chart considerably, make the data margins fairly wide. You may also want to adjust the label margins.

*If you have difficulty achieving the desired affect with your margins and your chart contains hash marks, try reducing the size of the hash marks. If this does not solve the problem, you may want to turn the label display off and create labels manually.*

- ✓ Turn off Gravity and GridAlign.

- ✓ **Create** a **Box** inside the chart and **Size** it to form a thin, rectangular bar that runs vertically and covers the area from the center of the high point (+) to the center of the low point (x) on the vertical coordinate 1 (see Figure 29-8). **Duplicate** this box, and **Move** it and **Size** it to cover the high and low points at each of the four remaining vertical coordinates.

- ✓ Next **Create** an **Oval**, **Size** it **Diagonally** so that it is nearly twice as wide as the bar, and position it over the point representing the closing value (▲) for vertical coordinate 1. **Duplicate** and overlay the oval on the closing value point (▲) for each of the four remaining vertical coordinates. Select all of the overlaid diagramming objects and **Fill** with black.

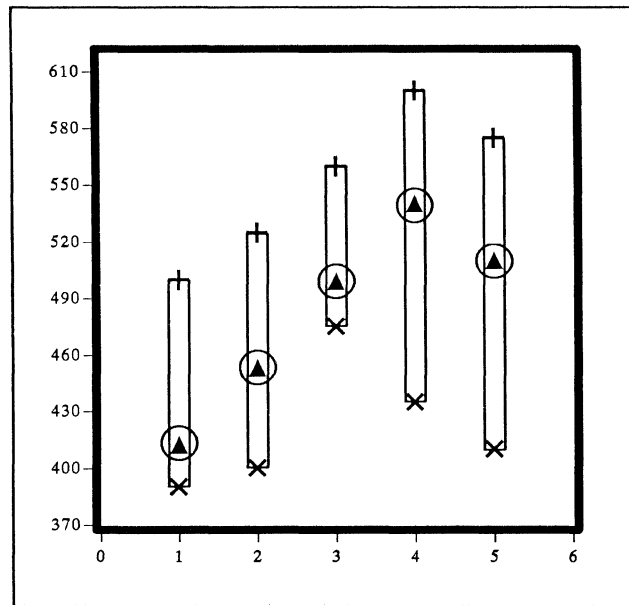

Figure 29-8. Chart with overlaid diagramming objects before they have been filled with black

- ✓ Select the Style sheet and remove the points by changing the *points* setting from points  to line .
- ✓ Select the chart and the overlaid object(s) and **Group** them.
- ✓ Select the chart again, **Duplicate** it, and **Size** the duplicate to a 2 in. square.

Figure 29-9 through Figure 29-12 illustrate the results when scale flags is set to 0, 15, and -1.

When the setting is 0, the diagramming objects grouped with the chart do not size to scale with the chart data. In Figure 29-9 the diagramming objects in the reduced chart do not represent the data accurately. For example, the first DJ bar in the original chart shows a low value of 390, but in the reduced chart the value appears to be about 375. In addition, the objects in the reduced chart have shifted and do not appear directly above their horizontal labels.

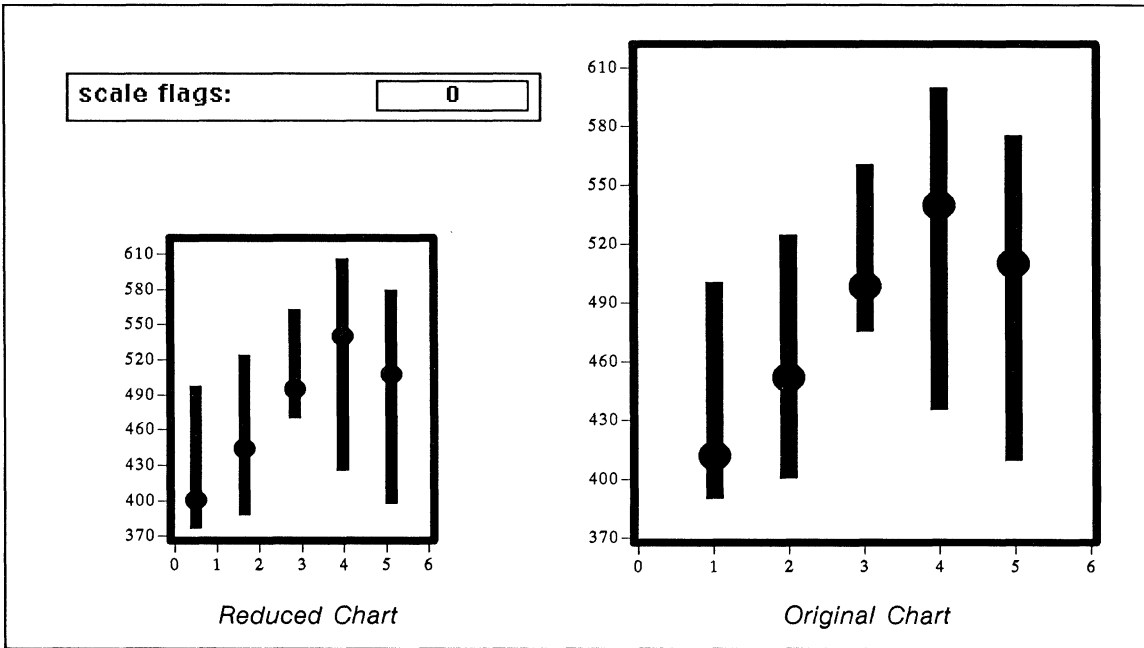

Figure 29-9. DJ chart reduced with scale flags set to 0

When the setting is 15, the objects scale in proportion to the chart data and retain their relative positions (Figure 29-10). The lines (i.e., data border and hash marks) in the smaller chart retain their original thickness as they do with the 0 setting above.

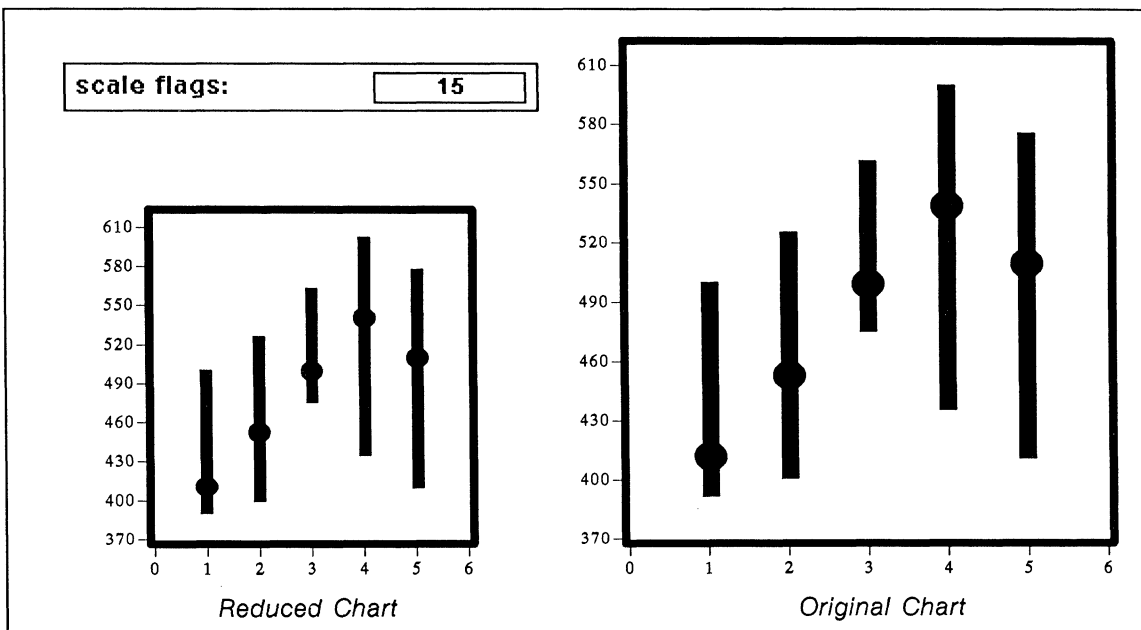

Figure 29-10. DJ chart reduced with scale flags set to 15



When the setting is  $-1$ , the objects scale in proportion to the chart data and retain their relative positions (Figure 29-11). However, this setting changes the appearance of line thicknesses on the original chart. Note that hash marks disappear.

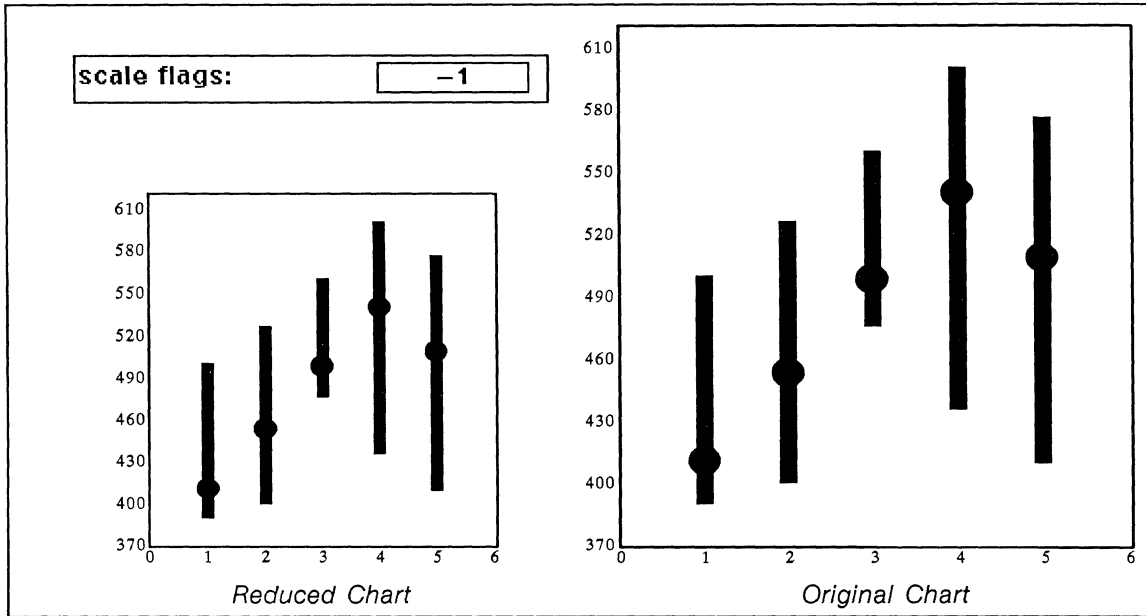

Figure 29-11. DJ chart reduced with scale flags set to  $-1$

In Figure 29-12 we increased the size of the data border and major hash marks on the Customize sheet. When we reduced the chart, the line thicknesses (i.e., data border and hash marks) also scaled in proportion to the chart size.

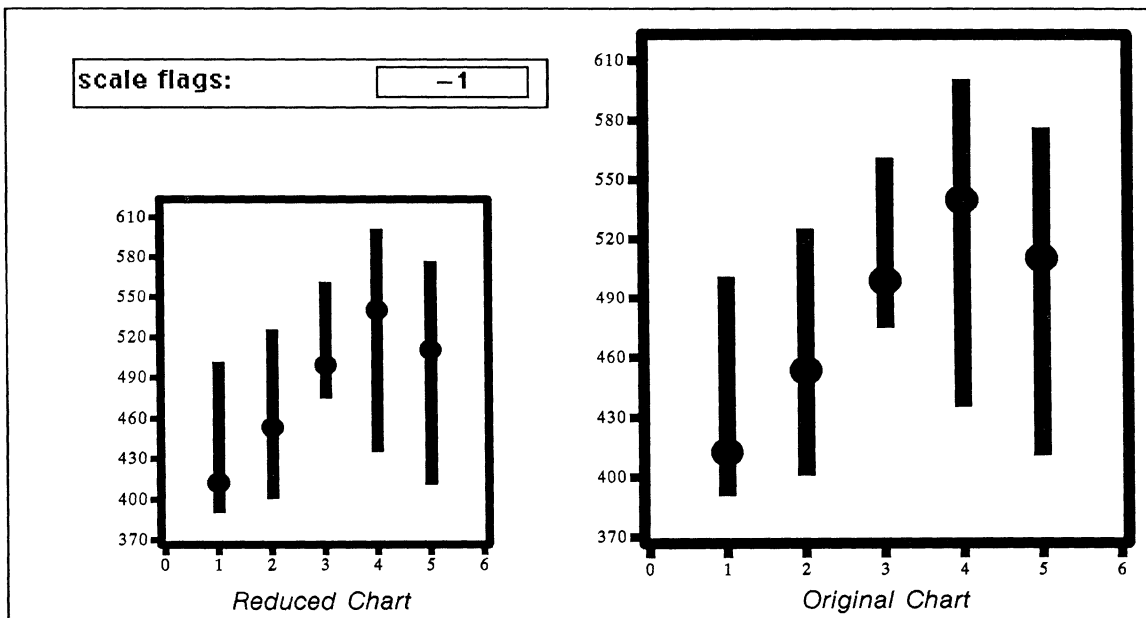

Figure 29-12. Chart reduced after increasing size of data border and hash marks

**Data border.** On the Style sheet you can select one of six icons to determine the thickness of the border around the data. Each of these icons represents an rsu value on the Customize sheet (Figure 29-13). To produce a thicker data border or one that falls between the settings offered on the Style sheet, modify the value of *data border* on the Customize sheet.

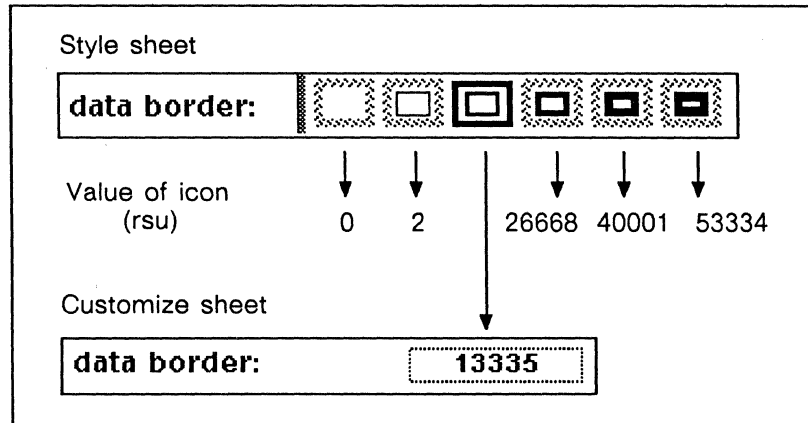

Figure 29-13. Numeric value of data border icons

**Origin line.** On the Style sheet for a line or bar chart you can select one of six icons to determine the thickness of the origin line. Each of these icons represents a rsu value on the Customize sheet (Figure 29-14). To produce a thicker origin line or one that falls between the settings offered on the Style sheet, modify the value of *origin line* on the Customize sheet.

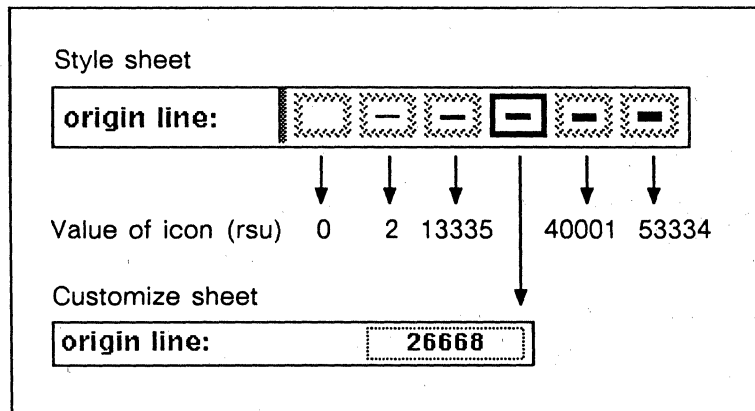

Figure 29-14. Numeric value of origin line icons

**Background.** On the Style sheet for a line or bar chart you can select one of six icons to determine the thickness of background lines. Each of these icons represents an rsu value on the Customize sheet (Figure 29-15). To produce thicker background lines or ones with a thickness not available through the Style sheet, modify the numeric value for *background* on the Customize sheet.

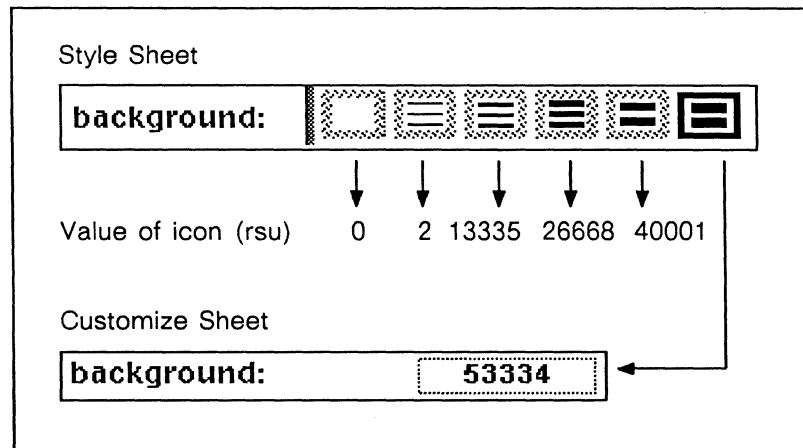

Figure 29-15. Numeric value of background icons

**Line size.** On the Style sheet for a line chart you can select one of six icons to determine the thickness of the data lines. Each of these icons represents an rsu value on the Customize sheet (Figure 29-16). To achieve more subtle variations or greater thicknesses, modify the value of *line size* on the Customize sheet.

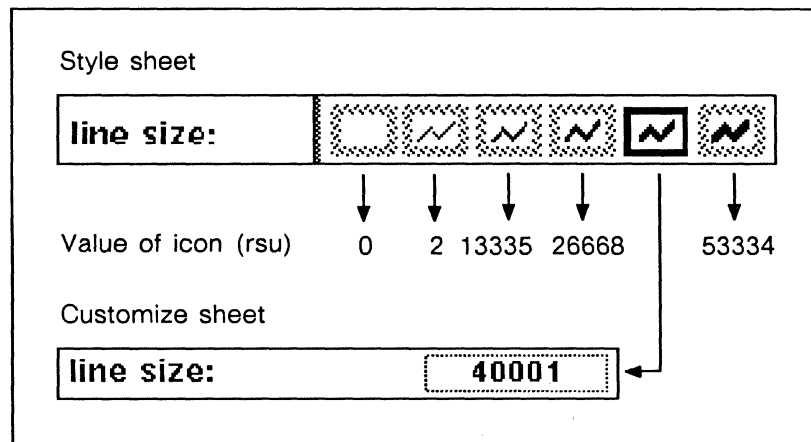

Figure 29-16. Numeric value of line size icons

**Major hash/minor hash.** On the Style sheet for a line or bar chart you can select four of sixteen icons to determine the length and thickness of major and minor hash marks. Each of these icons represents a rsu value on the Customize sheet. The values available on the Style sheet for minor hash are the same as those shown for major hash in Figure 29-17. To produce more varieties of hash marks, modify the numeric values for *major* and *minor hash width* and *length* on the Customize sheet.

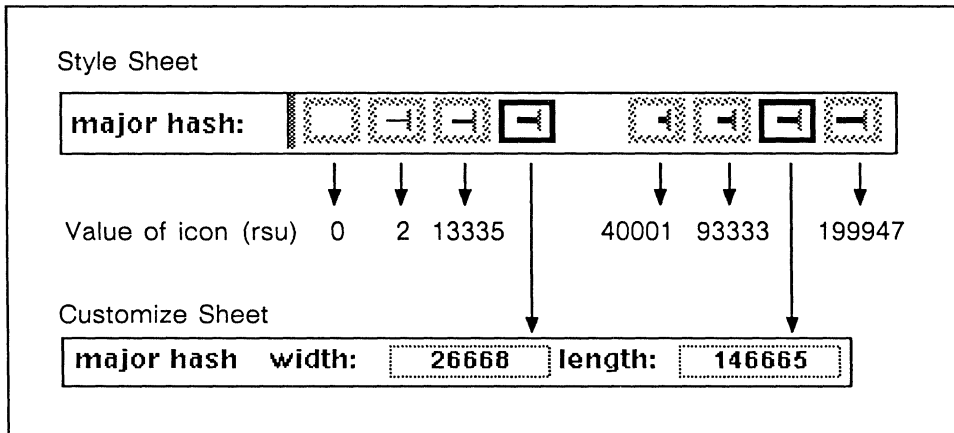

Figure 29-17. Numeric value of hash mark icons

**Label margins.** On the Style sheet you can increase or decrease the size of the label margins by pointing the mouse cursor at one of the four label margin icons and clicking the right or left button. Each click represents a change in the numeric value of that margin on the Customize sheet. (For details on the numeric value of each click, see Figure 29-5.) Figure 29-18 shows the label margin portion of both the Style and Customize sheets. To produce more subtle variations in label margin widths, modify the value of the appropriate *label margin* on the Customize sheet.

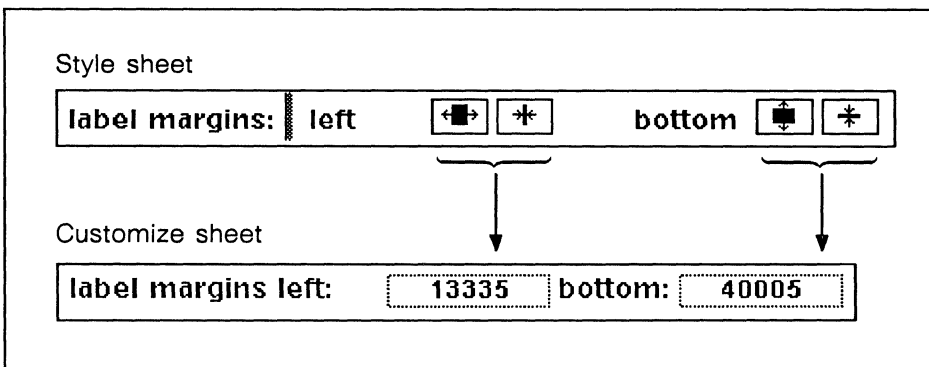

Figure 29-18. Numeric value of label margins

**Data margins.** On the Style sheet you can increase or decrease the size of the data margins by pointing the mouse cursor at one of the eight data margin icons and clicking the right or left button. Each click represents a change in the numeric value of that data margin on the Customize sheet. (For details on the numeric value of each click, see Figure 29-5.) Figure 29-19 shows the data margin portion of both the Style and Customize sheets. To produce more subtle variations in data margin widths, modify the value of the appropriate *data margin* on the Customize sheet.

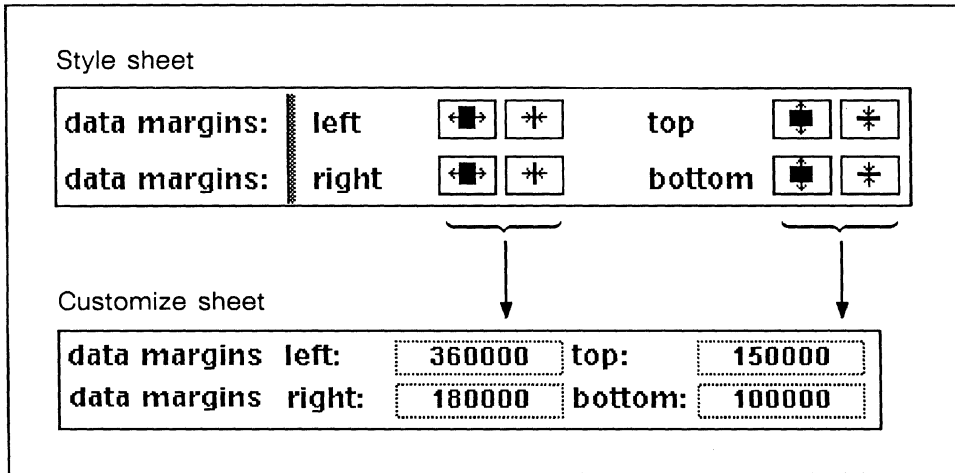

Figure 29-19. Numeric value of data margins

**Bar/gap size.** The *scale* and *fix* options on the Customize sheet help you size the bars and position the sets of bars the distance you want them from other sets of bars. Before modifying any of the four *bar/gap size* options on the Customize sheet, you must choose the appropriate setting, *scale* or *fix*, on the Style sheet. Otherwise, when you apply new values they do not affect the appearance of your chart.

When you want to adjust the scale of the bars and gaps, select *scale* on the Style sheet and you can modify *scale ratio* on the Customize sheet. When you want to fix the size of the bars and gaps, select *fix* on the Style sheet and you can modify *fix bar size*, *fix gap size*, and *fix 1st offset* on the Customize sheet. Before modifying any of the four *bar/gap size* options on the Customize sheet, check to be sure you have chosen the appropriate setting on the Style sheet.

**Scale ratio.** When you select the *scale* option on the Style sheet, you can select one of six icons. Each of these icons represents a numeric value expressed in percentages on the Customize sheet (Figure 29-20). The numeric value represents the percentage of the gap width to the bar width.

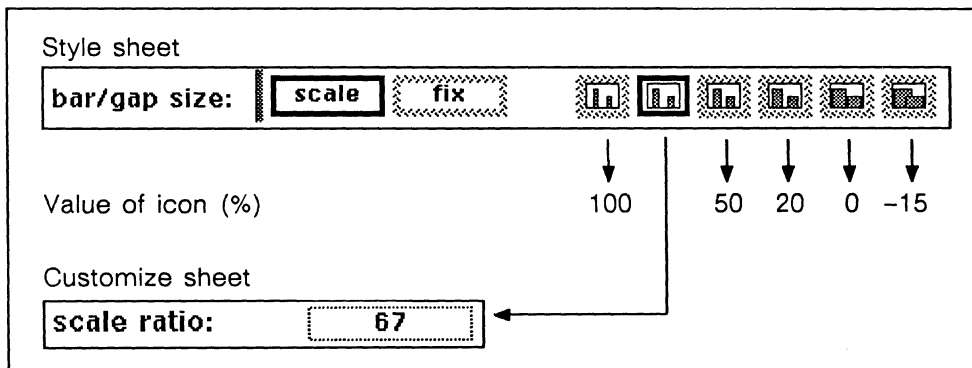

Figure 29-20. Numeric value of scale icons

In Figure 29-20, the selected icon indicates that the gap width is 67% of the bar width. To adjust the bar/gap scale to a percentage not offered on the Style sheet, use the *scale ratio* on the Customize sheet. For example, if you want the gap width to be 80% of the bar width, enter 80 as the *scale ratio*.

**Fix.** When you select the *fix* option on the Style sheet, you can independently adjust the size of the bars, the size of the gaps, and the distance between sets of bars by pointing the cursor at one of the six icons and clicking the right or left button. As described in *Changing RSU Values By Clicking*, on the Style sheet you can increase and decrease *bar/gap size* and distance by 253329 and 13335 rsu's by clicking the left and right buttons, respectively. If you want to make slight or very large adjustments to the bar/gap size, you can enter new values to *fix bar size*, *fix gap size*, and *fix 1st offset*.

For each new default chart you create (using the **Chart** command on the Create Misc submenu of the Diagramming Nothing Selected popup menu), the default value of the three fix items is 0 (Figure 29-21). Any adjustment of one value does not affect the other two values.

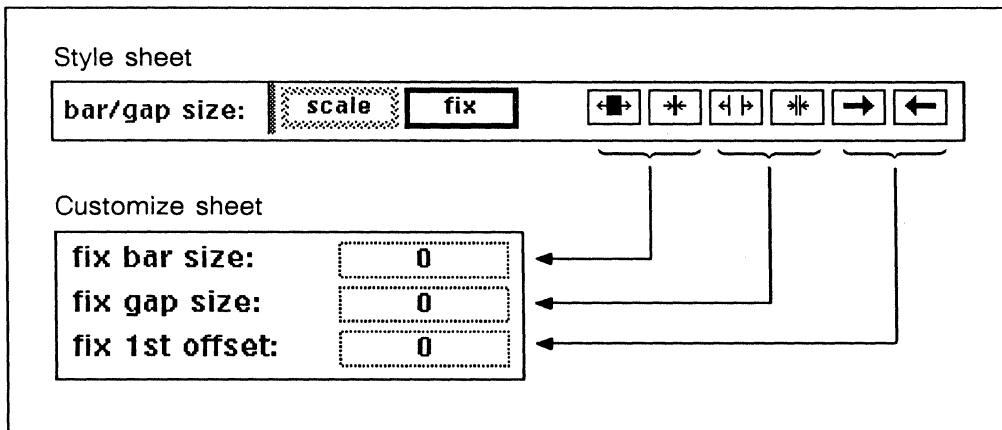

Figure 29-21. Numeric value of fix options

**Bar [1,2,...].** On the Style sheet for bar charts you can control the placement of each bar in relation to the other bars in the same set. For each bar in a set, you can choose one of nine icons to represent the placement of that bar in relation to the others. Bar placement settings are expressed in twelfths. As shown in Figure 29-22, each icon represents a multiple of  $\frac{1}{12}$ .

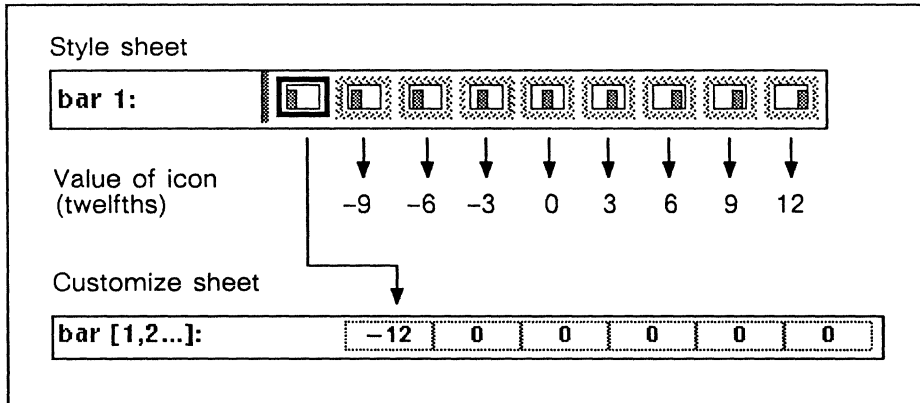

Figure 29-22. Numeric value of bar placement icons

Since each bar is 12 units wide, any two bars placed within 12 units of each other will overlap. For example, in Figure 29-23 *bar 2* overlaps *bar 1* by 75% because they are positioned 3 units apart (-12 and -9), and *bar 3* overlaps *bar 2* by 25% because they are positioned 9 units apart (-9 and 0).

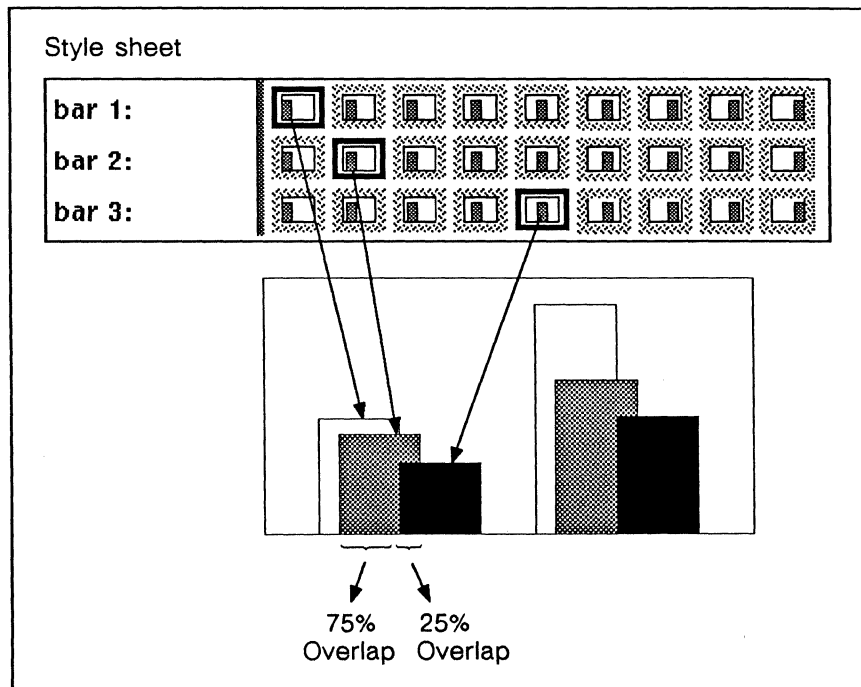

Figure 29-23. Selecting Style sheet icons to position bars

In some situations you may find the options offered on the Style sheet too limited, in which case you can control bar placement by editing the Customize sheet. For example, by selecting three icons on the Style sheet you can place three bars side-by-side without overlapping them (Figure 29-24). However, if you add a fourth bar, the Style sheet does not offer enough icons to position four bars side-by-side without overlapping.

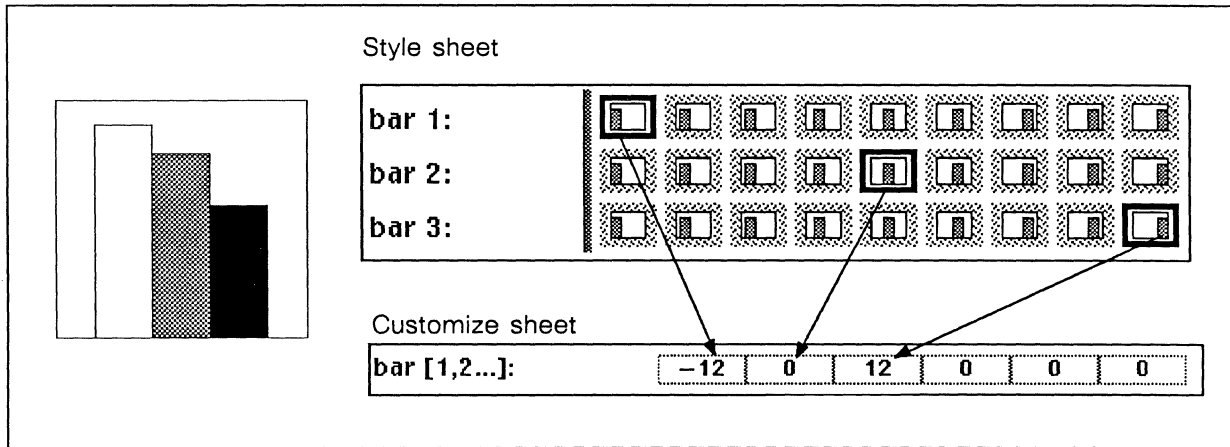

Figure 29-24. Numeric value of icons for placement of three bars

To overcome this, you could specify the placement of the fourth bar by editing the Customize sheet (Figure 29-25). Since each bar is 12 units wide, you would enter either 24 (to position bar 4 to the right of bar 3) or -24 (to position bar 4 to the left of bar 1) as the numeric value in the fourth field. For each new bar that you add, you could place the bar in a non-overlapping position by entering the associated bar placement value in an increment (or decrement) of 12 (e.g., 36, 48, 60 and -36, -48, and -60).

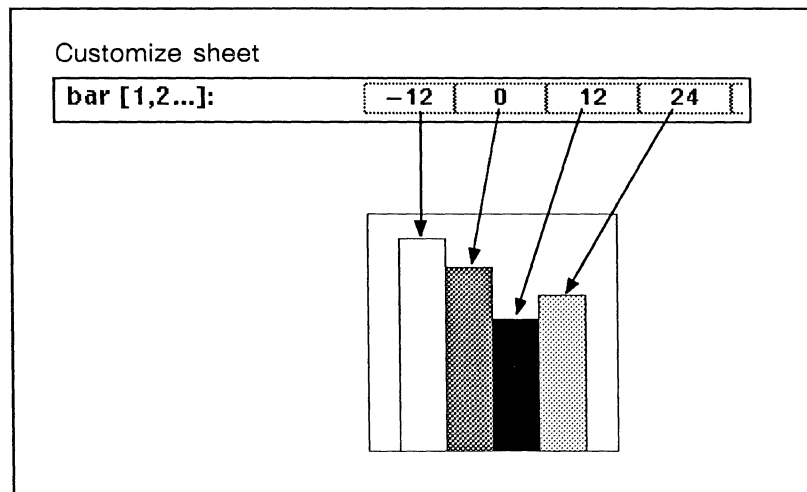

Figure 29-25. Controlling bar placement by using the Customize sheet

You can also use the Customize sheet to specify bar overlap in  $\frac{1}{2}$  increments (e.g., 1, 2, 3,...) rather than the  $\frac{3}{2}$  increments (e.g., 3, 6, 9) available on the Style sheet. In each *bar [1,2,...]* field, you can enter any whole number within the range -999 to 9999. Note that as you increase the distance between the left-most and right-most bars in a set, the bars will decrease in size to accommodate the increased range.



**Pie radius.** On the Style sheet for a pie chart you find options enabling you to control the size of the radius of the whole pie (Figure 29-26). You can select one of the following pie radius values: 80, 90, 100, and 115 (%). To produce a pie chart with a different radius, modify the value of *pie radius* on the Customize sheet. You can enter numbers from 0 through 9999, although a pie chart with a radius beyond 200% usually is not meaningful. Negative numbers and 0 are the equivalent of 100.

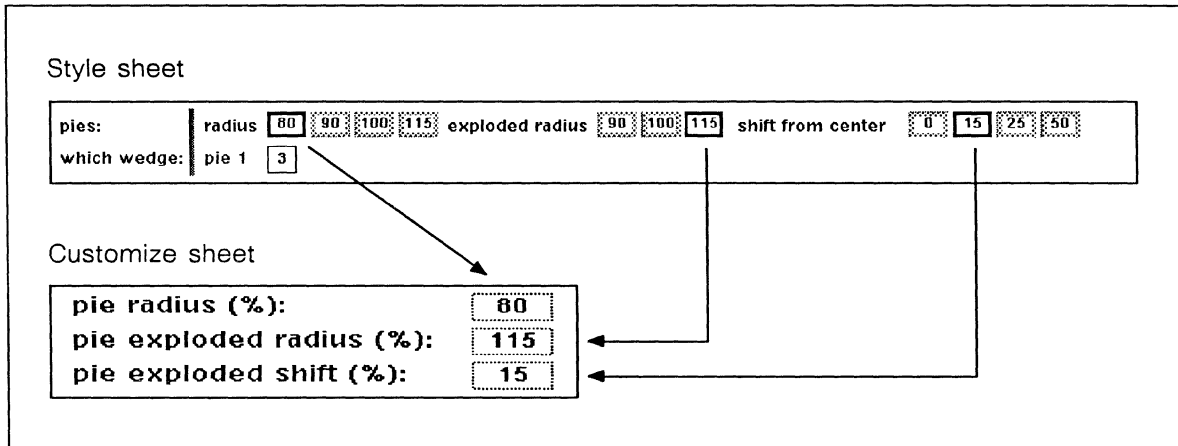

Figure 29-26. Properties of pie charts

**Pie exploded radius.** On the Style sheet you can select exploded radius values of 90, 100, and 115 (%). To produce a pie chart with a different exploded radius, modify the value of *pie exploded radius* on the Customize sheet. You can enter numbers from 0 through 9999, although a pie chart wedge with a radius beyond 200% usually is not meaningful. Negative numbers and 0 are the equivalent of 100.

**Pie exploded shift.** On the Style sheet you can select shift from center values of 0, 15, 25, and 50 (%). On the Customize sheet you can modify the value of *pie exploded shift* with any value from 0 through 100. Negative numbers and numbers beyond 99 are the equivalent of 0.

## Combining Charts with other Diagramming Objects

The chart in Figure 29-27 was created using the chart-making facility as well as other features of the diagramming system. This is a very simple example of what you can do to combine charts and graphics, and it uses only shapes that are available in the *Graphics* cabinet.

You can make a much more graphically sophisticated chart by creating some shapes of your own to portray your company's products. For example, if your company manufactures automobiles and trucks, you can create models of these and use them in place of our shapes.

In the following sections, we describe how this chart was created using the techniques that have been discussed in this chapter and how diagramming objects were used to turn the data-driven chart into the chart in Figure 29-27.

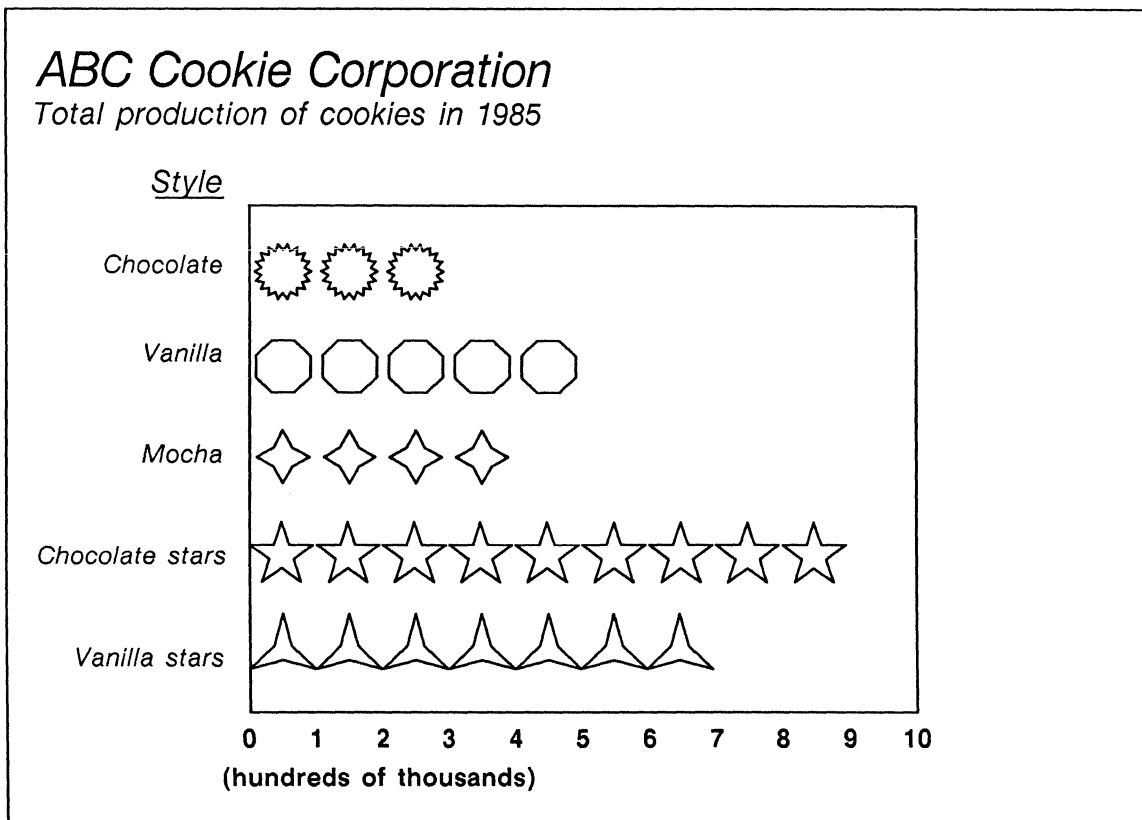

Figure 29-27. A chart with graphic objects

## How to Use Diagramming Objects with a Chart

The chart in Figure 29-27 began as a simple bar chart (Figure 29-28). You can find this chart in the *Bars* document in the *Charts* folder of the *Graphics* cabinet on your desktop.

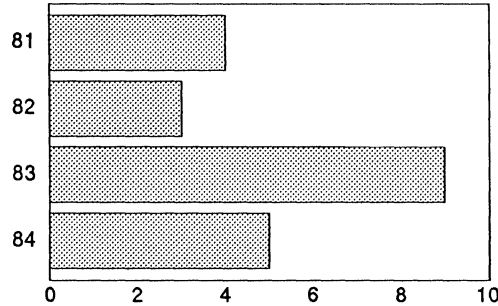

Figure 29-28. Chart B9 from the Graphics cabinet

We cut the chart from *Bars*, pasted it in *ScratchPad*, and sized it. The data we want to illustrate have the following form:

Style #	1	300000
	2	500000
	3	400000
	4	900000
	5	700000

To simplify this exercise, we entered the data in smaller units, tens rather than hundreds of thousands. Before typing the data in, we erased the data that was in the original chart. Figure 29-29 shows the chart and its completed Data sheet.

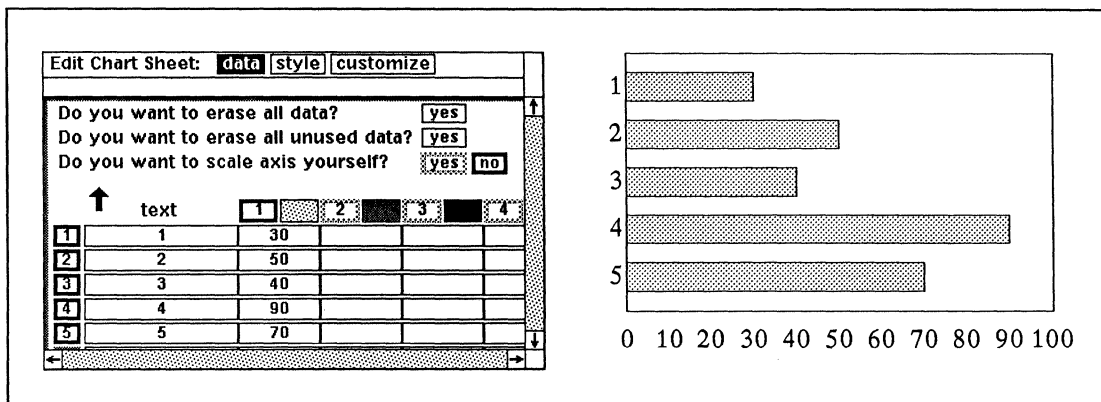

Figure 29-29. Data sheet for chart

**To change the bars to shapes and eliminate bars:**

- ✓ **Open** the *Shapes* folder in the *Graphics* cabinet, and **Cut** the shapes you want to use from the *Stars* and *Basic* document.
- ✓ **Paste** the shapes in *ScratchPad*.
- ✓ With **GridAlign** and **Gravity off**, size each shape diagonally, duplicate it, and arrange the shapes over the bars (Figure 29-30).

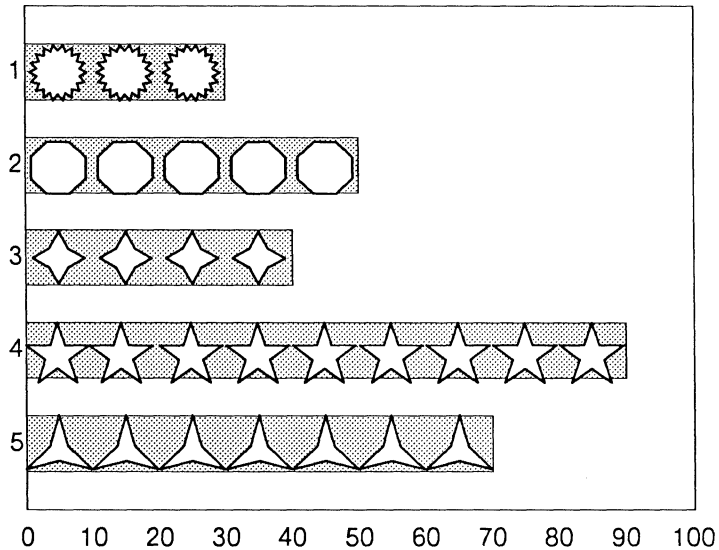

Figure 29-30. Chart with shapes on top of bars

- ✓ **Create** a **Box** the size of the data border, and position it over the data border. Put the box in **Back** of the chart.
- ✓ Select the chart and **Cut** it. The chart will now look like the one shown in Figure 29-31, before the text was added.

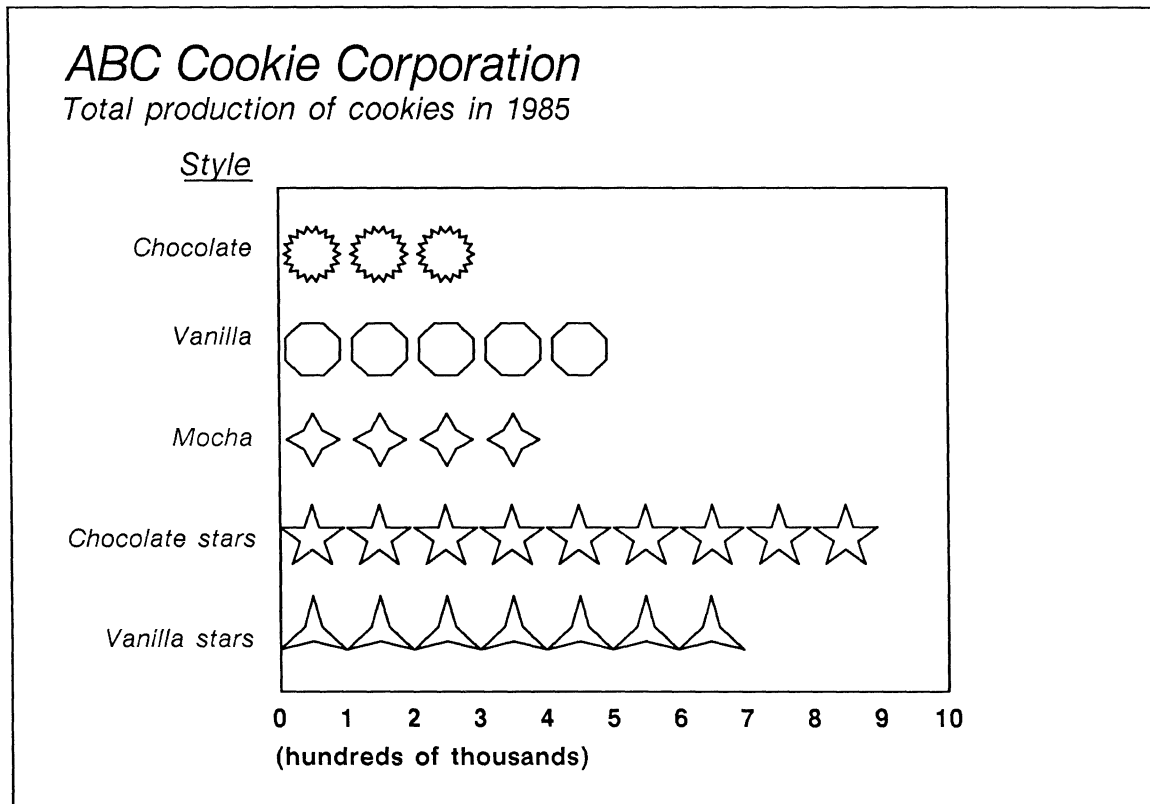

Figure 29-31. Finished chart

The text in the finished chart is in various sizes and weights of the Modern typeface:

- *ABC Cookie Corporation* is 18 point italic.
- *Total production of cookies in 1985* and *Style* are 12 point italic.
- *Chocolate*, *Vanilla*, *Mocha*, *Chocolate stars*, and *Vanilla stars* are 10 point italic.
- The label under the chart is 10 point bold.

The alignment of the text is as follows:

- *ABC Cookie Corporation* and *Total production of cookies in 1985* are flush left text. They were typed in to the right of their final location. After the names of the cookies were entered, these two lines and *Chocolate stars* (the longest cookie name) were selected and aligned on their left sides.
- *Style* and the names of the cookies are flush right text.
- The numbers in the bottom label are centered with tabs between them. After they were entered, they were selected and sized horizontally so that they appear in the proper relationship to the data.

- The label (*hundred of thousands*) is flush left text. After this label was entered, it and the 0 of the data label were left aligned.

## **Sample Chart Combined with Diagramming Objects**

Figure 29-32 shows another sample chart created by adding diagramming objects to a data-driven chart.

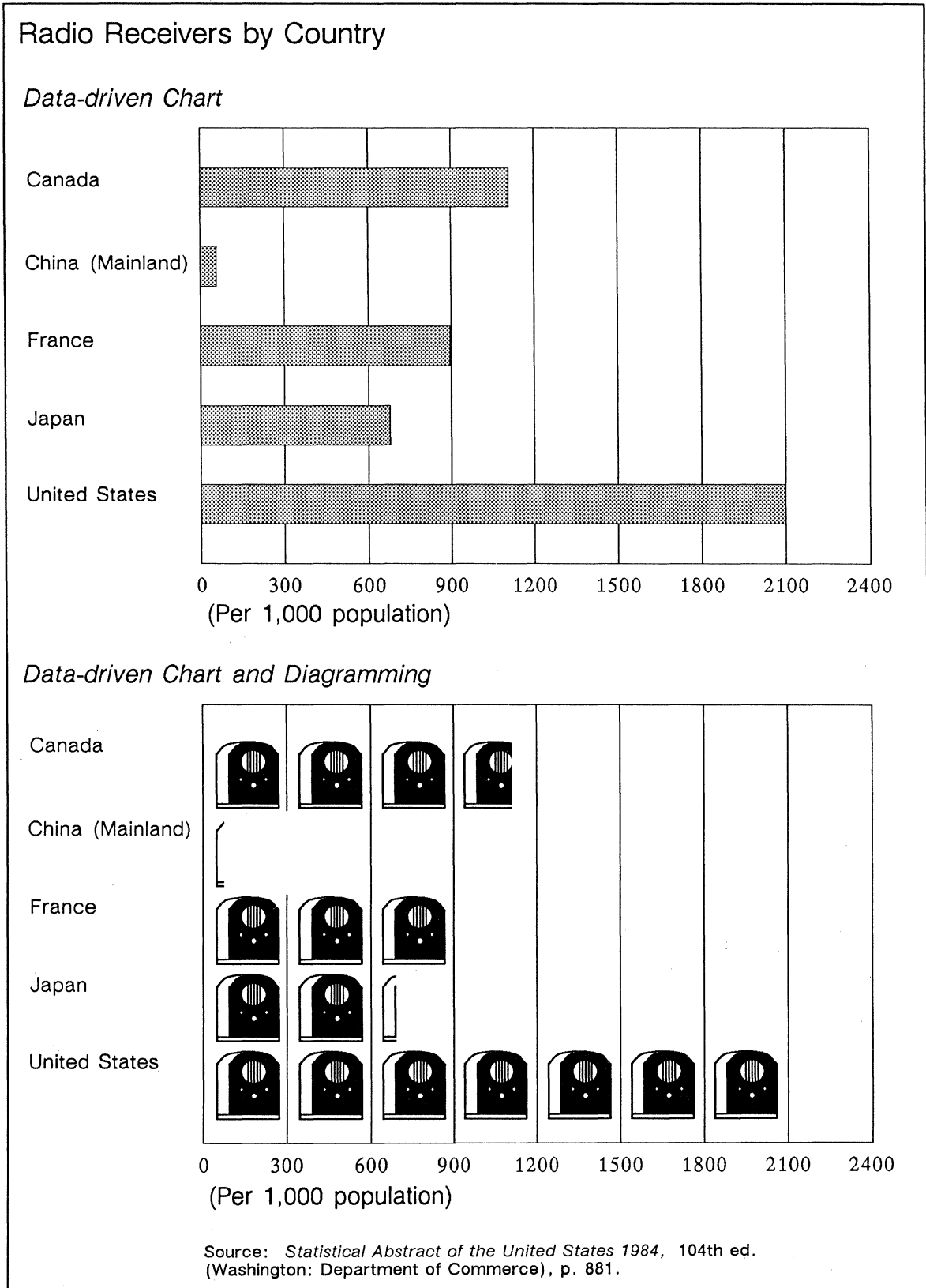

Figure 29-32. Sample chart combined with diagramming objects





---

## Chapter 30

# Printing

This chapter covers the following topics related to printing documents in the Interleaf publishing software.

- Printer property sheet
- Print menus
- Printing closed documents
- Printing open documents
- Printerleaf files
- Printing ASCII files
- Orientation and size of pages
- Following a document through the printing process

---

In this chapter, the term *printer* is used to refer to all output devices Interleaf supports. These are listed in the *Printing* document in the on-line *Reference* folder. Detailed information on typesetter options is contained in separate typesetter documentation.

## The Printer Property Sheet

You use the Printer property sheet to determine several things about your printing jobs, including whether or not your document will have a header page, whether or not text attributes (revision bars, for example) will print, and information concerning the output device to which your printing will be sent.

Execute the **Properties** command on the Printer pulldown menu in the document header to gain access to the Printer property sheet (Figure 30-1).

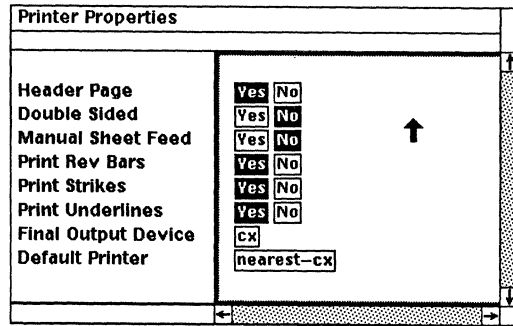

Figure 30-1. Printer property sheet with system defaults

## Header Page

When *Header Page* is turned to **Yes** (the default setting), a page giving details about your document is printed after each printing job. Figure 30-2 shows what the header page for an Imagen cx printer might look like.

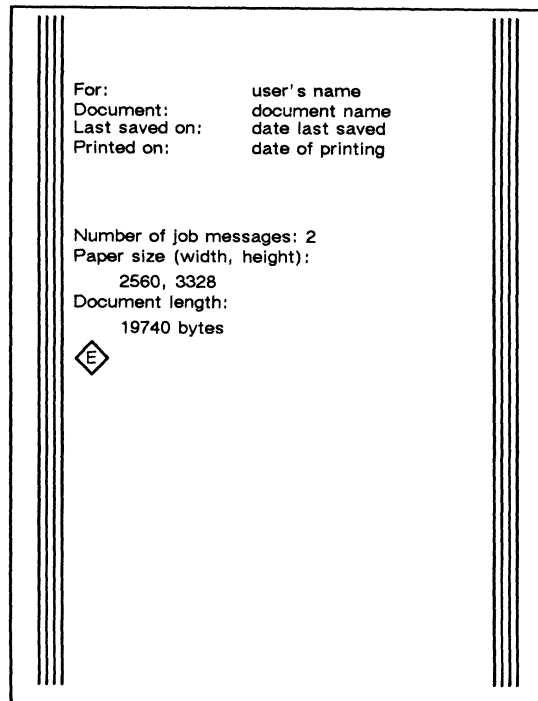

Figure 30-2. Imagen printer header page

The header page information may vary slightly, depending on which version of the publishing software and what particular output device you are using. If you have trouble printing a document on an Imagen printer, Interleaf Customer Support will need the information on the header page of the document to address the problem. The header page is useful to separate jobs from one another at a busy printer, even if you do not need the information on it.

## Double-Sided and Manual Sheet Feed

Double-sided and manual sheet feed printing are available on all the output devices Interleaf supports, except the typesetters. Double-sided printing enables you to save paper and reduce the total size of your document by half. The manual feed feature allows you to insert non-standard paper such as letterhead, envelopes, labels, transparencies, or oversized paper directly into the printer.

Instructions for double-sided and manual sheet feed follow. Be sure to set the property to **Yes** for either *Double-sided* or *Manual Sheet Feed* before you begin using these features.

### Double-Sided Printing

Since instructions for printing double-sided copy on the Interleaf, Imagen and Dataproducts printers are printed on the header page, it is best to have *Header Page* turned to **Yes** until you become familiar with the procedure.

If the paper tray runs out of paper while the printer is printing either side of your job, the paper light will go on, just as it would when any other job runs out of paper. The paper tray indicator will also light up when the printer is ready for you to re-insert your job or begin manual feed.

#### To print double-sided copy:

- ✓ Be sure you have set the *Header Page* and *Double Sided* variables on the Printer property sheet to **Yes**.
- ✓ Execute the printing command of your choice on the Printer pulldown menu.  
*Your job will be sent to the printer.*
- ✓ Check the printer queue to determine when your job is due to print so that you can be at the printer in time to turn over your pages.  
*A timeout occurs on the Interleaf and Dataproducts printers after a period of approximately ten (10) minutes. If you do not turn over your printed pages before the timeout, the printer will continue your job in the single-sided format with odd pages first, even pages last.*  
*If you are printing on the Imagen, no more printing can take place until you flip your job over. Be sure to be at the printer in time to turn your pages over.*
- ✓ Check to see that there is sufficient paper in the paper tray for your job.  
*If the tray cannot hold enough paper for one side of your printing job, stay close by to refill the tray when it runs out of paper.*
- ✓ When your job comes out of the printer, follow the instructions on the header page.

## Manual Feed on the Interleaf, Imagen and Dataproducts Printers

To print documents using manual sheet feed:

- ✓ On the Printer property sheet, turn on **Yes** in the box opposite *Manual Sheet Feed*.
- ✓ Execute the printing command of your choice on the Printer pulldown menu.  
*Your job will be delayed until you actually insert paper.*
- ✓ Be sure the paper tray is in place.  
*Even though you will not be using the paper tray, it must be inserted for your job to print.*  
*When the printer is ready for you to begin manual feed, the paper indicator light will appear.*
- ✓ Insert the paper you want lengthwise into the rear of the cx printer, or sideways into the rear of a dp printer.

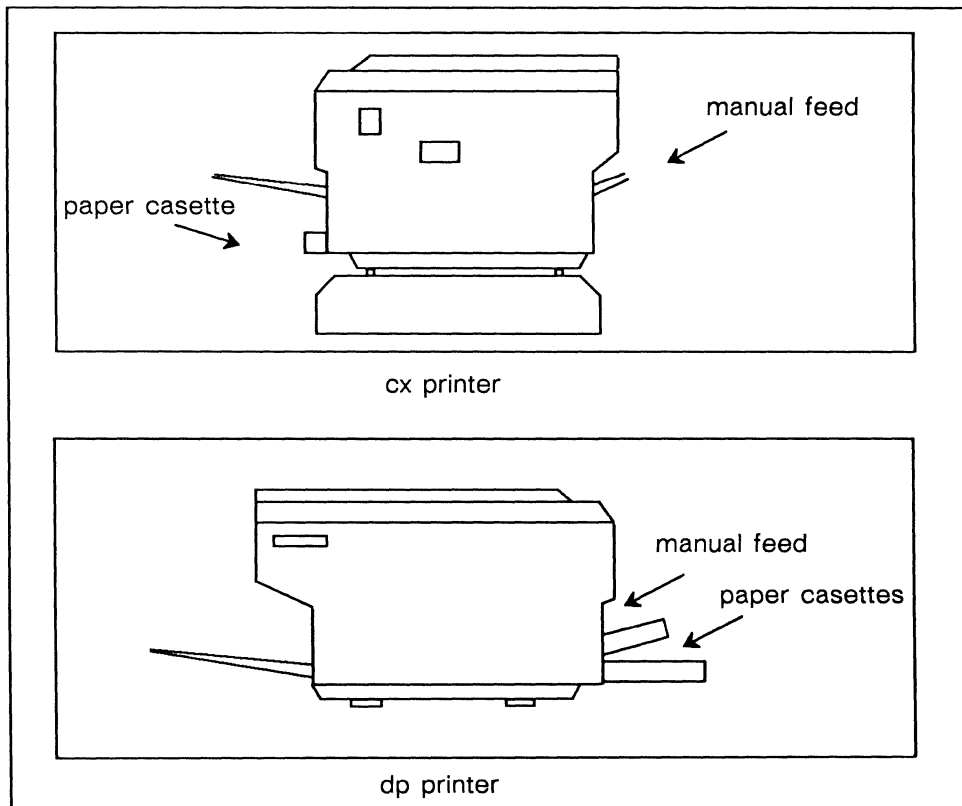

Figure 30-3. Manual feed trays on the cx and dp printers

## Text Attributes

The default setting for *Print Rev Bars*, *Print Strikes* and *Print Underlines* on the Printer property sheet is **Yes**. If you do not want revision bars, strikeovers or underlining in your document to appear in your printed copies, switch on the **No** boxes. (For more information about text attributes, see the chapter *Document Management*.)

## Final Output Device

On both the *Final Output Device* and *Default Printer* settings, the system defaults are set for a cx printer. *Final Output Device* refers to the hardware on which your document will be printed. This setting formats your document and selects the correct font hierarchy for the particular type of output device on which you intend to print.

The *Final Output Device* choices that appear on your Printer property sheet are determined by the output device(s) your company has purchased. If you have only cx printers, **cx** will be the only selection in the box opposite *Final Output Device*. However, you may have other output devices to choose from. If the setting reads **mono**, for example, your document would be formatted and paginated to print on the Lasercomp Monotype. (See Figure 30-4 below.)

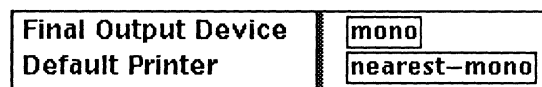

Figure 30-4. Example of a Final Output Device setting

The final output device, as specified on a document's Printer property sheet, determines the format for printing the document in its open state as well as in its icon state on the desktop. For example, if your final output device for an open document is a cx printer, your final output device will be a cx for desktop printing.

To change the final output device setting, scroll through the list box opposite *Final Output Device* on the Printer property sheet until you reach the device you wish to use.

## Default Printer

The default printer information designates the specific printer to which the Printer pulldown menu defaults for an open document. The default setting for *Default Printer* is **nearest-cx** if your company has at least one cx printer.

If there is only one printer to which you can send documents, both **nearest-cx** and the printer name that appears on the Printer pulldown menu will refer to the

same printer. The printer name on the pulldown could be **cx1**, though it could be named anything else.

If your organization has only Dataproducts printers or Lasercomp Monotypes, the *Default Printer* setting will be **nearest—dp** or **nearest—mono**, respectively. The printer name that appears on the Printer pulldown menu will be one of these. (If your company has more than one printer and you are not sure which is your default printer or suspect that it has been changed, you can create a default document and check the *Default Printer* setting on the Printer property sheet for that document.)

There are two situations in which you can use the *Default Printer* setting to your advantage.

*Situation 1:* The meaning of **nearest—cx** changes depending on which cx printer is closest to a particular workstation. Therefore, if your workstation is on a network, you can copy documents to other people's workstations, and the default on their Printer pulldown menu for these documents will be *their* closest cx printer.

Figure 30-5 shows the relationship between the *Default Printer* settings and the default on the Printer pulldown menu.

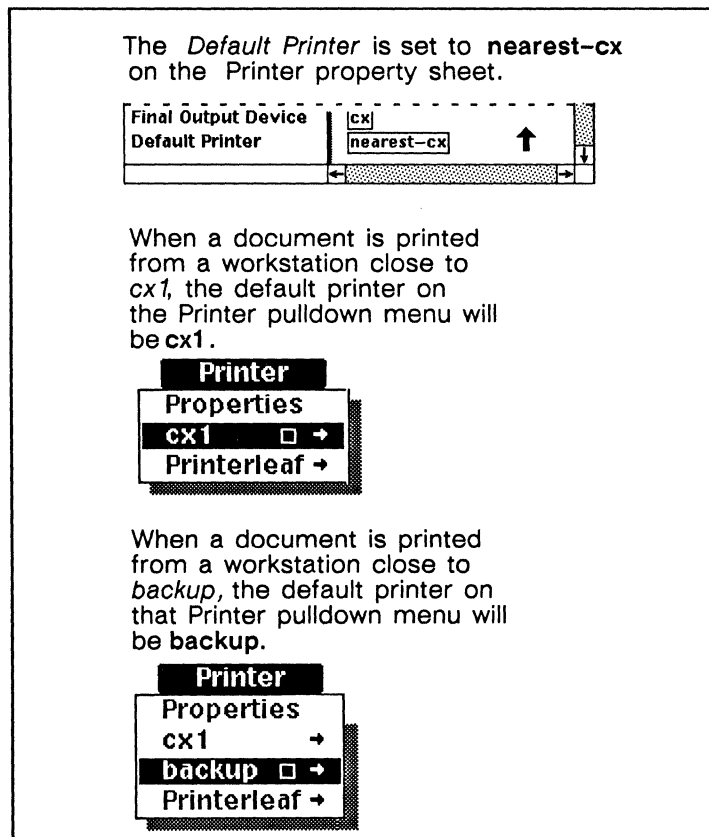

Figure 30-5. Relationship between the *Default Printer* setting and the default printer on the Printer pulldown menu

*Situation 2:* When you can print documents on more than one printer, there may be times when you want to change the default printer for some documents. For example, if your nearest cx is *cx1* and there is a document that you always prepare and print for a department that is closer to *backup*, it will save you or someone else time if you change the default printer for this document from **nearest—cx** to **backup**.

To designate a different default printer if you have more than one printer, scroll through the choices in the box opposite *Default Printer* on the Printer property sheet.

If you want to print a document on a different printer only occasionally, (for example, you might want to use a cx printer for proofing if you are using the Lasercomp typesetter as your final output device) you may not want to change the default printer. Instead, you can use the options on the Printer pulldown menu.

The *Default Printer* setting on the Printer property sheet applies to *open* documents only; there is no default printer for desktop printing.

See your system administrator if you want to change the default printer for all your open documents.

## The Print Menus

There are two ways to access the list of printers available to you. The menu you will use depends on whether you are printing from an open document or from a document icon. The submenu that lists the names of your company's printers in an open document window (Figure 30-6a) is the same as the Print submenu of the Desktop Icon Selected popup menu (Figure 30-6).

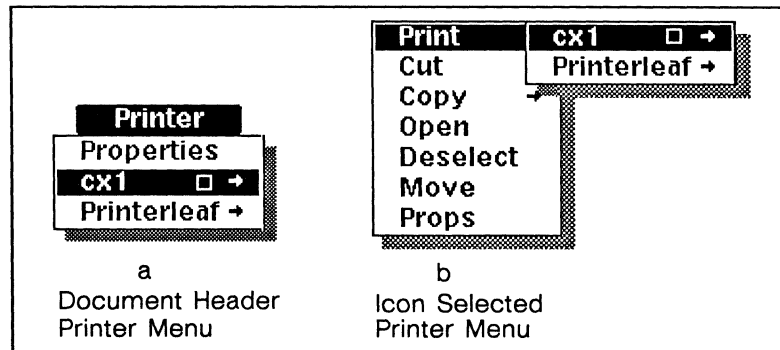

Figure 30-6. The Print Menus

Both of these menus have a submenu on which you can specify exactly what portion of the document you want to print. The default on this submenu (Figure 30-7) is **Document**, the command that allows you to print a single copy of your entire document.

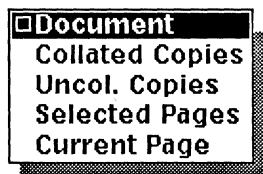

Figure 30-7. Print Copies submenu

You can also choose how many copies of a document you want to print and whether you want them to be collated or uncollated.

When you execute either the **Collated Copies** or **Uncol. Copies** command, only one copy of the document is sent from your workstation to the printer. Then, at the printer, multiple copies of each page are made.

When you choose to print **Selected Pages**, you are asked to type in the range of pages you want to print. These pages must be consecutive. You may print more than one copy of the selected pages. When you print copies of selected pages, the copies are always collated. If you do not specify the number of copies you want printed, one copy of the pages is printed.

In an open document, the **Current Page** command gives you one copy of the page that is registered in the Page box in the document header. When you are printing a publishing software document from the desktop, the current page is the



page on which the editing cursor was located when you saved and closed your document. When you are printing an ASCII document from the desktop, the current page command causes the *first* page of the document to be printed.

## Printing

There are four ways to print Interleaf publishing software documents. You can

- print an unopened document from the desktop, or from inside a directory on the desktop
- print an open document
- create a Printerleaf file and print it from the desktop or from the operating system
- execute the `Save → ASCII` command on a document and then print the document from the operating system.

## Printing Closed Documents

You can print unopened documents using commands on the submenus of the Desktop Icon Selected menu. This feature enables you to print individual documents on the desktop as well as documents inside directories (folders, drawers, cabinets and books) without having to open the documents or the directory that contains them. (See the chapter *Large Documents in Books* for details on printing the contents of books.) You can execute the desktop printing commands while multiple icons are selected. However, if you select documents in more than one *open* directory, the printing commands will affect only the active window.

If you select a directory icon that contains more than one document and you execute the **Print** command, a stickup will appear stating that all of the contents of the directory will be printed and asking you to confirm or cancel the printing. Normally, the order of printing is from right to left. That is, document icons in the lower righthand corner of a directory will be printed before those in the upper lefthand corner. This is particularly useful for printing the contents of a book; the documents are printed so that the finished book is in correct page order. (The order of printing can be random when you print any directory icon that contains 20 or more documents.)

Because desktop printing makes it possible to use one command to print many documents, each of which may have its own final output device, there is no default printer on the Desktop Print submenu. You must slide the cursor fully onto the submenu and choose a printer when using the desktop print feature.

To print documents from the desktop, select the icon(s) of your choice and execute the commands on the **Print** submenus.

---

If you see any of the following stickup menus when you try to print from the desktop, see your system administrator.

- Could not connect to desktop print daemon.
  - Could not start desktop print daemon.
  - Wrong version of desktop print daemon.
  - The desktop print spooler failed on...
- 

---

The software considers desktop printing low priority, so printing icons takes longer than printing from an open document or from a Printerleaf icon.

## Printing an Open Document

To print from an open document:

- ✓ With the mouse cursor in the Printer box in the document header, click the **middle** button if you want to print one copy of the whole document on your default printer.
- or ✓ With the mouse cursor in the Printer box, hold down the **middle** button to see the Printer pulldown menu and execute the command for the printer you want.  
*If you select a printer other than your default printer, the printer you choose will become the new default until you close and then re-open the document or choose another printer.*
- ✓ If you want to print the entire document, just release the **middle** button.
- or ☐ If you do *not* want to print the entire document, execute the command of your choice on the next submenu when the option you want is in reverse video.

## Canceling a Printing Command

You can use either **CTRL g** or **Cancel** on the Interrupt stickup menu (Figure 30-8) to cancel printing from both open documents and desktop icons.

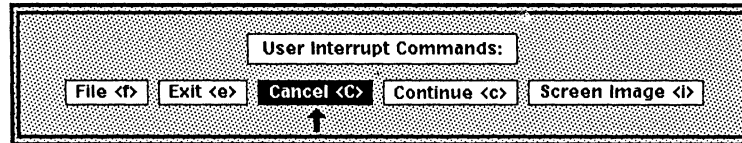



Figure 30-8. Interrupt stickup menu with the cursor at the default choice.

## Printerleaf Files

Creating a Printerleaf file is useful when you need to print a document periodically without making modifications to the document between printings. You can make a Printerleaf file from an open or closed document, and you can print it from the desktop or from the operating system. Printerleaf files print faster than documents.

While direct printing (printing open documents or document icons) creates a Printerleaf file that disappears as soon as the file is sent to the printer, Printerleaf files that *you* create remain until they are overwritten or you cut and purge their icons or remove them through the operating system.

Printerleaf files have their uses, but you should exercise caution with them. The icons for Printerleaf files  cannot be opened, so they cannot be edited. Therefore, when you create a Printerleaf file, be sure to keep the *document file* if you are going to need to edit the document again.

If you have two documents with the same name in a directory and you make a Printerleaf file from each of these *open* documents, the second Printerleaf file you make will overwrite the first. Finally, you should not keep old Printerleaf files after you upgrade your software because changes to the printer software could affect the way the files print.

## Creating Printerleaf Files

When you create a Printerleaf file from an open document for subsequent printing from the desktop, you can execute any of the commands on the Printerleaf submenu (Figure 30-9).

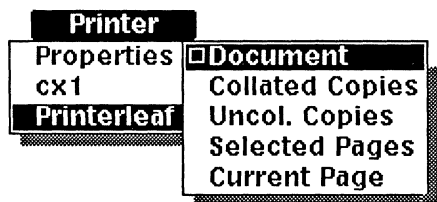

Figure 30-9. Printerleaf submenu

The Printerleaf icon that appears on your desktop represents only those pages you specified for printing. So, if you executed the command for **Current Page**, the Printerleaf file will contain only the page of your document on which the text caret currently appears.

Similarly, the number of copies, pages to print and collated/uncollated options are set at the time you make the Printerleaf file. If you later execute a command to print different pages or a different number of copies of the same Printerleaf file, it will be ineffective; the software will use the number of pages and copies you specified originally. The only printing commands you can execute on a Printerleaf file are commands that designate the printer to which you want the file sent.

If you wish to change the pages you want to print, cut and purge the original Printerleaf icon, make a new one and execute the Print command of your choice.

Printerleaf files created from desktop icons always appear on the desktop, while Printerleaf files created from open documents always appear in whatever directory the document is located in, *including* the desktop directory.

#### To create a Printerleaf file from an open document:

- ✓ On the **Printerleaf** submenu, execute the number of copies you want.  
*A Printerleaf icon bearing the same name as the document from which you created it will appear next to your document icon.*  
*The Printerleaf icon now on your desktop represents whatever pages you specified for printing. When you execute the **Print** command, only those pages of the document will print.*
- ✓ Now you can print the Printerleaf file using the **Print** command and the Print submenu just as you would to print any other document from the desktop.

#### To create a Printerleaf file from a document icon:

- ✓ Select the document icon for which you want a Printerleaf file and execute the **Print → Printerleaf** command.  
*In a few moments, a Printerleaf icon with the same name as the document from which it was made will appear on your desktop.*
- ✓ If you wish, you can open the Object property sheet for the Printerleaf icon and rename the file.

## Printing Printerleaf Files from the Desktop

To print a Printerleaf file from the desktop:

- ✓ Select the Printerleaf icon.
- ✓ Execute the *Printer Name* command on the Print submenu of the Desktop Icon Selected menu.

## Printing Printerleaf Files from the Operating System

In the operating system, Printerleaf files have an extension added to their names. For example, the Printerleaf file for a document named *Schedule* will be named *Schedule.pl*.

You print a Printerleaf file by invoking an operating system command, *lpr* (*Line Printer Request*). You can use this command to print a Printerleaf file either on your default printer or on another printer. (Note that the default printer for the *lpr* command may be different from the default printer for publishing software printing.)

To print a Printerleaf file on your default printer:

- ✓ Create a Printerleaf file of the document or portions of the document you want to print.
- ✓ At an operating system prompt, check that you are in the directory that has the Printerleaf file in it.
- ☐ At an operating system prompt, type

```
lpr documentname.pl <RETURN>
```

*For example, to print a Printerleaf file named Schedule.pl on your default printer, you would type lpr Schedule.pl <RETURN>*

If you want to print a Printerleaf file (or any other file you are printing from the operating system) on a printer other than your default printer, you can do so by using the **-P** option and the *network name* of the printer you want to use. (See the *Installation Manual* for information on printer network names or ask your system administrator.) For example, you would use the following steps if your default printer is *cx1*, and you want to print on a printer whose network name is *donald*.

To print a Printerleaf file on a printer other than your default printer:

- ✓ Make sure you are in the directory that has the Printerleaf file in it.

- ☐ At an operating system prompt, type

```
lpr -Pdonald documentname.pl <RETURN>
```

When you send a document to be printed using *lpr*, there is a period of time when two copies of the Printerleaf file must exist on your workstation. Therefore, because of inadequate storage space on your workstation, it may be impossible to print a Printerleaf file using the regular *lpr* command.

There is a printing option that you can use to your advantage in such a circumstance. The *-s* option creates a symbolic link that makes it unnecessary for the system to create a second Printerleaf file on your workstation.

---

Symbolic links are discussed in the *Administration* manual.

**To print a Printerleaf file most efficiently on the default printer:**

- ✓ Make sure you are in the directory that has the Printerleaf file in it.
- ☐ At an operating system prompt, type

```
lpr -s documentname.pl <RETURN>
```

You can combine the *-P* option and the *-s* option and print efficiently on a printer other than your default printer. For example, to print *widgets.pl* on a printer whose network name is *donald*, type:

```
lpr -Pdonald -s widgets.pl <RETURN>
```

## ASCII Files

You can print an ASCII file from inside or outside the Interleaf publishing software. An Interleaf ASCII format document is one that contains special markup so that it can be read by the Interleaf publishing software, and transferred between the Interleaf system and other text processing software.

If you save an Interleaf document in ASCII and print it from inside the Interleaf publishing software, the result will be an Interleaf document with multiple type fonts and graphics intact.

If you save an Interleaf document in ASCII and print it from the operating system, the printed document will not look at all like an Interleaf document. It will be much longer than an Interleaf document and will contain only text in typewriter font and extensive formatting instructions — graphics, for example, will be nothing but a large assemblage of numbers.

The *only* reason to print the ASCII version from the operating system is so that you can see the ASCII formatting instructions for an Interleaf document.

## Printing ASCII Files from the Operating System

The *lpr* command for printing ASCII files will take the *-P* and *-s* options described in the section, *Printing a Printerleaf File from the Operating System*.

### To print an ASCII file from the operating system:

- ✓ Make sure you are in the directory that contains the ASCII document.

- ☐ At an operating system prompt, type

```
lpr -Pnetworkname_of_printer documentname.doc <RETURN>
```

## Orientation and Size of Pages

The items on the Page Property sheet are primarily concerned with page makeup and are discussed in detail in the *Page Design* chapter. However, three settings on the sheet, *Orientation* and the *Height* and *Width* of pages, are directly involved with printing and are discussed in this section.

Figure 30-10 shows the relevant part of the Page property sheet with the defaults set.

The screenshot shows the 'Page Properties' dialog box with the 'Normal' tab selected. The 'Orientation' section has 'Portrait' selected. The 'Columns' section has a value of '1'. The 'Width' section has a value of '8.50' inches. The 'Height' section has a value of '11' inches. An upward-pointing arrow is visible between the width and height fields.

Page Properties		Normal	Custom
Orientation	Portrait Landscape		
Columns	1		
Width	8.50	inches	↑
Height	11	inches	

Figure 30-10. Portrait Orientation: Width and Height on the Page property sheet

When you change the *Orientation* to **Landscape**, the *Height* and *Width* of the page are automatically reversed since normally you will print in landscape mode when your document is wider than it is tall (Figure 30-11).

The screenshot shows the 'Page Properties' dialog box with the 'Normal' tab selected. The 'Orientation' section has 'Landscape' selected. The 'Columns' section has a value of '1'. The 'Width' section has a value of '11' inches. The 'Height' section has a value of '8.50' inches. An upward-pointing arrow is visible between the width and height fields.

Page Properties		Normal	Custom
Orientation	Portrait Landscape		
Columns	1		
Width	11	inches	↑
Height	8.50	inches	

Figure 30-11. Landscape Orientation: Width and Height on the Page property sheet

*Orientation* refers to the direction in which the contents of a document are printed. In Figure 30-12, the page on the left is in **Portrait** mode, and the page on the right is in **Landscape** mode.



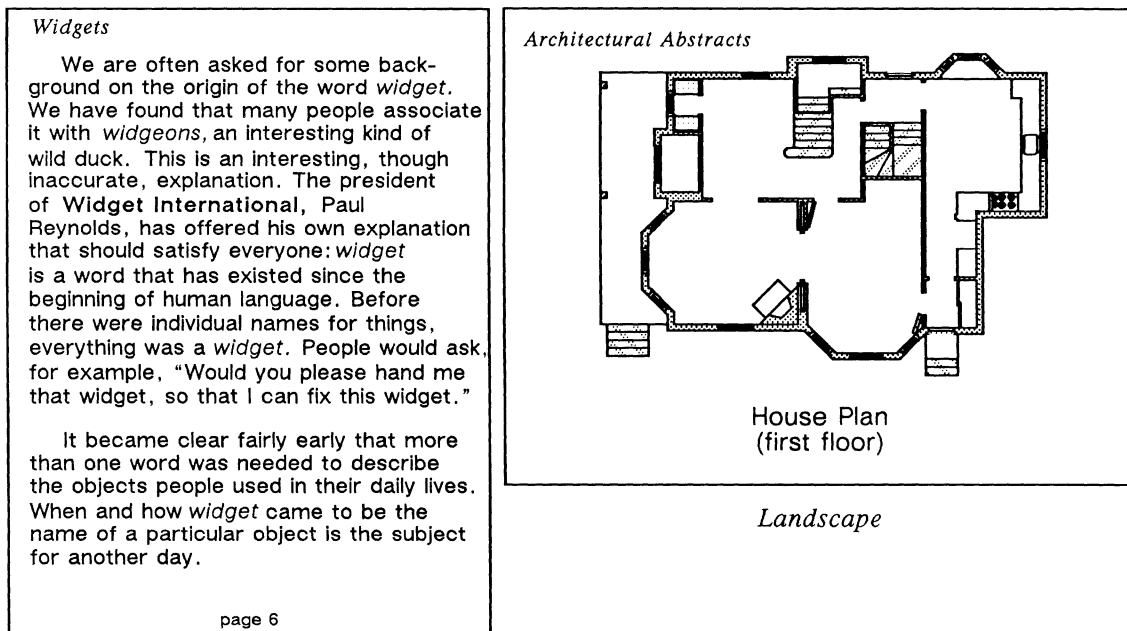

Portrait

Figure 30-12. Orientation of pages

All the pages of a particular document must have the same *Orientation*.

The paper cassette that comes with your cx printer holds paper that is 8.5 inches by 11 inches; this is the default page size.

You can make the *Height* and *Width* of your pages smaller and either manually feed smaller paper into the printer or use the cassette for 8.5 by 11 inch paper and trim the pages later to the size you want them.

If you have a legal-size cassette, you can print pages up to 8.5 by 14 inches. If you do not have a legal-size cassette, you must manually feed legal-size paper into the printer.

If you have a Dataproducts printer, you can print pages up to 11 by 17 inches using the appropriate cassette, or you can feed the paper manually.

## Page Margins

The default page margins are set so that the white space around text enhances readability, but you can easily change the margins to suit your own needs.

On the Dataproducts printer, there is a *hard* page margin of .25 inch all around; that is, nothing within .25 inch of the edge of the page will print, no matter how it appears on the display. On the Interleaf and Imagen cx printers, there is a hard margin of approximately .25 inch on the right, slightly less than that on the left, and much less on the top and bottom.

## Following a Document through the Printing Process

No matter which method you use to print a document, the document you send to printing goes to the workstation that functions as a *server* for the printer. This workstation keeps track of each document and makes sure that each document is printed in its turn. You can find out whether the printer is operating and also where your document ranks in the print queue through an operating system command, *lpq* (*Line Printer Queue* command).

To list the print queue for your default printer:

- ☐ At an operating system prompt, type  
**lpq <RETURN>**

*Figure 30-13 shows a typical print queue.*

% cx#1 is ready and printing				
Rank	Owner	Job	File	Total Size
active	md	431	.deskprint/ascii.pl	57831 bytes
1st	kath	254	.deskprint/fonts.pl	594333 bytes
2nd	sam	673	.deskprint/list.pl;	452145 bytes
3rd	tim	152	.deskprint/desktop.pl	32456 bytes
4th	jm	512	.deskprint/revision.pl	54095 bytes

*Figure 30-13. Line Printer Queue listing*

---

After sending a job to a printer, you may use the *lpq* command and find that there are no entries in the queue. This sometimes happens because the system is in the process of performing tasks like opening the document file and formatting it for printing.

Once these tasks have been completed, your job will show up in the queue. So wait a few minutes and then try the command again.

---

You can also see the queue listing for a printer other than your default printer by using the *-P* option. For example, *lpq -Pbackup* would give you a listing of the documents in the queue of the printer named *backup*.

Sometimes you will send something to print and then realize that you do not want to print it at this moment. When this happens, you can remove the document

from the print queue with a command that includes the job number of the document you sent for printing.

#### To remove a document from the print queue of your default printer:

- ☐ At an operating system prompt, type

```
lprm jobnumber <RETURN>
```

*For job number, see the column labeled Job in Figure 30-13.*

You can remove a document from the print queue of a printer other than your default printer by using the `-P` option.

#### To remove a document from the print queue of a printer other than your default printer:

- ☐ At an operating system prompt, type

```
lprm -Pprintername jobnumber <RETURN>
```

*For example, if you were the owner of revision.pl (see Figure 30-13) and were printing it on a printer named cx#1 that was not your default printer, you would remove it from the print queue by typing*  
**lprm -Pbackup 512 <RETURN>**

You can remove *all* your jobs from the print queue by substituting your login name for *jobnumber* with the `lprm` command.

After typing the `lprm` command to remove a job from the print queue, you will see several operating system messages. At least one of these messages will indicate that the job has been removed from the queue. However, if you want to check that the job is no longer in the queue, use the `lpq` command.

## Printer Maintenance

Certain procedures should be followed by all users. These procedures help minimize printer jams.

- Use the correct size paper.
- Aerate the paper before loading the printer. This is done by holding the stack of paper on opposite ends, bending it into a quarter-circle and flattening it out again. This causes a little “platform” of air to lodge between the sheets.
- Make sure the paper is stacked neatly and placed flush against the feed end.



# Appendix A

## Menus

### Text Selected Menus

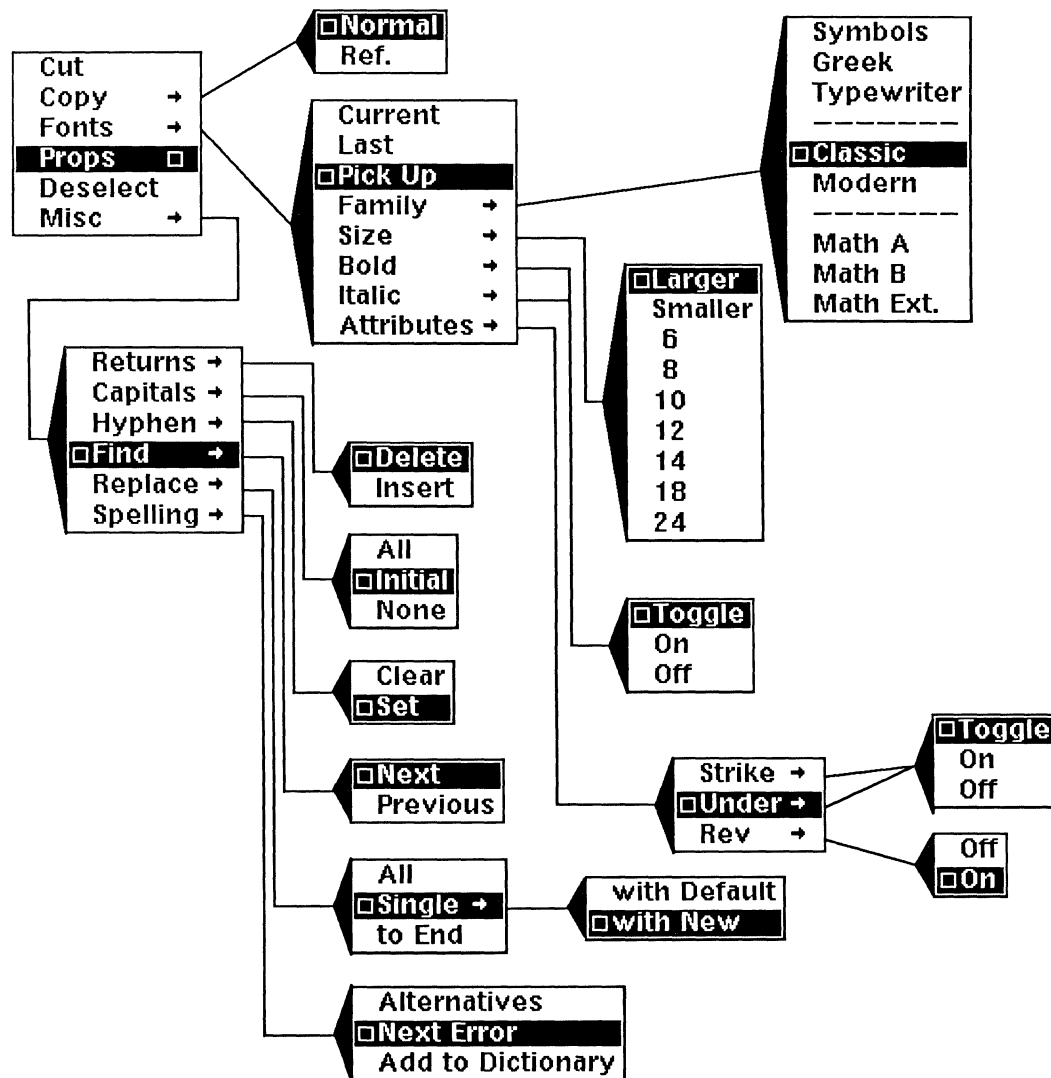
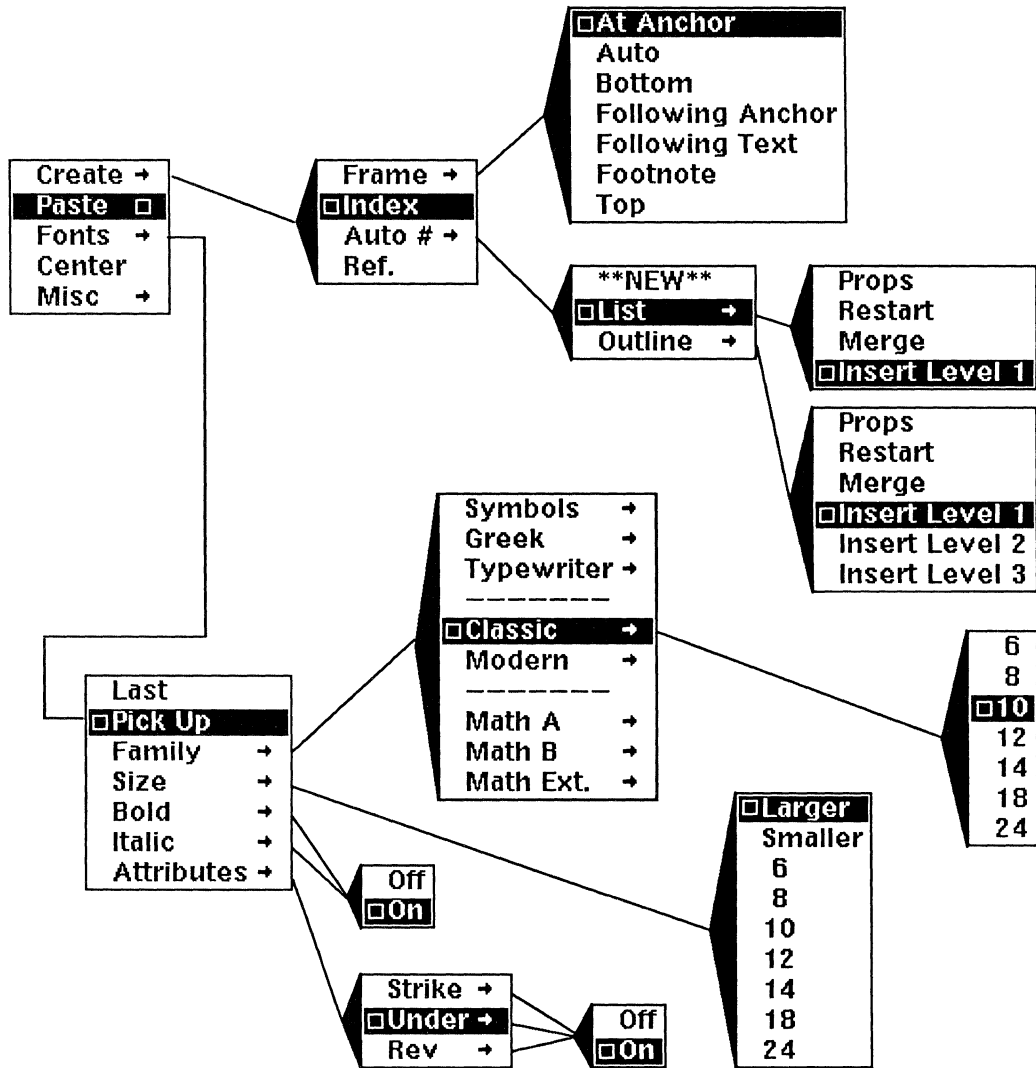

Figure A-1. Text Selected menus

# Text Location Menus



(Continued on next page)

Figure A-2. Text Location Create and Fonts submenus

## Text Location Menus (continued)

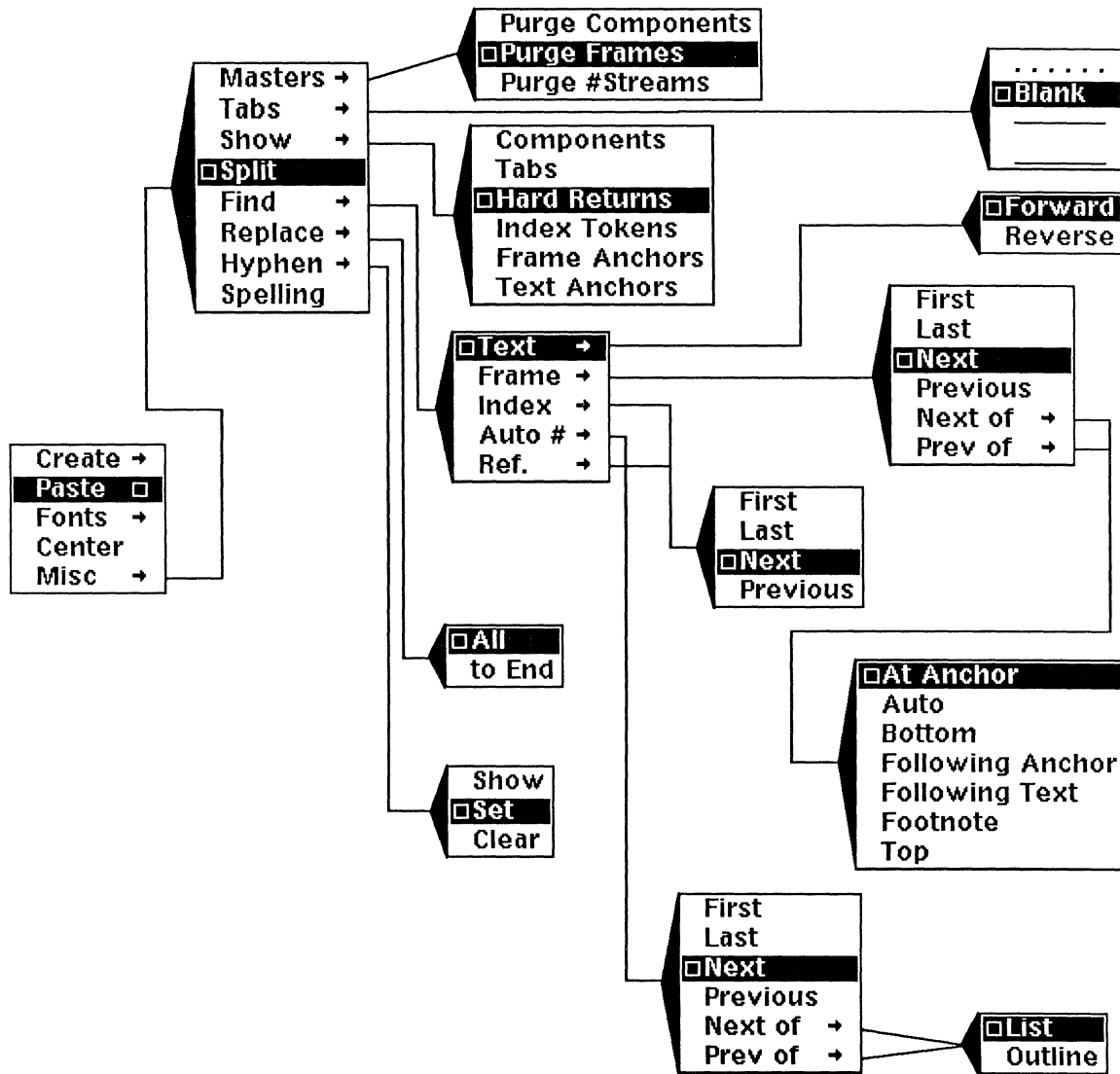
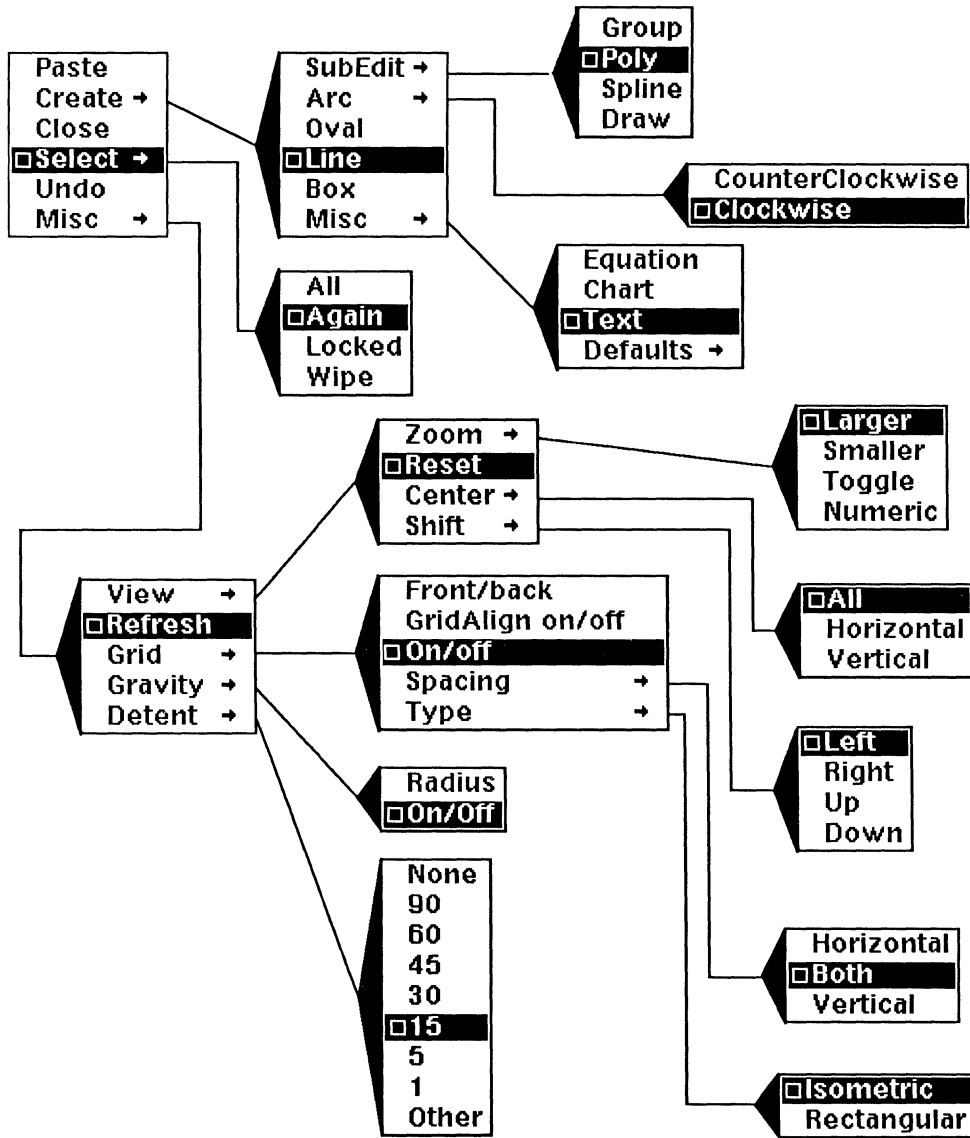

Figure A-3. Text Location Misc submenus

## Diagramming Nothing Selected Menus



(Continued on next page)

Figure A-4. Diagramming Nothing Selected Create, Select and Misc submenus



## Diagramming Nothing Selected (continued)

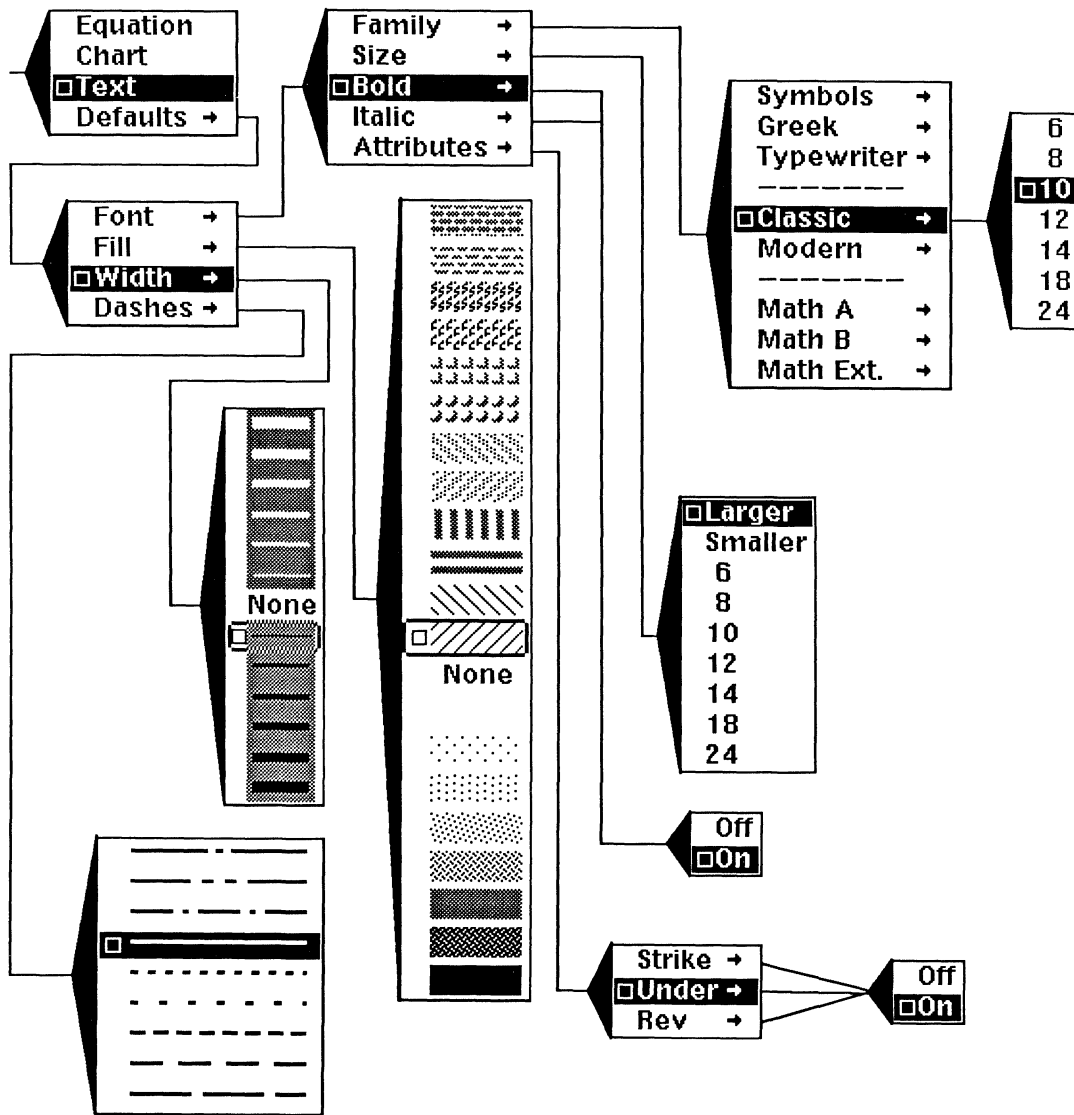
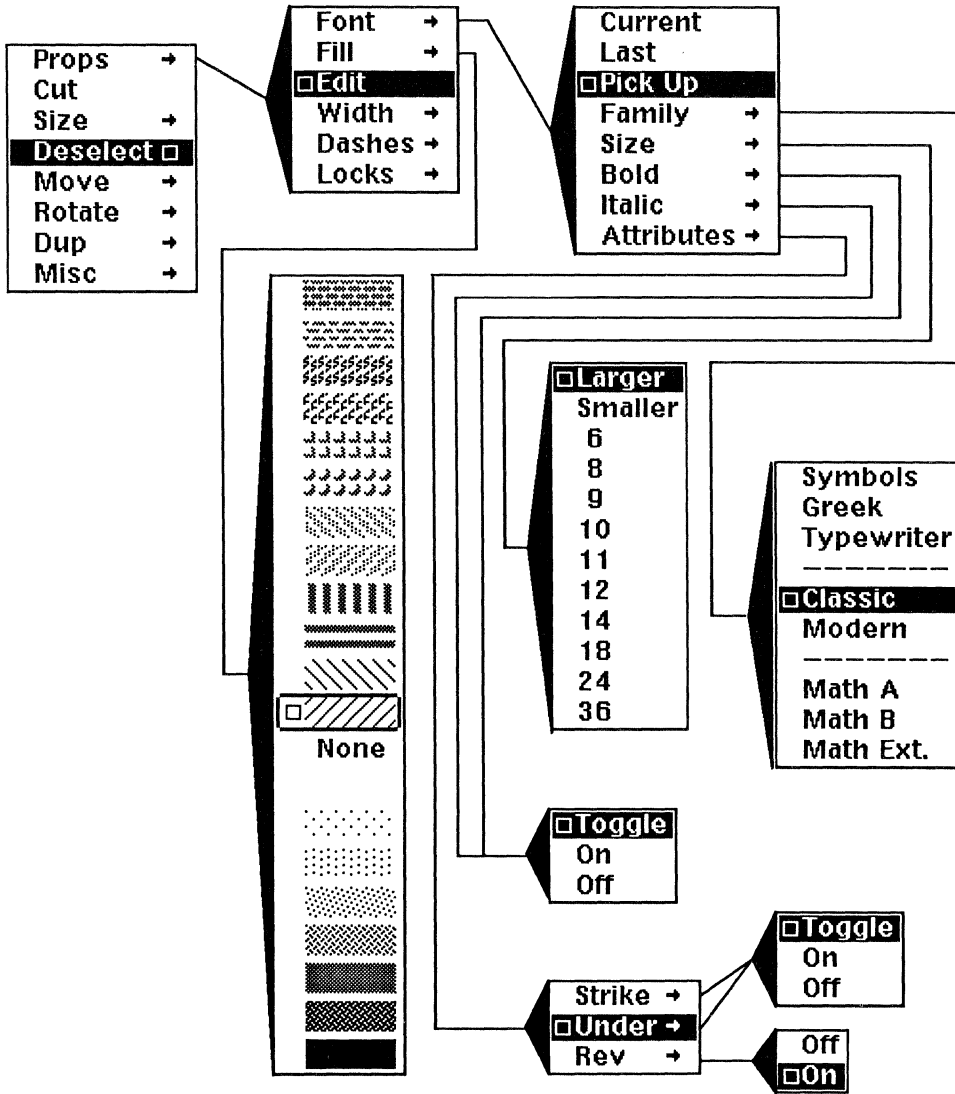

Figure A-5. Diagramming Nothing Selected Create Misc Defaults submenus

## Diagramming Object Selected Menus



(Continued on next page)

Figure A-6. Diagramming Object Selected Props submenus

## Diagramming Object Selected Menus (continued)

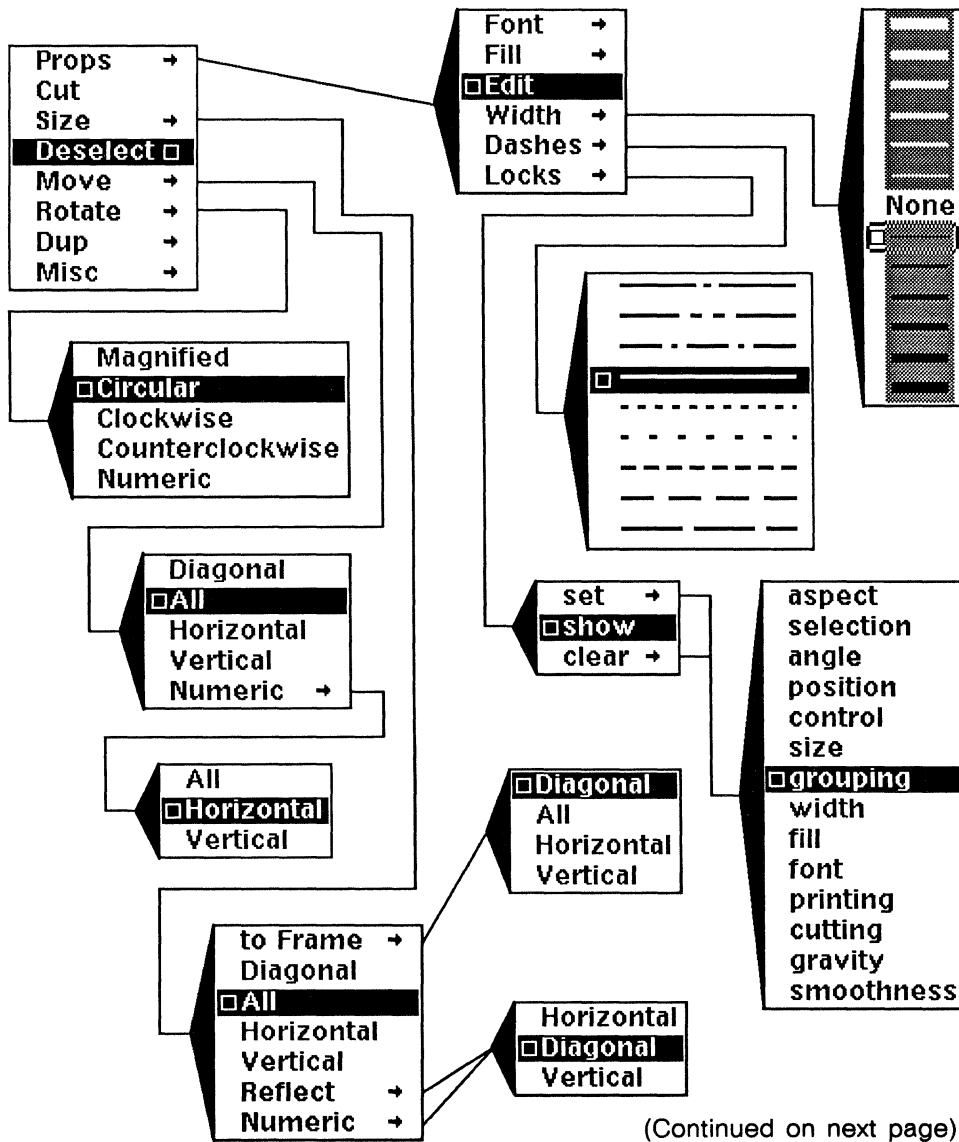

Figure A-7. Diagramming Object Selected Props, Size, Move, and Rotate submenus

## Diagramming Object Selected Menus (continued)

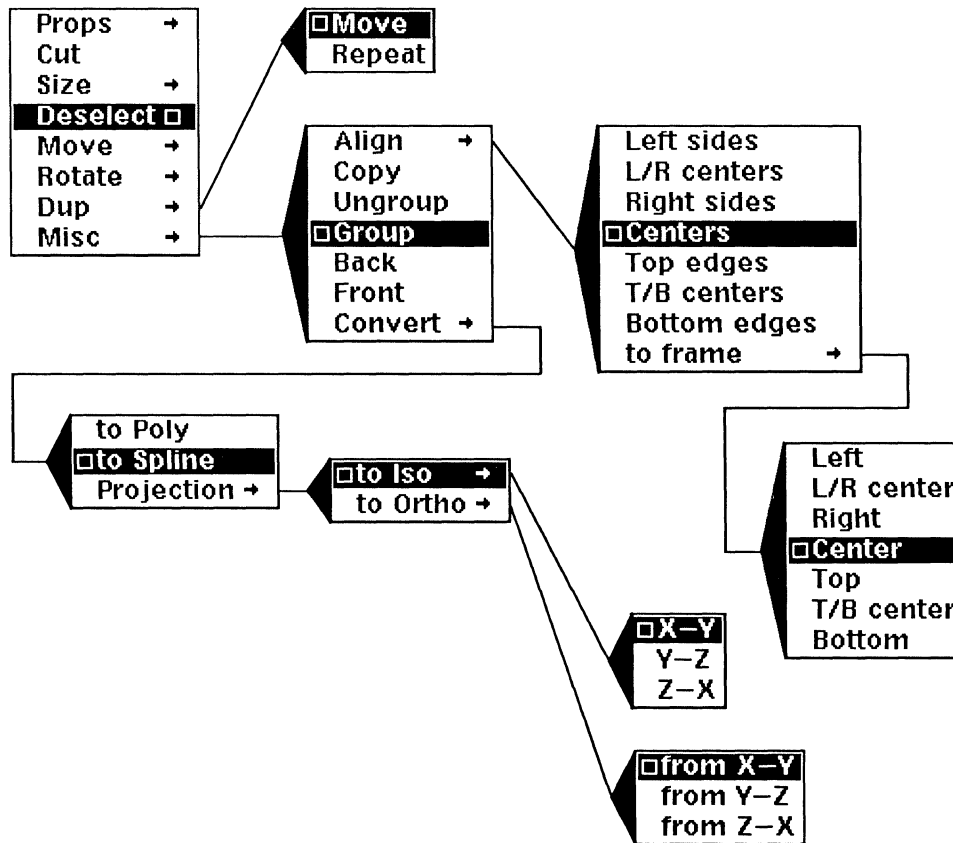
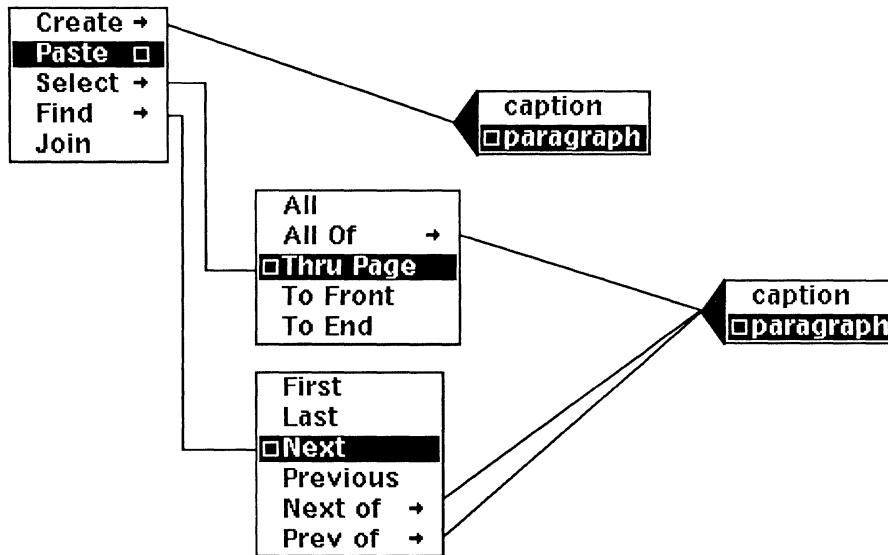

Figure A-8. Diagramming Object Selected Dup and Misc sub-menus

## In Component Bar

Location Selected



Component Selected

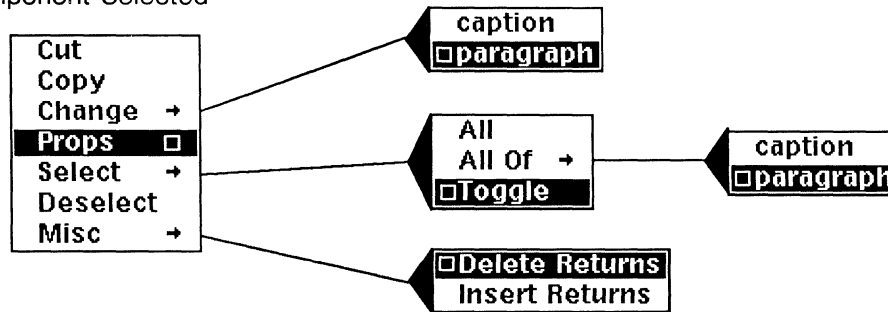
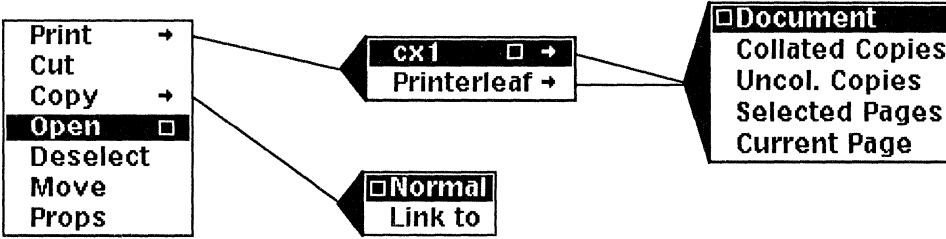

Figure A-9. Location Selected and Component Selected menus

## In Directory Windows

Icon Selected



Nothing Selected

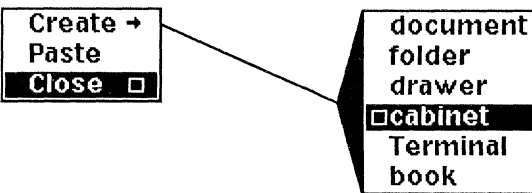

Book-Icon Selected

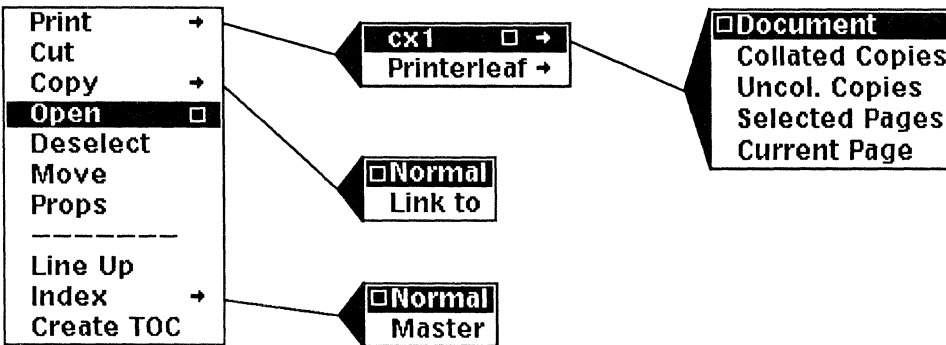

Figure A-10. Icon Selected and Nothing Selected menus in directory windows

## In Windows

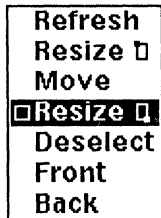

Figure A-11. Window menu in scroll bars and headers

## Property Sheet Menus

### Property Sheet Close

Printer, Page,  
Auto-Stream, Token



Object, Equation,  
Chart-Style



Component, Frame,  
Auto-Reference, Index

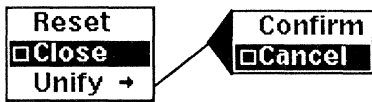
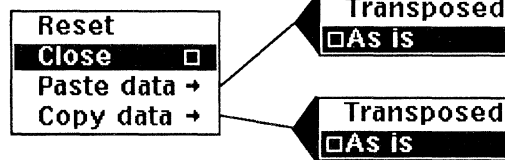

Chart-Data



### Property Sheet Apply

Page,  
Chart-Style



Component, Frame, Auto-Reference, Index

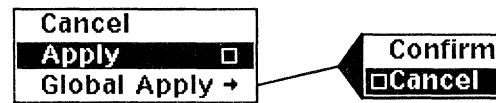

Object, Printer, Equation,  
Auto-Stream, Token

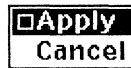

Chart-Data

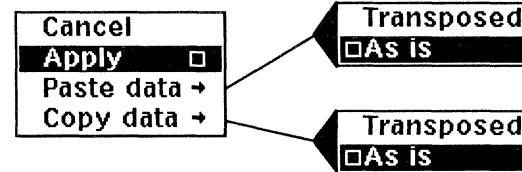
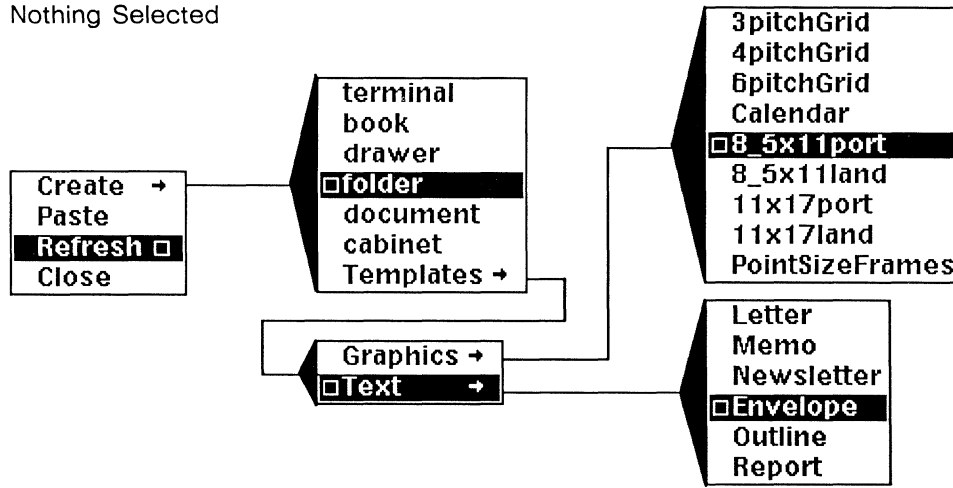

Figure A-12. Property sheet Close and Apply menus

## Desktop Menus

Nothing Selected



Icon Selected

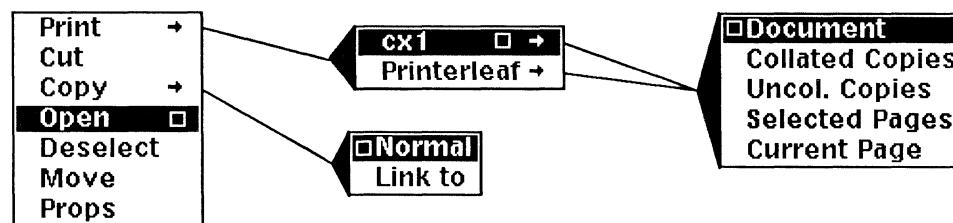

Figure A-13. Icon Selected and Nothing Selected menus on the desktop

## Virtual Terminal and Clipboard Menus

*In Virtual Terminal*

*On Clipboard*

Nothing Selected

Text Selected

Nothing Selected

Icon Selected

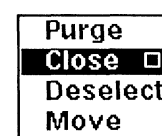
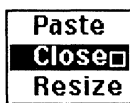

Figure A-14. Virtual terminal and clipboard menus



## Document Header Pulldown Menus

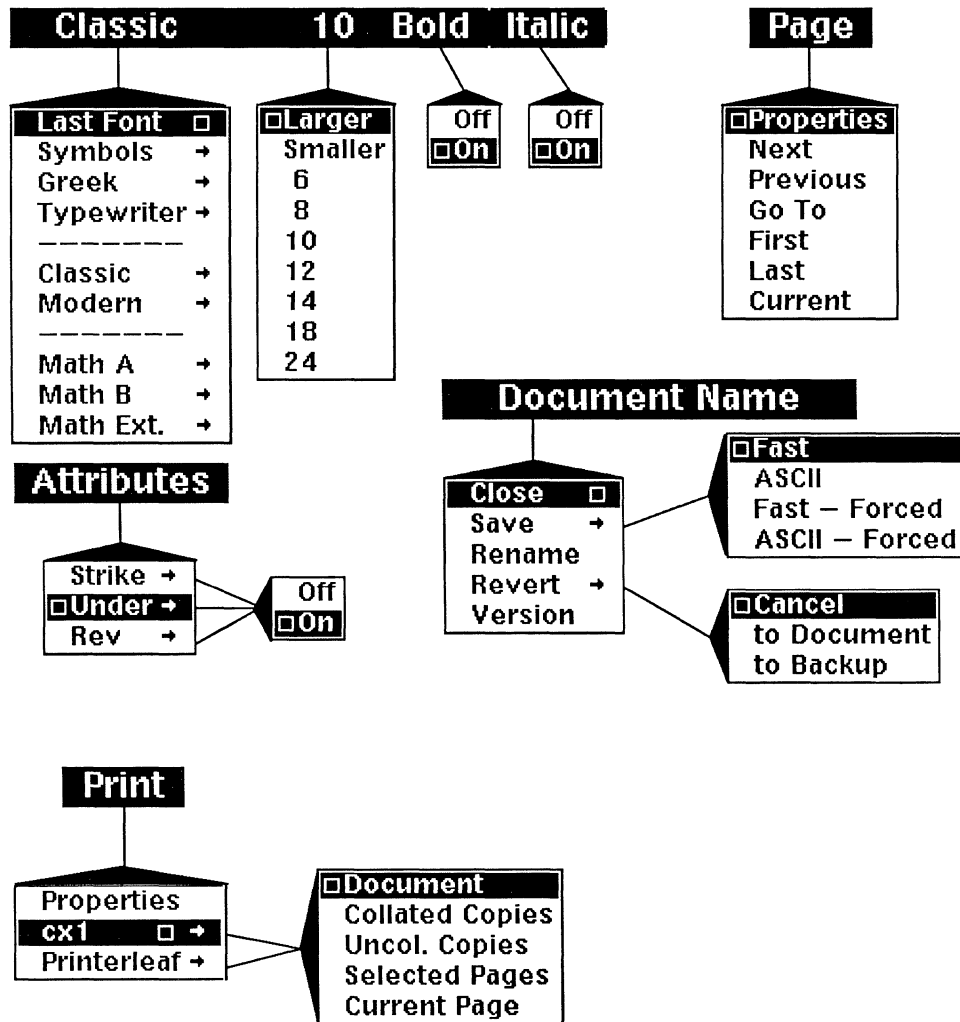

Figure A-15. Document Header pulldown menus



---

## Appendix B

### *The Virtual Terminal*

A **virtual terminal** is a window on your desktop which enables you to conduct UNIX operations without leaving the publishing system. For example, you would use UNIX commands in the virtual terminal to monitor your printing process. See the chapter *Printing* for these commands.

The virtual terminal is represented by a *terminal* icon, Figure B-1. The original desktop does not have a terminal icon, so you must create one.



*Figure B-1. Terminal icon*

### *The Terminal Icon*

The **terminal icon** behaves almost exactly like other icons on the desktop. You can create, cut, copy, move, and rename terminal icons. In fact, you can execute all the commands on the Icon Selected popup menu, except **Print**. However, there are a number of subtle differences between the way the **Cut** and **Copy** commands act on terminal icons and the way they act on document and directory icons.

You can cut a terminal icon only if it is *not* an **active terminal**. A terminal is active if you have not exited from your operations in it. If you try to cut a terminal icon without exiting from your operations in it, you will see a stickup menu that reads: *Active terminals cannot be cut.*

You can copy a terminal icon, and the copy will have the same properties (name, window size and location, for example) as the original icon. However, if you copy a terminal that is active, the *visual contents* of the icon will not be copied into the new terminal. (The unseen contents of the file in the operating system are copied to the new terminal, but the contents that you see in the window are not copied.)

### *The Terminal Window*

When you select and open a terminal icon, the *virtual terminal window* originally will appear in the lower left-hand corner of your desktop. Figure B-2 shows the desktop with a virtual terminal window that contains output of a program. The appearance of the window is similar to that of a directory window.

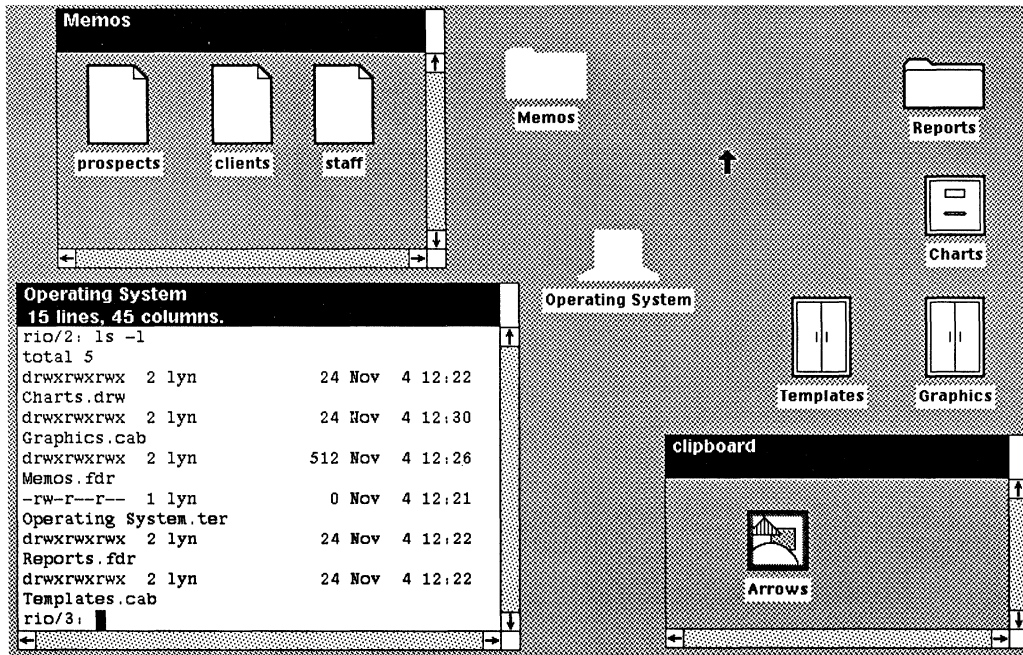

Figure B-2. Desktop with terminal window

In the header bar of the window is the name of the window; below it in the status line is the number of lines and columns the window currently has. In Figure B-2, the name of the window is *Operating System*.

The scroll bars in the terminal window do not scroll the window or its contents.

The terminal window will show an operating system prompt (in Figure B-2, the operating system prompt is *rio/3:*), a text cursor **█** and the mouse cursor **↑**. The operating system prompt tells you that the system is ready for you to enter a command. The mouse cursor's behavior in the terminal window does not differ from its behavior elsewhere in the publishing software.

## Resizing the Terminal Window

You can resize the terminal window by:

- using either of the **Resize** commands on the Window popup menu as you would for any window.
- selecting the **Resize** command from the Terminal Nothing selected menu and specifying the lines and columns on the *Resize* stickups.

Using either method, you can make your terminal window as large as your screen or as small as 3 lines x 8 columns, which is the minimum size for windows.

The **Resize** command is on the *Nothing Selected* menu (Figure B-3).



Figure B-3. Terminal Nothing Selected menu

To specify the number of lines and columns in the terminal window:

☐☐☐ With the mouse cursor in the terminal window and nothing selected, hold down the **middle** button.

✓ Execute **Resize** on the popup menu.

A stickup menu (Figure B-4) appears asking you to specify the number of lines in the terminal.

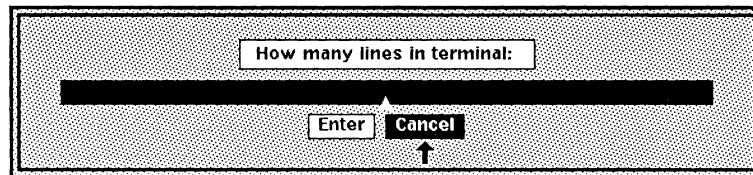

Figure B-4. Resize Lines stickup

Once you respond to this stickup, another stickup (Figure B-5) will appear asking you to specify the number of columns.

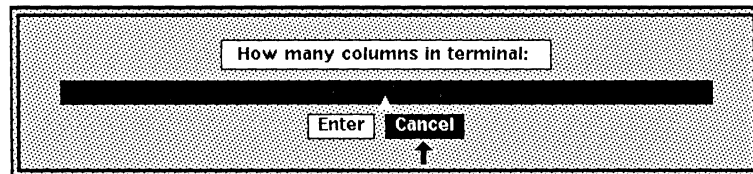

Figure B-5. Resize Columns stickups

☐ Enter the number of lines and columns you want your terminal window to have.

Your terminal window size is adjusted and the number of lines and columns displayed in the header bar has changed to reflect the new specifications.

If you enter no value for either lines or columns, no change will take place.

## Copying and Pasting Text within a Virtual Terminal

There may be times when you want to repeat a command in the virtual terminal window. Instead of typing the entire command line, you can select the line you want to repeat, copy it by using the **Copy** command on the *Text Selected* menu (Figure B-6), then paste it after the next operating system prompt by using the **Paste** command on the *Nothing Selected* menu.

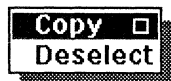

Figure B-6. Terminal Text Selected menu

**To copy and paste text within the virtual terminal window:**

- ✓ Select the text you want to copy.  
*The cursor no longer displays and the selected text is highlighted.*
- ✓ Execute the **Copy** command.  
*The text is deselected and the cursor appears again.*
- ✓ Execute the **Paste** command.  
*The copied text is placed on the command line.*

## Copying and Pasting Text from a Virtual Terminal

Any program, such as the vi editor, that you can run in the terminal can have its text (commands and output) copied to the *clipboard* and then pasted into a text component in an open document, into a chart Data sheet, or, as a document, into a directory or directly onto the desktop.

**To copy and paste text from a virtual terminal window:**

- ✓ Select the section of text you wish to copy.
- ✓ Execute the **Copy** command.
- ✓ **Paste** the text into an open document, a directory, or directly onto the desktop.

When you copy text from the terminal window, the copy appears on the clipboard in the form of an external document icon (Figure B-7). You can then paste the icon on your desktop and open it.

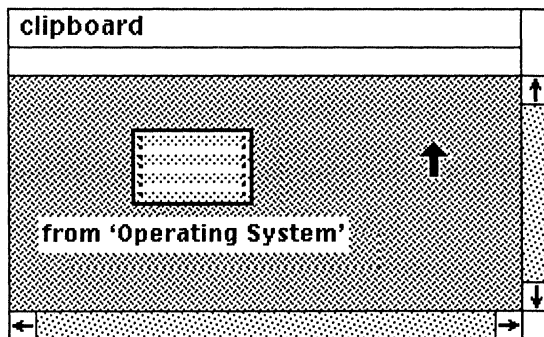

Figure B-7. External document icon containing text copied from the terminal window

You cannot paste the contents of any other icons except external document icons into the virtual terminal. The message: *Only external icons can be pasted*, displays in the status line of the terminal window when you try to paste the contents of other types of icons.

## Using the Flush Input Command

In addition to **Paste**, **Close**, and **Resize**, the Nothing Selected menu sometimes has another command, **Flush Input**. UNIX has a limit of 256 characters per command line. When your command line exceeds this limit, you will neither be able to type nor delete on the command line. **Flush Input** discards the command line and enables you to interact with the operating system again. Figure B-8 shows the Nothing Selected menu with the **Flush Input** command.



Figure B-8. Terminal Nothing Selected menu with Flush Input

To flush command-line input:

- ✓ Execute the **Flush Input** command.
- ☐ Press **Return** to bring back the operating system prompt.  
*Now you can enter a command again.*

## Exiting from the Virtual Terminal

In most cases, you will use one of two commands to exit from operations in a terminal window. If neither of these commands terminates your operations in the terminal window, see your system administrator.

To exit from operations in the virtual terminal window:

- ☐ At an operating system prompt, hold down the CTRL key and type **d**.
- or ☐ At an operating system prompt, type **exit <RETURN>**.  
*The virtual terminal window will close and the terminal icon on your desktop will no longer be selected.*

If you plan to resume your work in the virtual terminal, but want to close the window temporarily, you can simply close the terminal by using the **Close** command on the Nothing Selected menu. The **Close** command enables you to close

the window without terminating any process that is running in it. The terminal will remain active until you use one of the keyboard commands to exit.

## **Active Terminals**

An **active terminal** is considered an open window, even if it is in its closed, icon state. So, if you have three active terminals on your desktop, you can have only 13 other windows open at the same time.

You may create as many terminals on your desktop as you wish. Since you may have not more than four (4) terminals *active* simultaneously, however, it is best to limit the number of terminals you create. That way you will not have to search through numerous terminal icons to locate the active ones before you close your desktop.

If you try to close your desktop without exiting from your operations in the terminal window, you will see a stickup that reads; *You have terminals with active processes. Closing the desktop will terminate them. Please confirm.*

At that point it is best to select **Cancel** on the stickup. This will enable you to re-open your active terminal(s) and exit from the programs running there.



---

## Appendix C

# *Diagramming Techniques*

In this chapter, structured exercises offer practice in basic diagramming techniques and give some useful combinations of diagramming commands. This set of techniques is not exhaustive. As you use the diagramming system, you will find other techniques that help you with your work.

At the beginning of each technique, there is a descriptive title followed by an illustration of the end product of the exercise. Brief explanatory paragraphs introduce the detailed steps. Each step is preceded by an illustration of the way the object should look upon completion of the step.

In the following exercises, you will learn how to:

- force horizontal and vertical lines
- lengthen rotated boxes
- make concentric circles
- mask objects
- make cylinders
- rotate objects around a point
- make regular polygons with even and odd numbers of sides
- make stars
- create double lines and polygons
- divide boxes into equal parts
- create objects with curved corners
- create a cube
- create cubes with curved corners
- make reverse arrows
- create control and gravity points
- build rotate-magnified arrows
- organize objects with common borders into separate polys
- create a floor plan

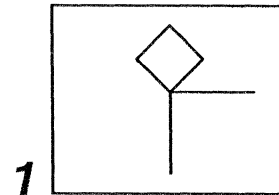

## Forcing Horizontal or Vertical Lines

Sometimes you will find that Gravity or GridAlign prevents you from making horizontal or vertical lines in certain positions. This technique makes it possible to force a horizontal or vertical line. It works with gravity points only if **Gravity** is *on* and with grid points only if **GridAlign** is *on*.

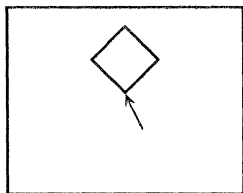

Point the cursor at the object or at the grid point you want the horizontal or vertical line to be attached to.

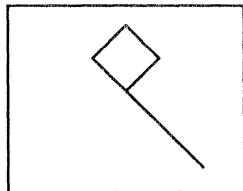

Create a line.

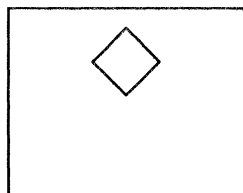

Use **Size All** to make the line into a point.

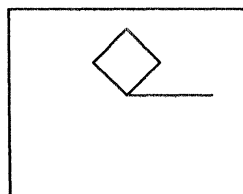

Use **Size Horizontal** to make a horizontal line.

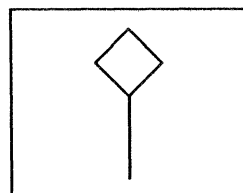

Or use **Size Vertical** to make a vertical line.

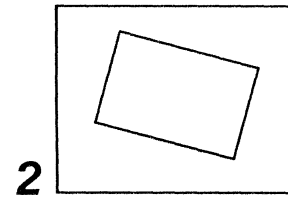

## Lengthening a Rotated Box

Use this technique when you want to make a rotated box longer or shorter in one dimension without affecting the other dimension.

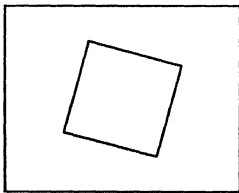

Select and **Edit** the box.

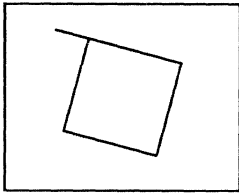

Use **Size Diagonal** to make one side the length you want.

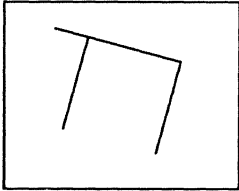

Cut the opposite side.

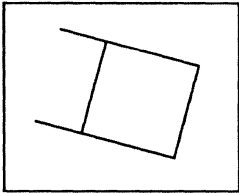

**Dup** the side you sized and **Move** the duplicate to make the opposite side.

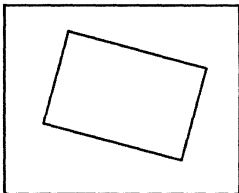

**Move** the end and **Close**.

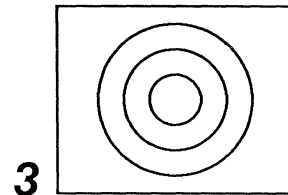

## Making Concentric Circles

A circle is an oval that is as high as it is wide. The default oval is a circle the size of one default grid block. To make a larger or smaller circle, use the **Size Diagonal** command. You can also use this technique with polys (including boxes); but, with polys, you must either use the **Size Numeric Diagonal** command instead of the **Size Diagonal** command or select all of the polygons and use the **Misc Align Centers** command.

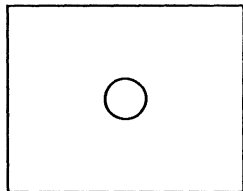

Create an oval.

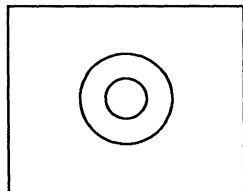

**Dup(licate)** the oval. Use either **Size Diagonal** or **Size Numeric Diagonal** to size the duplicate. If you use **Size Diagonal**, you will have to adjust the size of each circle manually, but you can make the circles the same distance apart (for this example, we used **Size Diagonal**).

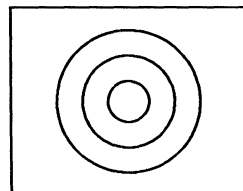

Use the **Dup Repeat** command to create additional circles. If you used **Size Numeric Diagonal**, the size and position of the circles will be automatically determined from your entry on the stickup menu, but they will be increasingly farther away from each other, giving a three dimensional effect.

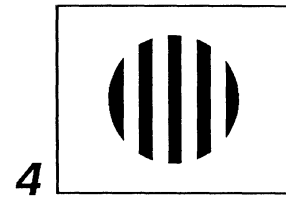

## Masking Objects

Masking is useful for covering up parts of an object, so that the underlying object looks more complex than it really is.

To make a circle with stripes:

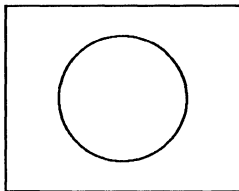

Turn **GridAlign** *off*. Create an **Oval**, and **Size** it diagonally.

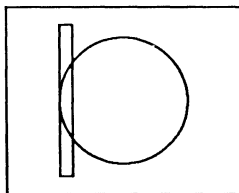

Create a **Box** taller than the oval and approximately the width of the stripe you want, and position it at one side of the oval.

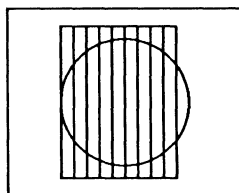

**Dup**(licate) and **Move** boxes horizontally until you have an odd number of boxes that will fit over the oval.

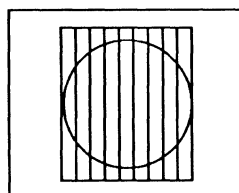

Select all of the boxes, and **Size** them horizontally to the width of the oval.

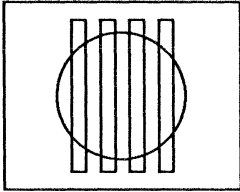

Select every other box beginning with the first one, and **Cut** them.

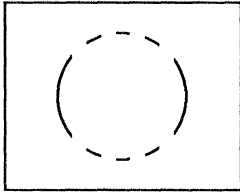

Select the remaining boxes, **Fill** them with white and make their **Width** none. **Lock** their fill and width.



Select the oval, and **Fill** it with a dark fill. **Select All**, and **Group**.

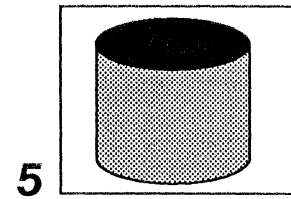

## Making a Cylinder

This technique uses arcs, detent, and grouping to create a cylinder.

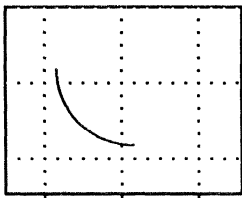

Turn the **Grid**, **GridAlign**, and **Gravity** *on*. Set detent to **45** degrees. **Create an Arc**.

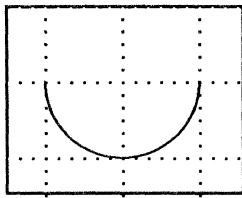

**Edit** the *endpoint* of the arc to create a half-circle. With detent at 45 degrees, this can be done by moving the control point two *clicks*.

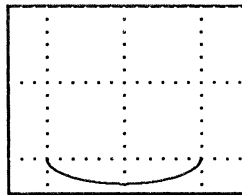

**Edit** the *midpoint* of the arc upward to flatten the arc.

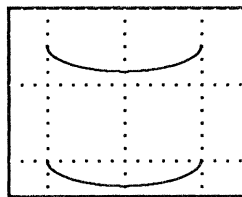

**Dup** the arc and **Move** the duplicate **Vertically**.

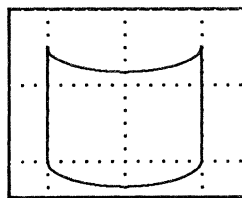

Connect the arcs with vertical lines.

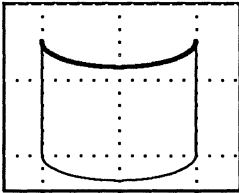

**Dup** the top arc without moving the duplicate, and **Deselect**.

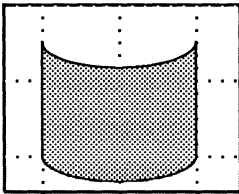

**Select** the lines, the bottom arc, and one of the top arcs. **Fill** or **Group** the selection.

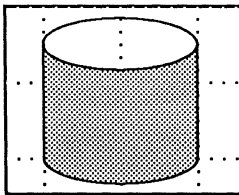

**Select** the remaining arc. It may help to first select the filled part of the cylinder and execute the **Back** command. **Edit** the endpoints of the remaining arc to make a closed ellipse.

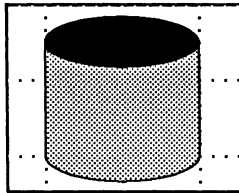

**Fill** the top of the cylinder if you wish. **Group** the top and bottom of the cylinder.



6

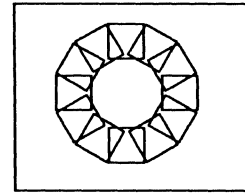

## Rotating Objects around a Point

The exact shape you create using this technique depends on the size and position of the box and the oval you create. Try it with shapes other than boxes, too. This technique assumes the detent is set to its default, 15°.

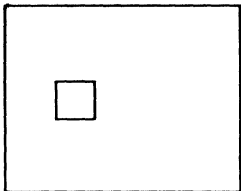

Create a **Box**. This is the object that will be rotated.

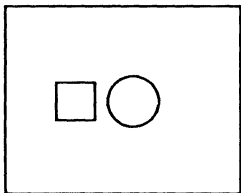

Create an **Oval** centered at the point you want to rotate around. The position of the oval and the size of the box will determine the appearance of the final object.

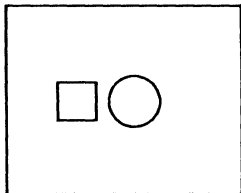

Select the circle (oval) and **Lock** control on it.

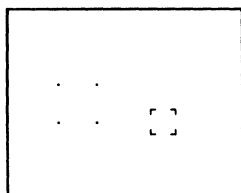

Select the circle and the box and **Dup(licate)** them. The display will look like this (the position of the control point may not be exactly the same).

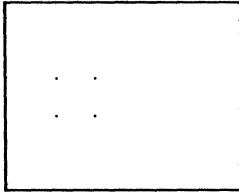

Execute the **Rotate Circular** command.

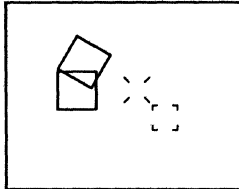

Move the mouse cursor until your display looks like this.  
(Again, the position of the control point may vary.)

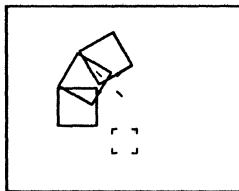

Execute the **Dup Repeat** command. The last animation command you executed was **Rotate Circular**, so you will automatically rotate after duplicating.

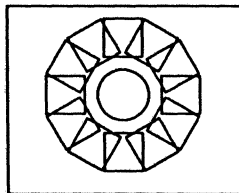

Continue to **Dup Repeat** until the circle is complete.

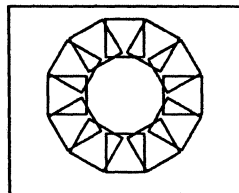

Use drag select to select the circles, and **Cut** them.

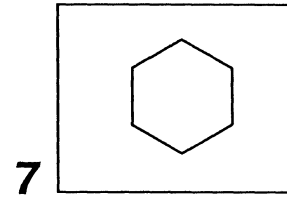

## Making a Regular Polygon with an Even Number of Sides

Before you begin, decide how many sides the polygon will have. Divide 360 by the number of sides, and set the default detent to the result. We are going to show how to create a six-sided polygon. One sixth of 360 is 60, so we have set the default detent to 60. This technique works best with **Gravity on** and **GridAlign off**.

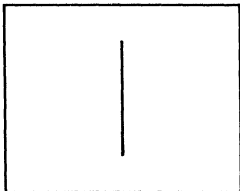

Create a vertical line.

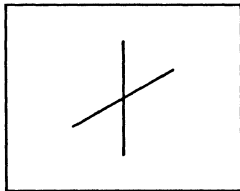

Dup(licate) the line and **Rotate** it.

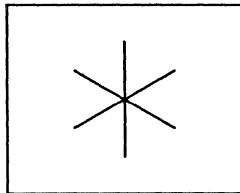

Dup and **Rotate** again.

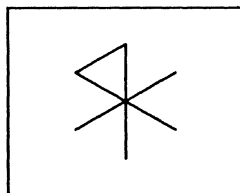

Create a line that connects the end points of two adjacent lines.

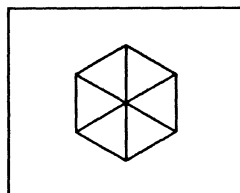

Create five more lines in this way.

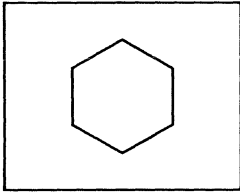

Select the three center lines and **Cut** them.

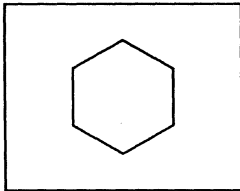

**Group** the six lines together.

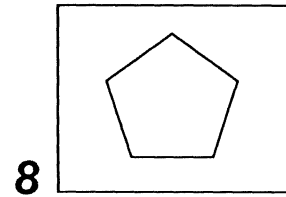

## Making a Regular Polygon with an Odd Number of Sides

Before you begin, decide how many sides the polygon will have. Divide 360 by the number of sides, and set the default detent to the result. We are going to show a five-sided polygon. One fifth of 360 is 72, so we have set the default detent to 72. This technique works best with **Gravity on** and **GridAlign off**.

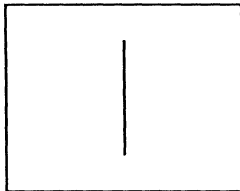

Create a vertical **Line**.

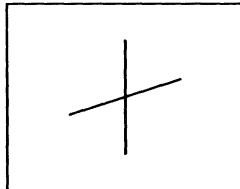

**Dup(licate)** the line and **Rotate** it.

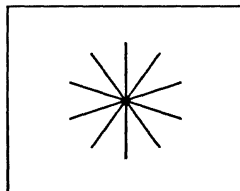

**Dup** and **Rotate** the line three more times.

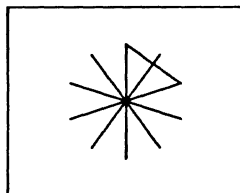

Create a **Line** that connects the end of the vertical line with the end of the second line to the right.

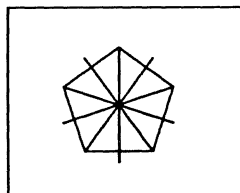

Create four more lines, connecting alternating endpoints.

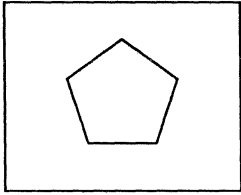

**Cut** the five center lines.

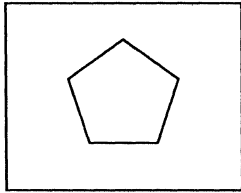

**Group** the five remaining lines.

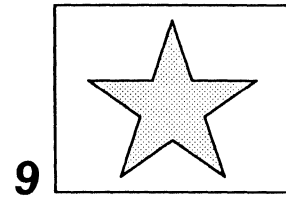

## Making a Five-Pointed Star

The preparation for making a star is the same as it is in the technique for making a regular polygon with five sides (Technique 8). You can either set the detent to 72 (360 divided by 5, the number of points in the star) before you begin to make the star, or you can use the **Rotate Numeric** command. This technique works best with **Gravity on** and **GridAlign off**.

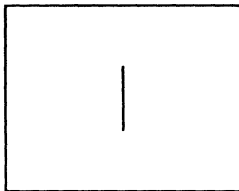

Create a vertical **Line** the approximate length of one of the star's points.

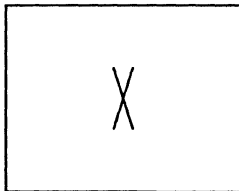

**Rotate** the line numeric 18°. **Dup(licate)** it, and **Size Reflect Horizontal** the duplicate.

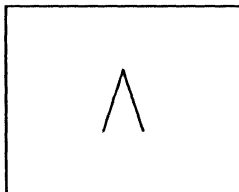

**Select Again**, make sure the cursor is pointing at the top of the line, **Move** the line, and attach it to the other line. **Group** the two lines.

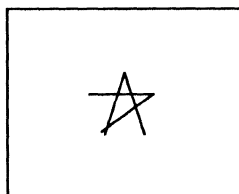

**Select Again** and **Dup**. If you have set the detent to 72, use the **Rotate Clockwise** command. If you have not set the detent to 72, use the **Rotate Numeric** command, and set the angle to 72.

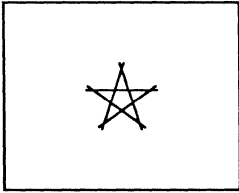

**Select Again and Dup Repeat** three more times.

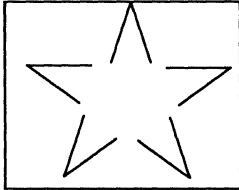

Select each of the five groups, and **Move** it out to its approximate location.

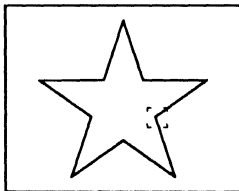

Select each of the five groups, and attach it to the group on either side using gravity.

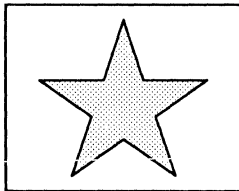

**Select All**, and **Ungroup**. **Select Again**, and **Fill**.

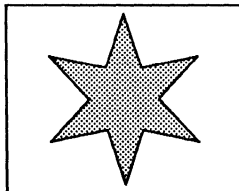

Stars with numbers of points other than 5 can also be created by creating the appropriate number of points and rotating them a different number of degrees. For example, to make a six-pointed star, you would create 6 points and rotate the points  $60^\circ$  (360 divided by 6).



10

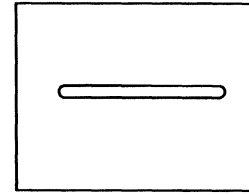

## Creating Double Lines

Double lines are lines of one color (black or white) overlaid with thinner lines of the other color. They are useful when a line must show up over both dark and light backgrounds.

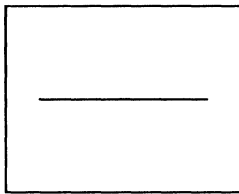

Create a Line.

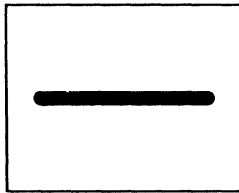

Change the **Width** of the line, and make it very thick and black.

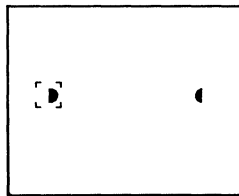

Dup(licate) the line. Your display will look like this.

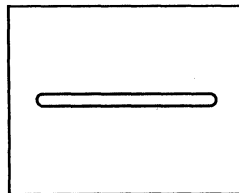

Change the **Width** of the duplicate. Make it white and two widths thinner than the original.

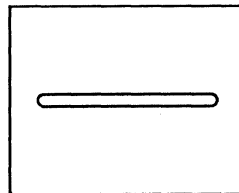

Group the lines together.

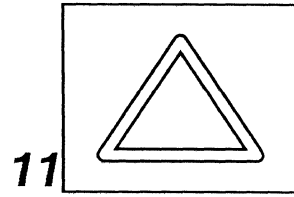

## Creating Double Polys

This is one technique for creating a poly which will show up over both dark and light backgrounds.

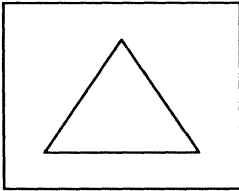

Create a poly, using thin lines.

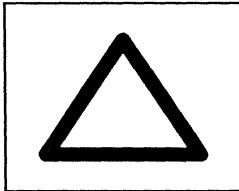

Make the border of the poly thick and black.

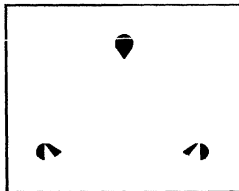

Duplicate the poly. Your display will look like this.

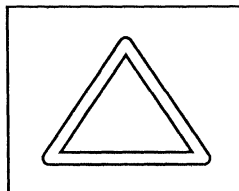

Change the **Width** of the duplicate. Make it white and two widths thinner.

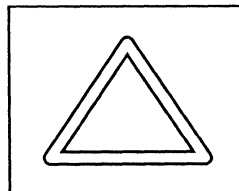

Select the duplicate poly, and **Lock** its fill. **Group** the two polys.

12

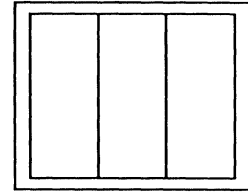

## Dividing a Box into Equal Parts

This technique works for dividing boxes either horizontally or vertically. It can also be used to divide horizontal or vertical lines. Work with **Gravity on** and **GridAlign off**.

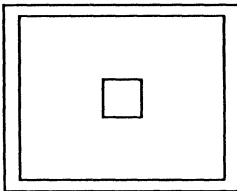

Create a **Box** inside the box you want to divide. Its shape and size do not matter.

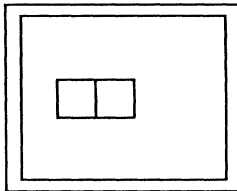

Dup the box and put the duplicate next to the first box.

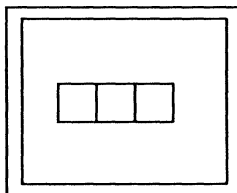

Repeat the previous step until you have as many boxes as you want to have parts in the box you are dividing.

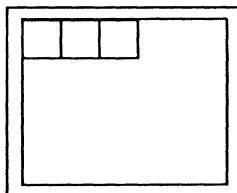

Move the small boxes to the upper left corner of the box you want to divide.

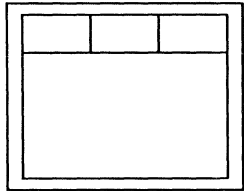

**Size** them horizontally until the edge of the last box touches the upper right corner of the box you want to divide. If you want the original box divided into three parts, go on to the next step. If you want three separate boxes, **Size** the small boxes vertically until their bottom edges touch the bottom of the original box, and execute the **Back** command. Select the original box, and **Cut** it.

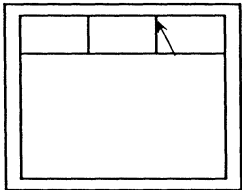

Point your mouse cursor at the top left corner of the right-hand box.

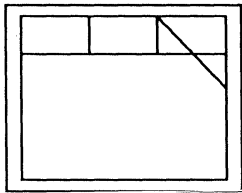

**Create a Line**. Do not deselect it.

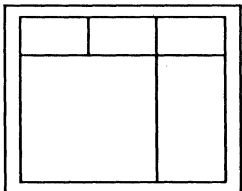

**Size the line** to a point and then **Size Vertical** to the bottom of the box you are dividing (Technique 1).

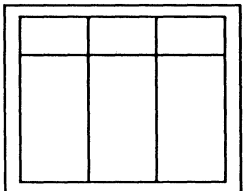

Select the line. With the mouse cursor near the top of the line, **Dup** it, and **Move Horizontal** until it lines up with the right edge of the first box.

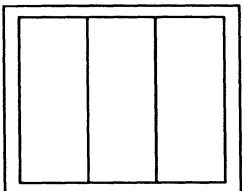

Select the little boxes and **Cut** them.

## Creating Objects with Curves

13

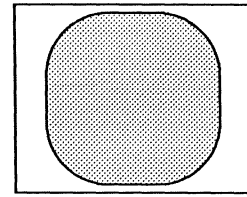

This technique was used to create one of the boxes with rounded corners in the *Basic* document in the *Shapes* folder in the *Graphics* cabinet. Follow these steps to create boxes with curves different from the ones provided in the *Basic* document, and alter the steps to create other polygons with rounded corners.

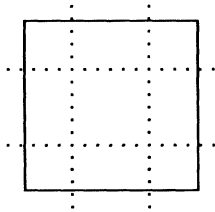

With the **Grid on**, **GridAlign off**, and **Gravity on**, **Create a Box**.

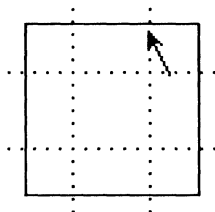

**Edit** the box. Place the cursor near the upper-right corner, where you want the curve to begin.

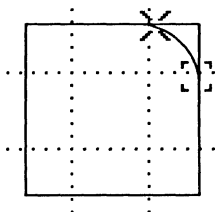

**Create a Clockwise Arc** at the corner. Make sure the end points of the arc are equal distances from the corner of the box.

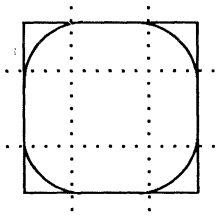

**Dup** the arc. **Size Reflect** the duplicate **Vertically**, and move it into the lower-right corner. To make the upper-right corner curve, **Size Reflect** a duplicate of the original arc **Horizontally**. To make the lower-left corner curve, **Size Reflect** a duplicate of the upper-left corner arc **Vertically**.

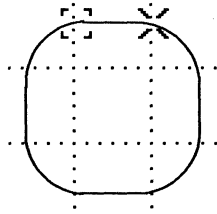

**Size** the sides the box to connect with the end points of the arcs. **Close** the edit.

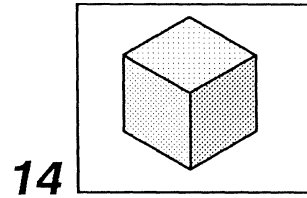

## Creating a Cube

This technique uses isometric projections.

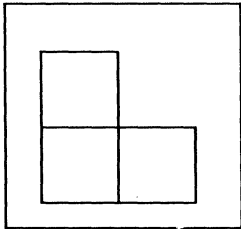

Create three square boxes. Position them in an *L* formation.

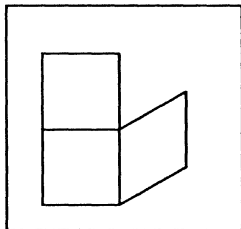

Select the lower-right box. Project it onto the X-Y plane (execute the **Misc Convert Projection to Iso X-Y** command).

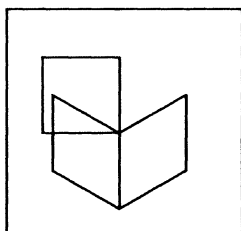

Select the lower-left box. **Project** it onto the Y-Z plane.

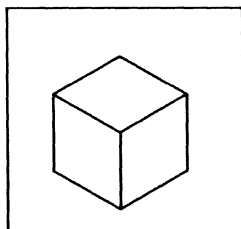

Select the last box. **Project** it onto the Z-X plane.

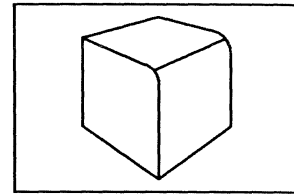

15

## Creating a Cube with Curves

This technique uses the **Zoom** command and arcs.

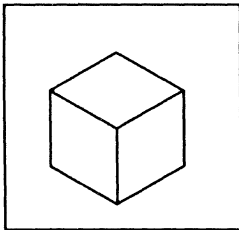
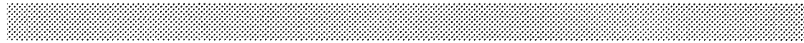

Create a cube. See Technique 14.

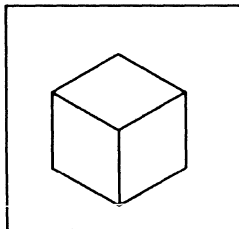

To convert the cube from three boxes to a collection of lines: select the three boxes; **Clear** the **Grouping** locks on them; select them again and **Ungroup** them.

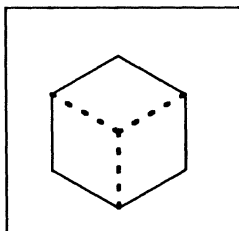

On each of the three edges where the boxes overlapped (shown at left as dotted lines), there are two identical edges, one on top of the other. Select and **Cut** a line at each of these edges.



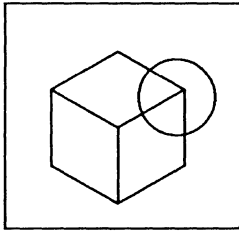

**Zoom** into the corner you want to round. Turn **Gravity on**.

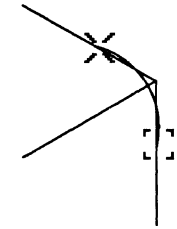

**Create an Arc.** Assisted by Gravity, position it so that the endpoints touch the sides of the corner.

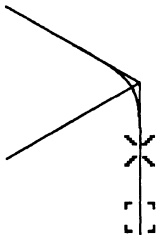

**Edit the tangent lines** at the endpoints of the arc so they line up with the two sides of the cube.



**Edit the midpoint** of the arc to make sure it connects with the third line.



**Size the vertical line** vertically so it touches the endpoint of the arc.

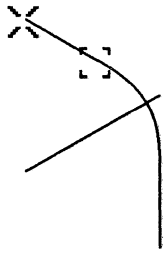

**Size** the uppermost line diagonally so it attaches to the other end of the arc.



**Size** the last line diagonally so it attaches to the midpoint of the arc.

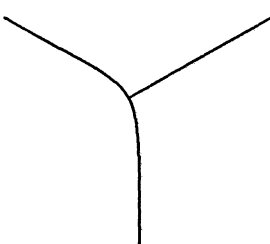

**Duplicate** the arc to use it on other corners.

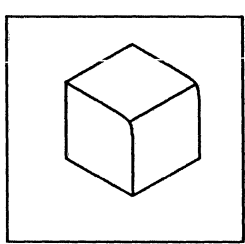

**Reset** the view.

16

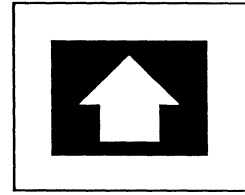

## Making a Reverse Arrow

This technique uses the *Graphics* cabinet. Before you begin, open the *Graphic* document in the *Arrows* folder.

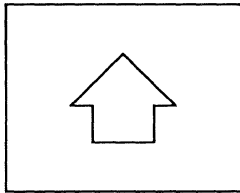

Select and Cut this arrow from the *Graphic* document. Paste it into your diagram.

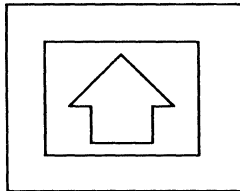

Create a **Box** larger than the arrow, and put it in back of the arrow. Select the box and the arrow, and **Align Centers**.

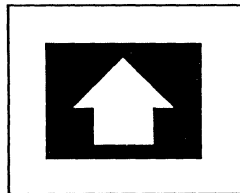

Select the box, and **Fill** it. Select the box and arrow, and **Group** them.

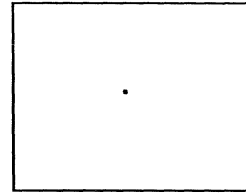

## Creating Control and Gravity Points

The active control point is the point on an object through which changes are controlled. You can create your own artificial control points and group them with objects. An artificial control point will be used as the active control point instead of the object's own control points.

You can also create gravity points using this technique by following the first three steps and not locking control. When **Gravity** is *on*, other objects will be attracted to these gravity points.

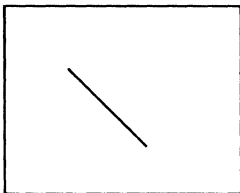

With **GridAlign** *on*, Create a Line.

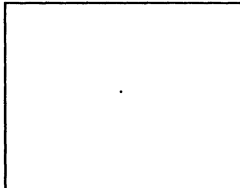

Size the line to a point. **GridAlign** will help you do this.

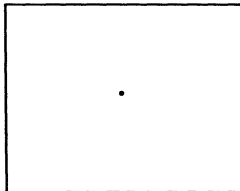

Change the point to a thicker **Width**. **Lock size, width, and control** on the point. Then you can position the point on an object where you want to control the object, and group it with the object.

## Building a Rotate Magnify Arrow

18

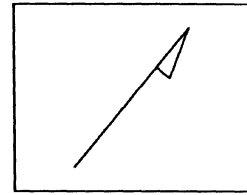

If you want a Rotate Magnify arrow with an arrowhead other than the ones we provide in the *Linear* document in the *Arrows* folder in the *Graphics* cabinet, use this technique to create it.

For this technique, **Gravity** should be *on*. It does not matter whether **GridAlign** is on or off.

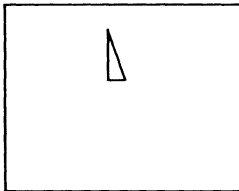

**Create** the **Lines** in the arrowhead first. **Group** the lines together to make a polygon.

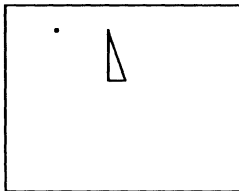

Create a control point (Technique 17), or copy one from the *Linear* document in the *Arrows* folder in the *Graphics* cabinet.

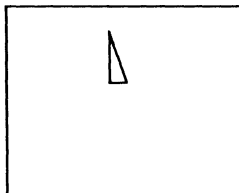

**Move** the control point to the tip of the arrowhead.

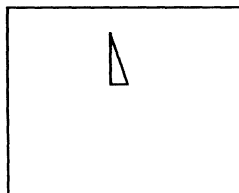

**Group** the arrowhead and the control point together. **Lock** gravity and size on the group.

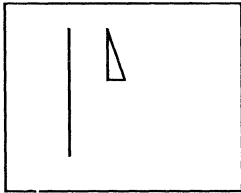

Create the arrow stem.

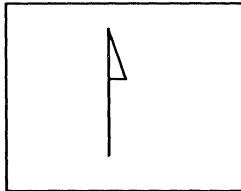

Move the tip of the arrow stem to the tip of the arrowhead.

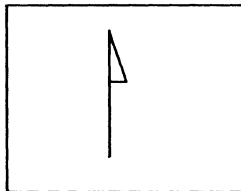

Group the stem and the arrowhead together. **Lock** grouping.

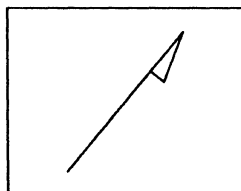

Use **Rotate Magnified** to change the angle of the arrow and the length of the stem without affecting the size or shape of the arrowhead or its relationship to the stem.

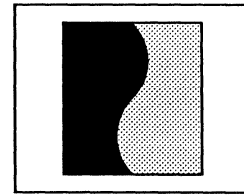

## Organizing Objects with Common Borders into Separate Polys 19

This method lets you regroup objects with adjoining sides so you can manipulate them as separate polys.

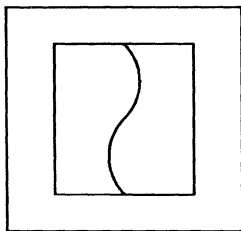

The diagram at left consists of three objects, as shown in exploded view below.

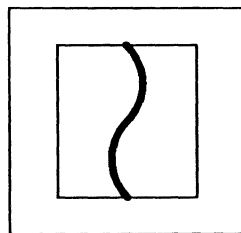
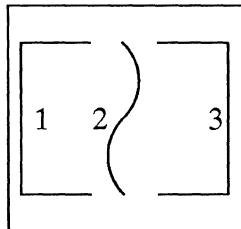

Select the common border, **Dup** it, and **Deselect** the duplicate *without* moving it.

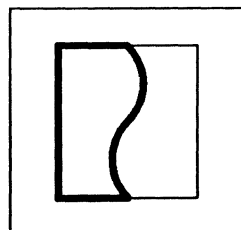

Use **Select Again** to select the duplicate border. Use the **right** button to add the left half of the object to the selection.

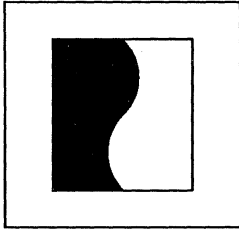

**Group** or **Fill** the selection; **Select Again** and move the new poly to the **Back**.

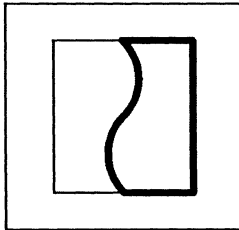

Select the original common border and the rest of the object.

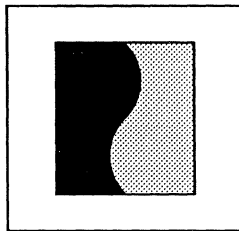

**Group** or **Fill** the selection. Now you can manipulate the two halves as separate polys.



## Creating a Floor Plan

17

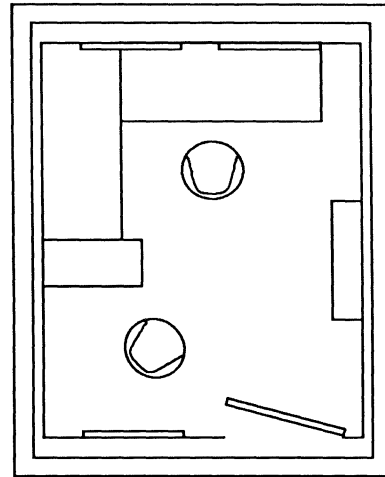

The **Spacing** command on the **Grid** submenu makes it possible for you to create your own grid tailoring it to the size of the room you want it to represent. Then you can measure your furniture, create objects of the right size to represent the furniture, and move them around electronically before you lift a finger to arrange the furniture in the real room.

This particular floor plan is for an office that is 8 feet by 10 feet. It was created originally in a frame  $8\frac{1}{2}$  by 11 inches and reduced to its present size for illustration purposes. The instructions are based on a page that is  $8\frac{1}{2}$  inches wide and 11 inches tall.

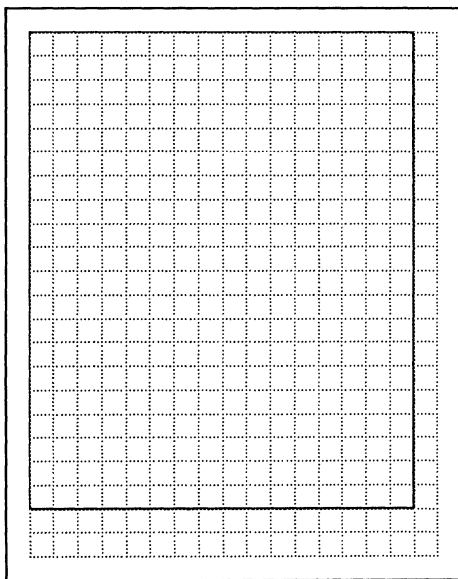

**Create a Document**, and make all the page and component margins **0**. **Create a Frame** the size of the page.

**Open** the frame, turn the **Grid on**. If you want the scale to be *1 screen inch = 1 foot*, each major grid unit to represent half a foot, and each minor grid unit to represent one inch, make the grid **Spacing .5 inches between major grid units and 6 minor grid units per major unit**. The grid will be 17 grid squares across and 22 grid squares down.

Starting at the upper left-hand corner of the frame, **Create a Box**, 16 grid squares across (representing 8 feet) and 20 grid squares down (representing 10 feet).

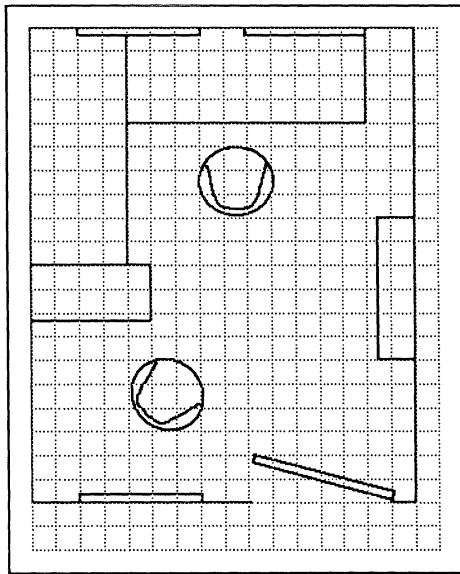

**Create** the door, windows, and furniture to scale. In this case, the door is 3 feet wide (**Lock size**, and **Rotate Magnified**); the two windows on the outside wall and the window on the wall with the door are 2.5 feet wide; the desk and table are 5 feet long and 2 feet deep; the chairs are 1.5 feet wide and 1.5 feet deep; the bookcase is 3 feet long and .75 feet deep; and the file cabinet beside the desk is 2.5 feet deep and 1.25 wide.

# Index

*Italicized numbers refer to pages on which figures appear.*

## A

- Abbreviations in Equations, 27-15–27-17
  - error messages and, 27-15
- Active Control Point
  - definition of, 19-12, 20-19
  - gravity and gridalign and, 20-22
  - Size command and, 21-8
- Active Window, 1-13
- Adjusting Spacing, in equations, 27-5, 27-15–27-16
- Algorithms, for frequency of hyphenation, 5-21–5-22
- Alignment
  - axes of alignment, 21-18
  - commands in diagramming, 21-18–21-22
  - component margins and, 9-14
  - of components, 4-24
  - of frames, 10-22
  - of groups in diagramming, 21-21, 21-21–21-22
  - keyboard commands and, 3-11
  - vertical justification and, 9-20
- Allow Break After, 9-13–9-16
- Allow Break Within, 9-13
- Anchor Points, 19-12
  - locations on diagramming objects, 20-3, 20-19–20-23
  - rotation of diagramming objects and, 21-10–21-11, 21-12–21-14
  - on very small objects, 20-22
- Anchors, showing, 6-3
- Animation Commands, in diagramming, 19-10–19-11
  - control and anchor points and, 19-12
  - definition of, 21-1
- Animation State, definition of, 19-11
- Arcs
  - bounding box on, 22-2–22-3
  - clockwise and counterclockwise, 22-3
  - conic center of, 22-2
  - control and anchor points on, 22-4–22-8
  - creating, 22-3
  - default of, 22-3
  - definition of, 22-1
  - editing, 22-6–22-8
  - endpoints of, 22-1, 22-1
  - midpoint of, 22-1, 22-1
  - modifying, 22-4–22-8
    - with Props Edit command, 22-6–22-8
    - with standard commands, 22-4–22-6
  - moving, 22-4
  - rotating, 22-5–22-7
  - sizing, 22-5
  - tangents to, 22-2
  - weighted center of, 22-2
- Arrowheads, 25-4
- Arrows
  - graphic, 25-6–25-9
    - circle arrow, 25-6
    - three-part, 25-7–25-9
    - two-part, 25-7, 25-8–25-9
  - linear, 25-3–25-5
- Arrows Folder, Graphics cabinet, 25-3–25-9
  - arrows in. *See* Arrows
- ASCII (Save) Command, 14-2–14-3
- ASCII Files, 30-15
  - printing, 30-15
- At Anchor Frames, 10-1, 10-15–10-16, 10-16
- Attributes
  - access to, 14-10
  - component, 4-25–4-26
  - printing and, 14-14, 30-5
  - revision bars, 14-12–14-14
  - for revision tracking, 14-10–14-14
  - strikethrough, 14-12
  - underline, 14-12
- Attributes Pulldown Menu, 14-11
- Autonumber Stream Property Sheet, 7-2
  - List, 7-3
  - for NEW stream, 7-4
  - Outline, 7-3
  - opening, 7-3
- Autonumber Token Property Sheet, 7-9–7-11
- Autonumbers
  - in books, 16-11
  - and Component Custom sheet, 7-7–7-9
  - last only, 7-6, 7-6

Autonumbers (cont.)  
 in microdocuments, 7-12  
 ordering of, 7-12—7-15  
 prefix and suffix, 7-5  
 spaces in, 7-5  
 purging, 7-11  
 show, 7-6—7-9  
 starting value, 7-5—7-6  
 streams  
   *See also* Streams  
   definition of, 7-1  
 symbol type, 7-5  
 tokens  
   creating, 7-2  
   definition of, 7-1  
   invisible  
     creating, 7-6  
     using, 7-15  
   properties of, 7-9—7-11

Autoreference Property Sheet, 7-13, 7-14

Autoreferences, 7-13—7-16  
 Copy Ref. command, 7-13  
 Create Ref. command, 7-14  
 creating  
   to a page number, 7-15—7-16  
   to an autonumber token, 7-13, 7-14—7-15  
 definition of, 7-13  
 property sheet, 7-14  
 tags  
   system assigned, 7-14  
   user generated, 7-14—7-15

## B

BACK SPACE Key  
 CTRL key alternative, 3-4  
 function keys and, 3-2

Back Command, 2-14—2-15

Backup Files, 14-5

Bar Chart  
 border settings, 28-32, 28-33  
 Data sheet, 28-10  
 fix option, 28-34, 29-16  
 options, 28-31—28-34, 29-12—29-18  
 placement of bars, 28-31, 29-17, 29-18, 29-16  
 Style sheet, 28-11  
 types of, 28-2, 28-3

Basic Document, Shapes folder, 25-22—25-23

Begin New Page, 9-10, 9-12, 9-20

Bold Command, text and, 4-31—4-33

Bold-Italic Typeface, 4-32

## Books

autonumbering in, 16-11—16-14  
 purging streams, 16-12—16-13  
 autoreferences in, 16-13  
 changing to another directory, 16-2  
 creating, 16-2—16-5  
 definition of, 16-1  
 dividing documents in, 16-7—16-10  
 effects of document order on printing and  
   page numbering in, 16-3  
 effects of hidden icons in, 16-5  
 features available in, 16-1  
 headers and footers in, 16-8—16-10  
 links in, 16-18—16-19, 16-19  
 page layout of documents in, 16-9—16-10,  
   16-10  
 page numbering issues in, 16-5—16-7  
 pasting documents into, 16-14—16-15  
 printing documents from, 16-15—16-16  
 scrolling between documents in, 16-17—16-18  
 shared information among contents of,  
   16-2—16-3  
 spell checking, search, and replace in, 16-18  
 sub-books in, 16-3—16-4  
 using Lineup command in, 16-4

Borders Document, Borders folder, 25-9—25-12

Borders Folder, Graphics cabinet, 25-9—25-14

Bounding Box, 11-7

Bulletin Board, sharing objects through, 15-17

Bullets, keystroke for obtaining, 3-12

## C

CAD drawings, 24-30—24-31

Calendar Template, 13-3, 13-3—13-4

Cancel Command, Component property sheet  
 popup, 4-20

Capitals Command, text and, 4-33—4-34

Capture Command, 26-4—26-5

Carets, 1-8

Center Command  
 in diagramming, 19-23  
 Text Location popup menu, 4-28

Change Command, components and, 4-18

Changing Fonts, in equations, 27-8—27-9  
 point size, 27-9  
 quotation marks and, 27-9  
 weight and slant, 27-9, 27-9

- Changing Objects in Diagrams. *See* Drawings, modifying; Duplicate Command, in diagramming; Move Commands, in diagramming; Objects in Diagramming; Rotate Commands, in diagramming; Size Commands, in diagramming
- Character String, 27-4, 27-4—27-5
- Charts
  - background settings
    - bar and line charts, 28-30
    - Chart Customize sheet, 29-12, 29-13
  - bar/gap size settings
    - bar chart, 28-33
    - Chart Customize sheet, 29-15
  - Copy Data command, 28-20
  - combining with other diagramming elements, 29-20—29-23
  - creating, 28-6—28-8
  - default size, 28-6
  - labeling, 28-29
  - making data changes, 28-12—28-23
    - See also* Edit Chart Sheets
  - margins, data and label, 28-26, 28-29, 29-14
  - Paste Data command, 28-17—28-20, 28-18
  - Property sheets. *See* Edit Chart Sheets
  - pasteing and copying data, 28-16—28-20
  - properties
    - all charts, 28-28—28-29
    - bar and line charts, 28-30—28-31
    - customized charts, 29-5—29-19
    - different among chart styles, 28-31—28-41
  - sizing, 28-1
  - spreadsheet data, incorporating into, 28-21—28-23
  - types of, 28-2, 28-3—28-5
    - See also* specific chart types
- Charts Folder, Graphics cabinet, 25-14, 28-6
- Checkpoint Files, 14-5—14-6
- Circumflex, in equations, 27-5, 27-5
- Clipboard, 2-18—2-22
  - 'from' icons on, 2-19—2-20
  - in diagramming, 21-15—21-16
  - overwriting on, 2-20
  - purging objects from, 2-21—2-22
- Closing
  - Desktop, 2-2
  - directories, 2-13
    - with open contents, 15-5
  - documents, 2-12
    - and saving, 2-13
- Column Balancing, 9-8
  - vertical justification and, 9-5
- Commands
  - See also* Specific commands
  - automatic repetition of, 3-4
  - default, on menus, 1-12—1-13
  - executing on menus, 2-3—2-5
  - how limited by windows, 15-4
  - keyboard, 3-5—3-16
- Component Bars, 1-14
  - in multicolumn documents, 9-16, 9-17
- Component Caret, 4-2
  - location, 4-9—4-10
  - paging and scrolling and, 4-40
- Component Location Popup Menu, 4-3
  - Create command, 4-11—4-12
  - Find commands, 4-16—4-18
  - Join command, 4-16
  - Paste command, 4-36—4-38
  - Select commands, 4-13—4-14
- Component Property Sheets
  - Custom sheet, 4-19, 4-26
    - and autonumbering, 7-7—7-9
    - designating contents of tables of contents with, 17-19, 17-20
  - Format sheet, 4-19, 4-21—4-27
    - Attributes line on, 14-11
  - Page sheet, 9-12, 9-12—9-16
  - Tab sheet, 4-42—4-44, 4-43
- Component Selected Popup Menu, 4-3
  - Change command, 4-18
  - Cut and Copy commands, 4-34
  - Deselect command, 4-16
  - Props command, 4-19
  - Select commands, 4-14—4-19
- Components
  - alignment of, 4-24
  - attributes, 4-25—4-26
  - changing, 4-18
  - combining, 4-16
  - creating, 2-29—2-32, 4-10—4-12
  - definition of, 4-1
  - deselecting, 4-15—4-16
  - finding, 4-16—4-18
  - fonts, 4-24—4-25
  - Global Apply and, 2-27—2-28
  - in multicolumn documents, 9-14—9-16
  - LINE FEED and, 4-12
  - margins between
    - soft, 9-14
    - stretch and shrink, 9-9
  - master definitions of, 4-5
    - creating, 4-5—4-6
    - deleting, 4-7—4-9
  - naming, 4-21—4-22

- Components (cont.)
    - negative indentation and, 4-23
    - property sheets. *See* Component Property Sheets
    - Show command and, 4-45–4-46
    - selecting, 4-13–4-15
    - splitting, 4-16
    - straddling, 9-14–9-15
  - Conic Section, definition of, 22-1
  - Control Points, 19-12
    - Draw command and, 24-8
    - in equations, setting, 27-16, 27-16
    - on fixed-width microdocuments, 23-5
    - on graphic text, 25-18
    - gravity and, 19-17
    - on images, 26-2
    - locations on arcs, 22-4
    - locations on diagramming objects, 20-3–20-4, 20-19–20-23
    - Size command and, 21-8
    - on text strings, 23-15
    - on very small objects, 20-22
  - Copy Command
    - basic procedure, 2-18
    - in diagramming, 21-16
    - inside documents, 2-19–2-20
    - Link to option, 15-12–15-14
    - and permissions, 15-10
    - text and, 4-34
  - Copying Documents, Rename command and, 14-3–14-4
  - Crash Files, 14-6, 14-7
  - Crash Recovery, 2-5
  - Create Cabinet, 13-9–13-13
    - and Create submenu, 13-9
    - changing command order, 13-13
    - customized, 13-10–13-13
      - adding your own templates to, 13-10
      - links to documents, 13-12
      - links to other cabinets, 13-11–13-12
      - sample, 13-12–13-13
      - sharing with other users, 13-10–13-11
      - on the desktop, 13-10
      - master, 13-9
      - system supplied templates, 13-9
  - Create Command
    - components and, 4-11–4-12
    - and permissions, 15-10
  - Create Misc Equation Command, 27-2
  - Create SubEdit Commands, in diagramming, 24-4–24-9
    - See also* SubEdit Commands
  - Create Submenu, for icons, 15-3
  - Create TOC Command, 17-1
  - Creating, basic procedures, 2-29–2-31
  - Cross References, 7-13–7-16
    - See also* Autoreferences
    - in an index document, 17-2
  - CTRL Key Sequences, 3-4–3-5
  - Curly Braces in Equations, 27-7, 27-7–27-8
  - Current Command, Fonts submenu, 4-29
  - Cursor Shapes, 1-8
  - Cursors
    - in diagramming, 19-1–19-2
    - drawing, 24-8
    - in document window, 4-2
  - Custom Sheet, of Index property sheets, uses of, 17-13–17-14
  - Customize Sheet, Charts, 29-1–29-19, 29-2
    - entering data on, 29-3–29-5
    - opening, 29-1
    - properties for fine tuning, 29-5–29-19
    - rsu's and, 29-3–29-4
  - Cut Command
    - basic procedure, 2-19
    - in diagramming, 21-16
    - inside documents, 2-19–2-20
    - and links, 15-14
    - and permissions, 15-10
    - text and, 4-34
- ## D
- Dashed and Dotted Lines, for diagramming objects, 20-8–20-9
  - Data Border Settings
    - Chart Customize sheet, 29-12
    - for all chart types, 28-28
  - Data Margins, 28-26
    - for all chart types, 28-28
  - Data Sheet, Charts, 28-9, 28-10, 28-12–28-23
    - copy and paste data into, 28-16–28-20
    - entering data on, 28-12–28-13
    - keyboard commands for making changes, 28-15
  - Default Commands
    - fundamentals of, 1-12–1-13
    - in diagramming, 24-24–24-29
    - environment, 24-24, 24-28

- object, 24-25—24-26
- popup, 24-26—24-28
  - dynamic defaults, 24-26
- Define Keyword in Equations, 27-15
- Deselect Command, components and, 4-16
- Deselection Commands, in diagramming, 19-10—19-24
  - definition of, 21-1
- Desktop
  - links to, 15-17—15-18
  - opening and closing, 2-2
  - organization of, 1-2, 15-2—15-5
- Desktop Cabinet, sharing objects through, 15-17—15-18
- Desktop Create Menu
  - changing command order, 13-13
  - changing commands on, 13-10—13-13
- Desktop Dictionary, 5-7—5-11
  - adding words to, 5-9
  - editing, 5-10—5-11
- Desktop Nothing Selected Popup Menu, 15-3
- Detents, 21-9—21-10
- Devices, icons for, 1-9
- Diacritical Marks, in equations, 27-14, 27-16
- Diagram Icons, 21-15
- Diagramming Objects. *See* Objects in Diagramming
- Diagramming Order, Front and Back commands in, 19-2—19-4
- Diagramming System
  - access to, 19-1
  - Clipboard in, 21-15—21-16
  - commands in. *See* specific diagramming commands
  - creating symbols for use in, 25-25
  - cursors in, 19-1—19-2
  - defaults in, 24-24—24-29
  - gravity, 19-17
  - grid and gridalign, 19-13—19-16
  - header/footer frames and, 12-2—12-3
  - images and, 26-2
  - kinds of text in, 23-1
  - locks in, 24-10—24-17
  - objects in. *See* Objects in Diagramming
  - opening and closing frames, 19-1
  - rulers for use in, 25-21
  - screen images and, 26-5—26-7
  - selecting objects, 19-2—19-9
    - See also* Selection and Deselection, in diagrams
  - text in, 25-17—25-20
    - See also* microdocuments; text strings
    - graphic
      - control points on, 25-18
      - italicizing, 25-19
      - samples of, 25-20
- Diagramming Techniques, C-1—C-32
- Diagrams
  - See also* Diagramming System; Objects in Diagramming
  - adding CAD drawings to, 24-30—24-31
  - aligning objects in, 21-18—21-22
  - borders for, 25-9—25-12
  - creating symbols for use in, 25-25
  - cutting, copying, and pasting objects in, 21-15—21-17
  - kinds of text in, 23-1
  - moving objects in, 21-1—21-4
  - undoing changes in, 21-23—21-24
- Dictionary, 5-1
  - desktop, 5-7—5-9
  - master, 5-7
  - system, 5-7, 5-11—5-12
- Dictionary Object Property Sheet, 5-8
- Directories
  - closing, 2-13
  - creating, 2-29—2-32
  - icons for, 1-9
  - linked copies of, 15-12—15-14
  - opening, 2-12
- Dividers Document, Borders folder, 25-12
- Document Format, Fast and ASCII, 14-2—14-3
- Document Locked Stickup Menu, 15-15
- Document Name Pulldown Menu, 14-2
  - Save commands on, 14-2
- Document Name Token, 3-13
- Document Page Property Sheets, 9-1—9-4
  - Custom sheet, 9-6—9-11, 9-7
  - implications for books on, 16-5—16-7, 16-8—16-10
  - Normal sheet, 9-2—9-4, 9-3
  - opening, 9-2
  - page references in indexes and, 17-8, 17-9
- Document Windows, 1-14—1-15
  - active documents in, 11-2
  - cursors and carets in, 4-2
  - effects of commands in, 11-4—11-6
- Documentation, on-line, 1-5
- Documentation Drawer, Reference folder, 27-8
  - Math Notes, 27-12, 27-14

- Documents
  - cancel opening, 2-12—2-13
  - closing, 2-12
  - creating, 2-29—2-32
  - icons for, 1-9
  - linked copies of, 15-12—15-14
  - locks for, 15-15—15-16
  - opening, 2-12
  - property sheets for. *See* Document Page Property Sheets
  - renaming, 14-3—14-4
  - saving, 2-12
  - saving and closing, 2-13
  - structured, 1-3
- Double-Sided Pages, 12-12—12-13
- Dow Jones Chart, creating and sizing, 29-7—29-11
- Draw Command, in diagramming, 24-7—24-11
  - creating drawings with, 24-8
- Drawing Cursor, 24-8
- Drawing to Scale in Diagrams, using GridAlign, 19-14
- Drawings
  - CAD, 24-30—24-31
  - modifying, 24-9
- Duplicate Command, in diagramming, 21-14—21-15

## E

- Edit Chart Sheets, 28-9—28-11
  - Customize sheet, 28-9, 29-1—29-19, 29-2
  - Data sheet, 28-9, 28-10, 28-12—28-23
  - opening, 28-9
  - Style sheet, 28-9, 28-11, 28-24—28-41
- Edit Commands, in diagramming, 24-1—24-9
  - and the Undo command, 24-3—24-4
- Editing Drawings, 24-9
  - See also* Wipe-Select Mode
- Ellipses Document, Shapes folder, 25-22
- Entries, in an index document, 17-2
- Envelope Template, 13-6
- Eqn, 27-1, 27-9, 27-16, 27-17
- Equation Edit Sheet, 27-2—27-3
  - scrolling fields in, 27-3
- Equations
  - baselines of, 27-16, 27-17

- brackets, 27-10
- changing fonts, 27-8—27-9
- control points of, 27-16
- creating, 27-2
  - and diagramming, 27-2, 27-16, 27-17
- editor, 27-1, 27-4
- grouping parts of, 27-7—27-8
- in-line, 27-1, 27-16
- separators in. *See* Keywords in Equations
- spacing, 27-5, 27-16
- special characters in, 27-11—27-12
  - interpretation of, preventing, 27-8
  - table of codes, 27-12
- superscripts and subscripts in, 27-6

Error Handling, in property sheets, 2-28

- Error Messages
  - in equations
    - abbreviations, 27-15
    - curly braces, 27-8
    - quoting characters, 27-8
  - in status line, 1-16

ESC Key, function keys and, 3-2

## F

- Family Command, Fonts submenu, 4-30—4-31
- Fast (Save) Command, 14-2—14-3
- Feathering, 8-6
- Files
  - backup, 14-5
  - checkpoint, 14-5—14-6
  - crash, 14-6, 14-7
  - damaged, 14-6—14-7
  - document, 14-5
- Fill Property
  - diagramming vs. images, 26-7
  - for objects in diagramming, 20-4—20-7
    - paths and polys, 20-14—20-16
- Find Commands
  - components and, 4-16—4-18
  - searching for objects with, 6-1
- Fixed-Width Microdocuments, 23-4—23-9
  - control and anchor points on, 23-5
  - creating, 11-13—11-14, 23-5
  - moving, 23-7
  - sizing, 23-6—23-7
- FlowCharts Folder, Graphics cabinet, 25-14—25-16



- Flowcharts
    - adding text to, 25-15—25-16
    - creating, 25-15
  - Flush Input Command, operating system and, B-5
  - Following Anchor Frames, 10-2, 10-17—10-18, 10-18
  - Following Text Frames, 10-2, 10-18—10-19, 10-19
  - Fonts
    - See also* Typefaces
    - changing, in equations, 27-8—27-9
    - of components, 4-24—4-25
    - decimal character values and, 3-12
    - definition of, 8-3
    - graphic, 25-17—25-20
      - control points on, 25-18
      - samples of, 25-17, 25-20
    - keyboard commands and, 3-9—3-10
    - text caret and, 1-8
    - of text, 4-29—4-33
    - for text strings, 23-12—23-13
  - Fonts Commands, text and, 4-29—4-33
  - Fonts Folder, Graphics cabinet, 25-17—25-20
  - Fractions, 27-6—27-7
    - keyboard commands and, 3-14—3-15
  - Frame Anchors
    - definition of, 10-1
    - Show command and, 4-45—4-46
    - visibility of, 10-26
  - Frame Masters, major aspects of, 10-5
  - Frame Property Sheet, 10-10, 10-10—10-25
    - frame alignment, 10-22—10-26
    - frame placement, 10-15—10-22
    - frame size, 10-10—10-11
    - Same Column as Anchor setting, 10-25
    - Shared Contents setting, 10-11—10-15
      - cautions in using, 10-15
      - updating master definitions with, 10-12—10-13
  - Frames
    - See also* Header/Footer Frames; Text-Anchored Frames
    - alignment of, 10-22—10-25, 10-23, 10-24
    - creating, 2-30
    - definition of, 1-4
    - Global Apply and, 2-27—2-28
    - in multicolumn documents, 10-26—10-28, 10-28
    - in-line, creating, 13-4—13-5
    - kinds of text in, 11-1
      - margins between, 9-9—9-10
      - master definitions of, 10-5—10-9
        - changing, 10-6—10-7
        - changing properties of. *See* Frame Property Sheet, Shared Contents setting
        - creating new, 10-5—10-6
          - from pasted master, 10-9
        - deleting individual, 10-8
        - pre-release 3.0, 10-9
        - purging, 10-7—10-8
      - opening and closing, 2-17, 19-1
      - placement of, 10-15—10-22
        - at anchor frames, 10-15—10-16, 10-16
        - bottom, 10-20—10-21, 10-21
        - following anchor, 10-17—10-18, 10-18
        - following text, 10-18—10-19, 10-19
        - top, 10-19—10-20, 10-20
      - properties of. *See* Frame Property Sheet
      - selecting and deselecting, 2-17
      - selection state of, 2-17
      - shared content, 10-11—10-15
  - Front and Back Commands
    - in diagrams, 19-2—19-4
    - in microdocuments, 6-4
  - Front Command, 2-14—2-15
  - Function keys, keyboard, 3-2, 3-3
  - Functions, 27-11
  - 'from' Icons, overwriting of, 2-20
- ## G
- Global Apply Command, 2-27
    - Component property sheet popup, 4-20
    - on Index property sheets, 17-11—17-12, 17-12
    - and microdocuments, 11-4—11-6
  - Global Replacement, 6-11—6-12
  - Graphic Document, Arrows folder, 25-6—25-9
  - Graphic Fonts, 25-17—25-20
  - Graphic Objects, icons for, 1-9
  - Graphics Cabinet
    - diagramming objects in, 25-1
    - documents in
      - Arrows folder, 25-3—25-9
      - Borders folder, 25-9—25-14
      - Charts folder, 25-14
      - FlowCharts folder, 25-14—25-16
      - Fonts folder, 25-17—25-20
      - Maps folder, 25-21
      - Measure folder, 25-21
      - Notes document, 25-2

Graphics Cabinet  
 documents in (cont.)  
   Sampler document, 25-2  
   ScratchPad document, 25-2—25-3  
   Shapes folder, 25-21—25-24  
 notation in, 25-2  
 System drawer, 25-1

Graphics Templates  
 types of  
   11x17land, 13-3  
   11x17port, 13-3  
   3pitchGrid, 13-2—13-3  
   4pitchGrid, 13-2—13-3  
   6pitchGrid, 13-2—13-3  
   8.5x11land, 13-3  
   8.5x11port, 13-3  
   Calendar, 13-3—13-4  
   PointSizeFrames, 13-4—13-5  
 uses of, 13-2

Gravity, 19-17  
 effects of, example, 19-18  
 Gravity Radius command, 19-17  
 gravity points, 19-17—19-19  
 gravity radius, 19-17  
   adjusting, 19-17  
   and images, 26-2  
   main uses of, 19-17

Greek Letters in Equations, 27-13—27-14

Grid, 19-13—19-14  
 creating, 24-18—24-21  
   Front/Back command, 19-15—19-16, 19-16  
 isometric, 24-19—24-24  
 modifying, 24-18—24-21  
 On/Off command, 19-15  
 screen display of, 24-19  
 Type command, 19-13, 24-20

Grid and GridAlign, 19-13—19-16

Grid Spacing Command, creating grids with,  
 24-18—24-19

GridAlign, 19-14—19-15

Group Command, in diagramming, 20-12  
 creating a group with, 24-4—24-5

Groupers Document, Borders folder,  
 25-12—25-13

Grouping, parts of equations, 27-7—27-8

Groups, 20-10—20-13  
 control and anchor points on, 20-20, 20-21  
 creating with Group command, 24-4—24-5  
 creating with Object Selected popup menu,  
 20-12—20-13  
 definition of, 20-1

editing, 24-1—24-3  
 modifying, 20-13  
 moving objects between, 24-9—24-10

Gutter Width, 9-5, 9-7

## H

Hard Spaces, keyboard commands for, 3-14

Hash Marks  
 bar and line charts, 28-30  
 Chart Customize sheet, 29-13, 29-14

Header Boxes, features of, 1-14—1-15

Header Page, 30-2

Header/Footer Frames  
*See also* Frames  
 adjusting size of, 12-14—12-16  
   with frame width bleed, 12-15,  
   12-15—12-16  
 closing, 12-8  
 definition of, 12-1  
 deleting text from, 12-4—12-5  
 diagramming objects in, 12-2—12-3  
 document names inside of, 12-8  
 and double-sided page layout, 12-12—12-13,  
 12-14  
 editing, 12-5  
   microdocuments in, 12-7  
 entering text in, 12-3—12-5  
   using Control Key sequences, 12-4  
   using text anchors, 12-3—12-4  
 major features of, 12-2  
 paginating documents in, 12-8—12-11  
 possible uses of, 12-1—12-2  
 reflecting contents of, 12-7, 12-7—12-8, 12-14  
 and single-sided page layout, 12-11—12-12

Headings  
 in an index document, 17-2  
 on the Index property sheets, inserting and  
 deleting, 17-5—17-6

Highlighters Document, Borders folder, 25-13

Holes in Diagramming Objects, 20-15—20-16

Hyphenation, 5-12—5-23  
 and Component Custom property sheet, 5-13  
 limiting consecutive hyphens, 5-20—5-21  
 and Page Custom property sheet, 5-13  
 and various text alignments, 5-12  
   justified text, 5-20—5-21  
   ragged text, 5-19—5-20

Hyphenation Points, 5-13  
 changing in desktop dictionary, 5-17—5-19  
 definition of, 5-1

guidelines for setting and clearing, 5-14—5-19  
 preserving manually-set, 5-16—5-17  
 seeing location of, 5-16

## I

Icon Selected Popup Menu, 15-2

### Icons

changing type of, 15-8  
 on the clipboard, 2-19—2-20  
 creating, 2-29—2-32  
 image, 26-1—26-2  
   *See also* Graphic Objects  
 and the Object property sheet, 15-5  
 read permission and, 15-9—15-11  
 states and appearances of, 15-1—15-2  
 types of, 1-9—1-13  
 write permission and, 15-9—15-11

### Images

capturing, 26-3  
 diagram icon, 26-2  
 diagramming and, 26-2  
 graphic icon, 26-1  
 image icon, 26-1—26-2  
 moving, 26-2  
 pasting into documents, 26-1—26-2  
 selecting, 26-2  
 sources of, 26-1  
 storing, 26-2

In-line Equations, 27-1, 27-16

In-line Frames, creating, 13-4—13-5

Indentation, component, 4-23

Index Command, 17-1

Index Document, 17-2

creating, 17-6  
 creating a sample for practice, 17-17—17-19  
 creating specialized indexes. *See* Custom Sheet, of Index property sheets  
 default style of, 17-14—17-17, 17-15  
   changing, 17-17  
 editing, using Revert command to update, 17-26  
 elements of, 17-2  
 Master index, 17-7  
 Normal index, 17-6—17-7, 17-7  
 naming, 17-13  
   precautions in, 17-13, 17-25  
 updating and correcting, 17-17

Index Property Sheets, 17-4—17-5

  Custom sheet, uses of, 17-13—17-14

Format sheet, 17-5

  range of page reference, 17-9—17-11  
   typeface of page reference, 17-8  
 Global Apply and, 17-11—17-12, 17-12

Index Tokens, 17-3—17-4

  creating, 17-3  
   in microdocuments, 17-4  
   Show command and, 4-45—4-46

Indexing, elements of, 17-2

Inherit, on Document Page property sheet, effect on documents in books, 16-5, 16-6

Integrals, 27-13, 27-13

Interrupt Stickup

  commands on, 2-5  
   crash recovery and, 2-5  
   how to call up, 2-4  
   uses of, 1-17

Invisible Lines, for diagramming objects, 20-8

Isometric Grids, 24-19—24-24

  definition of, 24-19  
   Move command and, 24-21  
   spacing for, 24-21

Isometric Planes, 24-22—24-23

Italic Command, text and, 4-31—4-33

## J

Join Command, components and, 4-16

Justified Text, 4-24

## K

Keyboard

  function keys on, 3-2, 3-3  
   layout of  
     Greek, 3-17  
     Math A, 3-17  
     Math B, 3-17  
     Math Extension, 3-17  
     Standard, 3-17  
     Sun 3 keyboard, 3-3  
     Symbols, 3-17

Keyboard Commands

  canceling with, 3-15—3-16  
   cutting, copying, and pasting with, 3-8  
   deleting text with, 3-7  
   fonts and, 3-9—3-10  
   fractions and, 3-14—3-15  
   Interrupt stickup and, 3-15—3-16

## Keyboard Commands (cont.)

LINE FEED, 4-12  
 moving text caret and, 3-5—3-7  
 searching and replacing with, 3-9  
 spaces and, 3-13—3-14  
 special characters and, 3-12  
 spell checking and, 3-10  
 text attributes and, 3-10  
 text string alignment and, 3-11  
 tokens and, 3-13

## Keys

arrow, 3-5  
 BACK SPACE, 3-2  
 CTRL, 3-4—3-5  
 ESC, 3-2  
 function, 3-2—3-3  
 LINE FEED, 3-11

## Keywords in Equations, 27-6

interpretation of, preventing, 27-8

## list of

above, 27-11  
 back, 27-15—27-16  
 bold, 27-9—27-15  
 cpile, 27-10  
 define, 27-15—27-17  
 down, 27-15—27-16  
 fat, 27-9  
 from, 27-12—27-13  
 fwd, 27-15—27-16  
 italic, 27-9—27-15  
 left, 27-10  
 lineup, 27-16  
 lpile, 27-10  
 mark, 27-16  
 over, 27-6—27-7  
 pile, 27-11  
 right, 27-10  
 roman, 27-9—27-15  
 rpile, 27-10, 27-15  
 size, 27-9  
 sqrt, 27-7—27-8  
 sub, 27-6  
 sup, 27-6  
 to, 27-12—27-13  
 up, 27-16  
 summary of, 27-17  
 undefined, 27-17

## L

Label Margins, for all chart styles, 28-29

Last Command, Fonts submenu, 4-29

Leading. *See* Typography, line spacing

Letter Template, 13-6

LINE FEED Key, creating components with,  
 2-30, 3-11, 4-12

Limits, in equations, 27-13

Line Chart, 28-10—28-11

Data sheet, 28-10  
 options, 28-35—28-39  
 Style sheet, 28-11  
 types of, 28-4, 28-35

Line Point, definition of, 25-5

Line Spacing, 4-23

feathering and, 8-6, 9-10  
 vertical justification and, 8-6

Linear Document, Arrows folder, 25-3—25-5

Linear On/Off Command, in diagramming, 24-8

Lines Document, Borders folder, 25-13—25-14

Links, 15-12—15-14

advantages of, 15-12  
 in books, 16-18—16-19, 16-19  
 editing linked objects, 15-14  
 to other desktops, 15-17—15-18  
 ownership of linked objects, 15-13—15-14  
 permissions for linked objects, 15-13—15-14  
 properties of linked objects, 15-12—15-13  
 and the Rename command, 15-14

Locators, in an index document, 17-2

style of, 17-8

## Locks

in diagramming, 24-10—24-17

angle, 24-13  
 aspect, 24-11—24-12  
 control, 24-14—24-15  
 cutting, 24-17  
 fill, 24-16  
 font, 24-16—24-17  
 functions of, 24-10  
 gravity, 24-17  
 grouping, 24-16  
 position, 24-15  
 printing, 24-17  
 Set submenu, 24-10  
 selection, 24-12—24-13  
 setting and clearing, 24-10—24-11  
 showing, 24-11  
 size, 24-15—24-16  
 smoothness, 24-17  
 width, 24-16

document, 15-15—15-16

overriding, 15-15—15-16

non-lockable documents and, 15-16

Login Procedure, 2-2

Logout Procedure, 2-2—2-3

## M

Maps Folder, Graphics cabinet, maps in, 25-21

### Margins

- altering on Chart Style sheet, 28-25, 28-26, 28-27
- between components, stretch and shrink, 9-9
- between frames, 9-9
- between straddles and columns, 9-15—9-16
- inappropriate, 9-19
- page, 9-1, 9-4, 9-9
- soft, 9-14

### Master Definitions

- the clipboard and, 2-21
- component, 4-5
  - creating, 4-5—4-6
  - deleting, 4-7—4-9
- properties and, 2-27

Master Index, 17-7

### Mathematical Terms, 27-11

- interpretation of, preventing, 27-8
- table of codes, 27-11

Measure Folder, Graphics cabinet, 25-21

Memo Template, 13-6

### Menus

- Component Location, 4-3
- Component Selected, 4-3
- canceling, 2-3
- Diagramming, Create Misc Equation, 27-2
- default commands on, 1-12—1-13
- dynamic, 4-11—4-12
- executing commands on, 2-3—2-5
- list of, A-1—A-13
- popup, how to call up, 2-3
- pull-down, how to call up, 2-3
- stickup, 2-4—2-5
- submenus, how to call up, 2-4
- Text Location, 4-4
- Text Selected, 4-4

Merge Command, in autonumbering, 7-10—7-11

Messages, how delivered, 1-16—1-17

- status line, 1-16—1-17
- stickup menus, 1-16—1-17

Microdocument Page Property Sheets,

- 11-18—11-20, 11-19
- Custom sheet, 11-20

Normal sheet, 11-19

### Microdocuments

*See also* Fixed-Width Microdocuments; Variable-Width Microdocuments

- autonumber streams in, 7-12, 11-5
  - See also* Autonumbers, in microdocuments
- beginning a search in, 6-5—6-6
- Cut, Copy, and Paste commands and, 11-14—11-15
- changing font of, 23-8
- changing from variable- to fixed-width, 11-12—11-13, 23-4
- closing, 11-18
- creating, 2-31, 11-9—11-15
- default component of, 11-8
- definition of, 11-1
- as diagramming objects, 23-1—23-9
  - modifying, 11-22—11-23, 23-6—23-8
- editing, 11-16—11-22
  - in header/footer frames, 12-7
- editing and closing, 23-8—23-9
- effects of commands on, 11-4—11-6
- empty, 11-13—11-14
- in bounding box, 11-7
- index tokens in, 11-5
- main documents and, in document windows, 11-2—11-4, 11-3
- opening, 11-16
- pagination in, 12-9—12-10
- rotating, 23-7—23-8
- scrolling in, 11-17
- sizing, 11-20—11-22, 11-21
- undoing changes in, 23-8
- unique layouts using, 11-23—11-28
- when to use each type, 11-9

Mouse, 1-7—1-8

Mouse Cursor, 1-8, 4-2

### Move Commands

- icons and, 15-4
- in diagramming, 21-2—21-4
- isometric, 24-21
- and permissions, 15-10

### Multicolumn Documents

- column balancing in, 9-8
- components in, 9-14—9-16
- creating, 9-5
- frames in, 10-26—10-28, 10-28
- gutter width in, 9-7
- pagination in, 9-5—9-6
  - problems in, 9-18—9-20
- straddling in, 9-14—9-15
- using Custom sheet for fine-tuning, 9-6
- vertical justification in, 9-9—9-10
- word spacing in, 9-5, 9-6, 9-20

## N

- Newsletter, sample layout using microdocuments, 11-26—11-28, 11-27
- Newsletter Template, 13-6
- NO TAG, 7-13
- Notes Document, Graphics cabinet, 25-2
- Null String, 6-9
- Numbering. *See* Autonumbers

## O

- Object Editor, definition of, 19-1
- Object Properties
  - changing, 15-7—15-12
  - defaults and, 15-7
  - permissions and, 15-8
- Object Property Sheet, 15-5—15-11, 15-6
  - change and access time on, 15-9
  - changing permissions on, 15-8
  - and group, 15-7
  - Icon Type, 15-8
  - of linked object, 15-13
  - and object ownership, 15-6
  - and others category, 15-7
- Objects in Diagramming, 19-1
  - See also* Graphic Fonts; Graphics Cabinet, documents in; Microdocuments; Text Strings
  - aligning, 21-18—21-22
  - animation state of, 19-11
  - arcs, 22-1—22-8
  - clipboard and, 21-15—21-16
  - control and anchor points on, 20-3, 20-19
  - creating, 2-30—2-31, 20-2—20-3, 25-25
  - cutting, pasting, and copying, 21-15—21-17
  - default properties of, 20-2, 24-24—24-29
  - definition of, 20-1
  - duplicating, 21-14—21-15
  - editing, 24-1—24-3
  - effect of Gravity and GridAlign on, 20-3
  - filling, 20-14—20-16
  - gravity points on, 19-18—19-19
  - grouping, 20-10—20-13
  - in header/footer frames, 12-2—12-3
  - with holes, 20-15, 20-15—20-16
  - images and, 26-2
  - locks for, 24-10—24-17
  - moving, 21-1—21-4
  - paths, 20-14

- polys, 20-14—20-15
- primitive, 20-1—20-3
- properties of, 20-4—20-9
- rotation of, 21-8—21-14
- selecting, 19-2—19-9
- selection state of, 19-10
- sizing, 21-4—21-8
- splines, 20-17—20-19
- types of, 20-1
- undoing changes to, 21-23—21-24
- On-line Documentation, Reference folder, Math Notes, 27-12, 27-14

Open Command, and permissions, 15-10

Origin Line

- bar and line charts, 28-31
- Chart Customize sheet, 29-12

Orphan, control of, 9-12—9-13

Outline Template, 13-7

Oval Point, definition of, 25-5

Ownership, of desktop objects, 15-6—15-7

## P

Page

- orientation, 9-3—9-4
- properties, 9-1—9-2
  - See also* Page Makeup
- range, on Index property sheets, 17-9
- width and height, 9-4

Page # Prefix, on Document Page property sheet, use of in books, 16-7

Page # Style, on Document Page property sheet, effect on documents in books, 16-5

Page Box, in document header, 4-39

Page Commands, on Page pulldown menu, 4-39—4-41

Page Makeup

- See also* Microdocuments, unique layouts using
- Allow Break After, 9-13—9-16
- Allow Break Within, 9-13
- Begin New Page, 9-10
- double-sided layout, 12-12—12-13
- multiple column. *See* Multicolumn Documents
- orphan and widow control, 9-12—9-13
- property sheets used in. *See* Component Page Property Sheet; Document Page Property Sheets
- single-sided layout, 12-11—12-12

Page Number Token, 3-13

- Pagination
  - automatic
    - with header/footer frames, 12-8—12-11
    - in microdocuments, 12-9—12-10
  - problems in, 9-18—9-20
- Paste Command, 2-20—2-21, 4-34
  - component and page information and, 2-21
  - in diagramming, 21-17
  - and permissions, 15-10
  - for text, components, and documents in document window, 4-36—4-38
  - what is pasted, 2-20
- Pathname, of linked object, 15-12—15-13
- Paths, definition of, 20-14
- Permissions
  - and document locking, 15-16
  - read and write for objects, 15-9—15-11
  - renaming and, 14-3
- Picas, 8-1
- Pickup Command, Fonts submenu, 4-30
- Pie Chart, 28-5
  - combinations, 28-39, 28-40, 28-41
  - options, 28-39
- Pixel Editor, definition of, 19-1
- PointSizeFrames, uses of, 13-4—13-5
- Points, 8-1—8-2
  - in Linear document
    - line, 25-5
    - oval, 25-5
  - uses of, with control and gravity points, 25-5
- Poly Borders, 25-11—25-14
- Poly Command, in diagramming, creating polys with, 24-5—24-6
- Polys, definition of, 20-14
- Popup Menus
  - default commands on, 1-12—1-13
  - definition of, 1-11, 1-11
  - how to call up, 2-3
- Primitive Objects
  - See also* Objects in Diagramming
  - definition of, 20-1
- Print Menus, 2-23, 30-8—30-9
  - defaults on, 2-23
- Printer and Screen Resolution, 19-19—19-20
- Printer Maintenance, 30-19
- Printer Property Sheet, 30-1—30-7
- Printer Queue Command, 30-18—30-19
- Printerleaf Files, 30-11—30-14
  - creating, 30-12
  - printing, 30-13—30-14
  - usefulness of, 30-11
- Printing
  - ASCII files, 30-15
  - attributes and, 14-14
  - basic procedure, 2-23
  - canceling, 30-11
  - closed documents, 30-9—30-10
  - double-sided, 30-3—30-4
  - manual sheet feed, 30-4
  - menus for, 30-8
  - open documents, 30-10
    - Current Page and, 30-8
    - default printer setting and, 30-7
  - Printerleaf files, 30-11—30-14
  - page margins and, 30-17
  - page orientation and, 30-16—30-17
  - page size and, 30-16—30-17
  - revision bars and, 14-14
  - strikethrough and, 14-14
  - text attributes and, 30-5
  - underlining and, 14-14
- Printing Property Sheet, 14-14
- Projections, in diagramming
  - isometric, 24-21—24-23, 24-23
  - orthographic, 24-21—24-23
- Properties
  - default object properties, 15-7
  - how to change, 2-24—2-28
- Property Sheets, 2-24—2-28
  - applying changes on, 2-26—2-28
  - autonumber stream. *See* Autonumber Stream Property Sheet
  - autonumber token. *See* Autonumber Token Property Sheet
  - autoreference. *See* Autoreference Property Sheet
  - canceling changes on, 2-27
  - charts. *See* Edit Chart Sheets
  - closing, 2-27
  - component. *See* Component Property Sheets
  - definition of, 1-18
  - documents. *See* Document Page Property Sheets
  - editing, 2-25—2-26
  - entering text in, 2-25—2-26
  - equations. *See* Equation Edit Sheet
  - error handling in, 2-28
  - frames. *See* Frame Property Sheet
  - Global Apply and, 2-27
  - icons. *See* Object Property Sheet
  - indexes. *See* Index Property Sheets

Property Sheets (cont.)  
list boxes in, 2-26  
microdocuments. *See* Microdocument Page  
Property Sheets  
objects on desktop. *See* Object Property Sheet  
opening, 1-18, 2-24  
printer. *See* Printer Property Sheet  
switching, 2-24—2-25  
toggle boxes in, 2-26  
types of, 2-24  
Unify and, 2-27

Proportional Spacing, 8-6

Props (Properties) Command, 2-24  
components and, 4-19  
icons and, 15-5  
and permissions, 15-10  
text and, 4-47

Protecting Diagrams and Drawings. *See* Locks

Pulldown Menus  
basic procedure, 2-3  
default commands on, 1-12—1-13  
description of, 1-11

Purge Command, 2-21—2-22  
autonumber streams and, 7-11  
and permissions, 15-10  
permissions and, 2-22

## Q

Quotation Marks, double, in equations, 27-8

Quoting Characters, in equations, 27-8, 27-8  
error messages and, 27-8

## R

Raster Editor, definition of, 19-1

Read-only Objects, 15-11

References, 7-13—7-16  
*See also* Autoreferences

Refresh Command, 2-16

Release Notes, on-line, 1-5

Rename Command  
cautions on using in books, 16-14  
copying open documents with, 14-3—14-4  
and linked objects, 15-14  
Revert command and, 14-3  
saving renamed documents, 14-4

Rename Stickup Menu, 14-3

Repeated Shape Borders, 25-10

Replace Command  
on the keyboard, 3-9  
using, 6-2

Replace Operations, 6-9—6-13  
keyboard commands and, 6-13—6-14  
terminating, 6-14

Replacement String, 6-9

Report Template, 13-7

Reset Command  
Component property sheet popup, 4-21  
in diagramming, 19-21

Resolution  
definition of, 8-10  
screen vs printer, 8-10—8-11

Restart Command, in autonumbering,  
7-10—7-11

Returns  
deleting and inserting, 4-46—4-47  
Show command and, 4-45—4-46

Revert Commands, 14-7—14-9  
canceling, 14-9  
global replace and, 6-9  
index and TOC documents and, 17-25

Revision Bars, 14-12—14-14  
in microdocuments, 14-14  
placement of, 14-13—14-14

Revision Tracking, 14-10—14-14

Rotation Commands, in diagramming,  
21-8—21-14  
using detents with, 21-9—21-10

Rsu's, 29-3—29-5

Rulers, for use in diagramming, 25-21

## S

Safety Measures, 1-6—1-18  
backup, checkpoint, and crash files,  
14-5—14-9  
document locks, 15-15—15-16

Sampler Document, Graphics cabinet, 25-2

Sans Serif, 8-4

Saving Documents, 2-12  
ASCII and Fast formats, 14-2—14-3  
and closing, 2-13  
forced saves, 14-3  
Revert Command and, 14-8

Scale Flags, 29-5—29-11  
and Dow Jones Chart, 29-7—29-11



- ScratchPad, creating charts in, 28-6—28-8
- ScratchPad Document, Graphics cabinet, 25-2—25-3
- Screen Capture
  - creating, 26-3
  - through the desktop, 26-4
  - through the operating system, 26-4—26-5
  - features of, 26-3
  - menu, 26-4
- Screen Images
  - diagramming and, 26-2, 26-5—26-7
  - recapturing, 26-5, 26-6, 26-7
- Scroll Bars, 1-13, 2-15—2-16
- Scrolling Methods, 4-40
  - Center command and, 4-28
- Search Command, on the keyboard, 3-9
- Search Operations, 6-6—6-8
  - keyboard commands and, 6-13
  - terminating, 6-14
- Search Paths, 6-3—6-6
  - forward and backward searches, 6-3
  - frames, 6-4
  - microdocuments, 6-4—6-6
- Search String, 6-6
- See(Also), on Index property sheets, 17-10—17-11
- Select Commands, components and, 4-13—4-15
- Select Locked Command, in diagramming, 24-13
- Selection and Deselection
  - basic procedures, 2-6—2-11
  - of components, 2-9—2-10, 4-13—4-26
  - of diagramming objects, 2-6—2-8
  - drag selection, 2-7
  - of everything in a frame, 2-8
  - of everything in a window, 2-8
  - of icons, 2-6—2-8
  - of images, 26-2
  - in diagrams
    - filled and unfilled objects, 19-4, 19-5
    - group vs. multiple selections, 20-10—20-11
    - methods of, 19-2—19-9
    - with popup menu commands, 19-6—19-8
  - menu commands and, 2-10
  - mouse buttons and, 1-7
  - of text, 2-11, 4-28
- Selection Box, 19-6
- Selection Cursor, in diagramming, 19-2
- Separators, in equations, 27-4
- Serif, 8-4
- Shapes Folder, Graphics cabinet, 25-21—25-24
  - samples of, 25-24
- Shared Content Frames, 10-11—10-15
  - autonumbering in microdocuments in, 10-15
  - cautions in using, 10-15
  - pasting between documents, 10-14—10-15
  - search and replace and spell checking in, 10-15
- Shift Command, in diagramming, 19-24
- Show Command, Text Location Misc submenu, 4-45—4-46
  - finding invisible anchors and tokens with, 6-3
- Single-Sided Pages, 12-11—12-12
- Size Commands
  - in diagramming, 20-3, 21-4—21-8
  - control points and, 21-8
  - Fonts submenu, 4-31
- Sort Strings, customizing for an index document, 17-14
- Source Document, 17-2
- Spaces
  - after punctuation, 8-9
  - between words, 8-7
  - creating, 8-7—8-9
  - em, 8-8
  - points to inches, 8-8
  - en, 8-8
  - hard word, 8-8
  - in equations, 27-5
    - adjusting, 27-15—27-16
  - keyboard commands and, 3-13—3-14
  - soft word, 8-7, 8-9
  - thin, 8-8—8-12
- Special Characters, ESC key and, 3-12
- Spell Checking
  - correcting errors, 5-5—5-6
    - and Spelling Suggestion sheet, 5-5—5-6
  - keyboard commands and, 3-10
  - searching for errors, 5-2—5-4
    - in microdocuments, 5-4
  - spelling conventions and, 5-2
- Spelling Errors, searching for, 5-2—5-4
- Spline Command, in diagramming, creating splines with, 24-7
- Splines
  - converting to polys, 20-18—20-19
  - creating with Object Selected popup menu, 20-17—20-19
  - creating with Spline command, 24-7
  - definition of, 20-17

Split Command, components and, 4-16

Spreadsheet Programs, using, to create a bar chart, 28-21—28-23

Square Roots, 27-7, 27-7—27-8

Stacking, in creating line charts, 28-35, 28-36, 28-37

Stars Document, Shapes folder, 25-23—25-24

Starting Page #, on Document Page property sheet, effect on documents in books, 16-5—16-6

Status Line, messages in, 1-16

Stickup Menus, 2-4—2-5

- executing commands on, 2-4
- Interrupt stickup, 2-4—2-5
- uses of, 1-17

Sticky Commands, in diagramming, 24-27

Straddles, 9-14—9-16, 9-15

- definition of, 9-14
- empty, 9-18, 9-19

Streams

- associating with a component, 7-7—7-9
  - duplicated tokens, 7-8—7-9
- autonumber, definition of, 7-1
- creating new, 7-3—7-4
  - examples, 7-6—7-7, 7-7
- default, 7-2
- levels
  - maximum number of, 7-4
  - properties for each, 7-5
  - setting up, 7-4—7-6
  - skipping levels, 7-2
- Merge command, combining two streams, 7-11
- property sheet. *See* Autonumber Stream Property Sheet
- Restart command
  - beginning new streams, 7-10
  - splitting streams, 7-10
- removing, 7-11

Strikethrough, 14-12

- keyboard commands and, 3-10

Structured Document Editing, 1-3—1-5

Style Sheet, Charts, 28-9, 28-11, 28-24—28-41

- entering data on, 28-24

Sub-books, definition of, 16-3

SubEdit Commands, in diagramming, 24-1—24-9

- Create SubEdit Draw, 24-7—24-9
- Create SubEdit Group, 24-4—24-5, 24-5
- Create SubEdit Poly, 24-5—24-6

Create SubEdit Spline, 24-7

SubEdit Levels, in diagramming, 24-2—24-3, 24-28—24-29

Submenus

- description of, 1-12
- how to call up, 2-4

Summations, 27-12—27-13, 27-13

Sun Workstations, keyboard layout of, 3-3—3-5

Superscripts and Subscripts, in equations, 27-6

Surface Charts, 28-3

System Cabinet

- Create cabinet, 13-9
- content of, 1-5

System Dictionary, 5-11—5-12

System Drawer, Graphics cabinet, 25-1

## T

Table, sample layout using microdocuments, 11-23, 11-23—11-28

Table of Contents

- and the Component Custom sheet, 17-20—17-21
- creating, 17-21
- creating a sample for practice, 17-24
- default style of, 17-22, 17-22—17-23
- designating contents of, 17-19—17-21
- editing, 17-23—17-24
  - using a template for, 17-23
  - using Revert command to update, 17-26
- key elements of, 17-19
- naming, precautions in, 17-19, 17-25

Tabs

- appearance of, 4-44
- Show command and, 4-45—4-46
- setting, 4-41—4-47
- Tab property sheet, 4-42—4-44

Tags, 7-13—7-15

- See also* Autoreferences, tags

Templates

- creating, 2-29—2-32, 13-7
  - design considerations, 13-8—13-9
  - purging masters, 13-8
- definition of, 13-1
- samples of, 13-13
- system supplied, 13-1—13-7
  - accessing, 13-2
  - Graphics templates, 13-2—13-5
  - Text templates, 13-5—13-8
- uses of, 1-4

- Terminal, icon for, 1-10
- Terminal Icon, *B-1*
  - See also* Virtual Terminal
  - behavior of, B-1
  - Copy command and, B-1—B-6
  - Cut command and, B-1
- Terminal Window
  - cursors in, B-2
  - resizing, B-2—B-3
- Text
  - copying using keyboard, 3-8
  - cutting using keyboard, 3-8
  - deleting using keyboard, 3-7
  - in diagrams
    - control points on, 25-18
    - graphic, samples of, 25-20
  - in diagrams, 23-1
  - kinds of, 11-1
  - in frames, 2-31
    - identifying, 11-1
    - kinds of, 11-1
  - open command and, 3-11
  - pasting using keyboard, 3-8
  - replacing, 6-10—6-13
  - searching for, 6-6
  - selecting, 4-28
- Text Anchors
  - Show command and, 4-45—4-46
  - text strings and, 23-10—23-11
    - in header/footer frames, 12-3—12-4
  - visibility of, 10-26
- Text Caret, 4-2, 4-27
  - centering in window, 4-28
  - component caret and, 4-27
  - keyboard commands and moving, 3-5—3-7
  - paging and scrolling and, 4-40
- Text Location Popup Menu, 4-4
  - Center command, 4-28
  - Create command, 4-11—4-12
  - Fonts commands, 4-29—4-33
  - Paste command, 4-36—4-38
  - Split command, 4-16
- Text Selected Popup Menu, 4-4
  - Cut and Copy commands, 4-34
  - Deselect command, 4-28
  - Fonts commands, 4-29—4-33
  - Props command, 4-47
- Text Strings
  - changing alignment of with Size commands, 23-14
  - control points on, 23-15
  - creating, 2-31—2-32, 23-10
  - definition of, 23-10
  - editing, 23-11—23-12
  - editing in groups, 23-18
  - and fonts, 23-12—23-13
  - keyboard commands and, 3-11
  - and line spacing, 23-13—23-14
  - modifying as diagramming objects, 23-14—23-16
  - realigning, 23-16—23-18
  - and text anchors, 23-10
- Text Templates
  - types of
    - Envelope, 13-6
    - Letter, 13-6
    - Memo, 13-6
    - Newsletter, 13-6
    - Outline, 13-7
    - Report, 13-7
  - uses of, 13-5
- Text-Anchored Frames
  - See also* Frames
  - alignment of. *See* Frames, alignment of
  - creating, 10-2—10-4
    - automatic, 10-3—10-4
  - definition of, 10-1
  - placement of, 10-15—10-22
    - at anchor frames, 10-1, 10-15—10-16, 10-16
    - bottom, 10-2, 10-20—10-21, 10-21
    - following anchor, 10-2, 10-17—10-18, 10-18
    - following text, 10-2, 10-18—10-19, 10-19
    - top, 10-2, 10-19—10-20, 10-20
- Texture Settings, for all chart styles, 28-29
- Three-Dimensional Grids, 24-19—24-24, 24-20
- Tilde, in equations, 27-5, 27-5
- TOC Doc Name, on Component Custom sheet, designating contents of a TOC with, 17-19
- Tokens
  - autonumber. *See* Autonumbers, tokens
  - document name, 12-9
  - in Frames, 3-13
  - index, 17-3—17-4
  - page number, 12-9
  - showing, 6-3
  - uses of, 1-4
- Troubleshooting, pagination problems, 9-18—9-20
- Type
  - ascender, 8-2
  - baseline, 8-2
  - descender, 8-2
  - families, 8-2

Type (cont.)

- italic, 8-3
- point size, 8-2, 8-2
- roman, 8-3
- serif and sans serif, 8-4
  - definition of, 8-4
  - when to use, 8-4
- slant, 8-3, 8-3
- weight, 8-3, 8-3
- x-height, 8-2

Typefaces

- choosing, 8-4
- definition of, 8-3
- Interleaf, character sets of, 8-11—8-12
  - Classic, 8-11
  - Greek, 8-12
  - Mathematics, 8-12
  - Modern, 8-12
  - Symbols, 8-12
  - Typewriter, 8-12

Typography

- books about, 8-11
- character spacing, 8-6
- line spacing, 8-6
  - vertical justification, 8-6
- page makeup
  - column width, 8-9
  - hyphenation, 8-5
  - justified columns, 8-5
  - justified or ragged columns, and hyphenation, 8-5
  - ragged right columns, 8-5
- practices, 8-9—8-10
  - indenting text, 8-9
  - new paragraphs, 8-10
  - quotation marks, opening and closing, 8-10
  - spaces after punctuation, 8-9
- principles of, 8-1
- units of measure, 8-1—8-2

## U

Underline, 14-12

- keyboard command and, 3-10

Undo Command, in diagramming, 21-23—21-24

- editing and, 24-3—24-4

Unify Command, 2-27

- Component property sheet popup, 4-20—4-21
- on Index Property sheets, 17-12
- and microdocuments, 11-4

User Interface, tools in, 1-7

## V

Variable-Width Microdocuments

- alignment of, 11-9—11-10, 23-2—23-3
- converting to fixed-width, 11-12
- creating, 11-7—11-8, 11-9—11-12, 23-2
- definition of, 23-2
- moving, 23-7
- sizing, 23-7

Variables, in equations, 27-4

Version Command, checking software version with, 14-9

Vertical Justification, 9-5, 9-8—9-11

- definition of, 8-6
- feathering and, 8-6
- in multicolumn documents, 9-9—9-11
- variables related to, 9-9—9-10

Vertical Stacks, in equations, 27-10—27-11

View Commands, in diagramming, 19-21—19-24

Virtual Terminal

- See also* Terminal Icon
- access to the operating system with, B-1
- active terminal, B-6
- copying and pasting
  - from, B-4—B-5
  - within, B-3—B-4
- definition of, B-1
- exiting from, B-5—B-6
- icon for, 1-10

## W

Widow, control of, 9-12—9-13

Width Property, for diagramming objects, 20-7, 20-7—20-9

Windows, 2-13—2-16

- active and inactive, 1-13
- commands and, 15-4
- directory, 1-13
  - closing, 2-13
  - hidden icons in, 15-5
- document, 1-14—1-15
  - closing, 2-12—2-13
  - header boxes in, 1-14—1-15
- fundamentals of, 1-13—1-15
- maximum number, 1-2
- moving, 2-14
- opening, 2-12
- Refresh command and, 2-16
- resizing, 2-13—2-14
- scrolling contents of, 2-15—2-16



stacking order of, 2-14–2-15  
Window popup menu, 2-13  
Wipe-Select Mode, 19-8–19-9  
  cursor and, 19-8  
Write-Only Objects, 15-11

## **Z**

Zoom Command, in diagramming, 19-21–19-22





