

System 136

# Source Entry Utility Guide



**When You Are:**

Planning to  
Install Your  
Computer

Getting Your  
Computer  
Ready to Use

Operating  
Your  
Computer

**Operating and  
Using the  
Utilities**

Programming  
Your  
Computer

Communicating  
with Another  
Computer or  
Remote Device

Determining  
the Cause  
of a Problem

**You Can Find Information In:**

What to Do Before Your Computer Arrives  
or  
Converting from System/34 to System/36

Setting Up Your Computer  
Performing the First System Configuration For Your System  
System Security Guide

Learning About Your Computer  
Operating Your Computer

**Source Entry Utility Guide**  
Data File Utility Guide  
Creating Displays  
Work Station Utility Guide  
Utilities Messages

Concepts and Programmer's Guide  
System Reference  
Sort Guide  
Work Station Utility Guide  
(language manuals)  
(language message manuals)

(communication manuals)  
(communication message manuals)

System Messages  
(message manuals)  
System Problem Determination

**IBM** System/36

**Source Entry Utility Guide**

File Number  
S36-32

Order Number  
SC21-7901-2

### **Third Edition (April 1985)**

| This major revision obsoletes SC21-7901-1. Changes or additions to the text and illustrations are indicated by a vertical line to the left of the change.

Changes are periodically made to the information herein; any such changes will be reported in subsequent revisions or Technical Newsletters.

| This edition applies to Release 3, Modification Level 0, of IBM Utilities Program Product (Program 5727-UT1), and to all subsequent releases and modifications until otherwise indicated in new editions or Technical Newsletters.

References in this publication to IBM products, programs, or services do not imply that IBM intends to make these available in all countries in which IBM operates. Any reference to an IBM licensed program in this publication is not intended to state or imply that only IBM's licensed program may be used. Any functionally equivalent program may be used instead.

Publications are not stocked at the address given below. Requests for IBM publications should be made to your IBM representative or to the IBM branch office serving your locality.

This publication could contain technical inaccuracies or typographical errors. A form for readers' comments is provided at the back of this publication. If the form has been removed, comments may be addressed to IBM Canada Ltd., Information Development, Department 849, 1150 Eglinton Avenue East, Don Mills, Ontario, Canada M3C 1H7. IBM may use whatever information you supply in any way it believes appropriate without incurring any obligation to you.

# Contents

<b>About This Manual</b> .....	<b>vii</b>
Who should use this manual .....	vii
How this manual is arranged .....	vii
What you should know .....	viii
If you need more information .....	viii
While you use this manual .....	ix
Summary of changes .....	x
<b>Chapter 1. What Is SEU?</b> .....	<b>1-1</b>
Why Use SEU .....	1-2
Before You Begin .....	1-3
First You Need to Sign On To SEU .....	1-5
Name of Member to be Created or Updated .....	1-6
Type of SEU Member .....	1-6
Name of Member Containing SEU Formats .....	1-6
Length of Statement .....	1-6
Name of Library Containing Member .....	1-6
After You Sign On To SEU .....	1-7
Displays That Guide You .....	1-8
Examples Using SEU .....	1-9
How to Enter Statements Using Enter/Update .....	1-9
How to Make Changes to Statements Using Enter/Update .....	1-15
How to Copy or Move Statements .....	1-18
How to Relocate Statements Using Copy/Move .....	1-18
How to Copy Statements Using Copy/Move .....	1-22
How to Remove Statements Using Delete .....	1-25
How to End the Job .....	1-27
Statement Numbers Are Only Temporary (Renumbering) .....	1-29
Don't Worry About Hurting Your Data .....	1-31
If You Need Some Help .....	1-32
Recovery .....	1-32
<b>Chapter 2. While Using SEU</b> .....	<b>2-1</b>
How SEU Asks You For Information .....	2-2
Name of Member to be Created or Updated .....	2-2
Type of SEU Member .....	2-3
Name of Member Containing SEU Formats .....	2-4
Length of Statement .....	2-5
Name of Library Containing Member .....	2-5
After You Have Identified the Member .....	2-6
Keys with Special Assignments .....	2-8
Command Keys .....	2-9
Autoskip (Cmd 1) .....	2-9
Scan/Replace (Cmd 2) .....	2-9
Select Display (Cmd 3) .....	2-9
Delete (Cmd 4) .....	2-9
Enter/Update (Cmd 5) .....	2-9
Print (Cmd 6) .....	2-9
End Of Job (Cmd 7) .....	2-10
Syntax (Cmd 8) .....	2-10
Search End of Source (Cmd 9) .....	2-10
Copy/Move (Cmd 10) .....	2-10
Include (Cmd 11) .....	2-10
Accept with Error (Cmd 12) .....	2-10
Command Key Display (Cmd 13) .....	2-11
Scan to Update (Cmd 14) .....	2-11
Change Roll Factor (Cmd 15) .....	2-11
Lines Per Stmt (Cmd 16) .....	2-11
Translate (Cmd 17) .....	2-11
Function Keys .....	2-12
Home .....	2-12
Dup .....	2-12
Help Key .....	2-15
Roll Up (Roll ↑) .....	2-16
Roll Down (Roll ↓) .....	2-17
Using the Roll Keys .....	2-17
Cursor Movement Keys .....	2-18
Field Exit .....	2-18
Field + .....	2-18
Field Advance .....	2-18
Field Backspace .....	2-18
New Line Key .....	2-18
Line 1 is the Status Line .....	2-19

Statement Numbering	2-21
How Statements Are Numbered	2-21
Adding Statements to a Member	2-21
Inserting Statements	2-22
How to Find a Statement in a Large Member	2-22
What About a Printer	2-23
Printing a Member	2-24
End of Job	2-25
Source Members at End of Job	2-25
End-of-Job Options	2-25
End-of-Job Maintenance	2-26
Procedure Members at End of Job	2-29
End-of-Job Options	2-29
End-of-Job Maintenance	2-30
<b>Chapter 3. Using SEU</b>	<b>3-1</b>
Creating or Updating Source and Procedure Members	3-2
Adding Statements	3-3
Changing Statements	3-3
Removing Statements	3-4
Copying or Moving Statements	3-5
How to Insert More than 99 Statements	3-7
Copying Statements from One Member to Another	3-8
Include Prompts	3-11
Locating and Replacing Characters in a Member	3-13
How to Look through a Member Using Scan (without Making Changes)	3-13
Scan Prompts	3-15
Scan and Replace	3-17
Replace Prompts	3-20
When Scan and Replacement Characters Aren't Equal in Length	3-22
How to Make Changes to a Statement During a Scan	3-26
Print Option for Replace	3-28
Scan and Replace Using Ideographic Characters	3-29
Considerations	3-29
Translating Messages	3-31
Inserting Translations	3-34
Summarizing Message Translation	3-34
<b>Chapter 4. Displays To Guide You</b>	<b>4-1</b>
SEU-Supplied Displays	4-2
What the Displays Do for You	4-3
The Order of the Displays When Entering a Member	4-5
The Order of the Displays When Making Changes	4-5
What Type of Field Is It?	4-6
Alphanumeric Fields	4-7
Numeric Fields	4-7
Protected Fields	4-7
Autoskip Fields	4-7
Constant Fields	4-7
Controlled Field Exit (Auto-Exit Field)	4-7
Adjust/Fill (Right-Adjust Field)	4-8
Ideographic Fields	4-9
More Details About the SEU Displays	4-10
Free-Form	4-10
RPG II and Auto Report	4-11
Checking Syntax of RPG II and Auto Report Statements	4-12
Error Detection	4-12
Comments	4-12
Work Station Utility (WSU)	4-13
SFGR	4-15
SFGR-S	4-15
SFGR-H	4-15
SFGR-D	4-15
D-Cont	4-15
DOC-H	4-15
SFGR and WSU Format Prompting	4-16
Command	4-18
Assembler	4-18
FORTRAN IV	4-18
COBOL	4-18
AUTOR	4-18
Message	4-19
Sort	4-19
Magnetic Character Reader	4-19
Display Lengths Can Be Different from Statement Lengths	4-20
<b>Chapter 5. Attention Programmers</b>	<b>5-1</b>
There Is a Shortcut to Calling SEU	5-1
SEU Procedure Command	5-2

An SEU Run Sheet .....	5-5
How SEU Uses Storage Space .....	5-6
What if There's not Enough Space? .....	5-8
How to Recover from Interruptions: Planned or Unplanned .....	5-9
SEU-Supplied Displays in a Format Member .....	5-10
Creating and Changing Displays .....	5-11
Restrictions .....	5-11
When You Should not Change a Display's Name .....	5-12
Storing New or Changed Displays .....	5-12
<b>Glossary .....</b>	<b>X-1</b>
<b>Index .....</b>	<b>X-5</b>





## About This Manual

### ***Who should use this manual . . .***

The *System/36 Source Entry Utility Guide* is an introduction to SEU for the new or experienced SEU user.

### ***How this manual is arranged . . .***

Chapter 1 gives you a general description of what the Source Entry Utility (SEU) is and how it works. It shows you how to sign on, steps you through a quick general description of how to use SEU, and in this chapter, shows you how to enter or update a member. If you want to follow the example, you should make the highlighted entries.

Chapter 2 begins the detailed section of the manual with *While Using SEU*. It describes things you will see when using SEU, such as the SEU parameters, the status line, the command keys, the statement numbering, the printer, and what your choices are at the end of a job.

Chapter 3 discusses in detail how SEU can be used. (Chapter 1 gives you a quick example of how SEU can be used). Chapter 3 is for reference when using SEU.

Chapter 4 discusses the displays that are available with SEU to guide you as you enter statements. These displays were introduced briefly in Chapter 1.

Chapter 5 is for the programmer or anyone who wants more detailed information on SEU. This chapter includes a sample SEU run sheet and explains how SEU uses disk space.

## ***What you should know . . .***

You should be familiar with data processing concepts (such as disk, file, and members) and with System/36 and its display stations as described in *Learning About Your Computer*, SC21-9018.

You should also be familiar with the operation of your display station as described in the *Operator's Guide* for your particular display station.

You should know how to use the keys on your keyboard, such as:

- Cursor movement keys
- Command keys
- Field exit keys
- Insert and delete keys
- Error reset key.

## ***If you need more information . . .***

You might need some of the information in these manuals while using the *SEU Guide*:

- *Operating Your Computer*, SC21-9026, tells how to sign on or off the system, explains how to reply to messages, and answers general questions about operating the system.
- *System Reference*, SC21-9020, can be used for reference when using procedures, commands, and operation control language (OCL).
- *System Messages*, SC21-7938, lists the system messages you may see when using the system.
- *Utilities Messages*, SC21-7939, explains the messages you may see when using the system utilities.

## ***While you use this manual . . .***

If you would like more details about WSU, SDA, DFU, or Sort, see:

- *Work Station Utility Guide*, SC21-7905
- *Creating Displays: Screen Design Aid and System Support Program*, SC21-7902
- *Data File Utility Guide*, SC21-7900
- *Sort Guide*, SC21-7903

If you would like more details about RPG II, COBOL, BASIC, FORTRAN IV, or Assembler, see:

- *Programming with RPG II*, SC21-9006
- *Programming with COBOL*, SC21-9007
- *Programming with BASIC*, SC21-9003
- *Programming with FORTRAN IV*, SC21-9005
- *Programming with Assembler*, SC21-7908

If you would like more detail about System/36 forms, see:

- *RPG Control and File Description Specifications*, GX21-9092
- *RPG Extension and Line Counter Specifications*, GX21-9091.
- *RPG Input Specifications*, GX21-9094
- *RPG Calculation Specifications*, GX21-9093
- *RPG Output Specifications*, GX21-9090
- *RPG Auto Report Specifications*, GX21-9139
- *RPG Indicator Summary*, GX21-9095
- *RPG Telecommunications Specifications*, GX21-9116

- *RPG Debugging Template*, GX21-9129
- *COBOL Coding Form*, GX28-1464
- *FORTTRAN Coding Form*, GX28-7327
- *Assembler Coding Form*, GX21-9279
- *Translation Table and Alternate Collating Sequence Coding Sheet*, GX21-9096
- *Sort Specifications*, GX21-7957
- *Display Format Specifications*, GX21-9800
- *WSU Job, Array, and File Specifications*, GX21-9453
- *WSU Processing Specifications*, GX21-7936
- *WSU/\$SFGR Debugging Template*, GX21-7926
- *Keyboard Template*, GX21-7929

### **Summary of changes**

The following changes have been made for Release 3 Modification 0:

- A new format selection has been added. This format lets you enter *Help* information for any text displays. The new format is *DOC-H*.
- Formats for *WSU-J*, *WSU-S*, *SFGR-S*, and *SFGR-H* have been changed to include *Ideographic Mode*, *Online Text*, and *132 Column* entries.
- SEU can be used on the 132 column capable IBM 3180 model 2, but all displays will be in 80 column mode. See the *IBM 3180 model 2 Display Station Users Guide*, GA21-9469, for more information.
- Various technical and editorial changes have been made to improve the quality and usability of this manual.

## Chapter 1. What Is SEU?

The System/36 Source Entry Utility (SEU) helps you enter or make changes to statements in a source member or a procedure member. With SEU you can use:

- Enter/update to create a source member, add statements to an existing member, or change statements in an existing member.
- Copy/move to duplicate or relocate statements in a member.
- Scan/replace to search through a member to locate a particular sequence of characters. You can update the located characters and optionally substitute the located set of characters with replacement characters.
- Delete to remove statements from a member.
- Include to copy statements from one member to another.
- Translate to translate each message in your message member into another language.

## Why Use SEU

Because SEU prompts you for the information it needs, you will find it easy to use whether you are a new or experienced user, and whether you are a display station operator or a programmer.

RPG programmers will find SEU helpful because it can check their RPG II or auto report statements for syntax errors as the statements are entered.

You may use SEU to:

- Enter OCL statements for a procedure
- Enter specifications for:
  - RPG II
  - COBOL
  - FORTRAN IV
  - BASIC
  - Assembler
  - Display formats (\$SFGR or SDA)
  - WSU
  - Sort.
- Make changes to any of the stored members.

**Note:** Throughout this manual the term *member* refers to a procedure or a source member.

## Before You Begin . . .

Before you begin using SEU, you might want to see the steps involved in SEU.

**Step 1. Plan and Code:** Before sitting down at the display station to enter a new member, you need to plan what statements you want to enter. You can do this using the program specification sheets.

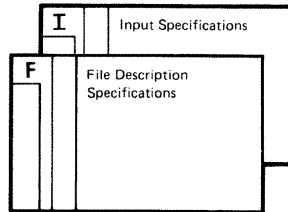

**Step 2. Signing On to SEU:** Next you need to sign on to SEU by entering the SEU command. You are then asked for information about the member you want to work with.

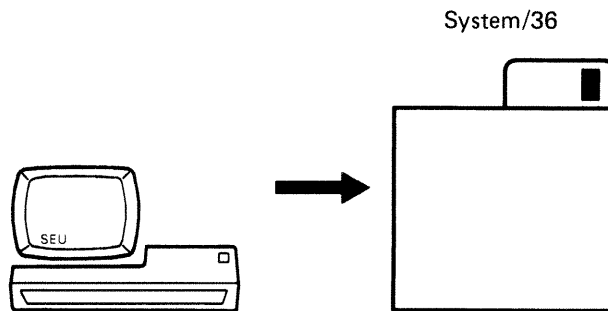

**Step 3. SEU Sets Up a Work Area:** SEU is loaded into main storage, and it sets aside a work file for you. (If you are working with an existing member, a copy of that member is placed in this work file for you.)

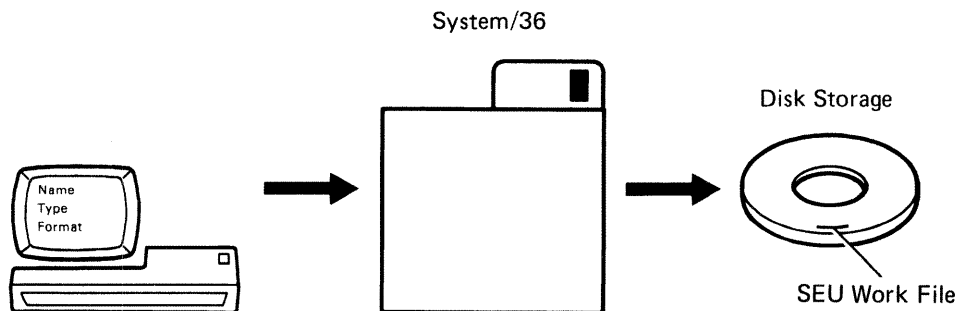

**Step 4. Enter or Update:** Now you can enter or make changes to statements in a member. SEU stores all new or changed statements in the work file.

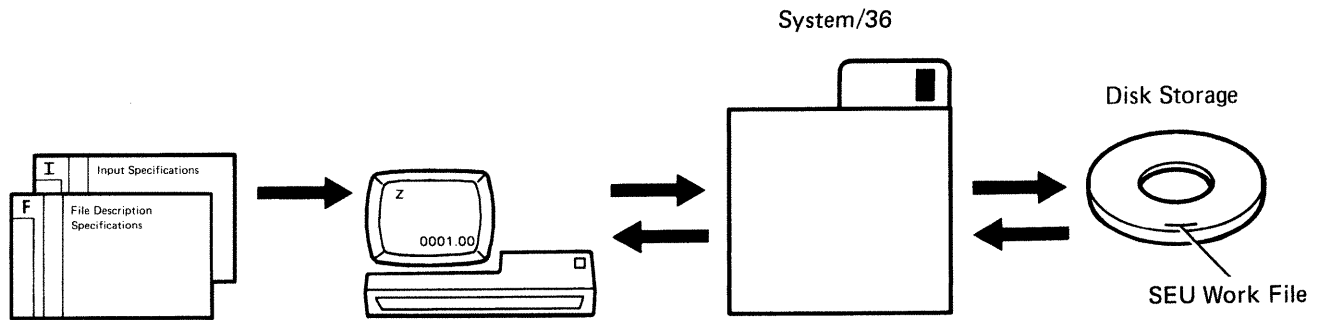

**Step 5. End the SEU Job:** When you end your job, SEU takes whatever is in the work file and stores it in the library you choose.

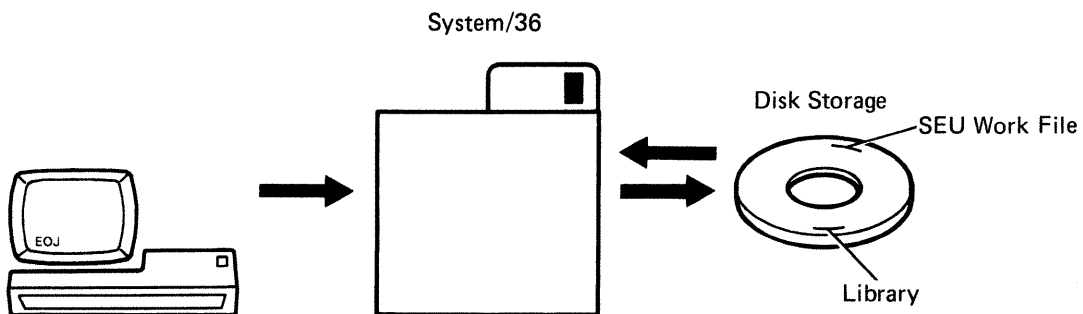



## First You Need to Sign On To SEU

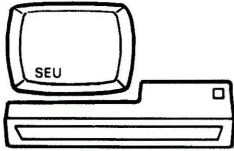

Once you have signed on to the system, you can sign on to SEU. You may have heard this referred to as accessing or calling SEU. Whatever you call it, it means making the utility available to you. SEU is easy to sign on to, you just type:

SEU

and press the Enter key. You are prompted for any more information SEU needs.

To help you understand how SEU works, this chapter gives a series of examples that step through several ways to use SEU with a new member. Now sign on to SEU and you can follow along at your display station. Because the example uses the library SEULIB, you must either build SEULIB before using the example, or enter the name of an existing library. You may build SEULIB with the BLDLIBR procedure. For information on the BLDLIBR procedure, see the *System Reference* manual.

Next you will see the following display. For this example, type in the name of the member, the member type, and the name of your library:

```
SEU PROCEDURE                               Optional-*
Source entry utility (SEU) is a program that allows you to create,
change, remove, and locate statements in source and procedure members

Name of member to be created or updated . . . . . AR230R
Type of SEU member . . . . . A,F,P,R,S,T,W R
Name of member containing SEU formats . . . . . #SE@XTRA
Length of statement . . . . . *
Name of library containing member . . . . . SEULIB

Cmd3-Previous menu

(C) 1983 IBM Corp.
```

**Note:** Throughout these examples the entries that you should make are highlighted. To follow the example, type the entries exactly as shown.

Press the Enter key to continue.

### ***Name of Member to be Created or Updated***

This is the name of the member you are entering or want to change. The name can be from 1 to 8 characters long. For the example, type in **AR230R** and press the Field Exit key.

### ***Type of SEU Member***

This is the SEU type of the member to be entered or changed. For this example, we are entering part of an RPG program so enter an **R**.

### ***Name of Member Containing SEU Formats***

This is where the system stores the SEU-supplied displays you use to enter statements. For this example, leave the entry that SEU supplied (**#SE@XTRA**).

### ***Length of Statement***

This is how many characters long each statement can be. You do not have to enter a number here. For this example, leave this parameter blank and SEU will enter a length of 96 characters for you.

### ***Name of Library Containing Member***

The name of the library you are currently using is displayed in this parameter. For this example, you can leave the library name that is displayed or enter another name. The sample data from this example will be stored in the library you specify.

## After You Sign On To SEU

What is displayed after you sign on to SEU depends on whether the member already exists or is a member being created. Since you are entering a new member for this example, once you sign on to SEU a *free-form* display is shown to help you enter data. The free-form display (also called the Z-display) looks like this:

```
16 120 Z      Enter      S      1 096 SEULIB  AR230R      W1

      1      2      3      4      5      6      7
12345678901234567890123456789012345678901234567890123456789

      8      9      0      1      2
01234567890123456789012345678901234567890

Enter or update statement number . . . . . 0001.00
```





To enter the first statement from the F-specification sheet, you need an F-display to guide you. Press the Select Display command key (Cmd 3), and a list of SEU displays is shown:

Select display			
1 Z	17 WSU-J	33 FORTRAN	49
2 Z-LDWER	18 WSU-E	34 COBOL	50
3 H	19 WSU-T	35 SDAS	51
4 U	20 WSU-M	36 SDAH	52
5 F	21 WSU-S	37 SDAD1	53
6 G	22 WSU-D	38 SDAD2	54
7 E	23 WSU-C	39 DOC-H	55
8 L	24 SFGR-S	40 AUTOR	56
9 T	25 SFGR-H	41 MESSAGE	57
10 I	26 SFGR-D	42 SRT-HEAD	58
11 J	27 D-CONT	43 SRT-RECD	59
12 C	28 SORTH	44 SRT-CNST	60
13 O	29 SORTRF	45 SRT-FLD	61
14 P	30 SORTRC	46 MICRSYS	62
15 K	31 SORTF	47 MICRSTCK	63
16 A	32 ASSEM	48	64

Enter the number of the specification display you want. . . .

If you have the Ideographic Character feature on your system and you are signed on to an ideographic-capable display station, you will see the following display when command key 3 (Cmd 3) is pressed. Notice that COMMAND is inserted into the list, and SORTH and the following selections have been moved one position. Also notice that DOC-H has been inserted between SDAD2 and AUTOR.

Screen 67 with Command display

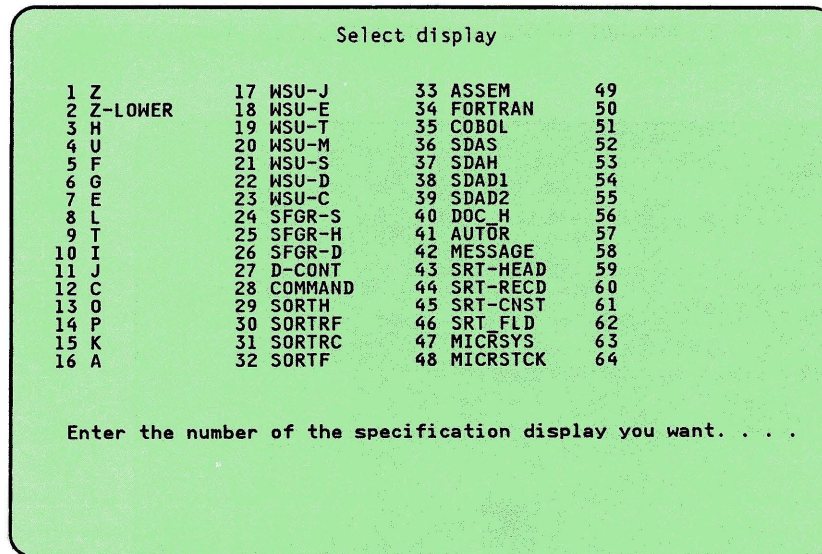

For an explanation of the Command display, see Chapter 4.

Enter the option number to select the display for the F-specification.

When the F-display is shown, begin entering the F-specification as shown, using the Field Exit key (for numeric fields) or Field Advance key (→) to move from field to field. You do not need to enter the statement numbers (such as 0001.00, 0002.00) since SEU will provide them for you. For more information, see *Statement Numbering* in Chapter 2.

If you accidentally press the wrong key, a blinking error message might be displayed and you will be unable to use the keyboard. In a case like this, simply press the Error Reset key and continue, or press the Help key for an explanation of the error message, then press the Error Reset key to continue:

```
16 096 F          Enter          1 096 SEULIB  AR230R      W1

      1      1 1 1 1 1 2      2  2 23 3 3 3 3  3 4      4 5 5 5
12345 6 78901234 5 6 7 8 9 0123 4567 8 90 1 2 34 5678 9 0123456 789012 3 456789
      F CUSTMSTR U          256  5  I          2  DISK

6      6 6 6 7 7 7 7  8 8      9
012345 6 7 89 0 12 34 567890 1234567890123456

Enter or update statement number . . . . . 0001.00
```

**Note:** Because you entered the SEU member type as R when you signed on, SEU will provide some RPG syntax checking while you enter the statements. The code you are entering in a field is checked to make sure it is the correct type of code for that field. So, if you enter invalid code, SEU will tell you that you did.



When you have finished typing the F-specification, press the Enter key. Because there is only one F-specification to enter, again press the Select Display command key (Cmd 3) and select the I-display from the list of displays.

When the I-display is shown, enter the next statement that defines your file:

```

16 096 I      Enter      1 096 SEULIB  AR230R      W1
      FCUSTMSTRU      256 5 I  2 DISK

      1 1 12 2 2 2 3 3 3 34 4 4 4 4 5 5 5 56
12345 6 78901234 5678 90 1234 567 8901 234 5678 901 2 3 4567 8901 2 345678 90
      I CUSTMSTR      01

6 6 6 6 6 6 7 7 7 8 8 9
12 34 56 78 90 1234 567890 1234567890123456

Enter or update statement number . . . . . 0002.00

```

Notice that all the rest of the statements are I-specifications that define a field. You can use the J-display to enter each statement. Again, press the Select Display command key (Cmd 3) and select the J-display from the list of displays.

When the J-display is shown, enter the next statement that defines a field:

```

16 096 J      Update     1 096 SEULIB  AR230R      W1
      ICUSTMSTR      01

      1 1 12 2 2 2 3 3 3 34 4 4 4 4 5 5 5 56 6 6 6 6
12345 6 78901234567890123456789012345678901 2 3 4567 8901 2 345678 90 12 34 56
      I      1 1 ARCOD

6 6 6 6 6 6 7 7 7 8 8 9
78 90 1234 567890 1234567890123456

Enter or update statement number . . . . . 0002.00

```

SEU will redisplay the J-display until you select a different display.

Continue entering the I-specifications shown in Figure 1-1. After you have entered all the statements, hold down the Shift key (⇧) and press the Roll Down key (Roll ↓). Your display should look like this:

```

16 096 J                1 096 SEULIB  AR230R  W1
0001.00 FCUSTMSTRU      256 5 I      2 DISK
0002.00 ICUSTMSTR      01
0003.00 I                1 1 ARCOD
0004.00 I                2 9 CUSNO
0005.00 I               10 34 CUSNM
0006.00 I               35 59 CUSA1
0007.00 I               60 84 CUSA2
0008.00 I               85 109 CUSA3
0009.00 I              110 111 STATE
0010.00 I              P 112 116OZIPCD
0011.00 I              P 117 118OAREAC
0012.00 I              P 119 122OPHONE
0013.00 I              123 123 CUSTP
0014.00 I              P 124 127OCRLIM
0015.00 I              P 128 130OOLSNO
0016.00 I              P 131 1352AMDUE

Enter or update statement number . . . . .

```

Press the Roll Up key (Roll ↑) and your display should look like this:

```

16 096 J                1 096 SEULIB  AR230R  W1
0017.00 I              P 136 139ODLTPM

Enter or update statement number . . . . .

```

## How to Make Changes to Statements Using Enter/Update

### Example 2

If you make a mistake while entering the statements, don't worry—they're easy to fix.

Just press the Enter/Update command key (Cmd 5). SEU displays a prompt at the bottom of the display and places the cursor at the prompt so that you can identify which statement you need to correct.

You can use the roll keys to look at the statements you have entered so far and determine the number of the statement you want to change.

Type in the number of the statement you want to correct (for this example, type in 14) and press the Enter key.

```
16 096 J          1 096 SEULIB  AR230R      W1
0001.00 FCUSTMSTRU 256 5 I  2 DISK
0002.00 ICUSTMSTR  01
0003.00 I          1  1 ARCOD
0004.00 I          2  9 CUSNO
0005.00 I         10 34 CUSNM
0006.00 I         35 59 CUSA1
0007.00 I         60 84 CUSA2
0008.00 I         85 109 CUSA3
0009.00 I        110 111 STATE
0010.00 I         P 112 1160ZIPCD
0011.00 I         P 117 1180AREAC
0012.00 I         P 119 1220PHONE
0013.00 I         123 123 CUSTP
0014.00 I         P 124 1270CRLIM
0015.00 I         P 128 1300SLSNO
0016.00 I         P 131 1352AMDUE

Enter or update statement number . . . . . 14
```

SEU displays the statement for you. Because you signed on to SEU with member type R, SEU automatically chooses the J-display. Change CRLIM to LIMIT and press the Enter key:

```

16 096 J      Enter      1 096 SEULIB  AR230R      W1
      I                      123 123 CUSTP

      1      2      3      4 4 4 4      4 5 5 5      56 6 6 6
12345 6 7890123456789012345678901 2 3 4567 8901 2 345678 90 12 34 56
      I                      P 124 127 0 LIMIT

6 67 7 7 8 8      9
78 90 1234 567890 1234567890123456

Enter or update statement number . . . . . 0014.00

```

SEU will store your changes and display the next statement following the one you just corrected; in this example, statement 15:

```

16 096 J      Enter      1 096 SEULIB  AR230R      W1
      I                      P 124 127 0 LIMIT

      1      2      3      4 4 4 4      4 5 5 5      56 6 6 6
12345 6 7890123456789012345678901 2 3 4567 8901 2 345678 90 12 34 56
      I                      P 128 130 0 SLSNO

6 67 7 7 8 8      9
78 90 1234 567890 1234567890123456

Enter or update statement number . . . . . 0015.00

```

You could now change statement 15 if you want. Each time you press the Enter key, SEU chooses the correct display and displays the next statement.

You can also continue updating statements by pressing the Enter/Update command key (Cmd 5), and entering the number of the statement you want to change. SEU will display the statement for you.

When you have finished entering the statements, hold down the Shift key (⇧) and press the Roll Down key (Roll ↓) to view the statements you entered. They should look like this:

```
16 096 J          1 096 SEULIB  AR230R  W1
0001.00 FCUSTMSTRU 256 5 I  2 DISK
0002.00 ICUSTMSTR  01
0003.00 I
0004.00 I          1 1 ARCOD
0005.00 I          2 9 CUSNO
0006.00 I         10 34 CUSNM
0007.00 I         35 59 CUSA1
0008.00 I         60 84 CUSA2
0009.00 I         85 109 CUSA3
0010.00 I        110 111 STATE
0011.00 I        P 112 1160ZIPCD
0012.00 I        P 117 1180AREAC
0013.00 I        P 119 1220PHONE
0014.00 I        123 123 CUSTP
0015.00 I        P 124 1270LIMIT
0016.00 I        P 128 1300SLSNO
          I        P 131 1352AMDUE

Enter or update statement number . . . . .
```

## How to Copy or Move Statements

You can copy or move statements from one location in a member to another location in the same member. You can copy or move one statement at a time or a group of statements together. When you copy a statement, the statement now exists in both the old and the new location within the member. When you move a statement to a new location, the statement no longer exists in the old location.

### How to Relocate Statements Using Copy/Move

#### Example 3

Press the Copy/Move command key (Cmd 10-using the 0 key). The copy/move prompts are displayed:

```
16          1 096 SEULIB AR230R W1
0001.00    FCUSTMSTRU      256 5 I  2 DISK
0002.00    ICUSTMSTR  01
0003.00    I
0004.00    I              1 1 ARCOD
0005.00    I              2 9 CUSNO
0006.00    I             10 34 CUSNM
0007.00    I             35 59 CUSA1
0008.00    I             60 84 CUSA2
0009.00    I             85 109 CUSA3
0010.00    I             110 111 STATE
0011.00    I             P 112 1160ZIPCD
0012.00    I             P 117 1180AREAC
0013.00    I             P 119 1220PHONE
0014.00    I             123 123 CUSTP
0015.00    I             P 124 1270LIMIT
0016.00    I             P 128 1300SLSNO
             P 131 1352AMDUE

Copy or move the statements . . . . . COPY,MOVE COPY
To statement number . . . . .
Starting from statement number . . . . .
Ending with statement number . . . . .
```

Change COPY to MOVE or M on the first line because we only want to change the location of the statement, not copy it to another location.

For this example, move statements 4 and 5 to follow statement 7. You must enter a location that is between 7 and 8.

Entering 7.1 as the new location tells SEU to place statements 4 and 5 after statement 7 but before statement 8.

Type the responses as shown:

```
16          P 1 096 SEULIB AR230R W1
0001.00    FCUSTMSTRU      256 5 I 2 DISK
0002.00    ICUSTMSTR 01
0003.00    I
0004.00    I                1 1 ARCOD
0005.00    I                2 9 CUSNO
0006.00    I               10 34 CUSNM
0007.00    I               35 59 CUSA1
0008.00    I               60 84 CUSA2
0009.00    I               85 109 CUSA3
0010.00    I              110 111 STATE
0011.00    I              P 112 1160ZIPCD
0012.00    I              P 117 1180AREAC
0013.00    I              P 119 1220PHONE
0014.00    I              123 123 CUSTP
0015.00    I              P 124 1270LIMIT
0016.00    I              P 128 1300SLSNO
              P 131 1352AMDUE

Copy or move the statements . . . . . COPY,MOVE MOVE
To statement number . . . . . 7.1
Starting from statement number. . . . . 4
Ending with statement number. . . . . 5
```

Press the Enter key to enter your responses.

SEU will display the first and last statements that are to be moved so you can make sure the responses are correct before the statements are moved:

```
16          P 1 096 SEULIB AR230R 0002 W1
0004.00     I          2 9 CUSNO

0005.00     I          10 34 CUSNM

Copy or move the statements . . . . . COPY,MOVE MOVE
To statement number . . . . . 0007.10
Starting from statement number. . . . . 0004.00
Ending with statement number. . . . . 0005.00
```

If the responses are correct, press the Enter key *again* to actually move the statements. If you do not press the Enter key this second time, the statements are not moved.

If you want to change the responses, do not press the Enter key. Press the Copy/Move command key (Cmd 10) again and enter new responses, or press another command key.



**Note:** After you press the Enter key, you can see how the statements were moved by holding down the Shift key (⇧) and pressing the Roll Down key (Roll ↓). The following is displayed:

```

16          FCUSTMSTRU      256 5 I 096 SEULIB AR230R      W1
0001.00    ICUSTMSTR      01          2 DISK
0002.00    I
0003.00    I
0006.00    I
0007.00    I
0007.10    I
0007.11    I
0008.00    I
0009.00    I
0010.00    I
0011.00    I
0012.00    I
0013.00    I
0014.00    I
0015.00    I
0016.00    I
          1 1 ARCOD
          35 59 CUSA1
          60 84 CUSA2
           2 9 CUSNO
          10 34 CUSNM
          85 109 CUSA3
          110 111 STATE
          P 112 1160ZIPCD
          P 117 1180AREAC
          P 119 1220PHONE
          123 123 CUSTP
          P 124 1270LIMIT
          P 128 1300SLNO
          P 131 1352AMDUE

Copy or move the statements . . . . . COPY,MOVE MOVE
To statement number . . . . .
Starting from statement number . . . . .
Ending with statement number . . . . .

```

See *How to Insert More than 99 Statements* in Chapter 3 for more information on moving statements.

## How to Copy Statements Using Copy/Move

### Example 4

You can duplicate statements within the member by using copy/move.

You again use the Copy/Move command key (Cmd 10). If you are following the example, the copy/move prompts are already displayed for you. For this example, make sure COPY or C is entered for the first prompt.

Type the responses shown:

```
16          FCUSTMSTRU          1 096 SEULIB          AR230R          W1
0001.00          ICUSTMSTR      01 256 5 I          2 DISK
0002.00          I
0003.00          I
0006.00          I              1 1 ARCOD
0007.00          I              35 59 CUSA1
0007.10          I              60 84 CUSA2
0007.11          I              2 9 CUSNO
0008.00          I              10 34 CUSNM
0009.00          I              85 109 CUSA3
0010.00          I              110 111 STATE
0011.00          I              P 112 1160ZIPCD
0012.00          I              P 117 1180AREAC
0013.00          I              P 119 1220PHONE
0014.00          I              P 123 123 CUSTP
0015.00          I              P 124 1270LIMIT
0016.00          I              P 128 1300SLSNO
0016.00          I              P 131 1352AMDUE

Copy or move the statements . . . . . COPY,MOVE COPY
To statement number . . . . . 7.12
Starting from statement number . . . . . 6
Ending with statement number . . . . . 7
```

To copy statements 6 and 7 and have them follow statement 7.11, you must enter a number between 7.11 and 8.00, such as 7.12.

Press the Enter key.

SEU displays the first and last statements to be copied so that you can make sure your responses are correct:

```
16          P 1 096 SEULIB AR230R 0002 W1
0006.00     I          35 59 CUSA1

0007.00     I          60 84 CUSA2

Copy or move the statements . . . . . COPY,MOVE COPY
To statement number . . . . . 0007.12
Starting from statement number. . . . . 0006.00
Ending with statement number. . . . . 0007.00
```

If the responses are correct, press the Enter key a second time to actually copy the statements. If you do not press the Enter key *again*, the statements are not copied.

If you want to change your responses, do not press the Enter key. Press the Copy/Move command key (Cmd 10) again and enter new responses or press another command key.

**Note:** After you press the Enter key, you can see how the statements are duplicated by holding down the Shift key (⇧) and pressing the Roll Down key (Roll ↓)

The following is displayed:

```
16
0001.00      FCUSTMSTRU      256 5 1 096 SEULIB      AR230R      W1
0002.00      ICUSTMSTR      01          2 DISK
0003.00      I
0006.00      I              1 1 ARCOD
0007.00      I              35 59 CUSA1
0007.10      I              60 84 CUSA2
0007.11      I              2 9 CUSNO
0008.00      I              10 34 CUSNM
0009.00      I              85 109 CUSA3
0010.00      I              P 110 111 STATE
0011.00      I              P 112 1160ZIPCD
0012.00      I              P 117 1180AREAC
0013.00      I              P 119 1220PHONE
0014.00      I              P 123 123 CUSTP
0015.00      I              P 124 1270LIMIT
0016.00      I              P 128 1300SLSNO
              P 131 1352AMDUE

Copy or move the statements . . . . . COPY,MOVE COPY
To statement number . . . . .
Starting from statement number . . . . .
Ending with statement number . . . . .
```

## How to Remove Statements Using Delete

You can remove statements (from a source or procedure member) one statement at a time or a group of statements together.

### Example 5

Press the Delete command key (Cmd 4) and type the responses indicated on the following display:

```
16          P 1 096 SEULIB AR230R W1
0001.00    FCUSTMSTRU      256 5 I  2 DISK
0002.00    ICUSTMSTR  01
0003.00    I
0006.00    I              1  1 ARCOD
0007.00    I              35 59 CUSA1
0007.10    I              60 84 CUSA2
0007.11    I              2  9 CUSNO
0007.12    I              10 34 CUSNM
0007.13    I              35 59 CUSA1
0007.13    I              60 84 CUSA2
0008.00    I              85 109 CUSA3
0009.00    I              110 111 STATE
0010.00    I              P 112 116OZIPCD
0011.00    I              P 117 118OAREAC
0012.00    I              P 119 122OPHONE
0013.00    I              123 123 CUSTP
0014.00    I              P 124 127OLIMIT

Delete, starting from statement number . . . . . 7.10
Ending with statement number. . . . . 7.13
```

After you press the Enter key, SEU will display the first and last statements to be removed so that you can make sure your responses are correct:

```
16          P 1 096 SEULIB AR230R 0004 W1
0007.10    I              2  9 CUSNO

0007.13    I              60 84 CUSA2

Delete, starting from statement number . . . . . 0007.10
Ending with statement number. . . . . 0007.13
```

When deleting only one line, the source text starting from that line is displayed at the top of the screen. If the responses are correct, press the Enter key a second time to actually remove the statements. If you do not press the Enter key *again*, the statements are not removed.

If you want to change your responses, press the Delete command key (Cmd 4) again and enter the new responses.

If you do not want to remove any statements, press another command key.

**Note:** After you press the Enter key, you can see where the statements were removed by holding down the Shift key (⇧) and pressing the Roll Down key (Roll ↓). The following is displayed:

```

16                P 1 096 SEULIB AR230R WI
0001.00          FCUSTMSTRU          256 5 I 2 DISK
0002.00          ICUSTMSTR 01
0003.00          I                    1 1 ARCOD
0006.00          I                    35 59 CUSA1
0007.00          I                    60 84 CUSA2
0008.00          I                    85 109 CUSA3
0009.00          I                    110 111 STATE
0010.00          I                    P 112 1160ZIPCD
0011.00          I                    P 117 1180AREAC
0012.00          I                    P 119 1220PHONE
0013.00          I                    123 123 CUSTP
0014.00          I                    P 124 1270LIMIT
0015.00          I                    P 128 1300SLSNO
0016.00          I                    P 131 1352AMDUE
0017.00          I                    P 136 1390DLTPM

Delete, starting from statement number . . . . .
Ending with statement number. . . . .

```

## ***How to End the Job***

When you have finished the work you have to do on the member, you can end the job by pressing the End-of-Job command key (Cmd 7). The following is displayed:

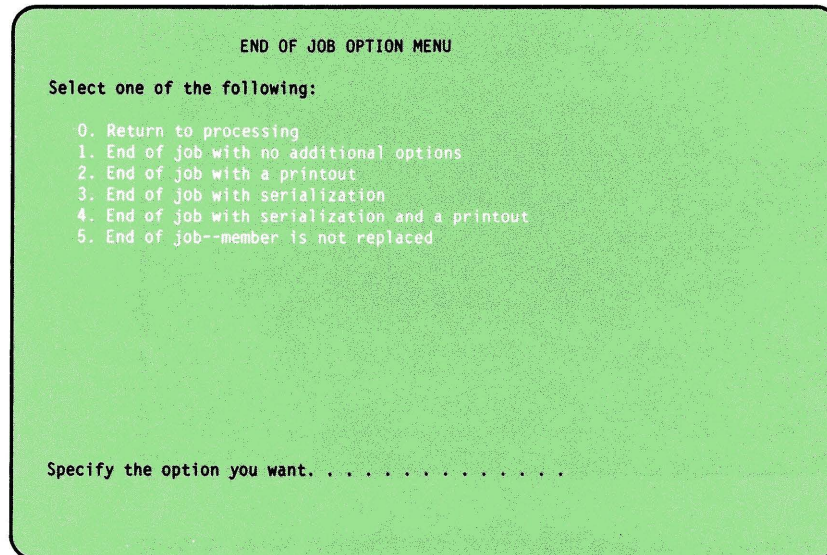

If you do not want to save the sample data, choose option 5 and press the Enter key.

If you do want to save all the work you did, choose option 1 and press the Enter key. The following is displayed:

```
                                END OF JOB

Member name . . . . . AR230R
Library name . . . . . SEULIB
Reference number . . . . . 000001
Library member subtype . . . . . 35
  2 DTA    13 BAP    16 MNU    19 SRT    33 COB    36 WSU    43 BGF
 11 ARS    14 DFU    17 MSG    31 ASM    34 FOR    40 UNS
 12 ARP    15 FMT    18 PHL    32 BAS    35 RPG    42 BGD
Remove diagnostics from diagnosed source member? . . . . . Y,N N
```

This display allows you to give the member a different name or even store it in another library. For this example, leave the responses as shown and press the Enter key. The source member named AR230R is stored in the library named SEULIB.

See Chapter 2 for more details on the end-of-job options.



## Statement Numbers Are Only Temporary (Renumbering)

Statement numbers are only temporary—they are not stored as part of the statement at end of job. Whether statements are added, deleted, or moved during a job, the next time you use the member, all statements are numbered in sequential order: 1.00, 2.00, 3.00, and so on.

For example, assume you have the following statements in a member:

```
16 120 Z          1 096 SEULIB  AR233R      W1
0001.00 FCUSTMASTU 256 5 I  2 DISK
0002.00 ICUSTMAST 01
0003.00 I          1 1 ARCOD
0004.00 I          35 59 CUSA1
0005.00 I          60 84 CUSA2
0006.00 I          85 109 CUSA3
0007.00 I          110 111 STATE
0008.00 I          P 112 1160ZIPCD
0009.00 FCUSTAMT U 62 8 I  6 DISK
0010.00 ICUSTAMT 01
0011.00 I          P 1 52AMDUE
0012.00 I          6 13 CUSNO
0013.00 I          14 38 CUSNM
0014.00 I          P 39 42OLIMIT
0015.00 I          P 43 472CHGTD
0016.00 I          P 117 1180AREAC

Enter or update statement number . . . . .
```

You add the following five statements to the member using the A-display:

```
16 096 A          1 096 SEULIB  AR233R      W1
0001.00 FCUSTMASTU 256 5 I  2 DISK
0001.10 /*THIS IS THE FIRST STATEMENT ADDED
0001.11 /*THIS IS THE SECOND STATEMENT ADDED
0002.00 ICUSTMAST 01
0003.00 I          1 1 ARCOD
0003.10 /*THIS IS THE THIRD STATEMENT ADDED
0004.00 I          35 59 CUSA1
0004.10 /*THIS IS THE FOURTH STATEMENT ADDED
0004.11 /*THIS IS THE FIFTH STATEMENT ADDED
0005.00 I          60 84 CUSA2
0006.00 I          85 109 CUSA3
0007.00 I          110 111 STATE
0008.00 I          P 112 1160ZIPCD
0009.00 FCUSTAMT U 62 8 I  6 DISK
0010.00 ICUSTAMT 01
0011.00 I          P 1 52AMDUE

Enter or update statement number . . . . .
```

The new statements are stored in the member at the end of the job.  
The next time you use that member, the statements will look like this:

```
16 120 Z                1 096 SEULIB  AR233R  W1
0001.00  FCUSTMASTU      256 5 I    2 DISK
0002.00  /*THIS IS THE FIRST STATEMENT ADDED
0003.00  /*THIS IS THE SECOND STATEMENT ADDED
0004.00  ICUSTMAST  01
0005.00  I
0006.00  /*THIS IS THE THIRD STATEMENT ADDED
0007.00  I
0008.00  /*THIS IS THE FOURTH STATEMENT ADDED
0009.00  /*THIS IS THE FIFTH STATEMENT ADDED
0010.00  I
0011.00  I
0012.00  I
0013.00  I
0014.00  FCUSTAMT U      62 8 I    6 DISK
0015.00  ICUSTAMT  01
0016.00  I

Enter or update statement number . . . . .
```

## **Don't Worry About Hurting Your Data**

Any of the work you do on a member with SEU is done in a temporary work area.

When you ask for a particular member, SEU gives you a copy of the member and keeps the original stored in the library. That means that as long as you don't replace it, the original member is protected while you make all the changes you want to the copy.

If you accidentally remove some of the data or change your mind, the original is still stored in your library until you specifically tell SEU to replace the original with the changed member.

The member is further protected by SEU, because when you are working on the member, no one else can have a copy of it to make changes. That way you know that the copy you are using is the latest copy of the member.

## If You Need Some Help

There is a Help key available that will do just that—help you when you have a question about what you are doing. If you run into a problem, just press the Help key which is located on the left side of your keyboard.

SEU will first display a list of command keys that are available to you at that time. Then you should hold down the Shift key (⇧), press the Roll Up key (Roll ↑), and SEU will display additional information about the function you were using when you pressed the Help key.

After you've had a chance to look over the help information, press the Enter key and you will return to the display you were using so you can continue with your job.

## ***Recovery***

SEU provides a way to recover from error conditions and system failures. If an error condition exists, such as the required disk space for the work area is not available, or if a system failure such as a power failure occurs, you may be able to recover your job from the work area. See *How to Recover from Interruptions: Planned or Unplanned* in Chapter 5 for more details.

## Chapter 2. While Using SEU

In Chapter 1 you went through some of the general steps involved in signing on to SEU, and entering or updating members using SEU. Before going any further in using SEU, you may want to know more about some of the basic things you've run into so far, such as:

- SEU parameters-how SEU asks you for information
- Keys with special assignments
- The letters and numbers on line 1 of the display
- How SEU numbers the statements
- Printing the member
- What to do at the end of the job.

## How SEU Asks You For Information

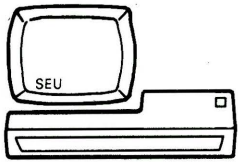

As you saw in Chapter 1, once you have signed on to the system, the easiest way to begin using SEU is to type at the bottom of the display:

SEU

The SEU procedure display then asks you to identify the member you want to work with and some information about the member. If you do not enter at least the member name, SEU will ask for it again. The SEU procedure display looks like this:

```
SEU PROCEDURE                               Optional-*

Source entry utility (SEU) is a program that allows you to create,
change, remove, and locate statements in source and procedure members

Name of member to be created or updated . . . . .
Type of SEU member . . . . . A,F,P,R,S,T,W S
Name of member containing SEU formats . . . . . #SE@XTRA
Length of statement . . . . . *
Name of library containing member . . . . . SEULIB

Cmd3-Previous menu

(C) 1983 IBM Corp.
```

### Name of Member to be Created or Updated

This names the member to be created or changed. The name can be as many as 8 characters long and must begin with an alphabetic character (A through Z, #, \$, or @). The remaining characters can be any combination of characters (numeric, alphabetic, and special) except commas (,), apostrophes ('), blanks, question marks (?), slashes (/), hyphens (-), or ideographic characters.

**Note:** A member name cannot be ALL, DIR, NEW, or SYSTEM.

If the name you supply is an existing member in the library you indicate, SEU assumes that the member is to be updated. If the name does not identify an existing member, SEU assumes that the member is to be created.

## Type of SEU Member

This specifies the type of the member to be created or changed.

Type	Contents of Member
<b>A</b>	Auto report specifications (syntax checking available)  <b>Note:</b> Although auto report specifications are also source, and you could also specify the SEU member type as S, it is best to specify member type as A so that syntax checking is available.  Also during <i>update</i> , SEU will select the correct display for each statement according to the entry in position 6.
<b>F</b>	Display formats (S- and D-specifications) used by \$SFGR (SEU will help you select the specification displays in their sequential order)  Also during <i>update</i> , SEU will select the correct display for each statement according to the entry in position 6.
<b>P or PROC</b>	Procedure
<b>R</b>	RPG specifications (syntax checking available)  <b>Note:</b> Although RPG specifications are also source, and you could also specify member type as source, it is best to specify member type as R so that syntax checking is available when you enter RPG specifications.  Also during <i>update</i> , SEU will select the correct display for each statement according to the entry in position 6.
<b>S or SOURCE</b>	Source statements, such as RPG or auto report specifications, sort sequence specifications, WSU specifications, display specifications, or statements for a message source member (syntax checking not available)
<b>T</b>	Message translation member (SEU prompts you for which message in your message source member you want to translate and aids you in entering the translation)
<b>W</b>	WSU source statements (SEU selects the WSU specification displays for you in sequential order)  <b>Note:</b> WSU specifications are also source, and you could also specify SEU member type as S. If you specify SEU member type as W, SEU will help you select the specification displays in their sequential order.  Also during <i>update</i> , SEU will select the correct display for each statement according to the entry in position 6.

**Note:** If an SEU member type is not entered, SEU assumes the type is SOURCE.

## **Name of Member Containing SEU Formats**

This is the name of a load member where the formats for the SEU-supplied displays (such as the Z-display) are stored. SEU stores all of the displays supplied by IBM in two load members: #SE@FORM and #SE@XTRA.

The SEU-supplied displays guide you as you enter code for your source or procedure members.

The format member name can be up to 8 characters long. If you do not enter a format member name, SEU assumes that you are using the supplied displays and makes them available to you by entering #SE@XTRA for you.

For information on display formats, refer to *SEU-Supplied Displays in a Format Member* in Chapter 5.



## Length of Statement

Statement length is the number of character positions available for the type of member specified. It specifies the length of the statements to be entered or changed.

You do not have to enter the statement length. If the member exists, SEU uses the current statement length of the member. If the member is new, SEU sets the statement length at 96 unless the member type is P (120) or T (80). The following chart describes the possible statement lengths for each type:

Member Type	Statement Length	Default Can Be Length
A	80-96	96
F	40-120	96
P or PROC	40-120	120
R	80-96	96
S or SOURCE	40-120	96
T	40-120	80
W	40-120	96

## Name of Library Containing Member

This specifies the name of the library that contains the member to be changed or that will contain the member to be created. If the library is not found, SEU displays an error message.

A library name is not required. If one is not entered, SEU assumes that the member is in the library you are currently using.

The library name can be as many as 8 characters long and must begin with an alphabetic character (A through Z, #, \$, or @). The remaining characters can be any combination of characters (numeric, alphabetic, and special) except commas (,), apostrophes ('), blanks ( ), question marks (?), slashes (/), hyphens (-), or ideographic characters.

**Note:** Do not use F1, READER, PRINT, or DISK as a library name.

## After You Have Identified the Member

Whether you are creating or updating a member, the Z-display is always the first display selected by SEU. The Z-display is a free-form display and has no fields defined to guide you.

If you are creating a member, a blank Z-display is shown:

```

16 120 Z          Enter      S   1 096 SEULIB   AR230R      W1

      1      2      3      4      5      6      7
12345678901234567890123456789012345678901234567890123456789
      8      9      0      1      2
01234567890123456789012345678901234567890

Enter or update statement number . . . . . 0001.00
  
```

If you are updating a member, the first 16 lines of data are displayed in the Z-specification display:

```

16 120 Z          1 096 SEULIB   AR230R      W1
0001.00 FCUSTMSTRU      256 5 I   2 DISK
0002.00 ICUSTMSTR      01
0003.00 I              1 1 ARCOD
0004.00 I              35 59 CUSA1
0005.00 I              60 84 CUSA2
0006.00 I              85 109 CUSA3
0007.00 I             110 111 STATE
0008.00 I             P 112 1160ZIPCD
0009.00 I             P 117 1180AREAC
0010.00 I             P 119 1220PHONE
0011.00 I             123 123 CUSTP
0012.00 I             P 124 1270LIMIT
0013.00 I             P 128 1300SLSNO
0014.00 I             P 131 1352AMDUE
0015.00 I             P 136 1390DLTPM

Enter or update statement number . . . . .
  
```

If there are more than 16 statements in the member, use the roll keys to view the rest of the member.

When you are entering or making changes to the member, SEU provides command and function keys to make your job easier.

## Keys with Special Assignments

You can select any of the uses of SEU with one of the *command keys* on the top row of the keyboard. Command keys are keys that have been assigned special uses. A *Keyboard Template*, GX21-7929, identifies the name and position of each key. The following illustration shows the relationship between the template (which fits in the recessed area at the top of the keyboard) and each command key:

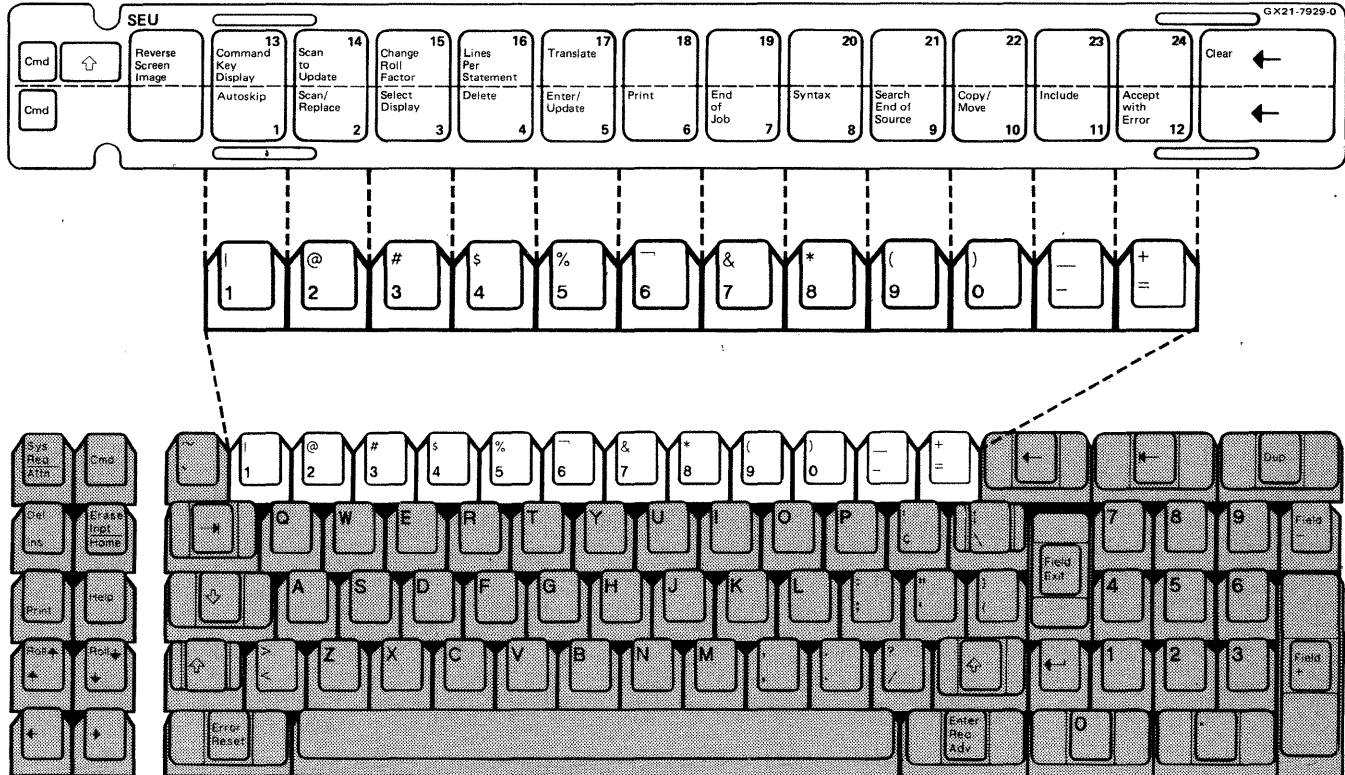

Each command key is assigned one of the numeric or special character keys in the top row of the keyboard. To select one of the uses shown on the bottom row (1 through 12) of the template, press the Cmd key and then press the key you want.

To select one of the uses shown on the top row (13 through 17) of the template, press and hold the Shift key (  $\uparrow$  ), press the Cmd key, then press the top-row key you want.

**Note:** Although the command keys and the keyboard template refer to keys 1 through 24, the keyboard may not be marked with numbers 1 through 24. For example, when you are referred to the Copy/Move command key (Cmd 10), press the Cmd key and the 0 key. Or when you need to use the Accept with Error command key (Cmd 12), press the Cmd key and the = key.

## **Command Keys**

To see which command keys are currently available, press the Help key and SEU will display a list of keys you may use with the SEU function you are using.

### **Autoskip (Cmd 1)**

Turns the autoskip option and indicator on and off. When the autoskip feature is on (indicated in position 39 of the status line by an A), the cursor will skip over all autoskip fields in a statement; data cannot be entered into autoskip fields then. *This can be used only when you are entering or updating.*

More information on autoskip fields can be found under *What Type of Field Is It?* in Chapter 4. More information on the status line can be found in this chapter under *Line 1 is the Status Line.*

### **Scan/Replace (Cmd 2)**

Allows you to search through a member for a set of characters (sometimes called a *global search*) and optionally replace that set of characters with another set.

### **Select Display (Cmd 3)**

Allows you to select a different display by providing a list (or menu) of available displays. *This can be used only when you are entering, updating, or scanning.*

### **Delete (Cmd 4)**

Allows you to remove a statement or group of statements.

### **Enter/Update (Cmd 5)**

Allows you to enter or change statements.

### **Print (Cmd 6)**

Turns the print option and print indicator on and off. If the print option is on (this is indicated in position 45 of the status line by a P), SEU will print any statements you enter, update, delete, or include during the job.

This printout is a record of the changes you have made during the job because SEU prints the before and after version of the statements you changed.

This type of printout is different from a printout requested at the end of the job. An end of job printout contains only the new version of the member.

More information on alter print can be found later in this chapter under *Line 1 Is the Status Line.*

### End Of Job (Cmd 7)

Allows you to choose an end-of-job option.

### Syntax (Cmd 8)

Turns the syntax checking option and indicator on and off. If this option is on (this is indicated by an S in position 42 of the status line), SEU checks RPG II or auto report fields for data that is valid for those specification displays. *This can be used only when you are entering or updating and you have specified the SEU member type as R or A.*

### Search End of Source (Cmd 9)

Displays the last statement in the member.

### Copy/Move (Cmd 10)

Allows you to copy (duplicate) statements into another location within the member or move (change the location of) statements in the member.

### Include (Cmd 11)

Allows you to copy statements from an existing member to the member you are entering or updating.

You cannot include statements you just entered during the current job.

### Accept with Error (Cmd 12)

Allows you to place a statement with a syntax error into a member. There may be times when you need to place statements in a member even though they contain syntax errors. Maybe you're rushed for time or maybe you need to get someone to help you correct the errors.

Accept with error is allowed only if the syntax checking option is on (indicated by an S in position 42 of the status line) and an error exists in an RPG II or auto report statement. *This can be used only when you are entering or updating and the member type is A or R.*

**How to record syntax errors:** To create a printed record of each statement accepted with an error, along with the text of the appropriate SEU diagnostic message printed beneath the statement, check position 45 of the status line. If P is not there, the print option is off. Turn the print option on with the Print command key (Cmd 6) before you press the Accept with Error command key (Cmd 12).

After you end an SEU job during which syntax errors were accepted, you can use the printed list of statements to help you correct any syntax errors you didn't correct during the job.

See *Utilities Messages* for more information on messages.

### **Command Key Display (Cmd 13)**

Displays a list of the SEU command keys and describes each key.

### **Scan to Update (Cmd 14)**

When SEU has located the scanned-for characters in a statement, scan to update will display the statement in enter/update so you can make changes if you want. If the scanned-for characters are not found, or an error occurs, SEU redisplay the scan prompts. *This can be used only when you are entering, updating, or scanning.*

### **Change Roll Factor (Cmd 15)**

Allows you to change the number of new statements (this is indicated in positions 2 and 3 of the status line) that are displayed if a roll key is pressed. This (Change Roll Factor (Cmd 15)) is not allowed when you are translating messages.

### **Lines Per Stmt (Cmd 16)**

Allows you to reverse the number of lines (this is indicated in position 42 of the status line) used to display each statement from 1 to 2 or 2 to 1. This is not allowed when you are translating messages, or displaying a single statement.

### **Translate (Cmd 17)**

Allows you to translate each message in your message source member into a second language.

## Function Keys

All the function keys are described in the operator's guide for your display station. However, some of the function keys have special uses in SEU jobs and are described below.

### Home



The Home key acts as a record backspace key. It can be used only when you are entering or updating.

When you press this key, the cursor is moved back to the first cursor position in a statement where you can enter data (defined by the display). If the cursor is already in the first position for a statement, the preceding statement is displayed.

### Dup

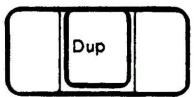

The Dup key can be used two ways, depending on whether you are entering or changing statements. If you are entering data, the Dup key will duplicate data for you from the previous statement. If you are changing data, the Dup key will *not* duplicate data for you; instead, it allows you to cancel changes you were typing within a field.

**Using the Dup key while entering data:** The Dup key duplicates, or copies, all or part of a field from the preceding statement into the statement you are currently entering.

For example, assume you are entering the statements in this procedure:

```
16 120 Z                               1 120 SEULIB 0E400R W1
0001.00 // LOAD 0E400R
0002.00 // FILE NAME-CUSTMAST
0003.00 // FILE NAME-CUSTORDS
0004.00 // RUN

Enter or update statement number . . . . .
```



Statements 2 and 3 are similar. After you enter statement 2, you are prompted to enter statement 3:

```

16 120 Z      Enter      1 120 SEULIB  OE400R      W1
// FILE NAME-CUSTMAST

      1      2      3      4      5      6      7
12345678901234567890123456789012345678901234567890123456789
      8      9      0      1      2
01234567890123456789012345678901234567890

Enter or update statement number . . . . . 0003.00

```

Rather than typing statement 3, if you are not in ideographic mode, press the Dup key. The code you entered in the first field of statement 2 is copied to the first field of statement 3. Overscored asterisks (\*) are displayed in the positions of the first field of statement 3 that will contain the code copied from the previous statement:

```

16 096 Z      Enter      1 120 SEULIB  OE400R      W2
// FILE NAME-CUSTMAST

      1      2      3      4      5      6      7
12345678901234567890123456789012345678901234567890123456789
      8      9      0      1      2
01234567890123456789012345678901234567890

Enter or update statement number . . . . . 0003.00

```

The duplicated code is actually entered when you press the Enter key to enter the entire third statement.

Press the Home key and the code in statement 3 is displayed for you. Move the cursor to position 14 and type the new file name, CUSTORDS. Press the Enter key to enter the change:

```
16 120 Z      Enter      1 120 SEULIB  OE400R      W1
// FILE NAME-CUSTMAST
      1      2      3      4      5      6      7
12345678901234567890123456789012345678901234567890123456789
// FILE NAME-CUSTORDS
      8      9      0      1      2
01234567890123456789012345678901234567890

Enter or update statement number . . . . . 0003.00
```

If you press the Dup key when the cursor is at the beginning of a field, SEU fills the field with data from that corresponding field in the previous statement. If you press the DUP key when the cursor is not at the beginning of a field, SEU fills the cursor position and the rest of the field with data from corresponding positions in the previous statement.

If you press the Dup key when you are entering the first statement in a member, SEU fills the field with blanks because there is no preceding data.

**Using the Dup key while updating data:** When you are updating a field within a statement and press the Dup key, it does *not* duplicate data from the preceding statement. If you have typed incorrect data into a field, move the cursor back to the beginning of the field and press the Dup key. SEU restores the original data to the field.

## Help Key



This key displays additional information, if any, about the display you are using. If there is more than one field on the display, the help text displayed will explain the field the cursor was in when you pressed the Help key.

For example, assume you are using this display:

```
16          A          1  096 SEULIB  AR230R      W1
0001.00    FCUSTMSTRU  256 5 I    2 DISK
0002.00    ICUSTMSTR  01
0003.00    I
0004.00    I          1  1 ARCOD
0005.00    I          35 59 CUSA1
0006.00    I          60 84 CUSA2
0007.00    I          85 109 CUSA3
0008.00    I          110 111 STATE
0009.00    I          P 112 116OZIPCD
0010.00    I          P 117 118OAREAC
0011.00    I          P 119 122OPHONE
0012.00    I          123 123 CUSTP
0013.00    I          P 124 127OLIMIT
0014.00    I          P 128 130OOLSNO
0015.00    I          P 131 1352AMDUE
           I          P 136 1390DLTPM

Include from library name . . . . . SEULIB
Include from member name. . . . .
Including at statement number . . . . .
Starting from statement number. . . . .
Ending with statement number. . . . .
```

When you press the Help key, SEU displays a list of available command keys. Press the Roll Up (Roll ↑) key and the following additional information is displayed:

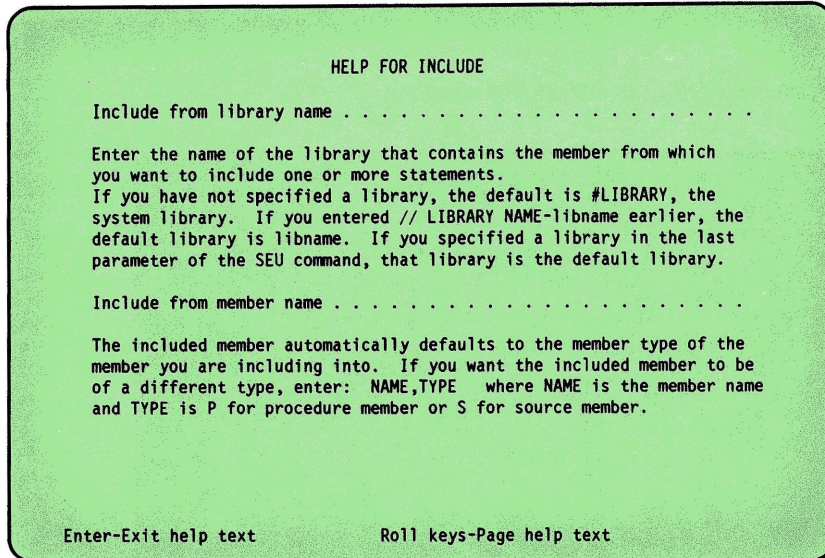

You can use the Roll Up key (Roll ↑) to continue the help text if there is more than one help display for the display you were using.

### Roll Up (Roll ↑)

When you hold down the Shift key (⇧) and press the Roll Up key (Roll ↑), SEU will display statements that are closer to the end of the member than those currently on the display. The statements appear to roll upward and out of sight at the top of the display.

If you continue to hold down the Roll Up key and the Shift key (⇧), SEU will continue to roll through the member. This allows you to look through the member in a short time.

The roll factor determines how many new statements are displayed when you press a roll key. Assume that the roll factor is 12. If statements 1.00 through 16.00 are being displayed when you press the Roll Up key, SEU displays 12 more statements, or statements 13.00 through 28.00.

Positions 2 and 3 of the SEU status line show the current roll factor. You can change the roll factor by pressing the Change Roll Factor command key (Cmd 15) and entering a new factor. The roll factor can be any value from 1 through 99.

**Wraparound:** Wraparound occurs when you press the Roll Up key (Roll ↑) after SEU displays the last statement in the member. If the last statement is being displayed when you press the Roll Up key, SEU starts over again and displays the first and following statements in the member.

For example, assume the member contains 43 statements and the roll factor is 16. If statements 25.00 through 40.00 are being displayed when you press the Roll Up key, SEU displays statements 41.00

through 43.00. If you press the Roll Up key again, SEU displays statements 1.00 through 16.00.

### Roll Down (Roll +)



The Roll Down key operates the opposite of the Roll Up key (Roll ↑). It causes SEU to display statements that are closer to the beginning of the member than those currently on the display screen.

The statements appear to roll downward from the top of the display when you press the Roll Down key with the shift key.

**Wraparound:** Wraparound occurs when you press the Roll Down key after SEU displays the first statement in the member. If the first statement is being displayed when you press the Roll Down key, SEU goes to the end of the member and displays the last and preceding statements.

### Using the Roll Keys

When using the roll keys, think of the records in the file as being on the outside surface of a drum or cylinder. As the drum is rolled forward or back you can view a specific part of the file.

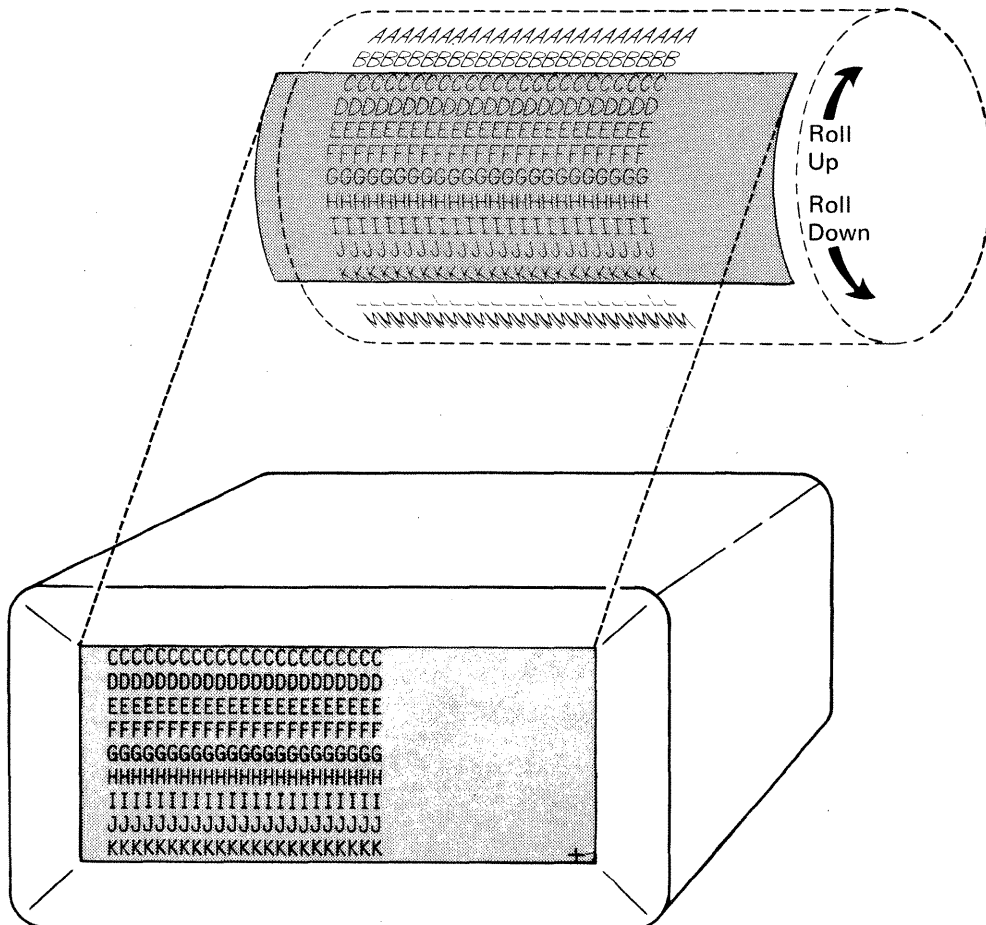

## Cursor Movement Keys

### Field Exit



The Field Exit key moves the cursor out of an input field. When you press this key in a field defined as blank fill, blanks are inserted from the cursor position to the end of the field. When you press Field Exit in a field defined as zero fill, the data is right-adjusted (shifted to the rightmost position of the field) and any remaining positions are filled with zeros instead of blanks.

Because of this, the Field Exit key should be used carefully so you do not blank out data when making changes to a field.

### Field +

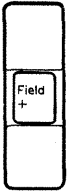

The Field + key moves you out of an input field the same as the Field Exit key. It can also insert a plus (+) sign in the last position of a signed numeric field. Because of this, the Field + key should be used carefully so you do not blank out data when making changes to a field.

### Field Advance



This key moves the cursor forward to the next available field without right adjusting any data within the field.

### Field Backspace

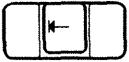

This key moves the cursor back to start of this field, or, if already there, then to the start of the previous field.

### New Line Key



This key moves the cursor to the next line of the display.

## Line 1 is the Status Line

Line 1 of the display is called the *status line* and contains general information about your job. The following is an example of a status line and what it can contain:

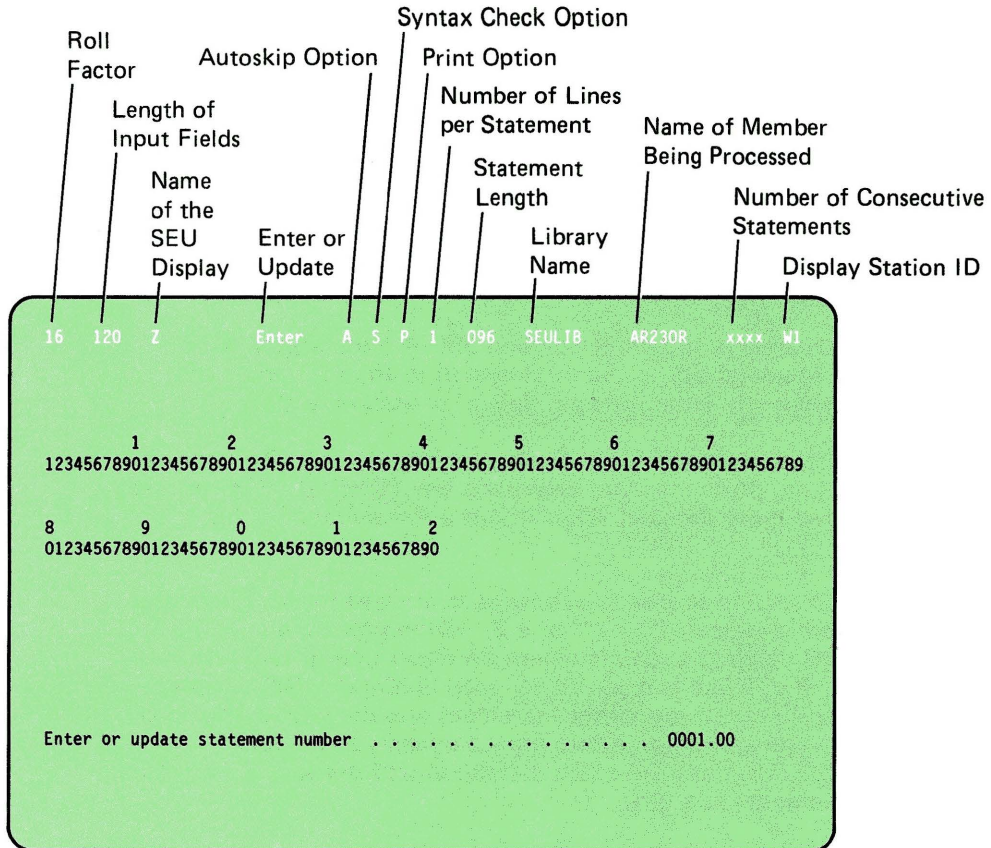

The **Roll Factor** is in positions 2 and 3. It determines how many new statements are displayed if the Roll Up (Roll ↑) or Roll Down (Roll ↓) function key is pressed.

The roll factor is always 16 immediately after SEU sign-on. To change the factor to any value from 1 through 99, press the Change Roll Factor command key (Cmd 15). For more information on changing the roll factor, see *Command Keys* earlier in this chapter. For more detail on the roll keys, see *Function Keys* earlier in this chapter.

The **Length of Input Fields** in positions 7 through 9 is the number of character positions available for the type of display you are using. This number may differ from the member statement length (which is determined by the type of member) specified in positions 46 through 48.

The **Name of the SEU Display** being used in enter/update is in positions 13 through 23.

**Enter or Update** in positions 24 through 29 indicates whether you are entering or updating statements.

The **Autoskip Option** is shown in position 33: A if the option is on, blank if the option is off. The autoskip option is always off at the beginning of an SEU job. The option is changed each time you press the Autoskip command key (Cmd 1). If the option is on when you enter or change a statement, SEU automatically skips fields in the statement that are defined as autoskip fields by the format of the display. For more information, see *Autoskip Fields* in Chapter 4.

The **Syntax Check Option** is shown in position 36: S if the option is on, blank if the option is off. *Syntax checking* means that SEU will check the RPG or auto report fields to make sure the data you entered is valid for those formats.

If the member type is A (auto report) or R (RPG), the syntax checking option is on at the beginning of the SEU job and changed each time you press the Syntax command key (Cmd 8). If the member type is S (source) or P (procedure), the option is off at the beginning of the job and cannot be turned on during the job.

The **Print Option** is shown in position 39: P if the option is on, blank if the option is off. If the print option is on, SEU prints the statement when you enter, update, delete, or include a statement.

The print option is always off at the beginning of a job. To change the print option, press the Print command key (Cmd 6). SEU printing is described in more detail in *What About a Printer* later in this chapter.

The **Number of Lines per Statement** is in position 42. The status of this option is indicated by a 1 or a 2. When you are viewing a member, SEU displays each statement on either one or two lines of the display. If one line is reserved for each statement, SEU displays only the first 70 characters of the statement and displays a maximum of 16 statements at a time. If two lines are reserved for each statement, SEU displays the entire statement and displays a maximum of eight statements at a time.

At SEU sign-on, one display line is reserved for each statement. You can change the number of display lines per statement by pressing the Lines Per Statement command key (Cmd 16).

The **Statement Length** for the display is in positions 46 through 48. This is the number of character positions available for the type of member you specified at sign-on. It specifies how long the statements can be. This number may differ from the number of character positions (which is determined by the type of display) shown in positions 7 through 10.

The **Library Name** identifies the library where the member you are using is stored. The library name is in positions 52 through 59.

The **Name of Member Being Processed** is in positions 63 through 68. This identifies the member you are using.

The **Number of Consecutive Statements** being deleted, moved, or included at one time is in positions 73 through 76. This is displayed only when you are deleting, moving, or including statements.

The **Display Station ID** identifies which display station you are using (for example, W1 or W2). The display station is identified in positions 79 and 80.



## **Statement Numbering**

You may have noticed the numbers to the left of each statement. SEU assigns each statement in a member a unique statement number. Statement numbers allow you to identify statements you want to enter, change, delete, move, or include.

The statement number assigned by SEU during the job is only temporary—it is not stored as part of the statement.

### ***How Statements Are Numbered***

The form of the statement number is xxxx.xx. However, the following numbers are all equal to statement number 5: 5, 5.0, 5.00, and 0005.00.

When you are using an existing member, the first statement in the member is assigned number 1.00, the second 2.00, the third 3.00, and so on, to a maximum of 9999.00. If you try to enter more than 9999 statements, SEU displays an error message. If the SEU print option is on, SEU prints the statement you entered but does not store the statement in the member.

### ***Adding Statements to a Member***

You can add statements at the end of a member. You must assign a number to the first added statement; after that SEU assigns the numbers automatically.

If you want to enter a statement number higher than the highest statement number in the member, the new statement number cannot be greater than 1.99 higher than the last whole number.

For example, if the highest statement number in the member is 0004.00, a new statement number can be any number from 0004.01 through 0005.99. If the highest statement number is 0006.98, a new statement number can be any number from 0006.99 through 0007.99 (adding 1.99 to 6.00).

When you assign the first new statement number:

- If you enter a whole statement number (for example, you enter a new statement number of 5), SEU assigns whole statement numbers to the following statements (for example, statement numbers 6.00, 7.00, and so on).
- If you enter a number with decimal positions (for example, you enter a new statement number of 5.1 or 5.10), SEU assigns statement numbers to the following statements that are increased by .01 (for example, statement numbers 5.11, 5.12, 5.13, and so on).

## ***Inserting Statements***

You can insert any number of statements up to 99 statements between any two whole numbered statements in a member. For example, assume you have several statements numbered 1.00, 2.00, and so on. Press the Enter/Update command key (Cmd 5). When SEU asks you which statement you want, enter 1.1. SEU displays a blank statement display so that you can enter a new statement.

Enter the statement.

SEU will place the new statement between statements 1.00 and 2.00 and display another blank statement display numbered 1.11.

If you continue to insert new statements in the same place, SEU will automatically assign each statement number by adding .01 to the previous statement number.

## ***How to Find a Statement in a Large Member***

When you are using a member with many statements, it is time-consuming to roll through the member to locate a particular statement. Instead, if you know the number of a statement you want displayed, select enter/update and enter the number in response to the enter/update prompt on the bottom of the display. If you do not know the statement number, use one of the following two methods to find the statement:

- Using enter/update, enter a statement number you think is close to the one you want, then use the Roll Up or Roll Down key to locate the statement.
- If you know that the statement contains unique characters, such as a file name in an RPG II F-specification, you can use scan to locate the characters. Enter the unique characters in response to the scan prompt Scan characters.

If the first statement located by scan is not the statement you are looking for, repeat the scan by pressing the Enter key or the Scan to Update command key (Cmd 14).

## What About a Printer

SEU does not require a printer for sign-on. But SEU expects a printer to be available if:

- The print option is on during your job when you enter, update, delete, or include a statement.
- You request a printout at the end of your job with end-of-job option 2 or 4.

If no printer is available when one is needed, SEU displays an error message. See the *System Reference* manual for more information on the PRINT procedure, which allows you to do such things as assign the printer, set the number of characters per inch, and so on.

If spooling is not active, if the print option is on during the job, and a printer is available and running, your statements will print out as you enter or update them. If spooling is active and the print option is on, the statements you enter or update will be printed out at the end of the job and reflect the changes you made.

See the manual *Concepts and Programmer's Guide* for more information on spooling.

**Note:** A listing requested as an end-of-job option prints the updated version of the member, but does not note the changes you made during the job. Records that are printed as a result of your having the Print option on during the job are printed individually and changes you made are noted.

For information on the various ways to print out your source, refer to *Printing Your Jobs* in the manual *Operating Your Computer*.

## Printing a Member

On all SEU end-of-job printouts, the first printed line of the first page contains the program date for the SEU job, the time of day when you requested the print, and a label that identifies it as an end-of-job printout. Printouts requested at end of job also contain the member name and library name on the first printed line.

```
MEMBER      AR230R  LIBRARY      SEULIB      SEU EDJ PRINTOUT      DATE 12/16/82      TIME 14.40

                                IBM SYSTEM/36 SOURCE ENTRY UTILITY

FCUSTMSTRU      256 5 I      2 DISK
ICUSTMSTR      01
I
I              1  1 ARCOD
I             35  59 CUSA1
I             60  84 CUSA2
I             85 109 CUSA3
I            110 111 STATE
I            P 112 116OZIPCD
I            P 117 118OAREAC
I            P 119 122OPHONE
I            123 123 CUSTP
I            P 124 127OLIMIT
I            P 128 130OGLSNO
I            P 131 1352AMQUE
I            P 136 139ODLTPM
```

\*\*\*\* E N D O F S E U P R I N T O U T \*\*\*\*

**Note:** Because SEU begins printing on the sixth line of the paper, the designated page size must be greater than six lines. Refer to the *System Reference* manual for more information on the SET command, which changes the number of print lines.

## End of Job

When you press the End of Job command key (Cmd 7), SEU displays a list of options.

### *Source Members at End of Job*

If you are creating or updating a source member, SEU displays the following end-of-job options:

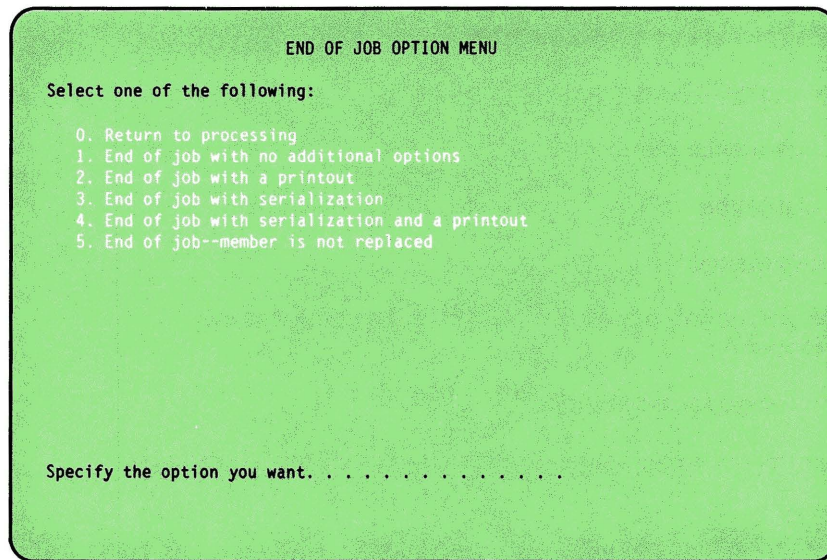

## End-of-Job Options

**0 Return to processing:** The job continues as though the End of Job command key (Cmd 7) had not been pressed. The cursor is returned to the first cursor position defined by the specification display. Option 0 is not allowed if the SEU work file is full or if an error exists for the display station.

**1 End of job with no additional options:** SEU copies the member from the work area to a library and replaces the old member in the library.

**2 End of job with a printout:** SEU copies the member from the work area to a library, replaces the old member, and then prints the new member on the printer currently assigned to the display station.

**3 End of job with serialization:** Serialization means that a four-digit serial number is inserted into each of the statements starting at a position you specify. (If you choose this option, you are prompted for the serialization start position on a following display.) Be sure these positions do not already contain data in each statement, because SEU will store the serial number over whatever data exists in those positions.

**4 End of job with serialization and a printout:** This is a combination of options 2 and 3. The member is serialized, copied from the work area to a library, and listed on a printer.

**5 End of job--member is not replaced:** SEU ends the job by removing the data in the work area. All new or changed data entered during the job is lost. If you were updating an existing member, this option cancels the update, and the member in the library remains unchanged.

### ***End-of-Job Maintenance***

If you choose end-of-job option 1 or 2, SEU gives you a chance to do several things, such as:

- rename the member as a new member
- store it in another library
- assign it a reference number
- assign it a subtype
- remove diagnostics.

If you choose end-of-job option 3 or 4, SEU asks you for some additional information:

- the start position for serialization
- if you want the program name duplicated in positions 75 through 80.

The following is displayed:

```
                END OF JOB

Member name . . . . . AR230R
Library name . . . . . SEULIB
Reference number . . . . . 000002
Library member subtype . . . . . 35
 2 DTA   13 BAP   16 MNU   19 SRT   33 COB   36 WSU   43 BGF
11 ARS   14 DFU   17 MSG   31 ASM   34 FOR   40 UNS
12 ARP   15 FMT   18 PHL   32 BAS   35 RPG   42 BGD
Remove diagnostics from diagnosed source member? . . . . . Y,N N
```

**Start serialization at position:** This prompt is displayed only if you select end-of-job option 3 or 4. The number specifies the position where the serial number will begin in each statement. The response can be any number greater than 0 that is equal to or less than statement length minus 3. SEU will overlay any data that is in these positions.

SEU supplies a value of 1 for this prompt, but you may change the value.

If you are using RPG II or auto report statements and the member contains compile-time tables, you should specify a serial start position of 1. Serialization stops if SEU finds two asterisks and a blank in the first three positions (indicating compile-time tables), and if you specify a serial start position of 1.

After you enter a response, SEU serializes statements in the member with four-digit numbers beginning with 0001.

**Member name:** SEU supplies the name you specified at the beginning of the job for this prompt. You can change the name. If you were updating an existing member, you can now store the changed member under a new name and save the original member as it was.

**Library name:** SEU supplies the name of the library you specified at the beginning of the job for this prompt. You may change the name and store the member in a different library. If you are using an existing member, a copy of the new member is stored in the new library, and the old member remains in the original library.

**Reference number:** This is a number SEU assigns to the member and stores in the library directory. If you are creating a new member, SEU supplies 000001 as the response and increases the number by one at the end of every SEU job that uses that member. You may change this number. You may use the reference number to keep track of the number of updates to the member, or the latest LISTLIBR printout.

**Library member subtype:** You may assign a subtype for a source member at end of job. A subtype further identifies a member within its type in a library listing.

For example, the LISTLIBR procedure may list and identify all of the members in your library as source (type S), procedure (type P), object (type O), or subroutine (type R) members. Although several members may be source, DFU source is very different from assembler source or FORTRAN source, and so on.

By assigning a subtype at end of job, you can identify a member such as a DFU source member or a FORTRAN source member.

If you do not enter a subtype for a new member, the subtype is entered as unspecified (40 UNS).

If you do not enter a subtype for an existing member, the subtype remains as the subtype that was specified when the member was last stored.

**Note:** Some SEU member types have default subtypes. For example, if you specified an SEU member type of W (WSU), a subtype 36 is specified for you.

The following subtypes are available for source or procedure members:

2	DTA	Data member
11	ARS	Automatic response member
12	ARP	RPG Auto report member
13	BAP	BASIC procedure (source member)

## ***Procedure Members at End of Job***

If you are creating or updating a procedure member, SEU displays the following end-of-job options:

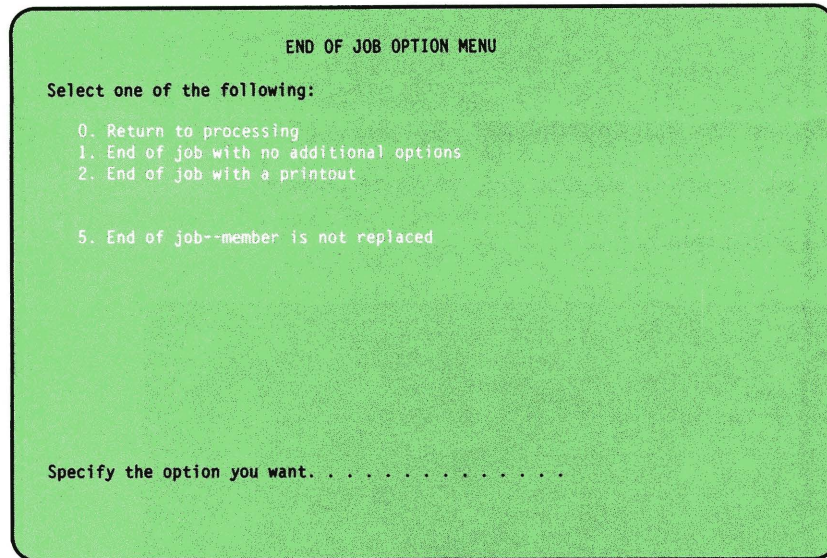

### **End-of-Job Options**

**0 Return to processing:** The job continues as though the End of Job command key (Cmd 7) had not been pressed. The cursor is returned to the first cursor position defined by the display. Option 0 is not allowed if the SEU work file is full or if an error exists for the display station.

**1 End of job with no additional options:** SEU copies the member from the work area to a library and replaces the old member in the library.

**2 End of job with a printout:** SEU copies the member from the work area to a library, replaces the old member, and then prints the new member on the printer currently assigned to the display station.

**5 End of job--member is not replaced:** SEU ends the job by removing the data in the work area. All new or changed data entered during the job is lost. If you were updating an existing member, this option cancels the update and the member remains in the library unchanged.



## End-of-Job Maintenance

If you choose end-of-job option 1 or 2, SEU gives you a chance to do several things, such as:

- identifying program data in statements
- renaming the member
- storing the member in another library
- assigning the member a subtype and reference number.

The following is displayed:

```
                                END OF JOB

Program data in include statements? . . . . . Y,N N
Member name . . . . . OE400R
Library name . . . . . SEULIB
Reference number . . . . . 000002

Library member subtype . . . . . 40
 2 DTA   13 BAP   16 MNU   19 SRT   33 COB   36 WSU
11 ARS   14 DFU   17 MSG   31 ASM   34 FOR   40 UNS
12 ARP   15 FMT   18 PHL   32 BAS   35 RPG

Log the procedure statements? . . . . . Y,N Y
Multiple requester terminal procedure? . . . . . Y,N N
```

If the SEU job that is ending did not create the procedure, but only updated it, SEU displays the current status of the options in the response positions. You may change the options.

**Program data in include statements?:** Procedure commands that run SRT (single requester terminal) programs may contain program data instead of parameters. Procedure commands that run MRT (multiple requester terminal) procedures always contain data instead of parameters. If the procedure command contains program data instead of parameters, you must enter a Y. (Y for this prompt is the same as PDATA=YES for the \$MAINT library maintenance utility program.) If the procedure command does not contain program data, the response must be N for no. The default value for a new member is N. Procedure commands and \$MAINT are described in the *System Reference* manual.

**Member name:** SEU supplies the name you specified at the beginning of the job for this prompt. You can change the name. If you were updating an existing member, you can now store the changed member under a new name and save the original member as it was.

**Library name:** SEU supplies the name of the library you specified at the beginning of the job for this prompt. You can change the library name and store the member in a different library.

**Reference number:** This is a number SEU assigns to the member and stores in the library directory. If you are creating a new member, SEU supplies 000001 as the response and increases the number by one at the end of every SEU job that uses that member. You can change this number. You can use the reference number to keep track of the number of updates to the member, or identify the latest LISTLIBR printout.

**Library member subtype:** You may assign a subtype for a procedure member at end of job. A subtype further identifies a member within its type in a library listing.

For example, the LISTLIBR procedure can list and identify all of the members in your library as source (type S), procedure (type P), object (type O), or subroutine (type R) members. Although several members may be procedure members, a sort procedure is different from an assembler procedure or a COBOL procedure.

By assigning a subtype at end of job you may identify on the LISTLIBR printout a member as a sort procedure, a COBOL procedure, or whatever.

If you do not enter a subtype for a new member, the subtype is entered as unspecified (40 UNS). If you do not enter a subtype for an existing member, the subtype remains as the subtype that was specified when the member was last stored.

The following subtypes are available for source or procedure members:

2	DTA	Data member
11	ARS	Automatic response member
12	ARP	RPG Auto report member
13	BAP	BASIC procedure (source member)
14	DFU	Data file utility member
15	FMT	Display format member
16	MNU	Menu member
17	MSG	Message member
18	PHL	Phone list member
19	SRT	Sort member
31	ASM	Assembler member
32	BAS	BASIC member
33	COB	COBOL member
34	FOR	FORTRAN member
35	RPG	RPG member
36	WSU	Work station utility member
40	UNS	Unspecified
42	BGD	Business Graphics Data
43	BGF	Business Graphics Format

**Log the procedure statements?:** If you want the system to log the procedure statements to the system history file each time the procedure is called, the response must be Y for yes. If you do not want the procedure statements logged, the response must be N (which is recommended). The default when using a new member is Y.

**Multiple requester terminal procedure?:** If the procedure is an MRT (multiple requester terminal) procedure, the response must be Y for yes. If the procedure is not an MRT procedure, the response must be N for no. The default for a new member is N. If you are updating an existing member, SEU displays the responses to the prompts as they were last stored.

For a description of multiple requester terminal procedures, see the *Concepts and Programmer's Guide*.

14	DFU	Data file utility member
15	FMT	Display format member
16	MNU	Menu member
17	MSG	Message member
18	PHL	Phone list member
19	SRT	Sort member
31	ASM	Assembler member
32	BAS	BASIC member
33	COB	COBOL member
34	FOR	FORTRAN member
35	RPG	RPG member
36	WSU	Work station utility member
40	UNS	Unspecified
42	BGD	Business Graphics Data
43	BGF	Business Graphics Format

**Remove diagnostics from diagnosed source member?:** While you are compiling a source member, the compiler can create a diagnosed source file that contains the source statements along with the diagnostic and informational messages from the compilation. SEU uses that file as input and allows you to make changes. If you enter a Y for this prompt, SEU will omit all the diagnostic and informational messages from the member when you have finished correcting the member. Refer to *SEU Procedure Command* in Chapter 5 for more information on SEU-diagnosed source files.

**Note:** For more information on compiling a source member and diagnosed source files, see the related programming reference manual.

**Duplicate program name (in positions 75 through 80):** This prompt is displayed only if you specified an SEU member type of A, R, or S when you signed on to SEU; if you have selected option 3 or 4 of the end-of-job options; and if the statement length specified is 80 or greater.

If you enter Y, SEU copies the value in positions 75 through 80 of the first statement into positions 75 through 80 in each of the remaining statements in the member. SEU will copy the value over serial numbers, comments, or code, if they exist in positions 75 through 80. If a source member contains compile-time data and program name duplication is requested, a serial start position of 1 should be specified to prevent the serial number from being overlaid by the program name.

If serialization is being done in positions 1 through 4 and two asterisks and a blank are found in positions 1 through 3, which indicates the presence of compile time data, program name duplication and serialization are discontinued.

If you enter N, SEU does not copy the value contained in positions 75 through 80 of the first statement in the member.

If you enter any value other than Y or N, SEU displays an error message and redisplay the prompt.

# Chapter 3. Using SEU

Chapter 1 introduced using SEU: enter/update, delete, and copy/move. The following sections give more details about the uses of SEU and include examples of using scan/replace, include, and message translate.

One sample source member will be used throughout the chapter. Assume the following statements are in a source member called AR230R.

**Note:** Changes were made to this member in Chapter 1 examples.

Line	Form Type	Filename	File Type		Mode of Processing		Device	Symbolic Device	Labels SN/EM	Name of Label Exit	Extent Exit for DAM	Storage Index	File Addition/Unordered		
			File Designation	End of File	Length of Key Field or of Record Address Field	Record Address Type							Number of Tracks for Cylinder Overflow	Number of Extents	
			IO/UCD	PS/CR/TD/F											
			E	A/D		L/R									
			File Format		Type of File Organization or Additional Area		Overflow Indicator		Key Field Starting Location		Continuation Lines		File Condition U1-UB, UC		
			Block Length	Record Length											
			External Record Name												
02	F	CUSTOMSTR			256	5	I							2	DISK
03	F														

Line	Form Type	Filename or Record Name	Sequence	External Field Name									Field Location		RPG Field Name	Control Level (L1-L9)	Matching Fields or Chaining Fields	Field Record Relation	Field Indicators										
				Record Identification Codes			1			2			3						From	To	Plus	Minus	Zero or Blank						
				Position	Not (N)	Character	Position	Not (N)	Character	Position	Not (N)	Character	Position	Not (N)	Character	Occurs n Times	Length	Decimal Positions											
01	I	CUSTOMSTR	01																										
02	I															1	1												ARCOD
03	I															35	59												CUSA1
04	I															60	84												CUSA2
05	I															85	109												CUSA3
06	I															110	111												STATE
07	I															P	112	116											ZIPCD
08	I															P	117	118											AREAC
09	I															P	119	122											PHONE
10	I																123	123											CUSTP
11	I															P	124	127											LIMIT
12	I															P	128	130											SLSNO
13	I															P	131	135											AMDUE
14	I															P	136	139											DLTPM
15	I																												

## Creating or Updating Source and Procedure Members

You can use enter/update to create a new source or procedure member, add statements to an existing member, or change statements in an existing member. When you sign on to SEU and identify a member, SEU automatically selects enter/update for you, so the first display you see will include the enter/update prompt at the bottom of the display:

```
16 120 Z          S 1 096 SEULIB AR230R W1
0001.00 FCUSTMSTRU 256 5 I 2 DISK
0002.00 ICUSTMSTR 01
0003.00 I          1 1 ARCOD
0004.00 I          35 59 CUSA1
0005.00 I          60 84 CUSA2
0006.00 I          85 109 CUSA3
0007.00 I          110 111 STATE
0008.00 I          P 112 1160ZIPCD
0009.00 I          P 117 1180AREAC
0010.00 I          P 119 1220PHONE
0011.00 I          123 123 CUSTP
0012.00 I          P 124 1270LIMIT
0013.00 I          P 128 1300SLSNO
0014.00 I          P 131 1352AMDUE
0015.00 I          P 136 1390DLTPM

Enter or update statement number . . . . .
```

When you are working with a member during a job and you want the enter/update prompt again, press the Enter/Update command key (Cmd 5).

Chapter 1 also explained that what you see on the display when you sign on to SEU depends on whether the member exists or not. If you identified a new member, a blank Z-display is shown.

If the member already exists, the first 16 lines of data are displayed (as shown in the previous example). You can use the roll keys to roll through the statements and review the data.

found within a statement. A response of N means the scan characters are replaced everywhere they are found within the statement.

If you leave this field blank, and did *not* enter a starting position on the previous scan display, the default is N. However, if you entered a starting position on the earlier display, the default is Y.

**End of replace area:** This is the ending or right-margin position of the data that will be scanned and replaced within a statement. Data beyond this position in the statement will not be replaced. For example, in an 80-column statement, if the end of the replace area is 60, columns 61 through 80 will not be scanned or shifted.

When you do not enter a response for this prompt, SEU assumes that the end of replace area is the end of the statement. When you do enter a response for this prompt, SEU limits the scan and replacement to a specific portion of each statement. This will protect any data to the right of the changed area that should not be shifted out of its position.

**Ending with statement number:** This is the number of the last statement that will be scanned and replaced within the member. If a last statement number is not entered, SEU continues to scan and replace throughout the entire member. To limit the number of statements that are scanned, enter a last statement number.

**Note:** The scan and replace always begins with the second statement on the SEU display when the scan responses were entered.

## ***Adding Statements***

To add a statement, type a new statement number in response to the enter/update prompt and press the Enter key. For example, if you want to add a statement between statements 3 and 4, enter any number between 3 and 4, such as 3.1, in response to the enter/update prompt.

## ***Changing Statements***

To update an existing statement, enter an existing statement number in response to the prompt. For example, if you want to change statement 5, enter a 5 in response to the enter/update prompt. If you specified member type A, F, W, or R, SEU displays that statement using the correct display so you can change the data. If you specified member type S or if you want a different display, press the Select Display command key (Cmd 3) and choose the necessary display.



## Removing Statements

Use delete to remove statements from a source or procedure member. You can remove one statement at a time or several consecutive statements at a time. Select delete by pressing the Delete command key (Cmd 4); the following delete prompts are displayed:

```
16          S      1  096  SEULIB      AR230R      W1
0001.00    FCUSTMSTRU      256  5  I      2  DISK
0002.00    ICUSTMSTR      01
0003.00    I
0004.00    I
0005.00    I
0006.00    I
0007.00    I
0008.00    I
0009.00    I
0010.00    I
0011.00    I
0012.00    I
0013.00    I
0014.00    I
0015.00    I

          1  1  ARCOD
          35  59  CUSA1
          60  84  CUSA2
          85 109  CUSA3
          110 111  STATE
          P 112 1160ZIPCD
          P 117 1180AREAC
          P 119 1220PHONE
          123 123  CUSTP
          P 124 1270LIMIT
          P 128 1300SLSNO
          P 131 1352AMDUE
          P 136 1390DLTPM

Delete, starting from statement number .....
Ending with statement number.....
```

- **Delete, starting from statement number:** Enter the statement number of the single statement you want to remove, or enter the statement number of the first statement in the series you want to remove.
- **Ending with statement number:** Enter the statement number of the last statement in the series you want to delete. You can leave this blank if you are removing only one statement.

If you enter the same statement number for the first prompt as for the second prompt, SEU will respond with the message:

```
Delete starting/ending stmt equal-one stmt assumed
```

After you type in the statement numbers you want to remove, press the Enter key to enter the responses. SEU displays the first and last statements to be removed so you can make sure the responses are correct before the statements are actually removed.

Press the Enter key *again* to remove the statements. If you do not press the Enter key this second time, SEU ignores your responses and does *not* remove the statements.

If you decide not to remove the statements, do not press the Enter key. Press the Delete command key (Cmd 4) again; you will return to the delete prompts, where you can change your responses. Or press another command key to select another use of SEU.

**Note:** If you remove all statements from a member and take one of SEU end-of-job options 1 through 4, the member is removed from the library. The REMOVE procedure is faster than signing on to SEU to remove a member. REMOVE is described in the *System Reference* manual.

To copy or move a single statement, you do not have to enter an ending statement number. To copy or move a group of consecutive statements, respond to all the prompts.

- **Copy or move the statements:** The default value for this prompt is COPY. If the response is not changed, the statements specified are copied. To move the statements specified to another location, change the response to MOVE or M.
- **To statement number:** Enter the statement number that identifies the new location for the first statement (or the single statement) that you want to copy/move. The statement number you enter must not already exist in the member, and there must be enough room between the existing numbers for another number.
- **Starting from statement number:** Enter the number of the first statement (or the single statement) you want to copy or move.
- **Ending with statement number:** Enter the number of the last statement that you want to copy or move. You can leave this prompt blank if you are moving or copying a single statement.

After you type in the responses, press the Enter key. SEU displays the first and last statements that are to be copied or moved so that you can make sure the responses are correct before the statements are actually copied or moved.

Press the Enter key *again* to actually move or copy the statements. If you do not press the Enter key this second time, the statements will *not* be copied or moved.

If you decide not to copy or move the statements, do not press the Enter key. Press the Copy/Move command key (Cmd 10) again to redisplay the copy/move prompts and change your responses. Or press another command key to select another use of SEU.

## How to Insert More than 99 Statements

The following example shows you how to insert more than 99 statements between two statements in a member. Assume the following statement numbers already exist:

```
0003.00
0004.00
0005.00
0006.00
```

To insert more than 99 statements (by entering, moving, or including) between statements 3.00 and 4.00, press the Copy/Move command key (Cmd 10) and respond to the prompts as follows:

```
Copy or move the statements . . . . . MOVE
To statement number . . . . . 3.01
Starting from statement number . . . . . 4.00
Ending with statement number . . . . .
```

Press the Enter key and verify your responses. Press the Enter key again to move the statement.

By moving the data in statement 4.00 into statement 3.01, you make it possible to enter 198 statements numbered 3.02 through 4.99. Statement numbers now are:

```
0003.00
0003.01
0005.00
0006.00
```

## Copying Statements from One Member to Another

**Note:** This example assumes a second member (AR231R) already exists in your library. If you do not have another member in the library, you will not be able to run the include example.

Include is used to copy statements from one member to another. Statements copied by include are not removed from their original member.

Include only duplicate data that already exists in a library, not data in the work area. In other words, you cannot use include to copy changes you just made during the current job.

### Example 6

This example will copy statements 1 through 7 from member AR231R into member AR230R. The statements will be placed between statements 8 and 9 of member AR230R. Both members are in the same library and both are SEU member type R.

Assume that the following statements exist for member AR231R:

```
16 120 Z          1 096 SEULIB  AR231R  W1
0001.00 FCUSTAMT U      62 8 I      6 DISK
0002.00 ICUSTAMT  01
0003.00 I
0004.00 I          P  1  52AMDUE
0005.00 I          6  13 CUSNO
0006.00 I          14  38 CUSNM
0007.00 I          P 39 420CRLIM
0008.00 I          P 43 472CHGTD
0009.00 I          P 48 5220VR30
0010.00 I          P 53 5720VR60
          P 58 6220VR90

Enter or update statement number . . . . .
```

To include statements from AR231R, press the Include command key (Cmd 11). The include prompts are displayed:

```

16          1 096 SEULIB  AR230R  W1
0001.00    FCUSTMSTRU      256 5 I  2 DISK
0002.00    ICUSTMSTR  01
0003.00    I
0004.00    I              1  1 ARCOD
0005.00    I              35  59 CUSA1
0006.00    I              60  84 CUSA2
0007.00    I              85 109 CUSA3
0008.00    I              110 111 STATE
0009.00    I              P 112 116OZIPCD
0010.00    I              P 117 118OAREAC
0011.00    I              P 119 122OPHONE
0012.00    I              123 123 CUSTP
0013.00    I              P 124 127OLIMIT
0014.00    I              P 128 130OOLSNO
0015.00    I              P 131 1352AMDUE
              P 136 139ODLTPM

Include from library name . . . . .
Include from member name . . . . .
Including at statement number . . . . .
Starting from statement number . . . . .
Ending with statement number . . . . .

```

Type in the first three responses shown and press the Enter key:

```

16          1 096 SEULIB  AR230R  W1
0001.00*   FCUSTAMT U      62 8 I  6 DISK
0002.00*   ICUSTAMT  01
0003.00*   I              P  1  52AMDUE
0004.00*   I              6  13 CUSNO
0005.00*   I              14  38 CUSNM
0006.00*   I              P  39 42OCRLIM
0007.00*   I              P  43 472CHGTD
0008.00*   I              P  48 522OVR30
0009.00*   I              P  53 572OVR60
0010.00*   I              P  58 622OVR90

Include from library name . . . . . SEULIB
Include from member name . . . . . AR231R
Including at statement number . . . . . 0008.10
Starting from statement number . . . . .
Ending with statement number . . . . .

```

Notice the AR231R is shown at the top of the display so that you can view AR231R and choose which statements to include and identify their statement numbers. Now type in the last two responses (1 and 7) and press the Enter key. The following is displayed so that you can make sure your responses are correct:

```

16          1 096 SEULIB AR230R 0007 W1
0001.00*    FCUSTAMT U      62 8 I   6 DISK

0007.00*    I                                P 43 472CHGTD
Include from library name . . . . . SEULIB
Include from member name. . . . . AR231R
Including at statement number . . . . . 0008.10
Starting from statement number. . . . . 0001.00
Ending with statement number. . . . . 0007.00

```

If the responses are correct, press the Enter key *again* to combine the data. If you do not press the Enter key again, the statements are not included.

If you want to change the responses, do not press the Enter key. Press the Include command key (Cmd 11) again and type new responses, or press another command key to select another use of SEU.

**Note:** After you press the Enter key you can see how the data from the two members is combined by holding the Shift key (⇧) down and pressing the Roll Down key (Roll ↓). The following is displayed:

```

16          1 096 SEULIB AR230R W1
0001.00    FCUSTMSTRU      256 5 I 2 DISK
0002.00    ICUSTMSTR      01
0003.00    I              1 1 ARCOO
0004.00    I              35 59 CUSA1
0005.00    I              60 84 CUSA2
0006.00    I              85 109 CUSA3
0007.00    I              110 111 STATE
0008.00    I              P 112 1160ZIPCD
0008.10    FCUSTAMT U      62 8 I 6 DISK
0008.11    ICUSTAMT      01
0008.12    I              P 1 52AMDUE
0008.13    I              6 13 CUSNO
0008.14    I              14 38 CUSNM
0008.15    I              P 39 420CRLIM
0008.16    I              P 43 472CHGTD
0009.00    I              P 117 1180AREAC
Include from library name . . . . . SEULIB
Include from member name. . . . . AR231R
Including at statement number . . . . .
Starting from statement number. . . . .
Ending with statement number. . . . .

```

**Include Prompts**

To include a single statement, you do not need to enter an ending statement number. To include a series of consecutive statements, respond to all of the prompts. Responses are:

- **Include from library name:** Enter the name of the library that contains the member from which you want to include statements. SEU will display the name of the library you are currently using.
- **Include from member name:** Enter the name of the member from which you want to include statements. If neither P nor S is entered, the member type is assumed to be the same type as the member you are using.

If the include member is a procedure member, type a comma and a P after the member name (name,P) to identify the member as a procedure member. Or you can also type an S after the member name to indicate a source member (name,S).

- **Including at statement number:** Enter the statement number that identifies the place at which the included statements will be added to the member.

**Note:** If you type in responses to the first three prompts and press the Enter key, SEU will display the member to be included from so that you can roll through that member to determine the correct numbers of the statements you are including.

- **Starting from statement number:** Enter the number of the first statement (or the single statement) you want to include.
- **Ending with statement number:** Enter the number of the last statement you want to include. You can leave this prompt blank if you are including a single statement.

After you type in the responses, press the Enter key. SEU will display the first and last statements to be included, so that you can make sure the responses are correct.

Press the Enter key *again* to actually have the statements included. If you do not press the Enter key the second time, SEU ignores the include responses and the statements are *not* included.

If you decide not to include the statements, do not press the Enter key. Press the Include command key (Cmd 11) again; you will return to the include prompts where you can change your responses. Or press another command key to select another use of SEU.

**Note:** You can also use include to copy statements from one location in a member to another location in the same member, but the statements to be included must already exist in the library. In other words, you cannot use include to copy any statements you have just entered or changed during your current job.



## Locating and Replacing Characters in a Member

You can do three things with scan/replace:

- You can search through a member to locate (but not change) a particular sequence of characters.
- If scan locates the characters, the statement containing the characters can be displayed using the Scan to Update command key (Cmd 14) so that you can manually make changes to the statement.
- The scan and replace prompt on the scan display allows you to automatically substitute one set of characters for another set of characters within a single statement or throughout the member.

### How to Look through a Member Using Scan (without Making Changes)

#### Example 7

**Note:** Because you may not have had the second member available for the previous example, Example 7 will continue as if none of the data in Example 6 was included in member AR230R.

You use scan when you want to locate a set of characters within a member. Scan will search the member and tell you if the characters are in the member. If scan does find the characters, it also shows you where the characters were first found.

To search through a member and find a particular word or set of characters, press the Scan/Replace command key (Cmd 2). The following is displayed. In this example, to make SEU search for the word AMDUE, type in that word as shown:

```
16          1 096 SEULIB  AR230R  W2
0001.00    FCUSTMSTRU      256 5 I  2 DISK
0002.00    ICUSTMSTR  01
0003.00    I
0004.00    I          1 1 ARCOD
0005.00    I          35 59 CUSA1
0006.00    I          60 84 CUSA2
0007.00    I          85 109 CUSA3
0008.00    I          110 111 STATE
0009.00    I          P 112 1160ZIPCD
0010.00    I          P 117 1180AREAC
0011.00    I          P 119 1220PHONE
0012.00    I          123 123 CUSTP
0013.00    I          P 124 1270LIMIT
0014.00    I          P 128 1300SLSNO
0015.00    I          P 131 1352AMDUE
          P 136 1390DLTPM

Scan characters . . . . . AMDUE
Starting at position . . . . .
Number of scan characters . . . . .
Scan and replace? . . . . . Y,N N
```

If you leave the second response blank, each statement is scanned, starting with the first position. Leave the third response blank; it will be explained later. At this time we do not want to replace AMDUE with anything else, so leave an N as the last response.

Now press the Enter key and the following is displayed:

```
16                      1 096 SEULIB  AR230R      W2
0014.00                I          P 131 1352AMDUE
0015.00                I          P 136 1390DLTPM

Scan characters . . . . . AMDUE
Starting at position. . . . .
Number of scan characters . . . . . 05
Scan and replace? . . . . . Y,N N
SEU-0569
053 is the position of the scan characters
```

The scan always starts with the second displayed statement—in this case, statement 2, and continues on through the entire member, back to statement 1.

The statement number of the first occurrence of AMDUE is displayed on the last line of the display.

Also the statement where AMDUE was first located is displayed at the top of the display.

If SEU cannot find the scan characters you entered, it displays this message on the bottom line:

The scan characters were not found in the member

## Scan Prompts

You must at least enter a response to *Scan characters* or *Number of scan characters*. The following explains the possible responses and restrictions for each prompt.

**Note:** To scan for lowercase characters, you must first press the Select Display command key (Cmd 3) and select the Z-lower format. After that, if the Scan/Replace command key (Cmd 2) is pressed, the scan prompts will allow lowercase responses. Only the Z-lower display allows you to enter lowercase responses.

- **Scan characters:** This is the consecutive group of as many as 25 characters you want to find (sometimes called a character string). Blanks are valid in any position of the group. If blanks are included at the beginning or end of the group, remember to include them in your count and enter a value for *Number of scan characters*.

If you do not enter a response to this prompt, you must enter a value for *Number of scan characters*. If you do not enter any scan characters, SEU assumes the scan characters are blanks and searches for a group of blanks with the length you specify for the *Number of scan characters* prompt.

**Note:** SEU searches for the scan characters in any form. For example, when scanning for the word ADD, SEU will display ADDITION, ADDRESS, or similar occurrences of the letters ADD. You can isolate the word ADD by including the blank before or after the group of characters. See *Scan and Replace* later in this chapter for similar considerations when performing a scan and replace function.

- **Starting at position:** This is the starting position of the scan characters within the statements you are searching. It limits the scan to starting at a particular position within each statement. The scan skips over any data in the statement up to the starting position and scans only the number of characters specified.

For example, assume you want to scan the C-specification result field (columns 43 through 48) of an RPG source program for a specific name. You specify column 43 as the starting position. If there are six scan characters in the string, SEU scans only positions 43 through 48.

This prompt is optional and can remain blank. If you leave the prompt blank, SEU searches the entire statement for the specified scan characters. When the scan characters are found, the statement where the characters are first located is displayed on the first display line. The scan continues with the next statement when you press the Enter key again.

- **Number of scan characters:** This is the number of scan positions, including blanks. Any number from 1 through 25 may be entered. If the number you specify is less than the number of scan characters you entered, SEU shortens the right end of the scan character string to this length. If the number you specify is greater than the number of scan characters you entered, SEU assumes blanks on the right end of the scan character string.

This prompt is optional only if you entered a value for *Scan characters* earlier. If you do not enter a value, SEU assumes that the scan characters contain no blanks at the end, counts only the number of scan characters, and enters the value for you.

- **Scan and replace?:** If you enter a Y, you can replace one set of scan characters with a set of replacement characters you specify in the next series of prompts.

Refer to *Scan and Replace* later in this chapter for examples of the replace prompts.

Enter an N if you do not want to replace the scan characters. The scan then continues and you will not see any of the replace prompts. N is the default value for this field.

If the scan characters are not found, SEU displays the message at the bottom of the display:

```
The scan characters were not found in the member
```

**Note:** If the first statement located by the scan is not the statement you want, press the Enter key to continue the scan.

## Scan and Replace

### Example 8

Many times you need to make several changes to data in your statements. If the same data appears several times within several statements, you want to make sure the change is made in each place, for example, changing CUSTMSTR to CUSTMAST.

SEU can make several changes at once for you.

To make sure the change is made every place the data appears, and each change is correct, use scan/replace.

**Note:** See *When Scan and Replacement Characters Aren't Equal in Length* later in this chapter for your considerations when the number of scan characters is different from the number of replacement characters.

Replace is an option of scan, and you can use it by pressing the Scan/Replace command key (Cmd 2). Again, notice the last scan responses are displayed. Enter the new responses shown, but be sure to type a Y in response to the last scan prompt like this:

```
16                1  096  SEULIB  AR230R  W2
0014.00          I                P 131 1352AMDUE
0015.00          I                P 136 1390DLTPM

Scan characters . . . . . CUSTMSTR
Starting at position. . . . .
Number of scan characters . . . . .
Scan and replace? . . . . . Y,N Y
```

The following is displayed. Because you are replacing CUSTMSTR with CUSTMAST, enter CUSTMAST as the replacement characters:

```
16          1 096 SEULIB AR230R W2
0014.00     I          P 131 1352AMDUE
0015.00     I          P 136 1390DLTPM

Replacement characters. . . . . CUSTMAST
Number of replacement characters. . . . .
Replace once per statement? . . . . . Y,N N
End of replace area . . . . . 096
Ending with statement number. . . . . 0014.00
```

Although statement 14.0 is at the top of the display, SEU will start the replacement with the second displayed statement (statement 15.0) and continue back through statement 14.0.

Press the Enter key; the next display is shown:

```

16                               1 096 SEULIB AR230R W2
0014.00 I                        P 131 1352AMDUE
0015.00 I                        P 136 1390DLTPM

Scan characters . . . . . CUSTMSTR
Starting at position. . . . .
Number of scan characters . . . . . 08
Scan and replace? . . . . . Y,N Y
SEU-0597
0002 statements have been changed

```

The number of statements in which replacements were made is indicated on the bottom line.

To see how the statements were changed, hold down the Shift key (⇧) and press the Roll Down key (Roll ↓):

```

16                               1 096 SEULIB AR230R W2
0001.00 FCUSTMASTU 256 5 I 2 DISK
0002.00 ICUSTMAST 01
0003.00 I 1 1 ARCOD
0004.00 I 35 59 CUSA1
0005.00 I 60 84 CUSA2
0006.00 I 85 109 CUSA3
0007.00 I 110 111 STATE
0008.00 I P 112 1160ZIPCD
0009.00 I P 117 1180AREAC
0010.00 I P 119 1220PHONE
0011.00 I 123 123 CUSTP
0012.00 I P 124 1270LIMIT
0013.00 I P 128 1300SLSNO
0014.00 I P 131 1352AMDUE
0015.00 I P 136 1390DLTPM

Scan characters . . . . . CUSTMSTR
Starting at position. . . . .
Number of scan characters . . . . . 08
Scan and replace? . . . . . Y,N Y

```

## Replace Prompts

You must enter either the replacement characters or the number of replacement characters. You may enter both, however. If you enter only the number of replacement characters, SEU assumes the replacement characters are blanks and substitutes blanks for the scan characters.

You can remove the scanned-for characters by leaving the *Replacement characters* prompt blank and entering a 0 for *Number of replacement characters*. SEU removes the scan characters and moves the data to the left to close up the empty space.

**Replacement characters:** These are the characters SEU uses to replace the scan characters you specified. From 0 to 25 alphameric characters can be entered.

This prompt is optional and can remain blank if you enter a value for *Number of replacement characters*. When you do not enter any replacement characters, SEU assumes the replacement characters are a string of blanks with the length you specify for *Number of replacement characters*.

**Note:** The replacement characters will replace the scan characters wherever the scan characters are found. For example, assume you enter ADD for *Scan characters* and SUB for *Replacement characters*. ADDITION becomes SUBITION, ADDRESS becomes SUBRESS, and so on. You can isolate the scan characters by including, as scanned-for characters, any blanks that appear at the beginning and/or end of the scan characters.

**Number of replacement characters:** This is the number of replacement characters SEU uses to replace the scan characters you specified. This prompt is optional and can be left blank if you entered replacement characters. When this prompt is left blank, SEU counts the number of replacement characters you entered (including blanks embedded within the group of characters) and displays that number. SEU does not count blanks at the end of the replacement characters. Some things to remember for this prompt are:

- The number of replacement characters can be any number 0 through 25.
- Enter 0 to remove the scan characters wherever they have been found and close up the space.
- If blanks are to be included at the end of the replacement characters, be sure to include them in the number of replacement characters.

If you enter a value that is less than the number of replacement characters entered, SEU shortens the right end of the string of replacement characters to this length. If you did not specify any replacement characters, SEU assumes a string of blanks the length of the value you entered.

See *When Scan and Replacement Characters Aren't Equal in Length* later in this chapter for considerations when the number of scan characters is different from the number of replacement characters.

**Replace once per statement?:** A response of Y to this prompt limits the replacement to only the first time the scan characters are



## When Scan and Replacement Characters Aren't Equal in Length

When the number of scan characters is different from the number of replacement characters, one of the following will happen:

- **If there are more replacement characters than scan characters:**

This means you are trying to add more new characters than you took out of the statement. To allow for this, data is shifted to the right to make room for the replacement characters to be inserted. However, shifting will not occur beyond the position you specify for the *End of replace area* prompt.

If you do not specify an *End of replace area*, all data in the statement to the right of the replacement characters is shifted by SEU to make room for the replacement characters—as long as there are blanks in the end positions of the statement.

**Note:** This shifting of data will reposition some data and could cause syntax errors for RPG or WSU programs.

For example, replacing CUSTMST with CUSTMAST requires a shift of data to the right as the following example shows:

```
16                               1 120 SEULIB   OE400R
0002.00 // FILE NAME-CUSTMST,UNIT-F1
0003.00 // FILE NAME-CUSTORDS,UNIT-F1
0004.00 // RUN

Scan characters . . . . . CUSTMST
Starting at position. . . . .
Number of scan positions . . . . .
Scan and replace? . . . . . Y,N Y
```

Enter the replacement characters:

```
16                               1 120 SEULIB  OE400R
0002.00 // FILE NAME-CUSTMST,UNIT-F1
0003.00 // FILE NAME-CUSTORDS,UNIT-F1
0004.00 // RUN

Replacement characters. . . . . CUSTMAST
Number of replacement positions . . . . .
Replace once per statement? . . . . . Y,N N
End of replace area . . . . . 120
Ending with statement number. . . . . 0002.00
```

When you press the Enter key, the scan prompts are redisplayed and the first statement changed is displayed on the second line of the display. The number of statements changed is noted at the bottom of the display:

```
16                               1 120 SEULIB  OE400R
0002.00 // FILE NAME-CUSTMAST,UNIT-F1
0003.00 // FILE NAME-CUSTORDS,UNIT-F1
0004.00 // RUN

Scan characters . . . . . CUSTMST
Starting at position. . . . .
Number of scan positions . . . . . 07
Scan and replace? . . . . . Y,N Y
SEU-0597
0001 statements have been changed
```

If data is to be shifted to the right to make room for the replacement characters, there must be enough blank space available at the end of the statement for the shift.

If there is not enough blank space available, an error occurs. SEU redisplay the scan and replace prompt with the affected statement on the first line of the display. You cannot change the responses to the scan and replace prompt at this time. You should note the error and statement number for correction later and press the Enter key to continue.

**Note:** If an error occurs and you do not continue the replacement, all replacements that have occurred up to the error will remain.

- **If there are fewer replacement characters than scan characters:**

The data between the replacement characters and the end of replacement area is shifted to the left to close the gap created by the replacement. Blanks are inserted between this data and the end of the replacement area.

**Note:** Again, this could cause syntax errors for an RPG or WSU member.

For example, replacing CUSTMAST with CUSTMST requires a shift of data to the left, as the following example shows.

Enter the scan characters, blank out the number of scan characters, and make sure that a Y is in the last position:

```
16                               1 120 SEULIB   OE400R
0002.00 // FILE NAME-CUSTMAST,UNIT-F1
0003.00 // FILE NAME-CUSTORDS,UNIT-F1
0004.00 // RUN

Scan characters . . . . . CUSTMAST
Starting at position. . . . .
Number of scan positions . . . . .
Scan and replace? . . . . . Y,N Y
SEU-0597
0001 statements have been changed
```

Enter the replacement characters:

```
16                               1 120 SEULIB   OE400R
0002.00 // FILE NAME-CUSTMAST,UNIT-F1
0003.00 // FILE NAME-CUSTORDS,UNIT-F1
0004.00 // RUN

Replacement characters. . . . . CUSTMST
Number of replacement positions. . . . .
Replace once per statement? . . . . . Y,N N
End of replace area . . . . . 120
Ending with statement number. . . . . 0002.00
```

When you press the Enter key, the scan prompts are displayed again, and the number of statements changed is noted at the bottom of the screen:

```
16                               1 120 SEULIB   OE400R
0002.00 // FILE NAME-CUSTMST,UNIT-F1
0003.00 // FILE NAME-CUSTORDS,UNIT-F1
0004.00 // RUN

Scan characters . . . . . CUSTMST
Starting at position. . . . .
Number of scan positions . . . . . 08
Scan and replace? . . . . . Y,N Y
SEU-0597
0001 statements have been changed
```

## How to Make Changes to a Statement During a Scan

### Example 9

You may want to locate and change data within a member. For this example, search for LIMIT and change it to CRLIM.

To scan for the data and be able to update it, press the Scan/Replace command key (Cmd 2). Notice the last scan responses are still displayed.

Type in LIMIT as shown in the following display:

```
16          1 096 SEULIB AR230R W2
0001.00    FCUSTMASTU      256 5 I  2 DISK
0002.00    ICUSTMAST  01
0003.00    I
0004.00    I              1 1 ARCOD
0005.00    I              35 59 CUSA1
0006.00    I              60 84 CUSA2
0007.00    I              85 109 CUSA3
0008.00    I              110 111 STATE
0009.00    I              P 112 1160ZIPCD
0010.00    I              P 117 1180AREAC
0011.00    I              P 119 1220PHONE
0012.00    I              123 123 CUSTP
0013.00    I              P 124 1270LIMIT
0014.00    I              P 128 1300SLSNO
0015.00    I              P 131 1352AMDUE
              P 136 1390DLTPM

Scan characters . . . . . LIMIT
Starting at position. . . . .
Number of scan characters . . . . .
Scan and replace? . . . . . Y,N N
```

Then press the Scan to Update command key (Cmd 14), rather than the Enter key.

When the scanned-for characters are found, SEU displays the statements so that you can change them.

Change LIMIT to CRLIM, as shown, and press the Enter key to enter the change:

```

16 120 Z      Update          1 096 SEULIB  AR230R      W2
      I                          123 123 CUSTP

      1          2          3          4          5          6          7
123456789012345678901234567890123456789012345678901234567890123456789
      I                          P 124 1270CRLIM

8          9          0          1          2
012345678901234567890123456789012345678901234567890

Enter or update statement number . . . . . 0012.00

SEU-0569
053 is the position of the scan characters

```

SEU then displays the next statement (in the example, statement 15) in enter/update even though it may not contain the scan characters:

```

16 120 Z      Update          1 096 SEULIB  AR230R      W2
      I                          P 124 1270CRLIM

      1          2          3          4          5          6          7
123456789012345678901234567890123456789012345678901234567890123456789
      I                          P 128 1300SLSNO

8          9          0          1          2
012345678901234567890123456789012345678901234567890

Enter or update statement number . . . . . 0013.00

```

To continue the scan to update, press the Scan to Update command key (Cmd 14) again.

## **Print Option for Replace**

When the print option is on, SEU prints the "before" and "after" version of each statement in which a replacement was made. The before-replacement version of the statement is identified with three hyphens (---). The after-replacement version of the statement is printed as it now exists.

## ***Scan and Replace Using Ideographic Characters***

You may scan for ideographic characters if your system has the Ideographic Character Generator feature. This section contains material unique to an ideographic system, and should be used in addition to other information in this manual.

The string of ideographic characters must be preceded by a Shift Out (SO) character and followed by a Shift In (SI) character. The SO occupies one position, each ideographic character occupies two positions, and the SI character occupies one position.

### **Considerations**

In ideographic mode, the entries for the *Scan characters* will automatically be bracketed with SO and SI characters. However, you may be scanning for a particular ideographic character in the middle of a character string. This character would be positioned away from both the SO and SI characters.

To handle the above situation, a new line was added to the scan display. A Y (yes) response to *First Character Is Omitted From Scan* will remove the SO character from the scan. A N (no) response will leave the SO character as part of the scan characters. N is the default entry.

To include or exclude the SI character, simply adjust the *Number of scan positions* entry.



*Example 10*

You may want to search a message member to find and change an ideographic character. To find (フ) in the character string (エフロシジフ), try the following example.

```
First Character Is Omitted From Scan..... Y
Scan characters..... ( エ フ )
Starting at position.....
Number of scan positions..... 2
Scan and replace..... N
```

The way the character (フ) is located in the character string (エフロシジフ), it does not have a SO to its immediate left. A Y is entered here to omit the automatically supplied SO from the scan.

The character is entered, and automatically bracketed with a SO and a SI character.

The Starting at position prompt is left blank, so you will find the character wherever it appears.

A 2 is entered for the number of scan positions because each ideographic character is two positions long and you do not want the SI character bracketing the scan character to be included.

N is the response to scan and replace. Properly bracketed ideographic character strings can be replaced automatically in the same way alphameric character strings can be replaced. However, unbracketed ideographic characters cannot be replaced automatically.

SEU will find your character in the character string and display the statement so that you can change it in the normal fashion.

## Translating Messages

**Note:** Before running this example, you may want to refer to the CREATE procedure in the *System Reference* manual to better understand how the source messages member is created.

The example will use a member named MESSAGES with statements 80 characters long. MESSAGES looks like this:

```
MEMBER      MESSAGES LIBRARY  SEULIB      SEU EOJ PRINTOUT      DATE 12/17/82      TIME 08.45
                                                    IBM SYSTEM/36 SOURCE ENTRY UTILITY

MESSAGES,1
0101 THIS IS THE FIRST MESSAGE
0102 THIS IS THE SECOND MESSAGE
0103 THIS IS THE THIRD MESSAGE
0104 THIS IS THE FOURTH MESSAGE
0105 THIS IS THE FIFTH MESSAGE
                **** END OF SEU PRINTOUT ****
```

You can translate your message into other national languages by using SEU message translation. Message translation is available for existing message source members by specifying member type T at SEU sign-on:

SEU PROCEDURE Optional-\*

Source entry utility (SEU) is a program that allows you to create, change, remove, and locate statements in source and procedure members

Name of member to be created or updated . . . . . MESSAGES

Type of SEU member. . . . . A,F,P,R,S,T,W T

Name of member containing SEU formats . . . . . #SE@XTRA

Length of statement . . . . . 80

Name of library containing member . . . . . SEULIB

Cmd3-Previous menu

(C) 1983 IBM Corp.

**Note:** If you do not specify a statement length of 80, SEU may issue a warning message that data will be lost. Source type members can have statements 96 characters long, but message translate only allows 80 characters. Make sure your messages are not longer than 80 characters.

You are prompted to enter a translation for the first message (0101):

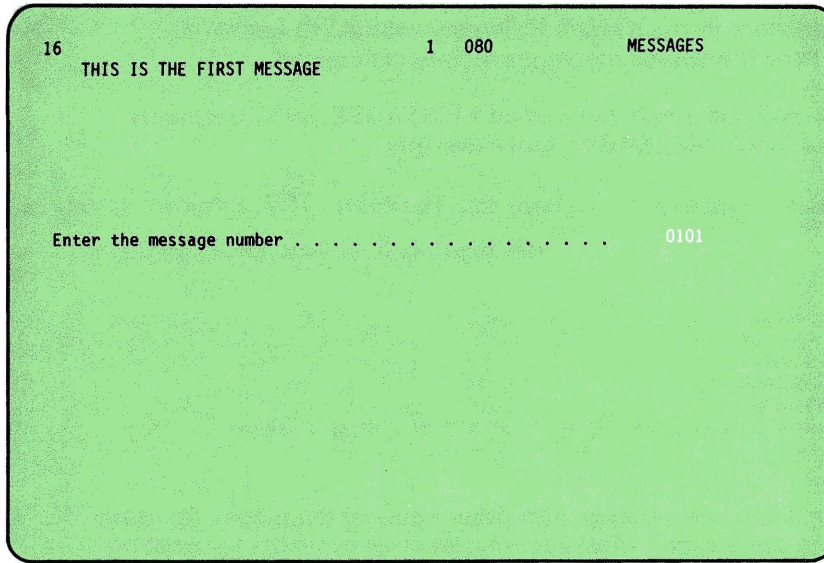

Enter the translated version of the message and press the Enter key:

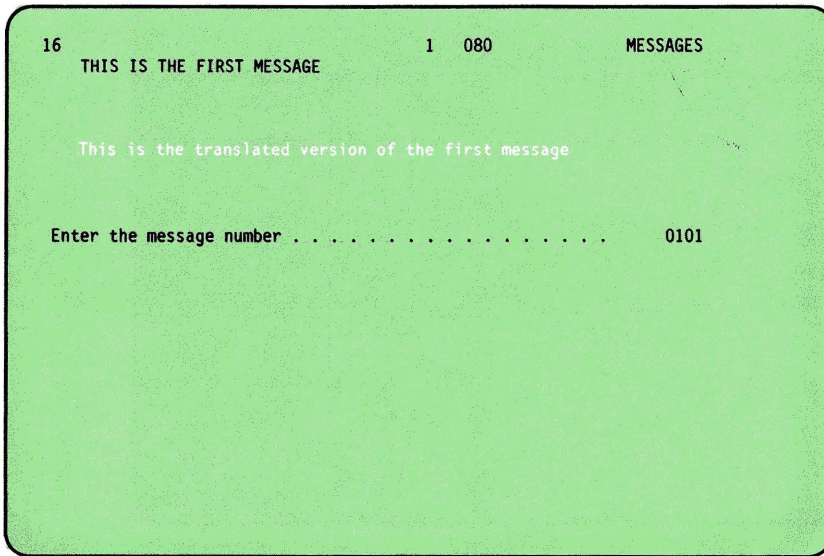

You can continue to enter translations. When you reach the last statement in the source member (by entering translations or pressing the Enter key), SEU displays the message statements and the translations.

Each translated statement is assigned the same four-digit message identification code (MIC) number as the untranslated message. As a result, the source member contains both the untranslated message and the translated message for each message (or MIC):

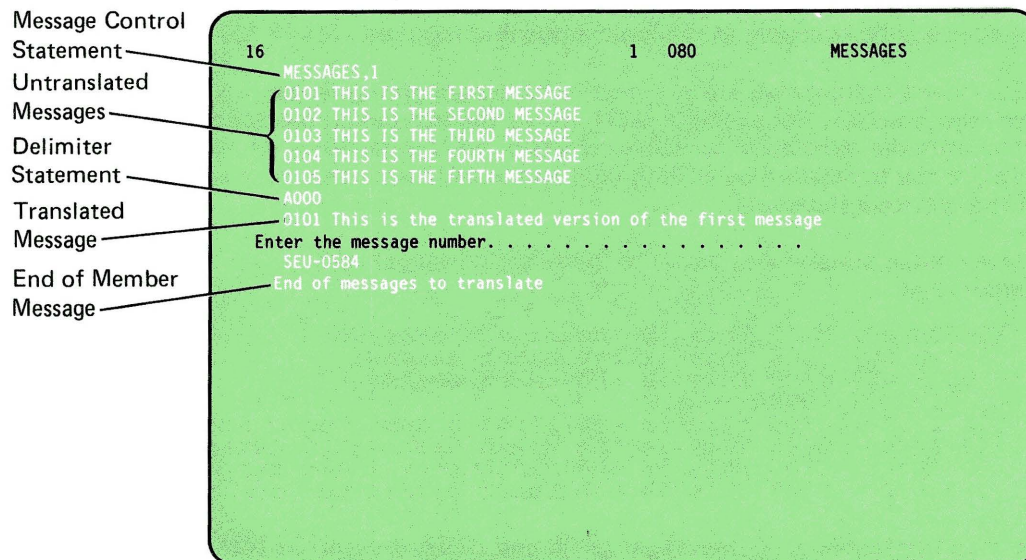

Notice that A000 is stored after the last untranslated message. This is called a *delimiter statement* and is a temporary record added at the end of the member by SEU at sign-on. The delimiter tells SEU where the original message statements end and the translated messages begin.

After a translation has been entered, as many as four untranslated statements of the next message set can be displayed. A message set consists of consecutive statements that contain an asterisk (\*) in column 1 or consecutive statements that contain the same MIC number in columns 1 through 4. Comment statements (identified by an asterisk in column 1) are displayed for possible translation.

You can enter more lines for a translated message than were used to enter the untranslated message.

Once you have added the translated statements to the message source statements using message translation, use the CREATE procedure to get a message load member. When you run the CREATE procedure, the source member must contain only the message control statement and the translated messages.

Either create a new source member and, using include, copy only the message control statement and the translated version of the messages to the member. Or, delete the original messages and the A000 delimiter statement from the member. More information on how to use the CREATE procedure is in the *System Reference* manual.

## ***Inserting Translations***

If you have already added an untranslated message statement into the message member, you can also add a translation for the message. However, when you insert a sequence of translations, you should insert them in ascending message number order so that a statement number will be available at the logical position required.

SEU inserts the translations in numerical order according to the message number. For example, SEU inserts the translation message 0107 after the translation for message 0105. SEU determines where to place the translation by adding 0.01 to the SEU statement number of the previous statement.

For example, assume you have the following messages and translations:

```
(00009.00) 0107 This is the eighth message
(00010.00) 0108 This is the ninth message
(00011.00) 0109 This is the tenth message
(00012.00) A000
(00013.00) 0104 This is the fifth translated message
(00014.00) 0105 This is the sixth translated message
(00015.00) 0108 This is the ninth translated message
(00016.00) 0109 This is the tenth translated message
```

To insert translations for messages 0106 and 0107, enter 0106 first. SEU determines that the translation for 0106 must be inserted before the translation for 0108 and following 0105. So, SEU adds .01 to message 0105's statement number (00014.00) and inserts the translation for message 0106 at statement number 00014.01.

If you had inserted message 0107 first, SEU would have determined that 0107 should be inserted between 0105 and 0108 and placed the translation for 0107 at statement 00014.01. There would then be no room between statements 00014.00 and 00014.01 for message 0106's translation. An error message would be displayed.

You would have to use move/copy to move the translation for message 0107 (statement number 00014.01) to another location to make room.

## ***Summarizing Message Translation***

When you sign on to SEU and specify an SEU member type of T, SEU determines whether the message member exists and if the member contains the delimiter statement with A000 in positions 1 through 4.

The determination results in one of the following displays:

- If the member specified at SEU sign-on does not exist in the specified library, a blank Z-display is shown so that you can begin entering message statements.
- If the member exists, the first eight statements following the message member control statement are displayed on the screen in the prompting mode of the message translate function.

**Notes:**

1. The first time you try to enter translations for an existing member, SEU inserts the delimiter statement in the member.
2. All the uses of SEU (enter/update, move/copy, delete, and include) are available to help you make any necessary changes to the message source member.



## Chapter 4. Displays To Guide You

As you saw in Chapter 1, SEU offers displays (sometimes called specification displays or display formats) to guide you when entering or changing statements.

All of the displays are stored together in two load members, #SE@FORM and #SE@XTRA. Refer to *Storing New or Changed Displays* in Chapter 5 for more details.



## SEU-Supplied Displays

SEU-supplied displays available to guide you include:

- Free-form, for entering and changing statements for which special displays do not exist, like OCL
- RPG II and auto report, for entering and changing RPG II and auto report specifications
- Work station utility (WSU), for entering and changing WSU specifications
- SFGR, for entering and changing display formats used by the display format generator utility program (\$SFGR)
- Command, to enter and change IGC character entries
- Assembler, for entering and changing assembler and macro processor instruction statements
- FORTRAN IV, for entering and changing FORTRAN IV statements
- COBOL, for entering and changing COBOL statements
- AUTOR, for entering source statements for automatic response to messages
- Message, for entering source statements for messages
- Sort, for entering and changing sort sequence specifications
- Magnetic character reader, for entering and changing specifications for the *IBM 1255 Magnetic Character Reader*
- BGU, for entering data for the Business Graphics Utility.

More detail on each display is found later in this chapter.

## What the Displays Do for You

Chapter 1 explained that you can get a list (menu) of the SEU displays by pressing the Select Display command key (Cmd 3):

```
                Select display

1 Z              17 WSU-J          33 FORTRAN        49
2 Z-LOWER       18 WSU-E          34 COBOL          50
3 H              19 WSU-T          35 SDAS           51
4 U              20 WSU-M          36 SDAH           52
5 F              21 WSU-S          37 SDAD1          53
6 G              22 WSU-D          38 SDAD2          54
7 E              23 WSU-C          39 DOC-H          55
8 L              24 SFGR-S          40 AUTOR          56
9 T              25 SFGR-H          41 MESSAGE        57
10 I             26 SFGR-D          42 SRT-HEAD       58
11 J             27 D-CONT          43 SRT-RECD       59
12 C             28 SORTH           44 SRT-CNST       60
13 D             29 SORTRF          45 SRT-FLD        61
14 P             30 SORTRC          46 MICRSYS        62
15 K             31 SORTF           47 MICRSTCK       63
16 A             32 ASSEM           48                64

Enter the number of the specification display you want. . . . .
```

When you select a display, that display guides you when you are entering or updating statements. Column positions are marked on the display, and fields are separated by blank spaces, or text is given that describes each field.



## ***The Order of the Displays When Entering a Member***

When you sign on to SEU and identify a member, the Z-display is automatically selected by SEU. This display will continue to be used for each statement you enter or change unless you select a different display using the Select Display command key (Cmd 3).

When you are entering SEU member types W or F, and you have selected your first display, SEU knows that the displays for those member types are used in a particular order. Based on the previous statement, SEU aids you in the selection of the appropriate display.

For more information, see *WSU* or *SFGR* later in this chapter.

## ***The Order of the Displays When Making Changes***

If you are adding or updating statements, SEU determines the display type of the statement that precedes the statement being entered, then selects the same display. SEU determines the type of display by the character in column 6 of the previous display.

If the statement to be updated is in an SEU member type of W or F, SEU will begin selecting the displays in sequence once you choose the first display.

## What Type of Field Is It?

Each SEU-supplied display (except the free-form) has some predefined fields. That is, there are fields that will accept only certain types of data. There are fields that affect the way you move the cursor from field to field. There are fields that are *protected*. And there are fields that are set up to always contain the same data.

**Note:** On the SEU displays, certain types of fields are shown in different ways. Numeric and alphameric right-adjust fields are displayed in reverse image. Headings for protected fields are underlined. Headings for autoskip fields are also underlined if autoskip is on. For example:

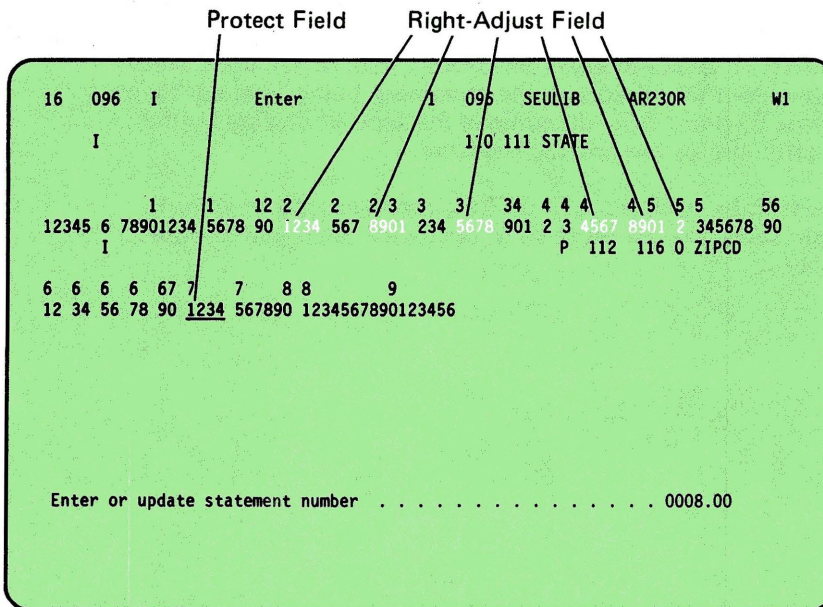

If the autoskip is turned off, the underline is removed from the autoskip fields.

## ***Alphameric Fields***

Any letter, number, or special character on the keyboard is a valid entry for an alphameric field.

## ***Numeric Fields***

Valid entries for a numeric field are the numbers 0 through 9 as well as the + (plus sign), - (minus sign), . (decimal point), blank, and , (comma).

## ***Protected Fields***

Protected fields are fields that are skipped. You cannot enter data into a protected field. Protected fields also save you time, since you do not have to manually move the cursor past a field that is protected.

## ***Autoskip Fields***

Autoskip fields (a special type of protected field) are fields that the cursor skips over whenever the SEU autoskip option is on.

Position 39 of the status line reflects the status of the autoskip option: A if it is on, blank if it is off. The Autoskip command key (Cmd 1) reverses the status of the autoskip option.

## ***Constant Fields***

Constant fields contain predefined *constants* (data that is always in a certain field). For example, position 6 in RPG II specifications is a constant because it always contains a letter that identifies which specification you are using; F for file description specifications, I for input specifications, and so on.

You can change the contents of a constant field if it is not specified as a protected field, which must be skipped.

The constant field already has the constant entered when a new statement is being entered.

## ***Controlled Field Exit (Auto-Exit Field)***

When you enter enough data to fill every position of an auto-exit field, the cursor automatically moves to the next field in the statement.

**Note:** The cursor automatically moves to the next field when an entry is made in a field that is only 1 character long.

## Adjust/Fill (Right-Adjust Field)

If a field is specified as adjust/fill (right-adjust), the contents of the field are moved to the rightmost position of the field when you press the Field Exit or Field+ key.

If the field is defined as zero fill, the remaining positions to the left of the data are filled with zeros. If the field is defined as blank fill, the remaining positions are filled with blanks.

The contents of the field are not right-adjusted if you press the Field Advance key.

In the following example, assume you have a four-position, right-adjust, blank fill field and you type in three characters:

```
16 096 F          Update          1 096 SEULIB  AR23OR  W1

      1      1 1 1 1 1 2  2  2 23 3 3 3 3  3 4      4 5 5 5
12345 6 78901234 5 6 7 8 9 0123 4567 8 90 1 2 34 5678 9 0123456 789012 3 456789
      F CUSTMAST U          296

6      6 6 6 7 7 7 7  8 8      9
012345 6 7 89 0 12 34 567890 1234567890123456

Enter or update statement number . . . . . 0001.00
```

When you press the Field Exit or Field+ key, position 1 in the field is left blank and the three characters you entered are moved to positions 2, 3, and 4 and remaining positions are filled with blanks:

```

16 096 F          Update          1 096 SEULIB  AR230R      W1

      1 1 1 1 1 2  2 2 23 3 3 3 3  3 4  4 5 5 5
12345 6 78901234 5 6 7 8 9 0123 4567 8 90 1 2 34 5678 9 0123456 789012 3 456789
      F CUSTMAST U          → 256

6      6 6 6 7 7 7 7  8 8      9
012345 6 7 89 0 12 34 567890 1234567890123456

Enter or update statement number . . . . . 0001.00

```

### ***Ideographic Fields***

Any specification listed on the *Select display* will accept ideographic characters (IGC) in alphameric fields. You may enter ideographic characters if you are in ideographic mode. IGC mode requires: that you have the IGC SSP on your system; that you are signed-on at an ideographic-capable display; and that you respond with a Y to the IGC prompt at sign-on.

Each group of ideographic characters on each line must start with a shift out (SO) character and end with a shift in (SI) character. If an ideographic constant is continued on the next specification line (as a continuation of the constant) a SI character must end the first line and a SO character must start the next line. SEU will remove the SI, the SO, any blanks in between them, and put the constant together in one unbroken character string. Putting the character string together like this is called concatenation.



## More Details About the SEU Displays

Earlier in this chapter you saw a brief description of each type of display that SEU provides to guide you when entering statements. The following sections give a more detailed explanation of each display:

```

                                Select display

1 Z          17 WSU-J          33 FORTRAN          49
2 Z-LOWER   18 WSU-E          34 COBOL           50
3 H          19 WSU-T          35 SDAS            51
4 U          20 WSU-M          36 SDAH            52
5 F          21 WSU-S          37 SDAD1           53
6 G          22 WSU-D          38 SDAD2           54
7 E          23 WSU-C          39 DOC-H           55
8 L          24 SFGR-S         40 AUTOR           56
9 T          25 SFGR-H         41 MESSAGE         57
10 I         26 SFGR-D         42 SRT-HEAD        58
11 J         27 D-CONT         43 SRT-RECD        59
12 C         28 SORTH          44 SRT-CNST        60
13 O         29 SORTRF         45 SRT-FLD         61
14 P         30 SORTRC         46 MICRSYS         62
15 K         31 SORTF          47 MICRSTCK        63
16 A         32 ASSEM          48                 64

Enter the number of the specification display you want. . . .
```

### **Free-Form**

SEU selects a free-form (Z-display) for the first display shown after sign-on. Free-form displays allow you to enter alphameric data into any character position on the display. There are two Z-displays: Z and Z-LOWER.

The Z-display permits entry of only uppercase characters; Z-LOWER permits entry of lowercase and uppercase characters. You must use the Shift key ( ) to enter uppercase characters on the Z-LOWER display.

Statements entered and updated using the free-form display can be as many as 120 characters long. In order to display all 120 character positions, free-form displays separate each statement into two fields: The first field is 79 positions long; the second is 41 positions long. The displays can be used to enter and change statements for which unique specification displays do not exist, such as OCL statements or BASIC statements.

## ***RPG II and Auto Report***

The following RPG II and auto report (K and U) displays are provided for entering and updating RPG II and auto report specifications. Each RPG II and auto report display is 96 positions long.

### **Specification Displays**

H	Control specification
U	Option format used by RPG II auto report
F	File description specification
G	(F-Cont) File description continuation
E	Extension specification
L	Line counter specification
T	Telecommunications specification
I	Input specification (record identification)
J	(I-Cont) Input specification for columns 44 through 96 (field description)
C	Calculation specification
O	Output specification (file identification and control)
P	(O-Cont) Output specifications for columns 32 through 96 (field description)
K	Copy specification used by RPG II auto report

## Checking Syntax of RPG II and Auto Report Statements

SEU can check the syntax of RPG II and auto report statements that are specified at sign-on as SEU member type R or A.

Limited syntax checking is offered as an option to help eliminate compile-time errors. SEU can diagnose many coding or typing errors that would result in an error, but SEU cannot diagnose all terminal compilation errors detected by the RPG II compiler.

For example, SEU does not detect errors that result from a conflict between entries in two or more statements. The syntax checking that is done is based on the display type used to enter or update the statement. When the F-format is used, for example, file description syntax checking is done.

SEU does allow auto report entries on all RPG F-, I-, J-, O-, and P-displays. For more information, see the manual *Programming with RPG II*.

## Error Detection

If you specify SEU member type R or A for an RPG II or auto report member, SEU checks the syntax of each statement as it is entered. SEU can diagnose only one error each time it checks the syntax of a statement, even though a statement may contain several errors.

If SEU finds a syntax error in a statement, it displays a diagnostic message. So that you can correct the error, SEU displays the statement again. When you press the Enter key after correcting the error, SEU again checks the syntax of the statement.

If you press the Accept with Error command key (Cmd 12) after a syntax error is found, SEU accepts the statement whether or not an error still exists in it. If the print option is on and a syntax error is present, SEU prints the statement, followed by \*\*\*. SEU also prints an asterisk beneath the field that is related to the error and the *message identification code* (MIC) of the appropriate SEU diagnostic message after the asterisk.

If the print option is on and you corrected all syntax errors in a statement, SEU prints only the corrected statement.

A blank entry in a statement in an auto report member is not necessarily a blank entry after RPG II compilation. It may be modified by a statement being copied. Therefore, the level of syntax checking performed on auto report specifications is limited to the level of syntax checking performed on RPG II specifications.

**Note:** The /COPY statement of auto report restricts copying to a maximum statement length of 96 bytes.

## Comments

Comments are source language statements that have no effect on the source, but are printed as part of an output printout. SEU provides the A-display, with an asterisk (\*) in position 7, that can be used by all programming languages except BASIC for comments.

## **Work Station Utility (WSU)**

SEU provides displays for entering and changing WSU J-, E-, T-, M-, S-, D-, and C-specifications. Comments for WSU can also be entered or changed using the comment display, A.

Each WSU display is 96 positions long.

For a member type of W (WSU), the correct order for the displays is J, E, T, M, S, D, and C. Once you select the J-display, enter a statement, and then press the Enter key, SEU selects the E-display. SEU will continue to select the E-display until you select a different display (in this case, the T-specification).

Once you enter a T-specification, SEU selects an M-display for you and will continue to select M-displays for you until you select another display (in this case, the S-specification). When you enter an S-specification, SEU selects the D-display and continues to select D-displays for you until you select a different display (in this case, C).

When you are updating a member, SEU selects the appropriate display determined by the entry in column 6 of that statement.

A WSU user can also use the SDA displays (SDAS, SDAD1, and SDAD2) for S- and D-specifications. These are *descriptive* prompting displays. A descriptive display means you are prompted for information and therefore do not need a specification (or coding) sheet to identify each column.

A WSU user can also use the D-Cont display to continue the constant field from the D-specification.

This is the WSU-D display:

```

16 096 WSU-D Update 1 096 WSULIB AR100W W1
0003 SAR100WD1

1 1 1 1 1 12 2 2 2 2 2 2 3 3 3 3 3 3 3 3 3 34 4 4 4 4 4
12345 6 789012 34 5 6 78 90 12 34 5 6 7 8 9 0 1 23 4 5 6 78 90 12 34 56 78 9
0004 D 02 26

5 5 5 5 5 6 7 8 8 9
0 1 2345 6 78901234567890123456789 0 1234567890123456
P 'PAYMENTS ON ACCOUNT'

Enter or update statement number . . . . . 0004.00

```

This is an example of the SDAD1 display:

```

16 080 SDAD1 Update 1 096 WSULIB AR100W W1
0003 SAR100WD1

Seq No 0004 Form type D Fld name Fld len
Line N 02 Position 26 Output data Allow input Data type
Mand ent Mand fill Self chk Enable dup WSU edit
Pos cursor Adjust/fill Ctl fld exit Auto rec adv Col sep
Protect fld Blink fld Underline Non-display Reverse image
High inten Lowercase
Const.type P Constant 'PAYMENTS ON ACCOUNT' Continuation

Enter or update statement number . . . . . 0004.00

```

For more information on the WSU specifications, see the *WSU Guide*.

## SFGR

SEU provides four displays for entering and changing display format specifications: SFGR-S, SFGR-H, SFGR-D, and D-Cont. These describe the display control (S) specifications, the application help (H) specifications, and field definition (D) specifications for the \$SFGR utility program.

If you specify member type F, once you select the SFGR-S display and enter an S-specification, SEU will select the SFGR-D display for you. When you are updating a member, SEU selects whichever display is appropriate depending on the entry in column 6 of that statement.

Each SFGR display is 96 positions long.

For more information about entries on the SFGR displays, see *Entries on the Display Format Specifications* in the manual *Creating Displays*.

### SFGR-S

SFGR-S (also known as the S-specification) is used to enter the display control specification. At least one S-specification is required for each display format generated by \$SFGR and must be the first statement in the member for each display format. SFGR-S provides general information about the entire display format such as: the name of the display format; whether lowercase letters can be entered by the operator; or how entered data will be sent to the user program.

### SFGR-H

SFGR-H (also known as the application help specification) is used to specify an area on the format for which the programmer has defined help text. Application help specifications are optional. If they are coded, any H-specifications must immediately follow the S-specification and precede all D-specifications.

### SFGR-D

SFGR-D (also known as the D-specification) follows the S-specification and the H-specifications. Each statement completely describes a field on the display format. There must be a statement for each field in the display format.

### D-Cont

D-Cont (also known as the continuation specification for the D-specification) allows you to continue the constant data field from the D-specification if the constant would not all fit on the D-specification.

### DOC-H

DOC-H (also known as the document help specification) is used to enter help information for document text. Unlike SFGR-H, documentation help is not sensitive to an area of the display. Documentation help text applies to the document displayed, not to the cursor location on the screen.

## SFGR and WSU Format Prompting

SEU provides prompting specification displays for entering or updating SFGR or WSU-S specifications, D-specifications and D-continuation specifications. The following specification displays have descriptive prompting rather than column definitions; that is, the name of each field is displayed to prompt you for a response:

- SDAS:** Used for SFGR-S or WSU-S specifications
- SDAH:** Used for SFGR-H specifications
- SDAD1:** Used for SFGR-D or WSU-D specifications
- SDAD2:** Used for continuation of SFGR-D or WSU-D specifications

This is a column-defining display:

```
16 096 SFGR-S Update 1 096 WSULIB AR100W W1
0002 TACTRCV WSULIB FILEDEF

      1 1 12 2 2 2 2 2 2 23 3 3 3 3
12345 6 78901234 56 78 90 1 2 34 56 7 8 90 12 34 56 78
0003 5 AR100W01

4 5 6 6 7 8 8 9
9012345678901234567890123 4567890123456789 0 1234567890123456

Enter or update statement number . . . . . 0003.00
```

This is a descriptive display:

```
16 080 SDAS      Update          1 096 WSULIB  AR100W      W1
0002 TACTRCV WSULIB FILEDEF

Seq No.      0003 Form type      S  Format name  AR100WD1  WSU format ID
Start line   Lines to clear  Lowercase   Return input
Reset keybd  Sound alarm    Blink cursor Erase input
Override     Suppress input  WSU start   WSU end
Required     Repeat         Priority     Preprocess
Review record IDs  Insert record IDs  Null fill
Function keys  Command keys  Key mask

Enter or update statement number . . . . . 0003.00
```



## **Command**

SEU provides a display for entering and changing ideographic characters. You may select the Command display only if your system has the ideographic support feature installed and you are signed on to an ideographic-capable display station.

The display consists of two input lines of 60 bytes each. SEU will automatically insert the SO and SI characters as they are required. If the first input line does not have enough room for the input data, you can overflow to the second input line (continuation).

SEU will correctly handle the SI and SO characters and will unite the two input lines when the Enter key is pressed.

## **Assembler**

SEU provides a display for entering and changing assembler language statements. Comments for assembler programs can be entered and changed using the assembler display if the autoskip option is off.

The assembler display is 96 positions long. For more information on using the assembler specifications, see the manual *Programming with Assembler*.

## **FORTRAN IV**

SEU provides a display for entering and changing FORTRAN IV statements and comment statements.

The FORTRAN IV display is 96 positions long. For more information on the FORTRAN specifications, see the manual *Programming with FORTRAN IV*.

## **COBOL**

SEU provides a display for entering and changing COBOL statements.

Continuation statements and comment statements for COBOL programs can be entered and changed using the COBOL display if the autoskip option is off.

The COBOL display is 96 positions long. For more information on using the COBOL specifications, see the manual *Programming with COBOL*.

## **AUTOR**

SEU provides a display for entering automatic response messages. You are prompted to identify the messages to which you want the system to automatically respond when a particular situation or error occurs.

## Message

This is a descriptive prompt for entering message member source statements.

## Sort

The following sort specification displays are provided with SEU. They can be used to enter and update both ideographic and non-ideographic sort sequence specifications.

Display Name	Specifications
SORTH	Header specification
SORTRC	Record type constant specification
SORTRF	Record type field specification
SORTF	Field specification

SORTH describes the type of sort you want to run. SORTRC and SORTRF describe which input records you want to include or omit from the sort. SORTRC describes a record type constant and SORTRF describes control fields and data fields to the sort program and identify which data fields will be included in the output file.

Comments for sort can be entered and changed using the comment display, A.

Each sort display is 96 positions long. For more information on using the sort specifications, see the *Sort Guide*.

The following sort specification displays are also supplied with SEU. They can be used to enter and update only non-ideographic sort sequence specifications.

Display Name	Specifications
SRT-HEAD	Header Specification
SRT-RECD	Record selection, field comparison
SRT-CNST	Record selection, constant or keyword comparison
SRT-CNST	Field specification

These displays are prompt displays, not 96-position coding form displays.

## Magnetic Character Reader

SEU provides the MICRSYS display and the MICRSTCK display to enter or change specifications for the IBM 1255 Magnetic Character Reader. For more information on using these displays, see *IBM System/36 Using and Programming the 1255 Magnetic Character Reader*, SC09-1046.

## Display Lengths Can Be Different from Statement Lengths

The number of character positions available for a particular display (display length) may be different from the number of positions available for a member type (statement length).

In other words, although a source member can have as many as 120 character positions, a display you choose— for example, the I-display— might have only 96 positions available.

When you are entering a new statement and the statement length is greater than the length of the selected display, SEU adds enough blanks to the statement to extend it to the specified statement length. In this example, if the source statement length is 120 and the I-display length is 96, SEU accepts 96 characters of data and adds 24 blanks:

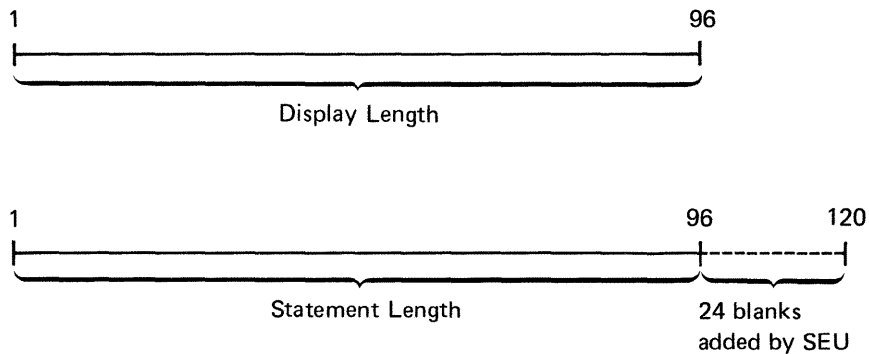

When you are updating a statement, and the statement length is greater than the display length, you may lose data. If SEU discovers data in positions beyond the length of the display, SEU displays a warning message. You can then select a longer display to avoid losing data, or you can press the Enter key and blanks are entered over the data:

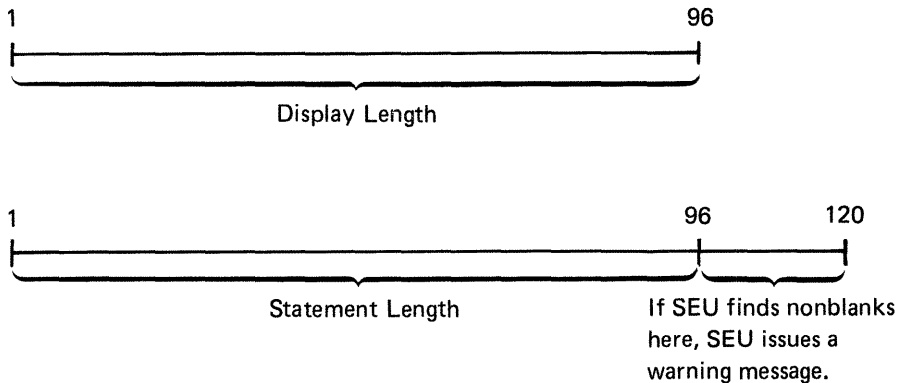

If the length of a statement being entered or updated is less than the length of the selected display, you can enter data only within the limits of the statement length. If you try to enter data beyond the specified statement lengths, SEU truncates the statement at the statement length, displays an error message, and displays the truncated statement. You can press the Enter key to enter the statement as it is displayed.

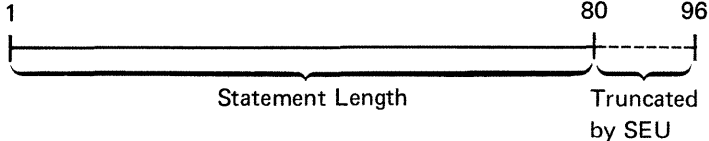
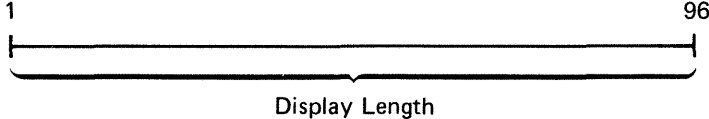



## Chapter 5. Attention Programmers

This chapter is for the programmer or the experienced user of the IBM System/36 and SEU. It contains explanations of extra things you can make SEU do for you, ways to do more complex jobs, and things to consider as you try out new ideas with SEU.

### There Is a Shortcut to Calling SEU

There is an easier way to call SEU rather than being prompted, once you feel more comfortable with the utility. If you do not enter a member type, SEU assumes it is a source member. If you do not enter a library name, SEU looks for the member in the library you are currently using. Therefore, if you are working with a source member (for example, AR230R) that is in the same library you have been using, call SEU by typing:

```
SEU AR230R
```

When you press the Enter key, SEU assumes the member type is S and the member is in the current library.

The member you named is then displayed for you.

## SEU Procedure Command

You can also call SEU using the entire SEU procedure command. The format of the SEU procedure command is:

```
SEU      member name, [ S  
                    (SOURCE)  
                    P  
                    (PROC)  
                    A  
                    F  
                    R  
                    T  
                    W ] , [ seu format member ] , [ statement length ] ,  
                    [ library name  
                    current library ] , [ diagnosed source file ]
```

**member name** Specifies the source member or procedure that you want to create or change. A member name can be as many as eight characters long and must begin with an alphabetic character (A through Z, #, \$, or @). The remaining characters can be any combination of characters (numeric, alphabetic, and special). You should avoid using the following characters because these have special meanings in procedures: commas (,), apostrophes ('), blanks, question marks (?), slashes (/), greater than signs (>) and equal signs (=). Do not use DIR, LIBRARY, or ALL as a member name.

**member type**

**S (SOURCE)** Specify a library source member. If no parameter is specified, S (SOURCE) is assumed.

**P (PROC)** Specify a library procedure member.

**A** Specifies an RPG II program that contains auto report specifications. The syntax of the RPG II program is checked by SEU. SEU displays the RPG specification for each statement in the source member.

**F** Specifies a library source member that contains display format S- and D-specifications. SEU displays the format specification for each statement in the source member.

**R** Specifies a library source member that contains an RPG II program. The syntax of the RPG II program is checked by SEU. SEU displays the RPG specification for each statement in the source member.

**T** Specifies a message translation source member.

**W** Specifies a source member containing work station utility (WSU) statements. SEU displays the WSU specification for each statement in the source member.

**SEU format member** Specifies the name of the SEU display format member to be used to edit source statements. If no format name is specified, #SE@XTRA is assumed.



**statement length**

Specifies the length for each source or procedure statement. This can be any decimal number from 40 to 120. If the member exists, the statement length of the member is assumed. If the member is being created, the values you can specify and the values that are assumed by SEU if no statement length is specified are as follows:

Member Type	Allowed Statement Length	Assumed Statement Length
SOURCE, S	40 to 120	96
PROC, P	40 to 120	120
A	80 to 96	96
F	40 to 120	96
R	40 to 120	96
T	40 to 120	80
W	40 to 120	96

**library name**

Specifies the library that contains or will contain the library member being changed or created. If no library name is specified, the current library is assumed.

**diagnosed source file**

While you are compiling a source member, a diagnosed source file can be created that will contain the source statements along with diagnostic and informational messages. SEU uses that file as input and allows you to make changes. The data in this file is then stored in the library as a source member.

This parameter is used by the RPGONL, COBOLONL, and FORTONL procedures to allow the diagnosed source members to be edited. You do not need to specify this parameter.

See one of the manuals *Programming with RPG II*, *Programming with FORTRAN IV*, or *Programming with COBOL* for more information on diagnosed source members.

*Example*

This example shows how to start SEU to create or change a procedure named PAYROLL. The procedure is contained in the current library:

```
SEU PAYROLL,P
```

## Copying or Moving Statements

Use the Copy/Move command key (Cmd 10) to copy or move statements from one location in a member to another location in the same member. You can copy or move one statement at a time or several consecutive statements at once.

The copy operation duplicates the statements you specify to a new location in the same member, but does *not* remove the original statements. The statements appear at both the original location and the new location.

The move operation relocates statements from one location in a member to a new location in the same member. The statements are no longer at the original location.

**Note:** It is best to use copy/move (rather than include) when changing or adding within a member because copy/move uses the data that you are currently updating. Include uses data that already exists in the library (permanent storage), and it will not reflect changes made to that data during the current job (work area).

When you press the Copy/Move command key (Cmd 10), the following prompts are displayed:

```
16          S      1  096  SEULIB  AR230R      W1
0001.00     FCUSTMSTRU      256  5  I      2  DISK
0002.00     ICUSTMSTR      01
0003.00     I
0004.00     I
0005.00     I
0006.00     I
0007.00     I
0008.00     I
0009.00     I
0010.00     I
0011.00     I
0012.00     I
0013.00     I
0014.00     I
0015.00     I
           1  1  ARCOD
           35  59  CUSA1
           60  84  CUSA2
           85 109  CUSA3
           110 111  STATE
           P 112 1160ZIPCD
           P 117 1180AREAC
           P 119 1220PHONE
           123 123  CUSTP
           P 124 1270LIMIT
           P 128 1300SLSNO
           P 131 1352AMDUE
           P 136 1390DLTPM

Copy or move the statements . . . . . .COPY,MOVE COPY
To statement number . . . . .
Starting from statement number . . . . .
Ending with statement number . . . . .
```

## An SEU Run Sheet

You may want to design an SEU run sheet to simplify SEU instructions for someone else to use. An example of such a sheet is shown below. The example contains entries you would supply for another person to enter:

SEU Job Sheet	
<input type="radio"/>	Date Submitted <u>5-7-82</u>
<input type="radio"/>	Programmer <u>L.G. Philips</u>
<input type="radio"/>	Job Number <u>6269</u>
<input type="radio"/>	Enter: SEU
<input type="radio"/>	Member Name <u>AR230R</u> ; Member Type <u>R</u> ; Format Member Name _____;
<input type="radio"/>	Statement Length _____; Library Name <u>SEULTB</u> ;
<input type="radio"/>	Use Displays: <u>F</u> , <u>I</u> , _____, _____
<input type="radio"/>	SEU Features: <u>Print</u> , <u>AutoSkip</u> , <u>Syntax Check</u>
<input type="radio"/>	EOJ Option: <u>2</u>
<input type="radio"/>	Coding Sheets Attached? <input checked="" type="radio"/> Yes <input type="radio"/> No
<input type="radio"/>	Listing Attached? Yes <input checked="" type="radio"/> No
<input type="radio"/>	Comments: - Enter F and I specs as shown - Use "RPGC" procedure command to compile

A run sheet is a very basic list of step-by-step instructions you give to someone to run a job for you. The run sheet can be kept with the job so the instructions are handy for anyone who needs to run the job.

## How SEU Uses Storage Space

Each SEU job uses a work area in main storage and a work file on disk. The work file on disk contains a copy of the member you are using or creating. As you use SEU, the statements to be changed are read from the work file into a buffer in main storage. The contents of that buffer are displayed as you do your work. As you make changes to the data, it is written to another buffer reserved by SEU for storing changed statements. When this second buffer is filled up, SEU writes the statements back to the work file on disk to make room for more statements in the buffer:

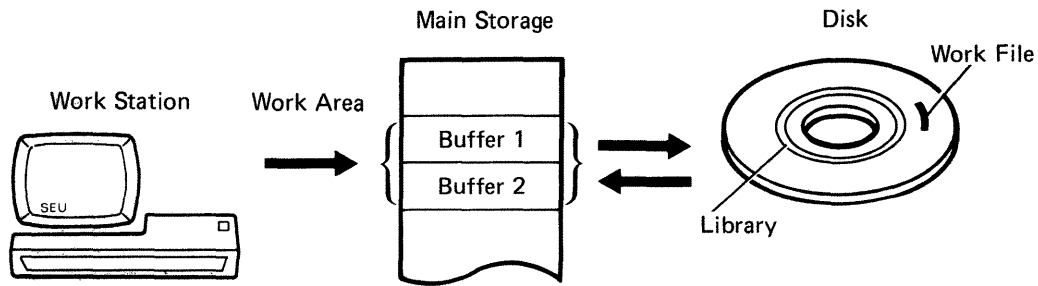

Whether you are updating an existing member or creating a new member, SEU sets up a work file. If you are updating a member, SEU places a copy of the member in the work file:

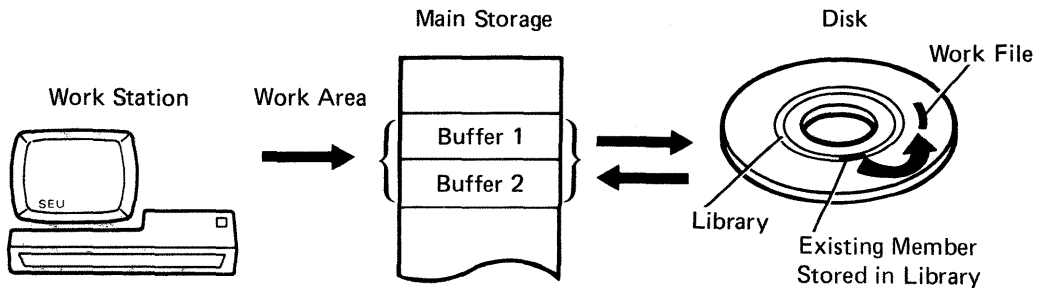

At the end of the job, the member is placed back in the library you specify.

If you created a new member, SEU places the new member in the library you specify:

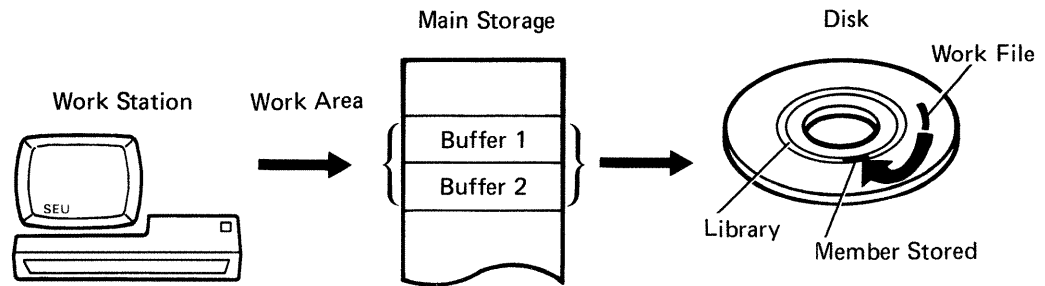

If the updated member increased in size, it is placed in a new location in the library and system pointers to the original member are removed. Anyone who now uses the member will use a copy of the updated version:

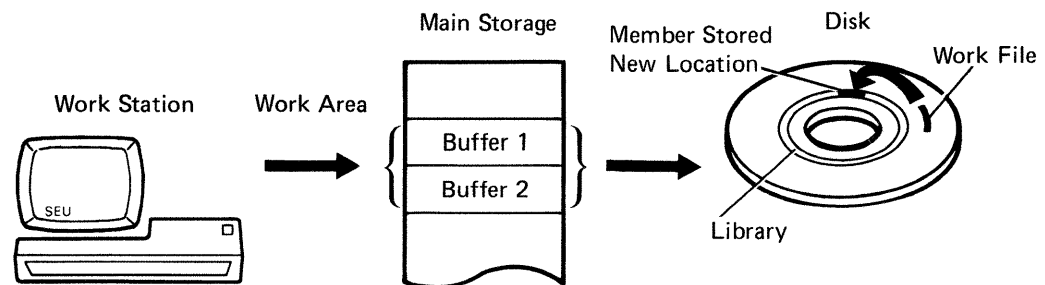

## ***What if There's not Enough Space?***

You may get a message that there is not enough disk space:

- At SEU sign-on: An error message is displayed stating there is not enough space available for the SEU work file
- At the end of the job: If there is not enough space available for the data in the work file, a message is displayed stating that there is no room for the work file.

You will need to delete unnecessary data on the disk or run the COMPRESS procedure to free up unused disk space. See the *System Reference* manual for more information on this procedure.

You may get a message that there is not enough library space:

- At the end of the job: If SEU cannot find enough library space to restore the member, a message is displayed stating that there is no room for the member in the library (you may have increased the size of the member by adding statements).

You will have to delete unnecessary members stored in the library or run the CONDENSE procedure to free up library space. If there is still not enough room in the library, a larger library or a different library will have to be created. See the *System Reference* manual for more information on the CONDENSE procedure.

If you get a message that there is not enough disk or library space, select option 2 and press the Enter key. Once you have created the necessary space, sign on to SEU again. SEU will help you recover the member through a series of recovery prompts. The following section explains the recovery process.

## ***How to Recover from Interruptions: Planned or Unplanned***

Your work can be interrupted for many reasons. For example, jobs might accidentally be canceled at the system console, there could be a power failure, or you might interrupt a job because there was not enough disk or library space available.

If such an error condition exists, you can later recover data from the SEU work file by:

- Signing on at the display station you were using at the time the error or failure occurred, and
- Signing on to SEU the same way you signed on for the original job

After you sign on to SEU again, SEU determines whether or not the work file exists and displays the message:

```
SEU-0545 Work file already exists -- is this a recovery run?...
```

**Note:** SEU cannot recover from permanent disk errors.

There are three options you can choose at this time:

- **Option 0:** You are still in SEU and can continue the job. The first thing to do is check to make sure all your data is saved—the last data you entered may have to be reentered.
- **Option 1:** You are still in SEU but you want to start completely over. SEU will remove the existing work file and create a new empty work file so that you can start again.
- **Option 3:** You want SEU to save the work file but you do not want to do anything with it at this time. Choose this option if you aren't sure what you want to do or don't have time to go through the recovery steps at this time.

When you choose option 0 to continue, SEU checks the parameters you used to sign on. If they do not match the previous sign-on, SEU issues message SEU-0546.

Either you used different parameters to sign on for recovery or someone else was using SEU at that display station when the error occurred. Choose option 3 so that you don't remove the work file.

## SEU-Supplied Displays in a Format Member

When you sign on to SEU, a prompt asks you for an *SEU format member* and supplies a default value of #SE@XTRA. The format members are where the SEU-supplied displays (such as the Z-display) are stored. The displays are stored in two load members: #SE@FORM and #SE@XTRA. #SE@FORM is stored in #SEULIB, and #SE@XTRA is stored in #LIBRARY:

#SE@ FORM
#SE@ XTRA

Select display

1 Z	17 WSU-J	33 FORTRAN	49
2 Z-LOWER	18 WSU-E	34 COBOL	50
3 H	19 WSU-T	35 SDAS	51
4 U	20 WSU-M	36 SDAH	52
5 F	21 WSU-S	37 SDAD1	53
6 G	22 WSU-D	38 SDAD2	54
7 E	23 WSU-C	39 DOC-H	55
8 L	24 SFGR-S	40 AUTOR	56
9 T	25 SFGR-H	41 MESSAGE	57
10 I	26 SFGR-D	42 SRT-HEAD	58
11 J	27 D-CONT	43 SRT-RECD	59
12 C	28 SORTH	44 SRT-CNST	60
13 O	29 SORTRF	45 SRT-FLD	61
14 P	30 SORTRC	46 MICRSYS	62
15 K	31 SORTF	47 MICRSTCK	63
16 A	32 ASSEM	48	64

Enter the number of the specification display you want. . . .

Source members for #SE@XTRA and #SE@FORM contain specifications that define each SEU-supplied display. The specifications that describe a particular display are called a *display format*. The load members contain the compiled display specifications.

**Note:** Loading the source for the format members is optional when SEU is loaded onto the system, so they may not be on your system. The load members are required if you are using the SEU-supplied displays.

You can create your own displays to suit your needs, or you can change an SEU-supplied display or its name. (You cannot, however, change the name of the Z-display.) You can reduce the size of the format members by deleting some SEU-supplied displays, or you can delete the format member source completely. Be sure you are not deleting a display used by another operator.



## ***Creating and Changing Displays***

Each SEU-supplied display is defined by a display format. All display formats exist originally as a sequence of display format specifications (S- and D-specifications) in a source member. The specifications are compiled into a load member by the display format generator utility program (\$SFGR).

Changing the specifications that define a display format is the first step in changing the display itself.

A complete description of how to design and code display formats, how to run \$SFGR, and how to design, code, and maintain display formats is given in the *Creating Displays* manual.

Before you create or change an SEU display format, you should be familiar with the restrictions imposed by SEU on the contents of a format intended for SEU.

### **Restrictions**

- A display format you define for SEU must describe only lines 1 through 7 of the display. SEU places the seven lines properly on the display. SEU requires the other lines for displaying status information, prompts, and messages. Although each of lines 1 through 7 need not be defined, defining a line other than 1 through 7 causes an error.
- The start line number (columns 17 and 18 of the display control specification, S-specification), must be variable. Enter a V in column 17. In addition, enter 00 in columns 19 and 20, for the number of lines to clear.
- Command key or function key masking (columns 27, 28, and 64 through 79) of the S-specification will be ignored by SEU.
- You cannot call a message to be shown within the display you are creating.
- Fields to contain heading information, such as column positions, must be defined as output fields. Enter Y in column 23 and enter C in column 56 of the field definition specification (D-specification).
- Fields to contain data must be defined as input/output fields. Enter Y in columns 23 and 26 of the D-specification. By defining data fields both as input and as output, you permit SEU to display data in the fields after the operator enters data into the fields as well as data already existing in the fields.
- The Z-display must not be deleted from #SE@FORM. There must be a Z-display in the format member #SE@FORM or SEU will not work.
- If you create a display format with the same name as a display format supplied by SEU, you will overlay the SEU display.
- The load member #SE@FORM and any other load member that contains display formats required by an SEU job, including #SE@XTRA, must be in the library you are currently using, in #LIBRARY, or in the SEU library (#SEULIB).

- A display format can define a maximum of 80 input or input/output fields.
- The total length of the input/output fields defined in a display format used by SEU must be at least one but not more than 120 positions.

### ***When You Should not Change a Display's Name***

The name of the free-form Z-display must not be changed, and the Z-display must not be deleted. Z is the display selected by SEU after sign-on. If SEU cannot locate a Z-display, SEU displays an error message.

The names of the RPG II, auto report, and WSU displays must not be changed or deleted if you want SEU to select the displays and check for syntax errors in RPG II and auto report statements.

### ***Storing New or Changed Displays***

To create a load member that contains displays or to add displays to an existing format load member, use the FORMAT procedure. Make sure you enter the correct library where the format is to be stored. You can use the LISTLIBR procedure to determine whether or not all required load members are stored in the same library. The names of SEU-supplied members begin with the characters #SE.

The LISTLIBR and FORMAT procedures are described in the *System Reference* manual.

It is best to create a new format member for your new display formats so that you do not overlay the IBM-supplied displays.

Do not use the name of a member that already exists in a library as the name of a display format member you add.

The total number of display formats stored in #SE@FORM together with those stored in #SE@XTRA (or your own format member) must not be greater than 64. In other words, when you press the Select Display command key (Cmd 3), up to a maximum of 64 displays are available.

# Glossary

**#LIBRARY.** The library, provided with the system, that contains the System Support Program Product. See *system library*.

**accumulate.** To collect.

**allocate.** To assign a resource, such as a disk file or a diskette file, to perform a specific task.

**alphabetic character.** Any one of the letters A through Z (uppercase and lowercase). Some program products extend the alphabet to include the special characters #, \$, and @.

**alphanumeric.** Consisting of letters, numbers, and often other symbols, such as punctuation marks and mathematical symbols.

**alphanumeric.** See *alphanumeric*.

**assembler.** A program that converts assembler language statements to machine instructions.

**attribute.** A characteristic.

**autoskip option.** An option of SEU that allows the cursor to automatically skip fields.

**BASIC (beginner's all-purpose symbolic instruction code).** A programming language designed for interactive systems and originally developed at Dartmouth College to encourage people to use computers for simple problem-solving operations.

**call.** To activate a program or procedure at its entry point. Compare with *load*.

**cancel.** To end a task before it is completed.

**character.** A letter, digit, or other symbol.

**character string.** A sequence of consecutive characters.

**code.** (1) Instructions for the computer. (2) To write instructions for the computer. Same as *program*. (3) A representation of a condition, such as an error code.

**collating sequence.** The sequence in which characters are ordered within the computer for sorting, combining, or comparing.

**command.** A request to perform an operation or a procedure.

**command display station.** A display station from which an operator can start and control jobs.

**command key indicator.** An indicator that is set on when an operator presses the corresponding command key.

**command keys.** The 12 keys on the top row of the display station keyboard that are used with the Cmd key (and optionally the Shift key) to request up to 24 different actions defined for program products and user programs. Compare with *function key*.

**comment.** Words or statements in a program or procedure that serve as documentation rather than as instructions.

**compile.** To translate a program written in a high-level programming language into a machine language program.

**compress.** To move files and libraries together on disk to create one continuous area of unused space.

**concatenate.** To remove blanks or control characters imbedded in a data string

**constant.** A data item with a value that does not change. Contrast with *variable*.

**constant field.** A field that is defined by a display format to contain a value that does not change.

**cursor.** A movable symbol (such as an underline) on a display, usually used to indicate to the operator where to type the next character.

**default value.** A value stored in the system that is used when no other value is specified.

**delete.** To remove.

**delete-capable file.** A file from which records can be logically removed without compressing the file.

**delimiter.** A character or sequence of characters that marks the beginning or end of a unit of data.

**diagnosed-source file.** A library member containing source statements and associated error messages.

**diagnosed-source member.** See *diagnosed-source file*.

**diagnostic.** Pertaining to the detection and isolation of an error.

**disk.** A storage device made of one or more flat, circular plates with magnetic surfaces on which information can be stored.

**diskette.** A thin, flexible magnetic plate that is permanently sealed in a protective cover. It can be used to store information copied from the disk.

**display.** (1) A visual presentation of information on a display screen. (2) To show information on the display screen.

**display format.** Data that defines (or describes) a display.

**display screen.** The part of the display station on which information is displayed.

**display station.** A device that includes a keyboard from which an operator can send information to the system and a display screen on which an operator can see the information sent or receive information from the system.

**edit.** (1) To modify the form or format of data; for example, to insert or remove characters such as for dates or decimal points. (2) To check the accuracy of information that has been entered, and to indicate if an error is found.

**enter.** To type in information on a keyboard and press the Enter key in order to send the information to the computer.

**field.** One or more characters of related information (such as a name or an amount).

**file.** (ANSI definition) A set of related records treated as a unit.

**format.** (1) A defined arrangement of such things as characters, fields, and lines, usually used for displays, printouts, or files. (2) To arrange such things as characters, fields, and lines.

**FORTRAN (formula translation).** A high-level programming language used primarily for scientific, engineering, and mathematical applications.

**free-form format.** The SEU display format designed for entering and updating statements, such as OCL statements and utility control statements, that do not have a constant format.

**function.** In BASIC and FORTRAN, a named expression that calculates a single value.

**function key.** A keyboard key that requests an action but does not display or print a character. The cursor movement and Help keys are examples of function keys. Compare with *command keys*.

**ID.** Identification.

**ideographic character.** A two position pictogram or graphic character.

**ideographic support.** A system support program feature that enables the use of ideographic-capable displays, printers, and programs.

**informational message.** A message that provides information to the operator, but does not require a response.

**initial program load (IPL).** The process of loading the system programs and preparing the system to run jobs.

**input.** Data to be processed.

**input/output (I/O).** (ANSI definition) Pertaining to either input or output, or both.

**IPL.** See *initial program load*.

**job.** (1) A unit of work to be done by a system. (2) One or more related procedures or programs grouped into a procedure.

**key.** One or more characters used to identify the record and establish the record's order within an indexed file.

**left-adjust.** To place or move an entry in a field so that the leftmost character of the field is in the leftmost position. Contrast with *right-adjust*.

**library.** (1) A named area on disk that can contain programs and related information (not files). A library consists of different sections, called library members. (2) The set of publications for a system.

**library member.** A named collection of records or statements in a library. The types of library members are *load member*, *procedure member*, *source member*, and *subroutine member*.

**library member subtype.** A specific classification of a library member type. For example, a source member can be identified as a COBOL source member or a DFU source member.

**load.** (1) To move data or programs into storage. (2) To place a diskette into a diskette drive or a magazine into a diskette magazine drive. (3) To insert paper into a printer.

**load member.** A library member that contains information in a form that the system can use directly, such as a display format. Contrast with *source member*.

**machine language.** A language that can be used directly by a computer without intermediate processing.

**macroinstruction.** A single instruction that represents a set of instructions.

**main storage.** The part of the processing unit where programs are run.

**mask.** A pattern of characters that controls the keeping, deleting, or testing of portions of another pattern of characters.

**member.** See *library member*.

**menu.** A displayed list of items from which an operator can make a selection.

**message.** Information sent to an operator or programmer from a program. A message can be either displayed or printed.

**message identification code (MIC).** A four-digit number that identifies a record in a message member. This number can be part of the message identification.

**message member.** A library member that defines the text of each message and its associated message identification code.

**MIC.** See *message identification code*.

**mode.** A method of operation.

**numeric.** Pertaining to any of the digits 0 through 9.

**OCL.** See *operation control language*.

**online document.** A DW/36 term used to describe text that may be displayed.

**operation control language (OCL).** A language used to identify a job and its processing requirements to the System Support Program Product.

**output.** The result of processing data.

**overlay.** (1) To write over (and therefore destroy) an existing file. (2) A program segment that is loaded into main storage and replaces all or part of a previously loaded program segment.

**pad.** To fill unused positions in a field with dummy data, usually zeros or blanks.

**parameter.** A value supplied to a procedure or program that either is used as input or controls the actions of the procedure or program.

**printout.** Information from the computer that is produced by a printer.

**procedure.** A set of related operation control language statements (and, possibly, utility control statements and procedure control expressions) that cause a specific program or set of programs to be performed.

**procedure command.** A command that runs a procedure.

**procedure member.** A library member that contains the statements (such as operation control language statements) necessary to perform a program or set of programs.

**program.** (1) A sequence of instructions for a computer. See *source program* and *load module*. (2) To write a sequence of instructions for a computer. Same as *code*.

**program product.** A licensed program for which a fee is charged.

**prompt.** A displayed request for information or operator action.

**protected field.** A displayed field in which operators cannot enter data.

**record.** A collection of fields that is treated as a unit.

**recovery procedure.** (1) An action performed by the operator when an error message appears on the display screen. Usually, this action permits the program to continue or permits the operator to run the next job. (2) The method of returning the system to the point where a major system error occurred and running the recent critical jobs again.

**requester.** A display station or interactive communications session that requests a program to be run.

**right-adjust.** To place or move an entry in a field so that the rightmost character of the field is in the rightmost position. Contrast with *left-adjust*.

**RPG.** A programming language specifically designed for writing application programs that meet common business data processing requirements.

**screen design aid (SDA).** The part of the Utilities Program Product that helps the user design, create, and maintain displays and menus. Additionally, SDA can generate specifications for RPG and WSU work station programs.

**SDA.** See *screen design aid*.

**self-check field.** A field, such as an account number, consisting of a base number and a check digit.

**serialization.** The consecutive numbering of statements.

**SEU.** See *source entry utility*.

**shift in (SI) character (hex 0F).** The one position character at the end of an ideographic character string.

**shift out (SO) character (hex 0E).** The one position character at the front of a ideographic character string.

**sign off.** To end a session at a display station.

**sign on.** (Verb) To begin a session at a display station.

**source entry utility (SEU).** The part of the Utilities Program Product used by the operator to enter and update source and procedure members.

**source member.** A library member that contains information in the form in which it was entered, such as RPG specifications. Contrast with *load member*.

**source program.** A set of instructions that are written in a programming language and that must be translated to machine language before the program can be run.

**source statement.** A statement written in a programming language.

**special character.** A character other than an alphabetic or numeric character. For example; \*, +, and % are special characters.

**specification sheets.** Forms on which a program is coded and described.

**spooling.** The part of the System Support Program Product that saves output on disk for later printing.

**SSP.** See *System Support Program Product*.

**statement.** An instruction in a program or procedure.

**status line.** Line 1 of the display which contains general information about a job.

**subroutine member.** A library member that contains information that must be combined with one or more members before being run by the system.

**subtype.** See *library member subtype*.

**syntax.** The rules for the construction of a statement.

**system library.** The library, provided with the system, that contains the System Support Program Product and is named #LIBRARY.

**system printer.** The printer that is used for any printed output that is not specifically directed to another printer.

**System Support Program Product (SSP).** A group of licensed programs that manage the running of other programs and the operation of associated devices, such as the display station and printer. The SSP also contains utility programs that perform common tasks, such as copying information from diskette to disk.

**truncate.** To shorten a field or statement to a specified length.

**unprotected field.** A displayed field for which operators can enter, modify, or delete data.

**Utilities Program Product.** A program product that contains the data file utility (DFU), the source entry utility (SEU), the work station utility (WSU), and the screen design aid (SDA).

**utility program.** A System Support Program Product program that allows you to perform a common task, such as copying information from diskette to disk.

**valid.** (1) Allowed. (2) True, in conforming to an appropriate standard or authority.

**variable.** A name used to represent a data item whose value can change while the program is running. Contrast with *constant*.

**work file.** A file that is used for temporary storage of data being processed.

**work station.** A device that lets people transmit information to or receive information from a computer; for example, a display station or printer.

**work station utility (WSU).** The part of the Utilities Program Product that helps you to write programs for data entry, editing, and inquiry.

**WSU.** See *work station utility*.



# Index

## Special Characters

\$SFGR and WSU prompting 4-16  
\$SFGR displays 4-15  
#SE@FORM 2-4, 4-1, 5-10  
#SE@XTRA 1-6, 2-4, 4-1, 5-10

## A

A-display 4-11  
Accept with Error 4-12  
Accept with Error key 2-10  
accessing SEU 1-5  
adding statements 1-9, 2-21, 3-2, 3-3  
additional information 2-18  
adjust/fill field 4-8  
alphameric fields 4-7  
alter lines per statement 2-11  
answers to questions 2-18  
assembler displays 4-18  
auto report displays 4-11  
auto report error checking 4-12  
auto-exit fields 4-7  
automatic response messages 4-18  
AUTOR displays 4-18  
autoskip feature 2-9  
autoskip fields 4-7  
Autoskip key 2-9

## B

backspace key 2-12  
backup key 2-12  
beginning SEU 2-2  
blinking error messages 1-12

## C

C-display 4-11  
calling SEU 1-5, 2-2, 5-1  
cancel key 2-12  
canceled jobs 5-9  
canceling data 2-12  
canceling the job 2-29  
change roll factor key 2-11  
changing display names 5-12  
changing lines per statement 2-11  
changing SEU displays 5-11  
restrictions 5-11  
changing statement numbers 1-29  
changing statements 1-15, 1-31, 3-2, 3-3  
character reader 4-19  
character string 3-15  
checking for errors 4-12  
checking for syntax errors 2-10  
Cmd keys 2-9, 2-11  
Cmd 1 key 2-9  
Cmd 10 key 2-10  
Cmd 11 key 2-10  
Cmd 12 key 2-10  
Cmd 13 key 2-11  
Cmd 14 2-11  
Cmd 15 key 2-11  
Cmd 2 key 2-9  
Cmd 3 key 2-9  
Cmd 4 key 2-9  
Cmd 5 key 2-9  
Cmd 7 key 2-10  
Cmd 8 key 2-10  
COBOL displays 4-18

column-defining display 4-16  
combining members 3-8  
combining statments from two members 3-8  
command 1-11, 4-2, 4-18  
command key list 2-11  
command keys 2-8, 2-9  
compile-time data 2-27  
compiler diagnostics 2-28  
concatenation 4-9  
CONDENSE procedure 5-8  
constant fields 4-7  
copy/move key 2-10  
copying statements 1-18, 1-22, 3-5  
copying statements using include 3-8  
copying syntax errors 2-10  
correcting statements 1-9, 1-15, 3-2, 3-3  
creating your own displays 5-11  
restrictions 5-11  
current library 2-5

## D

data fields 4-6  
defining a field 1-13  
defining the file 1-13  
delete key 2-9  
deleting statements 1-25, 3-4  
description of command keys 2-8, 2-11  
descriptive prompting 4-16  
descriptive prompting display 4-17  
descriptive prompting displays 4-13  
diagnosed source member 2-28  
disk space 5-6  
updating a member 5-6  
display lengths 4-20  
display selection 4-16  
display storage 2-4  
displaying command key description 2-11  
displaying statements 2-16  
displays 4-1  
storage 5-10  
displays for entering specifications 4-2  
displays that guide you 1-8  
DOC-H 4-15  
document help 4-15  
documenting SEU jobs 2-23  
documenting syntax errors 2-10  
Dup key 2-12  
duplicate program name 2-28  
duplicating statements 1-18, 1-22, 3-5

## E

E-display 4-11  
editing text 1-1  
end of job 1-4, 2-25  
procedure members 2-25  
source members 2-25  
with serialization 2-25  
end of replace 3-21  
end of source key 2-10  
end-of-job  
procedure members 2-29  
end-of-job key 2-10  
ending a procedure job 2-29  
ending your job 2-10  
Enter key 2-9  
entering assembler statements 4-18  
entering COBOL statements 4-18  
entering FORTRAN statements 4-18  
entering sort specifications 4-19  
entering statements 1-9, 3-2

- entering WSU comments 4-13
- entering WSU specifications 4-13
- error accept key 2-10
- error checking 2-10, 4-12
- error detection 4-12
- Error Reset 1-12
- error, accepting 2-10
- errors 5-9
- Example 1 1-9
- Example 10 3-30
- Example 2 1-15
- Example 3 1-18
- Example 4 1-22
- Example 5 1-25
- Example 6 3-8
- Example 7 3-13
- Example 8 3-17
- Example 9 3-26
- examples using SEU 1-9
- existing work files 5-9
- exiting a field 2-18

## F

- F-display 4-11
- Field + key 2-18
- field advance key 2-18
- field backspace key 2-18
- Field Exit key 2-18
- field types 4-6
  - alphanumeric fields 4-7
  - auto-exit fields 4-7
  - autoskip fields 4-7
  - constant fields 4-7
  - numeric fields 4-7
  - protect fields 4-7
  - right-adjust fields 4-8
- finding statements 2-22
- for more information 1-32
- format member name 1-6, 2-4
- format members 4-1, 5-10
- FORMAT procedure 5-12
- formats 4-2
- formats (see displays that guide you) 1-8
- FORTRAN displays 4-18
- free-form displays 4-1, 4-2, 4-10
- function keys 2-12

## G

- G-display 4-11
- general job information 2-19

## H

- H-display 4-11
- help 1-32, 2-18, 4-15
- help—keys that help 2-12
- Home key 2-12
- how SEU works 1-1, 1-31
- how to copy statements 1-18, 1-22
- how to enter statements 1-9, 3-2
- how to move statements 1-18
- how to move statements around 1-18
- how to recover from interruptions 5-9
- how to remove statements 1-25
- how to update statements 3-2
- how to use enter/update 3-3
- how to use SEU 1-2, 3-1

## I

- I-display 4-11
- I-specification 1-13, 4-4
- identifying statements 2-21
- identifying your library 2-5
- ideographic 4-9
- ideographic characters 2-2, 2-5, 4-18
- ideographic field 4-9
- ideographic sign-on 1-11
- if you make a mistake 1-15
- if you press the wrong key 1-12
- IGC 4-9
- include key 2-10
- including two members 2-10
- inserting more than 99 statements 3-7
- inserting statements 2-21
- introduction to SEU 1-1

## J

- J-display 4-11
- J-specification 1-13
- job sheet (sample) 5-5

## K

- K-display 4-11
- keyboard template 2-8
- keys on the top row 2-8
- keys that help you 1-32, 2-8
- keys with special assignments 2-8
- keys with special uses 2-12

## L

- L-display 4-11
- last statement search 2-10
- length of statement 2-5
- library name 1-6, 2-5, 2-27, 2-31
- limiting the replace 3-21
- line 1 of the display 2-19
- list of command keys 2-11
- listing statements 2-24
- LISTLIBR procedure 2-27, 2-32, 5-12
- load member 2-27, 2-32
- loading SEU source 5-10
- locating statements 2-22
- logging procedure statements 2-33
- looking for statements 2-22

## M

- magnetic character reader 4-19
- making changes to statements 1-9, 3-3
- member name 1-6, 2-2, 2-27, 2-30
- member subtype 2-27, 2-32
- member type 1-6, 2-3
- menu of SEU-supplied displays 2-9
- message code 4-12
- Message display 4-19
- message identification code 4-12
- message translate key 2-11
- MIC 4-12
- more scan than replacement characters 3-22
- move/copy key 2-10
- moving out of a field 2-18
- moving statements 1-18, 3-5
- moving statements 1-18
- moving the display 2-16
- MRT programs 2-30, 2-33
- multiple requester terminal procedure 2-33



## N

name of library 2-5  
naming a member 2-2  
new line key 2-18  
not enough disk space 5-6  
number of scan vs replacement characters 3-22  
numbering statements 2-21  
numeric fields 4-7

## O

O-display 4-11  
operator run sheet 5-5  
order of the displays when entering 4-5

## P

P-display 4-11  
positive numeric field 2-18  
pressing the wrong key 1-12  
print key 2-9  
print option 2-9  
printing statements 2-24  
printing syntax errors 2-10  
printing with SEU 2-23  
printout 2-29  
problems 1-32  
procedure command 5-1  
procedures at end-of-job 2-29  
program displays 4-1, 4-2  
programming considerations 5-1  
protect fields 4-7

## Q

questions 1-32  
quick way to call SEU 5-1

## R

recording syntax errors 2-10  
recording your work 2-9, 2-23  
recovery 5-9  
reference number 2-27, 2-31  
relocating statements 1-18, 3-5  
remove (delete) key 2-9  
REMOVE procedure 3-4  
removing characters 3-20  
removing diagnostics 2-28  
removing more than one statement 3-4  
removing statements 1-25, 3-4  
removing the work file 2-29  
renumbering statements 1-29  
replace and scan key 2-9  
restarting 5-9  
restoring members 2-27  
reversing autoskip option 2-9  
reversing lines per statement 2-11  
reversing print option 2-9  
reversing syntax checking option 2-10  
right margin of replace area 3-21  
right-adjust fields 4-8  
roll down key 2-17  
roll factor change 2-11  
roll up key 2-16  
rolling through a member 2-17  
RPG displays 4-11  
RPG error checking 4-12

run sheet 5-5

## S

scan and replace 3-17  
scan and replace - ideographic 3-29  
scan and replace key 2-9  
scan and replacement characters aren't equal 3-22  
scan to update 3-26  
scan to update key 2-11  
SDADH display 4-16  
SDAD1 display 4-16  
SDAD2 display 4-16  
SDAS display 4-16  
search end of source key 2-10  
selecting SEU displays 2-9  
serial numbers 2-28  
serialization 2-25, 2-26  
setting statement length 2-5  
SEU listing 2-24  
SEU load members 5-10  
SEU procedure display 2-2  
SEU uses 3-1  
SEU-supplied displays 2-4, 4-1  
    free-form 4-10  
    RPG and auto report 4-11  
    storage 5-10  
SFGR and WSU prompting 4-16  
SFGR displays 4-15  
shift in 4-9  
shift out 4-9  
shortcut to calling SEU 5-1  
SI 4-9  
sign-on ideographic 1-11  
signing on to SEU 1-3, 1-5, 2-2  
skipping fields 2-9  
SO 4-9  
sort comments 4-19  
sort displays 4-19  
SORTF display 4-19  
SORTH display 4-19  
SORTRC display 4-19  
SORTRF display 4-19  
source member 2-3  
specification displays 4-1, 4-2  
specification sheet 1-9, 4-4  
specification sheets 4-1  
SRT programs 2-30  
statement length 1-6, 2-5  
statement lengths 4-20  
statement numbering 2-21  
status line 2-19, 4-4  
    autoskip option 2-20  
    length of input fields 2-19  
    library name 2-20  
    member name 2-20  
    number of consecutive statements 2-20  
    one line per statement 2-20  
    print on 2-20  
    roll factor 2-19  
    syntax checking option 2-20  
    type of SEU display 2-19  
    work station ID 2-20  
storage 5-6  
storing displays 2-4  
storing members 2-5  
storing new displays 5-12  
storing statement numbers with statements 2-25  
subroutine 2-27, 2-32  
subtype 2-26, 2-27, 2-32  
syntax checking 1-12, 2-10, 4-12  
syntax diagram 5-1  
syntax errors 2-10  
syntax option 2-10  
system failures 5-9

## T

- T-display 4-11
- temporary statement numbers 1-29
- temporary storage 1-31
- translate messages key 2-11
- translating messages 3-31
- translation key 2-11
- type of member 2-3
- types of fields 4-6
  - alphameric fields 4-7
  - auto-exit fields 4-7
  - autoskip fields 4-7
  - constant fields 4-7
  - numeric fields 4-7
  - protect fields 4-7
  - right-adjust fields 4-8

## U

- U-display 4-11
- unspecified subtype 2-27, 2-32
- update after scan 2-11
- update key 2-9
- updating statements 1-15
- using enter/update 1-9, 3-3
- using move/copy 3-5
- using SEU 1-2, 3-1

## V

- viewing a member 2-17
- viewing statements 2-16

## W

- ways to use SEU 1-2
- what is SEU 1-1
- what to call a member 2-2
- when you need help 1-32
- when your work is interrupted 5-9
- where to store members 2-5
- work area 1-3, 1-31
- work file 5-6, 5-9
- wraparound 2-16
- WSU and \$SFGR prompting 4-16
- WSU displays 4-13
  - WSU-C display 4-13
  - WSU-D display 4-13
  - WSU-E display 4-13
  - WSU-J display 4-13
  - WSU-M display 4-13
  - WSU-T display 4-13

## Z

- Z-display 4-10
- Z-LOWER display 4-10

### What Is Your Opinion of This Manual?

Your comments can help us produce better manuals. Please take a few minutes to evaluate this manual as soon as you become familiar with it. Circle Y (Yes) or N (No) for each question that applies.

#### FINDING INFORMATION

- Y N Is the table of contents helpful?  
What would make it more helpful?  
\_\_\_\_\_
- Y N Is the index complete?  
List specific terms that are missing.  
\_\_\_\_\_
- Y N Are the chapter titles and other headings meaningful?  
What would make them more meaningful?  
\_\_\_\_\_
- Y N Is information organized appropriately?  
What would improve the organization?  
\_\_\_\_\_
- Y N Does the manual refer you to the appropriate places for more information?  
List specific references that are wrong or missing.  
\_\_\_\_\_

#### UNDERSTANDING INFORMATION

- Y N Is the purpose of this manual clear?  
What would make it clearer?  
\_\_\_\_\_
- Y N Is the information explained clearly?  
Which topics are unclear?  
\_\_\_\_\_
- Y N Are the examples clear?  
Which examples are unclear?  
\_\_\_\_\_
- Y N Are examples provided where they are needed?  
Where should examples be added or deleted?  
\_\_\_\_\_
- Y N Are terms defined clearly?  
Which terms are unclear?  
\_\_\_\_\_
- Y N Are terms used consistently?  
Which terms are inconsistent?  
\_\_\_\_\_
- Y N Are too many abbreviations and acronyms used?  
Which ones are not understandable?  
\_\_\_\_\_
- Y N Are the illustrations clear?  
Which ones are unclear?  
\_\_\_\_\_

#### USING INFORMATION

- Y N Does the information apply to your situation?  
Which topics do not apply?  
\_\_\_\_\_
- Y N Is the information accurate?  
What information is inaccurate?  
\_\_\_\_\_
- Y N Is the information complete?  
What information is missing?  
\_\_\_\_\_
- Y N Is only necessary information included?  
What information is unnecessary?  
\_\_\_\_\_
- Y N Are the examples useful models?  
What would make them more useful?  
\_\_\_\_\_
- Y N Is the format of the manual (shape, size, color) effective?  
What would make the format more effective?  
\_\_\_\_\_

#### OTHER COMMENTS

Use the space below for any other opinions about this manual or about the entire set of manuals for this system.

\_\_\_\_\_  
\_\_\_\_\_

#### YOUR BACKGROUND

- What is your job title?  
\_\_\_\_\_
- What is your primary job responsibility?  
\_\_\_\_\_
- How many years have you used computers?  
\_\_\_\_\_
- Which programming languages do you use?  
\_\_\_\_\_
- How many times per month do you use this manual?  
\_\_\_\_\_
- Your name \_\_\_\_\_  
Company name \_\_\_\_\_  
Street address \_\_\_\_\_  
City, State, ZIP \_\_\_\_\_

IBM may use or distribute whatever information you supply in any way it believes appropriate without incurring any obligation to you.

No postage necessary if mailed in the U.S.A.

Cut Along Line

IBM System/36: Source E ( tifty Guide (File No. S36-32) Printed in U.S.A. SC21-7901-2

Fold and tape

Please do not staple

Fold and tape



NO POSTAGE  
NECESSARY IF  
MAILED IN THE  
UNITED STATES

**BUSINESS REPLY MAIL**  
FIRST CLASS      PERMIT NO. 40      ARMONK, N. Y.



POSTAGE WILL BE PAID BY ADDRESSEE:

IBM CORPORATION  
Information Development  
Department 532  
Rochester, Minnesota, U.S.A. 55901

Fold and tape

Please do not staple

Fold and tape





## Source Entry Utility Guide

International Business Machines Corporation

File Number  
S36-32

Order Number  
SC21-7901-2

Printed in U.S.A.

SC21-7901-02

