

The IBM logo consists of the letters "IBM" in a bold, white, sans-serif font, centered within a solid black square.

## **Systems Reference Library**

### **Data Communications Concepts and Communications Facilities**

This publication is an introductory reference describing communications common carriers, coding systems, modulation, channels and communications concepts. Brief descriptions of IBM TELE-PROCESSING units and systems are included. Publications containing related information are listed in the "IBM TELE-PROCESSING Bibliography" (A24-3089-0).

## CONTENTS

INTRODUCTION . . . . .	1	Line Control . . . . .	15
Data Communications and IBM . . . . .	1	Communication Control Systems . . . . .	16
COMMUNICATIONS CONCEPTS . . . . .	2	CODING SYSTEMS . . . . .	17
DATA TRANSMISSION . . . . .	5	Baudot Code . . . . .	17
COMMUNICATIONS CHANNELS . . . . .	6	IBM 1050 Code . . . . .	17
Types of Channels . . . . .	6	American Standard Code for	
Signaling Methods . . . . .	6	Information Interchange . . . . .	17
Frequency Spectrum . . . . .	8	Four of Eight Code . . . . .	17
Carrier Systems . . . . .	8	COMMUNICATIONS FACILITIES . . . . .	18
Modulation . . . . .	8	Communications Common Carriers . . . . .	18
Grades of Channels . . . . .	10	The Federal Communications	
Broad Band Channels . . . . .	11	Commission . . . . .	18
Voice Grade Channels . . . . .	11	State Utility Commissions . . . . .	18
Subvoice Grade Channels . . . . .	12	The International Telecommunications	
Telegraph Grade Channels . . . . .	12	Union . . . . .	18
Line Quality . . . . .	12	The Bell System . . . . .	19
Data Sets . . . . .	13	General Telephone and Electronics	
COMMUNICATIONS SYSTEM		Corporation . . . . .	19
CONTROL . . . . .	14	Independent Telephone Companies . . . . .	20
Message Switching . . . . .	14	Western Union . . . . .	20
Manual Torn-Tape Switching . . . . .	14	American Cable and Radio Corporation . . . . .	20
Semiautomatic Switching . . . . .	14	RCA Communications, Inc. . . . .	21
Automatic Switching . . . . .	14	Privately Owned Communications	
Circuit Switching . . . . .	14	Systems . . . . .	21
Selective Calling and Polling . . . . .	15	A REPRESENTATIVE LIST OF DATA	
		TRANSMISSION TERMS . . . . .	22

## INTRODUCTION

In the complex and vigorous economy of today, management wants the latest facts where and when they are needed. Management wants centralized knowledge of widespread operations, improvements in service to customers, and close surveillance of critical activities in remote areas. These requirements can be summarized as the timely collection, processing and use of information.

Data processing systems, with their powerful logical ability and speed, reduce the volume and variety of information to the facts required for decisions and control. Before this data can be processed, however, it must be gathered from the sources of information. For example, in the petroleum industry, facts and figures must be collected from storage depots, warehouses, refineries, sales offices and other sources. In transportation industries, the drivers, dispatchers, terminal managers, maintenance supervisors and others send information to central offices for processing. Some industrial plants have internal data collection systems with volume and time requirements equivalent to those of an interstate chain of retail department stores.

Every organization with activities in more than one location or complex activities in one location must provide for a system of communications for operation and management control. With the development of data processing systems, it became apparent that existing telephone and telegraph facilities could be used to send data to a central point for processing. Large volumes of detailed information, formerly delayed by distance, weather conditions or traffic, could now be received, processed and acted upon earlier than ever before. This is data communications.

Specific objectives of data communications are:

- To reduce the time, effort and expense required to convert information to a form suitable for entry into a data processing system. This is done by capturing the data at its source.
- To increase the performance of a system by the more rapid movement of information from its source to the processing point.

- To provide accurate and timely reports for management information and decision making.

These three objectives may be realized by using data communications to improve existing systems and to open previously impractical application areas to the advantages of electronic data processing.

This manual is intended to provide some introductory information on data communications. Various communications channels, coding systems, terminals and control techniques are described to provide background material for further study.

## DATA COMMUNICATIONS AND IBM

The relationship of data processing equipment and communications facilities in a data transmission network is not a recent development. In 1940 and 1941, production models of IBM data communications equipment were being used by the U.S. Army Air Corps at Wright Field in an inventory control application. The IBM 057 converted the data on punched cards into punched paper tape, which was used as an input into a teletype network. Receiving stations used the IBM 040 to convert the paper tape output back into punched cards.

IBM's next significant step in data communications was to eliminate the intermediate operations of converting card data to paper tape and back to cards again. The IBM 65 and 66 Data Transceivers provided direct card-to-card transmission over telephone lines. Data communications equipment was developed along with stored program computers, resulting in machines capable of sending and receiving data directly from computer to computer, and in high-speed terminals controlling simultaneous traffic in complex multi-channel networks.

More than twenty years' experience in data communications has resulted in the wide range of IBM products and applications experience available today.

## COMMUNICATIONS CONCEPTS

The history of rapid communications, from smoke signals to satellites, reflects the continual growth in man's ability to convey information beyond the range of the human voice. In less than a hundred years, the electrical communications industry has developed from the first manually keyed telegraph to the first television system. In our time, messages have been sent and received over a million miles of space, and television programs have been transmitted from the United States to Europe by way of a communications satellite.

With all of these technological advances, the basic considerations in a modern communications system are not too different from those in a primitive society using drums or smoke signals to send messages between related villages. Some of the important factors which must be

considered in communications system design are:

1. The purpose of the communications system
2. The number and size of the messages
3. The urgency of the messages
4. The accuracy and cost of the system

The following description of a data communications system serves to introduce some terms and to illustrate the scope of the material covered in succeeding sections.

This example describes a data communications system in a financial institution, such as a commercial bank, savings bank, or savings and loan association. The financial institution has a main office and several branch offices, all handling savings accounts in addition to other activities. The data communications system used is the IBM On-Line Teller System.

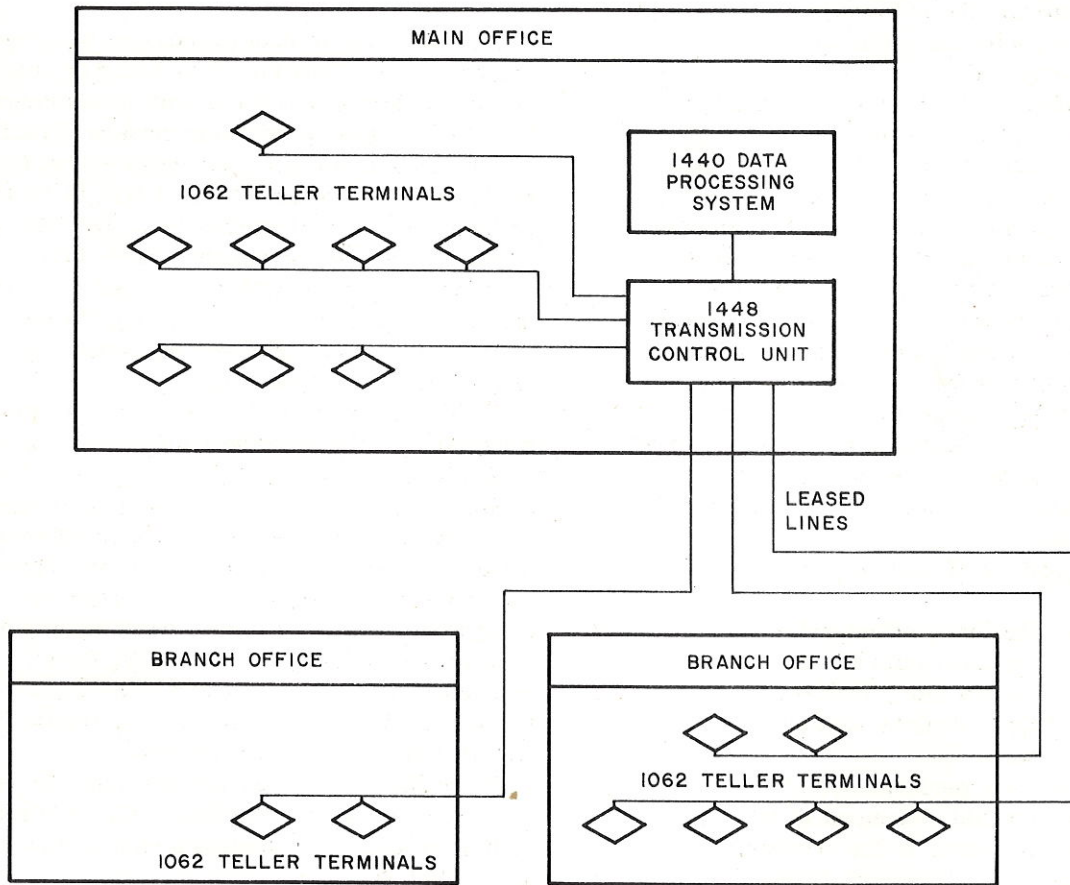

Figure 1. IBM On-Line Teller System network

It provides any teller in the main office or any of the branch offices with immediate access to all savings account records which are centrally located in the main office. The methods and facilities used are similar to those required for a complex cross-continent data communications system or an in-plant data collection system.

Purpose. -- The purpose of the IBM On-Line Teller System is to provide improved customer service, immediate updating of savings records, firm controls and a high degree of accuracy in processing savings accounts and other transactions.

Networks. -- The system consists of a central computer, the IBM 1440 Data Processing System, an IBM 1448 Transmission Control Unit, and IBM 1062 Teller Terminals located in the main office. The branch offices are also equipped with Teller Terminals, connected to the main office equipment over leased telephone lines. Figure 1 illustrates the network connecting two branch offices with the main office.

The three networks shown in Figure 2, arbitrarily indicated as A, B, and C, are the basic building blocks of any network. The circle indicates a terminal that can send messages, receive messages, or both. The connecting lines indicate the communications channel or circuit, which can be wire, cable, radio or microwave. Network "A" is considered a point-to-point network, and can represent, for example, two computers or a card reader and punch connected by a channel. Network "B" illustrates a situation in which two terminals can communicate over the channels only by passing through a third terminal. Network "B" also describes the On-Line Teller System, where two branches communicate with the main office. Network "C" indicates a three-terminal system in which each terminal is able to exchange information with one or both of the others.

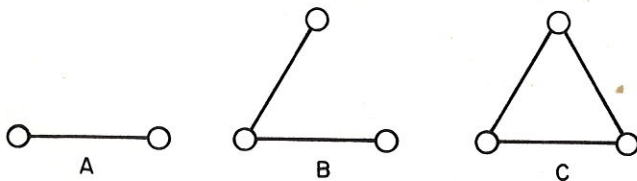

Figure 2. Basic networks

Operation. -- The operation of this system or any other data communications system requires input devices, output devices and mode conversion. In this example, the teller enters the transaction information using the 1062 Teller Terminal, which converts key strokes to coded signals. These signals move over the network to the 1448-1440 system. Within the network, a common code structure of seven parallel bits per character is used by the Teller Terminals and the 1448-1440 system. To make the data processing and communications systems compatible, a signal conversion to serial form and reconversion to parallel form is necessary.

A data communications system usually provides for two types of signals: control signals and text signals. The control signals indicate that a message is about to begin, has just ended, or other control functions. The text signals carry the actual message. In order to insure that the message was received properly, an answer back or acknowledgment signal must be provided by the receiving terminal.

What happens when most of the tellers contend for the attention of the central computer at the same time? This is the contention problem, and can arise in any system where two or more terminals try to use the same circuit at the same time.

Volume. -- The volume requirements of a data communications system include the number and length of the messages. Different message lengths, their origin, direction and destination, and the peak loading times are all factors in message traffic load determination.

The On-Line Teller System was designed to handle a high number of short messages in a small amount of time. Even with many tellers contending for the attention of the central processor, the average delay at each terminal is only a few seconds.

Speed. -- Communications facilities are relatively fast or slow. A wide microwave channel, for example, can carry a much greater amount of information at a higher rate of speed than a single telegraph channel. Other facilities such as telephone circuits are available, providing a wide selection of speeds. The On-Line Teller System uses telephone grade channels adapted for data to carry code signals to and from the central terminal.

Cost. -- The functions of a modern manager are to plan, control and coordinate. These three

functions are affected by the efficiency of a data communications system. The cost of a data communications system must be weighed against the cost of not having the system. What is the net cost of the system? Are the advantages of having current information on markets, machinery, manpower and materials commensurate with the investment in the system? Which configurations are available? Who provides communications channels?

These questions require a study of the proposed network, including the purpose or application, the volume of information to be carried, the required speed, and then the cost.

The following sections present information about the separate and joint functioning of communications channels and data transmission equipment. Detailed information about the cost of the various services and terminals is beyond the scope of this introductory manual.

## DATA TRANSMISSION

Facilities for the transmission of business data, are available and widespread. In order to use the existing telephone and telegraph networks for data transmission, data processing equipment must prepare suitable input for network terminals or be connected to the network. In addition, data processing codes and signals must be converted to signals acceptable to the circuits or channels being used.

The data flow in the system as illustrated in Figure 3 starts with input media such as punched cards, a keyboard, punched paper tape or magnetic tape. The information enters the system through an input device such as a card reader, and from there it goes to a terminal and data set before actually entering the communications channel. The point at which the data processing and communications equipment connect is called the interface.

The data set or modulator is basically a signal conversion device. The change or conversion may require changes in mode, format, speed and code structure as well as the insertion or deletion of control characters. The terminal changes the data to a form acceptable to the modulator. The modulator converts the signals to the form used

by the circuit or channel. At the receiving station, a similar interface with a demodulator and terminal reconverts the signals to a form acceptable to data processing equipment and an output device such as a card punch.

Figure 3 illustrates a data transmission system and one method of signal conversion used in a telephone circuit. The components are:

Input equipment:	An IBM 1401 system
Terminal:	An IBM 1009 Data Transmission Unit
Modulator:	A common carrier company data set
Circuit or channel:	A communications line
Demodulator:	A common carrier company data set
Terminal:	An IBM 1009 Data Transmission Unit
Output equipment:	An IBM 1401 system

Note that the IBM 1009 is both a receiver and a transmitter, and that its function is code conversion. Each character sent from one 1401 to another over this network is changed in mode from a parallel bit configuration to serial form, and changed back at the receiving terminal.

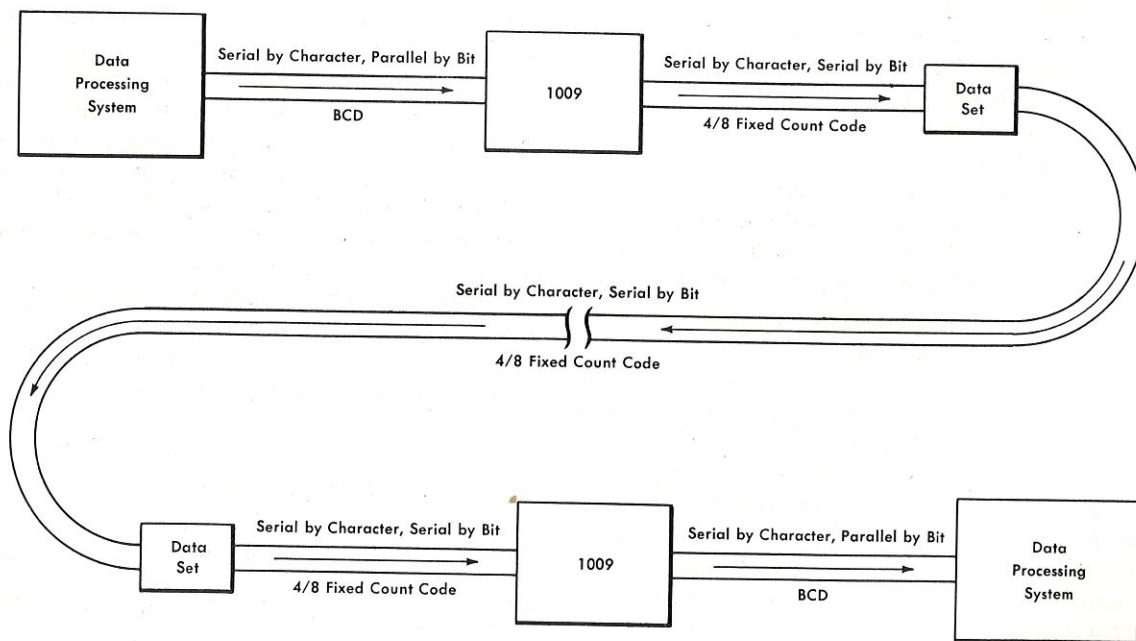

Figure 3. Data transmission system

## COMMUNICATIONS CHANNELS

A channel or circuit is a path for electrical transmission between two or more terminals. The channel may be a group of wires or a special part of the radio frequency spectrum. The purpose of the channel is to carry information from one point to another. Circuit is used conversationally as a synonym for channel, but technically a circuit can contain several communications channels.

### TYPES OF CHANNELS

The three basic channel types are called simplex, half-duplex and duplex. A simplex circuit, like a one way street or a doorbell, can carry information (either textual data or control signals) in one direction. It is simplex in most cases because of the type of sending and receiving units used. A half-duplex circuit can carry information in either direction, but only in one direction at a time. A duplex circuit, also known as a full-duplex circuit, can carry information in both directions at the same time. A network can consist of any combination of these, according to the application requirements. In a half-duplex telephone circuit, reversing the flow of data requires a certain amount of time known as "turn-around time", nominally 200 milliseconds. In preliminary planning for a network, consideration must be given to the time required for answerback signals that can occur before, during and after each message as a response from the receiving station indicating that it is ready to receive, or that the last block of data was received correctly. In some instances the time required for the answerback can affect the throughput of data transmission.

Simplex, half-duplex and duplex circuits are types of circuits. The names indicate only the directional capability of the channel. The grades of channels are broad band, voice grade, sub-voice grade and telegraph. Circuits are graded on their basic line speed, expressed in characters per second, bits per second, or words per minute. Since these different grades of circuits use different types of signaling, an understanding of code structure is necessary to evaluate their potential. The following section introduces some of the more common codes and signaling techniques now in use.

### SIGNALING METHODS

Morse or International code is made up of dots and dashes. The widely known letter "V", for example, consists of three dots and a dash. Although the parts of this code are written as dots and dashes, the actual transmission consists of long and short signals with pauses between characters. The use of long and short signals, intermixed with pauses, indicates that time is an element of transmission. Figure 4 shows that these signals are sent serially, or one after another, and that between the pauses, the presence or absence of a signal indicates the character configuration. Since this code was developed for manual telegraph signaling, the experienced operator could differentiate between letters because of the length of the "no signal" or pause condition.

Early mechanized telegraph equipment could not handle Morse code since the characters varied in length between pauses. A five-bit code, Baudot code, named after its inventor, was developed and is still used today.

Some telegraph implementations of Baudot code require about 7.42 bits or units of time per character, although only five are used to carry information. A "bit" in this instance, is the fixed unit of time in which a signal is present or absent. One bit is used as a start signal, and 1.42 bits as a stop signal, replacing the pause used between letters in Morse code. The stop signal, shown in this example as 1.42 bit times, can be as small as one bit, or larger than the 1.42 bits, according to the design of the receiving terminal.

The presence of a bit or signal on a line is called a "mark". The absence of a bit or signal is called a space. The Baudot code characters, then, consist of marks and spaces. The start bit, corresponding to the pause between characters in Morse code, is always a space. The long stop bit is always a mark, and the line is in a mark condition when not being used.

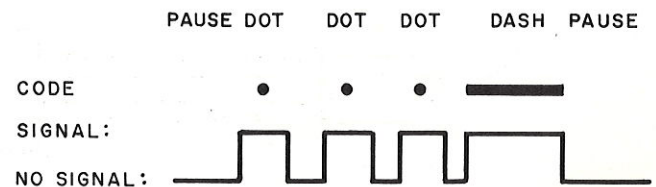

Figure 4. Morse code transmission of letter "V"



The early electromechanical telegraph sending unit used to transmit Baudot code was attached to a three-row keyboard resembling that of a typewriter. Five contacts, one for each bit in the code, were arranged in a circle. Each time a key was depressed, certain of the five contacts were activated, tested by a rotary wiper arm, then reset. Figure 5 illustrates this type of serial start-stop signal generation. For example, the letter "A", when depressed, would activate only the first and second contacts of the five. As the rotary wiper started testing the five contacts, it would send an automatic "no signal", or space, indicating the start of a character, then marks from the first two contacts, spaces from the remaining three, and finally a long mark for "end of character" or stop signal. The contacts were then reset for the next character to be sent. The receiving terminal had a similar rotary device timed to detect the marks and spaces.

Conceivably, if the sending and receiving terminals were controlled by the same timing pulse, the start and stop bits could be eliminated. Characters would be detected on the basis of

every five bit times. For example, the serial start-stop Baudot code would require 7.42 units of time for each character of 7.42 bits. Without start-stop bits, the character would only require five units of time for the five intelligence bits. Transmission without start and stop signals is termed "synchronous". In synchronous signaling, a special pattern of bits is sent periodically to keep the terminals in unison. These are automatically generated and sent as required by the system.

In addition to the serial start-stop and synchronous serial methods of transmission, Figure 5 shows how the same characters can be sent over five channels at the same time, allowing one channel for each bit in the code structure. This is called parallel transmission.

In summary, a network may include simplex, half-duplex or duplex channels. The transmission mode may be either start-stop serial, synchronous serial, or parallel. Within the circuit or channel, the code structure may be indicated by the presence or absence of a signal, or by changes in the signal itself.

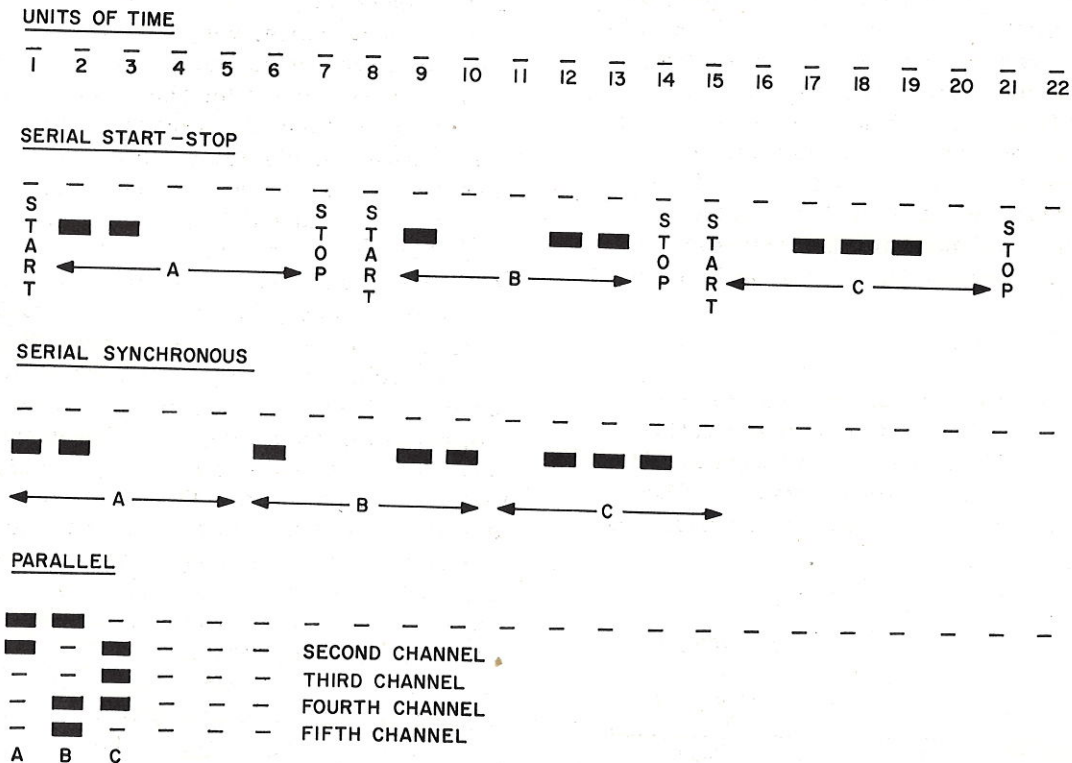

Figure 5. Transmission modes

## FREQUENCY SPECTRUM

The basic transmission technique in telegraphy is the use of a key, switch or rotor to periodically interrupt a flow of direct current (D. C.). Various other methods were developed which are more suitable for transmission over long distances.

Figure 6 contains the normal schematic representation of an electromagnetic wave. Radio waves, electromagnetic waves in a wire conductor, and sound waves, share the common characteristic of oscillating perpendicular to the direction of movement of the wave. In Figure 6, the perpendicular oscillation is shown three times. The extent of the oscillation represents the relative energy level, and is called the amplitude. Each complete oscillation is called a cycle. Figure 6 indicates three complete cycles. Ordinary electric power used in the home is usually 120 volts, 60 cycles. This means that the amplitude or maximum energy level is 120 volts, occurring 60 times each second.

The number of cycles per second is referred to as the frequency, and is expressed in cycles, kilocycles (thousands of cycles per second) and megacycles (millions of cycles per second). The frequency of electricity used in most homes, as previously mentioned, is 60 cycles. Radio broadcasting stations are identified by the frequency used, such as 970 kilocycles (AM), or 96.2 megacycles (FM). The overall frequency spectrum for electrical communications ranges up to 4 million kilocycles. Different parts of the frequency spectrum are used for different types of communications because the characteristics and behavior of the signals change with the frequency.

## CARRIER SYSTEMS

The low cost of communications today has been made possible by the efforts of communications engineers to use the frequency spectrum to full advantage by employing carrier systems. These systems permit many conversations or messages on a single circuit.

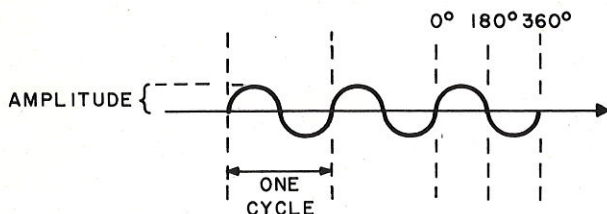

Figure 6.

Human voices have a frequency range of approximately 50 to 16,000 cycles per second. If the modern telephone system were limited to this frequency range, very few conversations per channel would be possible at any one time, and the cost per call would be high. Communications engineers found that a frequency range or band approximately three kilocycles wide is sufficient to retain most of the individual characteristics of the human voice during transmission. Since many telephone circuits have a range of 150 kilocycles, 50 voice channels are theoretically possible. The problem, of course, was to devise a method of carrying voice signals at different frequencies on the same line. This required considerable engineering effort, and involved assigning 3-kilocycle bands for voice signals or messages at different frequencies, raising the messages to the proper frequency, and separating or filtering them out at the receiving terminal.

## MODULATION

As an illustration of one modulation technique used on a carrier system, consider an imaginary one-wire communication channel capable of carrying frequencies from 10,000 to 30,000 cycles per second.

The human voice, with a range of from 50 to 16,000 cycles per second, is used to modify a flow of current in the telephone handset. The electrical image of the voice produced by the handset uses only the range of 200 to 3,200 cycles per second. This analog or electrical representation enters a modulator, along with a "carrier" signal equivalent to a carrier frequency. In this example, illustrated in Figure 8, carrier "B", produced by an oscillator, has a constant frequency of 15,000 cycles per second. The output of the modulator consists of the 15,000-cycle carrier "B" signal, an upper sideband of from 15,000 to 18,000 cycles, and a lower sideband of from 12,000 to 15,000 cycles. The upper and lower sidebands contain the same wave form or signal, and either can be used for the actual transmission. At this point filters are used to eliminate or suppress the carrier and, in this example, the lower sideband. The upper sideband alone, with a frequency of 15,000 to 18,000 cycles per second, a direct analog of the original voice signal, is routed to the telephone wires or cables.

At the receiving terminal, the voice signal enters a demodulator and filter. The recovered voice signals, reduced from the 15,000 to 18,000 cycles per second to the audible level of 200 to 3,200 cycles per second, are forwarded to the receiving telephone handset.

The modulators and demodulators, along with the fixed carrier frequencies, act to raise and lower the voice frequency level. By using different oscillators generating different carrier frequencies, the same technique can be used for bands A, C and D in Figure 7 to provide four simplex voice channels on a single wire. Band B shows the upper sideband of three kilocycles as previously described.

In a more complex carrier system, the upper sideband on the channel illustrated in Figures 7 and 8 could again be modulated and shifted to another frequency.

The three-kilocycle band used in the preceding illustration can be further subdivided into bands of 150 to 200 cycles each. These would not be wide enough for the human voice, but could be used for the transmission of information in code.

For data transmission, a code structure based on the presence or absence of a bit or signal can

be indicated by changes in the wave form of the sideband frequency transmitted. Figure 9 illustrates some modulation methods, and shows the relationship between the binary coded data, the presence or absence of a signal, and representations of the various wave forms produced for serial transmission. The binary coded data is indicated by a "one" or a "zero", corresponding to the bit configuration. The second line indicates telegraphic marks and spaces.

The example of amplitude modulation indicates a drop in the amplitude for a "no bit" condition. Frequency modulation changes the frequency of occurrence of the cycles to indicate a "no bit" condition in the example given. Phase modulation is not limited to the illustrated 180-degree change, but may be accomplished by a 90-degree or other phase change according to the design of the terminals and the quality of the channel.

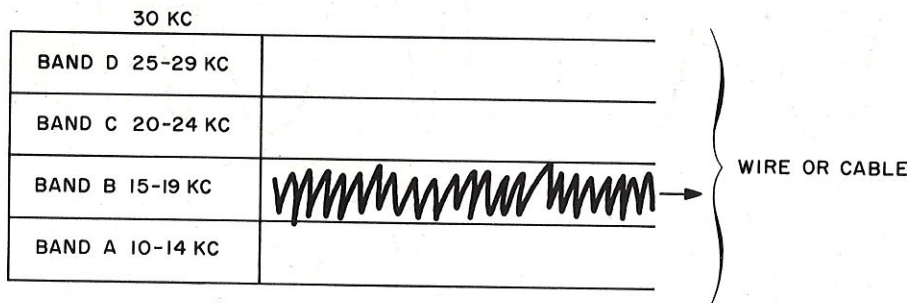

Figure 7. Example of carrier channels

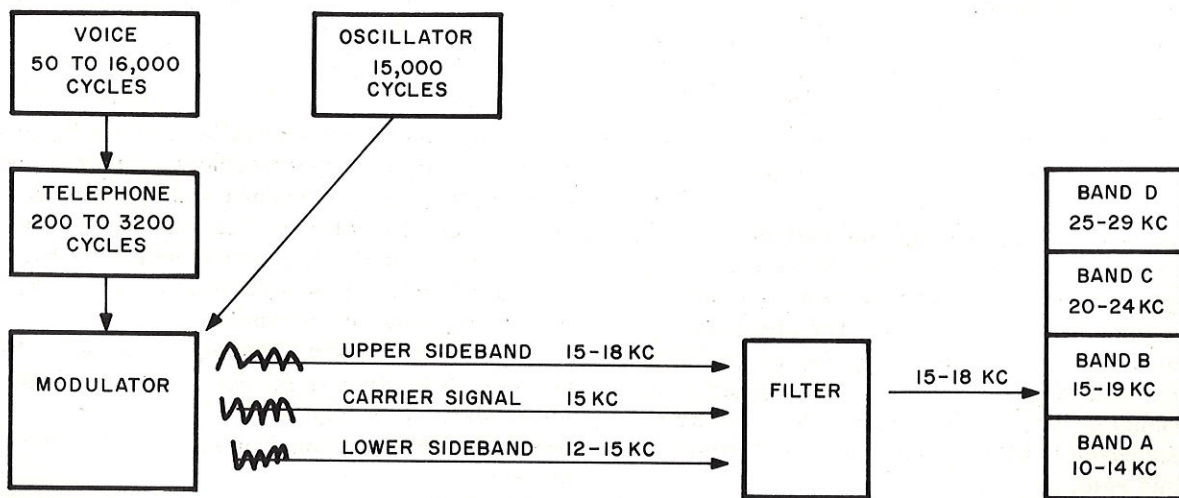

Figure 8. Modulation and filtering

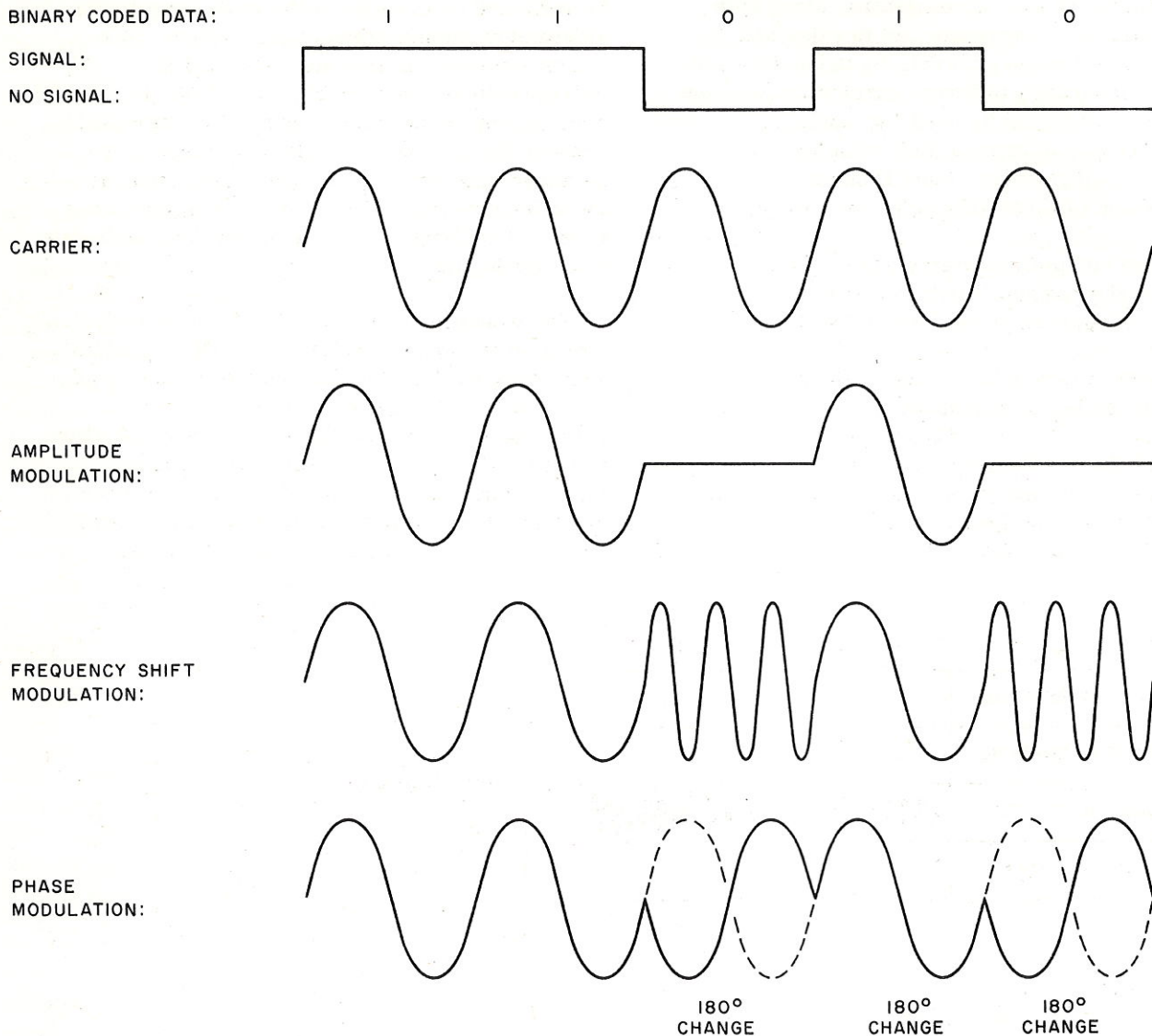

Figure 9. Modulation techniques

### GRADES OF CHANNELS

The agreement between the communications common carrier and the subscriber is basically an arrangement for the use of a certain type and grade of communications channel. The channels are classified by type, such as half-duplex or full duplex, and by grade, such as the capacity of the channel to carry information. The capacity can be expressed in bits per second or a similar signal-time rate.

The physical circuit or technique used, whether a voice frequency circuit, a wire carrier channel, or a portion of a microwave band,

depends on the facilities available in each geographic location. The subscriber, for example, is not necessarily concerned with the fact that a voice grade channel uses a carrier frequency of 15 kilocycles or 500 kilocycles, but only that the available bandwidth is capable of carrying the required volume of information.

The line speed of a channel, measured in bits per second is directly related to the bandwidth of the channel. A high bit per second rate requires a wider channel or more cycles per second.

The communications carriers have found that, from a practical point of view considering cost and performance, the bandwidth should be about

twice as wide as the number of bits per second passing through the channel. A rate of 2,000 bits per second, for example, would require a bandwidth of about 4,000 cycles, as contained in a frequency range of 200 to 4,200 cycles per second. Technological advances, however, have made it possible to pass 2,000 bits per second over a three-kilocycle bandwidth.

The grades of channels described below are broad band, voice, subvoice and telegraph. These grades do not imply strict limitations, but are general categories of high-, medium-, and low-speed facilities that are specifically described in tariffs filed with the Federal Communications Commission or equivalent state commissions.

### Broad Band Channels

Microwave or radio relay communications systems use the superhigh frequencies above 4 million kilocycles per second. The radio waves at this frequency level tend to travel in a straight line, requiring repeater stations with a dishlike antenna on high buildings or towers every 20 to 35 miles. Carrier, modulation and channelizing techniques are used. The speed of transmission is limited only by the bandwidth available and the terminals used.

Some idea of the cost of a broad band channel can be gained by noting that one type of channel capable of carrying 5,100 characters per second costs about \$15 per mile per month.

The IBM 7710 Data Communication Unit provides point-to-point communication over a broad band channel. It permits transmission between two IBM 1401 Data Processing Systems of 5,100 characters per second. Although the 7710 would normally be justified for broad band transmission, it can be operated with a voice grade channel as a secondary use. The 7710 is compatible with the IBM 1009 Data Transmission Unit, the IBM 1013 Card Transmission Terminal, and the IBM 7702 Magnetic Tape Transmission Terminal.

### Voice Grade Channels

Voice grade channels have a range or bandwidth of approximately 3,000 cycles per second. When used for voice communication, the channel can carry one conversation. In data communications a line speed of approximately 2,400 effective bits per second is available. Considerably higher speeds are possible, but are dependent on the commercial availability of suitable channels and terminal equipment.

The common carrier can channelize a voice grade line into smaller bands of 150 to 200 cycles, each suitable for subvoice or telegraph communication.

The cost of a leased voice grade line used for data is determined by the length and type of channel. Dialed calls for data transmission are usually charged for at the same rate as ordinary voice telephone calls. A telephone and data set is required at each terminal. A telephone connection is established between two terminals either by direct dialing or through an operator. Each terminal attendant then presses a data key on his telephone to connect the data set to the line and disconnect the telephone. Pressing the key establishes a direct line for data transmission between the two terminals and prevents normal use of the telephone.

The IBM 1001 Data Transmission System transmits numeric or alphameric information from remote locations over voice grade channels to a centrally located card punch. Input can be from punched cards, a keyboard, or both. Each terminal unit must be equipped with a transmitting or receiving data set supplied by the telephone company and a telephone to establish the connection for data transmission. The components of the system are the 1001 Data Transmission Terminal and a modified IBM 24 Card Punch or 26 Printing Card Punch. Transmission is at the maximum rate of twelve columns per second. Features include parity checking and record length checking. A self-checking numbering device is available as a special feature on the card punch. The 1001 transmits over ordinary dial lines at a low rate of speed. Because it is not expensive, the 1001 can be used in a large number of locations which could not otherwise justify data transmission equipment.

The IBM 1013 Card Transmission Terminal is a higher performance terminal for card transmission over voice grade lines. This terminal can communicate with another IBM 1013, an IBM 7702, IBM 7710 or IBM 1009, provided both terminals are operated at the same speed over a suitable channel. The maximum punching speed is 160 columns per second. If a 1013 is reading cards and transmitting to a magnetic tape unit or multiplexor, the channel rate of 150, 250 or 300 characters per second would be the limiting factor.

The IBM 1009 Data Transmission Unit is another unit for transmission on voice grade lines. This unit permits high-speed two-way communications between two IBM 1401, 1440, 1460 or 1410 Data Processing Systems. A 7702 or 1013 Magnetic Tape Transmission Terminal can be used in place of one of the 1401-1009 or

1410-1009 configurations. The IBM 1009 unit controls the movement of data from the storage area of one system to another system over toll or leased lines. Data is transmitted and received at rates ranging from 75 to 300 characters per second.

The IBM 7702 Magnetic Tape Transmission Terminal is used for transmitting and receiving magnetic tape data over voice grade channels. Communication can take place with a similarly equipped IBM 7702, 1009, 1013, 7710, 7740, or 7750. A data set supplied by the communications company is required at each terminal. The IBM 7702 operates at 150, 250 or 300 characters per second.

#### Subvoice Grade Channels

These circuits have a lower speed than voice grade channels. Although there are no specific limits, subvoice grade channels are usually considered to be those within the range of 150 to 600 bits per second. The following systems use subvoice grade channels.

The IBM 1030 Data Collection System has a transmission rate of 60 characters per second. It is a multi-application data collection system that provides two-way communications between a centralized IBM 1440 or 1460 Data Processing System and remote locations in a plant, using an IBM 1448 Transmission Control Unit. With the appropriate adapter, the system can be linked to a 1410 or 7010 system.

The input/output devices include a card punch, a page printer, an input station that will accept prepunched cards, manual entry, badges, or special data cartridges. Printing is at the rate of 14.8 characters per second. Punching speed of transmitted information is 60 characters per second. Modular design permits considerable flexibility in systems design, network size, distance to remote locations and adaptability to existing wiring.

The IBM 1050 Data Communication System is a general purpose data terminal for online transmission or offline preparation of data at rates of up to 14.8 characters per second. Input and output devices include the 1052 Printer-Keyboard, the 1053 Printer, the 1054 Paper Tape Reader and the 1055 Card Punch, all controlled through the 1051 Control Unit. Each terminal can communicate with another 1050 system, an IBM 1440, 1401, 1410, 1460, 7010 or any other 7000 series data processing system (except the 7072) with the appropriate control units and adapters.

The IBM 1060 Data Communication System is designed to meet the requirements of banking and savings and loan applications. Transmission is at the rate of 14.8 characters per second. The basic system consists of a control unit and Teller Terminals, which may be used online with an IBM 1440 Data Processing System equipped with a 1448 Transmission Control Unit. Transmitted data is recorded on a terminal record tape and a passbook or other document as required.

#### Telegraph Grade Channels

These circuits have line speeds in the range of approximately 45 to 75 bits per second. Information is transmitted serially. Historically, the telegraph was the first effective means of cross-country electrical communications. One of the characteristics of early telegraph lines was the use of regenerative repeater stations along the circuit. These repeaters were necessary because of signal weakening or distortion over long distances. This device samples the weak distorted signals, and generates a completely new undistorted signal to forward along the line. Regenerative repeaters are code-sensitive, and may restrict transmission to the code for which the repeater was designed.

The IBM 65 and 66 Data Transceivers are units which are used in conjunction with an IBM signal unit to provide a method of sending and receiving punched card data over voice grade and telegraph grade circuits. Depending on the circuit used, each transceiver can send or receive up to 11 fully punched cards per minute. Both the 65 and 66 are modified card punches capable of automatic operation under the control of a program card drum.

#### LINE QUALITY

A technical discussion of line quality would include such terms as resistance, impedance, conductance and attenuation. In this introductory material, however, only a few of the communications engineering accomplishments are described to illustrate some of the techniques used to provide faster and more accurate communications.

Theoretically, electrical communications can proceed at the speed of light. In practice, wires and cables have characteristics that tend to reduce this speed to some extent. Some of the factors that influence the efficiency of long-distance wires and cables are the distance involved, the ability of the copper or aluminum wire to carry the signal,

interference from other circuits, and their electrical characteristics which cause distortion or loss of signals.

Prior to the development of vacuum tubes and amplifiers, the maximum length of a telephone line was limited to a relatively short distance. Amplifiers increased the signal strength and the useful length of the line, but required additional technical development to prevent an extraneous "singing" tone and to eliminate interference between circuits.

Another problem unique to long-distance voice lines was a succession of echoes of diminishing volume that was disturbing to the person speaking. An echo suppressor was developed to prevent signals from echoing to the person talking. The echo suppressor takes effect just after speaking starts and drops out after speaking stops. The very slight delay is not noticeable in a conversation, yet eliminates the echo problem. The time required for the echo suppressor to drop out is known as "drop-out" time, or "turn-around" time, and must be taken into consideration when using a voice grade line for data transmission.

Compressors are devices specifically designed to compress the volume range of the human voice for economical transmission and to expand the signals at the receiving end. Effectively, soft sounds are amplified and loud sounds attenuated. The procedure is reversed at the receiving end. The common carrier normally removes compressors from circuits used for data transmission.

It is possible for a common carrier to provide lines of especially high quality, at additional cost. These specially conditioned lines permit data transmission at lower error rates or higher rates of speed than would otherwise be possible. One disadvantage of these conditioned lines is that alternate routes may not be readily available, should they be required.

## DATA SETS

Data sets, also known as "subsets" and "modems" (a contraction of modulator-demodulator), are designed to provide the necessary compatibility between data processing equipment and communications facilities. Data sets are used at each termination of the communications channel at the interface with the data processing equipment. Their basic function is modulation and demodulation for data transmission.

The following is an introductory examination of a typical data set. The characteristics are underlined, with explanatory comments and notes where required.

## EQUIPMENT: Transmitter-Receiver

This does not imply a set that is an original input or final output device, but one that functions as both a modulator and a demodulator. One is required at each terminal in a network.

## TRANSMISSION: Serial

## INPUT-OUTPUT: Binary. Conforms to EIA RS-232

This indicates that a binary code representation meeting the current recommended standards of the Electronics Industries Association must be used by the data processing equipment with the appropriate hardware adapter.

## MODULATION: FM

Frequency modulation is used.

## BIT RATE: 150 to 1200 BPS

This is the bit-per-second range of the data set.

## SYNCHRONIZATION: None provided by the data set

Synchronization is sometimes referred to as "synch" or "clocking". The clock is not a simple mechanical or electromechanical device, but an electronic component that provides a constant pulse rate. The clock is used by the receiver to control the sampling of the received data, and to keep in step with the data flow.

## OPERATION: 2-wire half-duplex

This indicates that the data set and channel can carry information in both directions, but not at the same time.

## UNATTENDED ANSWER: Yes

This indicates that an incoming call can be connected without human intervention.

## POWER: 105-120 volts, approximately 7.5 watts

## SIZE: 11 inches wide, 5-1/2 inches high, 14-1/2 inches deep

## REMARKS: A telephone handset is included

NOTES: This data set can be used with the IBM 1009, 1013, 7701, 7702 and 7710.

## COMMUNICATIONS SYSTEM CONTROL

The requirements for the control of a communications system are illustrated by the network diagram in Figure 10. The control terminal may or may not be adjacent to the central data processing system. The circles numbered two through eight indicate terminals on the network. This diagram will be used to review message switching, circuit switching, selective calling, polling, line control and a complete communications control system.

### MESSAGE SWITCHING

Message switching is used in a leased telegraph wire system with multiple circuits to transfer messages from one circuit to another. In Figure 10, a message from terminal 4 to terminal 6 would pass through the communications center and be switched to the circuit connected to terminal 6. In a message switching system, the entire message is received at the communications center and retransmitted along the appropriate circuit. This method, called "store and forward", requires receipt of messages in the form of perforated paper tape at the communications center. The methods described here are manual torn tape, semiautomatic pushbutton, and fully automatic switching.

#### Manual Torn-Tape Switching

In a leased line system employing manual torn-tape switching, a station wishing to send a message or data to any other station in the network will transmit the message to the communications center with the appropriate message origin and destination codes. The communications center receives the message in perforated paper tape form. An operator manually tears the message off the receiving console and transfers it to a tape storage rack. Sending operators interpret the destination codes and manually insert this

same tape in the proper outgoing transmitter connected to the circuit, and the message is directed to its final destination.

#### Semiautomatic Switching

A leased line system employing semiautomatic switching is a continuous, rather than a torn-tape operation. An abbreviation of the destination city in the heading of the message is all that is required for an operator to send a message to another station. Upon receipt of a message at the communications center, the operator in the switching aisle reads the destination station abbreviated on the perforated paper tape, depresses a pushbutton corresponding to the desired destination station, and the message is forwarded. At the end of each message, the transmitter stops automatically and signals the operator so that another message can be switched.

#### Automatic Switching

Several sizes and types of fully automatic switching systems are commercially available today. A private wire system of this type places a greater responsibility upon the operator at the originating station, in that a precise message heading and ending format must be used. The switching is executed on a fully automatic basis. The sequence of codes, entered by the originating operator, instructs the communications center as to the proper destination. In essence, the message is received in the communications center in perforated paper tape form. The tape feeds automatically from the tape punch, up over the sensing pins of the tape reader, which interprets the codes designating the destination station, checks these codes against a directory, establishes the proper circuit connection, and assigns the message to an outgoing line.

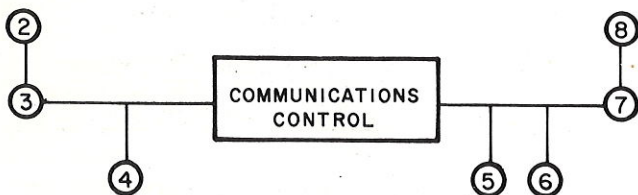

Figure 10. Communications network

### CIRCUIT SWITCHING

Circuit or line switching, as opposed to message switching, does not require the receipt and retransmission of messages. The communications center provides a connection between the terminals. The actual switching may be done by an operator or through the use of dial equipment. The dial telephone system is an example of circuit switching.



## SELECTIVE CALLING AND POLLING

When two or more terminals are operating on the same channel, all stations will receive all messages and data, whether meant for them or not, unless something is done to prevent this. Conversely, if all points are trying to transmit, there will be contention for the circuit. The first problem is solved through the use of a selective calling system, the second by a polling service. These systems, which vary in design and complexity, insure that only the proper station receives the message. One such system is designed so that when the sending (calling) station precedes its message with a two-character code, only the machine assigned that code is set up to receive. In this way, the selecting device prevents stations on a multi-station line from getting unwanted traffic.

One system used for solving the contention problem (several stations trying to send at the same time) incorporates a device which will automatically permit each station to send in turn. This is known as an automatic polling device. With this device, the communications center sends a code to start the first station. If the station has a message ready, transmission is begun. If there is none, the communications center sends a code to test the next station. Each station in the network is checked in this manner. Polling may be on either a sequential or a priority basis. In sequential polling, the communications center tests the transmitters in sequence. After the last station has been polled, the cycle is started again. The polling sequence can be modified to interrogate active stations more often than others.

## LINE CONTROL

Polling and selective calling systems use certain signals and procedures to insure the orderly and efficient use of the data transmission system. This is line control. Systems require different types of controls, depending on the complexity of the network and the volume and type of traffic. This survey of line control is not definitive, nor is it oriented towards any particular system; it serves to introduce some factors to be considered in designing or understanding the operation of a data transmission network.

In forwarding data from one terminal to another, the receiving terminal must be tested to determine whether it is ready to accept a message. If the receiving terminal is ready, the data is forwarded along with checking signals. During transmission, the receiving station signals whether or

not the data is being received properly. At the end of the message, the circuit must be left clear for other traffic. Performing these functions involves addressing, terminal status, text signals and error control.

Addressing. -- A transmission or message consists of the addressing portion in control mode and the data in text mode. A mode change character is used to differentiate between them. The addressing portion is used to direct the message to one or more terminals, and in some instances to a specific component such as a page printer or card punch linked to the terminal.

Status. -- Addressing is done in control mode. The terminals addressed respond in the same mode and indicate their status. The addressed terminal can signal that it is ready to receive, ready to send, not ready to receive, not ready to send, or it may not respond at all. If the power is not turned on at a terminal or the terminal is otherwise unable to respond, the sending station does not receive an answer, and starts a "time out" or waiting period. Depending on the system, this delay can be one second to two minutes long. The time out in polling is usually very short to prevent blocking traffic. In the middle of a transmission, however, the waiting period would be longer to permit the terminal attendant to overcome the cause of the delay by such actions as clearing a card jam or replenishing the forms in a printer.

Text. -- Text signals are classified as data transmission characters and text "answerback" signals. The data characters from the sending terminal are used to convey the data, and include end-of-message signals, end-of-block signals, and characters for redundancy checks. The text answerback signals from the receiving station include positive and negative signals indicating whether or not the preceding message or block of data was received properly. If an answerback is not received, a time-out delay is initiated.

Error control. -- In some systems, a longitudinal redundancy character (LRC) is sent after each block of information. This is checked by the receiving station and the appropriate answerback signals, indicating correct or incorrect receipt, are returned. An incorrect transmission signal can be used to initiate the retransmittal of a block of data from the sending terminal.

## COMMUNICATION CONTROL SYSTEMS

The previously described functions of switching, selective calling and polling can be performed by a communication control system such as the IBM 1448 or the IBM 7740.

The 1448 Transmission Control Unit is used to control data transfers between 1062 Teller Terminals, 1030 or 1050 systems components and an IBM 1440 or 1460 system. Communication can go over private or leased telephone, subvoice lines, or 150-bit-per-second TWX.

The IBM 7740 Communication Control System can be used as an independent message control processor, or in conjunction with a 1410 or 7000

series computer. The system can provide complete message control for a network. In addition to switching, polling and selective calling, the system provides for editing, code conversion, speed conversion, sequence numbering of messages, logging and other related functions. As many as 84 half-duplex channels in the low-speed range of 200 bits per second or four high-speed channels of up to 2,400 bits per second can be accommodated. The 7740 is a stored program unit that transfers data to and from the input/output channels of a system at rates of up to 70,000 characters per second while distributing and assembling messages to and from the multiple lines of a communications network.

## CODING SYSTEMS

The line speeds of communications channels are usually expressed in bits per second, characters per second, or words per minute. In order to compare line speeds, these expressions must be reduced to a common form such as bits per second. This requires a knowledge of the number of bits in a character for common codes, and the meaning of a "word". A word is considered to be six characters in length, usually five letters and a space. The following simple formula can be used for conversion:

$$\frac{\text{Words per minute} \times \text{Characters per word (6)} \times \text{Bits per character}}{60 \text{ seconds}} = \text{Bits per second}$$

### Baudot Code

The Baudot code, described earlier, is widely used for teletype transmission. The five intelligence bit positions per character are used to represent 32 characters. When these are combined with the "figures-letters" shift signal, 58 usable characters are available. Since there are no invalid characters in Baudot code, the systems design must include procedures to check transmitted information.

### IBM 1050 Code

The code used in the IBM 1050 system has a six-bit binary coded decimal structure with an odd parity check bit. The bits are denoted as C, B, A, 8, 4, 2, 1, and correspond closely to the internal

self-checking code of many IBM data processing systems. The code transmission is further checked by a longitudinal redundancy character that can follow each card, line or block of information sent over the network.

### American Standard Code for Information Interchange

This code, approved by the American Standards Association (ASA), is a seven-bit code that provides 128 possible characters. The basic purpose of this code is to achieve uniformity in the general interchange of information among data processing systems, communications systems, and associated equipment. The implementation of this recently adopted code, known as ASCII, will provide many advantages in data communications.

### Four of Eight Code

This code provides an extremely reliable two-way check of character transmission. The longitudinal check bit following each block is supplemented by the requirement that each character consisting of eight bit positions must contain no more nor less than four bits. This code is used in the IBM 1009, 1013, 7702 and 7710 systems.

The IBM 7740 Communication Control System is designed to accept or transmit any of these codes, and to convert from any one of these codes to any of the others. With this type of equipment, the user need not be concerned about possible code differences among the various data transmission terminals used in any one network.

## COMMUNICATIONS FACILITIES

### COMMUNICATIONS COMMON CARRIERS

Communications common carriers are companies which furnish communications services to the public. They are regulated by the Federal Communications Commission or appropriate state agencies. Their services include communications facilities for voice, data, facsimile and printed messages, as well as appropriate communications channels for television, telemetry and telephoto. In the United States approximately 2,800 companies are recognized as communications common carriers. These companies can provide complete communications services to the subscriber including channels, modulating equipment, and the necessary terminating arrangements. Alternatively, the customer may lease only the channels and provide purchased or leased terminal equipment for data communications.

The services mentioned in this section are presented as a survey of some of the communications facilities available today. The representatives of the communications companies should be consulted in order to obtain current information on rates, availability of service, billing arrangements, channels and related devices pertinent to data transmission.

### THE FEDERAL COMMUNICATIONS COMMISSION

The Federal Communications Commission, an independent federal agency, regulates interstate and international communications originating in the United States, such as radio, telephone, telegraph, facsimile, telephoto and other broadcast program transmissions by wire, cable or radio.

The Communications Act, establishing the Federal Communications Commission, requires that every subject common carrier furnish service at reasonable charges upon reasonable request. No carrier may construct, acquire or operate interstate or foreign facilities originating in the United States without the approval of the commission.

Under the provisions of the Communications Act every common carrier must file with the commission schedules showing all charges, practices, classifications and regulations for interstate communications services offered to the public. These schedules, known as tariffs, are

normally filed at least 30 days before their terms become effective. The tariffs form a significant part of the machinery by which the commission enforces the duties and prohibitions imposed on the common carriers for the benefit of the public. They are also the basic contract between the common carrier and the user. Telephone and telegraph companies are not required to file tariffs of their own if they concur in the tariffs filed by other common carriers. Due to local conditions, however, tariffs may vary from company to company.

One example of a tariff with a high degree of concurrence among a large number of telephone companies is tariff #245 filed with the Federal Communications Commission by the American Telephone and Telegraph Company. This tariff covers the V-H Measuring Plan. It establishes the basis for determining the cost of a telephone call by providing a uniform means of calculating the distance between the calling station and the receiving station. In the V-H Measuring Plan, each area in the United States and Canada is assigned a mathematical coordinate on a vertical (V) and a horizontal (H) basis. This divides the entire area into a series of small squares, each having an equivalent of latitude and longitude. The distance for billing purposes in airline miles between any two points can then be calculated from these coordinates.

### STATE UTILITY COMMISSIONS

Intrastate common carrier communications service is subject to regulation by state commissions similar in function to the Federal Communications Commission.

### INTERNATIONAL TELECOMMUNICATIONS UNION

The International Telecommunications Union is an administrative international organization responsible for the allocation, registration and utilization of the radio frequency spectrum. The main objective of the union is to maintain and develop international cooperation for the improvement and rational use of communications. The union undertakes studies and issues recommendations for the benefit of all members, as well as participating in the Technical Assistance Programs of the United Nations. Within the ITU, the Consultive Committee on International Telephone and Telegraph (CCITT) and the Consultive Committee on International Radio (CCIR) are

actively engaged in the standardization and coordination of international worldwide communications facilities.

#### THE BELL SYSTEM

The parent company of the Bell System is the American Telephone and Telegraph Company, incorporated in 1885, which owns all or part of the stock of 23 associated operating telephone companies and the Western Electric Company. Together with Western Electric, AT&T owns the Bell Telephone Laboratories. Western Electric manufactures, purchases, distributes and installs equipment to fit the needs of the Bell System. The Bell Telephone Laboratories carry on centralized research for the Bell System.

The people of the Bell Telephone System design, build, operate and maintain facilities for approximately 67 million telephones in 48 of the states and the District of Columbia. Bell System lines connect with telephone systems in all 50 states of this country and throughout the world.

The Bell System provides a wide range of products and services to fit specific communications needs, from the basic telephone instrument to DATA-PHONE Service which enables business machines to communicate via the telephone network in the same way people do. The technological contributions of the Bell System include the invention of the transistor and the solar battery, as well as the designing and building of the Telstar satellites. Touch-Tone calling which will replace the rotary dial with push buttons, and completely electronic telephone call switching are being developed to improve the service of the Bell System to its customers.

Some of the communications services of the Bell System are Wide Area Telephone Service (WATS), Telpak, Teletypewriter Exchange Service (TWX) and DATA-PHONE Service.

WATS. -- Wide Area Telephone Service is arranged for subscribers who make many outgoing long distance calls to many points. Monthly charges are based on the size of the area in which the calls are placed, not on the number or length of calls. Under the WATS arrangement, the United States is divided into six zones. The subscriber is billed a flat rate according to the zones to be called on a full-time or measured-time basis. This can be an advantageous arrangement for data transmission.

TELPAK. -- Telpak service makes available wide band communications channels of various sizes suitable for large-volume point-to-point transmission of data, voice, teletypewriter, facsimile, or other services for a flat-rate regardless of usage. Telpak can be used as a single large channel or a group of smaller channels. For example, a Telpak "A" channel may be divided into 12 voice grade channels.

Teletypewriter Exchange Service. -- Teletypewriter Exchange Service (TWX) provides direct dial point-to-point connections using input/output equipment such as page printers, keyboards, paper tape readers and paper tape punches.

DATA-PHONE Service. -- DATA-PHONE Service provides for the transmission of data between a variety of business machines, using regular local or long distance telephone networks, or WATS lines. The cost to the customer is the same as an ordinary telephone call in addition to a monthly rate for the DATA-PHONE data set.

Other Services. -- In addition to the familiar dial telephone services, voice grade and telegraph grade lines can be leased for the exclusive use of the subscriber.

#### GENERAL TELEPHONE AND ELECTRONICS CORPORATION

General Telephone and Electronics Corporation is a highly diversified communications and manufacturing enterprise whose operations throughout the United States and abroad are known as the "General System". GT&E provides communications services ranging from telephone service for the home and office to highly complex voice and data systems for industry and national defense. The company has approximately 5-1/2 million telephones in more than 30 domestic telephone operation subsidiaries and three international subsidiaries located in British Columbia, the Dominican Republic and Haiti.

Automatic Electric Company, a subsidiary of GT&E, produces communications equipment for the independent telephone industry. Lenkurt Electric Company, Incorporated, another subsidiary, manufactures data sets, microwave radio, and carrier multiplexing equipment for commercial and military communications.

The General System has had broad and extensive experience in the data communications field. Over the years, it has provided a wide variety of services making use of channels ranging from narrow band telegraph up to four-megacycle video channels. Its services include teletypewriter services in its operating territories and direct dial TWX operations.

It is the General System's intention to offer, under tariffs, all data services of the common carriers including wide band Telpak channels. The terminal and hardware equipment utilized in providing data communications will be developed and manufactured by GT&E subsidiaries where practicable. Western Electric equipment will be used in most instances where GT&E does not manufacture equivalent equipment. GT&E equipment will be compatible with the equivalent Bell System equipment, where required, to allow direct interconnection of services. Special arrangements will be available when required to meet individual requirements.

#### INDEPENDENT TELEPHONE COMPANIES

The General System and balance of the 2,800 telephone companies operating 13 million telephones in the United States provide services that interconnect with the Bell System and each other. Over 150 independent telephone companies have more than 10,000 subscribers, and another 100 have more than 5,000 subscribers.

The United States Independent Telephone Association (USITA), with headquarters in Washington, D. C., represents many of the independent telephone companies. It provides guidance to its members and coordinates their practices through committees. "Telephony Magazine", published weekly by the Telephony Publishing Corporation of Chicago, and "Telephone Engineer and Management", published semi-monthly by the Telephone Engineering Publishing Corporation of Chicago, are important vehicles for distributing information about the telephone industry. Both companies publish annual directories indicating the corporate structure and pertinent statistics about telephone companies in the United States.

#### WESTERN UNION

The Western Union Telegraph Company, incorporated in 1851, has played a vital role in the development of communications in the United States.

The company furnishes communications services by wire and microwave radio throughout the United States and by ocean cable between the United States and foreign countries. It provides the only national telegraph message service. It also furnishes custom-built private wire systems and facsimile systems on a leased basis and Telex, a direct-dial teleprinter service.

Western Union leases more than 2,000 private wire systems of varying sizes and speeds for industry and government. It recently placed in service for the Department of Defense the world's largest and most advanced digital data network with a capacity of 7,000,000 punched cards, or the equivalent of 100,000,000 words daily.

Western Union recently expanded its offerings of leased wire facilities to include a full range of voice, alternate voice-record, Telpak and voice-data services. It also leases circuits and equipment to speed communications by facsimile.

Scheduled for operation by Western Union in 1964 is a new coast-to-coast microwave system which will be capable of accommodating all modern forms of communication at high speeds and in large volume. It will be used to transmit voice, facsimile, and high-speed data as well as public message and private wire services.

#### AMERICAN CABLE & RADIO CORPORATION

American Cable & Radio Corporation (AC&R), a subsidiary of International Telephone and Telegraph, owns and operates an international telegraph system with both cable and radio facilities. AC&R was formed when the operations of four IT&T affiliates, All America Cables and Radio, The Commercial Cable Company, Mackay Radio and Telegraph Company, and Sociedad Anonima Radio Argentina (Buenos Aires) were consolidated. The company later acquired control of Globe Wireless, Incorporated.

AC&R, in addition to its operating centers located in New York, Washington, and San Francisco, maintains and staffs more than 110 overseas traffic offices, as well as seven marine radio stations. In the three "gateway" cities of New York, Washington, and San Francisco, the public deals with AC&R directly. Customers outside these cities use AC&R international facilities through the intermediate telegraph or teleprinter services of the domestic carriers, Western Union and the TWX Bell System. This applies to telegraph and Telex service, as well as to leased channel operation.

AC&R's communications network now includes more than 500 cable and radio channels, extending across the Atlantic to Europe, down through the Caribbean, Central and South American areas, and out to the Far East. Through the cable network, its own radio facilities, and by connection with foreign cable and telegraph companies, the IT&T/AC&R Communications System not only connects the United States with practically all countries of the world but also furnishes communications between countries outside the United States.

This worldwide network provides customers with regular message service, press-cast service radiotelephone service, Telex, Datatelex and leased channel service.

AC&R technical activity in the communications field is demonstrated by its installation of the first automatic Telex switching centers in the United States. AC&R Telex customers may call direct to subscribers in London or Paris, for example, without any operator intervention whatsoever.

#### RCA COMMUNICATIONS, INC.

The Radio Corporation of America was created in 1919 to provide international communications facilities. Ten years later, RCA organized a wholly owned subsidiary company, RCA Communications, Inc., to concentrate on the further development of international radio communications. In recent years, RCA has augmented its global radio facilities with coaxial cable channels to Europe, Puerto Rico, Hawaii, Bermuda and Jamaica. The company plans to expand its coaxial cable facilities beyond Hawaii across the Pacific, and to South and Central America in the very near future.

Today, RCA has a global communications network comprised of more than 600 radio and coaxial cable channels providing telegraph service to the entire world, Telex service to 85 countries, and Radiophoto service to 48 foreign terminals. In addition, RCA operates the terminals of 14 radiotelephone circuits in the Pacific area and provides two-way Program Transmission Service for broadcasters to almost any point on the globe. The company also maintains facilities for communication with oceangoing vessels and ships plying inland waterways.

RCA Communications furnishes private leased channel communication services to all parts of the world for commercial and governmental customers. More than 150 such channels for teletypewriter, telephone, facsimile and data communications are in use. New facilities are being designed to meet the needs of proposed transoceanic data processing systems. In New York, a wholly automated telegraph terminal will electronically route, process and transmit telegrams. Datatelex service provides for data communications between the United States and Great Britain on a "call up" basis. Photolex service provides for facsimile transmission between the same points on the same basis.

#### PRIVATELY OWNED COMMUNICATIONS SYSTEMS

The federal government and some industries purchase, maintain and operate some of their communications facilities. Examples of these private systems are telegraph and telephone systems owned by railroads and pipeline companies operating in remote areas. Licenses can be obtained to operate private radio and microwave systems under certain circumstances.

A REPRESENTATIVE LIST OF DATA TRANS-  
MISSION TERMS

Amplifier. -- A device which receives energy at a low level and sends it out at a high level in identical or nearly identical form.

Amplitude. -- The size or magnitude of a voltage or current wave form.

Attenuation. -- The decrease in amplitude that accompanies propagation or passage through equipment, lines or space.

Audio. -- Frequencies which can be heard by the human ear (usually 50 cycles to 16,000 cycles per second).

Band. -- Range of frequency between two defined limits.

Bandwidth. -- The difference, expressed in the number of cycles per second, between the two limiting frequencies of a band.

Baud. -- A unit of signaling speed in data transmission. The speed in bauds is equal to the number of bits per second.

Bit. -- Contraction of "binary digit", the smallest unit of information, which has two possible states, "1" and "0".

Bit rate. -- The speed at which bits are transmitted, usually expressed in bits per second (bauds).

Buffer. -- A storage device used to compensate for a difference in the rate of flow of information, or the time of occurrence of events.

Cable. -- Assembly of one or more conductors within an enveloping protective sheath so constructed as to permit the use of conductors separately or in groups.

Cable, coaxial. -- A cable consisting of one conductor, usually a small copper tube or wire, within and insulated from another conductor of larger diameter, usually copper tubing or copper braid.

Calling, selective. -- The ability of a transmitting station to direct a call to one or more specifically designated stations.

Carrier. -- A high-frequency current that can be modulated by voice or signaling impulses.

Carrier, communications common. -- A company which furnishes communications services to the general public, and which is regulated by appropriate state or federal agencies.

Carrier system. -- A means of conveying a number of channels over a single path by modulating each channel on a different carrier frequency and demodulating at the receiving point to restore the signals to their original form.

Channel. -- A path for electrical transmission between two or more stations or channel terminations. The channel may consist of wire or radio waves or both. A channel is sometimes referred to as a circuit.

Channel, analog. -- A channel on which the information transmitted can take any value between the limits defined by the channel. Voice channels are analog channels.

Channel, duplex. -- A channel providing simultaneous transmission in both directions.

Channel, four-wire. -- A two-way circuit where the signals simultaneously follow separate and distinct paths in opposite directions in the transmission medium.

Channel, half-duplex. -- A channel capable of transmitting and receiving signals, but in only one direction at a time.

Channel, simplex. -- A channel which permits transmission in one direction only.

Channel, two-wire. -- A two-way circuit for transmission in either direction, but not simultaneously.

Channel, voice grade. -- A channel which permits transmission of speech.

Channelizing. -- The process of dividing one circuit into several channels.

Character. -- The actual or coded representation of a digit, letter or special symbol.

Circuit. -- A physical, metallic connection between two points.

Circuit, multi-point. -- A circuit interconnecting several locations which makes information transmitted over the circuit available at all locations simultaneously.

Code. -- A system of symbols and rules for use in representing information.

Communication. -- The transferring of information from one point to another.

Communication, data. -- The transmission of data from one point to another.



Contention. -- A condition on a multi-point communication channel when two or more locations try to transmit at the same time.

Converter. -- A device capable of converting impulses from one mode to another, such as analog to digital or parallel to serial.

Data, analog. -- A physical representation of information such that the representation bears an exact relationship to the original information. The electrical signals on a telephone channel are analog representations of the original voice.

Data, collection. -- The act of bringing data from one or more points to a central point.

Data, digital. -- Information represented by a code consisting of a sequence of discrete elements.

Data set. -- A modulation/demodulation device designed to provide compatibility between input/output equipment and communications facilities.

Data transmission. -- The sending of data from one place to another or from one part of a system to another.

Dialing, Direct Distance. -- An exchange service which enables a telephone user to select subscribers outside the user's local area.

Exchange, central office. -- The place where a communications common carrier locates the equipment which interconnects incoming subscribers and circuits.

Exchange, dial. -- An exchange where all subscribers originate their calls by dialing.

Exchange, manual. -- An exchange where calls are completed by an operator.

Exchange, private automatic (PAX). -- A dial exchange which provides private telephone service to an organization, and which does not allow calls to be transmitted to or from the public telephone network.

Exchange, private automatic branch (PABX). -- A private automatic exchange which provides for the transmission of calls to and from the public telephone network.

Exchange, private branch (PBX). -- A manual or dial exchange, connected to the public telephone network, located on a customer's premises and operated by his employees.

Exchange service. -- A service permitting interconnection of any two customers' telephones through the use of switching equipment.

Frequency multiplexing. -- A method for dividing a circuit into many channels within the bandwidth of the circuit.

Hard copy. -- A machine-printed document, such as a message, order, invoice, etc.

Header. -- The first part of a message, which contains all necessary information for directing the message to the destination(s).

In-plant system. -- A data-handling system confined to one building or a number of buildings in one locality.

Interface. -- A common boundary -- for example, physical connection between two systems or two devices.

Loop, local. -- A channel connecting a subscriber to a central office exchange. Usually a metallic circuit.

Mod/demod. -- Abbreviated form for modulating and demodulating units.

Modem. -- Contraction of modulator-demodulator.

Modulation. -- The process by which some characteristic of one wave is varied in accordance with another wave.

Multiplexing. -- The division of a transmission facility into two or more channels.

Network. -- A series of points interconnected by communications channels.

Network, leased line or private wire. -- A series of points interconnected by telegraph or telephone channels, and reserved for the exclusive use of one customer.

Network, private telegraph. -- A series of points interconnected by leased telegraph channels and providing hard-copy and/or five-track punched paper tape at both sending and receiving points.

Offline system. -- A system in which human operations are required between the original recording functions and the ultimate data processing function. This includes conversion operations as well as the necessary loading and unloading operations incident to the use of data-gathering systems.

Online system. -- A system which eliminates the need for human intervention between source recording and the ultimate processing by a computer.

Perforator, tape. -- Manually operated equipment which punches holes in paper tape.

Point-to-point transmission. -- Transmission of data directly between two points, without the use of any intermediate terminal or computer.

Poll. -- A flexible, systematic method, centrally controlled, for permitting stations on a multi-point circuit to transmit without contending for the line.

Priority indicators. -- Groups of characters used in the header of a message to define the order of transmitting messages over a communication channel.

Processing, batch. -- A method of processing in which a number of similar input items are accumulated and grouped.

Processing, in-line. -- A method of processing in which individual input transactions are completely processed and all pertinent records are updated without previously having been grouped.

Record. -- A group of related facts or fields of information treated as a unit.

Relay center. -- Synonymous with message switching center.

Repeater. -- A device used to amplify and/or reshape communications signals.

Reperforator, tape. -- A device which automatically punches a paper tape from received signals.

Routing. -- Assignment of the communications path by which a message or telephone call will reach its destination.

Routing, message. -- The function of selecting the route, or alternate route, if required, by which a message will proceed to its destination. Sometimes used in place of message switching.

Routing indicator. -- An address or group of characters in the header of a message defining the final circuit or terminal to which the message has to be delivered.

Service, extended area. -- An exchange service without toll charges, which extends over a geographical area where there is a community of interest in return for a somewhat higher exchange service rate.

Service, private line (wire). -- A channel or circuit furnished a subscriber for his exclusive use.

Stunt box. -- A device to control nonprinting functions of a telegraph terminal.

Subset. -- A modulation/demodulation device designed to make business machine signals compatible with communications facilities. A subset is also known as a modem, subscribers set, or data set.

Switching, circuit or line. -- A switching technique where the connection is made between the calling party and the called party prior to the start of a communication (for example, telephone switching).

Switching, message. -- The technique of receiving a message, storing it until the proper outgoing circuit is available, and then retransmitting it.

Switching center. -- A location at which incoming data from one circuit is transferred to the proper outgoing circuit.

Switching center, automatic message. -- A location where an incoming message is automatically directed to one or more outgoing circuits according to intelligence contained in the message.

Switching center, semiautomatic message. -- A location where an incoming message is displayed to an operator who directs the message by push-button addressing to one or more outgoing circuits according to the information read from the tape.

Switching center, torn-tape. -- A location where operators tear off the incoming printed and punched paper tape and transfer it manually to the proper outgoing circuit.

Tariff. -- The published rate for a particular approved commercial service of a common carrier.

Telecommunication. -- Any transmission or reception of signals, writing, sounds, or intelligence of any nature, by wire, radio, visual or electromagnetic systems. Often used interchangeably with "communication".

Teleprinter. -- Trade name used by Western Union to refer to its telegraph terminal equipment.

Teletype. -- Trademark of the Teletype Corporation. A system for transmitting messages over some distance, employing keyboard or paper tape sending and printed receiving.

Teletypewriter. -- Trade name used by AT&T to refer to telegraph terminal equipment.

Teletypewriter Exchange Service (TWX). -- A switched network providing means for interconnecting AT&T Teletypewriter subscribers.

Telex. -- An automatic Teletype exchange service provided domestically by Western Union.

Telpak. -- A tariff offered by a common carrier for the leasing of wide band channels.

Toll. -- A charge for making a connection beyond an exchange boundary.

Transmission. -- The electrical transfer of a signal, message or other form of intelligence from one location to another.

Wide Area Telephone Service (WATS). -- A service which allows the customer to place unlimited calls within one or more zones on a direct dialing basis, for a predetermined monthly charge.



International Business Machines Corporation  
Data Processing Division, 112 East Post Road, White Plains, N. Y. 10601