

**Maintenance Library**

**3274**

**Control Unit  
Models 51C, 52C, and 61C  
Maintenance Concepts**

## Federal Communications Commission (FCC) Statement

**Warning:** This equipment generates, uses, and can radiate radio frequency energy and if not installed and used in accordance with the instructions manual, may cause interference to radio communications. It has been tested and found to comply with the limits for a Class A computing device pursuant to Subpart J of Part 15 of FCC Rules, which are designed to provide reasonable protection against such interference when operated in a commercial environment. Operation of this equipment in a residential area is likely to cause interference in which case the user at his own expense will be required to take whatever measures may be required to correct the interference.

## IBM Statement

This warning is also applicable to all attaching units produced for use in the U.S.A. that have been manufactured after December 31, 1980. A notice of compliance has been affixed within the customer access area of all affected units.

## Sixth Edition (December 1983)

This major revision obsoletes SY27-2528-4. Significant changes having been made throughout, this edition should be reviewed in its entirety.

Changes are made periodically to the information herein; before using this publication in connection with the installation and operation of IBM equipment, consult the latest *IBM System/360 Bibliography*, GC20-0360, and *IBM System/370 and 4300 Processors Bibliography*, GC20-0001, for the editions that are applicable and current.

IBM has prepared this maintenance manual for the use of IBM customer engineers in the installation, maintenance, or repair of the specific machines indicated. IBM makes no representations that it is suitable for any other purpose.

The drawings and specifications contained herein shall not be reproduced in whole or in part without written permission.

Information contained in this manual is subject to change from time to time. Any such change will be reported in subsequent revisions or Technical Newsletters.

References in this publication to IBM products, programs, or services do not imply that IBM intends to make these available in all countries in which IBM operates. Any reference to an IBM product in this publication is not intended to state or imply that only IBM's product may be used. Any functionally equivalent program may be used instead.

Publications are not stocked at the address given below. Request for IBM publications should be made to your IBM representative or to the IBM branch office serving your locality.

A form for readers' comments is provided at the back of this publication. If the form has been removed, address comments to IBM Corporation, Department 52Q, Neighborhood Road, Kingston, N.Y. U.S.A. 12401. IBM may use or distribute whatever information you supply in any way it believes appropriate without incurring any obligation to you.

## CE SAFETY PRACTICES

All Customer Engineers are expected to take every safety precaution possible and observe the following safety practices while maintaining IBM equipment:

1. You should not work alone under hazardous conditions or around equipment with dangerous voltage. Always advise your manager if you **MUST** work alone.
2. Remove all power AC and DC when removing or assembling major components, working in immediate area of power supplies, performing mechanical inspection of power supplies and installing changes in machine circuitry. Pull the power plug from the receptacle to remove power source.
3. Wall box power switch, when used to disconnect power, should be locked or tagged in off position. "Do not Operate" tags, form 229-1266, should be securely attached to power switch or to outside of power box.
4. When it is absolutely necessary to work on equipment having exposed operating mechanical parts or exposed live electrical circuitry anywhere in the machine, the following precautions must be followed:
  - a. At least one other person familiar with power off controls, emergency power off procedures, and the location of the wall box power switch, must be in the immediate vicinity at all times.
  - b. Rings, wrist watches, chains, bracelets, metal cuff links, shall not be worn.
  - c. Only insulated pliers and screwdrivers shall be used.
  - d. Keep one hand in pocket.
  - e. When using test instruments be certain they are of proper capacity and controls are set correctly. Only insulated probes are used.
  - f. Avoid contacting ground potential (metal floor strips, machine frames, etc. — use suitable rubber mats purchased locally if necessary).
5. Safety Glasses must be worn when:
  - a. Using a hammer to drive pins, riveting, staking, etc.
  - b. Power hand drilling, reaming, grinding, etc.
  - c. Using spring hooks, attaching springs.
  - d. Soldering, wire cutting, removing steel bands.
  - e. Parts cleaning, using solvents, sprays, cleaners, chemicals, etc.
  - f. All other conditions that may be hazardous to your eyes. **REMEMBER, THEY ARE YOUR EYES.**
6. Special safety instructions such as handling Cathode Ray Tubes and extreme high voltages, must be followed as outlined in CEM's and Safety Section of the Maintenance Manuals.
7. Do not use solvents, chemicals, greases or oils that have not been approved by IBM.
8. Avoid using tools or test equipment that have not been approved by IBM.
9. Replace worn or broken tools and test equipment.
10. The maximum load to be lifted is that which in the opinion of you and management does not jeopardize your own health or well-being or that of other employees.
11. All safety devices such as guards, shields, signs, ground wires, etc., shall be restored after maintenance.
12. Each Customer Engineer is responsible to be certain that no action on his part renders product unsafe or exposes hazards to customer personnel.
13. Place removed machine covers in a safe out-of-the-way place where no one can trip over them.
14. All machine covers must be in place before machine is returned to customer.
15. Always place CE tool kit away from walk areas where no one can trip over it (i.e., under desk or table).
16. Avoid touching mechanical moving parts (i.e., when lubricating, checking for play, etc.).
17. When using stroboscope — do not touch **ANYTHING** — it may be moving.
18. Avoid wearing loose clothing that may be caught in machinery. Shirt sleeves must be left buttoned or rolled above the elbow.
19. Ties must be tucked in shirt or have a tie clasp (preferably nonconductive) approximately 3 inches from end. Tie chains are not recommended.
20. Before powering up or starting equipment, make certain other CEs and customer personnel are not in a hazardous position.
21. Maintain good housekeeping in area of machines while performing and after completing maintenance.
22. Even though preventive measures are taken, accidents do occur. CEs and support personnel should be prepared to follow emergency first aid procedures as outlined below.

### First Aid — General

1. If accidental electrocution occurs:
  - a. Remove power source before touching victim.
  - b. If power cannot be removed, pull victim away from equipment by using non-conductive material such as a broom handle, leather belt, or necktie.
  - c. Immediately begin rescue breathing; see below.
  - d. Begin CPR if necessary and only if trained person is available.
  - e. Call a doctor.  
Have someone summon medical aid.
  - f. Remain in position.  
After victim revives, be ready to resume respiration if necessary.
2. For serious injury:
  - a. Summon medical aid.
  - b. Do not move victim unless absolutely necessary to remove from danger.
  - c. Attempt to stop serious bleeding by using pressure points or a pressure bandage.
  - d. Loosen clothing and keep victim warm.

### Artificial Respiration

#### General Considerations

1. Start Immediately, Seconds Count  
Do not wait or look for help or stop to loosen clothing, warm the victim or apply stimulants.
2. Check Mouth for Obstructions  
Remove foreign objects — Pull tongue forward.

#### Rescue Breathing for Adults — Place Victim on His Back Immediately

1. Clear throat of water, food, or foreign matter.
2. Tilt head back to open air passage.
3. Lift jaw up to keep tongue out of air passage.
4. Pinch nostrils to prevent air leakage when you blow.
5. Blow until you see chest rise.
6. Remove your lips and allow lungs to empty.
7. Listen for snoring and gurglings, signs of throat obstruction.
8. Repeat mouth to mouth breathings 10-20 times a minute. Continue rescue breathing until he breathes for himself, or medical aid arrives.



Reprint Courtesy Mine Safety Appliances Co.

# Safety Notices

## Personal Safety

The Danger and Caution notices that appear in this manual refer mainly to the 31SD Diskette Drive. Before using this manual, review all the Danger and Caution notices that are listed in the front of the *3274 Control Unit Maintenance Information* manual, SY27-2513.

### General Personal Safety Information

AC voltages are present on the 31SD drive motor connector and capacitor terminals when the drive motor is running. The motor and the solenoid become hot after continuous use; let the parts cool before attempting servicing. The following Danger and Caution notices appear in this manual:

#### DANGER

Input AC voltage is present in the Prime Power Box when the 3274 I/O (on/off) switch is in the O (off) position.

#### DANGER

Voltage is still present at the socket when the power cable is disconnected.

#### DANGER

High voltage may be present at the capacitor terminals.

#### CAUTION:

The solenoid case becomes hot after continuous use.

## Machine Safety

The notices that appear in this manual refer mainly to the 31SD Diskette Drive. Before using this manual, review all the Warning notices that appear in the *3274 Control Unit Maintenance Information* manual, SY27-2513.

### General Machine Safety Information

The 31SD Diskette Drive can be damaged if it is not operated or serviced correctly. Do not use IBM cleaning fluid or other chemical cleaning fluids near plastic parts. Never use damaged diskettes in a 31SD Diskette Drive. Diskettes that are damaged physically (creased or bent) or contaminated by pencil marks, finger marks, or cleaning fluids can cause data errors, equipment errors, or head damage. The following Warning notices appear in this manual:

**Warning:** Do not attempt to remove the collet/flat spring before removing the bail. Too much pressure or binding can damage the spring.

**Warning:** Damage to the head can occur if the pressure pad is permitted to hit the head.

**Warning:** Too much pressure or binding of the flat spring will damage the spring.

**Warning:** The head/carriage assembly is adjusted and tested at the factory. Do not attempt to adjust or repair any part of this assembly.

**Warning:** The head area can be easily damaged or contaminated. Read the following before exchanging a pressure pad:

- Ensure that your tools are clean; use isopropyl alcohol (part 2200200) and a clean tissue (part 2162567), or use an alcohol pad (part 9900679).
- Do not touch the pressure pad with your fingers.
- Be careful not to damage the new pressure pad or loosen any of the pad's surface. The layer of adhesive on the new pad is very thin; do not damage the adhesive. Do not let the adhesive touch the surface of the pad that will touch the diskette. Do not use damaged pads.
- Do not scratch the head load arm.
- Do not let the head load arm hit the read/write head.
- Move the head load arm as little as possible. The tension spring can come out.

**Warning:** The head/carriage service check must be performed with the diskette drive installed (or with the diskette drive in the same position as when installed), or the adjustment might not be accurate.

**Warning:** The head/carriage assembly adjustment must be performed with the diskette drive installed (or in the same position as when installed), or the adjustment might not be accurate.

**Warning:** The band must not be bent or damaged in any way.

**Warning:** When you install the head/carriage assembly, ensure that the bail is under the head load arm. Ensure that the bail return spring is correctly installed. Ensure that the band is not damaged in any way.

**Warning:** The band is easily damaged. Do not bend, crease, or scratch the band. Do NOT use a damaged band.

# Preface

This manual contains the information needed by the support field engineering (FE) customer engineer to maintain the IBM 3274 Control Unit Models 51C, 52C, and 61C.

The maintenance procedures described in this manual and performed by the support FE customer engineer represent a part of the overall support structure for the 3274 Control Unit. This support structure begins at the 3274 operator level and is briefly described as follows:

- **3274 Operator** — Performs initial problem isolation and recording of 3274 status indications by following the procedure in the *3274 Problem Determination Guide*, GA27-2854. If the problem is other than a customer operating procedure or customer-supplied power, the operator completes the *3274 Problem Report Form* and requests IBM service.
- **Product Customer Engineer** — Performs the maintenance procedures contained in the *3274 Maintenance Information* manual (MIM) to isolate the problem to a field replaceable unit (FRU). The *3274 Problem Report Form* prepared by the operator gives the 3274 indications necessary for performing these procedures. If the problem cannot be isolated and corrected, the product customer engineer requests assistance from the next level of the support structure.
- **Support Customer Engineer** — Verifies the results obtained by the product customer engineer and performs an in-depth analysis of the problem by means of the following:
  - Tests
  - Log Information
  - Error Code Definitions
  - Result of Host Test Routines
  - Special Tools and Test Equipment

If the problem cannot be isolated and resolved with the use of these service aids, the support customer engineer records the problem indications and supporting information on the 3274 Problem Checklist and requests assistance from the next level of the support structure.

## Organization

This manual is organized as follows:

- Chapter 1 — Maintenance Approach and System Overview
- Chapter 2 — Subsystem Indicators, Symbols, and Messages
- Chapter 3 — Subsystem Error Logs and Test Formats
- Chapter 4 — Subsystem Tests, External Tests, and Subsystem Service Aids
- Chapter 5 — Reference Data
- Chapter 6 — Tools and Test Equipment
- Appendix A — Support Structure Information Form
- Appendix B — 3274 Model 51C, 52C, and 61C Error Codes
- Appendix C — X.21 Switched Feature C-1
- Appendix D — X.25 Adapter Feature
- List of Abbreviations X-1



# Contents

## Chapter 1. Maintenance Approach and System Overview 1-1

- 1.1 Maintenance Approach 1-1
- 1.2 Subsystem Data Flow 1-3
  - 1.2.1 IML Test Data Path 1-4
  - 1.2.2 IML of Unit Code 1-4
  - 1.2.3 Message Data Flow between 3274 Control Unit and Attached Devices 1-5
  - 1.2.4 Message Data Flow between 3274 Control Unit and Host System 1-6
- 1.2.5 Logic Data Flow 1-7
- 1.3 Subsystem Functions 1-8
  - 1.3.1 Control Unit Power On Reset 1-9
  - 1.3.2 Keystroke Handling 1-9
  - 1.3.3 Sending to Host 1-11
  - 1.3.4 Receiving from Host 1-11
  - 1.3.5 Error Handling and Logging 1-11
  - 1.3.6 Internal Testing 1-11
  - 1.3.7 Function Priority 1-12
  - 1.3.8 Type A Adapter Coax Data Path 1-13
- 1.4 Supporting Publications 1-14

## Chapter 2. Subsystem Indicators, Symbols, and Messages 2-1

- 2.1 Introduction 2-1
- 2.2 8 4 2 1 Indicators 2-1
- 2.3 Power ON/OFF Indicator 2-1
- 2.4 Operator Information Area Layout 2-2
  - 2.4.1 Readiness and System Connection Symbols 2-2
  - 2.4.2 Do Not Enter (Input Inhibited) Symbols 2-2
  - 2.4.3 Reminder Symbols 2-5
    - 2.4.3.1 Communication Reminder Symbols 2-5
  - 2.4.4 Programmed Symbols 2-6
  - 2.4.5 Shifts and Modes Symbols 2-6
  - 2.4.6 Extended Highlighting 2-7
  - 2.4.7 Extended Color 2-7
  - 2.4.8 Printer Status Messages 2-8
  - 2.4.9 Machine Check Numbers 2-8
  - 2.4.10 Program Check Numbers 2-8
  - 2.4.11 Communication Check Numbers 2-8

## Chapter 3. Subsystem Error Logs and Test Formats 3-1

- 3.1 Introduction 3-1
- 3.2 Test 0: Communication Path Test and Display Test 3-1
  - 3.2.1 Description 3-1
  - 3.2.2 Procedure for Requesting Test 0 3-2
- 3.3 Test 1: Overview 3-2
  - 3.3.1 Test 1 Device Logs 3-3
  - 3.3.2 Test 1 Host Adapter Logs 3-6
  - 3.3.3 Test 1 Common Communications Adapter (CCA) Log for BSC 3-6
  - 3.3.4 Test 1 Common Communications Adapter (CCA) Log and High-Performance Communications Adapter (HPCA) Log for SDLC 3-11
  - 3.3.5 Test 1 Storage Card Isolation (Model 52C Only) 3-16
  - 3.3.6 Test 1 Device Adapter Logs 3-16
  - 3.3.7 Test 1 Type A Adapter Log 3-16
  - 3.3.8 Test 1 Type B Adapter/Encrypt-Decrypt Adapter Log 3-17
  - 3.3.9 Control Logic Error Log 3-19
  - 3.3.10 Display Response Time Monitor Data (A4/1) 3-20
  - 3.3.11 Reset Response Time Monitor (A4/4) 3-20
  - 3.3.12 Microcode Error-Correcting Code (ECC) Data (All Configuration Support Levels Except D) 3-21

- 3.3.13 X.21 Switched Log 3-21
- 3.3.14 Test 1 Extension for X.21 Switched 3-23
- 3.4 X.25 A0/1 Test 3-24
  - 3.4.1 X.25 Counters 3-26
    - 3.4.1.1 HPCA Counters 3-26
    - 3.4.1.2 X.25 Auxiliary Counters (Link-Level) 3-26
    - 3.4.1.3 X.25 Auxiliary Counters (Circuit-Level) 3-27
    - 3.4.1.4 X.25 Statistical Counters (Link-Level) 3-27
    - 3.4.1.5 X.25 Statistical Counters (Circuit-Level) 3-28
  - 3.5 Test 2: Display Configuration Information 3-28
  - 3.6 Test 3: Display the Status of All Configured Terminals and Display the Control Unit Summary Counters 3-40
  - 3.7 X.25 /3 Test 3-41
  - 3.8 Test 4: Reset Any Test 1 Log 3-42
  - 3.9 Test 5: Register Page Display 3-42
  - 3.10 Test 6: Device Control Block Display 3-43
    - 3.10.1 Test 6 Byte Identification 3-43
    - 3.10.2 DCB Bit Definitions 3-43
  - 3.11 /B Test: Device Address Assignment Table 3-47
  - 3.12 Test 7: Dynamic Convergence (Color) 3-47
  - 3.13 Test 8: PSs. Highlighting, and Color 3-47
  - 3.14 Kanji/Chinese Character Display 3-47
  - 3.15 /D Test — Request 3290 Dump 3-47
  - 3.16 /A Test — Operator Originated Alerts (Configuration Supports C and D) 3-48
  - 3.17 3277 Path Test and Test Request Key<sup>2</sup> 3-49
    - 3.17.1 BSC or Local Host Attached 3-49
    - 3.17.2 SNA Attached 3-49

## Chapter 4. Subsystem Tests, External Tests, and Subsystem Service Aids 4-1

- 4.1 Introduction 4-1
- 4.2 Initial Machine Load (IML) Tests (Models 51C and 52C) 4-1
  - 4.2.1 ALT 1 IML Mode 4-2
  - 4.2.2 ALT 2 IML Mode, Models with Wrappable Modem (Test/Operate Switch in Operate Position) 4-2
  - 4.2.3 ALT 2 IML Mode, Models without Wrappable Modem (Test/Operate Switch in Test Position) 4-2
  - 4.2.4 ALT 2 IML Mode, Modem Self-Test for Model 51C with Greater than 1200-bps Integrated Modem 4-3
- 4.3 Model 51C, 52C, and 61C Display System Online Tests 4-4
  - 4.3.1 Purpose 4-4
  - 4.3.2 Applicable Executive Control Programs 4-4
  - 4.3.3 Online Tests 4-4
- 4.4 Serviceability Aids 4-4
  - 4.4.1 Diskette Patching Procedure 4-4
  - 4.4.2 3274 Subsystem Dump Procedure 4-10
    - 4.4.2.1 Dump Print Program (B/M 4759525) 4-11
    - 4.4.2.2 Dump Analysis Document (Included in B/M 4759525) 4-11
  - 4.4.3 Coaxial Cables 4-11
    - 4.4.3.1 Cable  $\ell$  (Indoor) 4-11
    - 4.4.3.2 Cable  $\ell$  (Outdoor) 4-11
    - 4.4.3.3 Coaxial Cable Splicing 4-11
  - 4.4.4 Coax Testing with Scope 4-11
    - 4.4.4.1 Testing for Discontinuities 4-11
    - 4.4.4.2 Setup and Test Procedures 4-12

## Chapter 5. Reference Data 5-1

- 5.1 Introduction 5-1
- 5.2 Control Unit Command Summary 5-1

5.2.1	Write	5-1
5.2.2	Erase/Write	5-1
5.2.3	Erase/Write Alternate	5-1
5.2.4	Erase All Unprotected	5-1
5.2.5	Read Buffer	5-1
5.2.6	Read Modified	5-1
5.2.6.1	Read Modified Read	5-2
5.2.6.2	Short Read Read	5-2
5.2.6.3	Test Request Read (Models 51C and 61C, BSC)	5-2
5.2.7	Read Modified All (3274 SNA Only)	5-2
5.2.8	Copy (Models 51C and 61C, BSC)	5-2
5.2.9	Write Structured Field	5-2
5.3	Control Unit Order Summary	5-2
5.3.1	Set Buffer Address (SBA)	5-2
5.3.2	Start Field (SF)	5-2
5.3.3	Insert Cursor (IC)	5-2
5.3.4	Repeat to Address (RA)	5-3
5.3.5	Erase Unprotected to Address (EUA)	5-3
5.3.6	Program Tab (PT)	5-3
5.3.7	New Line (NL)	5-3
5.3.8	End of Message (EM)	5-3
5.3.9	Duplicate (DUP)	5-4
5.3.10	Field Mark (FM)	5-4
5.3.11	Forms Feed (FF) (Category A and 3288 Printers)	5-4
5.3.12	Carriage Return (CR) (Category A Printers)	5-4
5.3.13	Structured Field and Attribute Processing Orders	5-4
5.3.13.1	Start Field Extended (SFE)	5-4
5.3.13.2	Modify Field (MF)	5-4
5.3.13.3	Set Attribute (SA)	5-4
5.4	I/O Interface Codes	5-4
5.5	Examining 3279 Attributes and Modified Data Tags	5-12
5.6	Sequence/Response Diagrams, BSC	5-12
5.7	Remote Status and Sense Byte Definitions, BSC	5-22
5.7.1	Error Recovery Procedures	5-26
5.7.2	Supplementary Procedures	5-27
5.8	SDLC Sequence Response Descriptions	5-27
5.8.1	SDLC Transmission Frames	5-27
5.8.1.1	Response Modes	5-27
5.8.1.2	Control Field	5-28
5.8.2	Sequence Error Recovery Procedures	5-29
5.8.2.1	Abort Function	5-29
5.8.2.2	Timeout Control	5-29
5.8.3	Hexadecimal Notation and Frame Summary	5-29
5.9	SNA Information	5-30
5.9.1	Session Control	5-30
5.9.2	Data Flow Control	5-30
5.9.3	Transmission Header	5-30
5.9.4	Request/Response Header	5-31
5.9.5	SNA Definitions	5-32
5.9.6	SDLC/SNA Command to Start a Session	5-32
5.10	SDLC/SNA Error Information	5-33
5.10.1	Exception Response with Sense Data Included	5-33
5.10.2	SNA Sense Codes	5-34
5.10.3	Logical Unit Status (LUSTAT)	5-36
5.10.4	Command Reject	5-38
5.10.5	Request Maintenance Statistics (REQMS) Command	5-38
5.10.5.1	Record Formatted Maintenance Statistics (RECFMS)	5-39
5.10.5.2	RECFMS Formats	5-39
5.11	Switches and Controls	5-41
5.12	BSC and SNA Readiness Symbols	5-42
5.13	Digital Data Service (DDS) Adapter	5-44

## Chapter 6. Tools and Test Equipment 6-1

6.1	Introduction	6-1
6.2	Buffered Teleprocessing Diagnostic Analyzer and Tester (BTDAT)	6-1
6.3	NU Data Tester	6-1
6.4	PT-2 Attachment to Non-EIA Interfaces	6-1

## Appendix A. Support Structure Information Form A-1

## Appendix B. 3274 Model 51C, 52C, and 61C Error Codes B-1

B.1	List of Error Codes	B-1
B.2	<i>Probable Cause</i> Notes for Error Codes	B-31
B.3	Correlation between Indicator Codes and Log Area	B-32

## Appendix C. X.21 Switched Feature (3274 Models 51C and 61C) C-1

C.1	Introduction	C-1
C.2	Functional Description	C-1
C.2.1	X.21 Switched CAC Function	C-2
C.2.1.1	Function Requests	C-2
C.2.1.2	Call Collision	C-2
C.2.1.3	Call Progress (CP) Signals	C-3
C.2.2	Data Link Control Function	C-3
C.2.2.1	Call Ready	C-3
C.2.2.2	Incoming Call in Process	C-3
C.2.2.3	Dialing	C-3
C.2.2.4	Direct Call	C-3
C.2.2.5	Outgoing Call in Process	C-3
C.2.2.6	Local Mode	C-3
C.2.2.7	Disconnection	C-4
C.2.3	X.21 Switched Adapter (X.21) Card	C-4
C.3	Extension Key and Modifier Keys	C-4
C.3.1	Locations	C-4
C.3.2	Extension Mode	C-4
C.4	Status and Key Operation	C-5
C.5	Error Codes and Recovery	C-6
C.6	Call Progress Signal Code	C-6

## Appendix D. X.25 Adapter Feature (3274 Models 51C and 61C) D-1

D.1	Introduction	D-1
D.2	X.25 Elements	D-1
D.2.1	Physical Level	D-1
D.2.2	Link Level	D-1
D.2.3	Packet Level	D-1
D.3	Hardware/Configuration Support	D-1
D.3.1	Configuration Support	D-1
D.3.2	Hardware Support	D-1
D.3.2.1	Hardware Required	D-2
D.3.2.2	Mutually-Exclusive Feature	D-2
D.4	Timers	D-2
D.5	The X.25 Network	D-2
D.5.1	Virtual Circuits	D-2
D.5.2	Logical Channels	D-2
D.6	Packet Types	D-2
D.6.1	Call Request (SVC)	D-2
D.6.2	Incoming Call (SVC)	D-2
D.6.3	Call Accepted (SVC)	D-2
D.6.4	Call Connected (SVC)	D-2
D.6.5	Clear Request (SVC)	D-2
D.6.6	Clear Indication (SVC)	D-3
D.6.7	Clear Confirmation (SVC)	D-3





# Figures

1-1	Support Customer Engineer Maintenance Approach	1-2	4-6	A1D2 Card Indicator for 4800-bps Integrated Modem (Model 51C Only)	4-3
1-2	3274 Subsystem Overview	1-3	4-7	A1D2 Card Indicator for 9600-bps Integrated Modem (Model 51C Only)	4-3
1-3	Initial Machine Load (IML) Data Flow	1-4	4-8	3274 Model 51C, 52C, and 61C Online Tests	4-4
1-4	Message Data Flow between 3274 Control Unit and Attached Devices	1-5	4-9	Operator Codes	4-6
1-5	Message Data Flow between 3274 Control Unit and Host System	1-6	4-10	Dump Procedure Error Codes	4-10
1-6	Logic Data Flow	1-7	4-11	Incident and Reflected Waves	4-12
1-7	3274 Subsystem Functions	1-8	4-12	Scope Setup	4-13
1-8	Keystroke Handling, Type A Adapter	1-10	4-13	Measurement Points	4-13
1-9	Inbound Messages	1-11	4-14	Display Examples	4-14
1-10	Outbound Messages	1-12	5-1	Command Codes	5-1
1-11	3274 Subsystem Functional Priorities	1-12	5-2	Buffer Control Orders and Order Codes	5-3
1-12	Coax to Type A Adapter Data Flow	1-13	5-3	United States EBCDIC I/O Interface Code for 3274 Control Unit and Attached Category B Devices	5-5
2-1	8 4 2 1 Indicator Control Logic	2-1	5-4	United States EBCDIC I/O Interface Code for 3274 Control Unit and Attached Category A Devices	5-6
2-2	Operator Information Area Layout (without Extended Data Stream)	2-2	5-5	United States ASCII I/O Interface Code for 3274 Control Unit and Attached Category A Devices	5-7
2-3	Operator Information Area Layout (with Extended Data Stream)	2-2	5-6	Format of Write Control Character (WCC) Byte	5-8
2-4	Readiness and System Connection Symbols (Locations 1 through 7)	2-2	5-7	Function of Write Control Character (WCC) Bits	5-8
2-5	Do Not Enter Symbols (Locations 9 through 17)	2-3	5-8	Attribute Character Bit Assignments for 3278s	5-9
2-6	Reminders (Locations 21 through 27)	2-5	5-9	3278 Top-Card Connector CE Jumper (Three Base Cards)	5-9
2-7	Programmed Symbols (Locations 31 through 34)	2-6	5-10	3278 Top-Card Connector CE Jumper (Two Base Cards)	5-9
2-8	Shifts and Modes (Locations 36 through 44 and Location 52) – With Extended Data Stream; (Locations 32 through 41) – Without Extended Data Stream	2-7	5-11	Attribute Character Bit Assignments for 3277s	5-10
2-9	Extended Highlighting (Locations 46 and 47)	2-7	5-12	Control Character I/O Codes	5-11
2-10	Extended Color (Locations 49 and 50)	2-7	5-13	3279 Top-Card Connector CE Jumper	5-12
2-11	Printer Status (Locations 60 through 64)	2-8	5-14	3279 Base Field Attributes	5-12
2-12	Diagnostic Code Modifiers	2-9	5-15	3274 Message Response to Polling or Read Modified Command	5-13
2-13	Cause Codes (Use Field Received from the DCE)	2-9	5-16	General Poll and Specific Poll, Sequence/Response Diagram	5-14
2-14	Diagnostic Code Fields Received from the DCE	2-10	5-17	Selection Addressing, Sequence/Response Diagram	5-16
2-15	Diagnostic Code Fields Generated by an IBM (SNA) DTE	2-10	5-18	Write-Type and Control-Type Commands, Sequence/Response Diagram	5-18
3-1	Summary of Counter Definitions by Log Type	3-5	5-19	Read-Type Command, Sequence/Response Diagram	5-20
3-2	CCA BSC Operation Attempted Chart (Code FF)	3-7	5-20	Remote Status and Sense Byte Definitions, BSC	5-23
3-3	CCA BSC Operation Ending Chart (Code CCCC)	3-7	5-21	Remote Error Status and Sense Responses, BSC	5-24
3-4	Sense Byte Breakdown Chart for CCA BSC (Code SSSS)	3-11	5-22	Remote 3270 BSC Status and Sense Conditions	5-26
3-5	CCA/HPCA SDLC Operation Attempted Chart (Code FF)	3-11	5-23	Nonsequenced Commands and Responses Supported by 3274	5-28
3-6	CCA/HPCA SDLC Operation Ending Chart (Code CCCC)	3-13	5-24	SDLC Commands and Responses in Hexadecimal Notation	5-29
3-7	Sense Byte Breakdown Chart for CCA/HPCA SDLC (Code SSSS)	3-15	5-25	Session Control Functions Supported by 3274	5-30
3-8	Sense (SS) Byte Definitions	3-17	5-26	Data Flow Control Requests Supported by 3274	5-30
3-9	Type B Adapter Operation Attempted Chart (Code FF)	3-17	5-27	Transmission Header Format	5-30
3-10	Type B Adapter Operation Ending Chart (Code CCCC)	3-18	5-28	Request/Response Header Format	5-31
3-11	X.21 Switched Log Settings	3-21	5-29	SDLC/SNA Commands Required to Start Session with LU1	5-32
3-12	Subsystem Configuration	3-30	5-30	SDLC/SNA Exception Responses	5-33
3-13	Test 6 Byte ID Chart	3-44	5-31	Summary Table of LUSTATs	5-37
3-14	DCB Bit Definition Chart	3-44	5-32	Command Reject (CMDR) Message Format	5-39
4-1	IML Test Error Indications	4-1	5-33	Switches and Controls	5-41
4-2	ALT 1 IML Sequence	4-2	5-34	BSC Readiness Symbols	5-42
4-3	ALT 2 IML Sequence, Models with Wrappable Modem	4-2	5-35	SNA Readiness Symbols	5-43
4-4	ALT 2 IML Sequence, Models without Wrappable Modem	4-3	5-36	Connection of 3274 Control Unit with DDS Adapter Feature	5-44
4-5	A1D2 Card Indicator for 2400-bps Integrated Modem (Model 51C Only)	4-3	5-37	Digital Data Waveshapes	5-45
			6-1	TPLM Tab Pin Locations	6-1

B-1	Correlation between Indicator Codes and Log Area	B-33
C-1	Data Link Control Function	C-1
C-2	Keyboard Layout with X.21 Switched Feature	C-4
C-3	Key Operation (During X.21 Switched States)	C-5
C-4	Key Operation in Dial-In Mode	C-6
C-5	Call Progress Signal Code	C-6
D-1	Control Unit/Terminal Responses in Dial-In State	D-6
D-2	Key Operations During X.25 States	D-9
D-3	Extension Mode Definition	D-13
D-4	Extension Key and X.25 Function Keys	D-14
D-5	Dial Mode Display Layout	D-15
D-6	PVC States and Indicators	D-17
D-7	SVC States and Indicators	D-18



# Chapter 1. Maintenance Approach and System Overview

This chapter contains information to assist the support customer engineer in isolating and correcting 3274 sub system problems that cannot be attributed to a failing field replaceable unit (FRU). The information supplements existing documentation covering problem isolation, use of serviceability aids, specialized tools, and test equipment. The topics presented include the following:

- **Overall Maintenance Approach:** The maintenance approach is outlined to provide flexibility both in the type of approach taken and in the selection of supporting serviceability aids. The maintenance approach identifies and refers to procedures, tests, specialized tools, and test equipment that will most likely help isolate various types of 3274 problems. Detailed descriptions of these serviceability aids and their use are contained in other chapters in this publication. In addition, examples using these serviceability aids are given for typical 3274 problems.
- **Subsystem Operation Overview:** This overview gives a general description of 3274 operations and functions.
- **Serviceability Aids:** A general description of serviceability aids and their use is given. These aids include the operational indicators, display symbols, error suffix codes, logouts, tests, test equipment, and host error recording.
- **Reference Material:** All supporting reference material in this publication is identified and described. This reference material provides detailed descriptions of error recording and indications, tests, error recovery procedures, 3270/3274 operational differences, error suffix code action chart, and tools and test equipment.
- **Procedure for Requesting Assistance:** A procedure for requesting assistance from the next level of the support structure is outlined. This procedure includes 3274 problem recording which will aid the support structure in problem determination.
- **Supporting Publications:** Supporting IBM publications are identified.

## 1.1 MAINTENANCE APPROACH

This maintenance approach is outlined to provide flexibility both in the type of approach taken and in the selection of supporting service aids. The approach used to isolate a specific 3274 problem may vary because of multiple error indications and the type of operation being performed at the time the error occurred. Therefore, the following maintenance approach to typical problems is not necessarily the only effective approach that could be used.

The suggested maintenance approach identifies and refers to various procedures, tests, tools, and test equipment that will most likely aid in isolation of the problem. This approach has four basic steps, which are performed in sequence:

### Step 1

Review and verify the results obtained by the product customer engineer by using the following reference material:

- *3274 Problem Report Form*
- *3274 Control Unit Maintenance Information*

### Step 2

Analyze operational indicators (8 4 2 1), display symbols, and error suffix codes (nnn codes).

### Step 3

Analyze logouts, hang conditions, and failing operation sequences.

### Step 4

Record all problem symptoms, and complete the Support Structure Information Form in preparation for requesting assistance. The effectiveness of the assistance will depend largely on the information that you provide.

These four steps are illustrated in Figure 1-1.

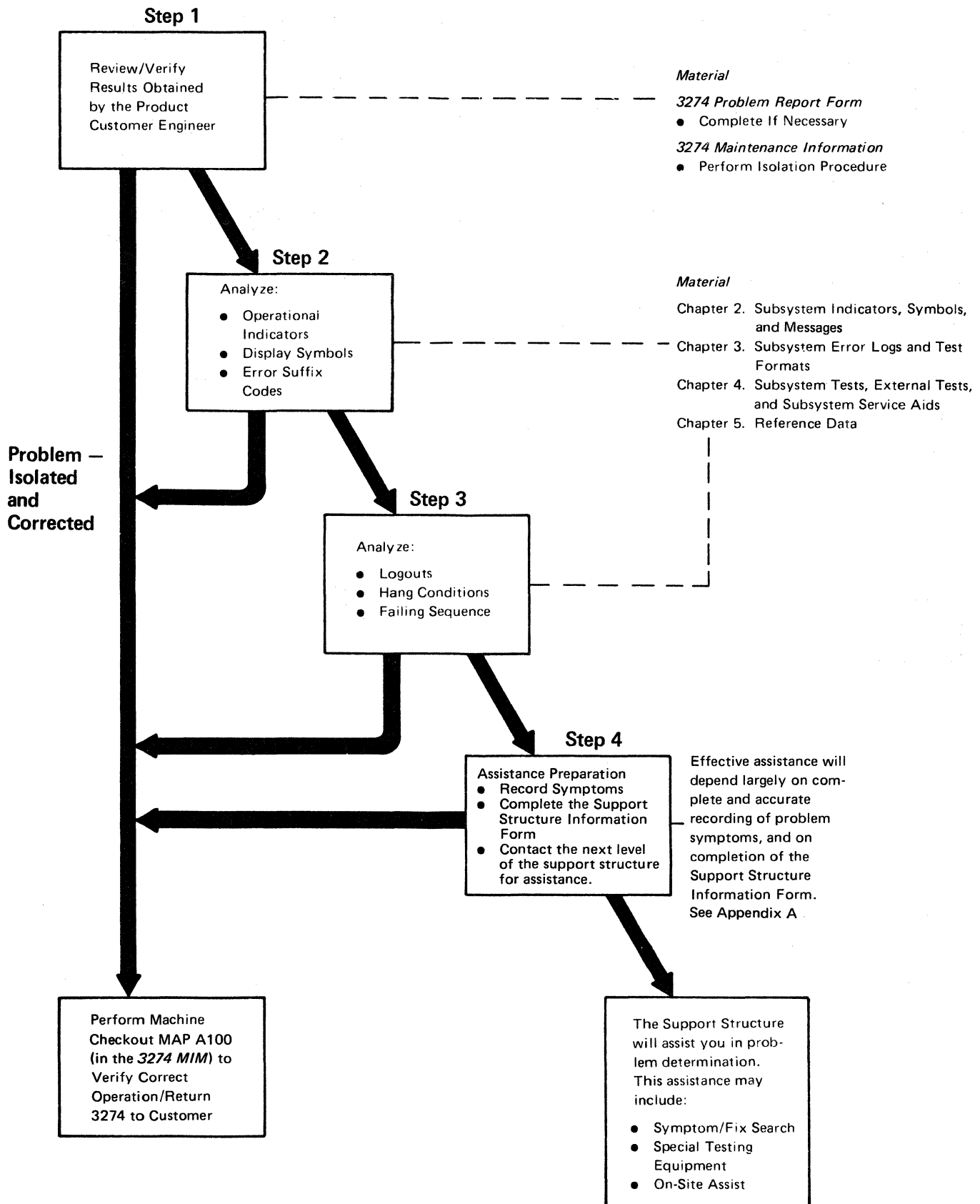

Figure 1-1. Support Customer Engineer Maintenance Approach

## 1.2 SUBSYSTEM DATA FLOW

The 3274 subsystem data flow consists of test data; control data (unit code); status, error, and log data; and message data between the components of the subsystem. Figure 1-2 illustrates the 3274 subsystem configuration, including use of the 3299 Terminal Multiplexer on the Model 61C. The data flow is described as follows:

- Initial Machine Load (IML) of Test Data – Loading the IML test data residing on the system diskette into control storage (paragraph 1.2.1 and Figure 1-3).
- Initial Machine Load (IML) of Unit Code – Loading the unit code residing on the system diskette into control storage (paragraph 1.2.2 and Figure 1-3).
- Message Data Flow between 3274 Control Unit and Attached Devices – The flow of message data between the 3274 Control Unit and attached devices (paragraph 1.2.3 and Figure 1-4).
- Message Data Flow between 3274 Control Unit and Host System – The flow of message data between the 3274 Control Unit and the host system (paragraph 1.2.4 and Figure 1-5).
- Status, Error, and Log Data Flow – The flow of data from the 3274 Control Unit, the host system, and attached devices to the data control block area of control storage (paragraph 1.2.5 and Figure 1-6).

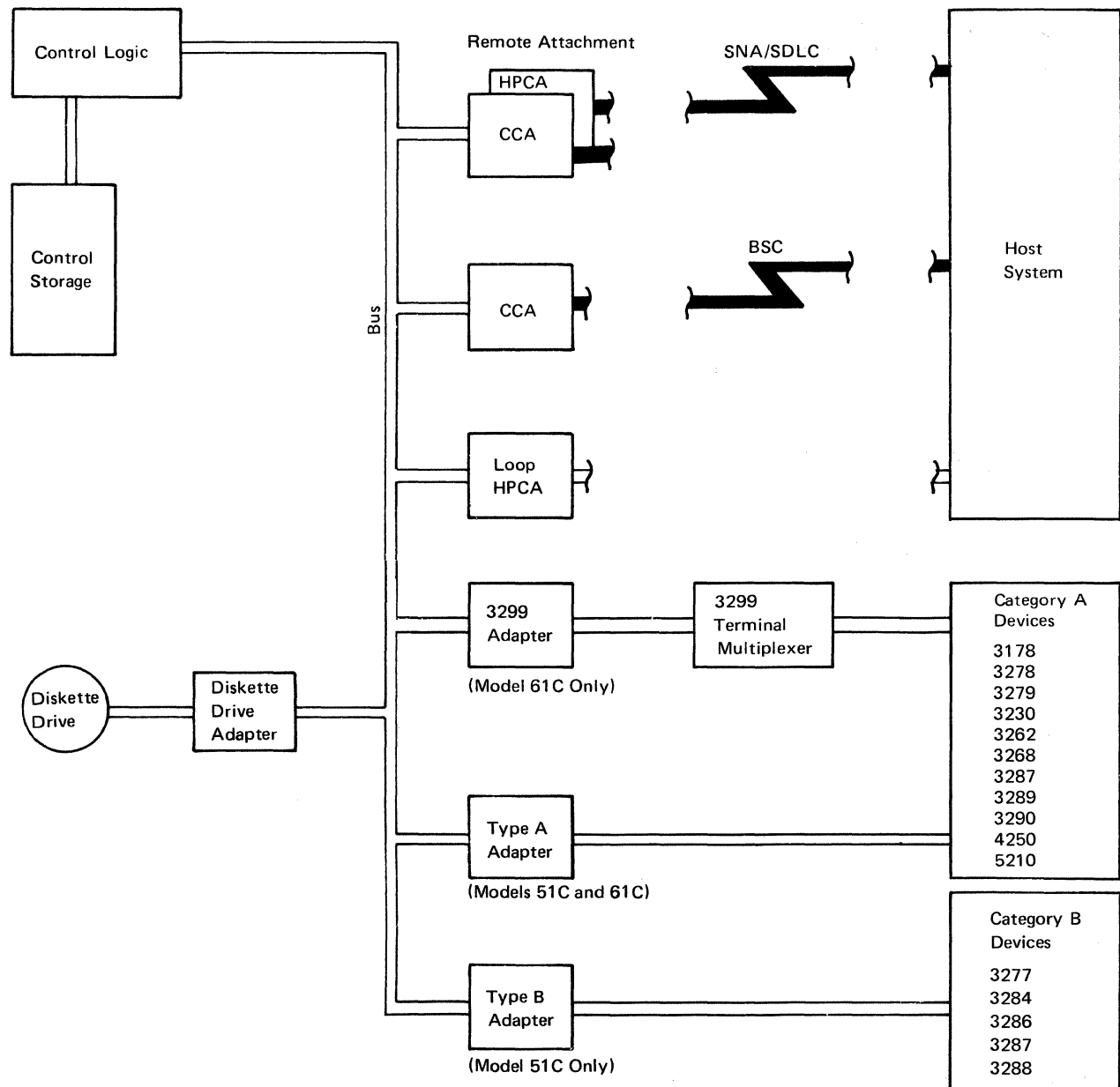

Figure 1-2. 3274 Subsystem Overview

### 1.2.1 IML Test Data Path

The IML test data path is shown in Figure 1-3. IML test data is retrieved from the diskette drive and the diskette drive adapter after IML tests 0000, 0001, and 0002 have been successfully completed. IML test 0002 verifies that the diskette drive and the adapter are functionally operational. The data path, from origin to destination, is identified as follows:

- Diskette Drive
- Diskette Drive Adapter
- Bus
- Control logic
- Control storage

### 1.2.2 IML of Unit Code

The data path of IML (loading of unit code) is the same as the IML test data path. Unit code is normally loaded after the IML tests are successfully completed. Placing the ALT switch in the ALT 1 position and pressing the IML push-button will cause the IML test to be bypassed and initiate loading of the unit code.

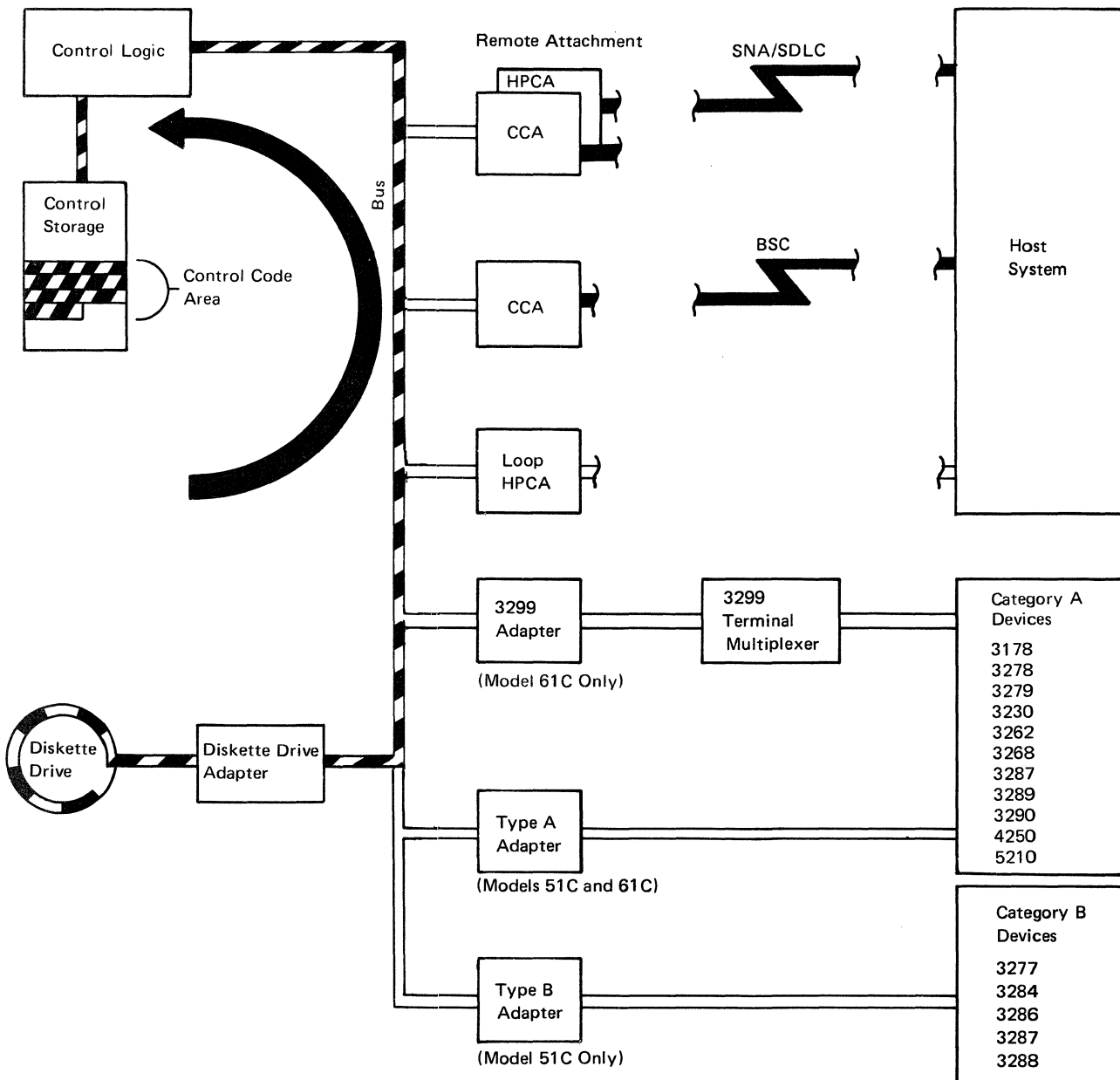

Figure 1-3. Initial Machine Load (IML) Data Flow



### 1.2.3 Message Data Flow between 3274 Control Unit and Attached Devices

Message data flow between the 3274 Control Unit and attached devices is shown in Figure 1-4. The message data paths, from origin to destination, are identified as follows:

#### 3274 Control Unit to Device

- Control storage (message buffer area)
- Control logic
- Bus
- Type A or B adapter
- Category A or B device

#### Device to 3274 Control Unit

- Category A or B device
- Type A or B adapter or 3299 Terminal Multiplexer
- Bus
- Control logic
- Control storage (message buffer area)

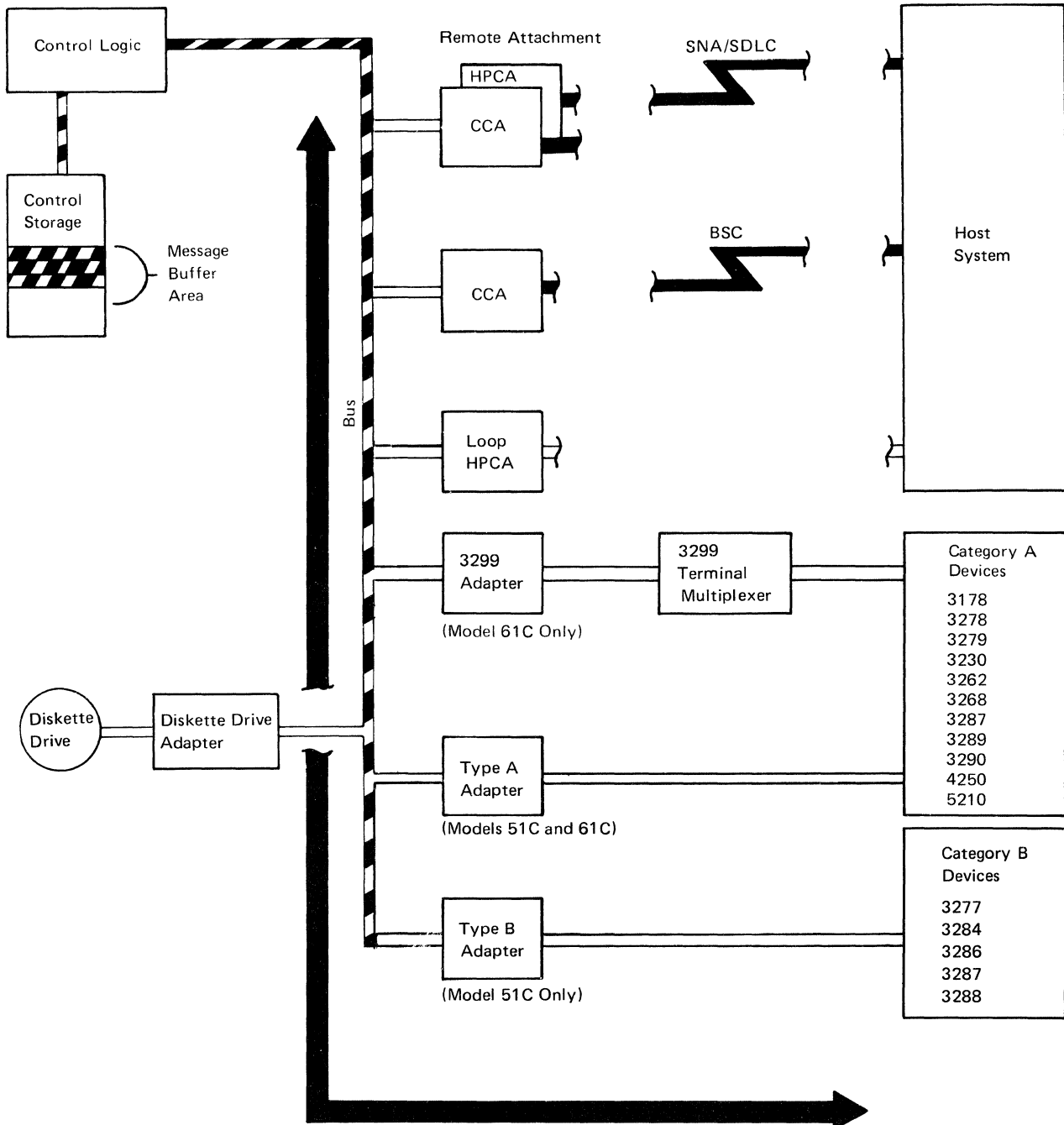

Figure 1-4. Message Data Flow between 3274 Control Unit and Attached Devices

### 1.2.4 Message Data Flow between 3274 Control Unit and Host System

Message data flow between the 3274 Control Unit and the host system is shown in Figure 1-5. The message data paths, from origin to destination, are identified as follows:

#### 3274 Control Unit to Host

- Control storage (message buffer area)
- Control logic
- Bus
- Remote host adapter/local channel attachment or local host attachment
- Host system

#### Host to 3274 Control Unit

- Host system
- Remote host adapter/local channel attachment or local host attachment
- Bus
- Control logic
- Control storage (message buffer area)

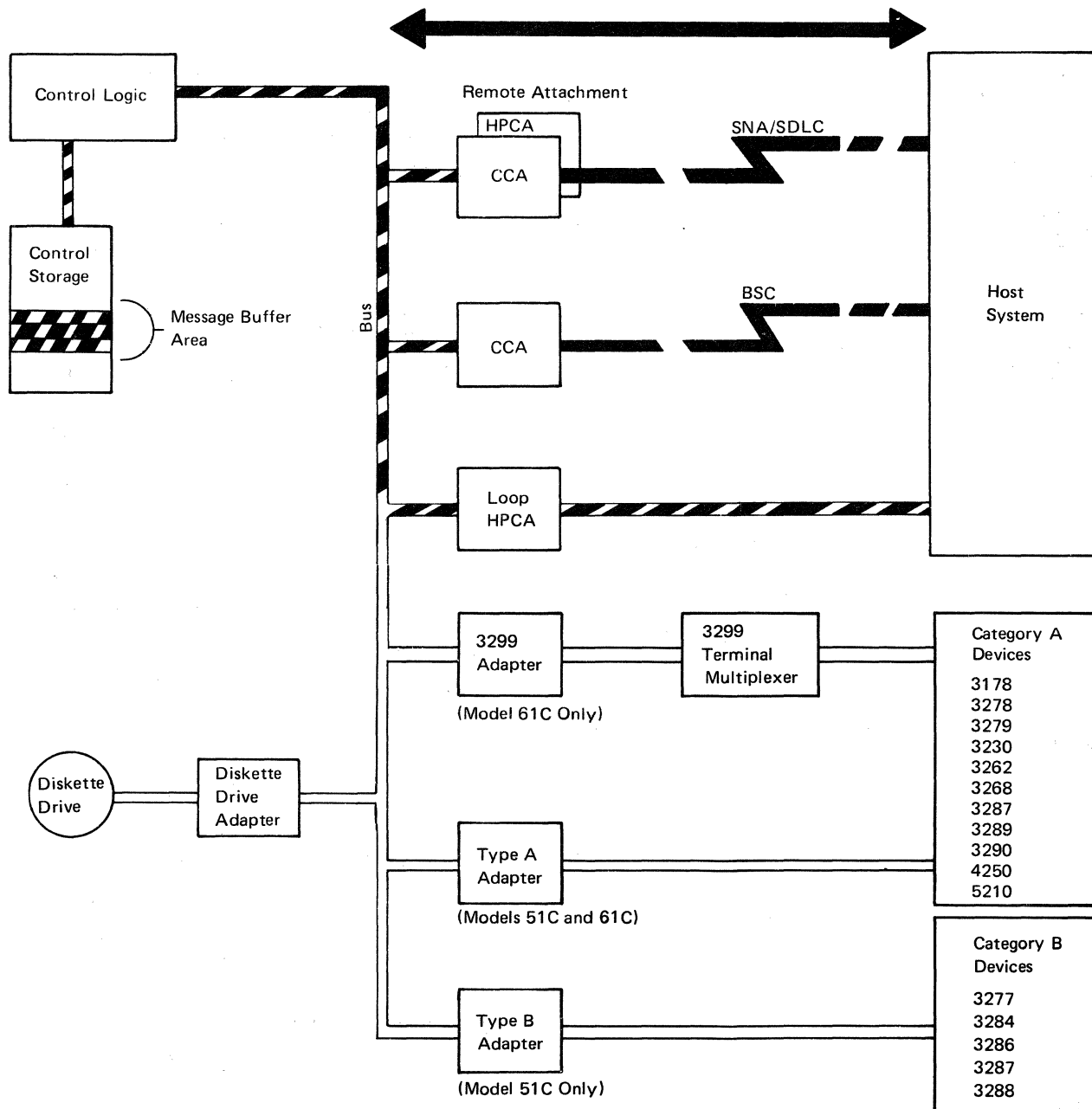

Figure 1-5. Message Data Flow between 3274 Control Unit and Host System

## 1.2.5 Logic Data Flow

Status, error, and log data flow is shown in Figure 1-6. The data paths, from origin to destination, are identified as follows:

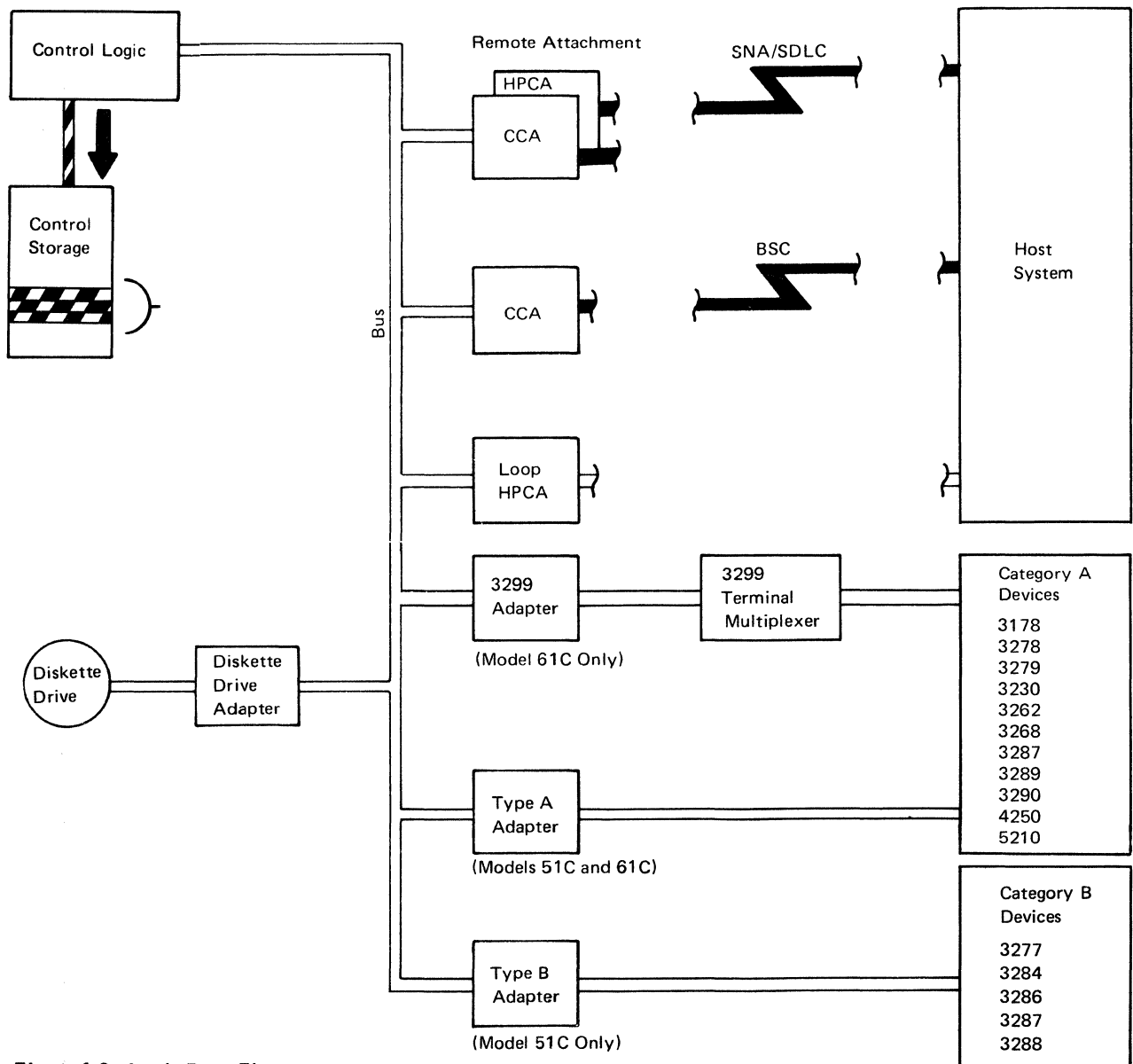
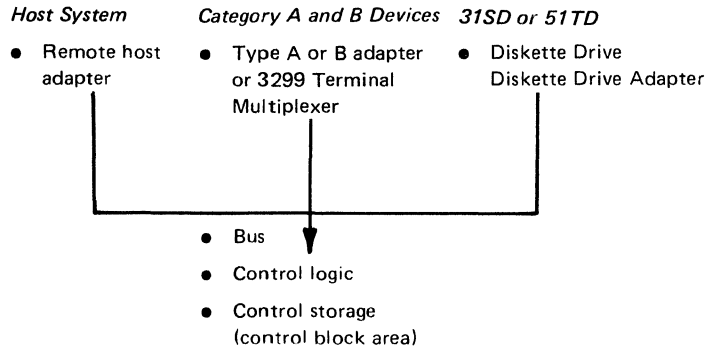

Figure 1-6. Logic Data Flow

### 1.3 SUBSYSTEM FUNCTIONS

The 3274 subsystem provides the following functions:

Function	Description
0	Machine check/program check activity
1	I/O operations to and from the host CPU
2	Diskette Drive operations
3	I/O operations to and from Category A and Category B devices (Category B devices do not attach to Model 61C)
4	Device feature functions
5	Messages sent to the host CPU
6	Messages received from the host CPU
7	Initialization (POR and IML)

To describe the 3274 unit functions in more general terms, they may be grouped into six basic categories:

- (1) Power On Reset (POR) operations,
- (2) key-tracking (moving data from the keyboard to the display screen),
- (3) receiving from the host,
- (4) sending to the host,
- (5) error handling and logging, and
- (6) internal testing.

These functions are illustrated in Figure 1-7.

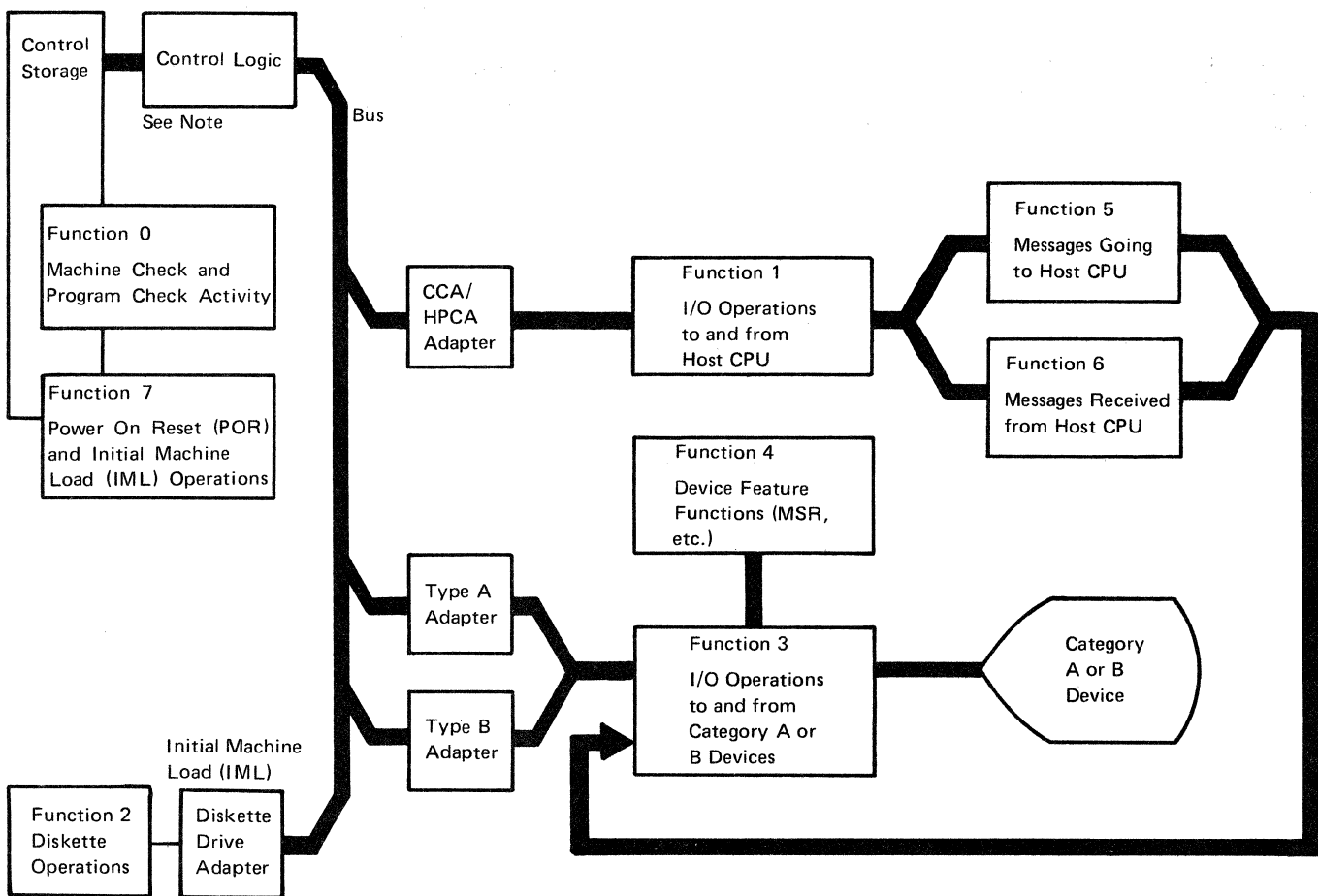

**Note:** The functions shown in this diagram are provided by the control logic.

Figure 1-7. 3274 Subsystem Functions

### 1.3.1 Control Unit Power On Reset

When the 3274 is powered on, the Power On Reset (POR) signal is generated in the power supply. The POR to the logic board generates a restart to the control logic and, subsequently, starts a normal IML sequence. If two power supplies are installed, the POR from each supply is connected to the other in the logic board. (See the *3274 Control Unit Models 51C and 52C Maintenance Information* manual, SY27-2513, or the *3274 Control Unit Model 61C Maintenance Information* manual, SY27-2555.)

### 1.3.2 Keystroke Handling

The requests and status from the attached devices are handled by the Keystroke control function. When an operator presses a key, the keyed data is read by the display base card 1, which, if it receives a poll, sends the data to the terminal adapter (Category A devices only). The terminal adapter then loads the status and scan code of the actuated key into a queue. The terminal adapter control retrieves this information from the buffer queue.

Keystroke control converts the scan code and distributes the data to the appropriate functions. See Figure 1-8 for an illustration of Type A adapter keystroke handling.

As an example of keystroke handling, when a graphic character key is pressed, the graphic key scan code is converted into internal code and then into regen code by means of a language code conversion table. The converted regen code is moved into the device regen buffer, after which the graphic character keyed may be seen displayed on the screen.

When a device is polled, if it has an error condition or request from a feature (selector pen, MSR), it sends status to the terminal adapter, and keytracking control handles the status as it does a status preceding keyed data.

An error condition detected by the device is signaled to the terminal adapter when the device is polled. Error conditions are (1) device check (a parity error was detected in the regen buffer), (2) keyboard overrun (keystrokes too close together), and (3) feature timeout (no response from the feature card within the expected time).

Special keyboard scan codes are used for the device POR signal and keyboard overrun conditions. Selector-pen data is sent to the terminal adapter by read commands. The row count is sent on the first read, and the field count is sent on the second.

To Control Logic

I/O Tags - 8 4 2 1 Indicators

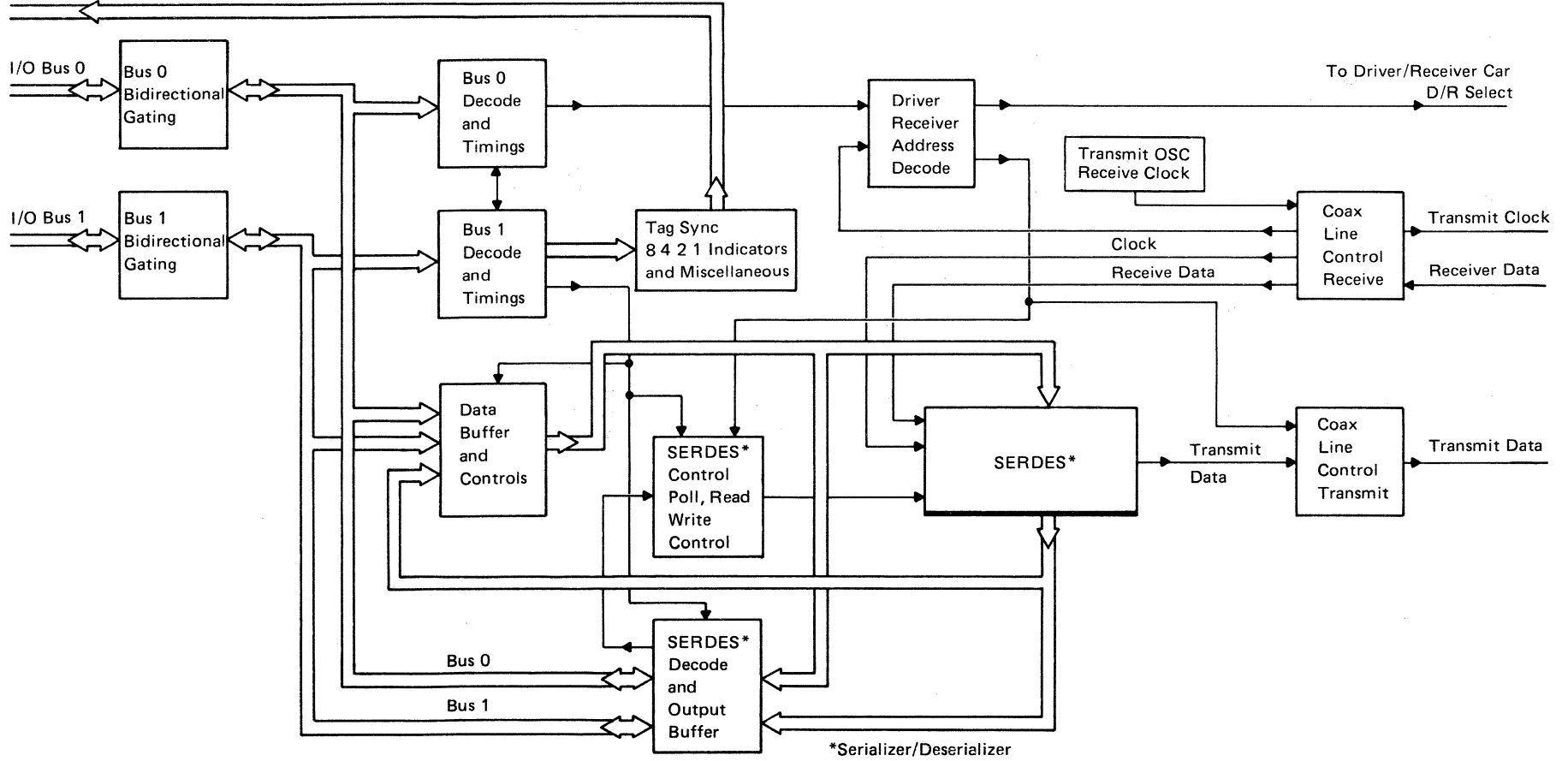

Figure 1-8. Keystroke Handling, Type A Adapter

### 1.3.3 Sending to Host

Data from Category A devices is queued via function 3 into various buffer formats, depending on the type of host attachment used, by the device control code. The data is then handled, again in queued buffer formats, by the data stream control code. The host processing control code then forwards the appropriate data from another queued buffer to the host. (See Figure 1-9.)

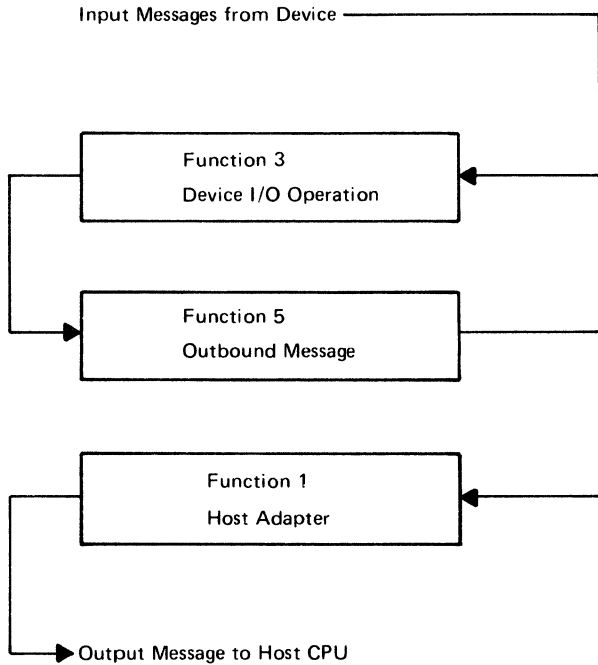

Figure 1-9. Inbound Messages

### 1.3.4 Receiving from Host

Data from the host is queued via function 1 into common transmit/receive buffers of various formats, depending on the type of host attachment used, by the host processing control code. The data is then handled in queued buffer formats by the data stream control code. The device control code then forwards the data to the device. (See Figure 1-10.)

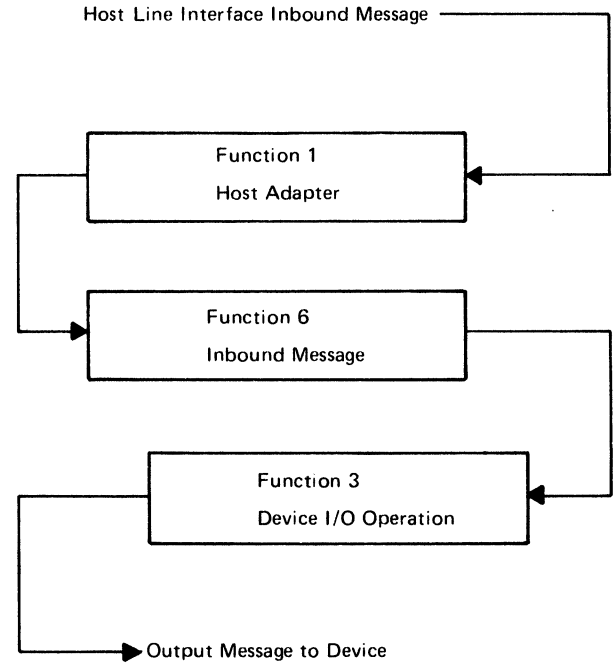

Figure 1-10. Outbound Messages

### 1.3.5 Error Handling and Logging

Error handling and logging is performed by the control logic and storage. Log statistics and information are available for each device and host adapter by means of test procedures.

### 1.3.6 Internal Testing

All internal tests are performed by the control logic, and indicators are provided for test results. Host support is not required for internal testing.

### 1.3.7 Function Priority

The priority scheme used by the 3274 subsystem is illustrated in Figure 1-11. Function 0 has the highest priority, and function 7 has the lowest priority. For example, if a machine check (function 0) and a file operation (function 2) are both pending, the 3274 control logic performs function 0 followed by function 2.

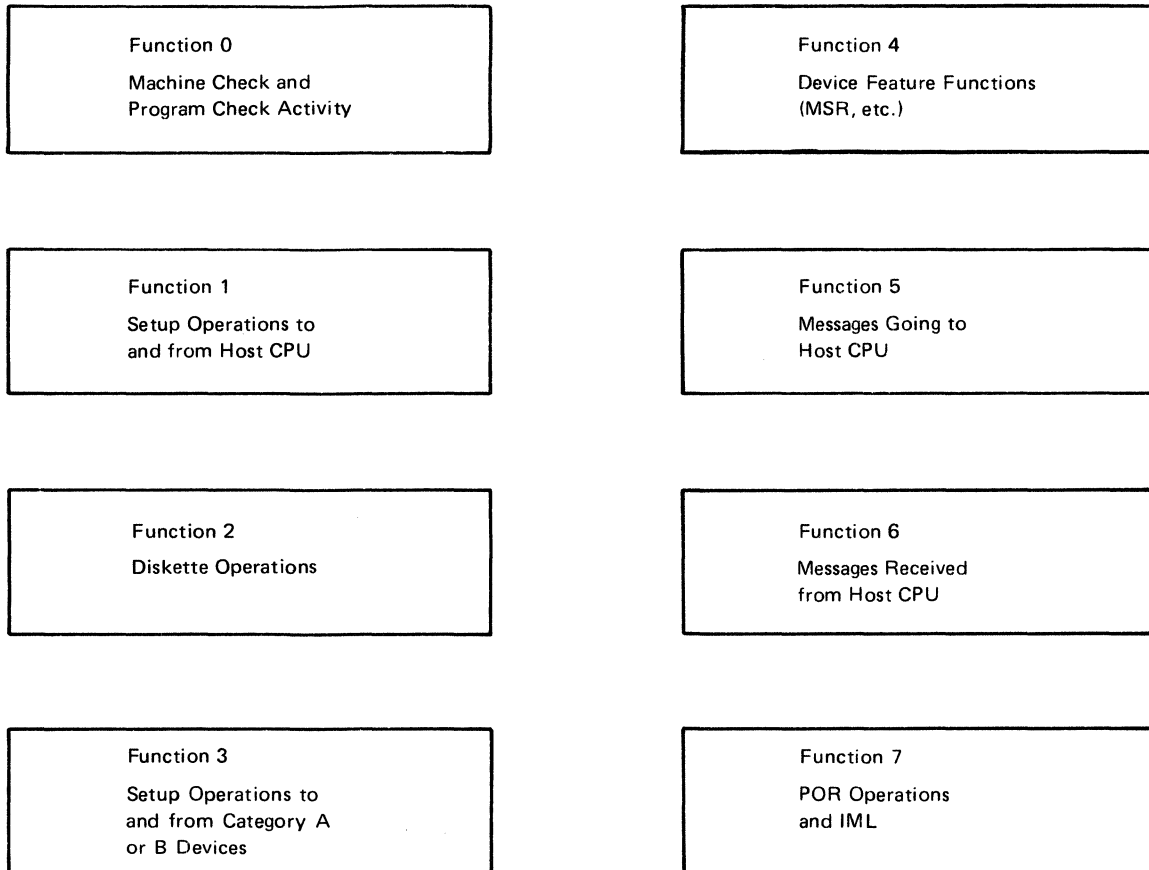

Figure 1-11. 3274 Subsystem Functional Priorities



### 1.3.8 Type A Adapter Coax Data Path

Figure 1-12 illustrates the bit path from the coax to the Type A adapter.

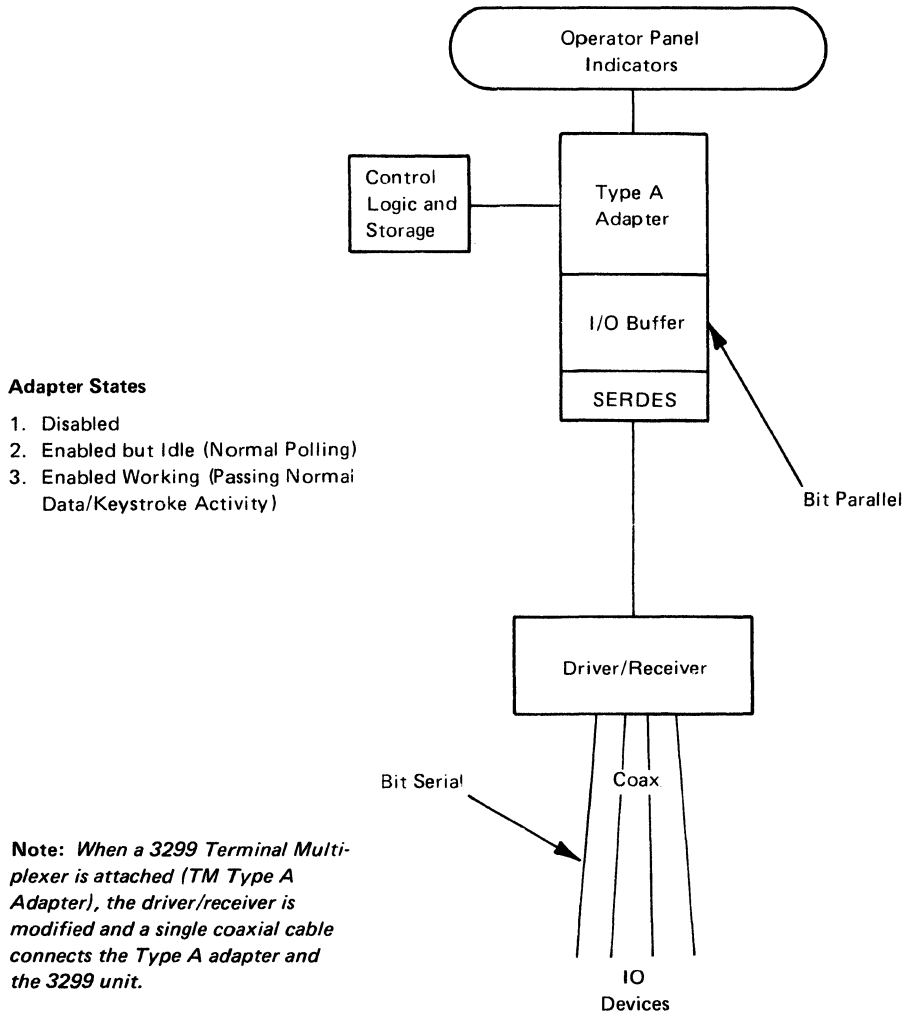

Figure 1-12. Coax to Type A Adapter Data Flow

## 1.4 SUPPORTING PUBLICATIONS

The following publications should be available for reference.

- System Description  
*3274 Control Unit Description and Programmer's Guide, GA23-0061*
- Customizing  
*3274 Control Unit Planning, Setup, and Customizing Guide, GA27-2827*  
*3274 Control Unit Customizing Guide, GA23-0065*
- Maintenance  
*3274 Control Unit Models 51C and 52C Maintenance Information, SY27-2513*  
*3274 Control Unit Model 61C Maintenance Information, SY27-2555*
- Setup  
*3274 Control Unit Model 51C/61C Setup Instructions, GA23-0047*
- Quick Reference  
*3274 Subsystem Customer Engineering Reference Summary, SX23-0207*

# Chapter 2. Subsystem Indicators, Symbols, and Messages

## 2.1 INTRODUCTION

This chapter provides information concerning the operator panel indicators and the 3278 display symbols and messages used to convey error and subsystem status conditions to the user and the customer engineer. The operator panel indicators include the 8 4 2 1 indicators and the Power On/Off indicator.

The subsystem symbols and messages displayed on the 3278 status line include the Readiness and System Connection symbols, Do Not Enter messages, Communication Reminders, Shifts and Modes symbols, Printer Status messages, and Machine, Program, and Communication Check numbers. The functional details of each item are described.

## 2.2 8 4 2 1 INDICATORS

The four indicators labeled 8 4 2 1 (Figure 2-1) are located on the operator panel. They are activated by the control logic to serve as prompting, progress, and/or success/failure indicators during the following operations:

- **IML Bus Test:** All four indicators are turned on by the IML pushbutton via the control logic and the Type A adapter card No. 12 (Model 51C or 52C) or card location S2 (Model 61C) if there is no activity on the internal logic bus.
- **IML Tests:** As the test routines are run, the control logic turns on and turns off each of the four indicators. A failure condition is indicated by a constant or flashing

code displayed in the 8 4 2 1 indicators. The success of a given test is indicated by the 8 4 2 1 indicators progressing on the next hexadecimal value.

- **Operational Mode:** During online operations with the host CPU, the 8 4 2 1 indicators are turned on by the control logic when an error condition is detected by the control logic. Hexadecimal values are used to indicate the most likely failing component. If additional errors are detected the control logic writes over the prior indication with the new hexadecimal value. The indicators turned on by the control logic may represent recoverable errors or nonrecoverable errors. The error remains displayed in the 8 4 2 1 indicators until the machine is powered off or until the IML pushbutton is pressed.
- **Customizing Mode:** During customizing, the 8 4 2 1 indicators display the type of customizing operation in progress, as well as serving as progress and procedural-failure indicators. They also prompt the user to change diskettes during customizing and notify the user when customizing is completed.

## 2.3 POWER ON/OFF INDICATOR

The Power On/Off indicator is located on the operator panel PC board. It is turned on by +5 Vdc from the logic board. When the machine has two power supplies, approximately half of the card sockets receive voltage from a particular supply. The Power On indicator will not light unless both supplies are active.

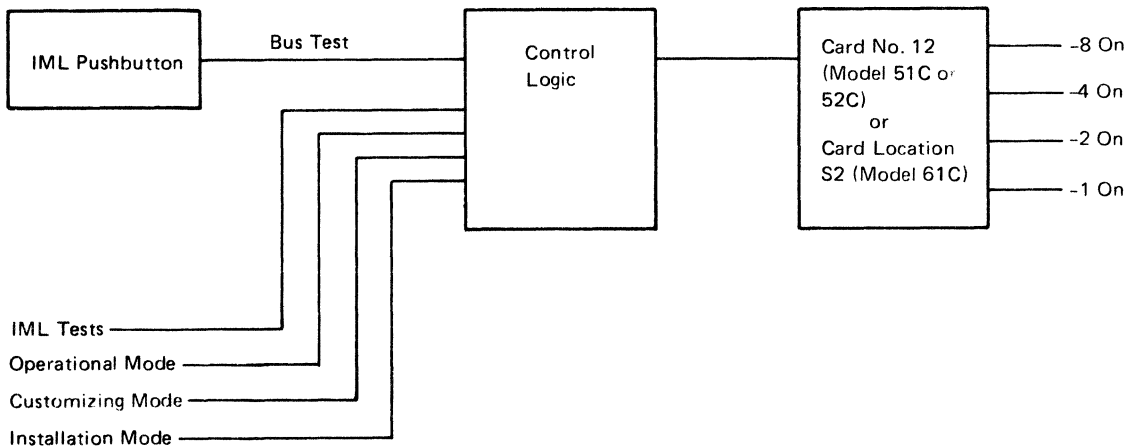

Figure 2-1. 8 4 2 1 Indicator Control Logic

## 2.4 OPERATOR INFORMATION AREA LAYOUT

The operator information area consists of individual fields located below the 3178/3278/3279 status line. These fields are not displayed on any category B device (3277). The field names and lengths are shown in figures 2-2 and 2-3.



### Notes:

1. If you are operating a device other than a 3178, 3278, or 3279 and a symbol is displayed other than the symbols defined in the following figures, consult documentation for that specific device.
2. The X.25 indicators defined in this chapter will not be displayed in the Operator Information Area of the 3290 or other variable function devices.

### 2.4.1 Readiness and System Connection Symbols

The first seven positions of the status line are allocated to Subsystem Ready, Host Ready, Application Ready, and Test. See Figure 2-4.

### 2.4.2 Do Not Enter (Input Inhibited) Symbols

The symbols shown in Figure 2-5 appear in positions 9 through 17 of the operator information area. Most of these symbols indicate an operator error. However, there are three categories of Do Not Enter symbols that are directly related to hardware or program failures: machine checks (X ) , program checks (X PROG), and communication checks (X ). Each of these symbols is accompanied by a 3-digit code that further defines the error. The codes are defined in paragraphs 2.4.6, 2.4.7, and 2.4.8.

All the Do Not Enter symbols are shown in Figure 2-4. All the symbols contain an X in position 9 (do not enter), combined with other symbols in positions 11 through 17, which define why input is disabled. The keyboard does not lock, but a change in state of the keyboard clicker (on-to-off or off-to-on) indicates that the keyboard is disabled. The symbols are arranged in descending order of assigned priority. In case of multiple conditions, the higher-priority symbol is displayed.

Readiness and System Connection		Do Not Enter (Input Inhibited)		Reminders		Shifts and Modes		Printer Status	
1	7	9	17	21	27	32	41	60	64

Figure 2-2. Operator Information Area Layout (without Extended Data Stream)

Readiness and System Connection		Do Not Enter Input Inhibited		Reminders		Programmed Symbols		Shifts & Modes		Extended Highlighting		Extended Color		Insert Mode		Printer Status	
1	7	9	17	21	27	31	34	36	44	46	47	49	50	52		60	64

Figure 2-3. Operator Information Area Layout (with Extended Data Stream)

Symbol	Name	Explanation
<b>4</b>	3274 Ready	1 of the operator information area when the 3274 <b>4</b> Control Unit to which the display is attached is ready (functional) and the display is ready.
<u>A</u> <u>B</u>	Online A Online B	The Online <u>A</u> and Online <u>B</u> symbols govern transactions with the host system. Certain keyboard functions and the meaning of some operator information area symbols differ depending upon which set of rules is applicable.  <u>Online A.</u> The control unit is connected to the system under A rules. The <u>A</u> symbol appears in remote systems using BSC protocol. It is turned on by receipt of the following commands: Write, Erase/Write, Erase All Unprotected, Copy, Read Modified, and Read Buffer.  The <u>A</u> symbol is turned off when <ol style="list-style-type: none"> <li>1. An operator action causes host communication.</li> <li>2. The display station is turned off.</li> <li>3. The Normal/Test switch is placed in Test, or the TEST key is pressed to place the 3274 in Test mode.</li> </ol> <u>Online B.</u> The control unit is connected to the system under B rules. The <u>B</u> symbol appears in systems that use SNA protocol. It is turned on by completion of an ACTPU/ACTLU command sequence, and is turned off by execution of DACTPU or DACTLU, including an internal DACTPU sequence, and when the Normal/Test switch is placed in Test or the TEST key is pressed.

Figure 2-4 (Part 1 of 2). Readiness and System Connection Symbols (Locations 1 through 7)



Symbol	Name	Explanation
	My Job	The display station is connected to the operator's application program. This symbol is displayed in position 3. This symbol appears in systems that use BSC or SNA protocol. In systems using BSC, it is turned on with the A symbol, and is turned off when power is removed, and when the Normal/Test switch is placed in Test. When using SNA protocol, it is turned on when the operator's application session owns the screen.
	System Operator	This symbol is used with SNA protocol and indicates that the system operator (SSCP Control Program) session owns the display screen. Except for the ENTER key, the Program Attention keys are not functional when this symbol is displayed.
	Unowned	The display station is connected to the system (using SNA only), but not to the operator's application program or to the system operator (control program). The SYS REQ key is used if LOGON is required. This symbol is displayed in position 3.
TEST	Test	The display station is in Test mode. Test mode is initiated or terminated by pressing the TEST key while holding the ALT key. TEST is displayed in positions 3 through 6. Test procedures are described in the <i>IBM 3270 Information Display System: 3278 Display Station Problem Determination Guide</i> , GA27-2839.
N (appears in column 7)	In-use indicator (X.21, X.25 only)	Data transfer is taking place between the 3274 control unit and the host. The In-use indicator is displayed on all attached 3178, 3278, and 3279 displays, when the control unit has entered the data transfer state.  The disconnect key (>DISC) is the only key honored in the data transfer state. Pressing the >DISC key disconnects the line and causes the "Disconnect In Process" indicator to be displayed followed by the "Call Ready" indicator when the disconnect process is complete. Both Disconnect in Process and Call Ready are "Reminders" that are defined later in this Chapter.

Figure 2-4 (Part 2 of 2). Readiness and System Connection Symbols (Locations 1 through 7)





Symbol	Name	Explanation
	Security Key	The security key is turned off, and no operator input can be accepted. When the key is turned on, this symbol disappears, but any other preexisting "do not enter" condition may then be displayed.
	Machine Check	The display station is not working properly. The symbol is accompanied by up to three digits, nnn (3278), which define the probable cause of the problem. Recovery procedures depend upon the type of error.
	Unavailable	The control unit is not equipped to handle a feature that has been invoked. RESET should be pressed and another action initiated. (See Appendix B.)
	Communication Check	A communication link error was detected and data cannot be sent. The RESET key should be pressed. This symbol is accompanied by up to three digits, nnn (3278), which define the probable cause of the problem. The communication reminder symbol is displayed as long as the condition exists.
	Program Check	A programming error was detected in the data received by the control unit. RESET should be pressed, and the operation should be retried. This symbol is accompanied by up to three digits which define the probable cause of the problem.

Figure 2-5 (Part 1 of 3). Do Not Enter Symbols (Locations 9 through 17)

Symbol	Name	Explanation
X 𐀀?	Questionable Card	The wrong magnetic stripe card was used with the MSR. RESET should be pressed, and the correct MSR card should be used.
X 𐀁	Operator Unauthorized	The operator has attempted to perform an unauthorized function. RESET should be pressed to restore the keyboard. The printer status area (location 60 through 64) should be checked for printer assignment. If the Operator Unauthorized symbol was displayed after the print key or IDENT key was pressed, a printer is not assigned. (If the Printer Assignment symbol is displayed in the printer status area, there is an error in the authorization matrix.) If the Operator Unauthorized symbol was displayed after the IDENT key was pressed and two numbers were entered, the operator is not authorized to use the printer.  Also, this symbol will be displayed instead of a printer status symbol if no device has been powered-on, on an authorized printer port, since the 3274 unit was IML'ed.
X 𐀂'+?	Accent Plus What	These symbols indicate that an invalid dead key/character combination was entered (keyboards for languages requiring accents only). RESET should be pressed to restore the keyboard, and a valid dead key/character combination should be entered.
X 𐀃'+?		
X 𐀄'+?		
X 𐀅'+?		
X 𐀆'+?		
X ←𐀇→	Go Elsewhere	An action has been attempted that is invalid for the display screen location. RESET should be pressed, and either the cursor should be moved or some other action should be taken.
X 𐀈	Message Received	A message from the control operator was received and rejected. RESET should be pressed to restore the keyboard. The operator may view the message by pressing SYS REQ or may defer viewing of the message until a later time.
X SYSTEM	System Lock	The system has disabled the keyboard following an entry. The operator should look for a message and then press RESET to restore the keyboard.
X ?+	What (Try Again)	The last input was not accepted. The screen should be rechecked, and the operation should be retried as follows:  1. Do not key while the X is displayed. 2. If ALT, or a shift key, was used, press the key again; then press RESET and retry the operation. 3. If ALT, or a shift key, was not used, press RESET and retry the operation.
X 𐀉	Printer Not Working	The printer assigned to the display station is not functioning. If this symbol appears after the Print key has been pressed, the print request is canceled, and the DEV CNCL key should be pressed to restore the keyboard. If the Printer Failure symbol is displayed in the printer status areas, the printer stopped during the last print operation. DEV CNCL should be pressed to restore the keyboard and to instruct the control unit to stop monitoring the operations of the printer that stopped.
X 𐀊	Printer Busy	The printer assigned to the display station is busy. If the Printer Printing symbol is displayed in the printer status area, the printer is printing. The operator may wait for the printer operation to complete, or he may press the DEV CNCL key. If the print key was used, it may be possible to select another printer.
X 𐀋	Printer Very Busy	This symbol means the same as Device Busy, except that more time than usual is anticipated before the print request is accepted.
X 𐀌	Time	Time is required for the system to perform a function.
X -S	Minus Symbol	The symbol you keyed is not available. The RESET key should be pressed to restore the keyboard.
X -f	Minus Function	A currently unavailable function was requested. RESET should be pressed to restore the keyboard.
X -f 𐀍	Minus Function	Operator Unauthorized.
X 𐀎>	More Than	An attempt was made to enter more information into a field than can be entered. RESET should be pressed to restore the keyboard, and the operation should be retried and the entry corrected.

Figure 2-5 (Part 2 of 3). Do Not Enter Symbols (Locations 9 through 17)

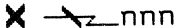
Symbol	Name	Explanation
X 人#?	What Number	A numeral was entered that is unacceptable at the display screen location. RESET should be pressed to restore the keyboard, and the correct entry should be made.
X 人NUM	Numeric	A nonnumeric entry was made at a display screen location reserved for numeric information. RESET should be pressed to restore the keyboard, and the operation should be retried.
X 人 —	Operator Communication Check (X.21, X.25 only)	The operator has requested a function that is currently prohibited. See Appendix C (X.21) or Appendix D (X.25).

Figure 2-5 (Part 3 of 3). Do Not Enter Symbols (Locations 9 through 17)

### 2.4.3 Reminder Symbols

Most of the symbols described herein refer to the X.21 only. Refer to Appendix C for a more detailed description of the X.21 symbols.

#### 2.4.3.1 Communication Reminder Symbols

The communication reminders (Figure 2-6) is turned on and broadcast to all active Category A displays when the 3274 detects a failure in the local or remote communication

path to the host system. The reminder will remain on until the failure condition has been cleared and the 3274 detects the cleared condition. When the reminder is broadcast to all displays, all retry activity has stopped. When a bi-synchronous line error has been detected, the original contents of the screen are restored. The reminder then remains on the screen of the display affected until cleared by host-system recovery activity.

Symbol	Name	Explanation
— 人 nnn	Communication Reminder	The communication link connecting the control unit to the system is not functioning. This symbol is displayed with the Communication Check symbol.
— 人 XCCDD (See Note)	X.25 Communication Reminder Codes	The communication link is not functioning for reason indicated by XCCDD (defined below).
— 人	Reserved	This symbol is reserved for future use and should be ignored if it is displayed.
— 人 :ss.s	Response Time Monitor Indicator	Response Time Monitor Last Transaction Time; rounded to nearest 10th second.
— 人 mm:ss	Response Time Monitor Indicator	Response Time Monitor Last Transaction Time; rounded to nearest second.
— 人 :	Response Time Monitor Indicator	Response Time Monitor Last Transaction Time indicator when local display not enabled.
— 人	Call Ready (X.21, X.25 only)	The 3274 is in X.21/X.25 Ready State. Dial operations or an incoming call may be accepted.
— 人 Nnn	Call Ready with Call Progress Signal (X.21 only)	A call has been placed but the connection has not been completed for the reason indicated by nn. See Appendix C, Figure C-5 for nn code interpretation.
— 人 XCCDD (See Note)	X.25 Call Ready with cause and Diagnostic Codes	A call has been placed but the connection has not been completed for the reason indicated by XCCDD (defined below).
— 人 #?	Dial-In (X.21, X.25 only)	The "DIAL" key has been pressed and the control unit is waiting for the operator to key in the dial information.  — 人 ## is displayed at the other terminals connected to the same control unit as the originating terminal.
— 人	Outgoing Call in Process (X.21, X.25 only)	The "Enter" key has been pressed after keying in the "dial" digits.
— 人 Nnn	Outgoing Call in Process with Call Progress Signal (X.21 only)	An outgoing call is in process and connection has not been made for the reason indicated by nn. See Appendix C, Figure C-5 for nn code interpretation. If the connection cannot be made the control unit returns to "ready" state and the Call Ready with Progress Signal indicator is displayed.

Figure 2-6 (Part 1 of 2). Reminders (Locations 21 through 27)

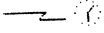
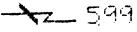
Symbol	Name	Explanation
	Incoming Call in Progress (X.21, X.25 only)	The 3274 has been addressed by the network and is processing an incoming call. When the connection is completed the "Incoming Call" in Process indicator is turned off and the "In-use" indicator (N) is displayed in location 7.
	Disconnect in Process (X.21, X.25 only)	The ► DISC* key has been pressed or a disconnect command or a timeout condition caused the connection to be broken.
	Local (X.21, X.25 only)	The ► LOCAL* key has been pressed. The control unit is offline to the network. Incoming and outgoing calls are inhibited. The control unit can be restored to "ready" state by pressing the ► Comm* key.

\*This is the X.21 or X.25 modified key on the display keyboard.

**Note:** *XCCDD* are defined as follows:

*X* This field may have the following values and meanings:

*P* = The 3274 received a clear packet.

*Q* = The 3274 received a reset packet.

*R* = The 3274 received a restart packet.

*L* = The 3274 sent a clear packet.

*M* = The 3274 sent a reset packet.

*N* = The 3274 sent a restart packet.

*CC* = Cause code (Figure 2-13) received when *X* = *P*, *Q*, or *R*.

= Diagnostic code modifier (Figure 2-12) when *X* = *L*. The diagnostic code modifier is supplied by the 3274 to give additional problem determination information about why the 3274 rejected an incoming call. This modifier is displayed and logged but is not included in the clear packet sent by the 3274.

*DD* = Diagnostic code (Figures 2-14, 2-15) sent or received.

Figure 2-6 (Part 2 of 2). Reminders (Locations 21 through 27)

#### 2.4.4 Programmed Symbols

The symbol set indicators (Figure 2-7), location 31 through 33, show the symbol set that will be addressed for a displayable character or symbol in response to the next

character entered at the keyboard. A supplementary indicator in location 34 is present if the application program allows the operator to select a PS character attribute for character positions in the current field.

Symbol	Name	Explanation
S0	Base character set	The base character set is addressed for a displayable character when the operator presses a character key.
PSA through PSF	Symbol set A through symbol set F	The EBCDIC code for characters entered at the keyboard will be used to address the indicated symbol set for a displayable character.

**Supplementary Indicator:**



The current character set or symbol set was selected by the operator.



The current character set or symbol set is determined by the extended field attribute; either (1) operator selection is allowed, but no selection has been made, or (2) the operator has selected field inherit.

Figure 2-7. Programmed Symbols (Locations 31 through 34)

#### 2.4.5 Shifts and Modes Symbols

There are six Shifts and Modes symbols (Figure 2.8). The Upshift key may be used to determine if the Type A adapter is still polling a display internally when the remainder of the keyboard may be locked up. (The adapter is disabled if the arrow (  ) will not display.)

If the extended data stream feature is installed locations 36 through 44 and location 52 for the insert (  ) are used. If the extended data stream feature is *not* installed locations 32 through 41 are used.



Symbol	Name	Explanation
APL	APL Mode	
TEXT	Text Mode	
NUM	Numeric	The keyboard is in numeric shifts, which allows use of the 0 through 9 keys and the (.), (-), and DUP keys only.
↑	Upshift	The keyboard is in Upshift.
^	Insert	The keyboard is in Insert mode. A character may be inserted at the cursor location. Characters beyond the cursor position move to make room for the inserted characters.
▶	Extension Mode Entered	The X.21 or X.25 extension key has been pressed and the X.21 or X.25 modifier keys on the display keyboard are enabled for use. And/or the Response Time Monitor last transaction time.

**Figure 2-8. Shifts and Modes (Locations 36 through 44 and Location 52) – With Extended Data Stream; (Locations 32 through 41) – Without Extended Data Stream**

### 2.4.6 Extended Highlighting

The Extended Highlighting indicator in location 46 shows how the next character entered at the keyboard will be highlighted on the screen; any symbol in location 46 confirms that the operator is allowed to select an extended highlighting character attribute for character positions in the current field. A supplementary indicator, in location 47, is present when the application program allows the operator to select an extended highlighting character attribute.

### 2.4.7 Extended Color

The color indicator in location 49 shows the color that will be used to display the next character entered at the keyboard; any indication in location 49 confirms that the operator is allowed to select an extended color character attribute for character positions in the current field. A supplementary indicator in location 50 is present when the application program allows the operator to select an extended color character attribute.

Symbol	Name	Explanation
None		No extended highlighting.
⌘	Reverse Video	Character highlighting by reversing the light intensity between the character and its background.
⌘	Blink	Character highlighting by blinking on and off at regular intervals.
⌘	Underscore	Character highlighting by underscore.
Supplementary Indicator		
▶		The current character set or symbol sent is determined by the extended field attribute; either (1) operator selection is allowed, but no selection has been made, or (2) the operator has selected field inherit.

**Figure 2-9. Extended Highlighting (Locations 46 and 47)**

Symbol	Name	Explanation
■	Extended color	The color of the symbol is the color used to display the next character at the keyboard.
⊙	Default	The color is green or white by default.
Supplementary Indicator		
⌘		The current extended color attribute was selected by the operator.
▶		The current extended color is determined by the extended field attribute; either (1) operator selection is allowed, but no selection has been made, or (2) the operator has selected field inherit.

**Figure 2-10. Extended Color (Locations 49 and 50)**

## 2.4.8 Printer Status Messages

Printer status (Figure 2-11) messages are displayed in the operator information area layout whenever a printer has been assigned to a display requiring the use of a printer. Refer to the *3270 Information Display System: 3274 Description and Programming Guide, GA23-0061*, for detailed information regarding printer assignments, classes, and matrix structures.

## 2.4.9 Machine Check Numbers

Machine check numbers follow immediately after the machine check symbol (  ). They are divided into the following categories: Category A device and adapter errors, Category B device and adapter errors, host attachment and adapter errors, and control logic errors. The 200 series nnn machine check numbers are used for the devices and their respective adapter failures, and the 300 series nnn machine check numbers are used for host and control logic failures. For a summary of all machine check numbers, see Appendix B.

## 2.4.10 Program Check Numbers

Program check numbers follow immediately after the program check symbol ( P R O G ). Program checks are divided into three categories: SNA protocol errors, print matrix definition errors, and data stream errors. Some program check numbers are not displayed at the device, but are logged in the event log for that device. See Appendix B for a summary of the program check numbers.

## 2.4.11 Communication Check Numbers

Communication check numbers follow immediately after the communication check symbol (  ). A communication check number may represent an interruption of the communication path to a remote attached 3274. The communication check number may also represent a normal communication path condition and not a hardware failure (for example, 532 = BSC line idle). The communication check numbers are directly related to the type of host adapter being used. The meaning of the nnn number may change from adapter to adapter. See Appendix B for a summary of the communication check numbers.







Symbol	Name	Explanation
	Assign Printer	When changing the printer IDENT, the two numbers entered (   ) appear in the printer authorization matrix.
	Printer Assignment	The display station is authorized to use printer number nn. Individual printers may be assigned 01 through 31. Printer "class" is designated by 70 through 80.
	Printer Printing	The printer identified by nn is printing.
	Printer Failure	The printer identified by nn has stopped while printing.
	What Printer	The printer IDENT has changed. Pressing the IDENT key causes display of a new printer assignment.
(Nothing Displayed)		If the display is attached to a 3274 (4 displayed in location 1), printing cannot take place.

Figure 2-11. Printer Status (Locations 60 through 64)

Diagnostic Code Modifier	Reason
00	No additional information is provided. See Diagnostic Code.
01	Calling DTE address is expected but none is included.
02	Calling DTE address does not match customized value.
03	Facilities other than RPOA are included when customizing indicates that none is expected.
04	Reserved
05*	Packet facility is included but is not customized.
06	Incoming CUG does not match customized value.
07	Call requests reverse charging but function is not customized.
08	Call requests reverse charging not requested but function is not customized.
09*	Call included window size facility but window size facility is not customized.
10	CID is to be validated but none is included in Call Request packet.
11	CID is included but does not match customized value.
12	Protocol ID is not included.
13	Protocol ID is not incorrect.
14	CUG facility is customized but is not included in Call Request packet.
15	Call includes throughput class facility but function is not customized.
16	Reserved
17	Call does not include reverse charging facility when customization indicates that it should.

\*Customized = either customized value or value entered via Dial screen.

**Note:** These modifiers show up on X.25 Communication Check, only – Do not appear in CLEAR REQUEST packets.

**Figure 2-12. Diagnostic Code Modifiers**

CLEAR Indication Packet	Hex Code
DTE originated*	00
Number busy	01
Out of order	09
Remote procedure error	11
Reverse charging acceptance not subscribed	19
Incompatible destination	21
Fast select acceptance not subscribed	29
Invalid facility request	03
Access barred	0B
Local procedure error	13
Network congestion	05
Not obtainable	0D
RPOA out of order	15

RESET Indication Packet	Hex Code
DTE originated*	00
Out of order†	01
Remote procedure error	03
Local procedure error	05
Network congestion	07
Remote DTE operational†	09
Network operational+	0F
Incompatible destination	11

RESTART Indication Packet	Hex Code
Local procedure error	01
Network congestion	03
Network operational	07

\*When the cause field is X'00', the diagnostic code field has been passed through the network from the remote DTE's original Clear Request, Reset Request, or Restart Request packet. The diagnostic code is then as listed in Figure 2-15 provided the remote DTE is an IBM (SNA) DTE.

†Applicable to permanent virtual circuits only.

**Note:** These codes may not apply or be common to all networks.

**Figure 2-13. Cause Codes (Use Field Received from the DCE)**

Diagnostic Code Field	Hex Code
No additional information	00
Invalid P(S)	01
Invalid P(R)	02
Packet type invalid – general	10
For state: R1	11
R2	12
R3	13
P1	14
P2	15
P3	16
P4	17
P5	18
P6	19
P7	1A
D1	1B
D2	1C
D3	1D
Packet not allowed – general	20
Unidentifiable	21
Call on one-way logical channel	22
Invalid packet type on PVC	23
Packet on unassigned logical channel	24
Reject not subscribed to	25
Packet too short	26
Packet too long	27
Invalid GFI	28
Restart with non-zero GFI	29
Packet type incompatible with facility	2A
Unauthorized interrupt confirmation	2B
Unauthorized interrupt	2C
Timer expired – general	30
Incoming call	31
Clear indication	32
Reset indication	33
Restart indication	34
Call setup problem – general	40
Facility code not allowed	41
Facility parameter not allowed	42
Invalid called-address	43
Invalid calling-address	44
Call clearing problem – general	50
Non-zero address lengths field	51
Non-zero facility lengths field	52

**Note:** These codes may not apply or be common to all networks.

**Figure 2-14. Diagnostic Code Fields Received from the DCE**

Diagnostic Code Field	Hex Code
Normal initialization or termination	00
Invalid LLC type	0C
Invalid packet type – general	10
For state: R1	11
R2	12
R3	13
P1	14
P2	15
P3	16
P4	17
P5	18
P6	19
P7	1A
D1	1B
D2	1C
D3	1D
DCE timer expired – general	20
Incoming call	21
Clear indication	22
Reset indication	23
Restart indication	24
DTE timer expired – general	30
Call request	31
Clear request	32
Reset request	33
Restart request	34
QLLC error – general	50
Undefined C-field	51
Unexpected C-field	52
Missing I-field	53
Undefined I-field	54
I-field too long	55
QFRMR received	56
Invalid QLLC header	57
Data received in non-data state	58
Timeout condition	59
PSH error – general	60
Sequence error	61
PS header too short	62
PSH format invalid	63
Command undefined	64
Invalid PSH protocol	65
Data received in non-data state	66
Timeout condition	69
Packet not allowed	A0
Invalid M-bit packet sequence	A1
Invalid packet type received	A2
Invalid packet on PVC	A3
Unassigned logical channel number	A4
Diagnostic packet received	A5
Packet too short	A6
Packet too long	A7
Invalid GFI	A8
Not identifiable	A9
Not supported	AA
Invalid P(S)	AB
Invalid P(R)	AC
Invalid 'D' bit received	AD
Invalid 'Q' bit received	AE

**Figure 2-15 (Part 1 of 2). Diagnostic Code Fields Generated by an IBM (SNA) DTE**

Diagnostic Code Field	Hex Code
CAC-specific codes	
Termination pending	C1
Channel inoperative	C2
Unauthorized interrupt confirmation	C3
Unauthorized interrupt request	C4
PVC resource not available	C5
Resources – general	
Buffers depleted	D1
PIU too long	D2
Local procedure error – general	
Packet received with LC not equal to 0	E1
Restart of Diagnostic packet received with LC not equal to 0	E2
Incoming call received on wrong LC	E3
Facility not subscribed	E4
Invalid packet for LC equal to 0	E5
Facility parameters not supported	E6
Facility not supported	E7
Unexpected calling DTE	E8
Invalid 'D' bit request	E9
Reset indication on virtual call	EA
Invalid protocol identifier	EB
Connection identifier mismatch	EC
Remote procedure error – general	
	F0

**Figure 2-15 (Part 2 of 2). Diagnostic Code Fields Generated by an IBM (SNA) DTE**



# Chapter 3. Subsystem Error Logs and Test Formats

## 3.1 INTRODUCTION

There are six basic formats for entry into the subsystem log and test facility. This concurrent test facility provides path tests between the control unit and attached devices, device error statistics, device adapter error statistics, host adapter error logs and statistics, control logic error statistics, configuration and EC data, display of the status of all configured devices, reset capability of statistical error counters, and device control block displays for all configured devices. The use of the ALT and TEST keys is necessary to enter Test mode. The concurrent test facility is available only after Test mode is entered. Following are the concurrent test and log facilities:

**Note:** *These tests cannot be invoked from a 3290.*

- Test 0 – Checks the communication path between the 3274 and its attached devices. Also provides functional testing of Category A devices and 4-color override switch function on a 3279.
  - /0 – Transmits a test pattern from the control unit to the display from which you requested Test 0.
  - 00 to 07/0 (52C), to 11/0 (51C), to 15/0 (61C) – Transmits a test pattern from the control unit to the specified Category A display (nn/0).
- Test 1 – Displays error statistics for displays, printers, adapters, and control logic.
  - 00 to 07/1 (52C), to 11/1 (51C), to 15/1 (61C) – Displays log of the specified device (nn/1).
  - A0/1 – Displays the host adapter/attachment log formats: CCA BSC, CCA SDLC, HPCA, LCA attachment, and LHA attachment. Only the format for the host adapter installed in your machine is displayed in response to this request.
  - A1/1 – Displays log of the Type A adapters.
  - A2/1 – Displays log of the Type B adapters, encrypt/decrypt adapter, and Model 52C volume 3 storage errors.
  - A3/1 – Displays control logic error logs.
- Test A4/1 – Display Response Time Monitor Log
  - A4/1 entered on a 3178, 3278, or 3279 terminal, displays the RTM log.
  - A5/1 – Displays error correcting code (ECC) counters (Configuration Support C only).
- Test 2 – Displays configuration information.
  - /2 – For first (hex) 40 bytes.
  - X – Enter only – second 40 bytes.

- Test 3 – Displays the status (off, on, disabled, unavailable) of all configured devices and summary errors.
  - /3 – Status of ports and summary error counters.
- Test 4 – Reset logs.
  - XX/4 – Resets specified log counter. XX has same meaning as Test 1 for example, A3/4 means reset control logic error logs.
- Test 5 – Register Page Display -/5 – Causes register page(s) to be displayed.
- Test 6 – Displays key information in device control blocks. Can also display all Logical Terminal extensions for each DCB (if any).
  - 00 to 07/6 (52C), to 11/6 (51C), to 15/6 (61C) – For first (hex) 40 bytes. You may page from one page to the next by pressing the ENTER key. Paging beyond the limit of the block will result in a locked keyboard and X-f displayed on the status line.
- Test 7 – Color Convergence.
- Test 8 – Programmed Symbols, Highlighting, and Color Test.
- Test 9 – Kanji/Chinese Character Display.
- Test /A – Generate Alert (SNA – CS “C” and “D” only)

When /A is entered on a 3178, 3278, or 3279 terminal by an authorized operator a screen is presented on the invoking display. From 1 to 20 predefined panels may be selected via this screen.
- Test B – Display Host Device Addresses - /B – Displays for each port on the controller, the port number, whether the port is available or unavailable, and the primary address associated with the port.
- Test /D – Request Intelligent Device Dump  
XX/D may be entered from a 3178, 3278, or 3279 terminal to obtain a dump for any intelligent device (XX = port number) that is attached to the same 3274 control unit that the display from which the dump is being requested is attached to.

## 3.2 TEST 0: COMMUNICATION PATH TEST AND DISPLAY TEST

### 3.2.1 Description

Test 0 performs the following functions:

- Transmits a test pattern from the control unit to the display from which you requested Test 0.

- Transmits a test pattern from the control unit to another Category A display (except 3290) as specified by you when you entered the Test 0 format message.
- Functionally tests the following using the test pattern transmitted by the control unit to the Category A display specified by you: (1) high-intensity function, (2) non-display function, (3) various key functions, (4) selector-open function, (5) MSR function, and (6) audible-alarm function.
- Executes communication path test to Category B display (3277).
- Executes communication path test to Category A or B printers.

A request for Test 0 will be executed to any Category A display except under the following conditions:

- If the device requested is in a SNA session, the test pattern function is not performed. A Do Not Enter minus-function indication is returned.
- If the device has the Wait indicator on and is busy executing a command that requires asynchronous ending status (Op Complete), a Do Not Enter minus-function indication is returned.

This test, if requested for a Category B display (3277) or Type A or B printer, only checks the continuity of the coaxial communication path. Success or failure of this test is displayed on the requesting Category A display as follows:

- The test message you entered followed by a +, -, or 0.  
+ = Test successful or path OK.  
- = Test failed, device disabled because of error  
0 = Test not run, device powered off

If no device is specified when the test is requested, an automatic default to the requesting device occurs.

### 3.2.2 Procedure for Requesting Test 0

- Press and hold ALT, and then press TEST to enter Test mode.
- Ensure the cursor is at location zero (0). Enter the following: (1) the device number you wish to test, using any two-digit number from 00 to 07(52C), to 11(51C), or to 15(61C), (2) a slash, and (3) a zero. Press the ENTER key.
- If you are testing a Category A display, the following pattern will appear on the screen if the test is successful:

```
TEST: 3274;NN
?SEL PEN      SEL PEN
  &SEL PEN    > SEL PEN
    DISPLAY  INSERT CK
```

NN = The port number of the terminal that requested the test.

- Use the appropriate *Display Station Maintenance Information* manual to run the function test with the above test pattern.
- To exit Test mode, press and hold ALT and then press TEST.
- An entry of only a slash (/) automatically defaults to Test 0 on the requesting display.

### 3.3 TEST 1: OVERVIEW

Test 1 is a variety of device and adapter error log and statistical counter information that can be displayed on any working Category A display while in Test mode. By using a two-digit prefix to the entry slash (/)1, specific device log or adapter log information can be retrieved. The formats for entering a Test 1 request are as follows:

- 00 to 07/1(52C), to 11/1(51C), to 15/1(61C) – Displays log of the specified device (nn/1).
- A0/1 – Displays three host adapter/attachment log formats: CAA BSC, CCA SDLC, and HPCA.  
Only the format for the host adapter installed in your machine is displayed in response to this request.
- A1/1 – Displays log of the Type A adapters.
- A2/1 – Displays log of the Type B adapters. For Model 52C, this test is used to isolate the Op code error of 0111.
- A3/1 – Displays control logic error log.
- A4/1 – RTM Log Display
- A5/1 – Displays ECC counts (Configuration Support C only).

**Note:** A5/4 resets all ECC counts for all volumes.

The error information contained in the above logs resides in the 3274 storage. The general format of all logs reflects: (1) the most recent error *event* information and (2) statistical counters that reflect the type of errors occurring. The event log may be a combination of significant information that will differ in content from adapter to adapter as well as format. The statistical counters record errors using hexadecimal values. The maximum value for any counter is hex 'ff'.

The terms used in the log descriptions are defined as follows:

**Machine Check** – The CCA hardware has detected an error and the failing operation is retried. If the retry is successful, the error is transparent. If the retry fails, the CCA is disabled and the machine check is logged. See nnn code 310 in Appendix B.



**Invalid Status** – The control logic has detected an unexpected or invalid combination of bit settings in the CCA Status Register. See nnn code 311 in Appendix B.

**DCE** – The control logic has detected the loss of Data Set Ready (DSR) from the modem. See nnn code 501 in Appendix B.

#### **Timeout**

**Read Operation** – This bit indicates that 3 seconds has elapsed without receipt of an Syn, ETX, or ETB.

**Write Operation** – See nnn code 530 in Appendix B.

#### **Overrun**

**CCA** – The 3274 was not ready to receive a byte of data from the device.

**HPCA** – Either the cycle-share buffers were full or the 3274 did not allow the adapter to cycle-share.

**Underrun** – The 3274 was not ready to transmit a byte of data at the time the transmission line was ready to receive it.

**Enq Received** – An inquiry character has been received by the 3274.

**NAK Sent** – A Negative Acknowledgment has been sent.

**NAK Received** – A Negative Acknowledgment has been received.

**15 NAKs Received** – 15 Negative Acknowledgments have been received.

**15 NAKs Sent** – 15 Negative Acknowledgments have been sent.

**N Timeouts Invalid** – N = number of invalid timeouts that have occurred.

**15 Timeouts Invalid** – 15 invalid timeouts have occurred.

**Count Exceeded** – The byte count has been exceeded.

**RI** – Ring Indicator (not used).

**RVI RCVD** – A reverse interrupt was received instead of ACK 0/ACK 1.

**ITB ATTN** – An ITB character was received.

**EOH ATTN** – An STX character was received signifying the End of Header.

**XPRNCY** – The receive operation has entered the transparent mode.

**Poll/Select** – This bit, when 1, indicates that this station has been polled. When this bit is 0, this station has to be selected.

### **3.3.1 Test 1 Device Logs**

Perform the following steps before consulting the log:

1. If any 8 4 2 1 indicators are set, refer to the *MIM* for the failing FRU.

2. If a 3nn or 5nn code is displayed, refer to Appendix B for problem determination information. These codes can be found in the device logs.

If the above steps do not provide sufficient information for problem determination, then the log may be of assistance. The log statistical counters indicate the state of the interface (how many errors of a certain classification), and the event data provides error status on the interface for certain severe error events. This event data should be the last error information examined, since the control logic normally examines the error data and sets the nnn code to the appropriate value.

The device logs should be accessed whenever a specific device is suspected of experiencing intermittent or difficult-to-define errors. These errors may or may not be generating nnn numbers on the failing device. (Not all nnn numbers are displayed.) Since several types of device logs are available when Test 1 is being used, it is necessary to determine what type of device (Category A or B) is attached to the device port number for which you are requesting log information. The format for all device logs requested using Test 1 is as follows:

- Line 1 –

01/1

This line is returned exactly as you entered your request. Example: You entered 01/1, and the first line of the display sent back to you should be 01/1.

- Line 2 –

2233 4455 6677 QQ00

This line displays the most current 2 low order digits of the 200 (22), 300 (33), 400 (44), and 500 (55) series NNN numbers detected by the 3274 and if it is a 3290, the 2 low order digits of the 600 (66) and 700 (77) series numbers detected by 3290. Also the 3290 qualifier (QQ). The last byte (00) is not used.

**Note:** *Specific device documentation should be consulted to obtain a description of the 600/700 NNN numbers and the device qualifier.*

If there are no errors generating nnn numbers, the second line of this display will appear as follows:

0000 0000

If it is not 3290 and error information has been recorded, the second line of this display could appear as follows:

0400 0032

- 04 = The most current 200 series error, in this example, 204, which is a device check.<sup>1</sup>
- 00 = No 300 series errors are recorded.
- 00 = No 400 series errors are recorded.
- 32 = The most current 500 series error, in this example, 532, which is BSC line idle.

The 200 numbers appear in the leftmost position and progress to the 500 numbers in the rightmost position.

If it is a 3290 and error information has been recorded, the second line of the display could appear as follows:

0088 0034 0100 0200

- 00 = No 200 series errors.
- 88 = Most current 300 series error (388).
- 00 = No 400 series errors.
- 34 = Most current 500 series error (534).
- 01 = A 600 series error (601).
- 00 = No 700 series errors.
- 02 = Qualifier.
- 00 = Not used.

● Line 3 --

XXXX XXXX XXXX XXXX YYYY YYYY

This line displays the statistical counter information associated with this device. The XX bytes are displayed for all devices and represent 8 counters, designated 01 through 08. The YY bytes represent 4 counters designated 09 through 12. These 4 counters are displayed for 3290 units only. Consult specific device documentation for a description of the YY bytes (counters 09 through 12). If no errors are recorded for this device, the counters will display as follows:

0000 0000 0000 0000

The counters are not numbered when they are displayed. They are, however, assigned counter position numbers. The leftmost two-digit position is counter number 01, and the rightmost counter position used is counter number 06. The value in each counter is given in hexadecimal. If errors were being recorded for this device, the display for line 3 would appear as follows:

02FF 1A00 0013 0000

- Counter number 01 = 02 hex = 02 errors total
- Counter number 02 = FF hex = 255 errors (maximum)
- Counter number 03 = 1A hex = 26 power off total
- Counter number 04 = 00 hex = no errors
- Counter number 05 = 00 hex = no errors
- Counter number 06 = 13 hex = 19 errors total
- Counter number 07 = Reserved
- Counter number 08 = Reserved

All counters for line 3 function in this manner. The counter numbers are assigned specific meanings according to the type of device log being requested. (See Figure 3-1.)

Following is a device log as it would appear for an intermittently failing 3278 display on control unit port A07.

07/1  
1200 0000  
0000 001C 0000

If the log for this device is broken down, there is a record in the nnn number field showing that a 212 (invalid scan code received) error is the most recent 200 series error and that no other nnn errors are recorded. Counter number 04 has a value of 1C recorded, indicating that 28 device checks were pointing to this display as the source of failure. Repair activity can now be attempted at the display level. Control-unit failure is not suspected.

<sup>1</sup>A 2% % (customization error) nnn error code will appear as 2EE in the error log.

<b>3178/3278/3279 Log</b>		<b>Type A Printer Log</b>			
<b>Counter</b>	<b>Meaning</b>	<b>Counter</b>	<b>Meaning</b>	<b>Counter</b> <b>Meaning</b>	
01	Coax timeouts	01	Coax timeouts	03	Normal power off — This counter indicates the number of times the device failed to respond to a poll retry sequence (device powered off). Counter 1 or 2 is incremented on the first failure to receive a poll sequence response; 32 successive poll sequence retries by the DCA then follow. If all retries are unsuccessful, the control logic assumes that the device is powered off and then increments counter 3.
02	Coax parity errors	02	Coax parity errors	04	Device checks — The device has detected an error and has returned device check status to the 3274. See nnn code 204.
03	Power Off	03	Power Off	05	Error status base machine -- Error status has been returned that indicates a device failure.
04	Device checks	04	Device checks	06	Error status features --- An invalid response or error response has been received from a feature device.
05	Error status base machine	05	Error status		
06	Error status features	06	Equipment checks		
<b>3277 Log</b>		<b>Type B Printer Log</b>			
<b>Counter</b>	<b>Meaning</b>	<b>Counter</b>	<b>Meaning</b>		
01	Coax timeouts	01	Coax timeouts		
02	Coax parity errors	02	Coax parity errors		
03	Power Off	03	Power Off		
04	Device checks	04	Device checks		
05	Not applicable	05	Sync or equipment checks		
06	Not applicable	06	Disabled or equipment checks		
<b>3178/3278/3279 AND 3290 (as Displayed on a 3178/3278/3279) Display Log Detail</b>					
<b>Counter</b>	<b>Meaning</b>				
01	Coax timeouts — This counter is incremented when the 3274 sends data or commands to the device and does not receive a response in a predetermined period of time.				
	<b>Note:</b> Use the nnn code logged for the device for further analysis.				
02	Coax parity error — This counter is incremented when the 3274 detects a parity error in a 12-bit received from the device.				
<b>Type A Printer Log Detail</b>					
<b>Counter</b>	<b>Meaning</b>				
01	Coax timeouts — See display log detail.				
02	Coax parity error — See display log detail.				
03	Normal power off -- See display log detail.				
04	Device checks — See display log detail.				
05	Error status — An error condition has been detected by the 3274, or error status has been received indicating a device failure.				
06	Equipment check — The printer has reported an unrecoverable error to the 3274.				
<b>Type B Printer Log Detail</b>					
<b>Counter</b>	<b>Meaning</b>				
01	Coax timeouts — See display log detail.				
02	Coax parity error — See display log detail.				
03	Normal power off — See display log detail.				
04	Device checks — See display log detail.				
05	Sync or equipment check — The printer has returned sense information that indicates an equipment check while printing. See nnn code 276 in Appendix B.				
06	Disabled and equipment check --- The printer has posted an equipment check and is in a not-ready condition. See nnn code 275 in Appendix B.				

Figure 3-1. Summary of Counter Definitions by Log Type

### 3.3.2 Test 1 Host Adapter Logs

The host adapter logs should be accessed whenever a problem is suspected to be intermittently causing host communication failures, host adapter failures, or other spurious or difficult-to-define failures. When a host adapter log is requested, the format will always be A0/1. The display sent from the control unit in response to this request will depend on the type of host adapter installed in your 3274. The display for each host adapter is slightly different. The display returned in response to an A0/1 request is covered in detail in subsequent sections; in general, however, all displays appear as follows:

- Line 1 – A0/1
- Line 2 – Event data is displayed
- Line 3 – This line displays the statistical counters associated with each host adapter

The host adapter logs can provide detailed information pertaining to the following questions: (1) What was the nnn number at the time of the last failure? (2) What was the operation being attempted at the time of the last failure? (3) How was that operation completed? (4) Why was that operation completed that way? (5) What is the frequency of this type of failure? If these questions are answered with the use of the information stored in the host adapter logs, remedial or repair activity can be attempted.

### 3.3.3 Test 1 Common Communications Adapter (CCA) Log for BSC

This host attachment log format is returned to the requesting 3278 in response to an A0/1 entry. The format detail is as follows:

- Line 1 – Returned the same as input, A0/1.
- Line 2 – Twenty-four bytes are displayed on this line, but only ten are used. The individual bytes are not labeled when displayed. Each byte is assigned a specific meaning. See the following example for byte identification:

```

Byte 1                               Byte 24
0000 0000 0000 0000 0000 0000 0000 0000 0000 0000
NNFF CCCC SSSS SSSS SSXX XXXX } } XXXX
    
```

The leftmost byte is labeled NN. This code represents the two low-order digits of any 500 series nn number in almost all cases. However, if NN equals zero (00) and the bytes labeled FF and CCC are *not* zeros, then the entire log information does not pertain to a 500 series communication check and is to be considered machine-check data.

The next byte to the right of NN is FF. This byte represents the type of operation being attempted at the time of

the failure. Refer to the CCA BSC Operation Attempted Chart (Figure 3-2) when FF is to be used.

The next two bytes to the right of FF are labeled CCCC. These two bytes indicate how the attempted operation ended. See the CCA BSC Operation Ending Chart (Figure 3-3) to determine if the operation was completed (1) normally, (2) with exception, or (3) with error.

The next five bytes to the right of CCCC are labeled SSSS. These five bytes contain sense information recorded at the time of the failure. After you have examined NN, FF, and CCCC, the SSSS bytes should give you some indication as to why the nnn code was generated and why the operation attempted was not completed normally.

All bytes labeled XXXX are not used.

- Line 3 – This line displays the statistical counter information associated with this adapter. If no errors are recorded for this adapter, the counters display as follows:

```
0000 0000 0000 0000 0000 0000 0000 0000 0000 0000
```

The counters are not numbered when they are displayed. They are, however, assigned counter position numbers. The leftmost two-digit position is counter number 01, and the rightmost counter position *used* is counter number 11. The remaining positions are not used. The value in each counter is given in hexadecimal. The maximum value for any counter is FF.

Each counter is assigned a specific meaning, as follows:

Counter	Meaning
01	NAK sent
02	NAK received
03	Enq received
04	Timeout invalid
05	15 NAKs received
06	15 Wrong ACKs (ACK 0 instead of ACK 1, etc.)
07	Underruns/overruns
08	Write timeout
09	DCE error
10	Number of Available Buffers Exceeded

A complete log display for this adapter would appear as follows:

```

A0/1
0000 0000 0000 0000 0000 0000 0000 0000 0000 0000 0000 0000
0000 0000 0000 0000 0000 0000 0000 0000 0000 0000 0000
    
```

FF Code	Operation Attempted	FF Code	Operation Attempted
00	Enable/Set Mode	14	Disable
01	Hardware Sense	16	STX/ETX Nonconversational
02	SOH/ETX Conversational Resp	18	Write WACK
03	Read Normal	1A	STX/ETB Conv Response
06	SOH/ETX Nonconversational	1E	STX/ETB Nonconversational
07	Read-Respond RVI	40	Monitor Line
0A	SOH/ETB Conv Response	46	SOH/ETX Expect Conv Resp
0E	SOH/ETB Nonconversational	56	STX/ETX Expect Conv Resp
10	Write EOT	58	Monitor Line-Respond WACK
12	STX/ETX Conv Response		

Figure 3-2. CCA BSC Operation Attempted Chart (Code FF)

Bits shown as 0 are not used unless specified otherwise.

Operation Attempted

00 Enable/Set Mode

	Left CC Byte (Completion)							Right CC Byte (Detail)										
	Bit	0	1	2	3	4	5	6	7	Bit	0	1	2	3	4	5	6	7
Normal Completion		0	0	0	0	1	0	0	0		0	0	0	1	0	0	0	0
RVI		_____																
Error Completion		0	0	0	0	1	1	0	0		0	1	1	1	1	1	0	0
Halted		_____																
Over/Underrun		_____																
Invalid Basic Status		_____																
DCE		_____																
Machine Check		_____																
Exception Completion		0	0	0	0	0	0	1	0		0	1	0	0	0	0	0	0
Timeout		_____																

01 Hardware Sense

Normal Completion		0	0	0	0	1	0	0	0		0	0	0	0	0	0	0	0
(No error or exception condition allowed)		_____																

02 SOH/ETX Conversational Response

03 Read Normal

06 SOH/ETX Nonconversational

07 Read and Respond RVI

Normal Completion		0	0	0	0	1	0	0	0		0	1	1	0	0	0	0	0
STX=0		_____																
SOH=1		_____																
ETX=0		_____																
ETB=1		_____																

Figure 3-3 (Part 1 of 4). CCA BSC Operation Ending Chart (Code CCCC)

Operation Attempted

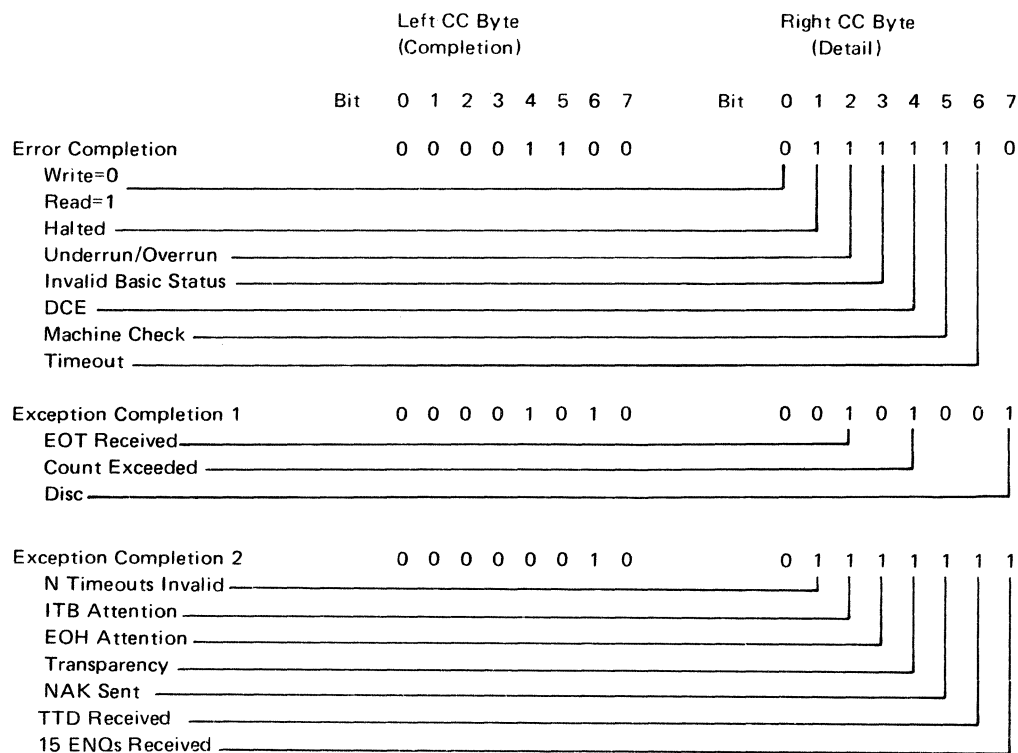

0A SOH/ETB Conversational Response

0E SOH/ETB Nonconversational

10 Write EOT

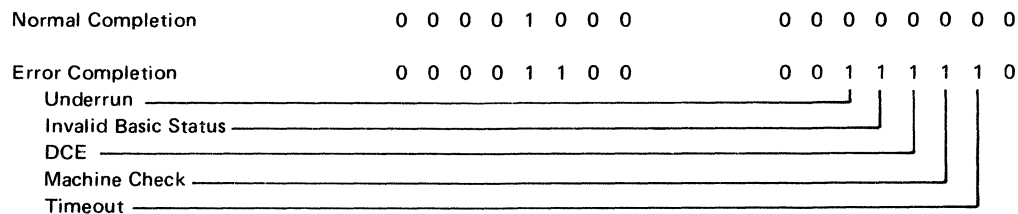

(Exception completion not valid for Write EOT)

12 STX/ETX Conversational Response

14 Disable

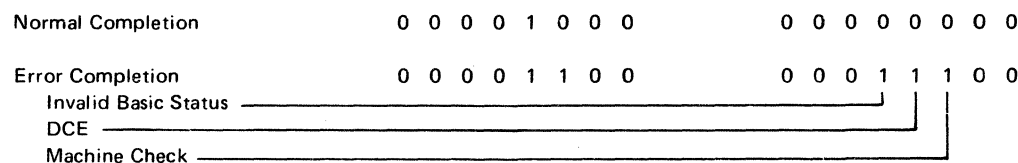

(Exception completion not valid for Disable)

16 STX/ETX Nonconversational

18 Write WACK

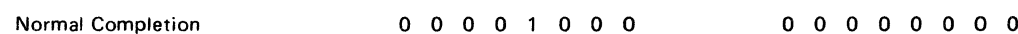
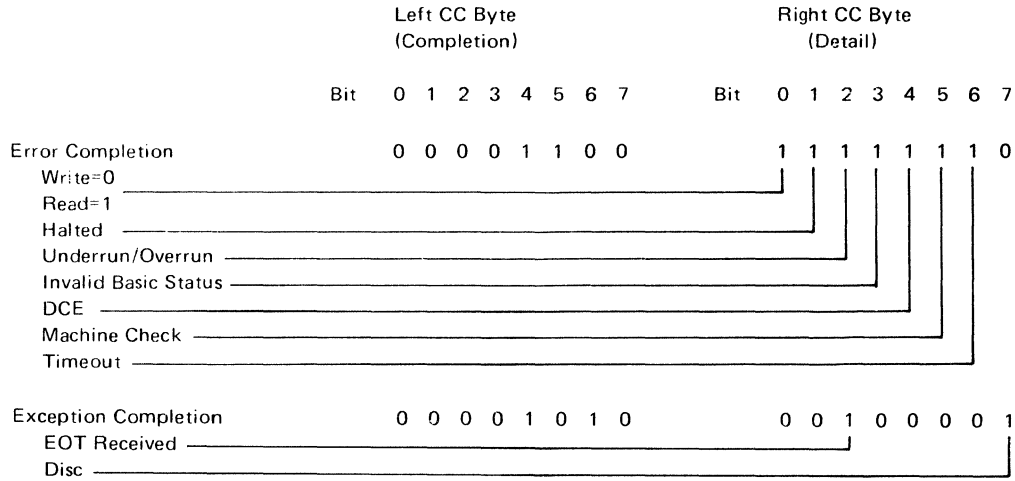

Figure 3-3 (Part 2 of 4). CCA BSC Operation Ending Chart (Code CCCC)

Operation Attempted



1A STX/ETB Conversational Response

1E STX/ETB Nonconversational

40 Monitor Line

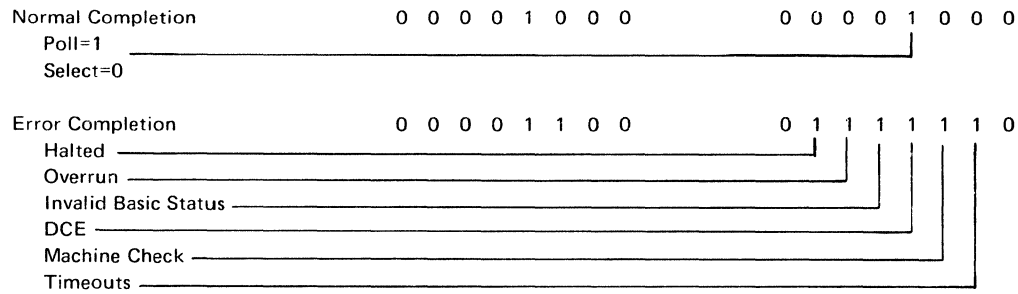

46 SOH/ETX Expect Conversational Response

56 STX/ETX Expect Conversational Response

FF codes 02 through 56 listed above use the following completion/detail.

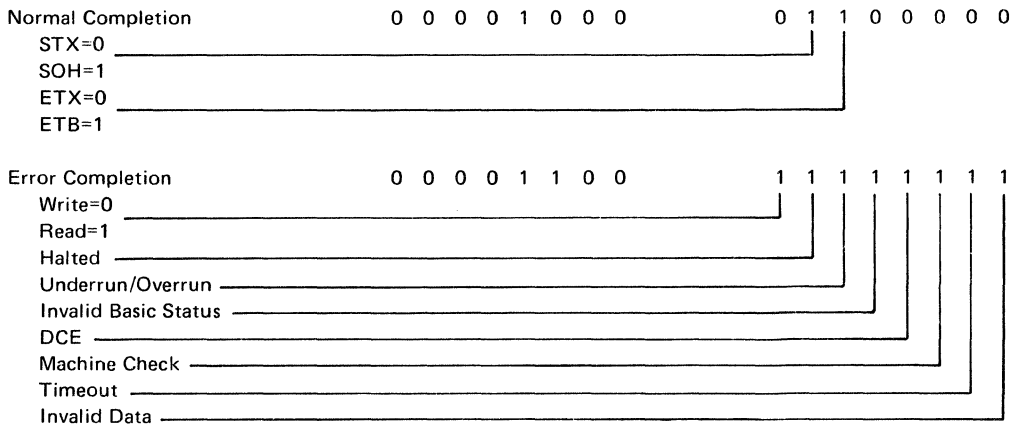
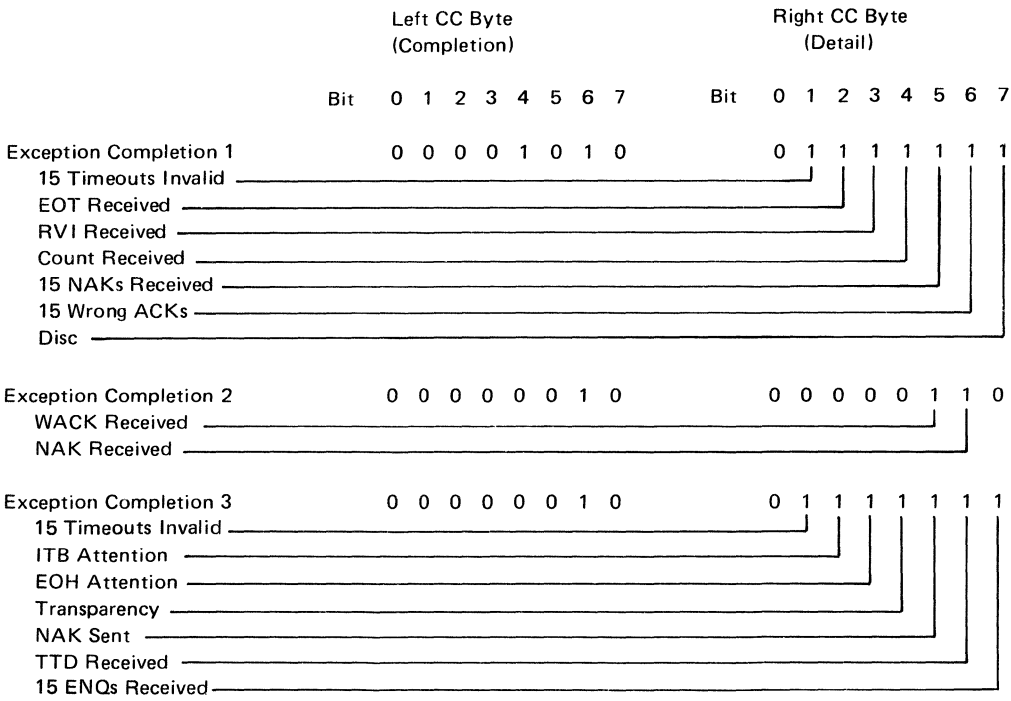

Figure 3-3 (Part 3 of 4). CCA BSC Operation Ending Chart (Code CCCC)

Operation Attempted



58 Monitor Line Respond WACK

FF Codes 44 through 58 use the following completion detail.

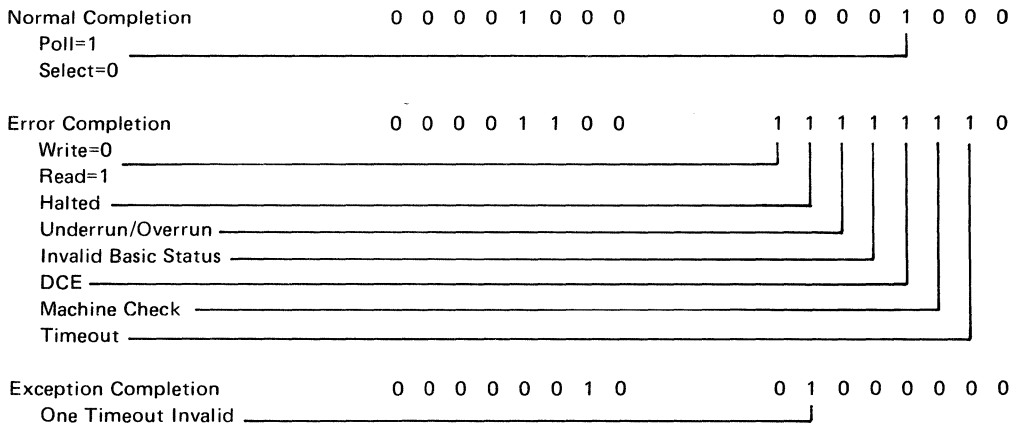

Figure 3-3 (Part 4 of 4). CCA BSC Operation Ending Chart (Code CCCC)



Figure 3-4 explains the sense-byte breakdown for CCA BSC. These conditions are logged only for nnn codes 311, 501, 530, 535, and 536, and the last error condition of that type.

Line 2 – NNFF CCCC SSSS SSSS SSSS  
 0102 0304 0506

SS bytes are labeled from left to right SS01, SS02, SS03, etc.

Location	Bit	Meaning If Bit Is Turned On (1)
Byte SS01		Ignore
Byte SS02	0	Input Request
	1	Output Request
	2	DCE Interrupt
	3	Timer Interrupt
	4	Exception
	5	Machine Check/Prog Check
	6	Enable/Disable
Byte SS03	0	Data Set Ready
	1	Clear to Send
	2	Recv Line Signal Det
	3	Ring Ind
	4	DSR Transition
	5	Reserved
	6	RLSD Transition
Byte SS04	0	DTR/CDSTL
	1	Request to Send
	2	Wrap
	3	Test
	4	Select Standby
	5	Select Half Speed
	6	New Sync
Byte SS05	0	Overrun
	1	Underrun
	2	Receive Clk Running**
	3	SDLC Invalid Seq
	4	SDLC Frame
	5	Invalid Character**
	6	Break Byte Detected**
Byte SS06	0	Receive Mode
	1	Transmit Mode
	2	Inhibit Zero Insertion
	3	Mode Select*
	4	Mode Select*
	5	+Code Length
	6	+ Code Length
7	NRZI	

\* 00 = Auto      + 00 = 8 bit  
 01 = EBCDIC    01 = 6 bit  
 10 = ASCII     10 = 7 bit  
 11 = SDLC      11 = 5 bit

\*\*Should always be zero

**Figure 3-4. Sense Byte Breakdown Chart for CCA BSC (Code SSSS)**

### 3.3.4 Test 1 Common Communications Adapter (CCA) Log and High-Performance Communications Adapter (HPCA) Log for SDLC

This host adapter log format is identical for both adapters and is returned to the requesting display in response to an A0/1 entry. The format detail is as follows:

- Line 1 – Returned the same as input, A0/1.
- Line 2 – Twenty-four bytes are displayed on this line, but only 11 are used. Information is stored and displayed only in Line 2 on specific error conditions. These conditions are associated with nnn codes 501, 502, 529, 530, or 321 (see Appendix B for details). Code 321 will be indicated in this line as NN=00 and the remainder of Line 2 will be not equal to 0. Each byte is assigned a specific meaning. See the following example for byte identification:

```

Byte 1                                     Byte 24
0000 0000 0000 0000 0000 0000 0000 0000 } } 0000
NNFF CCCC SSSS SSSS SSSS SSXX XXXX } } XXXX
  
```

NN – This code represents the two low-order digits of any 500 series nnn number in almost all cases.

FF – This byte represents the type of operation being attempted at the time of the failure. Refer to the CCA/HPCA Operation Attempted Chart (Figure 3-5) when FF is to be used.

FF Code	Operation Attempted
00	Open
01	Sense
02	Write/Read
04	Close
05	Adapter Prewrap (Test)
09	Adapter Wrap (Test)
10	Beacon
0D	Modem Wrap (Test)
20	Logical Open
40	Fast Close
82	Halt Write

**Figure 3-5. CCA/HPCA SDLC Operation Attempted Chart (Code FF)**

CCCC – These two bytes indicate how the attempted operation ended. See the CCA/HPCA Operation Ending Chart (Figure 3-6) to determine if the operation was completed (1) normally, (2) with error, or (3) with exception.

SSSS – These seven bytes contain sense information recorded at the time of the failure. After examining NN, FF, and CCCC, the SSSS bytes should give you some indication as to why the nnn code was generated and why the operation attempted was not completed normally.

XXXX — All bytes labeled XXXX are not used in the CCA and should be ignored for the HPCA, since these bytes contain secondary levels of information, which are not associated with the problem.

- Line 3 — This line displays the statistical counter information associated with these adapters. If no errors are recorded for these adapters, the counters will display as follows:

0000 0000 0000 0000 0000 0000 0000 0000 0000 0000

The counters are not numbered when they are displayed. They are, however, assigned counter position numbers. The leftmost two-digit position is counter number 01, and the rightmost counter position *used* is counter number 12. The remaining positions are not used. The value in each counter is given in hexadecimal. The maximum value for any counter is FF.

Each counter is assigned a specific meaning, as follows:

Counter	Meaning	nnn Code (App B)
01	Nonproductive Timeout	520
02	Idle Timeout (not valid for Loop)	521
03	Write Retry	
04	Overrun	
05	Underrun	
06	Connection Problem	525
07	FCS Error	
08	Primary Abort	
09	Command Reject	528
10	DCE Error	529
11	Write Timeout	530
12	Count Exceeded	519
13	Secondary Busy	
14	RLSD Error	507

The error to nnn code and counter relationship is shown below:

Error	nnn Code (See App B)	Counter
DCE Error	529	10
Machine Check		
CCA	320	—
HPCA	330	—
Invalid Status		
CCA	321	—
HPCA	331	—
Write Timeout	530	11
Nonproductive Timeout		01
Idle Timeout	521	02
Overrun	—	04

Error	nnn Code (See App B)	Counter
Underrun	—	04
Connect Problem	525	06
Secondary Busy	—	13
Write Retry	—	03
FCS Error	—	07
Primary Abort	—	08
Command Reject	528	09
Lost Data	519	11
No RLSD	507	14
Format Error	555	2
X.21 Timeout	556	3
Not Ready	557	5
Lost Data	558	6
DCE Cleared	559	7
Not +/-Bel	560	11
Clear Timeout	561	18
CMPR Error	562	1
Invalid Sequence	565	4

The following descriptions of conditions will help you analyze the logs:

**Read Message Available** — Indicates that an I-frame has been received and is destined to a physical or logical unit.

**Link Test** — Used in conjunction with the Read Message Available bit. When both bits are on (1), it indicates that the I-frame received is a test message.

**Poll Request** — This bit indicates that a valid poll has been received from the host.

**SNRM Received** — A Set Normal Response Mode sequence has been received from the host. An existing session will be terminated, and a new session may be established.

**Underrun** — The 3274 controller was not ready to transmit a byte of data at the time the transmission line was ready to receive.

**Connection Problem** — 20 consecutive occurrences of any of the following: ROL, FRMR, XID, NSA.

**FCS Error** — The 3274 controller detected an SDLC frame with an invalid block check character (BCC) or a frame-check sequence.

**Primary Abort** — The 3274 detected an abort message from the primary station.

**Lost Data** — An I-frame received by the 3274 was larger than the allocated buffer.

Write Timeout – A transmission of data took longer than expected and is suspected to be a result of a hardware function.

Dump Message – Addition status is contained in the register space that will indicate one of the following:

- FCS Error
- Primary Abort
- N (r) Sequence Error
- Wrong Length Message (same as lost data)
- Data with a command
- Invalid SDLC command

Secondary Busy – An RNR response has been sent to the primary station because the 3274 does not have sufficient buffers (receive).

Nonproductive Timeout – No valid SDLC frames have been received by the 3274 that contains either a valid FCS or a valid address for a period of 20 seconds.

XID Received – A valid XID was received from the primary station. The 3274 will go to normal disconnected mode (NDM) of operation.

Disconnect Received – A valid SDLC frame containing a Disconnect command was received from the primary station. The 3274 will go to normal disconnect (NDM) mode of operation.

Write Retry – A previously transmitted I-frame was not received by the host. The 3274 will transmit the same I-frame again.

Bits shown in the chart as 0 are not used unless specified otherwise.

**Operation Attempted**

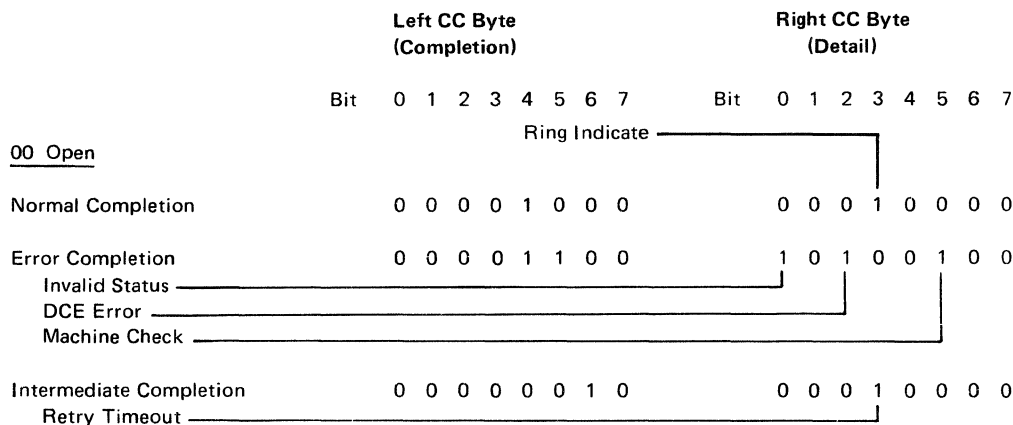

Read/Write

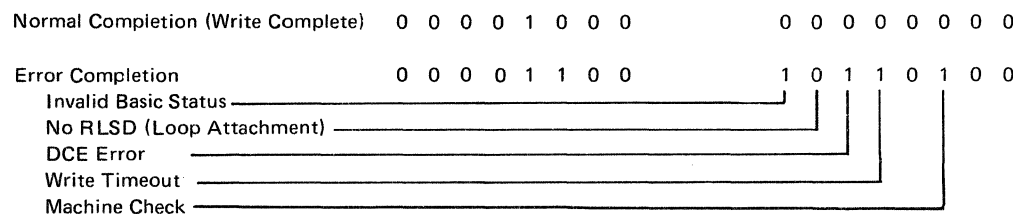

**Figure 3-6 (Part 1 of 2). CCA/HPCA SDLC Operation Ending Chart (Code CCCC)**

Idle Line Timeout – No valid flag characters have been detected on the host link for 20 seconds.

Ring Indicate Timeout – A switched connection has not been detected in a 3-second period.

Ring Indicate – A switched connection has been made.

Invalid Basic Status – An adapter hardware register contains data that was not meaningful.

DCE Error – A modem problem has been detected.

CNFG – A valid Configure command was received and the appropriate action is being taken by the adapter microcode.

No RLSD – RLSD has been inoperative for at least 4 seconds.

Overrun

- CCA – The 3274 was not ready to receive a byte of data from the device.
- HPCA – Either the cycle share buffers were full or the 3274 did not allow the adapter to cycle share.

A complete log display for this adapter would appear as shown below:

```
A0/1
0000 0000 0000 0000 0000 0000 0000 0000 0000 0000 0000 0000
0000 0000 0000 0000 0000 0000 0000 0000 0000 0000 0000
```

**Operation Attempted**

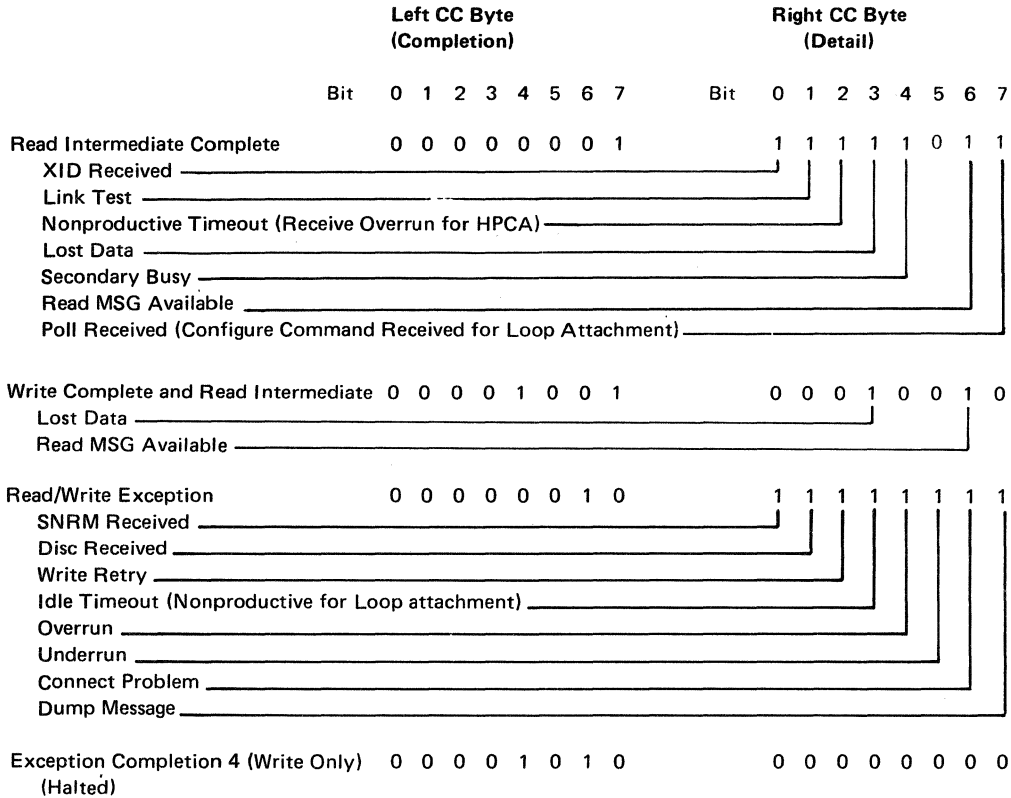

**04 Close**

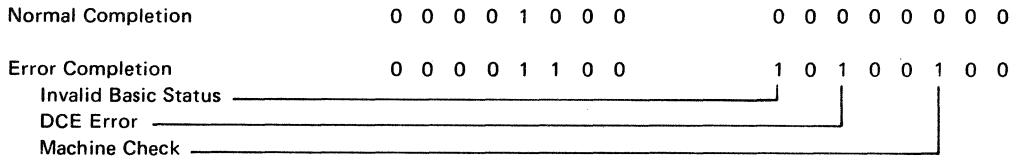

(Exception completion condition not allowed)

**05 Adapter Prewrap**

**09 Adapter Wrap**

**10 Beacon (Loop Attachment)**

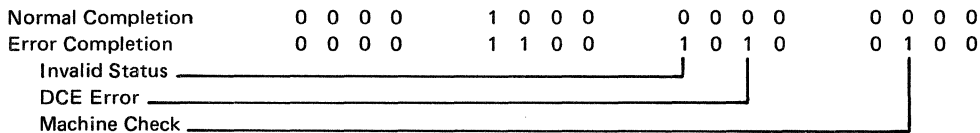

**0D Modem Wrap**

FF Codes 05 through 0D are not logged.

**Note:** Bits 0-3 of left cc byte are ignored except during Loop attachment. Bit 0 of left cc on indicates a valid SDLC Frame has been received.

**Figure 3-6 (Part 2 of 2). CCA/HPCA SDLC Operation Ending Chart (Code CCCC)**

Figure 3-7 explains the sense-byte breakdown for CCA/HPCA SDLC.

Line 2 – NNFF CCCC SSSS SSSS SSSS SS  
 0102 0304 0506 07

SS bytes are labeled from left to right SS01, SS02, SS03, etc.

Meaning If Bit Is Turned On (1)				Meaning If Bit Is Turned On (1)			
Location	Bit	CCA	HPCA	Location	Bit	CCA	HPCA
SS01	0	See Figure 3-4	Cycle Share Halt	SS07	0	Not used	Timer
	1	See Figure 3-4	Transmit EOL		1	Not used	Timer
	2	See Figure 3-4	Receive Control Entry		2	Not used	DSR
	3	See Figure 3-4	Modem/Timer		3	Not used	CTS
	4	See Figure 3-4	Exception		4	Not used	DSR Transition
	5	See Figure 3-4	Machine Check		5	Not used	Ring Transition
	6	See Figure 3-4	Enabled		6	Not used	RLSD Transition
	7	See Figure 3-4	Interrupt Request	7	Not used	CTS Transition	
SS02	0	See Figure 3-4	Receive Mode	SS08	0	Not used	Wrap
	1	See Figure 3-4	Ping Valid		1	Not used	T3/T4 Test
	2	See Figure 3-4	Pong Valid		2	Not used	New Sync
	3	See Figure 3-4	Not used		3	Not used	Tx New Sync
	4	See Figure 3-4	Specific Address Valid		4	Not used	Diagnostic Clock
	5	See Figure 3-4	Group Address Valid		5	Not used	Diagnostic Timer Control
	6	See Figure 3-4	Interrupt on Cont Flags		6	Not used	RLSD
	7	See Figure 3-4	Enable 15 Ones	7	Not used	Ring	
SS03	0	See Figure 3-4	Invalid Seq/Address	SS09	0	Not used	Not used
	1	See Figure 3-4	Byte Overrun		1	Not used	Not used
	2	See Figure 3-4	Receive Control Entry		2	Not used	Ptr Reg 0
	3	See Figure 3-4	15 Ones		3	Not used	Ptr Reg 1
	4	See Figure 3-4	Control Overrun		4	Not used	Ptr Reg 2
	5	See Figure 3-4	Traffic		5	Not used	Ptr Reg 3
	6	See Figure 3-4	Receive Cycle Share Halt		6	Not used	Not used
	7	See Figure 3-4	Address in Sync	7	Not used	0	
SS04	0	See Figure 3-4	Transmit Mode	SS10	0	Not used	Not used
	1	See Figure 3-4	Control Valid		1	Not used	Not used
	2	See Figure 3-4	NRZI		2	Not used	Ptr Reg 0
	3	See Figure 3-4	Load Serializer		3	Not used	Ptr Reg 1
	4	See Figure 3-4	Flag		4	Not used	Ptr Reg 2
	5	See Figure 3-4	Continuous Character		5	Not used	Ptr Reg 3
	6	See Figure 3-4	FCS Seq and Flag		6	Not used	Ptr Reg 4
	7	See Figure 3-4	Inhibit Zero Insertion	7	Not used	0	
SS05	0	See Figure 3-4	Reserved	SS11	0	Not used	Data Chain
	1	See Figure 3-4	Reserved		1	Not used	Frame Chain
	2	See Figure 3-4	Reserved		2	Not used	Pad Insert
	3	See Figure 3-4	Reserved		3	Not used	FTA
	4	See Figure 3-4	Reserved		4	Not used	Xmit Turnoff
	5	See Figure 3-4	Reserved		5	Not used	0
	6	See Figure 3-4	Transmit Cycle Share Halt		6	Not used	0
	7	See Figure 3-4	Byte Underrun	7	Not used	Count 256	
SS06	0	Not used	DTR	SS12	0	Not used	Count 128
	1	Receive Seq Count	RTS		1	Not used	Count 64
	2	Not used	Select Standby		2	Not used	Count 32
	3	Not used	Data Rate Select		3	Not used	Count 16
	4	Not used	Local Test		4	Not used	Count 8
	5	Send Seq Count	Disable Ring		5	Not used	Count 4
	6	Not used	Disable RLSD		6	Not used	Count 2
7	Not used	Disable CTS	7	Not used	Count 1		

Figure 3-7 (Part 1 of 2). Sense Byte Breakdown Chart for CCA/HPCA SDLC (Code SSSS)

Meaning If Bit Is Turned On (1)				Meaning If Bit Is Turned On (1)				
Location	Bit	CCA	HPCA	Location	Bit	CCA	HPCA	
SS13	0	Not used	1	SS15 (Cont)	4	Not used	Byte Overrun	
	1	Not used	0		5	Not used	Buffer Overrun	
	2	Not used	Ptr Reg		6	Not used	Flag Received	
	3	Not used	Ptr Reg		7	Not used	Count 256	
	4	Not used	Ptr Reg		SS16	0	Not used	Count 128
	5	Not used	Ptr Reg			1	Not used	Count 64
	6	Not used	X			2	Not used	Count 32
7	Not used	0	3	Not used		Count 16		
SS14	0	Not used	1	4		Not used	Count 8	
	1	Not used	0	5		Not used	Count 4	
	2	Not used	Ptr Reg 0	6		Not used	Count 2	
	3	Not used	Ptr Reg 1	7	Not used	Count 1		
	4	Not used	Ptr Reg 2	SS17	0	Not used	Count 256	
	5	Not used	Ptr Reg 3		1	Not used	Count 128	
	6	Not used	Ptr Reg 4		2	Not used	Count 64	
7	Not used	0	3		Not used	Count 32		
SS15	0	Not used	Valid Entry		4	Not used	Count 16	
	1	Not used	Invalid Sequence		5	Not used	Count 8	
	2	Not used	FCS Valid		6	Not used	Count 4	
	3	Not used	Pong Entry	7	Not used	Count 2		

Figure 3-7 (Part 2 of 2). Sense Byte Breakdown Chart for CCA/HPCA SDLC (Code SSSS)

### 3.3.5 Test 1 Storage Card Isolation (Model 52C Only)

To isolate one of the four possible storage cards, perform the A2/1 variation of Test 1 from any Type A display. If bytes 5 through 8 are nonzero, the failing card is identified as follows:

Nonzero Byte	Failing Card	nnn Code Displayed
5	S2	392
6	T2	393
7	U2	394
8	V2	395

Display Example:

```
1122 3344 5566 7788 9900
XXXX XXXX 0000 0048 XXXX
```

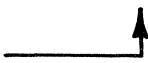
Failing Card V2 

### 3.3.6 Test 1 Device Adapter Logs

There are two types of device adapter log. The log for Category A devices is accessed by using an A1/1 format. The information returned in the log consists of the last nnn number recorded, some basic adapter status information at the time of the failure, and statistical counters similar to the device error log counters. The log for Category B devices is accessed by using an A2/1 format. The information returned in the log consists of the last nnn number recorded, the operation being attempted at the time of the failure, and information in byte form as to how the operation ended. There are also statistical counters similar to the device error log counters. The above log information should be used to determine the

type of error condition that is disabling either of these device adapters. The logs can be used in the same manner as the host adapter logs to determine (1) the frequency of error, (2) what the adapter was doing at the time of error, (3) how the operation ended, etc.

### 3.3.7 Test 1 Type A Adapter Log

This device adapter log format is returned to the requesting Category "A" Display in response to an A1/1 entry. The format detail is as follows:

- Line 1 – Returned the same as input, A1/1.
- Line 2 – Ten bytes are displayed on this line, but only three are currently used. The individual bytes are not labeled when displayed. Each byte is assigned a specific meaning. See the following example for byte identification:

```
0000 0000 0000 0000 0000
NNXX SSSS XXXX XXXX XXXX
```

The leftmost byte is labeled NN. This code represents the two low-order digits of any 200 series nnn number. The nnn number may or may not be displayed on a 3278.

The next byte to the right of NN is XX and is not used.

The next two bytes to the right of XX are labeled SSSS and represent the adapter status associated with the last failure. See Figure 3-8 for SS byte meanings.

- Line 3 – This line displays the statistical counter information associated with this adapter. If no errors are recorded for this adapter, the counters will display as follows:

```
0000 0000 0000 0000 0000
```

The counters are not numbered when they are displayed. They are, however, assigned counter position numbers. The leftmost two-digit position is counter number 01. The rightmost counter position *used* is counter number 08. The remaining positions are not used. The value in each counter is given in hexadecimal. The maximum value for any counter is FF.

Each counter is assigned a specific meaning, as follows:

Counter	Meaning
01	Status Q Entry Placed in Error Q
02	Unconfigured Device
03	Cycle Share Ended in Error
04	Invalid Adapter Status
05	Lost Status
06	Adapter stopped and was restarted
07	Cycle Share Machine Check
08	Non Command Cycle Share Machine Check

Bit	Meaning If Bit Is Turned On	Description
0	Counter Overflow	See nnn code 202, Appendix B.
1	Read Timeout	The DCA expected data or a response from the device while executing a command sequence and did not receive it in a pre-determined amount of time.
2	Turnaround Error or Read Line Parity	The DCA detected a coax turnaround sequence error or a coax parity error while executing a command sequence.
3	Read Data Byte Parity Error	The DCA detected a parity error in the data transmitted by the device.
4	Stop Poll	The DCA is not polling.
5	Timer	The DCA "timer" has fired. The timer is of 1 to 4 seconds' duration and is used primarily to check for a hung device.
6	Error Q Entry	The DCA has detected error status while communicating with or from an attached device and has stored this information in the Error Q in the 3274.
7	Not Used	
0	Extended Status Data	The DCA has set information in extension (left SS byte) status.
1	Command Completed	The DCA has completed a command sequence with a device.
2	Adapter Active	The DCA is active performing an operation.
3	Keystroke or Status Q Entry	The DCA has polled a device, has received a keystroke or status, and has placed the data in a Q in the 3274.
4	Not Used	
5	Machine Check	The DCA has detected an error in itself or on the UC I/O bus.
6	Enable/Disable	The DCA is enabled for operation.
7	Interrupt Request	The DCA has caused an interrupt request.

Figure 3-8. Sense (SS) Byte Definitions

### 3.3.8 Test 1 Type B Adapter/Encrypt-Decrypt Adapter/Disk Adapter Log

This device adapter log format is returned to the requesting display in response to an A2/1 entry. The format detail is as follows:

- Line 1 — Returned the same as input, A2/1.
- Line 2 — Ten bytes are displayed on this line. The individual bytes are not labeled when displayed. Each byte is assigned a specific meaning. See the following example for byte identification:

```
0000 0000 0000 0000 0000
NNFF CCCC XXXX XXXX KKSS
```

The leftmost byte is labeled NN. This code represents the two low-order digits of any 200 or 300 series nnn number. The nnn number may or may not be displayed on a 3278.

The next byte to the right of NN is labeled FF. This represents the operation being attempted at the time of the failure. Refer to the Type B Adapter Operation Attempted Chart (Figure 3-9) to determine the type of operation in progress at the time of failure.

FF Code	Operation Attempted
00	Initialize (Enable and Start Idle Poll)
1F	Read Full Buffer without Start Idle Poll
21	Specific Poll without Start Idle Poll
23	Start Idle Poll
26	Write Full Buffer without Start Idle Poll

Figure 3-9. Type B Adapter Operation Attempted Chart (Code FF)

The next two bytes to the right of FF are labeled CCCC. These two bytes indicate how the operation attempted ended. Refer to the Type B Adapter Operation Ending Chart (Figure 3-10) to obtain this information.

The next 4 bytes (XX...) represent parity errors on volume 3 storage cards (Model 52C), 2 digits per card, cards 1–4. The next byte (KK) represents Encrypt-Decrypt NN Number and the last byte (SS) represents Encrypt-Decrypt status associated with NN Number.

- Line 3 — This line displays the statistical counter information associated with the adapter. If no errors are recorded for this adapter the counters will display as follows:

```
0000 0000 0000 0000 0000
```

The counters are not numbered when they are displayed. However, they are assigned counter position numbers. The leftmost two-digit position is counter number 01. The rightmost counter position is counter number 10. The value in each counter is given in hexadecimal. The maximum value for any counter is FF.

Each counter is assigned a specific meaning, as follows:

Counter	Meaning
01	Type B adapter cycle steal machine checks
02	Type B adapter overruns
03	Type B adapter unconfigured device interrupts (PCM only)
04	Spare
05–08	Model 52C character font storage cards
09	Encrypt/Decrypt Key parity error
10	Encrypt/Decrypt Control Logic error

**Test 1 – Type B Adapter Log**  
(Configuration Support C, D, and T only)

This is an expanded version of Test A2/1 that includes the DISK and RTM functions.

The device adapter log format is returned to the invoking display in response to the operator entering, A2/1.

The displayed screen is formatted as follows:

- Line 1 – Returned the same as input, A2/1
- Line 2 – 16 bytes are displayed. The individual bytes are not labeled when displayed. Each byte is assigned a specific meaning. See the following example for byte identification:

NNFF CCCC XXXX XXXX KKSS MMRR EEEE TTZZ

- NN = Two low order digits of any 200 or 300 series NNN numbers.
- FF = Operation being attempted at the time of the failure (See Figure 3-9).
- CCCC = Completion code (See Figure 2-10).
- XX = Four bytes used only for Model 52C – Volume 3 storage parity errors. Each byte refers to a specific card (1, 2, 3, and 4 respectively).
- KK = Encrypt/Decrypt NN number (2 low-order digits).
- SS = Encrypt/Decrypt status associated with error NN.
- MM = Disk adapter machine check NN number (2 low-order digits).
- RR = Disk adapter function request issued (see Disk adapter function request chart).
- EEEE = Disk adapter completion code (see Disk adapter operation completion chart).
- TT = Response Time Monitor – machine check NN number (2 low-order digits).
- ZZ = Response Time Monitor – status associated with NN error number.

- Line 3 – Displays the statistical counter information associated with the adapters. If no errors are recorded the counters will be displayed as follows:

0000 0000 0000 0000 0000 0000 0000 0000

The counters are not numbered when they are displayed. However, they are assigned counter position numbers. The leftmost two-digit position is counter number 01. The rightmost position is counter number 16. The value in each counter is given in hexadecimal. The maximum value for any counter is FF.

Each counter is assigned a specific meaning, as follows:

Counter	Meaning
01	Type B adapter cycle steal machine checks
02	Type B adapter overruns
03	Type B adapter unconfigured device interrupts (PCM only)
04	Spare
05–08	Model 52C character font storage cards
09	Encrypt/Decrypt Key parity error
10	Encrypt/Decrypt Control Logic error
11	Disk adapter hardware errors
12	Disk media errors
13	Unrecoverable disk overrun errors
14	Spare
15	RTM adapter errors
16	Spare

Location	Bit	Meaning If Bit Is Turned On (1)
Left CC Byte	0	Retry Count
	1	Retry Count
	2	Retry Count = Number of times current operation retried
	3	Retry Count
	4	Complete—Operation terminated
	5	Error (Unrecoverable error encountered) (See Right CC Byte for detail)
	6	Exception (An attention was received before the idle poll could be stopped to perform the operation—valid only if Attention is on also)
Right CC Byte	7	Attention
	0	Overrun
	1	Parity Error on Serial Interface
	2	Device Not Available
	3	Busy
	4	Adapter Disabled
	5	Machine Check
6	Idle Poll On	
	7	Invalid Operation Attempted

**Figure 3-10. Type B Adapter Operation Ending Chart (Code CCCC)**



### 3.3.9 Control Logic Error Log

The control logic error log format is returned to the requesting 3278 in response to an A3/1 entry. The format detail is as follows:

- Line 1 – Returned the same as input, A3/1.
- Line 2 – Eight bytes are displayed on this line, but only seven are currently used. The individual bytes are not labeled when displayed. Each byte is assigned a specific meaning. See the following example for byte identification:

```
0000 0000 1010 1000
CCPP MMRR HHDD AAXX
```

CC represents the number of cycle share I/O errors encountered. The count is incremented when a cycle share error occurs. The counter will not wrap (increments to FF and then stops). For detailed log information for the associated adapter, see Adapter Logs A0–A2.

PP is the count of storage parity errors encountered for which recovery was successful. The counter will not wrap (increments to FF and then stops).

MM represents the engine machine checks encountered for which recovery was successful. The counter will not wrap (increments to FF and then stops).

RR is a reserved byte.

HH is a machine check threshold counter for the host adapter.

The count is incremented when an adapter I/O machine check occurs. The counter will not wrap (steps to FF and then stops).

DD represents the Type A adapter machine check threshold counter. It increments in the same manner as HH.

AA represents the Type B Adapter machine check threshold counter. It increments in the same manner as HH and DD.

Byte XX is used as the encrypt/decrypt adapter machine check counter. This counter increments in the same manner as HH.

- Line 3 – There is no line 3 assigned to this log; however, a third line may be displayed if you entered this log from another log display.

This is an expanded version of Test A3/1 that includes the DISK and RTM functions.

The control logic log format is returned to the invoking display in response to the operator entering, A3/1.

The displayed screen is formatted as follows:

- Line 1 – Returned the same as input, A3/1
- Line 2 – 16 bytes are displayed. The individual bytes are not labeled when displayed. Each byte is assigned a specific meaning. See the following example for byte identification.

```
CCPP MMRR HHDD AAXX YYZZ
```

CC = Number of cycle share I/O errors

PP = Storage parity error count

MM = Number of Control logic machine checks with successful recovery.

RR = Reserved

HH = Host adapter machine check count

DD = Type A adapter machine check count

AA = Type B adapter machine check count

XX = Encrypt/Decrypt adapter machine check count

YY = Disk adapter machine check count

ZZ = Response Time Monitor machine check count

- Line 3 – There is no line 3 assigned to this log. However, a third line may be displayed if you have entered this log from another log display.

### 3.3.10 Display Response Time Monitor Data (A4/1)

With Configuration Supports C and D, when the 3274 has been customized for local display of the RTM log or the host has enabled this function the A4/1 Test allows an operator to display the RTM log on authorized Category A displays (except devices like the 3290). After entering TEST MODE, by pressing the TEST key switch, entering A4/1 results in the following to be displayed:

A4/1 (Same as input) @ = 000

@	DEF	CTR#1	BDY#1	CTR#2	BDY#2	CTR#3	BDY#3	CTR#4	BDY#4	OV
00	1	10	0.5	11,415	1.0	316	5.0	21	1:00.0	6
01p	1	0	0.5	0	1.0	0	5.0	0	1:00.0	0
02 ?	1	651	0.5	0	1.0	0	5.0	0	1:00.0	14,458
03	*2	215	0.5	512	1.0	56	5.0	0	1:00.0	1
04i	1	31	1.0	11	2.0	4,371	5.0	4	10.0	2
05	1	0	0.5	0	1.0	0	5.0	0	1:00.0	0
06 <sup>-</sup>	*3	1	1.0	61	2.0	4	3.0	0	4.0	45
07	1	1,415	0.5	890	1.0	323	5.0	0	1:00.0	1,381

**Note:** The example shows representative information for the first eight logical terminals. If the 3274 is not customized for RTM when A4/1 is entered, the X \* ? is displayed in the Operator Information Area of the screen. Each time the ENTER (or PA1) key is pressed, the next group of eight terminals is displayed. The heading, @ = XXX, in the top center of the display corresponds to the first logical terminal number in the group currently being displayed (000, 008, etc.)

CTR = counter  
 BDY = boundary  
 @ = device or logical terminal  
 OV = overflow  
 p = printer (No statistics are kept for printers)  
 i = pass-through device  
 - = never powered on (No statistics are kept)  
 \* = parameter set by host  
 ? = RTM disabled by host for this device  
 DEF = response time definition  
 1 = time to first character on screen  
 2 = time to keyboard usable by the operator  
 3 = time to CD (Change Direction) /EB (End Bracket)

CTR#1 = first counter (response time = 0 up to BDY#1 value)  
 BDY#1 = first boundary in minutes and seconds  
 CTR#2 = second counter (response time greater than BDY#1 up to BDY#2 value)

BDY#2 = second boundary in minutes and seconds  
 CTR#3 = third counter (response time greater than BDY#2 up to BDY#3 value)  
 BDY#3 = third boundary in minutes and seconds  
 CTR#4 = fourth counter (response time greater than BDY#3 up to BDY#4 value)  
 BDY#4 = fourth boundary in minutes and seconds  
 OV = overflow (response exceeds last boundary value)

Note that the displayed boundaries are rounded to the nearest tenth of a second.

### 3.3.11 Reset Response Time Monitor (A4/4) (Only when RTM is Configured with No Host Support)

The operator at an authorized display can reset the RTM logs of all configured devices. All log information is reset except the customized boundaries, the customized RTM definitions and pending Transaction status. While in TEST Mode, entering A4/4 generates RTM log reset. When the reset is complete a plus sign (+) appears immediately to the right of A4/4 (A4/4+) in the upper left corner of the screen. The reset logs are not displayed.

If the 3274 is not customized for RTM when A4/4 is entered, the X \* ? is displayed in the Operator Information Area of the screen.

Note that the RTM logs can also be reset at any time during their display. The screen is first cleared by pressing the CLEAR key; the cursor is displayed in the upper-left corner of the screen, and the operator then enters A4/4. When the reset is complete the plus sign (+) appears to the immediate right (A4/4+).

### 3.3.12 Microcode Error-Correcting Code (ECC) Data (All Configuration Support Levels Except D)

The A5/1 Test displays the volume, the starting address of each segment, and the ECC counts for each segment. A volume total of ECC counts is calculated and displayed. The display for each volume follows:

```
A5/1
X YYYY
AAAA AAAA AAAA ..... AAAA
CCCC CCCC CCCC ..... CCCC
```

Where:

- X = Volume indicator
- YYYY = Total ECC error count in volume
- AAAA = Starting address of each segment in volume (up to 16 for 64K)
- CCCC = ECC count (number of recovered storage failures) of each segment

Pressing the ENTER or PA1 key pages the ECC data through each volume until all configured volumes have been displayed. If the key is pressed again, a Do Not Enter minus-function indicator appears.

The A5/4 test will reset all ECC counts for all volumes.

### 3.3.13 X.21 Switched Log

Figure 3-11 shows settings for the X.21 Switched Feature error logs, followed by descriptions of conditions that will help you analyze the logs.

Open

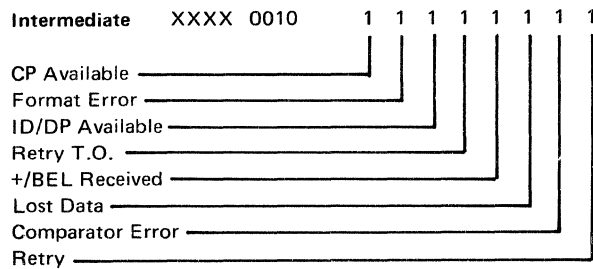
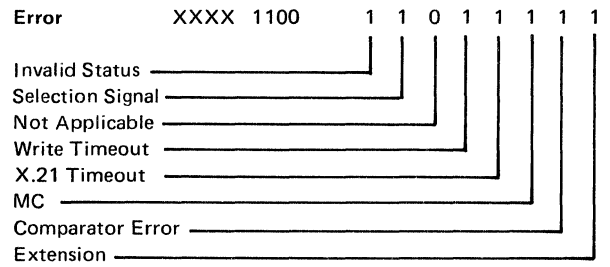

Figure 3-11 (Part 1 of 2). X.21 Switched Log Settings



Close

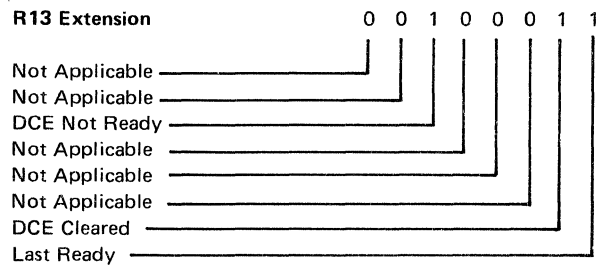
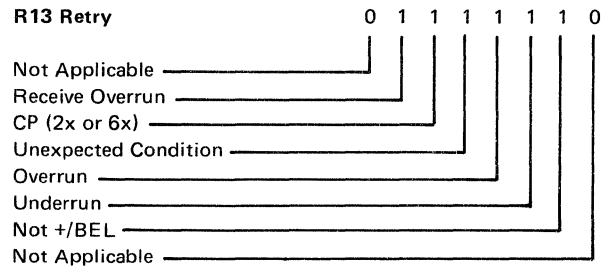
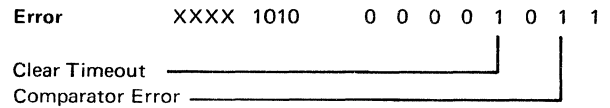

Figure 3-11 (Part 2 of 2). X.21 Switched Log Settings

**Receive Overrun** – Insufficient buffers were allocated for the current task.

**CP (2x or 6x)** – A Call Progress Signal was received that can be retried (Category 2x or 6x).

**Unexpected Condition/Overrun/Underrun** – Same as TP leased.

**Not +/BEL** – An unexpected character was received from the network while awaiting a “Proceed to Select” or “Incoming Call”.

**Invalid Status/Write Timeout/MC** – Same as TP leased.

**Selector Signal** – An invalid character was detected in the selection signals.

**X.21 Timeout** – A network timeout has occurred.

**Extension** – Additional status can be found in Register 13 in Control Space.

**DCE Not Ready** – The controller detected that the network is not ready.

**DCE Cleared** – The controller has responded to a clearing sequence from the network.

**CP Available** – The controller has received a Call Progress Signal from an X.21 Switched Network as a result of issuing an outgoing call to the network.

**Format Error** – The Call Progress Signal or Line Identification or DCE Provide Information did not end with the proper delimiter (IA5+).

**Note:** *These functions are not supported by the 3274 Model 51C.*

**ID/DP Available** – The controller received either a Line Identification or DCE Provide Information from the network.

**Retry Timeout** – The controller has been monitoring the network for an incoming call for 3 seconds.

**+/BEL Received** –

**BEL** – The controller has detected an incoming call.

**+ Received** – The network has signaled to the controller to transmit the selection signals (dial number) as a result of a request to process an outgoing call.

**Lost Data** – Insufficient buffer allocation has been detected during receipt of either a Call Progress Signal or DCE Provide Information.

**Comparator Error** – The hardware has detected a mismatch between the signals on the input and output of the drivers and/or receivers.

**Last Retry** – The specifiable limit on retries has been exceeded.

**Clear Timeout** – During execution of a close function request, the clearing sequence did not terminate properly.

**Receive Overrun** – Insufficient buffers were allocated for the current task.

**CP (2x or 6x)** – A Call Progress Signal was received that can be retried (category 2x or 6x).

**Invalid Status/Write Timeout/MC** – Same as TP leased.

**Clear Timeout** – During execution of a close function request, the clearing sequence did not terminate properly.

### 3.3.14 Test 1 Extension for X.21 Switched

The following version of Test A0/1 is used for the X.21 Switched attachment. Line 4 is used for an X.21 Switched specific event. Line 5 contains X.21 Switched counters.

```

Line 1  A0/1
Line 2  EEEE . . . . EEEE (same as HPCA)
Line 3  XXXX . . . . XXXX (same as HPCA)
Line 4  0022 4455 6678 KKMM LLII PPRR RRRR RRRR RRRR RRRR
Line 5  CCCC CCCC CCCC CCCC CCCC CCCC CCCC CCCC CCCC CCCC
  
```

Where: 00 = Last CP indicator of class 0X, 1X  
 22 = Last CP indicator of class 2X, 3X  
 44 = Last CP indicator of class 4X  
 55 = Last CP indicator of class 5X  
 66 = Last CP indicator of class 6X  
 78 = Last CP indicator of classes 7X, 8X and 9X  
 KK = Error Completion Flag Bits  
 MM = Extended Error Completion Modifier Bits  
 LL = Retry Modifiers  
 II = Intermediate Status Flag Bits  
 PP = Intermediate Status Modifiers  
 RR = Reserved  
 CC = X.21 Switched Error Counters

FIELD	BITS (NNN) IS NNN# ASSIGNED							
	0	1	2	3	4	5	6	7
KK	INV STAT (326)	SEL SIG (326)	0	WRTE T.O. (530)	X.21 T.O. (556)	MC (330)	CMPR ERR (562)	EXT
MM if X.21 T.O. set in KK*	0	0	T1 T.O.	T2 T.O.	T5 or T6 T.O. (CLR T.O.) (561)	T3A or T3B T.O.	T4 T.O.	
MM if EXT set in KK	0	0	NOT READY (557)	0	0	0	DCE CLR (559)	LAST RETRY
LL if LAST RETRY set in MM	0	RCV OVRN (326)	CP (2X or 6X)	UNEX COND (326)	OVER RUN (326)	UNDER RUN (326)	NOT +/BEL (560)	
II	CP AVAIL	FORM ERR (555)	ID/DP AVAIL	RETRY T.O.	+/BEL RCVD	LOST DATA (558)	CMPR ERR (562)	RETRY
PP if RETRY set in II	0	RCV OVRN	CP	UNEX COND	OVER RUN	UNDER RUN	NOT +/BEL	0

**Note:** The modifier fields will be zero if the specified conditions are not met.  
 If both Ext and X.21 T.O. are set, Ext will be shown.

X.21 Switched Error/Exception Counts:

- |                     |                          |                         |                             |
|---------------------|--------------------------|-------------------------|-----------------------------|
| 1. Comparator Error | 6. Lost Data             | 11. Not + BEL           | 16. CP available 6X         |
| 2. Format Error     | 7. DCE Cleared           | 12. CP available 0X, 1X | 17. CP available 7X, 8X, 9X |
| 3. X.21 Timeout     | 8. Last Retry            | 13. CP available 2X, 3X | 18. Clear Timeout           |
| 4. Invalid Status   | 9. CP                    | 14. CP available 4X     | 19. Spare                   |
| 5. Not Ready        | 10. Unexpected Condition | 15. CP available 5X     | 20. Spare                   |

### 3.4 X .25 A0/1 TEST

The following describes the format of the Host Adapter error log. The error log is displayed by entering an A0/1 Test request message.

Line 1	A0/1											
Line 2	NN00	0000	SSSS	SSSS	SSSS	SSSS	RRRR	RRRR	RRRR	RRRR		
Line 3	XXXX	XXXX	XXXX	XXXX	XXXX	XXXX	XXXX	XXXX	XXXX	XXXX	XXXX	
Line 4	RSRT	RSRT	CLRT	CLRX	CLRR	LARC	TARC	DICD	RCM1	RCM2	DIAG	DIAL
Line 5	CCCC	CCCC	CCCC	CCCC	CCCC	CCCC	CCCC	CCCC	....	(30 bytes displayed)		
Line 6												
Line 7	LLLL	LLLL	LLLL	LLLL	LLLL	LLLL	LLLL	LLLL	LLLL			
Line 8	LLLL	LLLL	LLLL	LLLL	LLLL	LLLL	LLLL	LLLL	LLLL			
Line 9	LLLL	LLLL	LLLL	LLLL	LLLL	LLLL	LLLL	LLLL	LLLL			
Line 10	CCCC	CCCC	CCCC	CCCC	CCCC	CCCC	CCCC	CCCC	CCCC			

Line 1: Name of test.

Line 2, where:

- NN = Communication Reminder 5NN that is associated with the error
- 00 = Always zero for X.25
- SS = Adapter sense bytes (identical to first eight bytes of HPCA sense)
- RR = Reserved

Line 3: HPCA counters. These are 1-byte counters in which XX represents the value counted in hexadecimal. The counter values range from 00-FF and do not wrap.

HPCA Ctr	Map via CAC adapter return code (ARC)
1	Reserved
2	Reserved
3	Reserved
4	Reserved
5	Reserved
6	Re-tries exceeded maximum limit
7	Reserved
8	Reserved
9	FRMR transmitted
10	DCE hardware error
11	Write timeout
12	Invalid status
13	Adapter Machine Check
14	Reserved

Line 4, where:

- RSRT = Cause and diagnostic codes for last restart packet transmitted by the 3274.
- RSTR = Cause and diagnostic codes for last restart packet received by the 3274.
- CLRT = Diagnostic code modifier and diagnostic codes for last clear or reset packet transmitted by the 3274.
- CLRX = Extension for cause and diagnostic codes for last clear or reset packet sent by 3274.
- CLRR = Cause and diagnostic codes for last clear or reset packet received by the 3274.
- LARC = Reserved for engineering use.
- TARC = Last bad termination ARC (NNN=539).
  - 0AC0 SABM Received
  - 0AC6 Unexpected UA Received
  - 0AC7 N(s) Not Sequencing
  - 8AC1 FRMR Received
  - 8AC2 FRMR Sent
- DICD = Reason code for last packet discarded event. Refer to Figure 2-14 in Chapter 2 of this manual.
- RCM1 = Reason code modifier for additional information on a FRMR sent or received.
- RCM2 = Reason code modifier for additional information on a FRMR sent or received.
- DIAG + DIAL = Information field from the last Diagnostic packet received by the 3274.

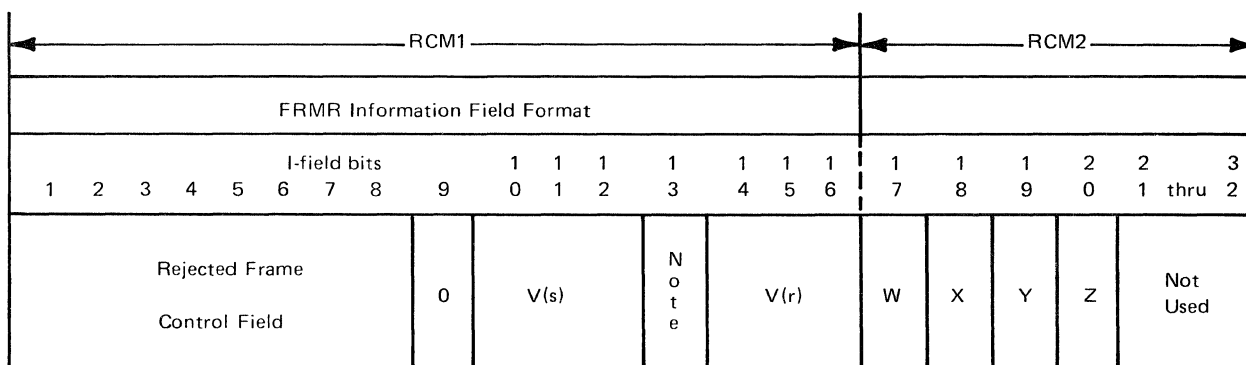

- Rejected frame control field is the control field of the received frame that caused the (text deleted) frame reject.
- Vs is the current value of Vs at the station reporting the rejection condition (bit 10 = low order bit).
- Vr is the current value of Vr at the station reporting the rejection condition (bit 14 = low order bit).
- 'W=1' indicates that the control field received and returned in bits 1 through 8 was considered invalid or not implemented.
- 'X=1' indicates that the control field received and returned in bits 1 through 8 was considered invalid because the frame contained an information field which is not permitted or is an S or U-frame with incorrect length. 'W=1' is required in conjunction with this bit.
- 'Y=1' indicates that the information field received exceeded the maximum established capacity of the station reporting the rejection condition.
- 'Z=1' indicates that the control field received and returned in bits 1 through 8 contained an invalid Nr.

**Note:** (Text deleted) Bit 13 is set to:  
 '1' if the frame rejected was a response; or,  
 '0' if the frame rejected was a command.

Line 5: X.25 Auxiliary counters. These are 1-byte counters in which XX represents the value counted in hexadecimal. The counter values range from 00–FF and do not wrap.

**Aux Ctr Value**

*Link Level*

- 1 SABM received
- 2 FRMR received
- 3 DISC received
- 4 DCE not available
- 5 Unexpected UA received
- 6 Send sequence number not sequencing
- 7 Restart sent
- 8 Restart received
- 9 Reserved
- 10 Reserved
- 11 Reserved

*Circuit Level*

- 12 Reset packets sent
- 13 Reset packets received
- 14 Clear packets sent
- 15 Clear packets received
- 16 Call timeouts
- 17 Call-connected truncated
- 18 Call parameter changes
- 19 Packets discarded
- 20 Packet timeouts
- 21 Contacts received
- 22 Discontacts received
- 23 Channel inoperative or no channel available

**Aux Ctr Value**

*Circuit Level*

- 24 Channel in invalid state
- 25 Diagnostic packets received
- 26–30 Reserved

Line 6 is a blank line.

Lines 7–10: X.25 Statistical counters. These are half-word counters where,  
 LLLL = Counters for link-level events (8 per line)  
 RRRR = Reserved  
 CCCC = Counters for circuit-level events (8 per line)

The values of the LLLL and CCCC counters range from 0000–FFFF and do not wrap.

Line 7: Link-level events

**Diag Ctr Value**

- 1 I-frames sent
- 2 I-frames received
- 3 RR-frames sent
- 4 RR-frames received
- 5 RNR-frames sent
- 6 RNR-frames received
- 7 REJ-frames sent
- 8 REJ-frames received

Line 8: Link-level events (cont.)

Diag Ctr	Value
9	Re-tries on transmit
10	FCS errors on receive
11	Receive errors
12	CS underruns
13	Receive-buffer overruns
14	Receive control-block overruns
15	Aborts
16	CS overruns

Line 9: Link-level events (cont.)

Diag Ctr	Value
17	Receive timeouts
18	Reserved
19	Call attempts
20	Call completions
21–24	Reserved

Line 10: Circuit-level events

Diag Ctr	Value
25	Data packets sent
26	Data packets received
27	RR packets sent
28	RR packets received
29	Reserved
30	RNR packets received
31	Interrupt packets sent
32	Interrupt packets received

3.4.1 X.25 Counters

Following is a list of the counters associated specifically with the X.25 function. They include HPCA counters, X.25 Auxiliary counters (both link level and circuit level), and X.25 Statistical counters (both link level and circuit level). They are listed by counter number; counters not listed are reserved.

**Note:** *CCDD = cause and diagnostic codes.*

3.4.1.1 HPCA Counters

- Counter 6 RE-TRIES EXCEEDED LIMIT: A link level error condition exists that has not been cleared by re-tries. The link and circuit have been stopped and a restart attempted.
- Counter 9 FRMR TRANSMITTED: An FRMR has been sent by the 3274 due to an error in a received I-frame. A DISC has been sent. The link and circuit have been stopped and a restart attempted (nnn = 539).
- Counter 10 DCE HARDWARE ERROR: Data Set Ready (nnn = 501) or Clear-to-Send (nnn = 502) from the DCE have been interrupted, or another DCE abnormal condition (nnn = 529) was detected. The link and circuit have been stopped and a restart attempted.

- Counter 11 WRITE TIMEOUT: Clocking from the DCE has been interrupted. The link and circuit have been stopped and a restart attempted (nnn = 530).
- Counter 12 INVALID STATUS: A 3274 communications adapter problem has been encountered (nnn = 331).
- Counter 13 ADAPTER MACHINE CHECK: A 3274 communications adapter problem has been encountered (nnn = 330).

3.4.1.2 X.25 Auxiliary Counters (Link-Level)

- Counter 1 SABM RECEIVED: A valid SABM link-level command was received from the DCE after normal initiation sequences. The 3274 has sent a DISC and terminated the link (nnn = 539).
- Counter 2 FRMR RECEIVED: An FRMR has been received. A DISC has been sent. The link and circuit have been stopped and a restart attempted (nnn = 539).
- Counter 3 DISC RECEIVED: A DISC has been received. A UA response has been sent. The link and circuit have been stopped and a restart attempted (nnn = 504).
- Counter 4 DCE NOT AVAILABLE: A DM has been received in response to a SABM, indicating that the DCE is not ready to communicate. A restart is attempted (nnn = 517).
- Counter 5 UNEXPECTED UA: A UA response has been received. A DISC has been sent. The link and circuit have been stopped and a restart attempted (nnn = 539).
- Counter 6 SENT SEQUENCE NUMBER NOT SEQUENCING: Multiple I-frames have been received with the same send sequence number. The link and circuit have been stopped and a restart attempted (nnn = 539).
- Counter 7 RESTART SENT: A restart packet has been sent due to an error. The link and circuit have been stopped and restarted. Analyze the diagnostic code in the event log to determine the cause. X.25 Communication Check Reminder indicator (R CCDD) is displayed.
- Counter 8 RESTART RECEIVED: A packet-level restart has been received. The link and circuit have been stopped and a restart attempted. Analyze the cause and diagnostic codes in the event log to determine the cause. X.25 Communication Check Reminder indicator (N CCDD) is displayed.



### 3.4.1.3 X.25 Auxiliary Counters (Circuit-Level)

- Counter 12 RESET SENT: A reset packet has been sent due to an error. The circuit has been stopped and restarted. Analyze the diagnostic code in the event log to determine the cause. X.25 Communication Check Reminder indicator (M CCDD) is displayed.
- Counter 13 RESET RECEIVED: A reset packet has been received. The circuit has been stopped. Analyze the cause and diagnostic codes in the event log to determine the cause. X.25 Communication Check Reminder indicator (Q CCDD) is displayed.
- Counter 14 CLEAR SENT: A clear packet has been sent due to an error. The circuit has been stopped and restarted. Analyze the diagnostic code in the event log to determine the cause. X.25 Communication Check Reminder indicator (L CCDD) is displayed.
- Counter 15 CLEAR RECEIVED: A clear packet has been received. The circuit has been stopped. Analyze the cause and diagnostic codes in the event log to determine the cause. X.25 Communication Check Reminder indicator (P CCDD) is displayed.
- Counter 16 CALL TIMEOUT: The response to a Call Request packet has not been received within the time specified. An attempt is made to restart the circuit (nnn = 537).
- Counter 17 CALL CONNECT TRUNCATED: A Call Request packet has been received which is larger than the buffer reserved for the packet.
- Counter 18 CALL PARAMETER CHANGE: This condition is posted on completion of an open circuit for an SVC if the flow control negotiation parameters received in the Call Connected packet are different from those entered during customizing or via the Dial screen.
- Counter 19 PACKET DISCARDED: A packet has been discarded. Analyze the diagnostic code field in the event log to determine the reason.
- Counter 20 PACKET LEVEL TIMEOUT: 200 seconds have elapsed without receiving a response to a clear, reset, or restart packet. The circuit and link have been stopped (nnn = 538).
- Counter 21 CONTACT RECEIVED: A LLC Contact packet has been received.
- Counter 22 DISCONNECT RECEIVED: A LLC Disconnect packet has been received (nnn = 504).
- Counter 23 CHANNEL INOPERATIVE: The PVC channel is inoperative due to a timeout. The circuit is stopped (nnn = 513), *or* NO CHANNEL AVAILABLE. No channel is available for the outgoing call (nnn = 513).
- Counter 24 CHANNEL IN INVALID STATE: An Incoming Call packet has been received and the 3274 was not in the proper state. The circuit is stopped (nnn = 513).
- Counter 25 DIAGNOSTIC PACKET RECEIVED: A Diagnostic packet was received. Analyze the diagnostic code and explanation field in the event log to determine the cause.

### 3.4.1.4 X.25 Statistical Counters (Link-Level)

- Counter 1 I-FRAMES SENT: The number of I-frames sent by the 3274.
- Counter 2 I-FRAMES RECEIVED: The number of I-frames received by the 3274.
- Counter 3 RR-FRAMES SENT: The number of RR-frames sent by the 3274.
- Counter 4 RR-FRAMES RECEIVED: The number of RR-frames received by the 3274.
- Counter 5 RNR-FRAMES SENT: The number of RNR-frames sent by the 3274.
- Counter 6 RNR-FRAMES RECEIVED: The number of RNR-frames received by the 3274.
- Counter 7 REJ-FRAMES SENT: The number of REJ-frames sent by the 3274.
- Counter 8 REJ-FRAMES RECEIVED: The number of REJ-frames received by the 3274.
- Counter 9 RETRIES ON TRANSMIT: The number of I-frames that had to be retransmitted by the 3274 due to Nr mismatches.
- Counter 10 FCS ERRORS ON RECEIVE: The number of I-frames received by the 3274 Frame Check Sequence errors.
- Counter 11 RECEIVE ERRORS: The number of receive errors detected by the 3274.
- Counter 12 CYCLE STEAL UNDERRUNS: The number of cycle underruns detected by the 3274. This is an internal exception condition and is re-tried by the 3274.
- Counter 13 RECEIVE BUFFER OVERRUNS: The number of receive buffer overruns detected by the 3274. This is an internal exception condition and is re-tried by the 3274.

- Counter 14 **RECEIVE CONTROL BLOCK OVERRUNS:** The number of receive control block overruns detected by the 3274. This is an internal exception condition and is re-tried by the 3274.
- Counter 15 **ABORTS:** The number of ABORTS detected by the 3274.
- Counter 16 **CS OVERRUNS:** The number of CS overruns detected by the 3274. This is an internal exception condition and is re-tried by the 3274.
- Counter 17 **RECEIVE TIMEOUTS:** A valid frame has not been received within the time specified. The link and circuit have been stopped and a restart attempted (nnn = 520).
- Counter 19 **CALL ATTEMPTS:** The number of call attempts counted by the 3274.
- Counter 20 **CALL COMPLETIONS:** The number of call completions counted by the 3274.

**3.4.1.5 X.25 Statistical Counters (Circuit-Level)**

- Counter 25 **DATA PACKETS SENT:** The number of data packets sent by the 3274.
- Counter 26 **DATA PACKETS RECEIVED:** The number of data packets received by the 3274.
- Counter 27 **RR PACKETS SENT:** The number of RR packets sent by the 3274.
- Counter 28 **RR PACKETS RECEIVED:** The number of RR packets received by the 3274.
- Counter 30 **RNR PACKETS RECEIVED:** The number of RNR Packets received by the 3274.
- Counter 31 **INTERRUPT PACKETS SENT:** The number of interrupt packets sent by the 3274.
- Counter 32 **INTERRUPT PACKETS RECEIVED:** The number of interrupt packets received by the 3274.

**3.5 TEST 2: DISPLAY CONFIGURATION INFORMATION**

The configuration data obtained from TEST 2 results from customizing the Feature Diskette and the subsequent writing of the configuration data to the System Diskette or Load Diskette. The following tables describe the more commonly required information in the order that the information appears on the display. Also included is an indication of the customization question associated with the particular data. (The customizing process is described in the *3274 Control Unit Planning, Setup, and Customizing Guide, GA27-2827.*)

The format of the configuration data charts is as follows:

- Column 1 Information — the definition of the data at the provided location indicated in Column 2.
- Column 2 Location — Describes the location in hexadecimal of the desired data.
- Column 3 Setting — Describes the pertinent bit settings or hexadecimal values.
- Column 4 Meaning — Describes the meaning of the particular bit settings or describes the contents of the data location.
- Column 5 Page/Line/Byte — This information will help you to find the byte under discussion.
  - Page indicates the value that should appear in display line 2 if you are in the proper block of configuration data for the byte in question.
  - Line indicates which line of the four lines of data being displayed contains the byte you are looking for.
  - Byte is the displacement of the byte in question from the start of the line. There are 16 bytes (00 to 0F hex) per line.

Column 6 Customizing — Indicates which customizing Question question, number and the value that caused the results.

When, in Test mode, the /2 is typed in (starting at location 0 on the display) and the Enter Key is depressed, a display similar to the following example will appear on the display. Lines 3-6 each represent 16 bytes of data, displayed in hex.

```
Line 1 /2
Line 2 00
Line 3 E245 4540 0400 0001 0140 6001 0021 040F
Line 4 0004 0402 0001 1304 0410 1020 0040 0199
Line 5 2020 041F 1003 0300 2027 FC8E EF0C 0F01
Line 6 2004 7700 8242 FFFE A55A 0100 003F 0000
```

By pressing the enter key, the next X'40' (64 decimal) bytes of the Configuration Table will be displayed. Line 2 indicates the starting location of the first byte displayed. (The last (0) digit is dropped.)

Line 1	/2
Line 2	04
Line 3	4000 0000 0000 0000 0000 0000 0000 0000
Line 4	0000 0100 9808 7151 2500 0000 0000 0000
Line 5	0000 0000 0000 0000 0000 0000 0000 0000
Line 6	9900 9900 0000 4000 0000 0000 0003 017F

The amount of Configuration Data displayed depends on the Configuration Support Level of the 3274 Microcode that is installed. In all cases, the Enter Key will 'page' to the next X'40' bytes (64 decimal), if more information is available to be displayed. If there is no more information to be displayed, pressing the Enter Key will cause the Keyboard to be inhibited. (X-f will be displayed in operator information area.) Line 2 will serve as an indication of location of the first byte displayed on Line 3. For example, if Line 2 contains a 08 the location in the table of the first byte displayed on Line 3 is X'80'.

Information Provided	Location	Hex Dig./Bit Setting	Meaning	Page/Line/Byte	Customization Question	
Disk. Type Identifier	00	D4 E2 E6	Feature System Load	00/3/00	N/A	
Diskette Level ID's	01 02 03	nn nn nn	Feature System Language	00/3/01 00/3/02 00/3/03	N/A	
3274 Model Number and Communications Adapter Type	04	84 A4	51C/52C CCA/HPCA 61C	00/3/04	151	
3274-C Models, Line Code	07	01	EBCDIC	00/3/07	321 = 0 Not CS-D	
		02	ASCII		321 = 1 Not CS-D	
3274-C Models, Line Control Mode	08	01	BSC	00/3/08	331 = 0	
		02	SDLC		331 = 1	
		06	X.25		331 = 2	
3274-C Models, BSC Address	09	nn	3274 BSC Poll Address	00/3/09	Derived from 301 (location ID contains 301; value)	
3274-C Models, Selection Address  Secondary Station Address	0A	nn	BSC	00/3/0A	Derived from 301 (see Location 1D 301's value)	
			SDLC			302 = nn
			X.25			302 = nn
Miscellaneous Options Selection	0B	01	CCA	00/3/0B	351 = 0	
		02	HPCA		351 = 1	
		04	Encrypt/Decrypt		352 = 1	
		08	Requested Screen to Assign Ports Individually		116 = 1	
		10	Printer Polled by Host		305 = 1	
3274-C Models, Remote Attachment Options	0C	00	CCITT V.35 or Exter. Modem Interface	00/3/0C	CS-A, B C, T	CS-D, P
			Wrappable Modem		343 = 0	343 = 00
			DDSA Adapter		311 = 1	311 = 1
			X.21 Leased		343 = 1	343 = 01
			Integrated Modem > 1200 BPS		343 = 2	343 = 02
			X.21 Switched		343 = B	343 = 11
			MCL Loop		343 = 3	343 = 03
			EMI		343 = A	343 = 10
			Integrated Modem 1200 BPS		343 = 4	343 = 04
3274 Models, Comm. Options	0D	01 02 04 08 10 20 40 80	Omit answer tone Permanent RTS (4 wire point to point) Half Speed SNBU (Select Standby) Special RTS (BSC from selection till EOT) Leased Line NRZI WT DCE Switched Network	00/3/0D	345 = 1 Value = 0 if 317 = 1 = 0 if 314 or 342 = 0 318 = 1 317 = 1 Value = 0 if 314 = 0 and 342 = 1 Value = 0 if 343 = 3, 4, or 6 = 0 if 343 = 0 and 317 = 1 Value = 1 all other cases 313 = 1 310 = 1	

Figure 3-12 (Part 1 of 10). Subsystem Configuration



Information Provided	Location	Hex Dig./Bit Setting	Meaning	Page/ Line/ Byte	Customization Question
Type B Driver/ Receiver	17	01 02 03 04	1 Card 2 Cards 3 Cards 4 Cards	00/4/07	111
Type A Driver/ Receiver	18	02 04 06 08	1 Card 2 Cards 3 Cards 4 Cards	00/4/08	112
Number of Category B Devices Installed	19	nn	Answer to Question 111	00/4/09	111 = nn
Number of Category A Devices Installed	1A	nn	Answer to Question 112	00/4/0A	112 = nn
Total number of Category A and Type B Devices Installed	1B	nn	111 + 112, Maximum of 32	00/4/0B	111, 112
Modem and Connection Options	1C	01	Loop Attach only High speed data rate	00/4/06	347 = 1
Control Unit Number	1D	nn	BSC Control Unit ID	00/4/0D	301 = nn
Language Code	1E	nn	Answer to 121	00/4/0E	121 = nn
Extended Function Store	1F	nn	First 2 digits of answer to 113	00/4/0F	113 = nnxx
Actual number of Type A Ports supported	20	nn	Number of Type A Device Control Blocks assigned by the 3274	00/5/00	Derived from 112, if 116 = 0 Derived from 117, if 116 = 1
Total number of Ports Supported	21	nn	Total number of Device Control Blocks assigned by the 3274	00/5/01	Derived from 112 + 111, if 116 = 0; if 116 = 1 Derived by 111 = 117's response. (To find the actual starting address for the first Type B Port sub- tract the value of Loc 20 from value of Loc 21.)
Print Authorization Matrix Entry Count	22	xx		00/5/02	022
Keyboard Types	23	01 02 04 08 10	Typewriter Data Entry Data Entry 11 APL Text	00/5/03	131 = 1 132 = 1 133 = 1 134 = 1 135 = 1 } No Question for CS-D
ECSA Adapter (configurations that support SFAP Data Stream Processing)	24	nn	Number of terminals with ECSA installed	00/5/04	163 = nn For CS-D this field is set by value in Location 20.
SFAP Data Stream Support Options (Configurations that support SFAP Data Stream Processing)	25	01	Color Terminals	00/5/05	161 = 1
		02	PS Terminals Installed		164 = 1 If CSD, set by 160 = 1
	26	01	SFAP Data Stream Supported	00/5/05	162 = 1 If CSD, set by 160 = 1
		02	Decompression Supported		165 = 1
X.21 Switched Retry Timing	27	Seconds Between Retries	Two-digit Number 00 through 20	00/5/07	381

Figure 3-12 (Part 3 of 10). Subsystem Configuration

Information Provided	Location	Hex Dig./Bit Setting	Meaning	Page/Line/Byte	Customization Question
Validation Number	28-29	Last 2 Characters of Cust. Question #001	Validation number printed on label of feature and system diskettes	00/5/08-09	001
SDLC X.21 Switched	3D	80	Direct key support on all terminals	00/6/0D	362 = 1XXX XXXX
		40	Dial key support on all terminals		362 = X1XX XXXX
		20	Local/Comm Key support		362 = XX1X XXXX
		10	Disconnect Key support on all terminals		362 = XXX1 XXXX
		08	Ext. Key support on all terminals		362 = XXXX 1XXX
		04	Reserved		
		02	DCE Support direct call		362 = XXXX XX1X
		01	DCE Support address call		362 = XXXX XXX1
Number of automatic re-dial attempts allowed	3E	nn	0 through 99	00/6/0E	360 (X.21) 451 (X.25)
Ring Time (Time between Automatic Re-dial Attempts (X.21))	3F	80	12.8 seconds	00/6/0F	361
		40	6.4 seconds		
		20	3.2 seconds		
		10	1.6 seconds		
		08	0.8 seconds		
		04	0.4 seconds		
		02	0.2 seconds		
		01	0.1 seconds		
Diskette Zapped	40	Not Zero	Not Zero value indicates diskette has been zapped with F-X	04/3/00	N/A
1200 bps Integrated Modem	41	00	Not Installed	04/3/01	343 = 5
		80	Feat. 5500		343 = 6
		40	Feat. 5501		343 = 7
		20	Feat. 5502		343 = 8
		10	Feat. 5507		343 = 9
		08	Feat. 5508		
Patch ID's	42-51		Each 1 byte field contains a patch ID. 00 indicates no patch.	04/3/02 to 04/4/01	011, 012, 013
Number of RPO Diskette Installed	52	nn	Number input in Question 031 (0-3)	04/4/02	031 = nn

Figure 3-12 (Part 4 of 10). Subsystem Configuration

Information Provided	Location	Hex Dig./Bit Setting	Meaning	Page/ Line/ Byte	Customization Question
<p>For configuration support below "D" only</p> <p>RPQ Information</p> <p>For each field at the right, the 10 decimal digits are broken down as follows:</p> <p>The first 3 digits represent the last 3 digits of the RPQ number.</p> <p>The last seven digits represent the media assembly bill of materials assigned by manufacturing. Example: RPQ 8K0 980, media assembly bill of materials 5675103 would display as: 9805 6751 03.</p> <p>For configuration support "D" and above: Last 4 digits of RPQ number, followed by a 6 digit number.</p>	54-58	See explanation at left	RPQ #1	04/4/04-08	N/A
	59-5D		RPQ #2	04/4/09-0D 04/4/0E to 04/5/02	
	5E-62		RPQ #3		
Feature Diskette Expected Suffix	63	XX	From Feature Diskette	04/5/03	N/A
System Diskette Expected Suffix	64	XX	From System Diskette	04/5/04	N/A
Language Diskette Expected Suffix	65	XX	From Language Diskette	04/5/05	N/A
Software ECC	66	40 20	ECC Function Configured ECC RAS Function Configured	04/5/06	N/A
Physical Unit ID Number	67-69	XX XX XX	1st Nibble of XID 2nd Nibble of XID 3rd Nibble of XID	04/5/07-09	215
3290 Configured Support	6A	80	3290 Support Configured	04/5/0A	171 = 1
		40	Transfer of Operational Load Module to Load Diskette		N/A
		20	3290 Dump Complete		N/A
		10	Multiple Interactive Screen Support		171 – CS-T or 117 – CS-D
		08	Information Display Panel (Load Diskette not Required)		170 = 2
Diskette Copied Using Copy Utility	6B	C3	Set by Disk Copy Utility	04/5/0B	N/A
X.25 Non-Standard Window Size	6E	01-07 01-11	Range for Modulo 8 Range for Modulo 128	04/5/0E	435
<p>EC Levels</p> <p><b>Note:</b> All EC Levels are expressed as release level and A suffix. For example Release 43.1 will display as 4301.</p>	70, 71 72, 73 74, 75	nn nn nn nn nn nn	Feature Diskette Level and Suffix System Diskette Level and Suffix Language Diskette Level and Suffix	04/6/00, 01 04/6/02, 03 05/6/04, 05	N/A

Figure 3-12 (Part 5 of 10). Subsystem Configuration



Information Provided	Location	Hex Dig./Bit Setting	Meaning	Page/ Line/ Byte	Customization Question
RPQ Information  <b>Note:</b> <i>The configuration Support Flags at the right indicate the 3274 Configuration Support Level for which the RPQ was released. Any mismatch between this setting and the Microcode Configuration Support Level (appears on the system disk) should be validated with your IBM Sales Representative for proper support.</i>	76	0XXXXXXX	RPQ1 If the high order bit of the first byte = 0 this byte contains RPQ EC Level.	04/6/06	N/A
		1XXXXXXX	If the high order bit of the first byte = 1 the byte listed has the meaning listed below and the second byte 77 = 00.		
		C000	Configuration Support D		
		8400	Configuration Support C		
		8800	Configuration Support T		
		8200	Configuration Support B		
	8100	Configuration Support A			
	77	nn	If high order bit of byte 76 = 0 RPQ1 Level Suffix	04/6/07	
	78	xx	RPQ2 (same as byte 76)	04/6/08	
	79	nn	RPQ2 Level Suffix	04/6/09	
	7A	xx	RPQ3 (same as byte 76)	04/6/0A	
	7B	nn	RPQ3 Level Suffix	04/6/0B	
Magnetic Reader Type	7C	00	None	04/6/0C	141 = A
		01	Numeric 3270 Compatible		141 = B
		02	Alphameric (Auto Entry for non-display data)		141 = C
		03	Alphameric (Auto Entry for all data)		141 = D
Attribute select keyboards (only valid for configuration Support Levels that support SFAP Data Stream Processing)	7D	00	No attribute select keyboards supported	04/6/0D	166 = A
		01	Attribute Select keyboards – w/o numeric lock		166 = B
		02	Attribute select keyboards with numeric lock.		166 = C
Alert Function Requested	8A	00	No Alert Function	05/3/0A	220 = 0
		01	Alert Without Test Alert Capability		220 = 1
		02	Alert With Test Alert On Port 0 Only		220 = 2
		03	Alert With Test Alert On All Ports		220 = 3
X.25 Non-Standard Packet Size	8B (high order nibble)	0	64 Byte Packet	08/3/0A	434 = 0
		1	128 Byte Packet		434 = 1
		2	256 Byte Packet		434 = 2
		3	512 Byte Packet		434 = 3
Load Diskette	90	xx	Load Diskette EC Number	08/4/00	N/A
EC + Suffix Number	91	xx	Load Diskette Suffix Number	08/4/01	N/A
3290 RPQ ID Number	92-96	XXXXXXXXXX	Ten digits	08/4/02-06	N/A
MIS Definition (Configuration Support T only)	97	xx	First port with MIS	08/4/07	171
	98	xx	Number of ports with two Logical Terminals	08/4/08	171
	99	xx	Number of ports with three Logical Terminals	08/4/09	171
	9A	xx	Number of ports with four Logical Terminals	08/4/0A	171
	9B	xx	Number of ports with five Logical Terminals	08/5/0B	171
3290 RPQ Options	9C-9D	xxxx	Defined by 3290	04/5/0C-0D	N/A

Figure 3-12 (Part 6 of 10). Subsystem Configuration

Information Provided	Location	Hex Dig./Bit Setting	Meaning	Page/Line/Byte	Customization Question
3290 Features and Functions	9F	80	Enable 3290 Local Copy	04/5/0E	173 = 1XXX XXXX = X1XX XXXX = XX1X XXXX
		40	Auto Form Feed before Local Copy		
		20	Auto Form Feed after Local Copy		
Physical and Logical Devices	A1	xx	Number of Physical and Logical Devices defined on the 3274	08/5/01	171 + 112 if CS-T 111 + 117 if CS-D
Number of MIS	A2	xx	Number of Logical Terminal Extensions	08/5/02	171 if CS-T 111 + 117 if CS-D
3290 Keypad Selection	A3	00	Default Keypad (based on national language).	08/5/03	139 = 0
		01	24-Key Numeric		139 = 1
		02	25-Key Numeric with Comma on Key 4		139 = 2
		03	25-Key Numeric with Decimal Point on Key 4		139 = 3
		07	Program Function Keypad		139 = 7
Optional Code Selection	A4	80	Clear Key Unsupported Control Codes Clicker Option	08/5/04	125 = 1XXX XXXX 125 = X1XX XXXX 125 = XX1X XXXX
		40			
		20			
X.25 Incoming Call Options	A6	XXXX XXX1	Bit-7 Reserved	08/5/06	420
		XXXX XX1X	Negotiate throughput Class		
		XXXX X1XX	Validate CID on Incoming Packets		
		XXXX 1XXX	Negotiate Window Size		
		XXX1 XXXX	Negotiate Packet Size		
		X11X XXXX	If bit positions designated 11 equal:		
		00	Don't accept calls with reverse charge facility		
		01	Accept calls w/reverse charge facility = reverse charge requested		
10	Accept calls with reverse charge facility <i>not</i> requested				
11	Accept calls w/reverse charge facility and either reverse charge requested or <i>NOT</i> reverse charge accepted				
1XXX XXXX	Validate Calling DTE address				
X.25 Outgoing Call Options	A7	XXXX XXX1	Bit-7 Reserved	08/5/07	421
		XXXX XX1X	Include throughput class facility in Call Request packet		
		XXXX X1XX	Include CID in the call user data field of call user packet		
		XXXX 1XXX	Include window size facility field in call request packet		
		XXX1 XXXX	Include packet size facility field in call request packet		
		X11X XXXX	If bit positions designated 11 equal:		
		00	Don't include reverse call facility in call request packet		
		01	Request reverse charge via reverse charge facility		
10	Request <i>NO</i> reverse charge via reverse charge facility field				
11	Invalid				
1XXX XXXX	Supply Calling DTE address in call request packet				

Figure 3-12 (Part 7 of 10). Subsystem Configuration

Information Provided	Location	Hex Dig./Bit Setting	Meaning	Page/ Line/ Byte	Customization Question
X.25 Negotiate Packet Size	A8 (high order nibble)	0 1 2 3	64 Byte Packet 128 Byte Packet 256 Byte Packet 512 Byte Packet	08/5/08	430 = 0 430 = 1 430 = 2 430 = 3
X.25 Packet Sequence Numbering	A8 (low order nibble)	0 1	Modulo 8 Modulo 128	08/5/08	431 = 0 431 = 1
X.25 Negotiate Window Size	A9	01–07 01–11	Range for Modulo 8 Range for Modulo 128	08/5/09	432 = nn
X.25 Throughput Class	AA (high order nibble)	3 4 5 6 7 8 9 A B C	75 bps 150 bps 300 bps 600 bps 1200 bps 2400 bps 4800 bps 9600 bps 19200 bps 48000 bps	08/5/0A	440 = 3 440 = 4 440 = 5 440 = 6 440 = 7 440 = 8 440 = 9 440 = A 440 = B 440 = C
X.25 K-Maximum Out	AA (low order nibble)	1–7	Maximum number of link level I-frames that the 3274 will transmit prior to waiting for acknowledgement	08/5/0A	433 = n
Closed User Group	AB	00–99	Include closed user group facility in outgoing call request packet	08/5/0B	441
X.25 Recognized Private Operating Agency (RPOA)	AC–AD	0000–9999	Used to select intermediate network to be used between two public networks	08/5/0C 08/5/0D	442 = nnnn
X.25 Keyboard Support	AE	XXXX XX1X 0 1 XXXX X1XX 0 1 XXXX 1XXX 0 1 XX11 XXXX 00 01 10 11 11XX XXXX 00 01 10 11	If bit position designated 1 equals: Take appropriate action – DISC (SVC) or LOCAL (PVC) key off only if no LU's active DISC (SVC) or LOCAL (PVC) key (disconnect or local mode) If bit position designated 1 equals: Display all fields on Dial Screen Display only HNAD on Dial Screen If bit position designated 1 equals: X.25 keys supported on Port 0 only X.25 keys supported on all ports If bit positions designated 1 equal: X.25 LOCAL and COMM keys are not supported on 3274 X.25 LOCAL and COMM keys are supported on Port 0 X.25 LOCAL and COMM keys are supported per XXXX 1XXX bit above Invalid If bit positions designated 1 equal: X.25 DISC key <i>not</i> supported on 3274 X.25 DISC key supported on Port 0 X.25 DISC key supported per XXXX 1XXX bit above Invalid	08/5/0E	443

Figure 3-12 (Part 8 of 10). Subsystem Configuration

Information Provided	Location	Hex Dig./Bit Setting	Meaning	Page/Line/Byte	Customization Question
X.25 Network Type	AF	00	CCITT Recommended network that has announced IBM support X.25 connection is to UKPSS or TELENET DDP-X	08/5/0F	400
		02			
		03			
RPO Parameter List	B0-BF	16X 'FF'	Specific information is supplied with the RPO.	08/6/00-0F	033
Type A Port Assignment Table	C0-CF	16 Hex Bytes	32 hex digits are displayed, one for each possible port	0C-3/00-0F	112 = 00 116 = 1 117 = Port-by-port assignment (Configuration Support "D" only)
Response Time Monitor Support	D0	00	Not Configured	0C/4/00	127 (X = 0)
		01	Configured - No Host Support Display from Port 0 only (SNA only)		127 (X = 1)
		02	Configured - No Host Support Display from all Ports (SNA only)		127 (X = 2)
		03	Configured - Host Support No Sub-system Display		127 (X = 3)
		04	Configured - Host Support Display from Port 0 only		127 (X = 4)
		05	Configured - Host Support Display from all Ports		127 (X = 5)
Response Time Monitor Definition	D1	00	Not Defined		127 (Y = 0)
		01	Host Attention Key to First Character on Screen		127 (Y = 1)
		02	Host Attention Key to Keyboard Usable		127 (Y = 2)
		03	Host Attention Key to Change Direction or End Bracket (SNA only)		127 (Y = 3)
Response Time Monitor	D2-D3	Minutes, Seconds, Tenths of Seconds, mm/ss/s	First Time Boundary	0C/4/02-03	128 B1 (Line 2)
	D4-D5		Second Time Boundary	0C/4/04-05	128 B2 (Line 3)
	D6-D7		Third Time Boundary	0C/4/06-07	128 B3 (Line 4)
	D8-D9		Fourth Time Boundary	0C/4/08-09	128 B4 (Line 5)
Response Time Monitor Options (Note: DO above must equal 3, 4, or 5 for this field to be displayed)	DA	80	Response Time Monitor Enabled	0C/4/0A	128 F1 (Line 1) 1XXX XXXX
		40	Unsolicited on Session End		128 F1 (Line 1) X1XX XXXX
		20	Unsolicited on Counter Overflow		128 F1 (Line 1) XX1X XXXX
		10	RTM Alerts Enabled		128 F1 (Line 1) XXX1 XXXX
X.25 Logical Link Control	DB (high order nibble)	0 1	PSH QLLC	0C/4/0B	403 = 0 403 = 1

Figure 3-12 (Part 9 of 10). Subsystem Configuration

Information Provided	Location	Hex Dig./Bit Setting	Meaning	Page/Line/Byte	Customization Question
X.25 Circuit Type	DB (low order nibble)	1 2 4 8	Permanent Virtual Circuit Incoming Call only Outgoing Call only Two-Way Call	0C/4/0B	401 = 1 401 = 2 401 = 3 401 = 4
X.25 Host DTE Network Address (HNAD)	DC-E3		15 packed decimal digits or spaces (16th position always set to F)	0C/4/0C through 0C/5/03	410 - digits (0–9, blanks or nulls)
X.25 3274 DTE Network Address (LNAD)	E4-EB		15 packed decimal digits or spaces (16th position always set to F)	0C/5/04 through 0C/5/0B	411 - digits (0–9, blanks or nulls)
X.25 Logical Channel ID	EC-ED	0000-0FFF	Channel ID for the circuit specified in byte DB (low order nibble) earlier in this table	0C/5/0C and 0C/5/0D	402 input = 0–4095
X.25 Link Level Transmit Timeout (Tp)	EE-EF	0000-2540	Number of one/tenth second intervals	0C/5/0E and 0C/5/0F	450 - Input example: 30 seconds = 300 x 0.1, value entered = 300

Figure 3-12 (Part 10 of 10). Subsystem Configuration

### 3.6 TEST 3: DISPLAY THE STATUS OF ALL CONFIGURED TERMINALS AND DISPLAY THE CONTROL UNIT SUMMARY COUNTERS

Test 3 is invoked after the ALT and TEST keys are used to enter Test mode. An entry of /3 from any functioning 3278 or similar display, and then an ENTER, will display one of the following formats on the screen (the actual format may vary, depending on how many devices have been configured):

Example 1:

- Line 1 – 01234567 8901
- Line 2 – 11111111 110 -
- Line 3 – 0000 0000 0000 0000 0000

Line 1 displays all the Category A devices, starting from the leftmost position. The digits correspond to the low-order digit of the coax port address. Therefore, port A0 = position number 0 and port A7 = position number 8. The Category B devices are separated from the Category A devices by 2 spaces. Therefore, port B0 = position number 8 in the log and port B03 = position number 11.

Line 2 displays the status (1 = on, 0 = off, and - = disabled) of each configured device.

Line 3 displays statistical counter information in summary form of control-unit-detected machine checks, communications checks, program checks, and SDLC test commands. The values are displayed in hexadecimal. The counters are two byte counters numbered from left to right starting at counter number 01. See the following example for counter meanings:

Counter	Meaning
0102	Summary of all machine checks
0304	Summary of all communications checks
0506	Summary of all program checks
0708	SDLC test commands received
0910	SDLC test commands sent

(Maximum counter values are FFFF)

Use the associated error logs (device/adaptor) to further define the summary counters. The maximum value of the counters is FFFF (hex). If a counter is incremented to the maximum value, it will remain there until reset by an IML or the A3/4 test.

Example 2:

Machine configured for 8 Category A and 4 Category B devices (Configuration Support B, C, T, and D only)

- Line 1 – 01234567 8901
- Line 2 – 10111X11 1001
- Line 3 – ddddd dd pppp TYP
- Line 4 – ..... .. COAX
- Line 5 – ..... .. DEV
- Line 6 – +++++ ++ +++ LU
- Line 7 – ## .914 666 1234
- Line 8 – 0000 00

Line 1 shows coax port addresses (0-A1). In this example the 3274 is configured for 12 devices (3 Category A displays and 4 Category B printers). Category A devices are always shown first. Printer and Category B devices are then shown separated by two spaces.

Line 2 shows the status of each device, where:

- 1 = device powered on
- 0 = device recognized as powered off
- = device recognized as disabled because of control-unit-detected errors
- x = indicates that the port is unavailable. The corresponding position in lines 3, 4, 5, 6, and 8 is blank (Configuration Support D and above).

Line 3 shows the type of device attached, where:

- d = display
- p = printer
- i = other
- = never initialized

Line 4 shows a summary of coax errors, where:

- . = 0 errors
- : = 1 - 9 errors
- | = 10 - 19 errors
- \* = 20 or more errors

Line 5 shows a summary of device errors, where:

- . = 0 errors
- : = 1 - 9 errors
- | = 10 - 19 errors
- \* = 20 or more errors

Line 6 shows a summary of sessions bound (this line will appear only for SNA attachments and is required for X.21 Switched), where:

- + = session bound
- blank = no session bound

Line 7 shows a display of dialed (X.21 Switched only), where:

- ## XXXX (up to 32 characters) dialed number entered by the keyboard
- ## 0000 = Direct call
- ## ---- = Incoming call

Line 8 consists of control unit statistical summaries.

### 3.7 X.25 /3 TEST

The /3 Test is modified as follows to inform the user of the currently-connected host address and the in-session status of the display stations.

Example of /3 Test Screen:

Line

```

1 | 012345678901234567890123 45678901
2 | 101110-1111011101111000 11111100
3 | dddddddddddddd i__i_pp d_dd_ppp TYP
4 | .....:.....| ..... COAX
5 | .....*.....:..... DEV
6 | + ++ + + + + LU
7 |                                     ## --> 555 8001212 459
8 |
9 | 0000 0010 0002 0015 0012

```

Line 1: 012345678901234567890123 45678901  
 Where the digits represent the low order digit of the coax port address attached in the configuration.  
 Type A adapter ports and Type B adapter ports are separated by two blank characters. (This example shows 24 Type A ports and 8 Type B ports.)

Line 2: 1, 0, or a - under each position in line 1.  
 Where 1 = Device powered on  
 0 = Device powered off or not attached  
 - = Device disabled because an error was detected at the control unit

Line 3: p, d, i, or a \_\_ under each position  
 Where p = Printer  
 d = Display  
 i = distributed-function device (e.g., 3290 Information Panel)  
 \_\_ = port never powered on  
 TYP indicates device type

Line 4 & 5: (.), (:), (|), or a (\*) under each character position ( ) Surround the character in question.  
 Where . = 0 errors  
 : = 1-9 errors  
 | = 10-19 errors  
 \* = Over 20 errors  
 COAX (Line 4) indicates coax errors  
 DEV (Line 5) indicates device errors

Line 6: + or a space under each position in line 1.

Where + = The device is in session with the host.  
a space = The device is not in session with the host.

Display 2 characters 'LU' after spacing 4 columns to the right of the session indication in this line.

Line 7: This line is omitted for PVC.

This line displays one of the three following variations for SVC:

(15 characters)  
## --> \_\_\_\_\_ indicates outgoing call performed. The 15 characters are the Host DTE address.

(15 characters)  
## <-- \_\_\_\_\_ indicates incoming call in session. The 15 characters are the Host DTE address

## <-- \_\_\_\_\_ indicates incoming call performed. No calling (Host) DTE address was provided in the Call Request packet.

The intent of Line 7 is to allow the user to tell what host the 3274 Control Unit is currently connected to (if Call Ready is displayed) or was connected to (if Call Ready is not displayed).

Line 8: This is a blank line.

Line 9: PPPP CCCC SSSS RRRR XXXX

Where,

PPPP = Summary count of control unit-detected product checks (Machine Checks)

CCCC = Summary count of Communication Checks

SSSS = Summary count of SNA errors (Program Checks)

RRRR = Summary count of XTEST Packets received

XXXX = Summary count of XTEST Packets transmitted

### 3.8 TEST 4: RESET ANY TEST 1 LOG

Test 4 provides the capability of resetting any device adapter, device, host adapter, or control logic log. By using the ALT and TEST keys, you may enter Test mode. Test 4 may now be used as shown below:

- 00 to 11/4 (51C) – Resets the device log for the device 00 to 07/4 (52C) specified to all zeros (0). 00 to 15/4 (61C)
- A0/4 – Resets the host adapter log to all zeros (0).
- A1/4 – Resets the Type A adapter log to all zeros (0).
- A2/4 – Resets the Type B adapter log to all zeros (0).
- A3/4 – Resets the control logic log to its initial values.

Test 4 may be used to track intermittent failures without re-IML or powering off the machine to clear the error logs.

### 3.9 TEST 5: REGISTER PAGE DISPLAY

This utility function provides for the display of register space. The format of the display will be:

```
Line 1 AA/5 (same as input)
Line 2 PP
Line 3 XXXX XXXX XXXX XXXX XXXX XXXX XXXX XXXX
Line 4 XXXX XXXX XXXX XXXX XXXX XXXX XXXX XXXX
Line 5 XXXX XXXX XXXX XXXX XXXX XXXX XXXX XXXX
Line 6 XXXX XXXX XXXX XXXX XXXX XXXX XXXX XXXX
```

Where:

PP = The register page (in hex) currently being displayed on line 3 (PP+1 on line 4, etc.)

XXXX = Hex representation of the register page

PA1 or the ENTER key may be used to page through register space four register pages at a time. Line 2 will be updated to show the starting page (in hex) of the register pages currently being displayed. Paging beyond the limit of register space is prohibited by the Do Not Enter minus function.

Valid address input (if entered on line 1) is ignored.



### 3.10 TEST 6: DEVICE CONTROL BLOCK DISPLAY

The device control block (DCB) contains common subsystem information pertaining to all terminals, device and host adapter information, and limited device-feature information. The Test 6 display represents the most current information regarding a specific device. The DCB should be checked when it is necessary to determine specific device parameters such as: (1) Is the device configured as display or printer? (2) Is the display screen size correctly specified? (3) Is an MDT bit set? (4) The status of keyboard for this device, etc.

To request Test 6, you must first enter Test mode by means of the ALT and TEST keys. The DCB for any device may be displayed by keying the device number followed by a slash (/), the number 6, followed by an ENTER key. Each DCB consists of four displays of 64 bytes each. The individual bytes are not labeled. There are six lines to each display. The first line displays the test request as entered. The second line of each display will indicate the beginning byte ID of that display: 00 to 04, 08, and 0C for the DCB; 10, 14, 18, and 1C if an extended DCB is present. See Figure 3-13 for details. You may page from one display to the next by pressing the ENTER key. Paging beyond display C1 will result in a locked keyboard and X-f displayed on the status line. See Figure 3-14 for DCB interpretation.

If a DCB, and an Extended DCB indicate that a 3290 is configured as a display, pressing ENTER will cause individual screens for each Logical Terminal (LT) to be displayed, — a maximum of five LT's. Each LT will display one line of, ten halfwords of hex information, defining the LT. After the last DCB/Extended DCB is displayed, the test sequence flow is as follows:

```
Press ENTER
  LT 0 displayed
Press ENTER
  LT 1 displayed
Press ENTER
  LT 2 displayed
Press ENTER
  LT 3 displayed
Press ENTER
  LT 4 displayed
```

If ENTER is pressed beyond the last configured LT, (X-f) is displayed, and the keyboard is locked.

#### 3.10.1 Test 6 Byte Identification

Figure 3-13 identifies the bytes of the DCB displays.

#### 3.10.2 DCB Bit Definitions

Bits defined as "Reserved," in Figure 3-14, may contain zeros or ones. They should be disregarded unless otherwise directed by the next level of the support structure. Defined bits are assumed to be set to 1 unless otherwise noted.

Bytes 02, 03, and 04 indicate functions supported by the controller and reported as available by the device. See bytes 25, 95, 96, and 97 for functions identified by the device.

**First Display**

XX/6 – Returned as entered XX = Any device

000 – ID of the first address of this display

ID only 0 1 2 3 4 5 6 7 8 9 A B C D E F –  
ID only, not displayed

```
000 0000 0000 0000 0000 0000 0000 0000 0000
010 0000 0000 0000 0000 0000 0000 0000 0000
020 0000 0000 0000 0000 0000 0000 0000 0000
030 0000 0000 0000 0000 0000 0000 0000 0000
```

Byte 3F

**Second Display**

XX/6 – Returned as entered

040 – ID of the first address of this display

```
040 0000 0000 0000 0000 0000 0000 0000 0000
050 0000 0000 0000 0000 0000 0000 0000 0000
060 0000 0000 0000 0000 0000 0000 0000 0000
070 0000 0000 0000 0000 0000 0000 0000 0000
```

Byte 7F

**Third Display**

XX/6 – Returned as entered

080 – ID of the first address of this display

```
080 0000 0000 0000 0000 0000 0000 0000 0000
090 0000 0000 0000 0000 0000 0000 0000 0000
0A0 0000 0000 0000 0000 0000 0000 0000 0000
0B0 0000 0000 0000 0000 0000 0000 0000 0000
```

Byte BF

**Fourth Display**

XX/6 – Returned as entered

0C0 – ID of the first address of this display

```
0C0 0000 0000 0000 0000 0000 0000 0000 0000
0D0 0000 0000 0000 0000 0000 0000 0000 0000
0E0 0000 0000 0000 0000 0000 0000 0000 0000
0F0 0000 0000 0000 0000 0000 0000 0000 0000
```

Byte FF

Note: See Appendix B for extended data stream configuration.

Figure 3-13. Test 6 Byte ID Chart

Location	Bit	Meaning	
Byte 02	0	See figure A	
	1		
	2		
	3		
	4	See figure B	
	5		Keyboard is attached
	6		This is a Type B device
	7	Numeric Lock feature is present	

Display Model	1	2	3	4	5
Bit	0	0	0	1	1
1	0	1	1	1	1
2	1	0	1	1	0

figure A

Bit	Data Entry KB	Printer	Typewriter, APL, Text-Keyboard
3	0	1	0
4	1	1	0

figure B

Location	Bit	Meaning
Byte 03	0	Katakana keyboard is attached
	1	SCS feature on Type A adapter printer
	2	Text keyboard
	3	3289 Text feature
	4	APL keyboard
	5	Extended function keyboard
	6,7	Reserved

Figure 3-14 (Part 1 of 3). DCB Bit Definition Chart

Location	Bit	Meaning	Location	Bit	Meaning	
Byte 04 (Category A Devices)	0	Not used	Byte 0B	0	Reserved	
	1	Security keylock present		1	Reserved	
	2	Selector pen attached		2	Reserved	
	3	Reserved		3	Local copy (display to printer) in progress	
	4	MSR/MHS attached		4	Alternate screen size	
	5	Reserved		5	Attributes not valid	
	6	Reserved		6	Monocase switch active in device	
Byte 04 (Category B Devices)	7	ECS (APL/Test)	7	Reserved		
	0	Device busy	Byte 0C	0	Printer messages queued – local copy	
	1	Buffer parity		1	Reserved	
	2	Indeterminate write errors		2	Local copy malfunction has occurred	
	3	Inhibit start idle poll		3	Wrong place	
	4	Buffer size (0=480, 1=1920)		4	Minus Function	
	5	DAU issued		5	MSR – wrong card MSR/MHS	
6	Start print	6		Message pending		
Byte 05	7	Format bits	7	Message reminder		
	3	Color	Byte 0D	0	Printer printing – local copy	
Byte 06	0	DCB busy		1	If display has printer assigned for local copy	
	1	Subsystem ready (DCB initialized)		2	Printer matrix changed (associated with this display)	
	2	Nondisplay	Byte 0E	0	Invalid dead key (language 06 only)	
	3	Op Complete pending from device		1	2NN machine check	
	4	Linkage stacked		2	Communication check	
	5	Stacked status/keystroke/error present		3	Program check	
	6	Numeric-lock field		4	Security key off	
7	Reserved	5		3NN machine check		
Byte 07	0	Protected field or attribute character		6	Too much (keystroke-MSR)	
	1	ECS buffer updated	7	Operator not authorized		
	2	Print ID entry mode	Byte 0F	0	Not enough	
	3	Reserved		1	Wrong number	
	4	MDT bit not set		2	Numeric shift	
	5	Do not enter		3	Operator retry	
	6	Reserved		4	Local-copy failure while printer printing (printer failure)	
7	Insert mode	5		Device busy doing local copy		
Byte 08	0	No indicators to write or erase (Category B displays and printers, Category A printers)		6	Reserved	
	1	Test mode	7	System lock		
	2	Alpha shift (not Katakana shift)	Byte 10	0	Communication check reminder	
	3	Reserved		1	My Job indicator	
	4	Text indicator		2	System Operator indicator	
	5	Upshift indicator		3	Unowned indicator	
	6	Katakana shift		4	Not enabled (not online)	
7	APL indicator	5		Reserved		
Byte 09	0	Online indicator		6	Reserved	
	1	System-wait condition	7	Minus Symbol indicator (WT only)		
	2	Hard-lock condition	Bytes 14, 15	Cursor position (3278 only) <sup>1</sup>		
	3	Keyboard in use by operator		Bytes 1A, 1B	First character position on display <sup>1</sup>	
	4	DCB scheduled for function 6 – waiting (BSC)	Bytes 1C, 1D		Last character position on display <sup>1</sup>	
	5	DCB scheduled for function 5 – waiting (BSC)		Byte 24 (Category A devices)	0	Model 5 wide screen
	6	Reserved			1	Model 5 wide screen
7	OK for function to be suspended	2	480-character format			
Byte A0 (52C only)	0	Keyboard mode – Kanji/Chinese (multishift input mode)	3		Reserved	
	1	Keyboard mode – (10-key input mode)	4	Inhibit display video		
	2	Two-byte code character attempted	5	Blank cursor		
	3–7	Reserved	6	Cursor reverse		
			7	Cursor blink		

Figure 3-14 (Part 2 of 3). DCB Bit Definition Chart

Location	Bit	Meaning	Location	Bit	Meaning
Byte 25 (valid only when SFAP feature installed)	0		Byte 68	0	Printer equipment check/display disabled due to error
	1			1	Intervention required/Security key off
	2	ROS present		2	Printer busy processor abort
	3	APL switch in APL position		3	Reserved
	4	APL feature present	4	Print in process	
	5, 6	00 = No PS feature on device 01 = Two PS features on device 10 = Four PS features on device 11 = Six PS features on device	Byte 95 (Display)		Display features identified to the controller by the device:
Byte 34	0	SNA — printer allocated to local copy	0–3	0000	= Reserved
	1	SNA — local copy printer allocated for host use		0001	= APL keyboard/Numeric Lock
	2	SNA — host request for local copy allocated printer		0010	= Text keyboard/Numeric Lock
	3	Alternate row length indication		0011	= Typewriter keyboard/Numeric Lock
	4	Default row length indication		0100	= Typewriter Attribute Select keyboard/Numeric Lock
	5	Reserved		0101	= APL keyboard
	6	SNA — LU in ERP state		0110	= Text keyboard
	7	SNA — host communications disabled (LU active)		0111	= APL Attribute Select keyboard
Byte 35	0	Local copy printing host-initiated)		1000	= Data Entry 2 keyboard/Numeric Lock
	2	Local copy (printer available for next message) SNA		1001	= Data Entry 1 keyboard/Numeric Lock
	3–7	Reserved		1010	= Typewriter keyboard
				1011	= Reserved
Byte 37 (52C only)	0	Kanji/Chinese terminals attached		1100	= Data Entry 2 keyboard
	1	Kanji/Chinese keyboards attached		1101	= Data Entry 1 keyboard
	2	Current field attribute is known		1110	= Typewriter
	3	Current field is Kanji/Chinese		1111	= No keyboard
	4–7	Reserved	4–6	001	= Model 1
Byte 46	0	Other function request		010	= Model 2
	1	Select pen for immediate detect field		011	= Model 3
	2	Required for select pen field		100	= Reserved
	3	Dup Key switch (Auto Tab)	101	= Reserved	
	4	Reserved	110	= Model 5	
	5	Clicker disabled	111	= Model 4	
	6	Reserved	7	0	= Indicates display byte
7	Type B erase all unprotected				
Byte 47	0	Disable cursor display	Byte 95 (Printer)	Printer features identified to the controller by the device:	
	5	Dead key sequence process		0	ECS feature present
	6	Local copy received IR	1	APL feature present	
Byte 4E (Category A devices)	0–7	Attribute affecting field cursor (3278 only)	2	Reserved	
			3	Reserved	
Byte 4E (Category B devices)	0	Device check	4–6	001	= Model 1
	1	Transmit check		010	= Model 2
	2	Information pending		011	= Model 3
	3	Not ready (printer only)		100	= Reserved
	5	Equipment check (printer only)		101	= Reserved
Byte 4F (Category B devices)	0	Device busy		110	= Model 5
	1	Buffer size (0=480, 1=1920)	111	= Model 4	
	2	0 = display, 1 = printer	7	1	= Indicates printer byte
3–7	Device address (type B adapter port number) Byte B6 (Mod BSC) Pending Device Status	Byte 96 (Display)		1	Security key
Bytes 50, 51		Present attribute address (3278 only) <sup>1</sup>	2	Selector light pen	
Bytes 52, 53		Next attribute address (3278 only) <sup>1</sup>	4	Magnetic slot reader	
			Byte 97	3	ECS adapter
				7	Color

<sup>1</sup>When using this byte on Category A devices, subtract hex 50 from the cursor position. This will give you the current I/O interface code. (If Model = 1, subtract X"40".)

Figure 3-14 (Part 3 of 3). DCB Bit Definition Chart

### 3.11 /B TEST: DEVICE ADDRESS ASSIGNMENT TABLE

This test displays, for each port on the controller, the number of addressable terminals (physical and logical) associated with the port. The primary address for the port, and the range of secondary addresses (if any) associated with the primary address. Category A and B adapters are shown.

This test requires 22 lines on the screen (there is no paging for additional data) and must be requested from a display device with 24-row screen capacity or greater.

The data for Category A adapter ports is presented in 4 groups, 8 ports to a group (A00 to A07, A08 to A15, . . .) with 3 lines required for each port, as follows:

```
Line 1:  A00      A01 . . . . . A07
Line 2:   X       X             X
Line 3:  XX      XX            XX
Line 4:  XX-XX   XX-XX         XX-XX
```

Three more groups, A08 to A15, A16 to A23, and A24 to A31, follow.

Each line carries the following meaning:

- Line 1 = port number
- Line 2 = port availability: X = non-zero, port available; X = 0, port unavailable
- Line 3 = primary address
- Line 4 = range of secondary addresses (if any)

The data for Category B adapter ports is presented following the Category A presentation and consists of two lines displaying the data for all 16 possible Category B ports. The format is:

```
Line 1: B00    B01    B02 . . . . . B15
Line 2: XX     XX     XX             XX
```

Where:

- Line 1 = port number
- Line 2 = primary address

### 3.12 TEST 7: DYNAMIC CONVERGENCE (COLOR)

For a description of this test, see the *IBM 3279 Color Display Station Maintenance Information* manual, SY33-0069.

### 3.13 TEST 8. PSs, HIGHLIGHTING, AND COLOR

For a description of this test, see the *IBM 3279 Color Display Station Maintenance Information* manual, SY33-0069.

### 3.14 KANJI/CHINESE CHARACTER DISPLAY

For a description of this test, see the *IBM 3278 Model 52 Display Station Maintenance Information* manual, SY18-2032.

### 3.15 /D TEST – REQUEST 3290 DUMP

You may request a dump of the 3290 from a 3178, 3278, 3279 display. For example, after a 3290 has been down-stream loaded and a failing symptom is present, remove the "load" diskette from the 3274 and insert the 3274/3290 "dump" diskette (B/M 6849597). When the "load" diskette is removed from the 3274 a flashing 1111-0001 will appear in the 3274 LEDs. This is a normal indication and will stop when the "dump" diskette has initialized with no LEDs present – 0000. Then, at the display from which the dump is being requested, press the TEST key and enter:

XX/D

XX = The primary LU address (3274 Port) of the 3290.

For our example above, if the dump is for the 3290 on port 05 of the 3274, enter:

05/D

When the request is successfully received and the dump is in progress, a plus sign (+) will appear immediately adjacent to the D:

05/D+

While the dump is in progress and performing properly a flashing 1111-0101 will be displayed in the 3274 LEDs. After approximately 10 minutes, the dump should be complete and a solid 1111 will appear in the 3274 LEDs. Remove the "dump" diskette and insert the "load" diskette, then POR the intelligent device for which the dump was taken. The POR ensures a new down-stream load of the intelligent device. Refer to Chapter 4 for a step by step 3274 Subsystem Dump Procedure.

**Note:** *If you are requesting a matched - 3274/3290 set of dumps proceed as follows:*

1. Dump the 3274 following the 3274 Subsystem Dump Procedure described in Chapter 4. then,
2. Perform the following steps in sequence:
  - a. Disconnect the coaxial cable at the 3274 for each 3290 to be dumped.
  - b. Ensure that the "load" diskette is inserted in the 3274.
  - c. IML the 3274.



If other than the basic characters have been entered from the keyboard, the **X ? +** is displayed.

If a communication check is detected, the Input Inhibited and Communication Reminder symbols, followed by a 5nn number, are displayed.

### **3.17 3277 PATH TEST AND TEST REQUEST KEY<sup>2</sup>**

#### **3.17.1 BSC or Local Host Attached**

On 3277s attached to a BSC or local host-attached 3274, the coax path from the device to the control unit can be verified by means of the Test Request key. Pressing the Test Request key will cause the control unit to attempt to turn on the System Available indicator on the 3277. A Test Request message will also be generated if the control unit is online to the host.

<sup>2</sup> Not applicable to Model 61C.

#### **3.17.2 SNA Attached**

On 3277s attached to an SNA-configured 3274, the coax path from the device to the control unit can be verified by means of the Test Request key twice. The first pressing of the key will cause the control unit to attempt to turn off the Do Not Enter indicator; the second will cause the control unit to attempt to turn on the System Available indicator. Operationally, this sequence is used to enter and exit 2-key sequence mode. Test Request followed by Clear is functionally equivalent to the Systems Request key on 3278s in SNA mode. Test Request followed by PA1 is the equivalent in function to the ATTN key on 3278s in SNA mode. Test Request followed by Test Request returns the 3277 to normal operation.





# Chapter 4. Subsystem Tests, External Tests, and Subsystem Service Aids

## 4.1 INTRODUCTION

Subsystem tests consist of the Bus and Lamp test and the IML tests.

**Note:** Model 61C IML Test code descriptions and card locations are defined in MAP D30 of the Model 61C Maintenance Information manual, SY27-2555.

Initiating a normal IML (ALT switch not pressed and system diskette installed) invokes a sequence of hardware tests before operational code is loaded. When the IML pushbutton is pressed, a hardware Bus and Lamp test is performed.

## 4.2 INITIAL MACHINE LOAD (IML) TESTS (MODELS 51C and 52C)

Code	Description	Code	Description
0000	Control Logic failure — All four indicators not lit indicates a control logic failure. The test sequence will not proceed. The failure of any adapter can also cause this failure. Parity problems can also appear to be control-logic failures.	0111	Modem Wrap failure — A flashing display of this code indicates the Modem Wrap/DDSA test failed. The wrap test is run only if a wrappable modem was specified at customizing time. If a display is powered on at port A0, additional information concerning the failure is available on the screen. Data displayed is as follows:  0111 016 — Modem failed to set Clear to Send 0111 013 — General modem failure  For Configuration Support "D" and above, additional information that is displayed at port A0 is also displayed in the 3274 LEDs. This is done by alternating the flashing 0111 code with the solid failure indication code as described in the Maintenance Information Manual (SY27-2513).
0001	Low Storage failure — A steady display of this code in the 8 4 2 1 indicators indicates a failure in low storage.	1000	Type B Adapter failure — A flashing display of this code indicates the Type B Adapter test has failed. The test looks for the first Type B display powered on and attempts to do an Erase-Write-Erase operation. The cursor is left in the lower right portion of the screen. Any Type B device failure that would disable the adapter would cause this test to fail.
0010	Diskette Drive failure — A flashing display of this code indicates the diskette drive failed. A steady display of this code may be caused by any of the following: <ul style="list-style-type: none"> <li>• Failure of the diskette drive to come "ready."</li> <li>• A hung sequence (did not start) because of another adapter failure.</li> <li>• Loss of ground to the diskette drive (check A1Z2 cable).</li> <li>• Defective diskette.</li> </ul>	1001	Encrypt/Decrypt Adapter failure — A flashing display of this code indicates that the Encrypt/Decrypt Adapter test has failed.
0011	Type A Adapter failure (no display required) — A flashing display of this code indicates the test for this adapter failed. A steady indication may indicate the sequence is hung (did not start). Any activity from a device that would normally disable the adapter will also cause this test to fail.	1010	Diskette Drive error — This flashing code is displayed whenever a problem has been detected <i>after</i> the initial test. This failure can also be caused by invalid tracks or data on the diskette.
0100	Type A Adapter failure (display required) — A flashing display of this code indicates the tests for this adapter failed. If a POR response was not detected from Port A0, this test will automatically be bypassed. A failing display can also cause this test to fail.	1101	Uncustomized system diskette.
0101	Storage Card failure — A flashing display of this code indicates the storage test failed. The failure could be caused by a defective storage card, failure of a component interfacing with storage (Extended Function Store feature), or incorrect customizing parameters. If a Category "A" display is powered on at port A0, additional failure information will be displayed on the screen.  For Configuration Support "D" and above additional information will be displayed in the 3274 LEDs. The flashing 0101 code will remain in the LEDs for approximately 5 seconds and will alternate with a control storage card error indicator (solid) that will be displayed for approximately 3 seconds. Refer to the Maintenance Information Manual (SY27-2513) for interpretation of the card error code.	1110	Insufficient storage.
0110	Host Adapter failure — A flashing display of this code indicates the host adapter/attachment test failed. Failure could be caused by the following, in addition to defective cards: (1) model specified wrong when customized, (2) system diskette not for this machine, or (3) problem on the host interface has disabled the adapter, and (4) if this flashing code is present for approximately 5 seconds then all LED's momentarily go off, and a solid 0001 is displayed for approximately 3 seconds, a jumper mismatch between hardware and configured values is indicated.	1111	Operational code failed to load.
		1001, 1110	Alternating. This code indicates that the 3274 does not have the required minimum storage.
		1001, 1010	Alternating. This code indicates that the customized system diskette is not correct for this 3274 model configuration support D, and later configuration support levels. For Configuration Support below Support D the configuration support level is incompatible with the 3274 model.
		1011	Response Time Monitor Error

**Note:** At least one complete IML test sequence is required to initialize control storage. Bypassing IML by using either ALT 1 or ALT 2 mode does not perform this initialization function; invalid parity may therefore exist after initial power on if normal IML has been bypassed.

Figure 4-1. IML Test Error Indications

When the IML pushbutton is released, the diagnostic sequence begins and the error indications described in Figure 4-1 may be displayed.

#### 4.2.1 ALT 1 IML Mode

Pressing the IML pushbutton while holding the ALT switch in the ALT 1 position bypasses the normal IML test sequences and causes the unit code to be directly loaded. This will enable the user to bypass a failing test sequence (for example, a defective Type B adapter). In this case, the control unit is operational except for the Type B adapter. The Bus and Lamp test functions the same as during a normal IML. See Figure 4-2 for an ALT 1 IML sequence.

Step	Code	Meaning
1. ALT 1 and IML pressed	1111	Bus and Lamp test OK
2. ALT 1 and IML released	0000	Initiate Unit Code loading
3. Wait	1111	Unit Code loading
4. Begin normal operation	0000	Unit Code loaded

A hang condition at either step 3 or step 4 usually indicates a defective system diskette or a configuration error.

Figure 4-2. ALT 1 IML Sequence

#### 4.2.2 ALT 2 IML Mode, Models with Wrappable Modem (Test/Operate Switch in Operate Position)

Pressing the IML pushbutton while holding the ALT switch in the ALT 2 position invokes an extended Modem Wrap test. Some types of modems require manual intervention to set up for wrap testing. The test checks the transmission path (Transmit and Receive Data lines) to and from the modem. Modem clocking is required to run this test successfully, and a missing or defective modem clock will result in a failure indication (flashing 0111). The intent of this test is *NOT* to test the modem. The Bus and Lamp test functions the same as during a normal IML. See Figure 4-3 for this ALT 2 sequence.

Step	Code	Meaning
1. ALT 2 and IML pressed	1111	Bus and Lamp test OK
2. ALT 2 and IML released	0000	Begin Modem Wrap test
3. Wait	0110	Communication Adapter Test running
	0110	Flashing – Communication Adapter Test failure
4. Wait	0111	Prewrap, Adapter Wrap, and Modem Wrap tests are running
	0111	Flashing – Modem wrap test has failed
5. End Test – A normal IML required to begin normal operation	1000	Successful test – Carrier not present after completion of test.
	1111	Successful test – Carrier is present after completion of test.
	0111	Flashing – Modem wrap test has failed

When this test is run in ALT 2 mode, the 3278 does not display the 8 4 2 1 indications.

Figure 4-3. ALT 2 IML Sequence, Models with Wrappable Modem

#### 4.2.3 ALT 2 IML Mode, Models without Wrappable Modem (Test/Operate Switch in Test Position)

Pressing the IML pushbutton while holding the ALT switch in the ALT 2 position invokes an extended Modem Wrap test. When a nonwrappable modem is being used, the EIA test cable Test/Operate switch should be in the TEST position. This test checks the transmission path (Transmit and Receive Data lines) to and from the Test/Operate switch at the end of the cable. The test cable must be attached to the modem, and the modem must provide clocking or a failure indication of 0111 (flashing) will result. The Bus and Lamp test functions the same as during a normal IML. See Figure 4-4 for this ALT 2 sequence.

Step	Code	Meaning
1. ALT 2 and IML pressed	1111	Bus and Lamp test OK
2. ALT 2 and IML released	0000	Begin Modem Wrap test
3. Wait	0110	Communication Adapter Test running
	0110	Flashing – Communication Adapter Test failure
4. Wait	0111	Prewrap, Adapter Wrap, and Modem Wrap tests are running.
5. End Test	0111	Flashing – Modem Wrap test has failed.
	1000	Successful test.
6. Return TEST/ OPERATE switch to Operate position.	1000	Carrier not present.
	1111	Carrier is present.

**Figure 4-4. ALT 2 IML Sequence, Models without Wrappable Modem**

A normal IML is required to begin normal operation. When this test is run in ALT 2 mode, there is no display of failing indications on the port 0 display. See paragraphs 5.4.3 and 5.4.4 of the 3274 MIM for additional information on the Wrap Test without Modem and DDS Adapter Wrap Test.

#### 4.2.4 ALT 2 IML Mode, Modem Self-Test for Model 51C with Greater than 1200-bps Integrated Modem

Pressing and holding the ALT IML Address switch in position 2 will cause the modem self-test to be initiated and repeated about every 4 seconds until the switch is released. Releasing the switch should return the modem to Operate mode, regardless of the test results.

While the test is being run, the TEST light on the operator panel is lit. If the test is successful, the Data Quality–Good indicator on the operator panel will flash each time the test is run. The indicators on the A1D2 card will also flash each time the test is run successfully.

If the test fails, the failing card is indicated in the A1D2 card indicators. Figures 4-5 through 4-7 show the meanings of the indicators. Cards indicated as failing are replaced in order of probability. If multiple A1D2 card indicators are displayed, replace all cards indicated.

Flashing Indicator	Steady Indicator	Operator Panel Poor Indicator	Failing Card
1111		Off	Test successful No failure
111		On or flashing	D2, G2, C4
	000	On or flashing	D2, G2, C4
	111	On or flashing	D2, G2, C4
	100	On	C2, G2, D2
	010	On	G2, D2
	001	On	D2, G2, C4
1 = On 0 = Off			

**Figure 4-5. A1D2 Card Indicator for 2400-bps Integrated Modem (Model 51C Only)**

Flashing Indicator	Steady Indicator	Operator Panel Poor Indicator	Failing Card
1111		Off	Test successful No failure
1111		On or flashing	D2, G2, F2, C4
	0000	On or flashing	D2, G2, C4
	1111	On or flashing	D2, F2, G2, C4
	1000	On	C2, G2, D2
	0100	On	F2, D2, G2
	0010	On	G2, F2, D2
	0001	On	D2, F2, G2, C4
1 = On 0 = Off			

**Figure 4-6. A1D2 Card Indicator for 4800-bps Integrated Modem (Model 51C Only)**

Flashing Indicator	Steady Indicator	Operator Panel Poor Indicator	Failing Card
1111		Off	Test successful No failure
1111		On or flashing	E2, G2, F2, D2, C4
	0000	On or flashing	E2, G2, C2, C4
	1111	On or flashing	E2, D2, F2, G2, C4
	1000	On	D2, F2, E2
	0100	On	F2, D2, E2, G2
	0010	On	G2, E2, F2, D2
	0001	On	E2, F2, G2, D2
	0000	On	C2, G2, E2, D2
1 = On 0 = Off			

**Figure 4-7. A1D2 Card Indicator for 9600-bps Integrated Modem (Model 51C Only)**

### 4.3 MODEL 51C, 52C, AND 61C DISPLAY SYSTEM ONLINE TESTS

#### 4.3.1 Purpose

These Online Tests (OLTs) provide path testing for the 3274 Model 51C, 52C, and 61C display system host attachment downline from a 270X or a 370X.

Prior to invocation of the OLT, the 3274 must complete its IML sequence; that is, the 3274 operational resident code is in control and ready for I/O operations with the host.

#### 4.3.2 Applicable Executive Control Programs

These OLTs are compatible with the following control programs at the levels indicated or higher:

DOS/VS OLTEP	33
OS/VS1 OLTEP	6
OS/VS2 SVS OLTEP	1.7
OS/VS2 MVS OLTEP	3.7
TCAM TOTE	10
OLTSEP	9.0
OS OLTEP	21.8
DOS OLTEP	26

#### 4.3.3 Online Tests

See Figure 4-8 to determine the OLT to be used for a specific configuration.

Configuration	OLT User's Guide	OLT
3274 Models 51C, 52C, and 61C BSC operating with a 270X, or a 370X with the Emulator Program (EP).	D99-3274B	R3274A
3274 Models 51C, 52C, and 61C BSC operating with a 270X, 370X EP, or a 370X NCP. R3274B requires that the 3700 Series Diagnostics be cataloged at the host. It is suggested that R3274A be used when operating with a 270X, or 370X EP.	D99-3274C D99-3700A	R3274B
3274 Models 51C, 52C, and 61C SDLC operating with a 370X NCP. Use the following Link Level Tests:		
Link Level 1	D99-3700C	T3700LTE
Link Level 0	D99-3705A	T3705

Figure 4-8. 3274 Model 51C, 52C, and 61C Online Tests

### 4.4 SERVICEABILITY AIDS

The following procedures are intended to supplement problem determination and troubleshooting techniques. Moni-

toring procedures for interface lines, coaxial cable checking procedures, and patching procedures are some of the aids provided.

#### 4.4.1 Diskette Patching Procedure

This procedure is to be used by the support customer engineer, at the direction of the next level of the support structure.

**Note:** *Diskette patching is an emergency procedure only. It should be used only when time will not permit waiting for an update diskette from the plant of manufacture.*

Before the patching procedure can be performed, the patch header information and the patch coding must be obtained from the next level of the support structure.

Use the steps listed below to perform the diskette patching procedure. If, while performing steps 4 and 5, you want to cancel what you have done and start again, enter FF and press the ENTER key. This will bring you back to step 3. If you enter an unacceptable response, the operator code in the upper center of the display will alert you to the problem. If an operator code (80–89) is displayed, verify your entry and retry the operation. If the error recurs, follow local procedures for reporting the problem. Figure 4-9 gives the meanings of the operator codes.

The 8 4 2 1 codes also provide a guide to your progress in the patching procedure.

1. Insert the feature diskette. While holding the ALT IML Address switch in position 1, momentarily press and release the IML pushbutton; then release the ALT IML Address switch. Within 2 minutes, the 8 4 2 1 indicator code will be flashing 1011 if Configuration Supports A, B or C is installed, or 0101 if Configuration Supports D or T is installed.
2. Replace the feature diskette with the customized system diskette or load diskette if a 3290 is configured. DO NOT PRESS IML. Within 1 minute, the 8 4 2 1 indicator code will be flashing 1110.
3. Replace the system diskette or load diskette if a 3290 is configured, with the feature diskette used in step 1. DO NOT PRESS IML. Within 1 minute, the 8 4 2 1 indicator code will be a steady 0001. If you are using a 3279, the color convergence pattern will be displayed on the display screen. To bypass this pattern, hold down the ALT key, momentarily press the TEST key, and release the ALT key. Sequence number 001 will be displayed on the display screen. Continue with step 4.

If you want to converge the 3279, follow the instructions in the "Color Convergence Procedure" in the *IBM 3270 Information Display System 3274 Control Unit Customizing Guide*, GA23-0065.

4. When sequence number 001 appears in the upper-left corner of the display screen:
  - a. Key in the following characters:  
1234567890ABCDEF
  - b. Press the spacebar once.
  - c. Key in the two-digit Validation Number shown on the system diskette label or load diskette if a 3290 is configured.
  - d. Press ENTER.
5. When sequence number 011 appears, key a 1 and press ENTER.
6. When sequence number 012 appears, key in the patch header information and press ENTER.
7. When sequence number 013 appears, key in the patch information one line at a time. Press ENTER after each line. After all lines of the patch have been keyed in, type 49 and press ENTER.
8. Sequence number 011 will appear again. If you have another patch to enter, type 1, press ENTER, and go to step 7.  
  
If you do not have another patch to enter, key a 0, press ENTER, and go to step 9.
9. At this time, either sequence number 021 is displayed (meaning that no printer authorization matrix has been defined), or the defined matrix is displayed.  
  
If sequence number 021 is displayed, type 0 and press ENTER.  
  
If a matrix is displayed, move the cursor to the entry for 901, change it to a 1, and press ENTER.
10. When sequence number 031 appears, enter the number of RPO diskettes being used (0, 1, 2, or 3), and press ENTER.  
  
**Note:** *A non-zero entry will result in the display of sequence number 032. At this point enter the RPO Parameter List, if there is one. For more information on sequence 032 refer to the 3274 Customizing Guide, GA23-0065 or the 3274 Planning, Setup and Customizing Guide GA27-2827.*
11. When sequence number 999 appears, move the cursor to the entry for 900, change it to a 1, and press ENTER.
12. Within 2 minutes, the 8 4 2 1 indicator code on the 3274 Control Unit will be flashing one of the following:
  - 1100 – Replace the feature diskette with the RPO diskette. DO NOT PRESS IML. After the RPO diskette is inserted, the code will change to 0111 within 30 seconds. If additional RPO diskettes are required, the indicator code will again flash 1100. Repeat the procedure for each additional RPO diskette. AT NO TIME SHOULD YOU PRESS IML. When the RPO diskette procedure is completed, the indicator code will be flashing 1110. Reinsert the feature diskette. DO NOT PRESS IML. Within 2 minutes, the 8 4 2 1 indicator code will flash 1011 or 1101.
  - 1011 – Replace the feature diskette with the system diskette. *Do not* press IML. Within 20 minutes the indicator code will change to 1111 or 0011.
  - 0011 – Replace the system diskette with the load diskette. *Do not* press IML. Within five minutes the indicator will change to 1111.
  - 1111 – The patch procedure is now complete, and a normal startup can be initiated.
  - 1101 – Replace the feature diskette with the language diskette. DO NOT PRESS IML. Within 30 seconds, the indicator code will change to 0111 and then to flashing 1011 within 1 minute. When the indicator code is flashing 1011, replace the language diskette with the system diskette. DO NOT PRESS IML. Within 20 minutes, the indicator code will change to 1111. The patch procedure has now been completed, and a normal startup can be initiated.

Code	Meaning	Action
01	One or more of the first 10 characters are incorrect.	Enter the correct response.
02	One or more of the 11th to 17th characters, including the space, are incorrect.	Enter the correct response.
03	<ol style="list-style-type: none"> <li>One of the last two characters entered in response to sequence number 001 is incorrect, or</li> <li>The diskette release level is not the same as the documentation level.</li> </ol>	<ol style="list-style-type: none"> <li>Enter the correct response.</li> <li>Restart after matching diskette and documentation levels.</li> </ol>
*11	An invalid response has been entered (too many characters, value too high or too low, wrong character, etc.).	Enter the correct response.
*12	A character other than A, B, C, D, E, 1, 2, 3, or 4 has been entered in response to sequence number 151 (3274 Model Designation).	Enter the correct response.
*13	The response entered has too few characters.	Enter the correct response.
*14	<ol style="list-style-type: none"> <li>The numeric total of the responses entered for sequence numbers 111 (Number of Category B Terminals) and 112 (Number of Category A Terminals) is greater than 12 (Model 51C) or 16 (Model 61C).</li> <li>The response to sequence number 163 (Extended Character Set Adapter) is greater than the response to sequence number 112 (Number of Category A Terminals).</li> </ol>	<ol style="list-style-type: none"> <li>Enter the correct response.</li> <li>Change the response for sequence number 163 to the same value as, or a value less than, the response to sequence number 112.</li> </ol>
*21	An unacceptable change was made during the modify sequence (number 999).	Recheck the entries and correct them.
*22	<p>Something was specified in the configuration that is not compatible with the character set specified in sequence number 321.</p> <p>If the EBCDIC character set (321=0) was specified, sequence number 121 must not be <i>02</i>.</p> <p>If the ASCII character set (321=1) was specified:</p> <p>121 must be <i>02</i>  131 must be <i>1</i>  132, 133, 134, and 135 must be <i>0</i>  162, 163, 164, and 165 must be <i>0</i>  166 must be <i>A</i>.</p>	Verify and enter the correct responses.
*23	One or more of the responses entered are not compatible with the response to sequence number 331 (BSC or SDLC Protocol).	Verify and enter the correct response.
*24	<ol style="list-style-type: none"> <li>All responses to sequence numbers 131 through 135 (keyboard types) were 0's (at least one must be 1), or</li> <li>The response to sequence number 113 (Extended Function Store) was something other than 0000 or A000. The response indicates that the Extended Function Store feature is installed in this 3274 when, in fact, the feature is not installed.</li> </ol>	<ol style="list-style-type: none"> <li>Verify and enter the correct response.</li> <li>Verify and enter the correct response.</li> </ol>
*25	<ol style="list-style-type: none"> <li>If this response is to sequence number 133 (Data Entry Keypunch Layout Keyboard), the Katakana language (121=17) was specified with a Data Entry Keypunch Layout Keyboard (133=1). The Data Entry Keypunch Layout Keyboard cannot be specified with the Katakana language.</li> <li>If this response is to sequence number 113 (Extended Function Store), the 3274 has less storage than indicated in the response to sequence number 113.</li> </ol>	<ol style="list-style-type: none"> <li>Verify and enter the correct response.</li> <li>Report the problem.</li> </ol>

\*If any entry is unacceptable, the entry for customization sequence number 900 is changed back to zero, and the unacceptable value is intensified.

Figure 4-9 (Part 1 of 5). Operator Codes

Code	Meaning	Action
	3. A language other than 01 (U.S. English) was specified in response to sequence number 121, and a Text keyboard was specified (135=1). Text cannot be specified with languages other than U.S. English.	3. Verify and enter the correct response.
*26	There is not enough storage to support all the features that have been selected.	Report the problem and verify that the storage specified in response to sequence number 113 is correct. (The storage requirements for the features selected may have to be recalculated.)
*27	<ol style="list-style-type: none"> <li>1. The Portuguese language (121=18) was specified and is not allowed with this configuration.</li> <li>2. SFAP (162=1) was specified with a language that is not allowed with SFAP (121=02, 08, 10, 13, 20, 26 or 27).</li> <li>3. Entry Assist was specified (115=1) and a language that is not allowed with Entry Assist (121=2, 6, 8, 10, 11, 12, 13, 17, 20, 26) was also specified.</li> <li>4. A language was specified that is not allowed with a 3290 Information Panel (121=02, 06, 08, 09, 10, 11, 13, 20, 26, or 27).</li> </ol>	<ol style="list-style-type: none"> <li>1. Specify Portuguese – Alternate (127=28).</li> <li>2. Verify and enter the correct responses.</li> <li>3. Verify responses to 115 and 121 and enter compatible responses.</li> <li>4. Verify and enter the compatible response.</li> </ol>
*28	The responses to sequence numbers 113 (Extended Function Store) and 151 (3274 Model Designation) are incompatible.	Verify and enter the correct response.
29	An Attribute Select Keyboard (166=B or C) has been specified, but a Typewriter Keyboard (131=1) or an APL Keyboard (132=1) has not been specified.	Either change 166 to A or change 131 and/or 134 to 1.
30	<ol style="list-style-type: none"> <li>1. A starting address for Multiple Interactive Screens (sequence number 171) has been specified, but logical terminal addresses have not been specified.</li> <li>2. Logical terminal addresses for Multiple Interactive Screens have been specified but a starting address has not been specified.</li> </ol>	Review instructions for defining Multiple Interactive Screens and enter the correct response.
31	An invalid starting address for Multiple Interactive Screens has been specified.	Specify a starting address that is not port A0, but is low enough to allow for the required number of terminals.
32	More logical terminals than this system will allow have been specified.	If using BSC or a 3274 – Model D, specify no more than 32 logical terminals. If using SDLC or 3274 Model A, specify no more than 128 logical terminals.
33	Zero has been specified to sequence number 170, but non-zero responses to sequence numbers 139 or 171, 173, 175, or 176 were specified.	Either specify 1 to sequence number 170 or zeros to sequence numbers 139 or 171, 173, 175, or 176.
34	In response to sequence number 111, a Category B device was specified, but a 3290 was specified for sequence number 170. Category B devices are not allowed with 3290 terminals.	Verify and enter the correct responses.

\*If any entry is unacceptable, the entry for customization sequence number 900 is changed back to zero, and the unacceptable value is intensified.

Figure 4-9 (Part 2 of 5). Operator Codes

Code	Meaning	Action
35	The responses specified for sequence numbers 343, 151, and 331 are incompatible. Compatible responses are:  Sequence Number 343 151 331 00 31C, 41C, 51C, 61C 0 or 1 01 31C, 41C, 51C, 61C 0 or 1 02 31C, 41C 51C, 61C 1 03 51C, 61C 1 04 51C, 61C 1 05 51C 0 or 1 06 51C 1 07 51C 1 08 51C 0 or 1 09 51C 0 or 1 10 51C, 61C 1 11 31C, 51C 0 or 1	Verify and enter the correct responses.
36	A non-zero response for sequence number 139 and a zero response for sequence number 170 were specified. 170 must be 1 for 139 to be non-zero.	Verify responses to sequence numbers 139 and 170, then enter the correct responses.
37	1. Decompression (165=1) was specified, but SFAP (160=1) was not specified. 2. Attribute Select Keyboard (166=B or C) was specified, but SFAP (160=1) was not specified.	1. Verify and enter the correct responses. 2. Verify and enter the correct responses.
41	The X.25 Network Type (response 400) selected during the customizing procedure is invalid.	Check Network Type values and re-enter a valid response to 400.
42	The Incoming Call Options selected (response 420), included 'Validate Host DTE Address' but the address was not entered in response to 410.	Either respond to question 410 with the host address or do not include 'Validate DTE Host Address' in response to 420.
43	1. The Circuit Type selected (response 401) requires a host address (response 410). 2. The Outgoing Call Options selected (response 421) included, 'Validate 3274 DTE Address' but the address was not entered in response to 411. 3. The response to 'Outgoing Call Options' (421) was invalid.	1. Either change the response to 401 (Circuit Type) or provide a host DTE address (410). 2. Either respond to question 411 with the 3274 address or do not include 'Validate DTE 3274 Address' in response to 421. 3. Check 'Outgoing Call Options' and re-enter a valid response to 421.
44	Negotiate Window Size (response 432) or Non-Standard Window Size (response 435) conflicts with Packet Sequence Numbering (response 431).	Check responses to 431, 432 and 435: If 431 response = 0, then 432/435 response must = 01-07 (2 digits). If 431 response = 1, then 432/435 response must = 01-11 (2 digits).
45	Circuit Type (response 401) invalid.	Verify Circuit Type values and respecify response to 401.
46	X.25 Keyboard Support (response 443) invalid.	Verify X.25 Keyboard Support values and respecify response to 443.
47	No CID Password initialized (response 452) but CID required for call options (responses 420 and/or 421).	Either respecify call options to remove CID requirement or enter CID Password in response to question 452.

Figure 4-9 (Part 3 of 5). Operator Codes



Code	Meaning	Action
50	The response that was entered for 116 is incompatible with the response that was entered for 112. When: 116=0, 112=0 116=1, 112=0	Verify responses to sequence numbers 112 and 116; then enter the correct responses.
51	<ol style="list-style-type: none"> <li>If the response to 151 was 51C, only the first 8 ports may have nonzero entries.</li> <li>If the response to 151 was 61C and (111=00), only the first 16 ports may have nonzero entries.</li> <li>If the response to 151 was 61C and (111≠00), only the first 8 ports may have nonzero entries.</li> <li>The highest port configured does not allow for the Category B devices specified (sequence number 111).</li> </ol>	<ol style="list-style-type: none"> <li>Set highlighted entries (sequence number 117) to zero or change the response to sequence number 151.</li> <li>Set highlighted entries (sequence number 117) to zero or change the response to sequence number 151 or change the response to sequence number 111.</li> <li>Set highlighted entries (sequence number 117) to zero or change the response to sequence number 151 or change the response to sequence number 111.</li> <li>Set highlighted entries (sequence number 117) to zero or change the response to sequence number 111.</li> </ol>
52	Highlighted entries (sequence number 117) have invalid responses: if 170 = 0, valid response = 0/1. if 170 = 1 valid responses = 0-5.	Set the highlighted entries to a value within the allowed range.
53	One or more MIS devices have been specified and the total number of device addresses allowed for the configured system has been exceeded.	Remove one or more devices (MIS or non-MIS).
60	Both response fields to customization sequence number 127 (RTM) are not zero or are not non-zero. Both must be zero or both must be non-zero.	Verify values and re-enter responses to customization sequence number 127.
61	The response to customization sequence number 127 indicates Host supported responses and the system is non-SNA. Host supported responses require a SNA system.	Verify values and re-enter responses to customization sequence number 127.
62	The boundaries specified for RTM are not valid. Either the maximum time allowed (27:18.3) has been exceeded or the seconds field is greater than 59.	Verify RTM values and respecify boundaries on the post-modify panel (customization sequence number 128) to comply with acceptable limits.
63	The time specified for the first boundary of RTM is 00:00.0. This is not allowed unless all entries are 00:00.0.	Verify RTM values and respecify boundaries on the post-modify panel (customization sequence number 128) as required.
64	The RTM boundaries have 00:00.0 embedded between two non-zero boundaries.	Verify RTM values and respecify boundaries on the post-modify panel (customization sequence number 128) as required.
65	The RTM boundaries are not in ascending order.	Verify RTM values and respecify boundaries on the post-modify panel (customization sequence number 128) as required.
66	The maximum RTM boundary (27:18.3) is followed by a non-zero (00:00.0) value.	Verify RTM values and respecify boundaries on the post-modify panel (customization sequence number 128) as required.
**99	All RTM entries are acceptable, but the entry to customization sequence number 900, 901, 904 or 907 on the post-modify panel has not been changed to a 1.	Change the entry to a 1.
80	One or more incorrect characters were entered.	Enter the correct response.
81	All patch areas are in use.	
82	The patch ID number (header) already exists.	Obtain a new patch ID number.

\*\*Applies when Operator Code 99 appears while customizing RTM.

**Figure 4-9 (Part 4 of 5). Operator Codes**

Code	Meaning	Action
83	The EC or suffix level of the patch does not match the configuration table.	Verify the data.
84	An attempt was made to delete a patch that does not exist.	Verify the data.
85	The line entered does not have the correct data length.	Verify the data and retry.
86	The call line had invalid data in it.	Enter the correct response.
87	A portion of the patch data was not entered. Sequence number 013 must be responded to with at least one line beginning with the numeral 1.	Enter the correct response to 013 and then retry the 49.
89	The number of lines entered does not agree with the count specified in the header line.	Verify the data.
99	All entries are acceptable, but the entry for sequence number 900 has not been changed to 1.	Change the entry for sequence number 900 to 1.

**Note:** When an operator code (80 through 89) appears after verification and retry, follow local procedures for reporting the problem.

Figure 4-9 (Part 5 of 5). Operator Codes

#### 4.4.2 3274 Subsystem Dump Procedure

The 3274 Dump Diskette (B/M 6849597) is used if normal maintenance package procedures fail to identify a problem. The same type dump diskette is used to dump the 3290. The procedure for requesting a 3290 dump is described in Chapter 3, "Test /D Request 3290 Dump".

The dump procedure can be performed by the customer or by the customer engineer. This procedure should be performed when the 3274 Control Unit has reached the point at which a dump is desired.

**Note:** This procedure must be followed exactly as described; use only the Dump and System diskettes as specified in this procedure, or if a 3290 is configured and has been downstream loaded, use only the Dump and Load diskettes (or System diskette that was used to generate the Load diskette) as specified in this procedure.

1. Replace the System diskette with the Dump diskette.
2. While holding the Alt IML Address switch in position 1, press and release the IML switch and then release the Alt IML Address switch.
3. In approximately 2 minutes, the 8 4 2 1 indicator lights will change to a flashing 1011 code. When this occurs, replace the Dump diskette with the System diskette or Load diskette from step 1. Do *not* press the IML switch.

**Note:** If the 8 4 2 1 indicator lights do not perform as specified in any step of this procedure, follow the instructions listed in Figure 4-10.

Error Code	Cause	Action
Flashing Codes		
1100	Diskette read error	Retry procedure from step 1.
1101	Diskette write error	Retry procedure from step 1.
0001	Parity error	Do not retry. Write 0001 on Dump diskette label and go to step 7.
Alternating Codes		
1111-1100	Diskette read error	Do not retry. Write 1111-1100 on Dump diskette label and go to step 7.
1111-1101	Diskette write error	Do not retry. Write 1111-1101 on Dump diskette label and go to step 7.
1111-0111	Internal error	Do not retry. Write 1111-0111 on Dump diskette label and go to step 7.

Figure 4-10. Dump Procedure Error Codes

4. After the System diskette or Load diskette is inserted, the 8 4 2 1 indicator lights will change to a steady 0000 code and then, in about 10 seconds, to a flashing 1001 code. When this occurs, replace the System diskette or Load diskette with the Dump diskette. Do *not* press the IML switch.
5. The dump procedure is complete when the 8 4 2 1 indicator lights change to a steady 1111 code.
6. When the procedure is completed, replace the Dump diskette with the System diskette or Load diskette if 3290's are attached and press the IML switch to restore customer operation.

7. Place the Dump diskette between protective sheets of cardboard. Insert this package, your filled-out return-address label, the filled-out 3274 Control Unit Problem Report Form, and any other pertinent data into the return envelope. Send the sealed envelope to the requesting System Support Center.

#### 4.4.2.1 Dump Print Program (B/M 4759525)

The Dump Print program is used to print the contents of a 3274 Dump diskette. The dump can then be analyzed by use of the Dump Analysis Document (DAD) (see heading 4.4.2.2).

#### 4.4.2.2 Dump Analysis Document (Included in B/M 4759525)

With the DAD, key areas of the 3274 dump can be analyzed, to determine whether a hardware problem exists. If it is determined that no hardware problem exists, the user is instructed to follow the normal support structure for further problem determination.

**Note:** *The 3274 Dump Analysis Document is not intended to replace, or be used in place of, the basic 3274 maintenance and troubleshooting procedures. It is intended to enhance the basic procedures by guiding the user through a 3274 dump to isolate the source of a problem that the basic procedures failed to identify.*

### 4.4.3 Coaxial Cables

Cables must be procured, installed, and maintained by the customer. Cable  $\lambda$  is for indoor installation only; cable  $\ell$  is for outdoor installation, although it is approved for indoor use as well.

#### 4.4.3.1 Cable $\lambda$ (Indoor)

At present, the only approved cable  $\lambda$  bears the commercial designation RG62A/U. Cables may be purchased from IBM or from a customer-selected source. Bulk cables may be ordered from IBM by specifying IBM part 323921 and the length on a Miscellaneous Equipment Specification (MES) form. Preassembled cables may be purchased from IBM by specifying IBM part 2577672 and the length on the MES form.

For fabricating cables, two BNC-type connectors are needed: IBM part 1836444 or equivalent. These two connectors can be ordered in a kit from IBM by specifying "Connector Group (indoor type), IBM part 1836418" on the MES form. Instructions for assembling BNC-type connectors on bulk cable are given in *Assembly of Coaxial Cable and Accessories*, GA27-2805.

#### 4.4.3.2 Cable $\ell$ (Outdoor)

Cable  $\ell$  is an RG26A/U modified for outdoor/underground

installation. This cable is suitable for indoor and outdoor installation and for direct burial. Cable may be purchased from IBM or from a source selected by the customer.

Bulk cable may be ordered from IBM by specifying IBM part 5252750 and the length on a Miscellaneous Equipment Specification (MES) form. Preassembled cables may be purchased from IBM by specifying IBM part 1833108 and the length on the MES form.

For fabricating cables, two BNC-type connectors are needed: IBM part 1836447 or equivalent outdoor type. These two connectors may be obtained in a kit from IBM by specifying "Connector Group (outdoor type), IBM part 1836419" on the MES form. Instructions for assembling BNC-type connectors on bulk cable are given in *Assembly of Coaxial Cable and Accessories*, GA27-2805.

#### 4.4.3.3 Coaxial Cable Splicing

Do not cut and splice cables; instead, use a quick-disconnect adapter, IBM part 5252643, or commercial adapter, Amphenol Corp. part UG-914/U. A maximum of 13 connections is allowed in any given cable run. The adapter and the attached cable connectors must be covered with 127 mm (5 inches) of shrink tubing, 19.05 mm (0.75 inch) expanded diameter, to prevent accidental grounding of splice. This adapter and connecting jacks should be water-proofed for applications requiring this type of installation.

### 4.4.4 Coax Testing with Scope

This procedure describes how to test any length of coax cable—in segments of up to 1500 m (5000 ft)—with a Tektronix 453 oscilloscope, or equivalent. For additional information on coax testing, refer to the *Oscilloscope Measurement Procedure for Twisted and Coax Cables*, S226-3913.

**Note:** *Since the communication lines are the customer's responsibility, the following practice should be observed:*

1. *Use this procedure only after (1) all product maintenance procedures have been followed, (2) a communication line problem is suspected, and (3) the customer indicates he cannot locate the line problem.*
2. *Do not use the procedure for the purpose of checking the quality of the wiring work done by customer personnel or by a contractor.*

#### 4.4.4.1 Testing for Discontinuities

This test consists of looking for impedances attached to the communication line that are different from the characteristic impedance of the line,  $Z_0$  ( $93\Omega$ ). This is done by sending a wave front (leading edge of square wave) down the line and looking for energy that is reflected by any point that differs from the characteristic impedance.

The "B gate" out pulse is the square wave that is applied to the coax; it travels down the line at about 80% of the speed of light, depending upon the isolation material used in the cable. If no impedance impairment is present on the line, the wave front travels down the line until the termination is reached, and all the energy contained in the wave front is absorbed in the termination.

$Z_o$  of the cables and the termination can vary, in which case not all the energy contained in the wavefront is absorbed. The energy not absorbed is reflected back toward the sending end. Viewing the sending end with the oscilloscope allows display of both the transmitted wave (incident wave) and the reflected wave. Figure 4-11 shows examples of possible reflections for different terminations.

The reflected wave is delayed by the time it takes for the incident wave to travel to and return from the termination. The delay is called "propagation delay" and is expressed as a percentage of the speed electronic waves travel in a specific type of cable (usually 60-80%) as compared with the speed they travel in open air—the speed of light (100%).

If the propagation delay of the cable is known, the scope can be calibrated to meters or feet per division, and the distance to a mismatch—shorts, opens, etc.—in the cable can thus be determined:

The speed of light is 300,000 km/sec, or 30 cm/nanosec, or 0.984 ft/nanosec. Propagation delay in a coax cable is about 1.25 nanosec/ft. The dc resistance is  $44\Omega/1000$  ft.

#### 4.4.4.2 Setup and Test Procedures

##### Parts

X1 probe (or short piece of coax with BNC connector on each end):

1 resistor equal to  $Z_o$  of cable (93 ohms)

1 BNC-T (PN 1650789)

1 probe tip to BNC adapter PN 453199 (not needed if short coax is used as input from T-connector to scope input)

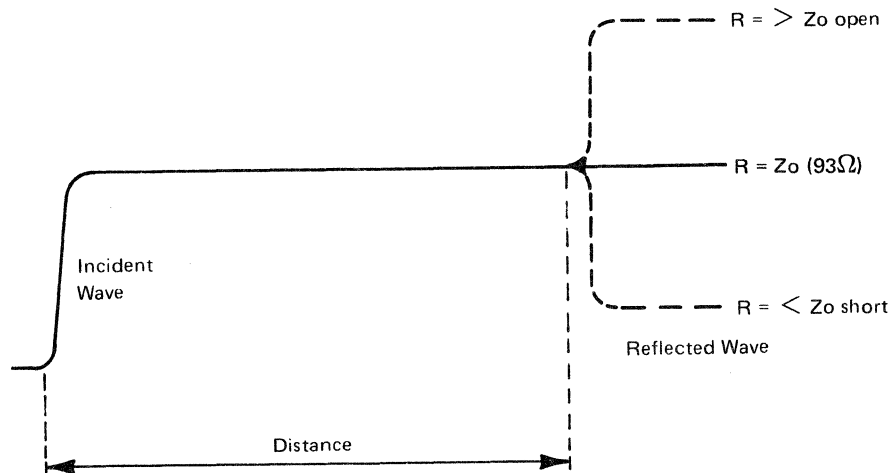

Figure 4-11. Incident and Reflected Waves

**Scope Hookup:** Make the connections shown in Figure 4-12.

**Initial Scope Settings**

- Mode: ch 1
- Volt/div: 0.2 V (initial)
- Input: ac
- A triggering level: fully counterclockwise
- A sweep length: full
- Horiz. display: delayed sweep B
- B sweep mode: B starts after delay time
- A sweep mode: auto trigger
- Delay time multiplier dial: fully clockwise (9.5)
- A and B time division initial setting:
  - A: 10  $\mu$ sec
  - B: 0.1  $\mu$ sec (pull to unlock)

**Test Procedures**

1. Consider the cable length:
  - Up to 100 m (300 ft)—use the initial scope setup.
  - Up to 1500 m (5000 ft)—use B time division up to 2.0  $\mu$ sec.
  - Longer than 1500 m (5000 ft)—measure in segments not exceeding 1500 m.
  - Shorter than 20 m (60 ft)—use the X10 time base. This distance represents only about two horizontal divisions to the center of the screen. Switch to X10 magnifier. B time can now be set to .2 or .5, and speed can be considered 0.02 and 0.05.
2. Use the following conversion table to determine distances.

B-sweep setting ( $\mu$ sec)

	(Meter/Div)	(Feet/Div)
0.1	12.2	40
0.2	24.4	80
0.5	61	200
1.0	122	400
2.0	244	800

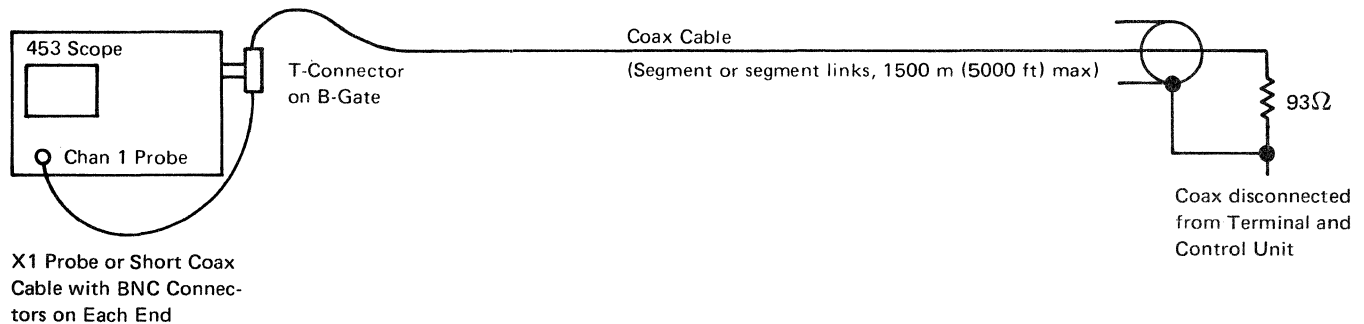

**Figure 4-12. Scope Setup**

3. Use the following measurement techniques and become familiar with Figure 4-14 to gain understanding of what you may see displayed.

- Measure from the point where the reflected pulse starts to change (Figure 4-13). (Rise time degrades with cable-length increase.)
- Lower the volts/div, and use Vertical Position knob to position waveform on screen.
- Identify the end of a cable by opening and shorting the cable end.
- After finding mismatches, measure as closely as possible to the fault. Measuring from both ends of the cable enhances fault location; because of cable loss, major faults at long distances can appear as minor faults close to the test point.

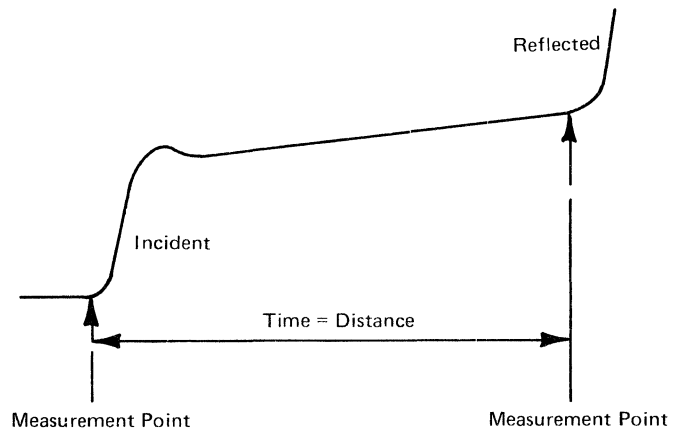

**Figure 4-13. Measurement Points**

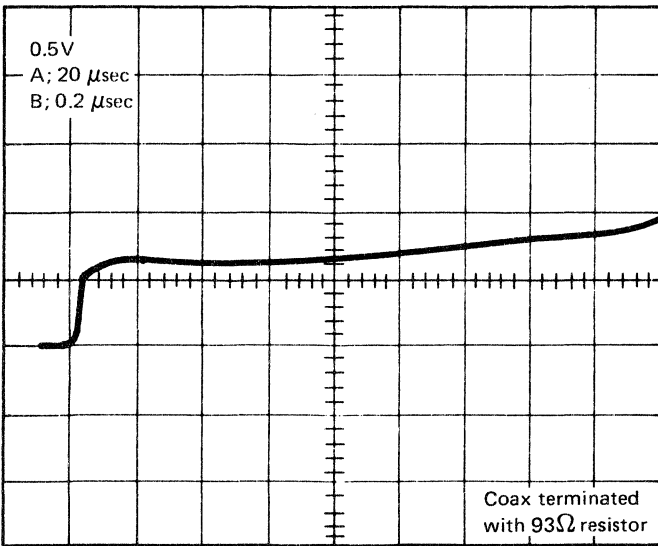

A

This waveform is an indication of a good coax cable 190 m (624 ft). A gradual sloping and overshoot of rise time is normal.

*Impedance  $Z_0$  Checking*

This 93-ohm cable is terminated at the end with a 93-ohm resistor. The straight line after 7.8 divisions proves that this cable's characteristic impedance is close to 93 ohms.

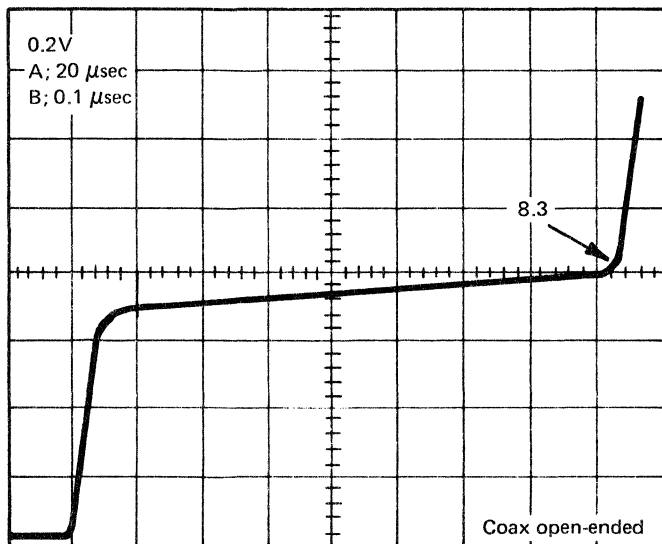

B

101 m (332 ft) of good coax cable, 8.3 div long. (This is an effective method to measure the length of the cable.)

$$8.3 \times 40 = 332 \text{ ft} \quad \text{or}$$

$$8.3 \times 12.2 = 101 \text{ meter}$$

Rising slope is normal.

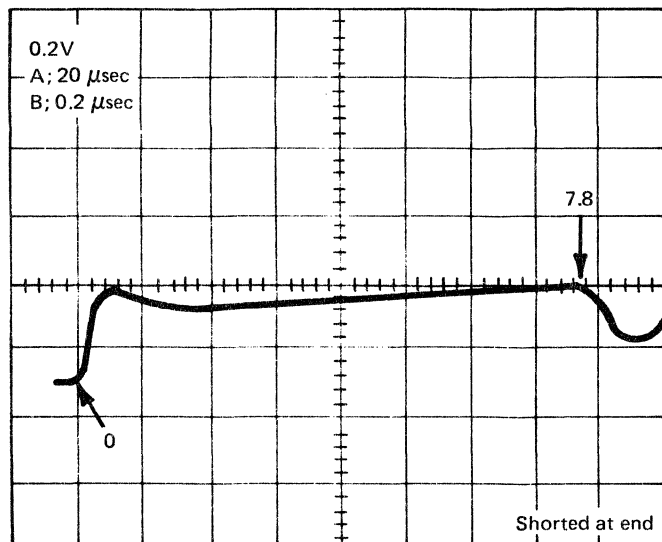

C

The same cable as A now shorted at end to show downward reflection and length.

Length of sweep is 7.8 divisions (see arrows).

$$B \text{ setting} = 0.2 \mu\text{sec or } 80 \text{ ft/div}$$

$$7.8 \times 80 = 190 \text{ m (624 ft)}$$

Figure 4-14 (Part 1 of 3). Display Examples

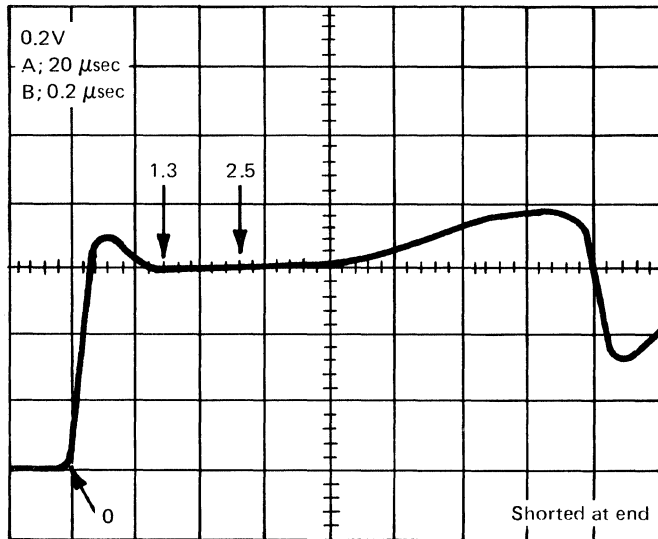

D

Same as C, now with higher vertical gain (0.2V/div).

Arrow points to start. At 1.3 and 2.5 divisions from start, very small mismatches from BNC connection occur. These are at 9.78 m (32 ft), 18.6 m (61 ft), 31.7 m (104 ft) and 61.0 m (200 ft) from start.

A reflection deviation of greater than 10% of the incident wave, usually indicates an undesirable impedance change and should be corrected.

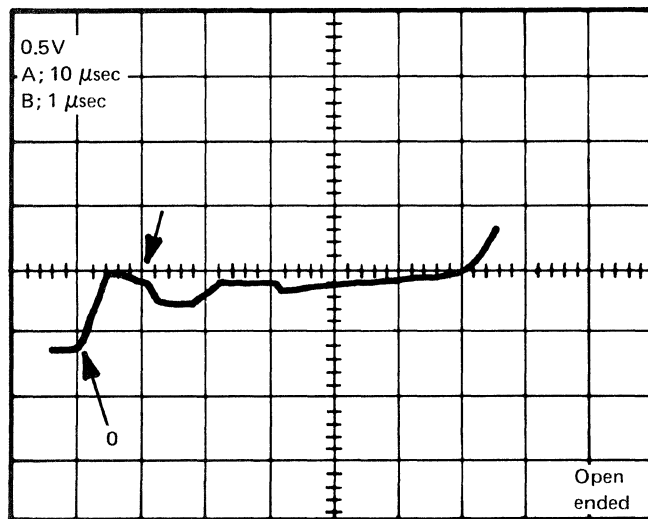

E

This 731.5 m (2400 ft) cable has a 100-ohm short to shield at the 121.9 m (400 ft) point (see arrow).

Total cable length

$$6 \times 400 = 2400 \text{ ft (731.5 m)}$$

Fault point

$$1 \times 400 = 400 \text{ ft (121.9 m)}$$

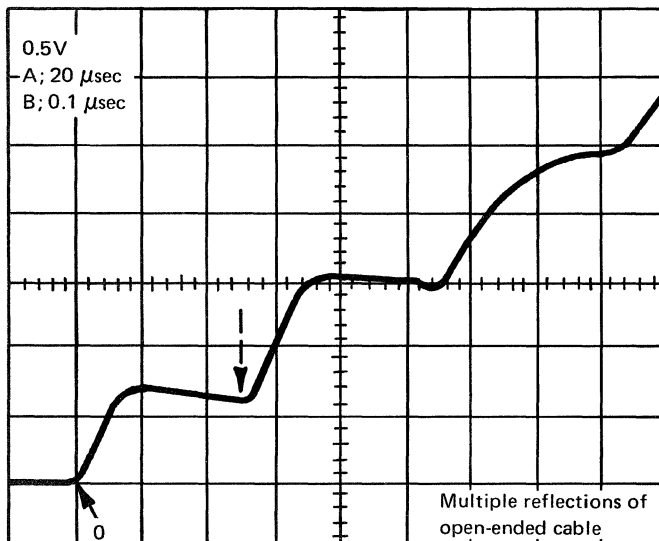

F

Improper setup of scope.

Multiple reflections. 26 m (100 ft) of good cable with open end.

Improper scope display due to wrong vertical gain setting, .5V/div.

Only the first reflection is significant and should be magnified.

See G.

Figure 4-14 (Part 2 of 3). Display Examples

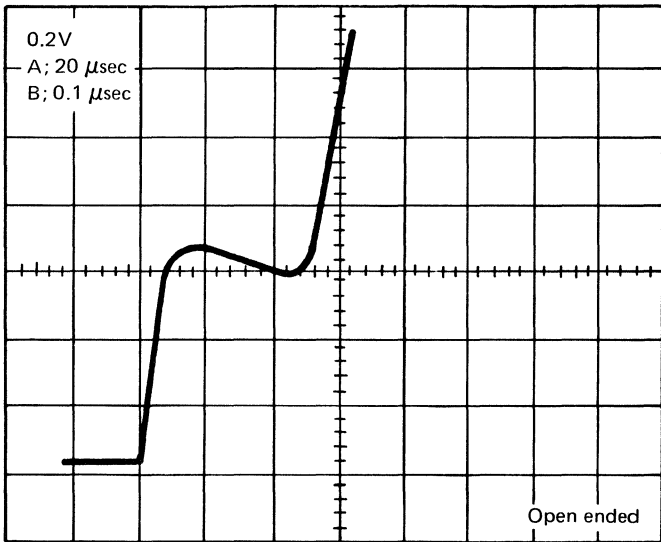

G

Same as F now with scope set to higher vertical gain, 0.2V.

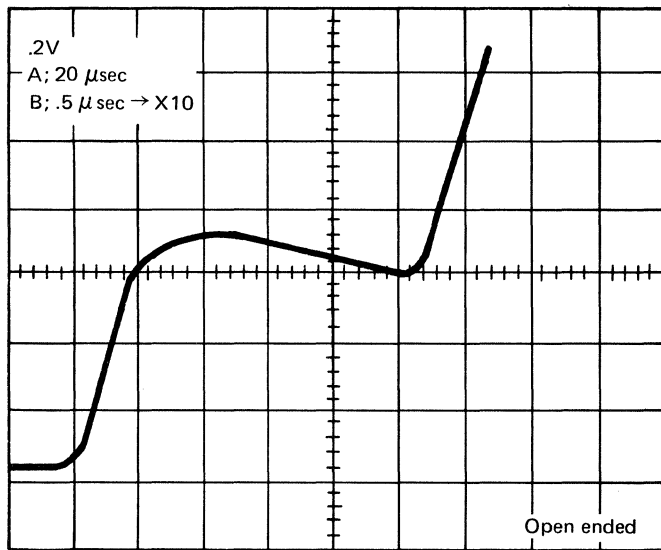

H

Same as G but magnified with X10.

This is the first reflection section of picture G.

A smooth cable 5.2 divisions long (as opposed to 2.6 div on A) with overshoot.

$$5.2 \times 20 \text{ ft (6.2 m)} = 104 \text{ ft (31.7 m)}$$

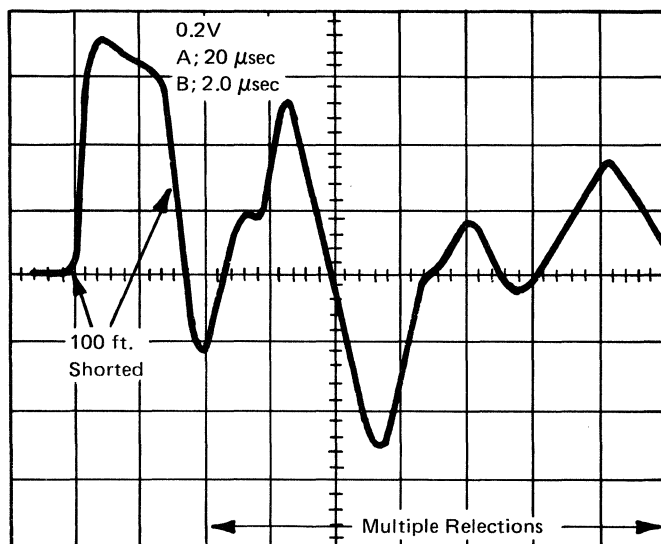

J

Improper Setup of Scope.

Multiple reflections due to wrong, slow B group setting.

Same 28 m (100 ft) as in F, G, and H.

Only the first reflection is significant; the normal, multiple reflections of the test pulse should be cancelled out on the display by using a B time that will display the first reflection only, using the whole screen or as great a portion of the screen as possible. See H.

Figure 4-14 (Part 3 of 3). Display Examples



# Chapter 5. Reference Data

## 5.1 INTRODUCTION

This chapter provides the following information as an aid to maintenance:

- Command summary
- Order summary
- Various codes
- Sequence/response diagrams
- Status and sense byte descriptions
- Switches and controls

## 5.2 CONTROL UNIT COMMAND SUMMARY

See Figure 5-1 for control unit command codes.

Command	3274 Models 51C, 61C	
	EBCDIC Hex	Graphic
Copy <sup>1</sup>	F7	7
Erase All Unprotected	6F	?
Erase/Write	F5	5
Erase/Write Alternate	7E	=
Read Buffer	F2	2
Read Modified	F6	6
Read Modified All <sup>2</sup>	6E	:
Write	F1	1
Write Structured Field	F3	NA
No Operation	NA	NA
Select	NA	NA
Sense	NA	NA

<sup>1</sup> Applicable to 3274 Models 51C and 61C (BSC).

<sup>2</sup> Applicable to 3274 (SNA/SDLC).

Figure 5-1. Command Codes

### 5.2.1 Write

The Write command:

1. Transfers the contents of the addressed device buffer to the control unit (CU) storage buffer.
2. Performs the operation specified by the write control character (WCC).
3. Enters data in any portion of the CU storage buffer (without erasing or modifying portions of the buffer in which a change is not required).

4. Allows execution of various order sequences within the data stream.
5. Transfers the updated CU buffer to the device buffer.

### 5.2.2 Erase/Write

The Erase/Write command:

1. Clears the CU buffer to nulls.
2. Performs operations specified by the WCC.
3. Stores new data characters provided by the program.
4. Allows execution of various order sequences within the data stream.
5. Transfers the updated CU buffer to the device buffer.

### 5.2.3 Erase/Write Alternate

1. Switches the device to alternate character capacity.
2. Performs normal erase/write operation.

### 5.2.4 Erase All Unprotected

The Erase All Unprotected command:

1. Clears all unprotected alphameric characters to nulls, resets modified data tag (MDT) bits of all unprotected fields to 0, restores the keyboard, resets the attention identifier (AID), and repositions the cursor to the first character location in the first unprotected field in the buffer.
2. Is performed at the device and has no data stream.

### 5.2.5 Read Buffer

The Read Buffer command:

1. Transfers the contents of the addressed device buffer to the CU buffer.
2. Data stream transferred to the host includes the AID character, the cursor address, and the contents of all device buffer locations (both protected and unprotected). These include attribute and alphameric characters (including nulls), starting at a specific location and continuing to the end of the buffer, unless the channel byte count goes to zero before the last location is reached.

### 5.2.6 Read Modified

Receipt of a Read Modified command (or a Poll when an AID is pending) generates one of three different data streams, depending on the AID code present. Their descriptions follow.

### 5.2.6.1 Read Modified Read

The Read Modified Read command:

1. Transfers the contents of the addressed device buffer to the CU buffer.
2. Data stream transferred to the host includes the AID character, the cursor address, and all fields in which the MDT bit has been set. The data stream for each modified field contains the SBA order, the buffer address of the attribute character plus 1, and all alphanumeric characters (with nulls suppressed).
3. The command is issued by the program or as a result of an ENTER, PF key, selector-pen attention, or operator identification card read-in operation.

### 5.2.6.2 Short Read Read

The Short Read Read command:

1. Permits the display operator to communicate with the host program without sending modified data characters. This action is initiated when the display operator presses CLEAR, CANCEL, or a PA key.
2. A read-modified operation is performed, but only the unique AID character, to identify the key pressed, is sent to the host program.

### 5.2.6.3 Test Request Read (Models 51C and 61C, BSC)

1. A read-modified operation is performed if the TEST REQ or the SYS REQ (BSC only) key has been pressed at a device.
2. A Test Request Read heading is generated by the control unit. The sequence is: SOH % / STX.
3. If the device buffer is unformatted, all alphanumeric data in the buffer is included in the data stream (nulls are suppressed). If the device buffer is formatted, only fields that have the MDT bit set will be included in the data stream following the Test Request Read heading.

### 5.2.7 Read Modified All (3274 SNA Only)

1. The Read Modified All command is sent only by the primary logical unit (host application).
2. A read-modified operation is performed, and all modified fields in the selected device are sent to the host, regardless of the AID byte generated.

### 5.2.8 Copy (Models 51C and 61C, BSC)

The Copy command:

1. Transfers the contents of one device buffer to another device buffer via the CU buffer.
2. The device whose contents are transferred is called the *from* device.
3. The receiving device is called the *to* device.
4. The *to* device is selected in the addressing sequence.

5. Two bytes always follow the command byte: (1) the copy control character (CCC) and (2) the address of the *from* device.
6. The CCC performs a function similar to that of the WCC in the Write and Erase/Write commands.
7. The *from* device buffer can be *locked* (incapable of being copied) by storing a protected alphanumeric attribute character in buffer address 0.
8. The addressed device (that is, the *to* device) may also be specified as the *from* device. This permits troubleshooting the Copy command with a single device.

### 5.2.9 Write Structured Field

The Write Structured Field command is used to transmit data in structured field format.

The WSF instruction provides the mechanism for:

1. Loading symbol definition data into a specified terminal's storage.
2. Querying a terminal as to its characteristics.
3. Specifying the type of inbound transmission desired.
4. Allowing/disallowing operator selection of color, extended highlighting, and symbol set attributes for keyed data.

The WSF command must be the first item in any structured field transmission.

## 5.3 CONTROL UNIT ORDER SUMMARY

See Figure 5-2 for control unit order codes.

### 5.3.1 Set Buffer Address (SBA)

The Set Buffer Address (SBA) order loads data, starting at the address immediately following the SBA character.

The format is: SBA, address, address.

### 5.3.2 Start Field (SF)

The Start Field (SF) order specifies the next character as an attribute character.

The format is: SF, attribute character.

### 5.3.3 Insert Cursor (IC)

The Insert Cursor (IC) order changes the address in the CU buffer and thus repositions the cursor on the display screen. Because the CU buffer address is not advanced when the IC order is loaded in the CU buffer, the next byte is stored at the cursor address.

The format is: IC.

Order Sequence	Byte 1 (Order Code)		Byte 2	Byte 3	Byte 4
	EBCDIC (Hex)	ASCII (Hex)			
Start Field (SF)	1D	1D	Attribute Character <sup>1</sup>		
Set Buffer Address (SBA)	11	11	1st Address Byte	2nd Address Byte	
Insert Cursor (IC)	13	13			
Program Tab (PT)	05	09			
Repeat to Address (RA)	3C	14	1st Address Byte	2nd Address Byte	Character to Be Repeated <sup>2</sup>
Erase Unprotected to Address (EUA)	12	12	1st Address Byte	2nd Address Byte	

<sup>1</sup> Figure 5-17 shows coding of this byte.

<sup>2</sup> Figures 5-3, 5-4, and 5-12 show coding of this byte.

**Figure 5-2. Buffer Control Orders and Order Codes**

### 5.3.4 Repeat to Address (RA)

The Repeat to Address (RA) order loads a single character repeatedly, starting at the current CU buffer address and continuing to, *but not including*, the address specified in the order sequence. The cursor is not affected.

The format is: RA, address, address, character.

### 5.3.5 Erase Unprotected to Address (EUA)

The Erase Unprotected to Address (EUA) order deletes all unprotected-field characters beginning with the character at the current address to, *but not including*, the character at the address specified in the order sequence. If the address specified in the order sequence equals the *current address*, wraparound occurs, and all unprotected characters are deleted. The attribute characters defining the unprotected fields are not deleted.

The format is: EUA, address, address.

### 5.3.6 Program Tab (PT)

The Program Tab (PT) order advances the CU buffer address to that of the character position immediately following the next attribute character that defines an unprotected field. The cursor is unaffected, and no wraparound occurs. The search begins at the current buffer address. The final result depends on one of three conditions:

1. When PT immediately follows a data character within an unprotected field, all remaining characters within that field are replaced by nulls.
2. When PT immediately follows a WCC or an order sequence, no nulls are inserted.

3. When the current buffer address contains an attribute character that defines an unprotected field, the CU buffer address is simply advanced one character location.

The format is: PT.

### 5.3.7 New Line (NL)

When included in the data stream addressed to a printer, the New Line (NL) order initiates a carriage return/line feed (CR/LF) operation by the printer. That is, the platen is advanced one line and the print mechanism is returned to the first print position of the new line. If this order is included in the data stream addressed to a display, the NL order is displayed as the number 5 (space 5 for Katakana), but does not cause action in the CU or display. In any case, it is stored in the CU buffer as the number 5 (space 5 for Katakana).

The format is: NL.

### 5.3.8 End of Message (EM)

The End of Message (EM) order must be included at the end of a message addressed to a printer to notify it when to stop printing. If the EM order is not included at the end of the printer message, the printer will print out the contents of the complete printer buffer (either 480 or 1920 characters). If this order is included in the data stream addressed to a display, the EM order is displayed as the number 9 (space 9 for Katakana), but does not cause action in the CU or display. In any case, it is stored in the CU buffer as the number 9 (space 9 for Katakana).

The format is: EM.

### 5.3.9 Duplicate (DUP)

The Duplicate (DUP) order informs the program that the DUP key was pressed by the display station operator. Its actual function is determined by the CPU program. The DUP order is displayed as an asterisk (\*) with overscore. It is stored in the CU buffer, but does not cause action in the CU.

The format is: DUP.

### 5.3.10 Field Mark (FM)

The Field Mark (FM) order informs the CPU program that the FM key was pressed by the display operator. It indicates the end of a field to the program. The FM order is displayed as a semicolon (;) with overscore. It is stored in the CU buffer, but does not cause action in the CU.

The format is: FM.

### 5.3.11 Forms Feed (FF) (Category A and 3288 Printers)

Valid Forms Feed (FF) orders are executed by all Category A printers and by the 3288 printer during printouts, both with and without a line-length format specified. (The FF order is described in the *IBM 3270 Information Display System 3274 Control Unit Description and Programmer's Guide*, GA23-0061.) When a valid FF order is encountered in the first print position of a line, with the Page Length Control/VFC feature installed, the print form indexes to a predetermined print line on the next form.

### 5.3.12 Carriage Return (CR) (Category A Printers)

When the Carriage Return (CR) order code is found in the data stream, the next print position will be the leftmost character position on the current print line. CR orders are not executed when they occur in nonprint fields, and when the printer format bits in the WCC indicate a line length (40, 64, or 80 characters). In both cases, the CR order is printed as a space character.

### 5.3.13 Structured Field and Attribute Processing Orders

#### 5.3.13.1 Start Field Extended (SFE)

This order is used to define the start of a field and to assign Color, Extended Highlighting, and Programmed Symbol attributes to a field.

The format is:

SFE, number of type/value pairs, type-value type-value  
... type-value

#### 5.3.13.2 Modify Field (MF)

This order is used to selectively change field; Color, Extended Highlighting, and Programmed Symbol attributes at the current buffer address. The current buffer address be that of a field attribute byte. Only the attribute bytes specified in the order are changed.

The format is:

MF, number of type/value pairs, type-value type-value  
... type value

#### 5.3.13.3 Set Attribute (SA)

This order is used to change the; Color, Extended Highlighting, or the Programmed Symbol attributes applicable to the character at the current buffer address, or to set these attribute types to their default value.

The format is:

SA, type-value

For more information on Command Codes, Orders, and Attribute types and values, refer to the Description and Programmer's Guide (GA23-0061).

## 5.4 I/O INTERFACE CODES

The I/O interface codes for the 3274 Control Unit are illustrated in Figures 5-3 through 5-12. For information concerning Buffer Address I/O Interface Codes, refer to *3270 Information Display System Reference Summary*, GX20-1878.



Hex 1 Bits 4567		00				01				10				11				Bits 0,1
		00	01	10	11	00	01	10	11	00	01	10	11	00	01	10	11	Bits 2,3
		0	1	2	3	4	5	6	7	8	9	A	B	C	D	E	F	Hex 0
0000	0	NUL			SP	&	—							(	)	AA	0	
0001	1						/		a	j	—			A	J		1	
0010	2								b	k	s			B	K	S	2	
0011	3								c	l	t			C	L	T	3	
0100	4								d	m	u			D	M	U	4	
0101	5		NL						e	n	v			E	N	V	5	
0110	6								f	o	w			F	O	W	6	
0111	7								g	p	x			G	P	X	7	
1000	8								h	q	y			H	Q	Y	8	
1001	9		EM						i	r	z			I	R	Z	9	
1010	A				¢	!	6A	:										
1011	B				.	\$	.	#										
1100	C	FF	DUP		<	*	%	@										
1101	D				(	)	—	'										
1110	E		FM		+	;	>	=										
1111	F					⌋	?	"										

**Notes:**

- Character code assignments other than those shown within all outlined areas of this chart are undefined. If an undefined character code is programmed, the character that will be displayed is not specified. IBM reserves the right to change at any time the character displayed for an undefined character code.
- Lowercase alphabetic characters (shown within the dotted outlined area) are converted to uppercase by the display station or printer and displayed or printed as uppercase characters, unless the terminal has Dual Case capability.

**Legend:**

 = Stored as a lowercase symbol. Displayed on Mono Case display only. Blank on Dual Case display. Cannot be entered from keyboard.

 6A or  AA = Stored as Hex code shown. Nondisplayed on Mono and Dual Case displays.

**Figure 5-3. United States EBCDIC I/O Interface Code for 3274 Control Unit and Attached Category B Devices**

Hex 1 Bits 4567		00				01				10				11				Bits 0,1
		00	01	10	11	00	01	10	11	00	01	10	11	00	01	10	11	Bits 2,3
		0	1	2	3	4	5	6	7	8	9	A	B	C	D	E	F	Hex 0
0000	0	NUL				SP	&	-						{	}	\	0	
0001	1						/			a	j	~		A	J		1	
0010	2									b	k	s		B	K	S	2	
0011	3									c	l	t		C	L	T	3	
0100	4									d	m	u		D	M	U	4	
0101	5		NL							e	n	v		E	N	V	5	
0110	6									f	o	w		F	O	W	6	
0111	7									g	p	x		G	P	X	7	
1000	8									h	q	y		H	Q	Y	8	
1001	9		EM							i	r	z		I	R	Z	9	
1010	A					ç	!		:									
1011	B					.	\$	,	#									
1100	C	FF	DUP			<	*	%	@									
1101	D	CR				(	)	_	'									
1110	E		FM			+	;	>	=									
1111	F						⌋	?	"									

**Notes:**

1. Character code assignments other than those shown within all outlined areas of this chart are undefined. If an undefined character code is programmed, the character that will be displayed or printed is a hyphen. IBM reserves the right to change at any time the character displayed for an undefined character code.
2. NL (hex 15), EM (hex 19), FF (hex 0C), NUL (hex 00), and CR (hex 0D) are not displayed or printed. The DUP (hex 1C) and FM (hex 1E) control characters on Dual Case featured terminals are displayed as \* and ; respectively, and are printed as \* and ;.
3. DUP (hex 1C) and FM (hex 1E) control characters on Mono Case terminals are displayed as \* and ; respectively, and are printed as \* and ;.

**Figure 5-4. United States EBCDIC I/O Interface Code for 3274 Control Unit and Attached Category A Devices**

		Hex 1								Bits
		000	001	010	011	100	101	110	111	← 7, 6, 5
Bits 4321		0	1	2	3	4	5	6	7	← Hex 0
0000	0	NUL		SP	0	@	P	·	p	
0001	1			!	1	A	Q	a	q	
0010	2			"	2	B	R	b	r	
0011	3			#	3	C	S	c	s	
0100	4			\$	4	D	T	d	t	
0101	5		NL	%	5	E	U	e	u	
0110	6			&	6	F	V	f	v	
0111	7			'	7	G	W	g	w	
1000	8			(	8	H	X	h	x	
1001	9		EM	)	9	I	Y	i	y	
1010	A			*	:	J	Z	j	z	
1011	B			+	;	K	[	k	}	
1100	C	FF	DUP	,	<	L	\	l		
1101	D	CR		-	=	M	]	m	}	
1110	E		FM	.	>	N	^	n	~	
1111	F			/	?	O	_	o		

**Notes:**

1. Character code assignments other than those shown within all outlined areas of this chart are undefined. If an undefined character code is programmed, the character that will be displayed is not specified. IBM reserves the right to change at any time the character displayed for an undefined character code.
2. Lowercase alphabetic characters (shown within the dotted outlined area) are converted to uppercase by the display station or printer and displayed or printed as uppercase characters, unless the terminal has Dual Case capability.

**Figure 5-5. United States ASCII I/O Interface Code for 3274 Control Unit and Attached Category A Devices**

*	1	Printout Format	Start Print	Sound Alarm	Kbd Restore	Reset MDT Bits	
0	1	2	3	4	5	6	7

\*Determined by the configuration of bits 2–7. See Figure 5-12.

Figure 5-6. Format of Write Control Character (WCC) Byte

Bit	Explanation
0	Determined by the contents of bits 2–7 as shown in Figure 5-12.
1	Reserved (must be a 1).
2,3	Define the printout format, as follows: = 00 – The NL, EM, and CR* orders in the data stream determine print line length. Provides a 132-print position line when the orders are not present. = 01 – Specifies 40-character print line. = 10 – Specifies 64-character print line. = 11 – Specifies 80-character print line.
4	Start Printer bit. When set to 1, initiates a printout operation at completion of the write operation.
5	The Sound Alarm bit. When set to 1, sounds the audible alarm at the selected device at the end of the operation if that device has an audible alarm.
6	The Keyboard Restore bit. When set to 1, restores operation of the keyboard by resetting the INPUT INHIBITED indicator on 3275 and 3277 displays, and the System Lock or Wait symbol on 3276 and 3278 displays. It also resets the AID byte at the termination of the I/O command.
7	Reset MDT bits. When set to 1, all MDT bits in the selected devices' existing buffer data are reset before any data is written or orders are executed.

\*The CR order is applicable to Category A Printers only.

Figure 5-7. Function of Write Control Character (WCC) Bits



Attribute	X	X	U/P	A/N	I/SPD	0	MDT
-----------	---	---	-----	-----	-------	---	-----

EBCDIC Bits 0 1 2 3 4 5 6 7

**EBCDIC**

- Bit 0,1 = XX Determined by contents of bits 2-7.
- Bit 2 = 0 Unprotected data.
- Bit 2 = 1 Protected data - Autolock.
- Bit 2,3 = 1,1 Autoskip.
- Bit 3 = 0 Alphameric data.
- Bit 3 = 1 Numeric data - Autoskip
- Bit 4,5 = 0,0 Normal Intensity/Nondetectable.
- Bit 4,5 = 0,1 Normal Intensity/Selector-Pen-Detectable.
- Bit 4,5 = 1,0 High Intensity/Selector-Pen-Detectable.
- Bit 4,5 = 1,1 Nondisplay/Nonprint/Nondetectable.
- Bit 6 = 0 Reserved. Must be zero.
- Bit 7 = 0 Field data not tagged as modified.
- Bit 7 = 1 Field data tagged as modified.

ATTRIBUTE						Bits		Hex	Graphic Display
Prot	A/N Auto-Skip	MDT ON	High Intens	Sel Pen Det	Non Disp PRT	23	4567		
U						00	0000	40	æ g c z
U		Y				00	0001	C1	
U				Y		00	0100	C4	
U		Y		Y		00	0101	C5	
U			H	Y		00	1000	C8	A j i
U		Y	H	Y		00	1001	C9	
U			-	-	Y	00	1100	4C	
U		Y	-	-	Y	00	1101	4D	
U	N					01	0000	50	P S B
U	N	Y				01	0001	D1	
U	N			Y		01	0100	D4	
U	N	Y		Y		01	0101	D5	
U	N		H	Y		01	1000	D8	→ B ↓
U	N	Y	H	Y		01	1001	D9	
U	N		-	-	Y	01	1100	5C	
U	N	Y	-	-	Y	01	1101	5D	
P						10	0000	60	C C C N
P		Y				10	0001	61	
P				Y		10	0100	E4	
P		Y		Y		10	0101	E5	
P			H	Y		10	1000	E8	E S I i
P		Y	H	Y		10	1001	E9	
P			-	-	Y	10	1100	6C	
P		Y	-	-	Y	10	1101	6D	
P	S					11	0000	F0	X - A
P	S	Y				11	0001	F1	
P	S			Y		11	0100	F4	
P	S	Y		Y		11	0101	F5	
P	S		H	Y		11	1000	F8	↑ - A
P	S	Y	H	Y		11	1001	F9	
P	S		-	-	Y	11	1100	7C	
P	S	Y	-	-	Y	11	1101	7D	

H = High      S = Auto-Skip  
 N = Numeric    U = Unprotected  
 P = Protected   Y = Yes

**Figure 5-8. Attribute Character Bit Assignments for 3278s**

To examine data for proper attributes and the setting or resetting of modified data tags (MDTs), use the following procedure:

1. Place the CE jumper, as shown in Figure 5-9, on the A-gate top-card connector that connects card F2 to card G2 on the A-gate with three base cards (Figure 5-9), or card F4 to card G4 on the A-gate with two base cards (Figure 5-10).
2. Attribute and nondisplay fields will now be displayed and can be compared with the graphic display in this figure.
3. Remove the jumper when completed.

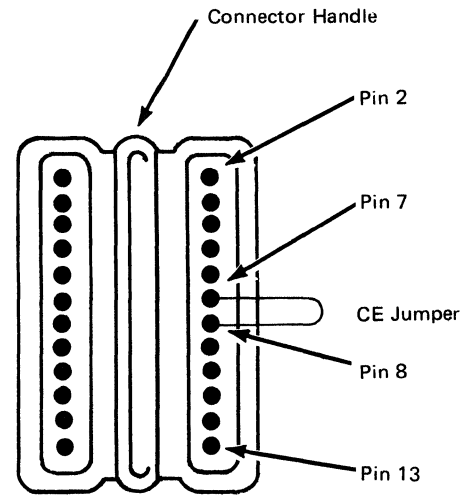

**Figure 5-9. 3278 Top-Card Connector CE Jumper (Three Base Cards)**

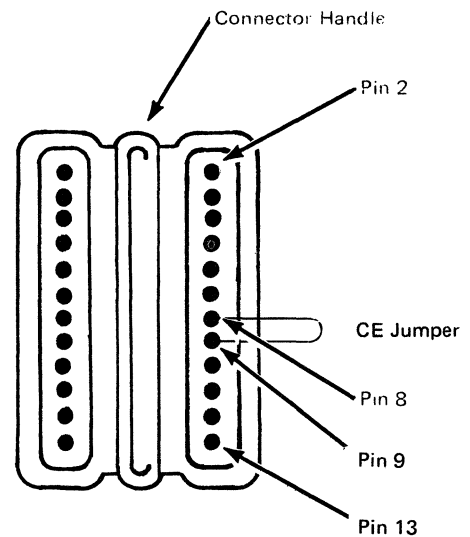

**Figure 5-10. 3278 Top-Card Connector CE Jumper (Two Base Cards)**

X	1	U/P	A/N	D/SPD	Reserved	MDT	
0	1	2	3	4	5	6	7

EBCDIC Bit	Field Description
0	- Value determined by contents of bits 2–7.
1	- Must be a 1.
2	- 0 = Unprotected - 1 = Protected
3	- 0 = Alphameric 1 = Numeric (causes automatic upshift of data entry keyboard)
	<b>Note:</b> Bits 2 and 3 equal to 11 causes an automatic skip. See text.
4 & 5	- 00 = Display/not selector-pen-detectable 01 = Display/selector-pen-detectable 10 = Intensified display/selector-pen-detectable 11 = Nondisplay, noprint, nondetectable
6	- Reserved. Must always be 0.
7	- Modified Data Tag (MDT); identifies modified fields during Read Modified command operations.  0 = Field has not been modified 1 = Field has been modified by the operator. Can also be set by program in data stream.

**Notes:**

1. Bits 0 and 1 are not decoded when received by the 3270. When characters are being transferred to the CPU, bit 1 is a 1 and bit 0 is set, depending upon the character being transferred. All attribute characters are part of the defined character set. The default option (bits 2 through 7 all set to 0) results in an unprotected, alphameric, displayed, nondetectable field.
2. To examine data for proper attributes and the setting or resetting of modified data tags (MDTs), use the following procedure:
  - a. Jumper J2M13 or H2D07 to Gnd (D08). 3277s with APL Text should also jumper K2B07 to Gnd (attribute byte of "6D" will not be displayed).
  - b. Attribute and nondisplay fields will now be displayed and can be compared with Figure 5-12.
  - c. Remove the jumpers when completed.

**Figure 5-11. Attribute Character Bit Assignments for 3277s**

Bits 2-7	Graphic	EBCDIC	ASCII	Bits 2-7	Graphic	EBCDIC	ASCII
00 0000	SP	40	20	10 0000	-	60	2D
00 0001	A	C1	41	10 0001	/	61	2F
00 0010	B	C2	42	10 0010	S	E2	53
00 0011	C	C3	43	10 0011	T	E3	54
00 0100	D	C4	44	10 0100	U	E4	55
00 0101	E	C5	45	10 0101	V	E5	56
00 0110	F	C6	46	10 0110	W	E6	57
00 0111	G	C7	47	10 0111	X	E7	58
00 1000	H	C8	48	10 1000	Y	E8	59
00 1001	I	C9	49	10 1001	Z	E9	5A
00 1010	¢, [	4A	5B	10 1010	! (EBCDIC)	6A	C
00 1011	.	4B	2E	10 1011	,	6B	2C
00 1100	<	4C	3C	10 1100	%	6C	25
00 1101	(	4D	28	10 1101	-	6D	5F
00 1110	+	4E	2B	10 1110	>	6E	3E
00 1111	, !	4F	21	10 1111	?	6F	3F
01 0000	&	50	26	11 0000	0	F0	30
01 0001	J	D1	4A	11 0001	1	F1	31
01 0010	K	D2	4B	11 0010	2	F2	32
01 0011	L	D3	4C	11 0011	3	F3	33
01 0100	M	D4	4D	11 0100	4	F4	34
01 0101	N	D5	4E	11 0101	5	F5	35
01 0110	O	D6	4F	11 0110	6	F6	36
01 0111	P	D7	50	11 0111	7	F7	37
01 1000	Q	D8	51	11 1000	8	F8	38
01 1001	R	D9	52	11 1001	9	F9	39
01 1010	!, ]	5A	5D	11 1010	:	7A	3A
01 1011	\$	5B	24	11 1011	#	7B	23
01 1100	*	5C	2A	11 1100	@	7C	40
01 1101	)	5D	29	11 1101	'	7D	27
01 1110	;	5E	3B	11 1110	=	7E	3D
01 1111	¬, ^	5F	5E	11 1111	"	7F	22

**Note:** The following characters are used as attribute, AID, write control (WCC), copy control (CCC), CU and device address, and buffer address. They are also used as status and sense, except by the 3274 when operating in BSC. When any character is received by the CU, only the low-order 6 bits are used. When any of these characters is transmitted to the program, the CU assigns the appropriate EBCDIC code. If transmission is in ASCII, the CU translates the EBCDIC code to ASCII code prior to transmission.

For example, to use this table to determine the hex code transmitted for an attribute character, first determine the values of bits 2-7. Select this bit configuration in the table under "Bits 2-7". The hex code that will be transmitted (either in EBCDIC or ASCII) is to the right of the bit configuration.

Use this table also to determine equivalent EBCDIC and ASCII hex codes and their associated graphic characters.

Graphic characters for the United States I/O interface codes are shown. If a World Trade I/O interface code is used, refer to the *IBM 3270 Information Display System: Character Set Reference* manual, GA27-2837, for possible graphic character differences.

**Figure 5-12. Control Character I/O Codes**

## 5.5 EXAMINING 3279 ATTRIBUTES AND MODIFIED DATA TAGS

To examine data in the 3279 refresh buffer (not the ECS buffer) for proper attributes and the setting or resetting of modified data tags (MDTs), use the following procedure:

1. Place the CE jumper as shown in Figure 5-13.
2. Position the cursor at the location where the attribute is to be displayed.
3. Place the Normal/Test switch in the Test position. Nulls will display as  and attributes are blank. Note that base white and red change to red and white, respectively.
4. Press CONTROL D. The character, or attribute, at the cursor position is copied into the first position of the operator information area and the cursor advances.
5. Refer to Figure 5-14 to determine if the attributes are being correctly interpreted by the hardware.

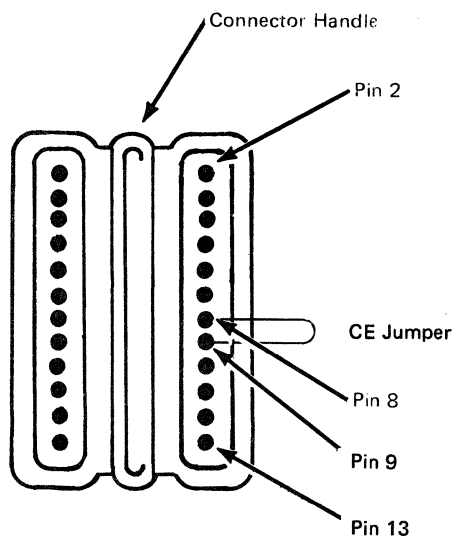

Figure 5-13. 3279 Top-Card Connector CE Jumper

0	1	2	3	4	5	6	7
1	1	Protected	Alpha-numeric			Reserved	Modified Data Tag
2	4	5					
			Color of Field	Sel Pen Detectable			
0	0	0	GREEN	NO			
1	0	0	BLUE	NO			
0	0	1	GREEN	YES			
1	0	1	BLUE	YES			
0	1	0	RED	YES			
1	1	0	WHITE	YES			
0	1	1	Nondisplay	NO			
1	1	1	Nondisplay	NO			

Figure 5-14. 3279 Base Field Attributes

## 5.6 SEQUENCE/RESPONSE DIAGRAMS, BSC

Figures 5-15 through 5-19 provide the sequences and responses that occur during online BSC operation of the 3274.

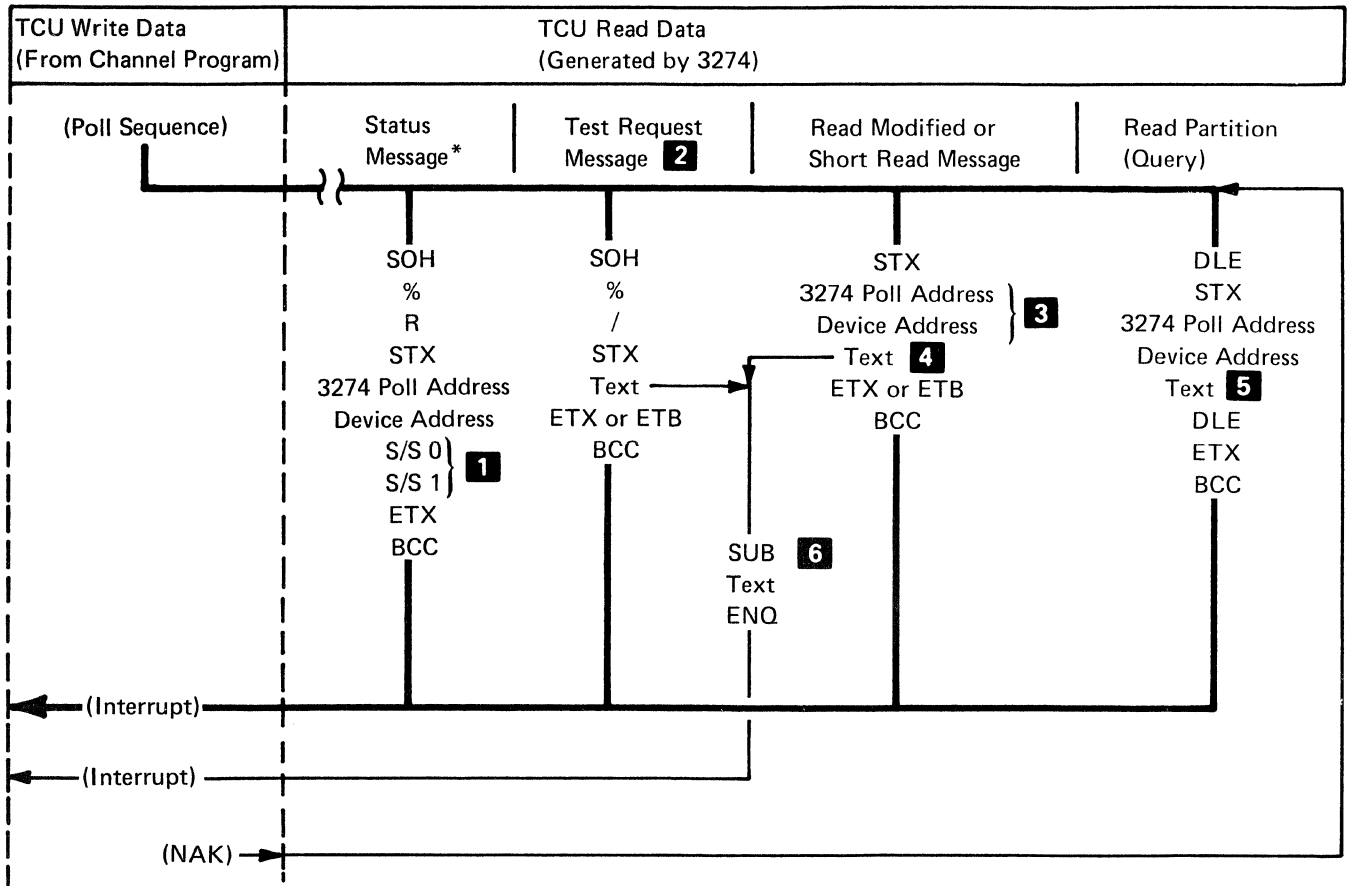

**Notes:**

- 1** A status message response is issued to a General or Specific Poll if (1) the 3274 has pending status (General Poll ignores Device Busy and device "unavailable" and the 3274 continues polling of next device), or (2) error status develops during execution of the poll.
- 2** A Test Request Message response is issued to a General or Specific Poll if a TEST REQ key is pressed at the keyboard of a polled Category B display, or if a SYS REQ key is pressed at a Category A display.
- 3** This address is included only in the first block of a blocked text message.
- 4** The text portion of this message is the result of either a read-modified or short-read operation by the 3274.
- 5** The text portion of this message is the result of a Read Partition (Query) structured field function.
- 6** Inbound abort, error occurred on device after first block sent to host.

**Legend:**

(Interrupt) = TCU-generated interrupt.

\*Response to General Poll or Specific Poll only (not program-generated Read Modified command)

**Figure 5-15. 3274 Message Response to Polling or Read Modified Command**

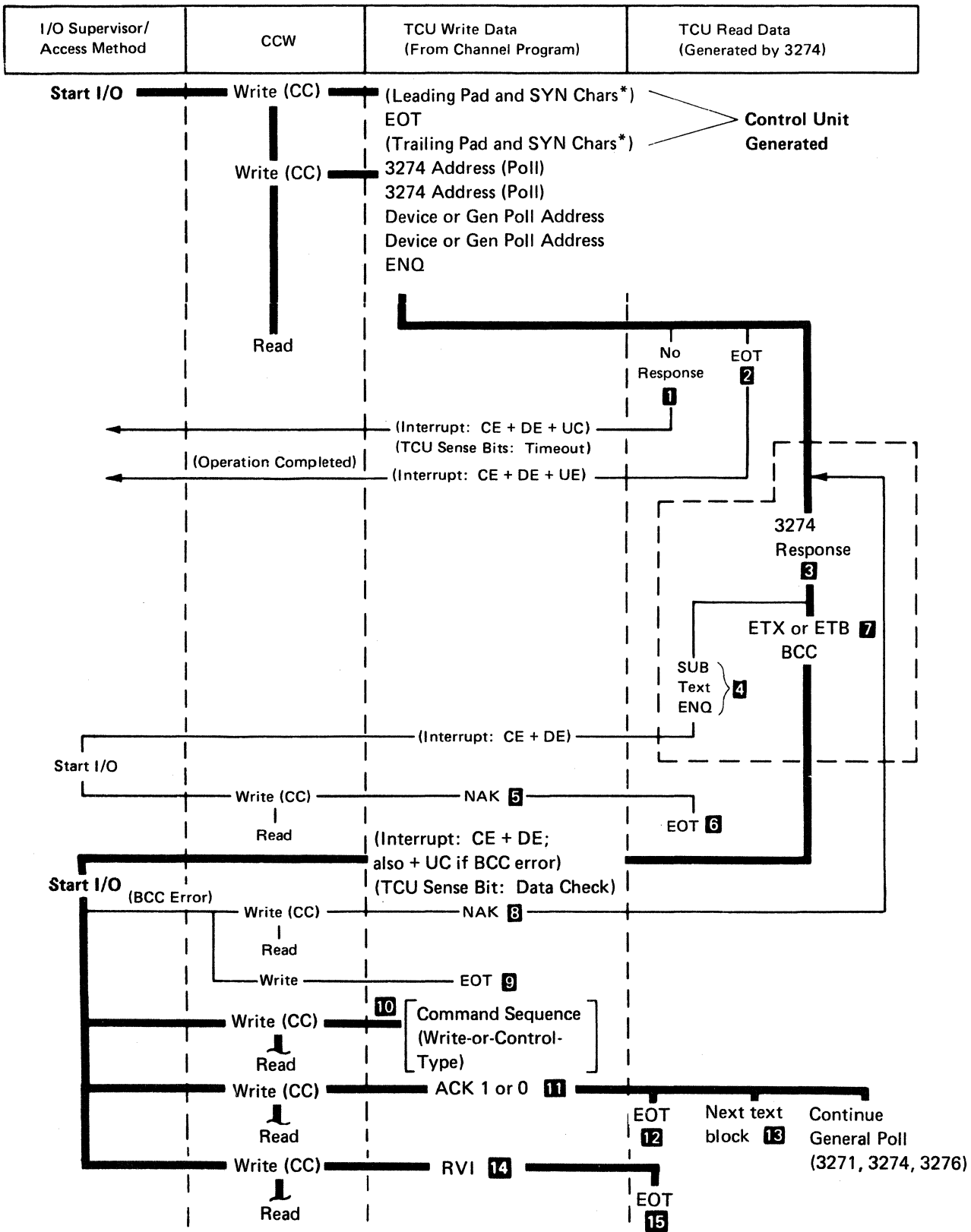

Figure 5-16 (Part 1 of 2). General Poll and Specific Poll, Sequence/Response Diagram

**Notes:**

- 1** The 3274 will fail to respond to the addressing or polling sequence, causing a TCU timeout, for any of the following reasons:
  - The 3274 is "unavailable" (has power off, is "offline", or is not attached).
  - Any character in the polling sequence is invalid.
  - The characters in the polling sequence are out of order.
  - The polling sequence is incomplete (less than seven characters).
  - The 3274 address is incorrect in the write data stream.
  - The addressed 3274 was left selected from the previous transmission.
- 2** There is no I/O pending nor pending status. For General Poll, the CU sends EOT only after polling all devices.
- 3** The device response is a function of the kind of device and its status. Types of responses include: Text, Status, and Test Request messages.

3274: For General Poll, the search for a response starts at some random device address and continues sequentially (as long as ACKs are received in response to text transmissions) until all devices are given the opportunity to respond.
- 4** Upon detection of an internal parity check or a cursor check, the 3274 (1) substitutes the SUB character for the character in error, (2) records Data Check status, and (3) transmits an ENQ in place of ETX (or ETB) and BCC at the end of the text block. The general poll process is stopped.
- 5** Mandatory program response to a text block terminated in ENQ.
- 6** Terminates the operation. The nature of the error (parity or cursor check) does not warrant a retry. This response indicates that status and sense information is stored and that internal 3271/device polling is stopped.
- 7** ETB is used to frame each block of a blocked text message, except the last block. ETX is used to frame the last block of a blocked text message.
- 8** BCC error has been detected. The program issues NAK to cause the 3274 to repeat its last transmission.
- 9** Response issued by the program to terminate the operation if the TCU is unsuccessful in receiving a valid BCC following "n" attempts by the 3274 to transmit the message. This response does not cause the 3274 to reset its sense/status information. Therefore, the same status message will be transmitted if a Specific Poll is immediately issued to the same device.
- 10** This transmission must be a write or control-type command sequence. A read-type command would violate BSC standards on Limited Conversational mode.

3274: For General Poll, this transmission stops the polling operation. The General Poll must be reinitiated to ensure receipt of all pending device messages.
- 11** Positive acknowledgment. The text block has been successfully received by the TCU. The program issues ACK 1 in response to the first and all odd-numbered text blocks and issues ACK 0 in response to the second and all even-numbered text blocks.
- 12** Normal termination of a Specific Poll.

3274: Normal termination of a General Poll.
- 13** The second and all succeeding text blocks are framed as the first except they do not include the 3274/device address sequence.
- 14** RVI to terminate polling sequence.
- 15** Termination of polling sequence on receipt of RVI.

**LEGEND:**

(CC) = Chain Command (CC) Flag in CCW is set to 1.

(Interrupt) = TCU-generated interrupt (CE = Channel End, DE = Device End, UE = Unit Exception, UC = Unit Check).

\*Only the critical framing characters (sync pattern and pad) are shown. All other framing characters are also hardware-generated as required. See SL *General Information - Binary Synchronous Communications*, GA27-3004, for a complete description.

**Figure 5-16 (Part 2 of 2). General Poll and Specific Poll, Sequence/Response Diagram**

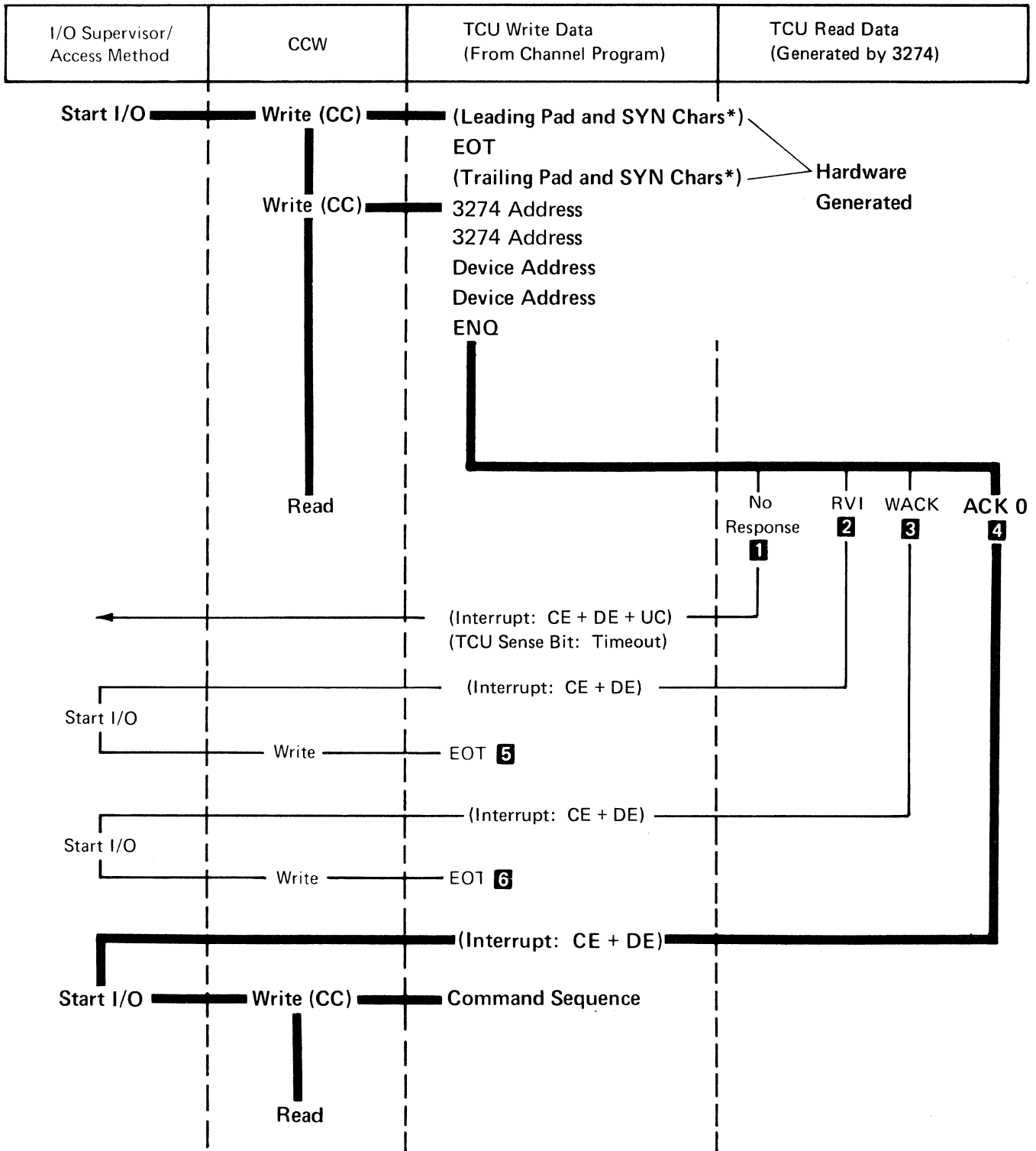

\*Only the critical framing characters (sync pattern and pad) are shown. All other framing characters are also hardware-generated as required. See *SL General Information – Binary Synchronous Communications, GA27-3004*, for a complete description.

**Figure 5-17 (Part 1 of 2). Selection Addressing, Sequence/Response Diagram**



**Notes:**

- 1** The 3274 will fail to respond to the addressing or polling sequence causing a TCU timeout, for any of the following reasons:
  - The 3274 is “unavailable” (has power off, is “offline”, or is not attached).
  - Any character in the polling sequence is invalid.
  - The characters in the polling sequence are out of order.
  - The polling sequence is incomplete (less than seven characters).
  - The 3274 address is incorrect in the write data stream.
  - The addressed 3274 was left selected from the previous transmission.
- 2** 3274: The addressed device has pending status (excluding Device, Busy or Device End).
- 3** The addressed 3274 device, including the 3284-3 Printer is busy. No S/S information is stored. An RVI response takes precedence over a WACK response.
- 4** The address has been successfully received, and no status is pending.
- 5** Termination of attempted addressing sequence:  
3274: Availability of valid status and sense information cannot be ensured unless a Specific Poll is issued to the responding device as the next addressing sequence issued to this 3274.
- 6** Termination of attempted addressing sequence.

**LEGEND:**

(CC) = Chain Command (CC) Flag in CCW is set to 1.

(Interrupt) = TCU-Generated interrupt (CE = Channel End, DE = Device End, and UC = Unit Check)

**Figure 5-17 (Part 2 of 2). Selection Addressing, Sequence/Response Diagram**

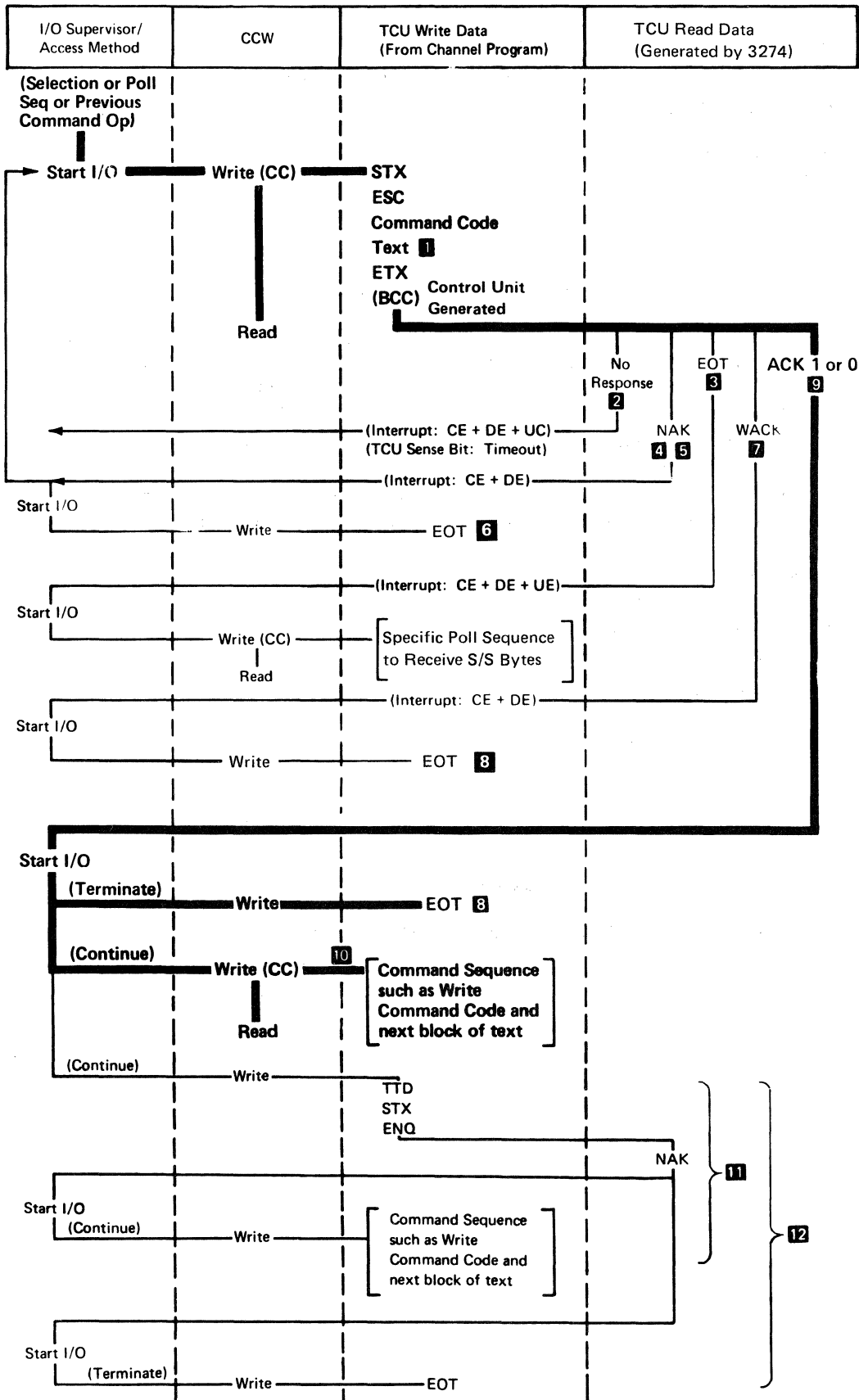

Figure 5-18 (Part 1 of 2). Write-Type and Control-Type Commands, Sequence/Response Diagram

**Notes:**

- 1** No text is transmitted on an EAU command transmission.
- 2** Command transmission was not successfully received because of invalid framing (STX missing). Causes a timeout at TCU.
- 3** 3274: The control unit is unable to perform the operation indicated in the command transmission because of a busy/unavailable/not ready device.
  - a. receipt of an illegal command/order sequence,
  - b. failure to decode a valid command,
  - c. an I/O interface "overrun",
  - d. a parity/cursor check,
  - e. an illegal buffer address, or
  - f. a locked buffer.

In the case of the Copy command: the "from" device is busy or has locked buffer, or CCC is missing.

The EOT response to a command transmission indicates that status information is stored in the control unit. To ensure retrieval of valid status, the program must issue a Specific Poll (addressing the device that was selected when EOT was generated) as the next addressing sequence to this control unit. Successful completion of a Specific Poll addressed to the responding device, a device selection addressed to any other device on the same control unit, or a General Poll addressed to the same control unit, is required to restart the internal control unit device polling operation.

- 4** 3274: If a transmission problem causes both a 3274 detected check condition and a BCC error, the BCC error takes precedence over all other check conditions, and a NAK is transmitted to the TCU.
- 5** 3274: BCC error or missing ETX has been detected. The NAK response requests the program to repeat its last transmission.
- 6** Response issued by the program to terminate the operation if the 3274 is unsuccessful in receiving a valid BCC following "n" attempts by the program to transmit the message.
- 7** If the Start Printer bit is set in the WCC or CCC, a WACK response indicates that the text transmission was successfully received, but that the printer is now busy and an additional chained command cannot be accepted.

If any of the conditions cited in Note 3 prevail, the EOT response takes precedence over the WACK response.
- 8** Normal termination of the operation by the program.
- 9** Command execution has been successfully completed.
- 10** Repeat the operation shown in this figure for the next command sequence.
- 11** Example of a Temporary Text Delay (TTD) sequence.
- 12** Example of terminating an operation using TTD (a forward abort sequence).

**Legend:**

(CC) = Chain Command (CC) Flag in CCW is set to 1.

(Interrupt) = TCU-generated interruption (CE = Channel End, DE = Device End, UE = Unit Exception, UC = Unit Check).

**Figure 5-18 (Part 2 of 2). Write-Type and Control-Type Commands, Sequence/Response Diagram**

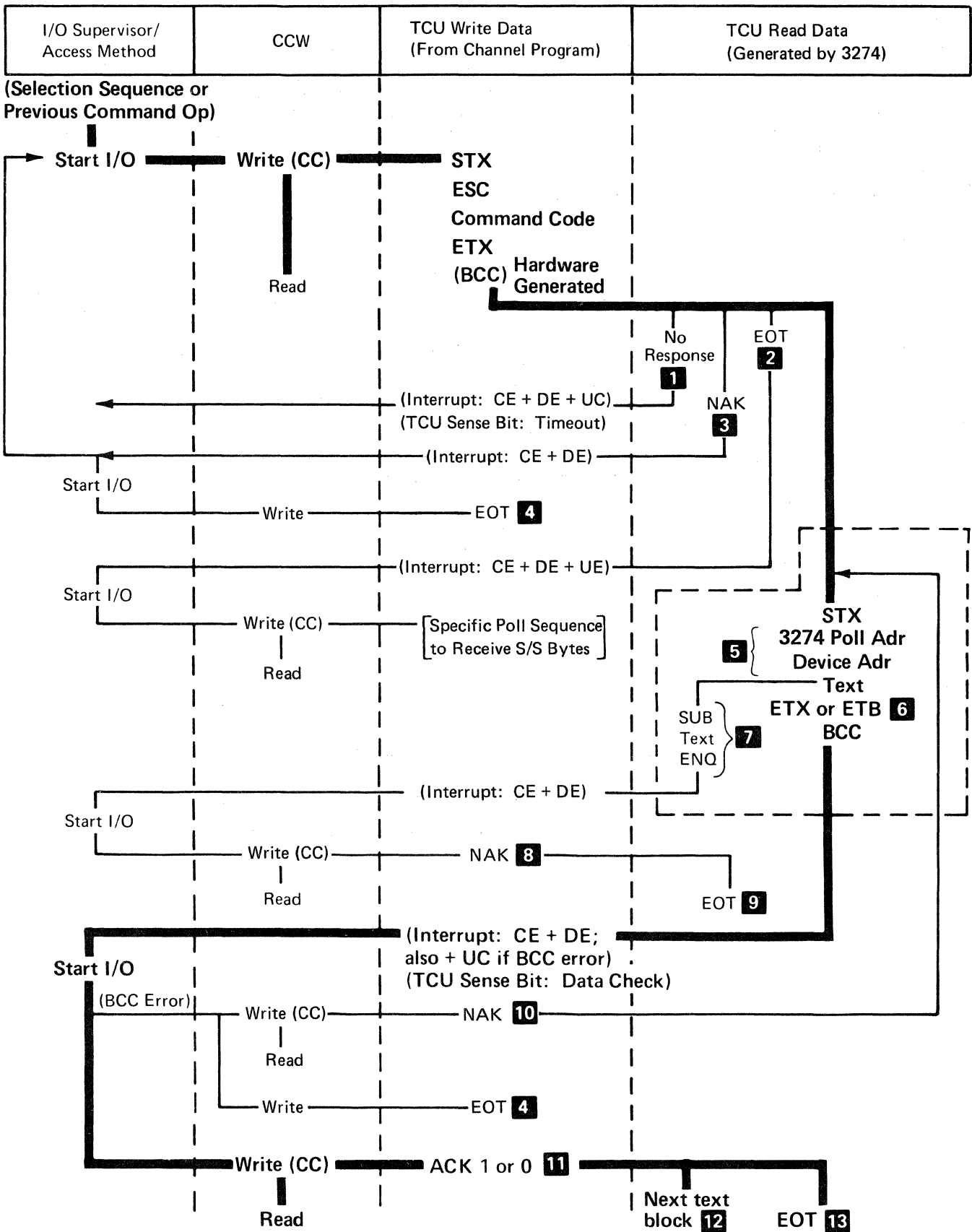

Figure 5-19 (Part 1 of 2). Read-Type Command, Sequence/Response Diagram

**Notes:**

- 1** Command transmission was not successfully received because of invalid framing (STX missing). Causes timeout at TCU.
- 2** 3274: The 3274 is unable to perform the operation indicated in the command transmission because of a busy/unavailable/not ready device or a 3274-detected check condition (receipt of an illegal command/order sequence, failure to decode a valid command, or an I/O interface "overrun"). The EOT response to a command transmission indicates that status information is stored in the 3274. To ensure a retrieval of valid status, a Specific Poll must be issued to the device-responding EOT as the next addressing sequence issued to this 3274.
- 3** 3274: If a transmission problem causes both a 3274-detected check condition and a BCC error, the BCC error takes precedence over all other check conditions, and a NAK is transmitted to the TCU.
- 4** Response issued by the program to terminate the operation if the 3274 is unsuccessful in receiving a valid BCC following "n" attempts by the program to transmit the message.
- 5** This address sequence is included only in the first block of a blocked text message.
- 6** ETB is used to frame each block of a blocked text message, except for the last block. ETX is used to frame the last block of a blocked text message.
- 7** Upon detection of an internal parity check, the 3274 automatically substitutes the SUB character for the character in error. If a parity or cursor check is detected, ENQ is transmitted in place of ETX (or ETB) and BCC at the end of the text block and appropriate status and sense information is stored. This is used by the 3274 after transmitting the first block, the transmission cannot be completed because of power's being off at the terminal.
- 8** Mandatory program response to a text block terminated in ENQ.
- 9** Response to terminate the operation. The nature of the error (parity or cursor check) does not warrant a retry. This response indicates that appropriate status and sense information is stored. Retrieval information included in Note 2 applies.
- 10** BCC error has been detected. The program issues NAK to cause the 3274 to repeat its last transmission.
- 11** Positive acknowledgment. The text block has been successfully received by the TCU. The program issues ACK 1 in response to the first and all odd-numbered text blocks and issues ACK 0 in response to the second and all even-numbered text blocks. This response to a text block terminated in ETX turns on the device SYSTEM AVAILABLE indicator.
- 12** The second and all succeeding text blocks are framed as the first except that they do not include the 3274/device address sequence.
- 13** Normal termination of the operation following transmission of the last text block.

**LEGEND:**

(CC) = Chain Command (CC) Flag in CCW is set to 1.

(Interrupt) = TCU-generated interrupt (CE = Channel End, DE = Device End, UE = Unit Exception, UC = Unit Check).

**Figure 5-19 (Part 2 of 2). Read-Type Command, Sequence/Response Diagram**

## **5.7 REMOTE STATUS AND SENSE BYTE DEFINITIONS, BSC**

Figures 5-20 through 5-22 provide status and sense byte definitions, responses, conditions, and error recovery procedures for the 3274 Models 51C, 52C, and 61C.

Bit No.	Bit Definition
	S/S Byte 0:
0	Dependent upon setting of bits 2-7.
1	Always a 1.
2	Reserved.
3	Reserved.
4	<p><b>Device Busy (DB)</b> – This bit indicates that the addressed device (except the 3278) is busy executing an operation or that a busy detection was previously made by a command or Specific Poll. The device is busy when it is executing an Erase All Unprotected command or a print operation, accepting data from the Operator Identification Card Reader, or performing various keyboard operations (Erase Input, Backtab, and Clear).</p> <p>This bit is set with Operation Check when a Copy command is received which specifies a “busy” device with its “from” address.</p> <p>This bit is set with Unit Specify when a command is addressed to a busy device. This can occur by chaining a command to a Write, Erase/Write, Erase/Write Alternate, or Copy command which started a Printer or by chaining a command to a Specific Poll addressed to a busy device.</p> <p><b>Note:</b> DB is not returned for the 3278 when executing an Erase All Unprotected command, accepting data from the MSR, or performing Erase Input, Backtab, or Clear keyboard operations.</p>
5	<p><b>Unit Specify (US)</b> – This bit is set if any S/S bit is set as a result of a device-detected error or if a command is addressed to a busy device.</p>
6	<p><b>Device End (DE)</b> – This bit indicates that the addressed device has changed from unavailable to available and not ready to ready, or busy to not busy. This bit is included during a Specific or General Poll but is not considered pending status by a Selection Addressing sequence.</p> <p>If a Selection Addressing sequence detects that the addressed device has pending status and also detects one of the above status changes that warrants a Device End, then the Device End bit is set and preserved along with the other pending status, and an RVI response is made.</p>
7	Reserved
	S/S Byte 1:
0	Dependent upon setting of bits 2-7.
1	Always a 1.
2	<p><b>Command Reject (CR)</b> – This bit is set upon receipt of an invalid 3270 command.</p>
3	<p><b>Intervention Required (IR)</b> – This bit is set if:</p> <ul style="list-style-type: none"> <li>● A Copy command contains a “from” address in its data stream which specifies an unavailable device.</li> <li>● A command attempted to start a printer but found it not ready. The printout is suppressed.</li> <li>● The 3274 receives a Selection Addressing sequence or a Specific Poll sequence for a device which is unavailable or which became not ready during a printout. A General Poll sequence does not respond to the unavailable/not ready indication and proceeds to determine the state of the next device.</li> <li>● The 3274 receives a command for a device which has been logged as unavailable or not ready.</li> </ul>
4	<p><b>Equipment Check (EC)</b> – This bit indicates a printer character generator or sync check error occurred, the printer became mechanically disabled, or a 3274 detected bad parity from the device.</p>
5	<p><b>Data Check (DC)</b> – This bit indicates the detection of a parity check in a device buffer or a 3274 operation to a device was unsuccessful (i.e., the device was disabled with DC returned to the host. IR will be returned on subsequent retry by the host).</p>
6	Reserved
7	<p><b>Operation Check (OC)</b> – This bit, when set alone, indicates one of the following:</p> <ul style="list-style-type: none"> <li>● Receipt of an illegal buffer address or of an incomplete order sequence on a Write, Erase/Write, or Erase/Write Alternate command.</li> <li>● The device did not receive a CCC or a “from” address on a Copy command.</li> <li>● Receipt of an invalid command sequence. (ESC is not received in the second data character position of the sequence.)</li> <li>● The internal buffering capability is exceeded on a 3274. This bit is set with Unit Specify to indicate that the “from” address on a Copy command specified a device with a “locked” buffer (the device data is secure).</li> </ul>

Figure 5-20. Remote Status and Sense Byte Definitions, BSC

Device Response	Command	S/S Explanation
RVI	Selection	<p>Outstanding Status – Pending information from a previous operation with the same device. (If the addressed device is busy, WACK is sent to the TCU instead of RVI, and no S/S bit is set.) <b>Note:</b> A Selection Addressing sequence does not recognize a Device End as pending status. If there is no other pending status, it resets this bit and proceeds with the selection. If the addressed device has other pending status. Device End remains set with it, and the RVI response is made as usual.</p> <p>CC is not used for the 3274.</p> <p>IR – The addressed device is unavailable.</p> <p>DC, EC (either or both) – Not used for the 3274.</p> <p>DE, EC, US – A character generator or syn check error has occurred, or the printer was mechanically disabled but the condition has been corrected. DE, EC, US is not sent by the 3287 or 3289.</p> <p>DE, IR – The addressed printer is out of paper, its power has been turned off, or its cover is open.</p> <p>DE, IR, EC, US – The addressed printer is mechanically disabled and cannot recover.</p> <p>DE, DC, US – A parity error is detected at the printer.</p> <p>DC, US – An operation to a terminal was unsuccessful. The terminal was disabled and DC US returned to the host. On subsequent retry by the host, IR will be returned to the host.</p>
EOT	Read Commands	<p>CR – Invalid 3270 command is received.</p> <p>OC – Invalid command sequence (ESC is not in the second data character position), or data follows the command in the data stream received at the device.</p> <p>DB, US – The addressed device is busy. The command was chained to a Write, Erase/Write, Erase/Write Alternate, or Copy command which started a print, or it was chained to a Specific Poll.</p> <p>DB, US, DE – Not used for the 3274.</p> <p>IR – A command is addressed to an unavailable device.</p> <p>DC – The 3274 is unable to complete a Read command operation after the first block has been sent to the host, because either there was an error in the terminal or the terminal was powered off after the first block was sent. A SUB character and an ENQ character are placed in the buffer. When the TCU responds NAK, the 3274 responds EOT.</p> <p>DC, US – For a 3274, an operation to a terminal was unsuccessful. The terminal was disabled and DC US returned to the host. On subsequent retry by the host, IR will be returned to the host.</p>
EOT	Write Commands	<p>CR – An invalid or illegal 3270 command is received.</p> <p>OC – An invalid command sequence (ESC is not in the second data position), an illegal buffer address or an incomplete order sequence is received, or a data byte was sent to the device during the Write command before the operation required by the previous data byte was completed.</p> <p>(Not used for the 3274 or 3276.)</p> <p>DC, US – An operation to a terminal was unsuccessful. The terminal was disabled and DC US returned to the host. On subsequent retry by the host, IR will be returned to the host.</p> <p>CC – (Not used for the 3274.)</p> <p>DB, US – The addressed device is busy. The message is accepted but not stored in the 3274 buffer. The command is aborted.</p> <p>DE, DB, US – Not used for the 3274.</p>
EOT	Copy Command	<p>CC, OC – Not used for the 3274.</p> <p>DB, OC – The "from" device is busy. (The device is busy executing an operation, a printout, reading data from the Operator Identification Card Reader, or performing a keyboard operation.) The Copy command is aborted.</p> <p>IR, OC – The "from" device is not available.</p> <p>OC, US – The "from" device has a locked buffer.</p> <p>OC – The data stream contains other than two bytes (the CCC and the "from" address). The command is aborted.</p> <p>OC – The "from" device buffer is larger than the "to" device buffer.</p> <p>OC – The buffer of the "from" device (has APL Text Feature) contains APL text characters (entered since an Erase/Write or Erase/Write alternate command or a Clear key operation) and the "to" device does not have the APL text feature.</p>

Figure 5-21 (Part 1 of 2). Remote Error Status and Sense Responses, BSC



Device Response	Command	S/S Explanation
EOT	Copy Command	<p>OC – The buffer of the “from” device (has APL Text Feature) contains APL text characters (entered since an Erase/Write or Erase/Write alternate command or a Clear key operation) and the “to” device does not have the APL text feature.</p> <p>DC, OC, US – Set when “from” device detects an internal parity or cursor check. An operation to a terminal was unsuccessful. The terminal was disabled and DC US returned to the host. On subsequent retry by the host, IR will be returned to the host.</p> <p>DB, US – The addressed “to” device is busy.</p> <p>DB, US, OC – The addressed “to” device is also specified at the “from” device and is busy.</p> <p>DB, US, OC, DE – The addressed device becomes not busy before a specific poll is issued to retrieve the DB, US, OC status (described above).</p>
EOT	Write, Erase/Write, Erase/Write Alternate, Copy Commands	<p>IR – Addressed device is not available, or addressed printer is not ready.</p>
EOT	Erase All Unprotected Command  Specific and General Poll	<p>OC – One or more data bytes followed the command (buffer overrun).</p> <p>DE, IR, EC, US – An unrecoverable mechanical failure is detected at the printer.</p> <p>DE, EC, US – A character generator or sync check error or a mechanical failure is detected at a 3284/3286/3288 printer but then recovered from.</p> <p>DC, US – An operation to a terminal was unsuccessful. The terminal was disabled and DC US returned to the host. On subsequent retry by the host, IR will be returned to the host.</p> <p>DC – The 3274 is unable to complete a Read command operation after the first block has been sent to the host, because either there was an error in the terminal or the terminal was powered off after the first block was sent. A SUB character and an ENQ character are placed in the buffer. When the TCU responds NAK, the 3274 responds EOT.</p> <p>DE – The poll finds a device (1), previously recorded as busy, now not busy or, (2) previously recorded as unavailable <i>or</i> not ready, now available <i>and</i> ready.</p> <p>IR, DE – The poll finds a device, previously recorded as ready, available, and busy, now not ready and not busy, or the printer went not ready during a printout.</p> <p>DC, US, DE – A parity error is detected at printer.</p>
	Specific Poll	<p>DB – The addressed device is busy.</p>
NAK	Read and Write Commands	<p>NAK is transmitted by the 3274 when it detects a Block Control Character (BCC) error on the TCU transmission. A BCC error has priority over all other detectable error conditions. If, for example, a BCC error and a parity error are detected during the same command transmission, the parity error condition is reset, and a NAK response is set by the 3274.</p>

Figure 5-21 (Part 2 of 2). Remote Error Status and Sense Responses, BSC

Sense/ Status Bits	Detected during 3270 Operation						Transmitted in Response to:		Error Recovery Procedure
	Hex		Selection Addressing Sequence	Specific Poll Sequence	General Poll Sequence	A 3270 Command	Specific Poll	General Poll	3274
	EBCDIC	ASCII							
CR	40 60	20 2D				D, P	D, P		6
OC	40 C1	20 41				D, P	D, P		6
OC, US	C4 C1	44 41				D, P	D, P		12
IR	40 50	20 26	D, P	D, P		D, P	D, P		4
IR, OC	40 D1	20 4A				D, P	D, P		5
DC	40 C4	20 44	D, P	D, P	D, P	D, P	D, P	D, P	1
DC, US	C4 C4	44 44	D, P	D, P	D, P	D, P	D, P	D, P	2
DC, OC, US	C4 C5	44 45				D, P	D, P		3
DC, US, DE	C6 C4	46 44		P	P		P	P	8
IR, DE	C2 50	42 26		P	P		P	P	4
EC, US, DE	C6 C8	46 48		P	P		P	P	7†
IR, EC, US, DE	C6 D8	46 51		P	P		P	P	7
DB	C8 40	48 20	D, P	D, P			D, P		9
DB, US*	4C 40	3C 20				D, P	D, P		10
OC, DB*	C8 C1	48 41				D, P	D, P		11
DE	C2 40	42 20		D, P	D, P		D, P	D, P	None

**Note:** The attached device errors that are detected asynchronously do not cause a Sense bit to set until the device is polled for status during a Selection Addressing, Specific Poll, or General Poll sequence. Those error S/S bit combinations that contain DE were detected during a printout.

\*The DB, US, and OC S/S bits will be combined if a Copy command is addressed to a busy "to" device and the command also specifies the "from" device the same as the "to" device.

†Occurs only if 3284, 3286, 3288 Printers are attached.

**Legend:**

D — Display (Category A or B)

P — Printer

**Figure 5-22. Remote 3270 BSC Status and Sense Conditions**

**5.7.1 Error Recovery Procedures**

1. Execute a new address selection addressing sequence and retransmit the message, starting with the command sequence that was being executed when the error occurred. If, after two retries, the operation is not successful, this should be considered as a nonrecoverable error. Follow supplementary procedure B after two retries.
2. Reconstruct the entire device buffer if possible, and retry the failing chain of commands (within the BSC sequence of operations). The sequence of commands used to reconstruct the buffer should start with an Erase/Write or Erase/Write Alternate command. If the information in the screen buffer is such that it cannot, or need not, be reconstructed, the operation may still be retried. If an unrecoverable Category A display buffer error is detected, the entire buffer is cleared and the host system is informed of the error by receiving DC, US status but is not informed of the clear operation. If, after three retries, the operation is not successful, this should be considered as a nonrecoverable error. Follow supplementary procedure A.

**Programming Note:** A cursor check in the 3284 is indistinguishable from a second selection to a 3277 with a cursor check. A selection addressing sequence or poll sequence to another device on the same control unit should be attempted before flagging the control unit as inoperative. A successful sequence indicates that the CU is probably satisfactory, and the device requires manual intervention to reset it (for example, a 3277 with a nonrecoverable data check). An unsuccessful sequence indicates that the CU may be at fault and requires manual intervention to reset it.

3. The error occurred during execution of a Copy command. Execute procedure 2, except that it is the buffer of the "from" device specified by the Copy command that should be reconstructed. After three retries, follow supplementary procedure B.
4. The error indicates that the printer is out of paper, has its cover open, or has a disabled print mechanism; or it indicates that the device is unavailable. Request (or wait for) either the display or system operator to ready the device. Then, retry the printout by issuing a Write command with the proper WCC and no data stream. (There is no data error, and the data is still intact in the device buffer and can be reused.) Or, follow procedure 2.

5. The error indicates that the "from" device specified by a Copy command is unavailable. Note that the device address associated with the error status and sense information does not indicate the device that actually required "readying." The device that requires the corrective action is the device specified by the "from" address in the Copy command. When the device is determined and made "ready," follow procedure 1.
  6. The operation should be tried up to six times. Continued failure implies an application programming problem, which can be detected by analyzing the failing write data stream.
  7. The error occurred during a printout operation and indicates either a character-generator error or a disabled print mechanism. There is no data error. The proper error recovery procedure is application-dependent since the user may or may not want a new printout. If a new printout is required, follow procedure 4.
  8. A data error occurred in the device buffer during a printout, and procedure 2 should be followed.
  9. A Specific Poll detected that the addressed device is busy. Periodically issue a Specific Poll to pick up the Device End sense/status bit sent by the device when it becomes not-ready (unless this status change is detected on a selection addressing sequence).
  10. Indicates that a command was erroneously addressed to a busy device. Periodically issue a General or Specific Poll to pick up the Device End sense/status bit sent by the device when it becomes not busy. Then follow procedure 1.
  11. Indicates that, in attempting to execute a Copy command, the "from" device was found to be busy. Follow procedure 1 when the "from" device becomes not busy. Note that the device address associated with the status and sense message is the address of the "to" device and not that of the busy "from" device. The "from" device will transmit Device End via a Specific or General Poll when it becomes not busy.
  12. An attempt was made to execute a Copy command, but access to the "from" device data was not authorized. The device address associated with the error sense/status bits is that of the Copy "to" device.
- B. The "from" device specified by the Copy command in the failing chain of commands (CCWs) is malfunctioning. The "from" device should be determined from the data-stream information, and maintenance should be requested for the device. After the repair, reconstruct the buffer image. The sequence of commands used to reconstruct this image should start with an Erase/Write command. Retry the failing chain of commands according to the procedure that referred you to this supplementary procedure.
  - C. Same as procedure 1, except a new selection addressing sequence is not performed, and this message is transmitted as part of the present device selection.
  - D. Same as procedure 1, except retransmit the entire failing chain of commands.

## 5.8 SDLC SEQUENCE RESPONSE DESCRIPTIONS

### 5.8.1 SLDC Transmission Frames

SDLC transmission frames are composed of a series of eight-bit binary-coded bytes which contain addressing, data, control, and checking information. Transmission between the controller and the 3274 unit takes place according to a predefined frame format which consists of the following sequence of bytes:

- Flag (F) Sequence — 1 byte
- Secondary Station Address (A) — 1 byte
- Control (C) Field — 1 byte
- Information (I) Field — up to 256 bytes of message data, preceded by header information
- Frame Check Sequence (FCS) — 2 bytes
- Flag (F) Sequence — 1 byte

Bit synchronization preceding transmission of an initial flag and following a line turnaround is achieved by transmission of 16 zero bits, after the clear-to-send signal is turned on and the NRZI encoder (when used) is enabled.

For a detailed description of the SDLC frame format, refer to *IBM Synchronous Data Link Control General Information*, GA27-3093. Support of the frame sequence, flag byte, Address byte, and Frame Check Sequence bytes conforms to the referenced document.

#### 5.8.1.1 Response Modes

The 3274 unit functions in two link operating modes: normal response mode (NRM) and normal disconnect mode (NDM). In NRM, the 3274 can initiate transmission and raise the request-to-send signal only as a result

### 5.7.2 Supplementary Procedures

- A. Request maintenance for the device that is giving trouble. After repair, reconstruct the screen buffer image. The sequence of commands used to reconstruct this image should start with an Erase/Write command. Retry the failing chain of commands according to the procedure that referred you to this supplementary procedure.

of receiving a frame from the communications controller which contains the P bit set to 1. Single or multiple frames may be sent by the 3274. The last frame (or a single frame) transmitted by the 3274 in response to a command received with the P bit set to 1 must have the F bit set to 1. When the 3274 has completed a transmission, a new transmission cannot be initiated until a subsequent frame is received from the communications controller which contains the P bit set to 1. A response transmission initiated by the 3274 which requires acknowledgment from the communications controller, is repeated each time the communications controller polls until the acknowledgment is received. There is no limit to the number of transmissions. Responses that require acknowledgment from the communications controller are I-frames, CMDR and RR when transmitted with the F bit set to 0, to report clearing of a busy condition.

When in NDM, the 3274 cannot accept or transmit I or supervisory (S) frames. Nonsequenced responses are not transmitted unless the 3274 is solicited to reply. Invalid or nonimplemented commands received in NDM cause the 3274 to transmit an ROL response at the next response opportunity. ROL can be retransmitted until an SNRM or DISC command is received. Command reject conditions are not present in NDM.

The following paragraphs describe the 3274 port of the Control and Information fields.

### 5.8.1.2 Control Field

The Control field designates the frames as Supervisory (S), Nonsequenced (NS), or Information (I).

**Supervisory Commands:** The 3274 supports only the Supervisory commands Receive Ready (RR) and Receive Not Ready (RNR).

The C-field formats are as follows:

RR	Nr	P/F	00	01
	012	3	45	67
RNR	Nr	P/F	00	01
	012	3	45	67

The 3274 will transmit RNR when the control unit cannot accept further data from the link.

When the reported RNR condition is cleared, the control unit will transmit an I-frame or RR with the F bit on after a frame with the P bit on is received.

If the 3274 has received an RNR, an I-frame will not be transmitted until an RR or I-frame with the poll bit on is received.

The transmission or receipt of an NS frame does not indicate the RNR condition has cleared.

**Nonsequenced Commands and Responses:** The Nonsequenced commands and responses listed in Figure 5-23 are supported by the 3274.

Command/Response	C-Field	Hex Code
Set Normal Response Mode (SNRM) Command	1 0 0 P 0 0 1 1 0 1 2 3 4 5 6 7	93
Disconnect (DISC) Command	0 1 0 P 0 0 1 1 0 1 2 3 4 5 6 7	53
Nonsequenced Acknowledgment (NSA) Response	0 1 1 F 0 0 1 1 0 1 2 3 4 5 6 7	73
Request Online (ROL) Response	0 0 0 F 1 1 1 1 0 1 2 3 4 5 6 7	1F
Command Reject (CMDR) Response	1 0 0 F 0 1 1 1 0 1 2 3 4 5 6 7	97
Test Command/Response	1 1 1 P/F 0 0 1 1 0 1 2 3 4 5 6 7	F3
Exchange Station ID Command/Response	1 0 1 P/F 1 1 1 1 0 1 2 3 4 5 6 7	

**Figure 5-23. Nonsequenced Commands and Responses Supported by 3274**

The SNRM command sets the 3274 in NRM. Receipt of SNRM causes the 3274 to deactivate the physical unit if it is in active state. The On-Line and Ownership symbols are turned off.

The DISC command sets the 3274 in NDM.

The NSA response is sent by the 3274 to acknowledge receipt and acceptance of the SNRM and DISC commands.

The Test command is used to initiate one round-trip transmission of test data in both NRM and NDM. The 3274 station will return the Test response without data if buffering is not available to hold the complete test data, or with data if buffering is available.

The Request on Line (ROL) response is sent by the 3274 in normal disconnect mode (NDM) to request online status. ROL is sent in response to any command except Test and XID. ROL is sent in response to the SNRM command when the 3274 cannot enter NRM.

The CMDR response is implemented by the 3274 as described in GA27-3093. The CMDR will be sent in response to any poll until an SNRM or DISC is received to reset the control unit.

The Exchange Station Identification (XID) command and response contains additional data beyond the C byte. The 3274 responds to the XID command in NRM or NDM, except when a CMDR condition exists, in which case the CMDR response takes precedence over XID. The request/response unit (RU) of the XID response consists of 48 bits, defined as follows:

Bits	Meaning
0–3	ID format B "0000"
4–7	PU type B "0010"
8–15	Self-description X "00"
16–27	X'017' (3274)
28–47	ID number

**Information (I) Frame:** The Information frame is used to transmit message data. When transmitted, the I-frame contains a maximum of 256 bytes of RU message data preceded by six bytes of transmission header (RH).

### 5.8.2 Sequence Error Recovery Procedures

A sequence error occurs when the 3274 receives an I-frame with an incorrect Ns sequence count and valid FCS bytes. The 3274 does not accept the I-frame that caused the sequence error and rejects all following I-frames, until an I-frame is received which contains the correct Ns value, at which time the sequence error condition is reset.

The 3274 transmits I-frames in the sequence indicated by the last Nr count received, which may include retransmission of previously transmitted I-frames that have not been acknowledged.

All I-frames are transmitted in contiguous sequence according to the Ns value within the constraints of the modulo count.

#### 5.8.2.1 Abort Function

The abort function is used by the communications controller or by 3274 when a frame being transmitted is to be discarded. The abort function is performed by transmitting eight contiguous one bits without zero insertion at the earliest possible time following recognition of an abort situation. No FCS is transmitted. When, for example, the 3274 receives seven contiguous one bits, it discards the aborted frame. The 3274 employs the abort function when an equipment malfunction occurs that causes an erroneous transmission.

### 5.8.2.2 Timeout Control

When the 3274 is attached point-to-point or multipoint and does not recognize any valid outbound frame for 20 to 25 seconds, a nonproductive timeout occurs. This timeout causes the 3274 to set the Communication Check symbol on all attached Category A displays. The timer is reset to zero every time the 3274 detects a valid outbound frame. The Communication Check symbol is turned off when a valid frame is received by the station.

If a condition of no line activity is detected by the 3274 for 20 to 25 seconds, the Communication Check symbol is set on all attached Category A displays. The indicator will be turned off when a valid frame is received.

### 5.8.3 Hexadecimal Notation and Frame Summary

Figure 5-24 shows the hexadecimal notation for SDLC commands and responses.

<i>Nonsequenced Commands</i>			<i>Legend</i>		
	P	$\bar{P}$	<i>Hexadecimal digit for "--"</i>		
SNRM	'93'	'83'	Nr=	P/F	$\bar{P}/\bar{F}$
DISC	'53'	'43'	0	1	0
SIM	'17'	'07'	1	3	2
NSI	'13'	'03'	2	5	4
NSP	'33'	'23'	3	7	6
XID	'BF'		4	9	8
TEST	'F3'	'E3'	5	B	A
			6	D	C
			7	F	E
<i>Nonsequenced Responses</i>			<i>Hexadecimal digit for "****"</i>		
	F	$\bar{F}$	Ns=	Hex	
NSA	'73'	'63'	0	0	
ROL	'1F'	'0F'	1	2	
CMDR	'97'	'87'	2	4	
RQI	'17'	'07'	3	6	
NSI	'13'	'03'	4	8	
XID	'BF'		5	A	
TEST	'F3'	'E3'	6	C	
			7	E	
<i>Supervisory Commands/Responses</i> (See Legend)					
RR	'_1'				
RNR	'_5'				
REJ	'_9'				
<i>Information Commands/Responses</i> (See Legend)					
I	'_*'				

**Figure 5-24. SDLC Commands and Responses in Hexadecimal Notation**

## 5.9 SNA INFORMATION

### 5.9.1 Session Control

Session Control (SC) requests are sent from the host to establish and maintain a session with 3274. Session Control also provides facilities to clear data flowing within a session after a catastrophic error occurs and then to resynchronize the data flow after such an error. All Session Control commands supported by 3274 are transmitted on the expedited flow. The specific SC function is identified by the first byte of the Request Unit (RU). The SC functions supported by 3274 are listed in Figure 5-25.

Function	BU Byte	Support
Activate Physical Unit (ACTPU)	X'11'	Outbound
Deactivate Physical Unit (DACTPU)	X'12'	Outbound
Activate Logical Unit (ACTLU)	X'0D'	Outbound
Deactivate Logical Unit (DACTLU)	X'0E'	Outbound
Bind	X'31'	Outbound
Unbind	X'32'	Outbound
Clear	X'A1'	Outbound
Start Data Traffic (SDT)	X'A0'	Outbound

Figure 5-25. Session Control Functions Supported by 3274

### 5.9.2 Data Flow Control

Data Flow Control (DFC) requests are passed between the application program and 3274 to provide control over session data flow. Data Flow Control functions are identified by the setting of the RU type bit to B'1' and the Sub-system Control bit to B'0'. The DFC requests listed in Figure 5-26 are supported by 3274.

Function	Flow	RU Byte	Support
Cancel	Normal	X'83'	Inbound/Outbound
Bid	Normal	X'C8'	Outbound
Chase	Normal	X'84'	Outbound
Signal	Expedited	X'C9'	Inbound/Outbound
SHUTD	Expedited	X'C0'	Outbound
SHUTC	Expedited	X'C1'	Inbound
LUSTAT	Normal	X'04'	Inbound
RTR	Normal	X'05'	Inbound
			(LU types 1, 3)

Figure 5-26. Data Flow Control Requests Supported by 3274

### 5.9.3 Transmission Header

The format of the transmission header is shown in Figure 5-27.

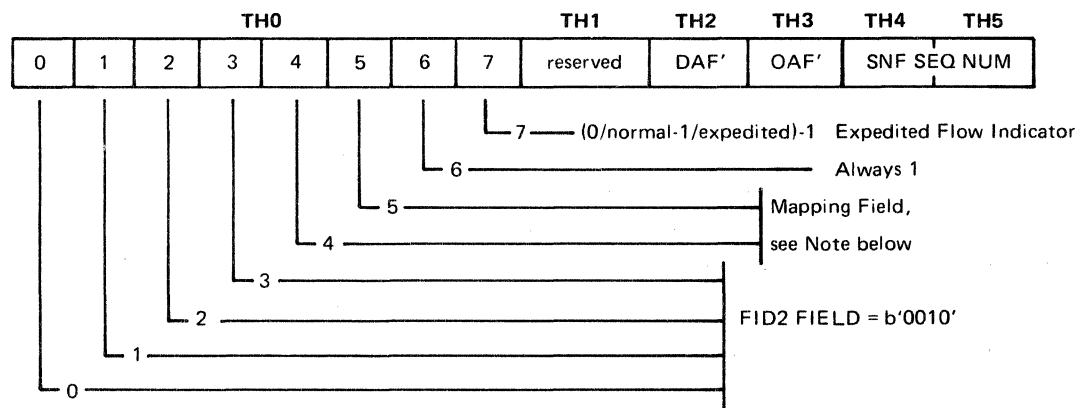

Note: Mapping Fields

Bits	4	5	
	0	0	Middle of segment
	0	1	Last of segment
	1	0	First of segment
	1	1	Whole segment

Figure 5-27. Transmission Header Format

### 5.9.4 Request/Response Header

The format of the request/response header is shown in Figure 5-28.

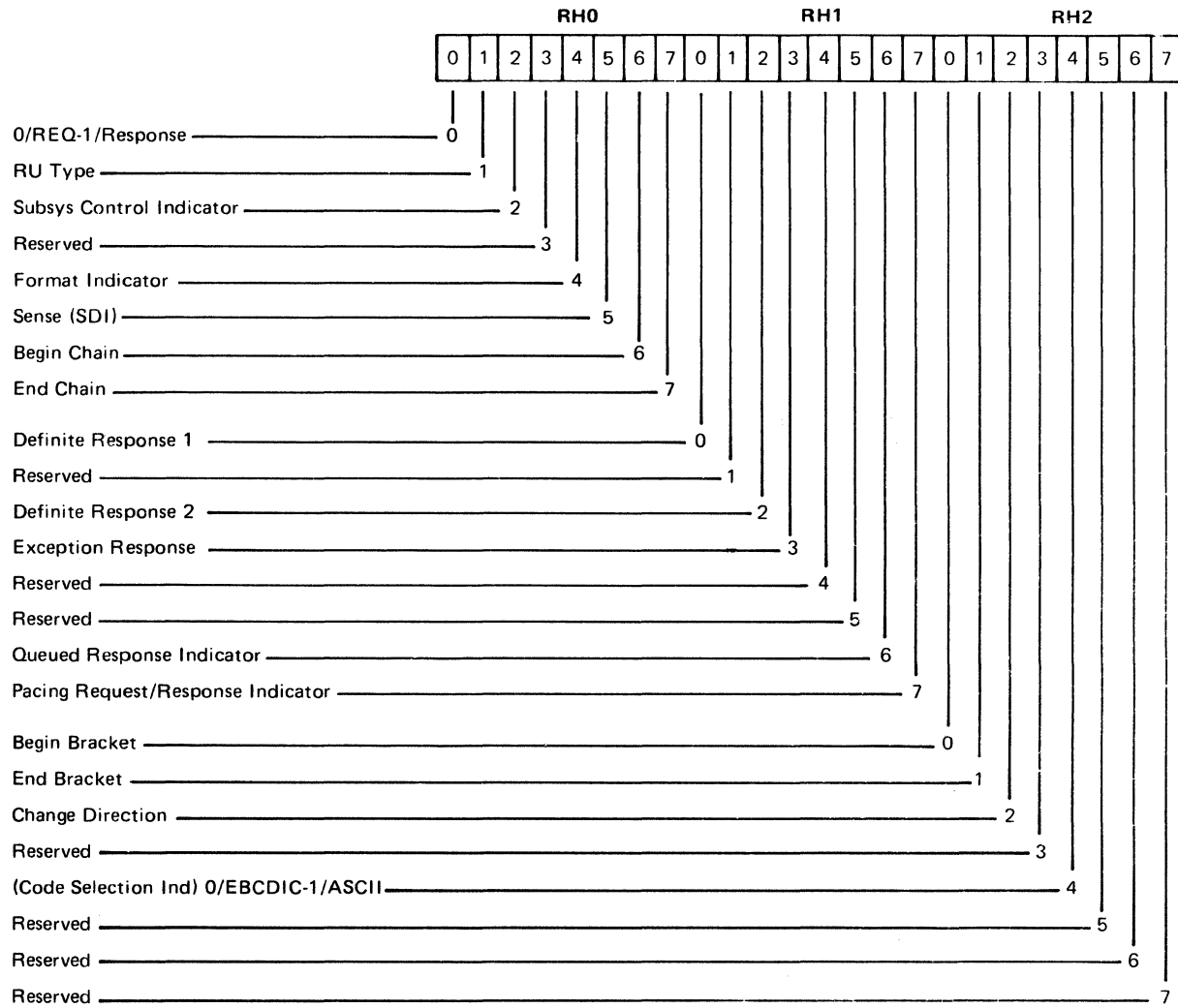

**Note:** *RU0 Bits 1 and 2 – RU Type/Subsystem Control Indicator*

- 1 1 Session Control*
- 1 0 Data Flow Control*
- 0 1 Network Control (not implemented)*
- 0 0 FM Data*

**Figure 5-28. Request/Response Header Format**

## 5.9.5 SNA Definitions

### 3274 – PU.T2

For all PIUs sent and received, the transmission header (TH) format is a FID2. (See Figure 5-27 for the layout for FID2 TH.)

### 3274 – FM Profile 3

Primary LU half-session and secondary LU half-session use delayed control mode and immediate-response mode. These half-sessions support the following DFC functions:

- Cancel
- Signal
- LUSTAT (allowed secondary to primary only)
- Chase
- SHUTD
- SHUTC
- RSHUTD
- Bid and RTR (allowed only if brackets are used)

The FM usage fields defining the options for Profile 3 are:

- Chaining use (primary and secondary)
- Request mode selection (primary and secondary)
- Chain response protocol (primary and secondary)
- Compression indicator (primary and secondary)
- Send EB indicator (primary and secondary)
- FM header usage

### Brackets

- Bracket termination rule
- Alternate Code Set Allowed indicator
- Normal-flow send/receive mode
- Recovery responsibility
- First speaker (for bracket protocol)
- Contention resolution

### 3274 – TS Profile 3

Profile 3 specifies the following session rules:

- Primary – secondary normal flow is paced.
- Sequence numbers are used on normal flows.
- Clear and SDT are required.
- RQR and STSN may be used.

### LU Types

- LU1 – Any Category A printer supporting SNA Character String (SCS) printer control.
- LU2 – Any Category A or B display type device.
- LU3 – Category A and B printers using 3270 data stream printer control [data-stream compatibility (DSC) mode].

## 5.9.6 SDLC/SNA Command to Start a Session

Figure 5-29 shows the SDLC/SNA commands required to initialize a session with LU1 (DAF of 2). Only the requests are shown, but the SDLC receive count has been updated whenever a line direction change occurs to account for a positive response from the secondary station.

It should be noted the requests/responses do not carry the SDLC poll/final bit. The lines, in all cases, are turned around by the RR (SDLC) cmd after every response/request.

	Frame	Address	Control	TH	RH	RU	BCC	Frame
SNRM	7E	C1	93				277A	7E
RR	7E	C1	11				3DDD	7E
ACTPU	7E	C1	00	2F0000000001	6B8000	110101050000000001	02B9	7E
RR	7E	C1	11				3DDD	7E
ACTLU	7E	C1	22	2F0002000001	6B8000	0D0101	126B	7E
RR	7E	C1	31				3FFC	7E
Bind	7E	C1	44	2F0002010001	6B8000	31010303B1A03080 0001858700000200 0000000018501850 02000006F3C5B2B3 C5D900	94FF	7E
RR	7E	C1	51				399F	7E
Clear	7E	C1	66	2F0002010002	6B8000	A1	C62E	7E
RR	7E	C1	71				3BBE	7E
SDT	7E	C1	88	2F0001010001	6B8000	A0		
RR	7E	C1	91				3559	7E

Figure 5-29. SDLC/SNA Commands Required to Start Session with LU1



## 5.10 SDLC/SNA ERROR INFORMATION

### 5.10.1 Exception Response with Sense Data Included

The exception responses for SDLC/SNA are shown in Figure 5-30.

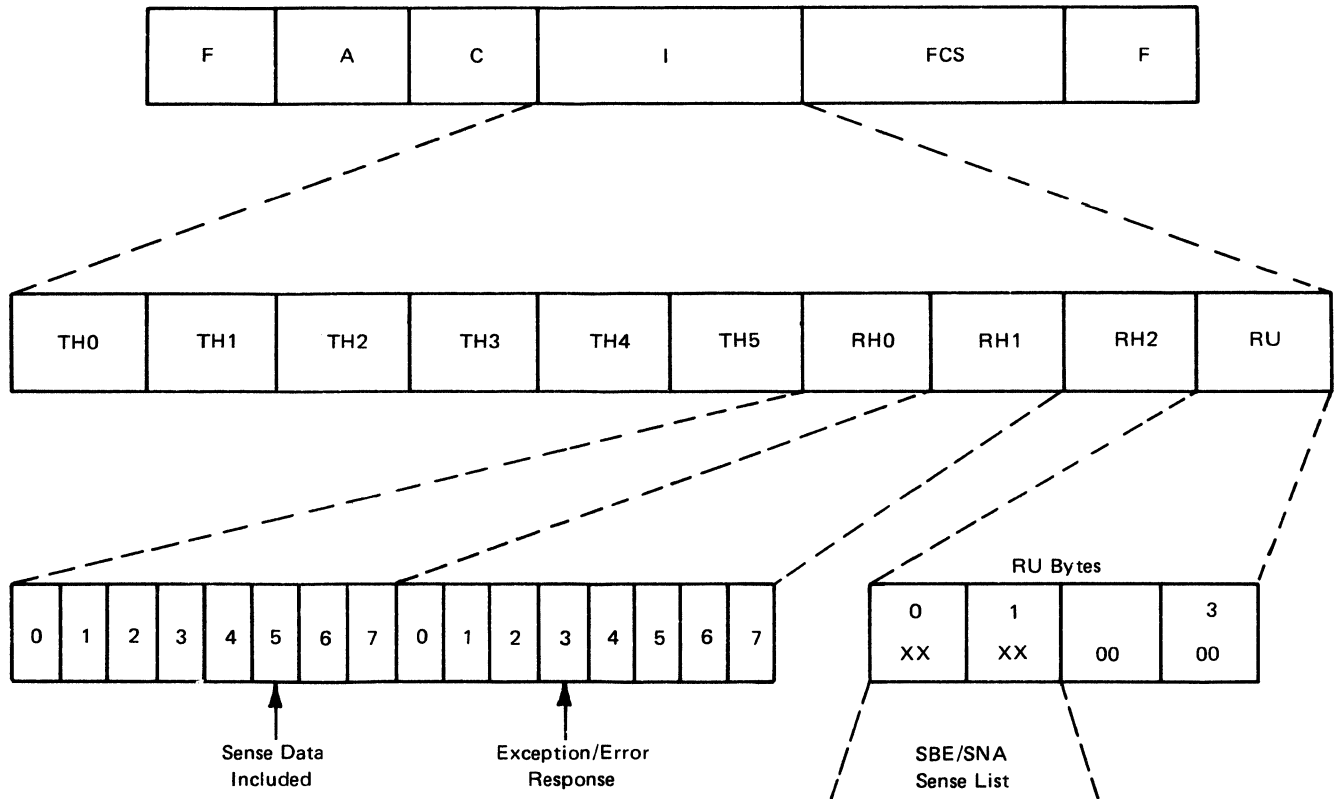

*Note: SDI and EXR/FRR bits are on for sense information.*

**Figure 5-30. SDLC/SNA Exception Responses**

## 5.10.2 SNA Sense Codes

Each major error code has modifiers for further description in sense byte 1. Following are the modifier codes supported and the controller or terminal condition causing the negative response to be returned.

### Sense

#### Byte

#### One Description

#### Path Error X'80'

X'04' Unrecognized DAF'  
Controller does not have a terminal adapter for the DAF address.

#### X'05' – NO SESSION

- A Bind has not been received or accepted by the 3274.
- A request other than Bind is sent to an SLU which has already accepted a Bind, and the OAF' is not X'00' or the OAF in the accepted Bind.

#### X'08' – PU NOT Active

The 3274 has not received or accepted an ACTPU, or a control condition caused an internally generated DACTPU.

#### X'09' – LU NOT Active

The 3274 has not received or accepted an ACTLU, or a control condition caused an internally generated DACTLU.

#### X'0F' – Invalid Address Combination

A request was addressed to the PU (DAF'=X'00'), and the OAF was not SSCP (OAF'=X'00').

#### RH Error X'40'

#### X'06' – Exception Response Not Allowed

LIC carried exception response when Bind specified definite response.

#### X'07' – Definite Response Not Allowed

LIC carried definite response when Bind specified exception response or LIC carried definite response.

#### X'0A' – No-Response Not Allowed

A chain element did not have DR1, DR2, or the exception bit set to 1.

#### X'0F' – Format Indicator Not Allowed

An FM request received by the 3274 indicated formatted header included.

#### State Error X'20'

#### X'01' – Sequence Number Error

The sequence number of the normal flow request did not match the number expected by the 3274.

#### X'02' – Chaining Error

Chain elements were out of protocol sequence.

#### X'03' – Bracket State Error

A Bracket state error occurred.

#### X'04' – Direction Error

A normal flow without begin bracket was received while the 3274 was in Send state.

#### X'05' – Data Traffic Reset

An FM or DC request was received before an SDT was received or accepted.

**Sense****Byte****One            Description****Request Error X'10'**

X'01' – WCC had start print set but was not last structured field.

X'03' – Function Not Supported.

- Unsupported Session Control Request
- Unsupported Data Flow Control Request
- SIGNAL Code is not X'00010000'
- Network Control Request
- FM Data Stream
- Invalid Command
  - Data Following a Read, RM, RMA, or EAU command
  - For LU type 3, and Read, RM or RMA command.

X'05' – Parameter Error

Invalid address following SBA, RA, or EUA order (SBA, RA, or EUA order without parameters), or SCS parameter error.

X'07' – Category Not Supported

- An FMD request from the SSCP was received by a SLU which has an attached device without a keyboard.
- An unsupported network service message received.

**Request Reject X'08'**

X'01' – Resource Not Available

- LU type 2, A printer is not allowed by the Authorization Matrix
- For LU type 1 or 3, Bind reject because printer is authorized for Local mode only.

X'02' – Intervention Required (on principal device).

- For LU type 2, security key is turned off.
- For LU type 1 or 3, printer condition such as end of form, paper jam, printer cover up, or hold time-out.

X'05' – Session Limit Exceeded

A Bind was received whose OAF' differs from the PLU already bound.

X'07' – Resource Not Available

Device unavailable for an indeterminate time; LUSTAT sent when available.

X'0A' – Permission Rejected

Display or printer power is off. The SSCP will not be notified when the device powers on.

X'11' – Break

Sent on LU type 1 when the operator depresses the printer Hold Print key followed by Cancel key, if a chain has not completed printing.

X'13' – Bracket Bid Reject – (No RTR)

Returned by LU type 2 to a BID or BID with Begin Bracket if the display has won contention and started a bracket.

X'14' – Bracket Bid Reject

Bid received while secondary device is in the in-bracket state.

X'15' – Function Active

Bind reject if the same OAF' already has an accepted Bind to the SLU.

X'1B' – Receiver in Transmit Mode

- The SLU is Between Bracket but a data key has been depressed.
- An FM message was received from the SSCP while the display was owned by the PLU-SLU session or is in Test mode.
- An SSCP FM message is rejected if local copy is taking place while the SSCP-SLU session owns the display.

X'1C' – Request Not Executable

The 3274 has a nonrecoverable error.

X'21' – Invalid Session Parameters

- Bind parameters do not match the 3274 Bind checks.

**Sense  
Byte  
One            Description**

- X'29' – Change Direction Required  
A 3270 read-type command was received without a Change Direction, or with an End Bracket.
- X'2A' – Presentation Space Altered, Request Executed  
An LU type 2 3277 attached to a 3274 has a reset keyboard, and tried to enter while in receive state.
- X'2B' – Presentation Space Integrity Lost
  - A temporary error has occurred; for example, parity check in device,
  - An operator has cleared the display by switching to SSCP-SLU session or Test mode and returned to PLU-SLU session.
- X'2D' – SLU Busy
  - LU type 2 Display is owned by SSCP-SLU session or Test mode.
  - LU type 2 Display is busy doing an operator-initiated local copy.
  - LU type 2 3277 attached to 3274 is busy with a Back Tab.
- X'2E' – Intervention Required at Subsidiary Device  
For LU type 2, a printer being copied to from a host-initiated print has intervention-required type error. Refer X'0802'. Printer power off or not attached to the controller is included in this category.
- X'2F' – Request Not Executable Because of LU Subsidiary Device  
For LU type 2, a printer being copied to has a nonrecoverable error.
- X'31' – LU Component Disconnected  
This response is returned if the device attached to the 3274 cannot be contacted by a device poll. This is due to device power off, cable detached from the controller port, or connecting cable broken.
- X'43' – Required Function Manager Synchronization Not Supplied  
For LU type 2 or 3 chains having the print bit on, must be definite response or exception response chain must carry CD.
- X'45' – Permission Rejected  
Bid cannot be accepted; the secondary LU will notify (LUSTAT) SSCP when bid can be accepted.
- X'4A' – Presentation Space Altered, Request Not Executed  
Refer to X'2A'.
- X'4C' – Permanent Insufficient Resource  
An error in processing a query request was detected.
- X'63' – LCID Missing  
Local Character Set Identifier was not found.

### 5.10.3 Logical Unit Status (LUSTAT)

LUSTAT provides a means for the SLU to report exception conditions or status when the SLU is not in Receive state (a negative response is used when the SLU is in Receive state). Following are the CD settings that accompany LUSTAT and the state changes, if any, that occur:

SLU State When LUSTAT Sent	CD Setting	State Change
BETB	CD may be set	None
ERP1	CD not set	None
Send	CD set for principal device	to Receive
	CD not set for subsidiary device	None

Inbound LUSTATs are sent with exception response by the 3274.

**Programming Note:** An LUSTAT showing power off sent while in Send state carries CD. An LUSTAT that shows power on cannot be sent until the PLU causes an SLU state change to (S, \*R).

The following status codes will be used by 3274 to send information to the PLU, on the PLU-SLU session.

Value	Explanation
X'0001Z000'*	Device now available; presentation space not destroyed.
X'00020000'	Device has received CD, but has no input mechanism.
X'081CZ000'*	Component Failure; Permanent Error.
X'082B0000'	Device available; presentation space integrity lost.
X'08310000'	Principal device is powered off or disconnected.
X'0801Z000'*	Printer has been removed from configured status.

\*Where Z specifies whether the status refers to the principal or subsidiary device. (Refer to "SNA Printer Sessions" for a description of principal and subsidiary devices.) The value of Z is defined as follows:

LU type 1 Principal (printer)	Z = 0
LU type 2 Principal (display)	Z = D
LU type 2 Subsidiary (printer)	Z = B
LU type 3 Principal (printer)	Z = 0

The priority of these status codes, in low to high order, is assigned as:

X'0002', X'0001', X'082B', X'0831', X'0801', X'081C'

The 3274 will send the highest level of priority status when an opportunity allows its transmission.

Definition: (S, \*R) = Send state, ERP1 state, or BETB state.

The upper section of Figure 5-31 shows the LUSTAT codes that are returned to clear the negative response condition listed in the left column. The lower section lists the LUSTAT codes that are used to report an SLU error condition instead of a negative response. The X's show the sessions that use the code points.

The usages of LUSTAT are as follows:

For all LU types, when the 3274 has sent -RSP with X'0802' or X'082E' and this condition is reset, LUSTAT with X'0001P000' will be sent: where the value P is X'0' for LU type 1 or 3, X'D' for LU type 2 principal (display), and X'B' for LU type 2 subsidiary device (printer).

#### LUSTAT Returned

Negative Response Code	LU TYPE			
	T1	T2	T3	SSCP
0802	00010000	0001D000	00010000	NA
	082B0000	082B0000	082B0000	
	081C0000	081CD000	081C0000	
	08310000	08310000	08310000	
0807	NA	0001B000	NA	NA
		0801B000		
		081CB000		
		081CD000		
082D	NA	0001D000	NA	NA
		082B0000		
		081CD000		
082E	NA	0001B000	NA	NA
		0801B000		
		081CB000		
		081CD000		
0831	082B0000	082B0000	082B0000	NA
	081C0000	081CD000	081C0000	NA

#### Sent By

LUSTAT	LU TYPE		
	T1	T2	T3
SEND			
BETB			
ERP.1			
00020000	X	X	X
081C0000	X		X
081CB000		X	
081CD000		X	
082B0000	X	X	X
08310000	X	X	X
0801B000		X	

Figure 5-31. Summary Table of LUSTATs

If the presentation integrity is lost while an X'0802' condition exists, LUSTAT with X'082B0000' will be sent instead of X'0001P000' when the X'0802' condition is reset.

For LU type 2, when the 3274 SLU has sent -RSP with Secondary component not available (X'0807') and this condition is reset, LUSTAT with X'0001B000' will be sent.

For all LU types supported, the LUSTAT X'00020000' will be sent when the 3274 accepts a Normal flow request carrying CD, but no input components (keyboard, light-pen, MSR, etc.) are attached to the device.

For all LU types, LUSTAT with X'082B0000' will be sent to the PLU when the 3274 SLU detects presentation integrity lost (for example, regeneration buffer parity error), and is in (S \*R) state for the 3274.

For LU type 2, when the 3274 has sent -RSP (Device Busy) (X'082D') to a PLU request because of session ownership change from PLU to SSCP or TEST, LUSTAT with X'082B0000' will be sent to the PLU when returning to PLU-SLU session.

For LU type 2, when the -RSP (Device Busy) (X'082D') has been returned from the 3274 for a Back Tab busy condition, the LUSTAT X'0001D000' component now available to the PLU will be sent when the busy condition clears.

For LU type 2, when 3274 has sent -RSP (Device Busy) (X'082D') to a PLU because the SLU is busy executing a local copy, the 3274 sends LUSTAT X'0001D000' component now available to the PLU when the busy condition clears.

For all LU types, if a principal device is powered off or unplugged from the controller port and a session exists which is in (S, \*R) state, LUSTAT X'08310000' will be sent to the PLU.

For all LU types, when a principal device has sent -RSP or LUSTAT X'08310000' and then power is restored, LUSTAT with X'082B0000' will be sent to the PLU.

For all LU types, if 3274 finds a permanent error in the principal device and is in (S, \*R) state, LUSTAT with X'081CP000' will be sent to the PLU. The value of P is the same as defined in item 1.

For LU type 2, if the 3274 finds a permanent error in the subsidiary device and is in (S, \*R) state, the worsening of the previous condition will not be reported. Instead, LUSTAT X'0001B000' will be sent, and the next outbound requests will be rejected with the proper sense code.

For LU type 2, if the 3274 finds the subsidiary device has been configured from Local or Shared mode to System mode, LUSTAT X'0001B000' will be sent if an LUSTAT is owed. The next outbound request will be rejected with the proper sense code.

**Note:** An LUSTAT showing power off during send state carries CD. An LUSTAT showing power on cannot be sent until the PLU causes an SLU state change to (S, \*R).

#### 5.10.4 Command Reject

The Command Reject (CMDR) response is sent by the 3274 control unit to report the following error conditions:

1. Receipt of a command code with valid BCC but which is an invalid command or a command not implemented for the 3274.
2. Receipt of a frame with valid BCC that contains an I-field and a command which should not be sent with an I-field.

3. Receipt of an I-format frame with valid BCC which contains an illegal Nr count in the C-field.
4. Receipt of an I-format frame in which the information field is too large to be accommodated by the available buffer space in the 3274.

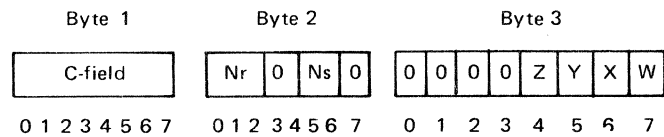

Byte 1 is the C-field that caused the CMDR response. Byte 2 contains the Ns and Nr sequence counts that existed immediately prior to establishing the CMDR response. Byte 3 indicates the reason for the CMDR.

Bit W is set to 1 when the C-field returned in byte 1 represents an invalid or nonimplemented command.

Bit X is set to 1 when the C-field returned in byte 1 is considered invalid because the frame contained an information field not allowed with the command sent.

Bit Y is set to 1 when the information field associated with the valid and implemented C-field contained in byte 1 was too long for the available buffer space in the 3274 control unit. This condition never occurs when bit X is set.

Bit Z is set when the receive Nr sequence count contained in the C-field in byte 1 is out of range.

Figure 5-32 shows the CMDR message format.

#### 5.10.5 Request Maintenance Statistics (REQMS) Command

The Request Maintenance Statistics (REQMS) command is sent by the SSCP to a 3274 when the Network Determination Aid Processor (NDAP) requests PU performance statistics. Four types of requests can be made, as follows:

- Type 1 – Link Test Statistics
- Type 2 – Summary Counters
- Type 3 – Communication Adapter Data Error Counts
- Type 5 – 3274 Configuration Information/3276 Machine Level Information

The state of the RESET/NO-RESET indicator in the REQMS request determines whether the log area where the transmitted maintenance statistics are stored is cleared.

An REQMS request that cannot be executed by the 3274 is rejected with a negative response; an accepted REQMS request receives a positive response and the requested statistics (formatted as RECFMS) as an inbound message.

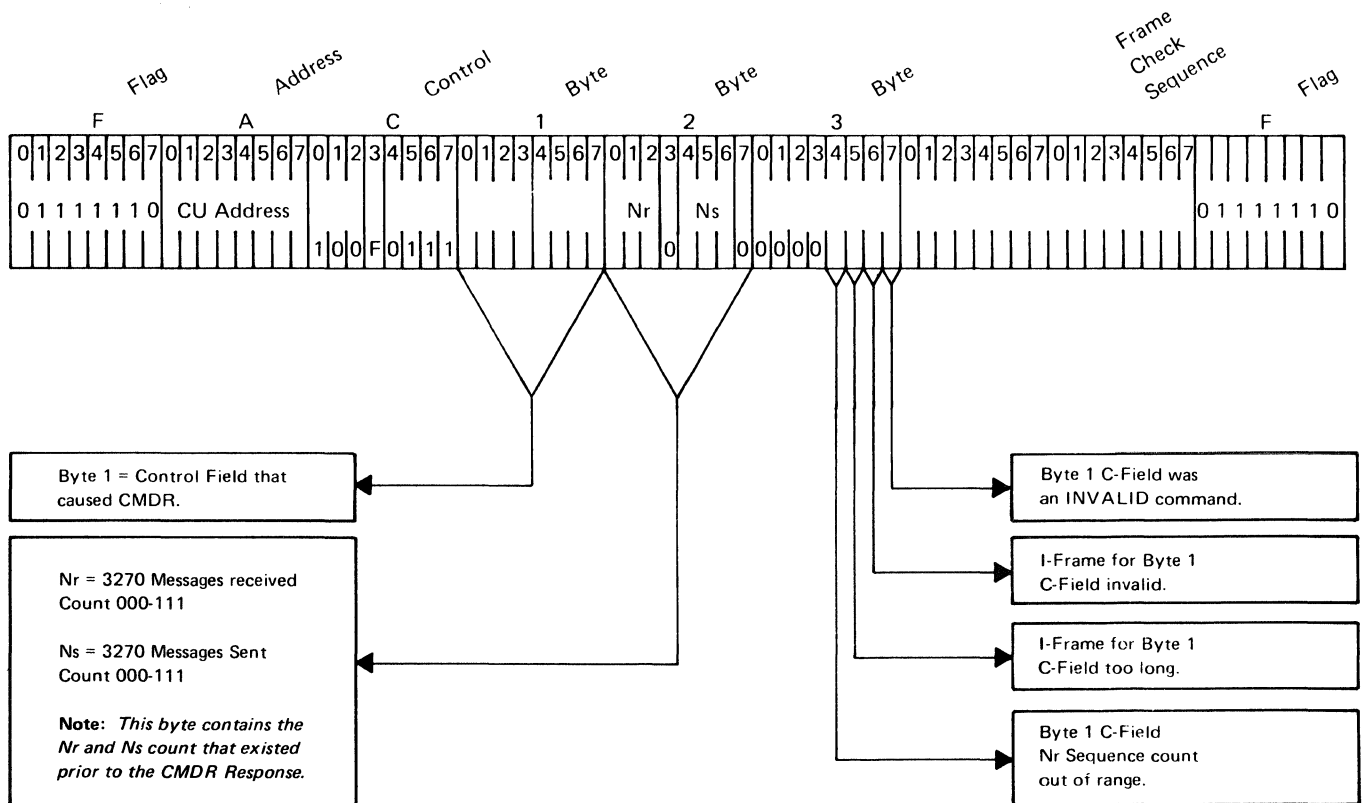

Figure 5-32. Command Reject (CMDR) Message Format

### 5.10.5.1 Record Formatted Maintenance Statistics (RECFMS)

Record Formatted Maintenance Statistics (RECFMS) is sent by the 3274 to the SSCP in response to an REQMS command. (The 3274 will not send unsolicited RECFMS requests to the host.) The RECFMS maintenance statistics are recorded at the host by the Network Communications Control Facility (NCCF).

When the 3274 accepts an REQMS request, it transmits the maintenance statistics requested. If the REQMS specified "RESET," the error log area referenced by the REQMS is reset by the 3274 after the RECFMS is transmitted.

A description of RECFMS responses follows.

### 5.10.5.2 RECFMS Formats

The 3274 can send the host system four types of RECFMS responses to an REQMS command.

Counters in type 1, 2, and 3 responses do not wrap when they exceed their maximum value; they maintain the maximum value.

The log areas are reset when:

- The 3274 is turned off (types 1, 2, and 3).
- The concurrent test, Error Log Erase, is executed for the 3274 CCA/HPCA Adapter (type 3 only).
- The execution of RECFMS is completed normally as the response to an REQMS with a "RESET" request (types 1, 2, and 3).

The formats of the four RECFMS responses are as follows:

- REQMS Request Type 1 – Link Test Statistics

Bytes 14, 15 = Number of times the Test Command was received.

Bytes 16, 17 = Number of times the Test response was transmitted.

- REQMS Request Type 2 – Summary Counters

Byte 14 = Mask bits of the summary counters supported. All supported counters, including those containing zero count, are sent to the host by RECFMS.

- Bit 0 = 1 = Machine Check.
- Bit 1 = 1 = Communication Check.
- Bit 2 = 1 = Program Check.
- Bits 3–7 = Reserved.

Bytes 15, 16 = Reserved.

Bytes 17, 18 = Machine Check Summary Counter.

Bytes 19, 20 = Communication Check Summary Counter.

Bytes 21, 22 = Program Check Summary Counter.

- REQMS Request Type 3 – Communication Adapter Data Error Counts

Byte 14 = Adapter Type.  
 = X'01' = CCA Link Adapter.  
 = X'02' = HPCA Link Adapter  
 = X'03' – X'FF' = Reserved.

Byte 15 = Mask bits of the Communication Adapter Error Counters supported. All supported counters, including those containing zero count, are sent to the host by RECFMS.

- Bit 0 = 1 = Nonproductive Timeout.
- Bit 1 = 1 = Idle Timeout.
- Bit 2 = 1 = Write Retry.
- Bit 3 = 1 = Overrun.
- Bit 4 = 1 = Underrun.
- Bit 5 = 1 = Connection Problem.
- Bit 6 = 1 = FCS Error.
- Bit 7 = 1 = Primary Abort.

Byte 16 = Mask bits of the Communication Adapter Error Counters supported. All supported counters, including those containing zero count, are sent to the host by RECFMS.

- Bit 0 = 1 = Command Reject.
- Bit 1 = 1 = DCE Error.
- Bit 2 = 1 = Write Timeout.
- Bits 3–7 = Reserved.

- Byte 17 = Reserved.
- Byte 18 = Nonproductive Timeout Counter.
- Byte 19 = Idle Timeout Counter.
- Byte 20 = Write Retry Counter.
- Byte 21 = Overrun Counter.
- Byte 22 = Underrun Counter.
- Byte 23 = Connection Problem Counter.
- Byte 24 = FCS Error Counter.
- Byte 25 = Primary Abort Counter.
- Byte 26 = Command Reject Counter.
- Byte 27 = DCE Error Counter.
- Byte 28 = Write Timeout Counter.

- REQMS Request Type 5 – 3274 Configuration Information

- Byte 14 = Always X'00'.
- Bytes 15–30 = Installed Patch ID Values.
- Byte 31 = Number of RPOs Installed on the 3274.
- Byte 32 = Reserved.
- Bytes 33–37 = RPO 1 ID.
- Bytes 38–42 = RPO 2 ID.
- Bytes 43–47 = RPO 3 ID.
- Bytes 48–50 = Control Values for Suffix Numbers.
- Bytes 51–60 = Reserved.
- Byte 61 = Feature Disk Level.
- Byte 62 = Feature Disk Suffix.
- Byte 63 = System Disk Level.
- Byte 64 = System Disk Suffix.
- Byte 65 = Language Disk Level.
- Byte 66 = Language Disk Suffix.
- Byte 67 = RPO 1 Disk Level.
- Byte 68 = RPO 1 Disk Suffix.
- Byte 69 = RPO 2 Disk Level.
- Byte 70 = RPO 2 Disk Suffix.
- Byte 71 = RPO 3 Disk Level.
- Byte 72 = RPO 3 Disk Suffix.



## 5-11 SWITCHES AND CONTROLS

Figure 5-33 explains the switches and controls.

Indicator/Control	Explanation
Power/Interface switch and On/Off switch (I = on; O = off) On Indicator	<p>When locally attached to a host system, power for the 3274 can be applied and removed from the host processor (remote power control) or at the 3274 (local power control) by using the Power/Interface switch as follows:</p> <ol style="list-style-type: none"> <li>1. Remote power control. When the Power/Interface switch is placed in the Remote/Online position and the On/Off switch to On, power can be turned on or off at the host processor.</li> <li>2. Local power control. To apply power, the Power/Interface switch is placed in the Local/Online position and the On/Off switch is placed in the On position. The On indicator lights. To remove power, the Power/Interface switch is placed in the Local/Offline position and the On/Off switch is set to Off, after the Local/Offline indicator lights.</li> </ol> <p>When remotely attached to a host system, power is applied and removed at the 3274 by using the On/Off switch. (The Power/Interface switch is not installed.)</p>
IML and Alt IML Address 1/2	<p>The Initial Machine Load (IML) pushbutton and the Alternate (Alt) IML rocker switch are used to initiate manual IML operations at the 3274.</p>
<b>Warning:</b>	<p><b>The Power/Interface switch must be in the Local/Offline position and the Local/Offline indicator must be on.</b></p>
	<p>Pressing and holding the IML pushbutton causes a basic test to be run. Releasing IML allows execution of the IML tests, followed by loading of the machine. (Total operation time is approximately 50 seconds.)</p>
<b>Warning:</b>	<p><b>Pressing the IML pushbutton causes an interruption and temporarily disables all terminals attached to the 3274. If any attached terminals are in use, all terminal operators should be notified before proceeding.</b></p>
IML and Alt IML Address 1/2	<p>Holding the Alt IML Address switch in position 1, while pressing and holding the IML pushbutton, loads the machine directly. This procedure should be followed only when the normal loading procedure fails and useful work can still be done.</p> <p>Holding the Alt IML Address switch in position 2 while pressing the IML pushbutton causes a communication link test to be run. The test is operable only when the Power/Interface switch is in the Remote position.</p>

Figure 5-33. Switches and Controls

### 5.12 BSC AND SNA READINESS SYMBOLS

Figures 5-34 and 5-35 show the readiness symbols associated with the BSC and SNA selection sequences, respectively.

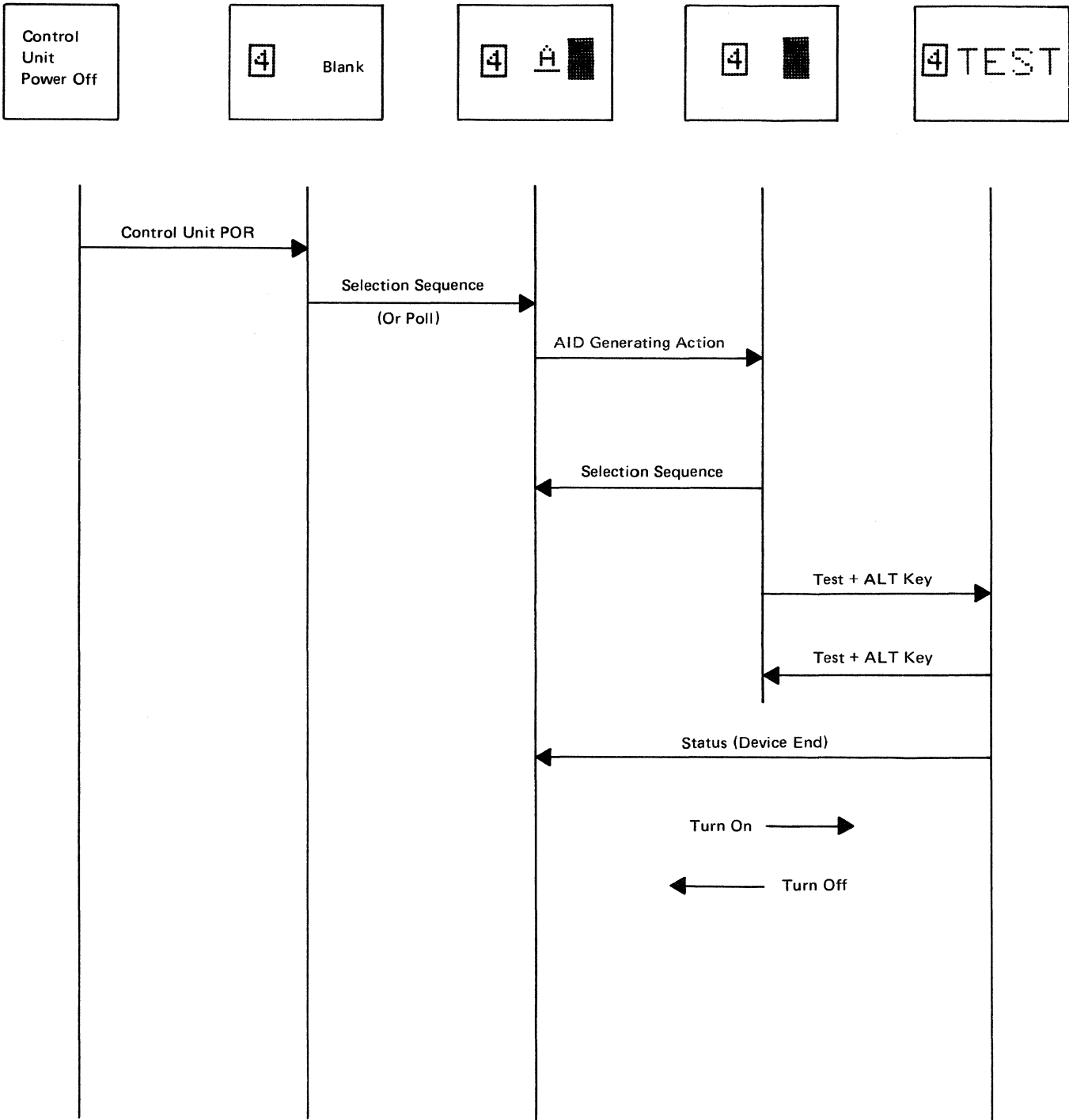
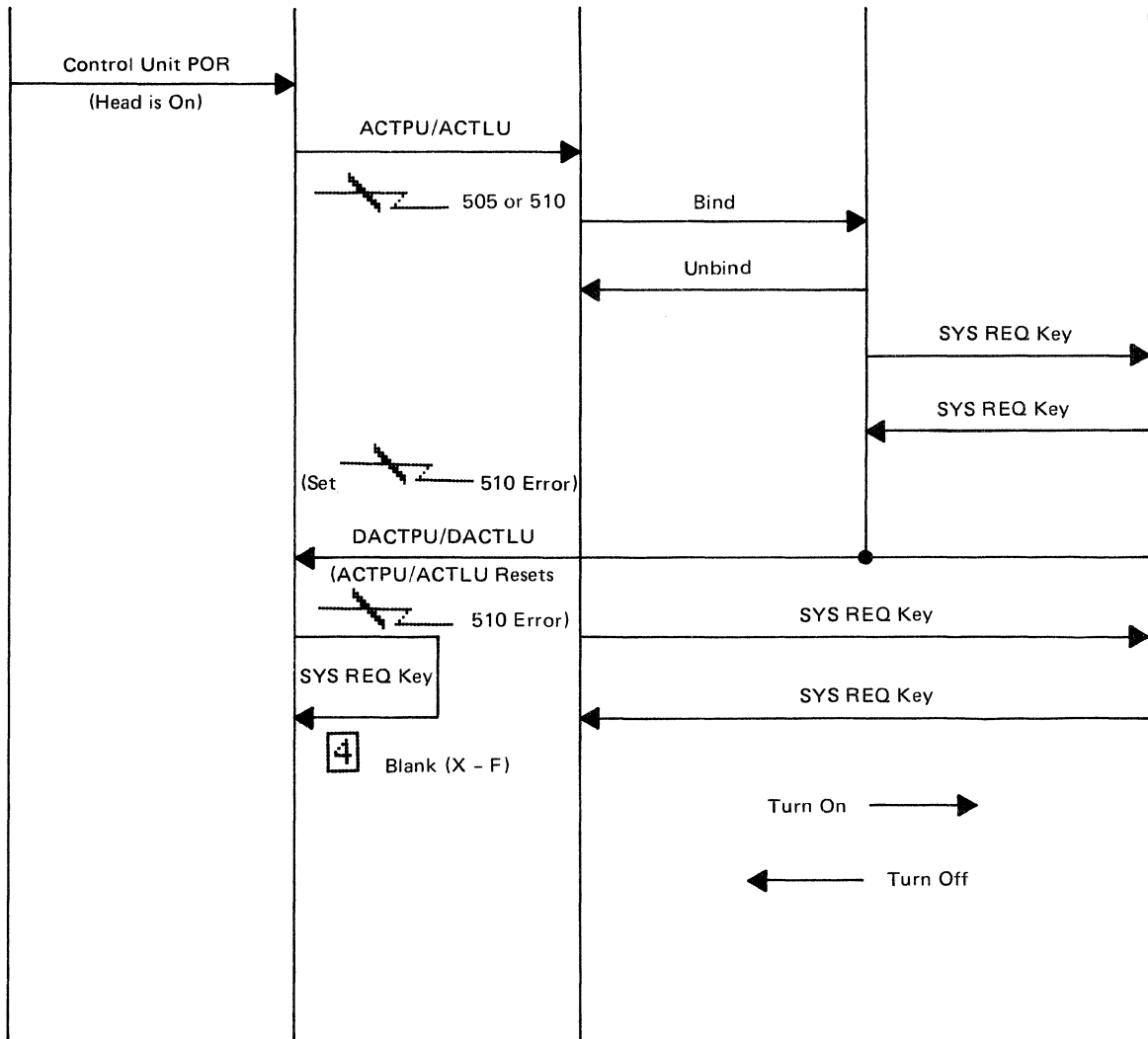
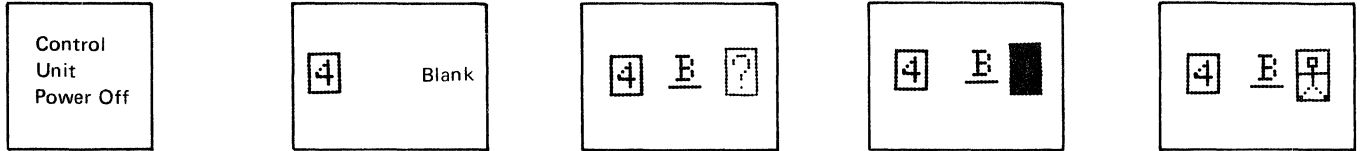

Figure 5-34. BSC Readiness Symbols



Note: The TEST key with ALT will set TEST. The second depression will return to the state prior to the entry to Test mode.

Note:  
 505 = SNRM Required  
 510 = PU Not Active

Figure 5-35. SNA Readiness Symbols

### 5.13 DIGITAL DATA SERVICE (DDS) ADAPTER

The Digital Data Service (DDS) Adapter provides for the connection of the control unit to the AT&T nonswitched Dataphone<sup>1</sup> digital data service network. The DDS Adapter is an integrated adapter for BSC or SDLC data transmission at speeds of 2400, 4800, or 9600 bps or for SDLC transmission at 56,000 bps. Access to the DDS network is provided by the AT&T Channel Service Unit, which is the DDS network termination point at the customer site. See Figure 5-36.

The 3274 must have either the Common Communications Adapter (CCA) or the High-Performance Communications Adapter (HPCA) installed. (The HPCA is required for operation at 56,000 bps.) The DDS Adapter can be used in point-to-point or multipoint configurations. Wrap test capability of the DDS Adapter allows testing of the adapter only, or the adapter and the communications cable. Figure 5-37 illustrates the digital data waveshapes.

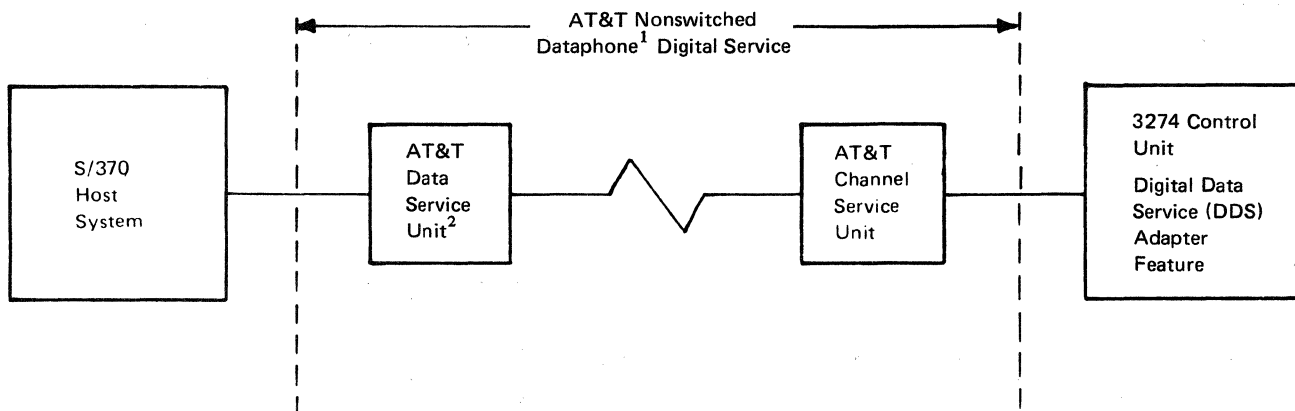

<sup>1</sup>Trademark of American Telephone and Telegraph Co.

<sup>2</sup>Or equivalent

Figure 5-36. Connection of 3274 Control Unit with DDS Adapter Feature

DDSA Output to Channel Service Unit

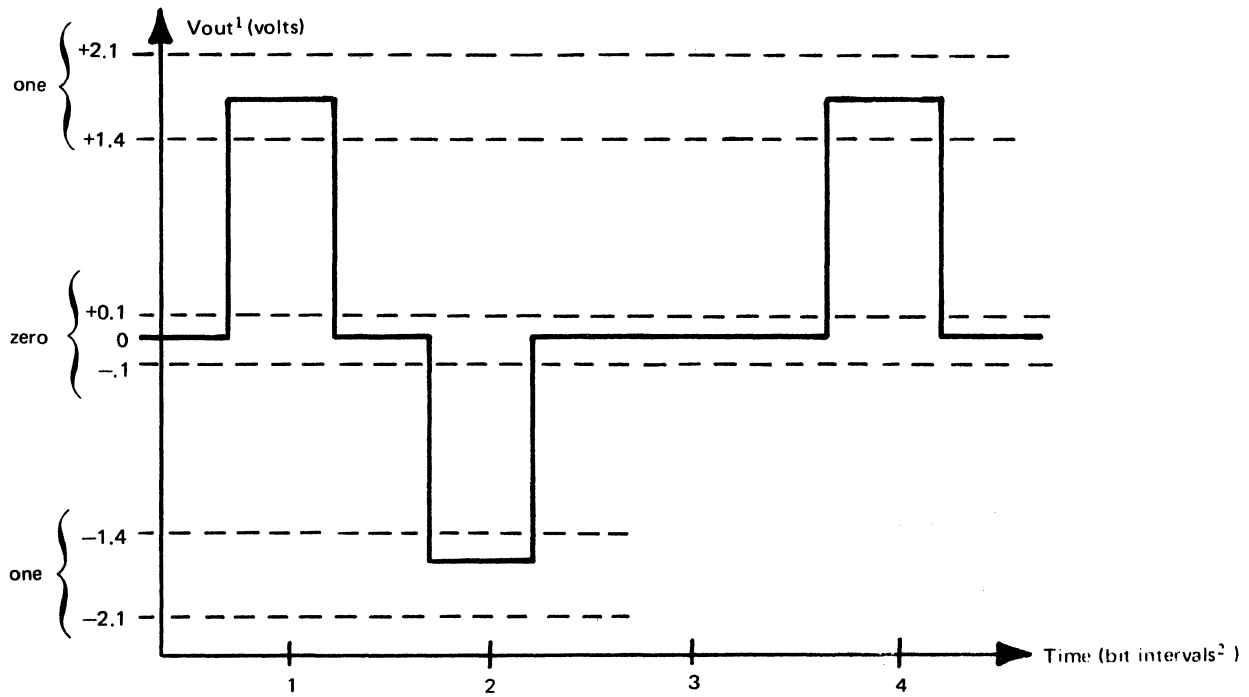

Channel Service Unit Input to DDSA

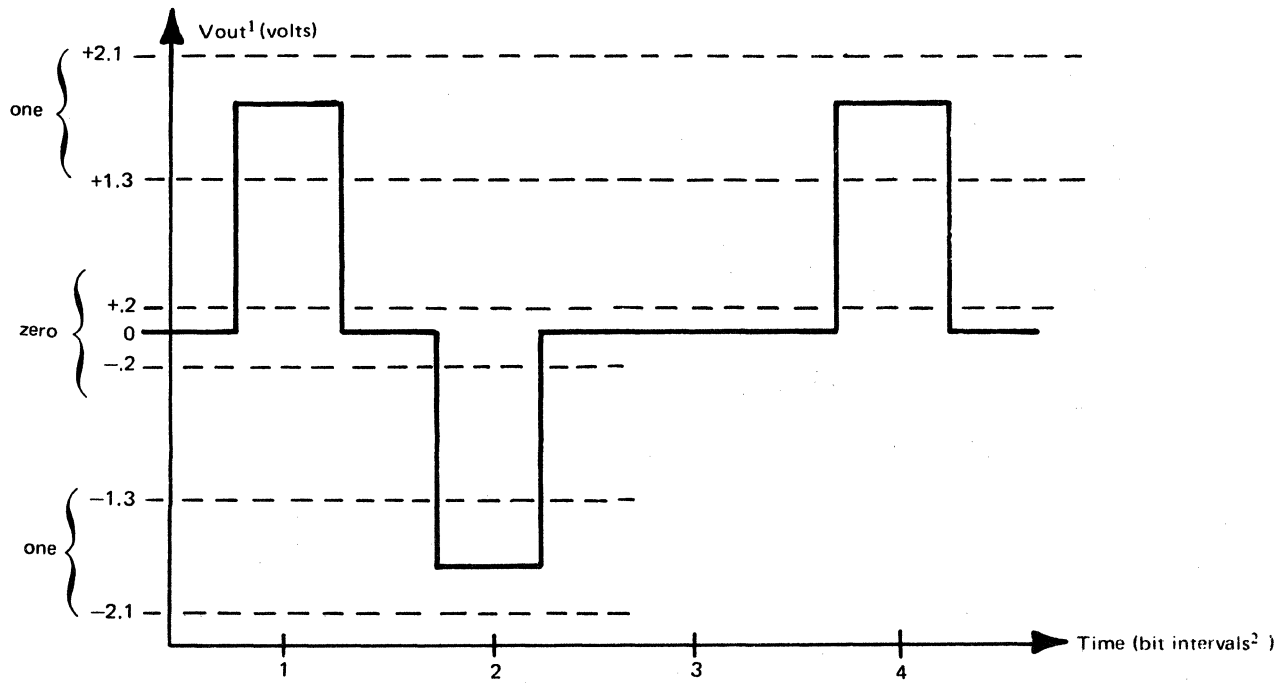

<sup>1</sup> Vout<sup>1</sup> is a differential ac voltage across a 135-ohm resistive termination

<sup>2</sup> Bit interval =  $\frac{1}{\text{bit rate (bps)}}$

Figure 5-37. Digital Data Waveshapes



# Chapter 6. Tools and Test Equipment

## 6.1 INTRODUCTION

This chapter identifies and describes the specialized tools and test equipment that may be required for 3274 problem isolation.

These specialized pieces of test equipment are presently used with the 3274 Control Unit:

- Buffered Teleprocessing Diagnostic Analyzer and Tester (BTDAT)
- NU Data Tester, IBM PN 453637
- PT-2

## 6.2 BUFFERED TELEPROCESSING DIAGNOSTIC ANALYZER AND TESTER (BTDAT)

The Buffered Teleprocessing Diagnostic Analyzer and Tester (BTDAT) was designed as a branch office teleprocessing (TP) specialist's tool. The purpose of this tool is to trap transmit data and/or receive data for analysis and to further use this data to exercise local or downline TP devices.

The BTDAT consists of two 32K bit memories and various registers and controls to allow data in and out of these buffers.

## 6.3 NU DATA TESTER

The NU Data Tester (IBM PN 453637) is used to monitor and isolate problems between data terminal equipment and data transmission equipment that follow the standards outlined in EIA Standard RS-232-c.

Seven EIA leads are displayed for continuous monitoring: transmit and receive data, data terminal ready, data set ready, request to send, clear to send, and carrier detected.

This tester connects in series with the EIA/CCITT data set cable and the 25-pin data set connector. The CE may then monitor, measure, or control the leads on the data set interface.

## 6.4 PT-2 ATTACHMENT TO NON-EIA INTERFACES

This procedure will allow attachment of a PT-2 to the 3274 in such a way as to allow monitoring of transmit and receive data when a Non-EIA Interface is present.

1. Assemble PT-2 using TP Line Monitor (TPLM) Adapter.
2. Set Optional Probe Switches on TPLM Adapter to the SLT/VTL (UP) position.
3. Attach optional probes as follows:

TPLM	Line Name
2	Xmit Data
3	Req to Send
4	Clear to Send
5	Xmit Clock
6	Rec. Data
7	Carrier Detect
8	Receive Clock
9	Data Set Ready

The appropriate tab pins are shown in Figure 6-1.

4. Load TP Tool Program and enter appropriate responses to questions displayed.
  - a. Specify Product Clock.
  - b. When running above 9600 bps (via V.35, X.21, or DDSA features) it is necessary to use the High-Speed Monitor Function of the PT-2. Refer to PT-2 Line Monitor Manual, Section 6.

CCA/HPCA Location A1H2(51C) A1L2(61C)	EIA/DDSA*/V.35*/X.21*/Greater than Locations A1G2(51C) A1K2(61C)	1200-bps Integrated Modem
U04	Xmit Data	D04
S10	Req to Send	D02
S12	Clear to Send	D13
U11	Xmit Clock	B07
U13	Rec Data	B10
S04	Carrier Detect	B12
U10	Receive Clock	B08
S13	Data Set Ready	B13
U12	Data Terminal Rdy	B02

\*Can run only up to 9600 bps unless High-Speed Monitor Function.

Figure 6-1. TPLM Tab Pin Locations





# Appendix A. Support Structure Information Form

CE Name \_\_\_\_\_ CE Telephone Number \_\_\_\_\_

Customer Name \_\_\_\_\_ Customer Telephone Number \_\_\_\_\_

Customer Number \_\_\_\_\_ Branch Office Number \_\_\_\_\_

Host System Type \_\_\_\_\_ Subsystem Type/Model \_\_\_\_\_

Incident Machine Type/Model \_\_\_\_\_

Serial Number \_\_\_\_\_ EC Level \_\_\_\_\_

Installed Microcode \_\_\_\_\_

Part Number \_\_\_\_\_ EC Level \_\_\_\_\_

REAs 1 \_\_\_\_\_ 2 \_\_\_\_\_ 3 \_\_\_\_\_ 4 \_\_\_\_\_

5 \_\_\_\_\_ 6 \_\_\_\_\_ 7 \_\_\_\_\_ 8 \_\_\_\_\_

If your subsystem is a local configuration, include the following information:

Control unit type/model \_\_\_\_\_

Channel type: Selector \_\_\_\_\_ Byte \_\_\_\_\_ Block \_\_\_\_\_

Channel cable length (max 200 ft) \_\_\_\_\_

Control unit position on channel (1-8) \_\_\_\_\_

Last unit on channel? Yes \_\_\_\_\_ No \_\_\_\_\_

If your subsystem is a remote configuration, include the following information:

Multiplexer type: 270x \_\_\_\_\_ 370x \_\_\_\_\_ OEM \_\_\_\_\_

Line type: Point to point \_\_\_\_\_ Multipoint \_\_\_\_\_ Switched \_\_\_\_\_

Number of wires: 2 \_\_\_\_\_ 4 \_\_\_\_\_

Modem type: IBM \_\_\_\_\_ OEM \_\_\_\_\_

Line speed (baud): 1200 \_\_\_\_\_ 2000 \_\_\_\_\_ 2400 \_\_\_\_\_ 4800 \_\_\_\_\_

7200 \_\_\_\_\_ 9600 \_\_\_\_\_ Other \_\_\_\_\_

Communications adapter type: CCA \_\_\_\_\_ HPCA \_\_\_\_\_ EIA \_\_\_\_\_

SLA \_\_\_\_\_ Other (specify) \_\_\_\_\_

Channel type: Selector \_\_\_\_\_ Byte \_\_\_\_\_ Block \_\_\_\_\_

Channel cable length (max 200 ft): \_\_\_\_\_

Control unit position on channel (1-8) \_\_\_\_\_

Control unit priority: High \_\_\_\_\_ Low \_\_\_\_\_

Multichannel switch: Yes \_\_\_\_\_ No \_\_\_\_\_

Number and type of attached devices.

Number of ports \_\_\_\_\_

Number of 3299s attached \_\_\_\_\_

Total number of displays attached \_\_\_\_\_

Number of displays by type:

3277-1	_____	3278-1	_____	3279-S2A	_____
3277-2	_____	3278-2	_____	3279-S2B	_____
---	_____	3278-3	_____	3279-S3G	_____
3178-1	_____	3278-4	_____	3279-02X	_____
3178-2	_____			3279-03X	_____

Total number of printers attached \_\_\_\_\_

Number of printers by type:

3284-1	_____	3287-1	_____	3289-1	_____	3268-2	_____
3284-2	_____	3287-2	_____	3289-2	_____	4250	_____
3284-3	_____	3287-1C	_____	---	_____	5210-G01	_____
---	_____	3287-2C	_____	3230-2	_____	5210-G02	_____
3286-1	_____	---	_____	---	_____		
3286-2	_____	3288-2	_____	3262-3	_____		
				3262-13	_____		

Number of distributed function devices (by type)

3290 \_\_\_\_\_

Subsystem features.

Subsystem machine type/model \_\_\_\_\_

List appropriate features \_\_\_\_\_  
\_\_\_\_\_  
\_\_\_\_\_  
\_\_\_\_\_  
\_\_\_\_\_

Does subsystem machine have any RPOs? Yes \_\_\_\_\_ No \_\_\_\_\_

If yes, list RPOs \_\_\_\_\_  
\_\_\_\_\_  
\_\_\_\_\_  
\_\_\_\_\_

If the incident machine and the subsystem machine are not the same, list the appropriate features and/or RPOs for the incident machine.

Incident machine type/model \_\_\_\_\_

Features \_\_\_\_\_  
\_\_\_\_\_  
\_\_\_\_\_  
\_\_\_\_\_

Does the incident machine have RPOs? Yes \_\_\_\_\_ No \_\_\_\_\_

If yes, list the RPOs \_\_\_\_\_  
\_\_\_\_\_  
\_\_\_\_\_

Host system program support information.

SCP type: OS \_\_\_\_\_ DOS \_\_\_\_\_ VS1 (SVS) \_\_\_\_\_ VS2 (MVS) \_\_\_\_\_ VM \_\_\_\_\_  
APL \_\_\_\_\_ Other (specify) \_\_\_\_\_ Release level \_\_\_\_\_

Access method: BTAM \_\_\_\_\_ TCAM \_\_\_\_\_ TCAM-E \_\_\_\_\_ VTAM \_\_\_\_\_  
GAM \_\_\_\_\_ Other (specify) \_\_\_\_\_ Version number \_\_\_\_\_

Application type: APLSV \_\_\_\_\_ CICS \_\_\_\_\_ CMS \_\_\_\_\_ TSO \_\_\_\_\_ IMS \_\_\_\_\_  
MIS \_\_\_\_\_ Other (specify) \_\_\_\_\_ Version number \_\_\_\_\_

NCP type (370x only) \_\_\_\_\_ Release level \_\_\_\_\_

PEP type (270x only) \_\_\_\_\_ Release level \_\_\_\_\_

EP type (270x only) \_\_\_\_\_ Release level \_\_\_\_\_

General description of problem and the maintenance aids used.

Incident machine type/model \_\_\_\_\_

Brief description of problem: \_\_\_\_\_  
\_\_\_\_\_  
\_\_\_\_\_

Tools used: \_\_\_\_\_  
\_\_\_\_\_  
\_\_\_\_\_  
\_\_\_\_\_



# Appendix B. 3274 Model 51C, 52C, and 61C Error Codes

This appendix has three parts: the first (heading B.1) lists the error codes; the second (heading B.2) contains expanded discussion of probable causes for selected error codes; the third (heading B.3) describes the relationship of the error codes and the extended-DCB log area for selected error codes.

The three-digit error codes (nnn) are displayed in the operator information area on the display and follow the Machine Check ( X ), Program Check ( X PRQG ), and Communication Check ( X ) symbols. These codes further define the error conditions indicated by the error symbols.

The first digit of the nnn code indicates the type of error that occurred, as follows:





nnn Code	Type of Error
2XX, 3XX	Machine check
4XX	Program check
5XX	Communication check
6XX and 7XX	3290 nnn codes (Not defined in this manual. Refer to Documentation for Specific Device).

For example, a Communication Check symbol followed by an nnn code of 532 ( X 532) indicates that the BSC line is idle.

## B.1 LIST OF ERROR CODES

The error codes (nnn) are listed in numeric order with the following information to assist you in problem determination:

- Error description
- 8 4 2 1 indicator setting
- Test number used to retrieve the logout
- The error statistic counter that is incremented
- Where the code is displayed (one/all displays)
- Indication displayed in the operator information area on the display ( X 203)
- Probable cause and action to be performed
- Sense information
- Application features associated with the error condition

nnn Code	Error Description	Operational Indicator	Test No. for Log*	Counter Incremented	Log Only	Displayed On		Indicator Displayed	Recovery	Probable Cause/Action	Sense Codes		Applicable Feature
						All	One				SNA	Non-SNA	
202	Interrupt Threshold Exceeded <ul style="list-style-type: none"> <li>Terminal with 202 error display caused keystroke/status buffer overflow.</li> <li>The terminal is disabled.</li> </ul>	—	nn/1	5	—	—	X	X  202	<ul style="list-style-type: none"> <li>POR device</li> </ul>	<ul style="list-style-type: none"> <li>Internal terminal error (see device MIM)</li> </ul>	081C	DC/US	Category A Terminal
203	Feature Bus Error <ul style="list-style-type: none"> <li>Feature-bus error at terminal.</li> </ul>	—	nn/1	6	—	—	X	X  203	<ul style="list-style-type: none"> <li>Reset key</li> <li>Retry operation</li> </ul>	<ul style="list-style-type: none"> <li>Terminal Feature circuitry failure (see device MIM)</li> </ul>	—	—	Features
204	Device Check <ul style="list-style-type: none"> <li>Terminal-buffer parity error was detected.</li> <li>Control unit clears buffer.</li> <li>If recovery not successful, terminal is disabled.</li> </ul>	—	nn/1	4	—	—	X	X  204	<ul style="list-style-type: none"> <li>Reset key</li> <li>Host recovery</li> <li>POR device If disabled</li> </ul>	<ul style="list-style-type: none"> <li>Terminal buffer parity error (see device MIM)</li> </ul>	028B 081C	DC/US DC/US	Category A Terminal
205	Unsupported Feature Address Attached <ul style="list-style-type: none"> <li>Feature is not supported with configuration selected at customizing time, <i>or</i></li> <li>Feature did not respond when the terminal was initialized.</li> </ul>	—	nn/1	—	—	—	X	X  205	<ul style="list-style-type: none"> <li>Reset key</li> <li>Retry operation</li> </ul>	<ul style="list-style-type: none"> <li>Verify customizing selected feature</li> <li>Reminder is on if display can be used</li> </ul>	—	—	Feature
206	Invalid Feature Response on Initialization <ul style="list-style-type: none"> <li>Invalid response from feature during initialization.</li> <li>Terminal remains enabled, <i>but</i> all features are disabled.</li> </ul>	—	nn/1	6	—	—	X	X  206	<ul style="list-style-type: none"> <li>Reset key</li> <li>Retry operation</li> </ul>	<ul style="list-style-type: none"> <li>Feature did not initialize properly (see device MIM)</li> </ul>	—	—	Feature

\*Where nn = port ID = 00-15

nnn Code	Error Description	Operational Indicator	Test No. for Log*	Counter Incremented	Log Only	Displayed On		Indicator Displayed	Recovery	Probable Cause/Action	Sense Codes		Applicable Feature
						All	One				SNA	Non-SNA	
207	Lost Operation Completed <ul style="list-style-type: none"> <li>Control unit started on operation to terminal that required deferred ending status (Op Complete).</li> <li>Over 1 second elapsed, and Op Complete not received.</li> <li>The terminal is disabled.</li> </ul>	—	nn/1	5	—	—	X	✗ 207	<ul style="list-style-type: none"> <li>POR device</li> </ul>	<ul style="list-style-type: none"> <li>Terminal failure (see device MIM)</li> <li>Loss of communication with device (Coax)</li> </ul>	081C	DC/US	Category A Terminal
208	Invalid Operation Completed <ul style="list-style-type: none"> <li>Asynchronous Ending Status received when no operation.</li> </ul>	—	nn/1	5	—		X	✗ 208	<ul style="list-style-type: none"> <li>Reset key</li> <li>Retry operation</li> </ul>	<ul style="list-style-type: none"> <li>Terminal error (see device MIM)</li> </ul>	—	—	Category A Terminal
209	Command Queue Failed <ul style="list-style-type: none"> <li>A Cycle Sharing command or data queue failed in transmission.</li> <li>Operation is retried, and counter is incremented.</li> <li>If retry fails, terminal is disabled.</li> </ul>		nn/1	1 or 2	—		X	✗ 209	<ul style="list-style-type: none"> <li>POR device</li> </ul>	<ul style="list-style-type: none"> <li>CU to terminal communication failure (Coax)</li> </ul>	081C	DC/US	Category A Terminal
210	Invalid Keyboard Attached <ul style="list-style-type: none"> <li>The ID of the terminal's keyboard does not match the types selected during customizing.</li> <li>No table is available for this keyboard type.</li> </ul>		nn/1	—	—		X	✗ 210	<ul style="list-style-type: none"> <li>Reset key</li> <li>Retry operation</li> </ul>	<ul style="list-style-type: none"> <li>Verify keyboard type selected in customizing</li> </ul>	—	—	Type A Adapter
211	Invalid Status Received <ul style="list-style-type: none"> <li>Invalid combination of status bits received from terminal.</li> <li>Keyboard is locked.</li> <li>If Reset key fails, terminal is disabled.</li> </ul>		nn/1	5	—		X	✗ 211	<ul style="list-style-type: none"> <li>Reset key</li> <li>Retry operation</li> </ul>	<ul style="list-style-type: none"> <li>Terminal error (see device MIM)</li> </ul>	081C	DC/US	Category A Terminal

\*Where nn = port ID = 00-15

nnn Code	Error Description	Operational Indicator	Test No. for Log*	Counter Incremented	Log Only	Displayed On		Indicator Displayed	Recovery	Probable Cause/Action	Sense Codes		Applicable Feature
						All	One				SNA	Non-SNA	
212	Invalid Scan Code Received <ul style="list-style-type: none"> <li>Invalid scan code was received from this terminal.</li> <li>Keyboard is locked.</li> </ul>		nn/1	—	—		X	X 212	<ul style="list-style-type: none"> <li>Reset key</li> <li>Retry operation</li> </ul>	<ul style="list-style-type: none"> <li>Terminal keyboard error</li> <li>Customization error (see device MIM)</li> </ul>	—	—	Category A Terminal Keyboard
222	Invalid Selector Pen Status or Command Queue Failure <ul style="list-style-type: none"> <li>Illegal status received from selector pen or</li> <li>Selector pen I/O operation failed after retry.</li> </ul>		nn/1	6	—		X	X 222	<ul style="list-style-type: none"> <li>Reset key</li> <li>Retry operation</li> </ul>	<ul style="list-style-type: none"> <li>Selector lightpen error (see device MIM)</li> </ul>	—	—	Category A Terminal Light Pen
223	ECS Adapter Buffer Parity Error <ul style="list-style-type: none"> <li>Control unit clears buffer and notifies host.</li> <li>If clear does not eliminate parity check, the terminal is disabled.</li> </ul>		nn/1	6	—		X	X 223	<ul style="list-style-type: none"> <li>Host recovery</li> <li>Retry operation</li> <li>POR device if disabled</li> </ul>	<ul style="list-style-type: none"> <li>ECS adapter buffer (see device MIM)</li> </ul>	082B	DC/US	ECS Feature
224	Invalid MSR or MHS Status or Command Queue Failure <ul style="list-style-type: none"> <li>Illegal status received from Mag Strip Reader or MHS.</li> <li>MSR or MHS I/O operation failed after retry.</li> </ul>		nn/1	6	—		X	X 224	<ul style="list-style-type: none"> <li>Reset key</li> <li>Retry operation</li> </ul>	<ul style="list-style-type: none"> <li>MSR</li> <li>MHS (see device MIM)</li> </ul>			Category A Terminal MSR or MHS
225	ECS Adapter Status/ Initialization Error <ul style="list-style-type: none"> <li>Device is disabled if not recoverable.</li> </ul>		nn/1	6	—		X	X 225	<ul style="list-style-type: none"> <li>Reset key</li> <li>POR device if disabled</li> </ul>	<ul style="list-style-type: none"> <li>ECS adapter error (see device MIM)</li> </ul>	081C	DC/US	Category A Terminal

\*Where nn = port ID = 00-15



nnn Code	Error Description	Operational Indicator	Test No. for Log*	Counter Incremented	Log Only	Displayed On		Indicator Displayed	Recovery	Probable Cause/Action	Sense Codes		Applicable Feature
						All	One				SNA	Non-SNA	
226/ 227	ECSA Feature Command Queue Failure <ul style="list-style-type: none"> <li>● A cycle-sharing command/ data operation failed in transmission.</li> <li>● Operation is retried, and counter is incremented.</li> <li>● If retry fails, the terminal is disabled.</li> </ul>		nn/1	1 or 2	—		X	✗ 226 or ✗ 227	● Device POR	● Transmission error while communicat- ing with ECS Feature	081C	DC/US	Category A Terminal ECS Feature
228	Convergence Backup Store Failure		nn/1	6				✗ 228	● Reset key ● Retry operation	● Battery failure (see device MIM)			3279 Color
229	Convergence Feature Memory Failure		nn/1	6				✗ 229	● Reset key ● Retry operation	● Convergence logic (see device MIM)			3279 Color
231	Printer Equipment Check <ul style="list-style-type: none"> <li>● Printer reported an unrecover- able error to the control unit.</li> </ul>		nn/1	6		—	X	—	● See Printer PDG	● Printer error	081C	EC/IR/ US	Category A Printer
234	ECS without ROS	—	nn/1	—	—	—	X	✗ 234	● POR device ● At 3278 termi- nal, activate test switch from Normal to Test and back again	● The ECS adapter does not have the required ROS	—	—	Category A Adapter
235	Bad Status or Command Q Failure			6			X	✗ 235	● Device POR	● Port is Disabled	081C	DC/US	PC
236	Lost Op Code			6			X	✗ 236	● Device POR	● PC Software/ Check PC Software	081C	DC/US	PC
237	Message Protocol Error			6			X	✗ 237	● Device POR	● PC Software/ Check PC Software	081C	DC/US	PC

\*Where nn = port ID = 00-15

There will be a 6NN error number request at the 3290, and the last two digits of the 6NN error number will be recorded in the device error log. Refer to the 3290 documentation for a description of the 6NN error numbers.

nnn Code	Error Description	Operational Indicator	Test No. for Log*	Counter Incremented	Log Only	Displayed On		Indicator Displayed	Recovery	Probable Cause/Action	Sense Codes		Applicable Feature
						All	One				SNA	Non-SNA	
238	Inbound Message Exceeded Maximum Allowable Length			6			X	X	• Device POR	• PC Software/ Check PC Software	081C	DC/US	PC
240	Sync Error Between 3290 and 3274 – Interface Disconnected		nn/1	6			X	X	• Device POR	• 3290 - 3274 Sync Error appears to be caused by 3290	081C	DC/US	3290
241	Sync Error Between 3290 and 3274 – Interface Disconnected		nn/1	6			X	X	• Device POR	• 3290 - 3274 Sync Error appears to be caused by 3274	081C	DC/US	3290
242	Permanent Error – Interface Disabled		nn/1	5			X	X	• Device POR	•	081C	DC/US	3290
243	Time Expected For Reply (Lost or Op-Complete) Interface Disabled		nn/1	5			X	X	• Device POR	• Excessively long data stream pre- sented for 3290 processing, conse- quently, the 3274 did not receive required ending status (Op Comple- te) from the 3290 within the allowed time	081C	DC/US	3290
263 thru 269	Refer to installed RPO documentation.												
270	Unrecoverable Machine Check • The control unit detected an unrecoverable error from the Type B adapter. • Type B adapter is disabled. • Type A terminals are not affected.	1010	A2/1	6	X	–	–	–	• IML	• Type B adapter logic	–	–	Type B Adapter

\*Where nn = port ID = 00-15

There will be a 6NN error number request at the 3290, and the last two digits of the 6NN error number will be recorded in the device error log. Refer to the 3290 documentation for a description of the 6NN error numbers.

nnn Code	Error Description	Operational Indicator	Test No. for Log*	Counter Incremented	Log Only	Displayed On		Indicator Displayed	Recovery	Probable Cause/Action	Sense Codes		Applicable Feature
						All	One				SNA	Non-SNA	
271	Adapter Disabled – Interrupt Threshold Exceeded <ul style="list-style-type: none"> <li>● Category B device exceeded interrupt threshold value within 1 second.</li> <li>● Type B adapter disabled.</li> <li>● Type A terminals are not affected.</li> </ul>	1010	A2/1	–	X	–	–	–	● IML	<ul style="list-style-type: none"> <li>● Type B device</li> <li>● Use /3 test – bad device indicated by ‘ – ’</li> <li>● Device log for failing device should indicate 279</li> </ul>			Category B Terminal
272	Unrecoverable Overrun <ul style="list-style-type: none"> <li>● Type B adapter requested data, the request was not serviced within control unit cycle steal I/O time, and recovery attempts were unsuccessful.</li> </ul>	1010	A2/1	2	X	–	–	–	● Host recovery	● Type B adapter logic	082B	DC/US	Type B Adapter
273	Adapter Timeout <ul style="list-style-type: none"> <li>● Type B adapter did not return I/O operation ending status within 2 seconds.</li> <li>● Type B adapter is disabled.</li> <li>● Type A adapter is unaffected.</li> </ul>	1010	A2/1	–	X	–	–	–	● IML	● Type B adapter logic	–	–	Category B Terminal
274	Solid Busy <ul style="list-style-type: none"> <li>● An EAU command sent to the terminal, and Busy condition does not clear.</li> <li>● Terminal is disabled because of error.</li> </ul>		nn/1	–	X	–	–	–	● POR device	● Type B device error	081C	DC/US	Category B Terminal
275	Equipment Check and Printer Not Ready <ul style="list-style-type: none"> <li>● Printer has returned Sense of Equipment Check and Not Ready.</li> </ul>		nn/1	6	X	–	–	–	● See Printer PDG	● Printer error	081C	EC/IR/US	Category B Printer
276	Equipment Check – Printer <ul style="list-style-type: none"> <li>● Printer has returned Sense of malfunction while printing.</li> <li>● Print-buffer contents not affected.</li> </ul>		nn/1	5	X	–	–	–	● See Printer PDG	● Printer error	082B	EC/US	Category B Printer

\*Where nn = port ID = 00-15

nnn Code	Error Description	Operational Indicator	Test No. for Log*	Counter Incremented	Log Only	Displayed On		Indicator Displayed	Recovery	Probable Cause/Action	Sense Codes		Applicable Feature
						All	One				SNA	Non-SNA	
277	Device Check <ul style="list-style-type: none"> <li>Device buffer parity error.</li> <li>Host error recovery should clear error.</li> <li>Device disabled if recovery is unsuccessful.</li> </ul>		nn/1	4	X	-	-	-	<ul style="list-style-type: none"> <li>Host recovery</li> <li>POR device</li> </ul>	<ul style="list-style-type: none"> <li>Type B device buffer</li> </ul>	082B	DC/US	Category B Terminal
278	Coax Parity <ul style="list-style-type: none"> <li>Parity error while communicating with device via coax.</li> <li>Device disabled if retry fails.</li> </ul>		nn/1	2	X	-	-	-	<ul style="list-style-type: none"> <li>Host recovery</li> <li>POR device</li> </ul>	<ul style="list-style-type: none"> <li>Coax</li> <li>Device error</li> <li>Type B Dr/Rcvr</li> </ul>	081C	DC/US	Type B Adapter
279	Interrupt Threshold Exceeded <ul style="list-style-type: none"> <li>Device exceeded interrupt threshold value.</li> <li>Type B adapter disabled.</li> </ul>	1010	nn/1	-	X	-	-	-	<ul style="list-style-type: none"> <li>IML</li> </ul>	<ul style="list-style-type: none"> <li>Device with nnn = 279 in log caused adapter to be disabled</li> <li>Type B device</li> <li>Search device error log to determine failing device.</li> <li>Use /3 test also.</li> </ul>	081C	DC/US	Category B Terminal
292	Illegal Entry in Error Queue <ul style="list-style-type: none"> <li>Illegal combination of status in error queue for Type A adapter.</li> </ul>		A1/1	1	-	X	-	X 292	<ul style="list-style-type: none"> <li>Reset key</li> <li>Retry operation</li> </ul>	<ul style="list-style-type: none"> <li>Type A adapter</li> </ul>	-	-	Type A Adapter
293	Unconfigured Device <ul style="list-style-type: none"> <li>Input received from a device address not in configuration table.</li> </ul>		A1/1	2	-	X	-	X 293	<ul style="list-style-type: none"> <li>Reset key</li> <li>Retry operation</li> </ul>	<ul style="list-style-type: none"> <li>Ensure that port address is included in customizing</li> </ul>	-	-	Type A Adapter
294	Unexpected End Cycle Share <ul style="list-style-type: none"> <li>Control unit received End of Cycle Share when none was initiated.</li> </ul>		A1/1	3	-	X	-	X 294	<ul style="list-style-type: none"> <li>Reset key</li> <li>Retry operation</li> </ul>	<ul style="list-style-type: none"> <li>Type A adapter</li> </ul>	-	-	Type A Adapter
295	Invalid DCA Status <ul style="list-style-type: none"> <li>Undefined combination of status bits received from Type A adapter.</li> </ul>		A1/1	4	-	X	-	X 295	<ul style="list-style-type: none"> <li>Reset key</li> <li>Retry operation</li> </ul>	<ul style="list-style-type: none"> <li>Type A adapter</li> </ul>	-	-	Type A Adapter

\*Where nn = port ID = 00-15

nnn Code	Error Description	Operational Indicator	Test No. for Log*	Counter Incremented	Log Only	Displayed On		Indicator Displayed	Recovery	Probable Cause/Action	Sense Codes		Applicable Feature
						All	One				SNA	Non-SNA	
296	Lost Status <ul style="list-style-type: none"> <li>Type A adapter keystroke/status buffers reached threshold (64CTR overflow).</li> <li>Status was lost during an attempted restart.</li> </ul>		A1/1	5	—	X	—	✘ 296	<ul style="list-style-type: none"> <li>Reset key</li> <li>Retry operation</li> </ul>	<ul style="list-style-type: none"> <li>Type A adapter</li> </ul>	—	—	Type A Adapter
297	Adapter Stopped and Was Restarted <ul style="list-style-type: none"> <li>The DCA was detected to be stopped with active set for longer than allowed.</li> <li>The DCA was reset and successfully restarted.</li> </ul>		A1/1	6	—	X	—	✘ 297	<ul style="list-style-type: none"> <li>Reset key</li> <li>Retry operation</li> </ul>	<ul style="list-style-type: none"> <li>Type A adapter</li> <li>Type A device</li> </ul>	—	—	Type A Adapter
298	Command Queue Cycle Share Machine Check <ul style="list-style-type: none"> <li>Machine check during command queue cycle share operation.</li> <li>Operation is retried. If unsuccessful, coax port disabled.</li> <li>Device status may have been lost.</li> </ul>		A1/1	7	—	X	—	✘ 298	<ul style="list-style-type: none"> <li>POR device</li> </ul>	<ul style="list-style-type: none"> <li>Type A adapter</li> <li>Type A device</li> <li>Use device logs and/3 test to isolate</li> </ul>	—	—	Type A Adapter
299	Non-Command Queue Cycle Share Machine Check <ul style="list-style-type: none"> <li>Cycle Share machine check when no command queue operation was in progress.</li> <li>CU cannot isolate failing port.</li> <li>Device status may have been lost.</li> </ul>		A1/1	8	—	X	—	✘ 299	<ul style="list-style-type: none"> <li>Reset key</li> <li>Retry operation</li> </ul>	<ul style="list-style-type: none"> <li>Type A adapter</li> </ul>			Type A Adapter
2% (2EE)	Unsupported Feature Attached <ul style="list-style-type: none"> <li>Feature is not supported with configuration selected during customizing.</li> <li>Feature did not respond when terminal was initialized.</li> <li>Keyboard ID does not match control unit keyboard table.</li> </ul>		nn/1 displays as NNN of 2EE in error log display	—	—	X	—	✘ 2%	<ul style="list-style-type: none"> <li>Reset key</li> <li>Retry operation</li> </ul>	<ul style="list-style-type: none"> <li>Machine features do not match configuration</li> <li>Feature logic error</li> <li>See heading B.2.</li> </ul>	—	—	Features

\*Where nn = port ID = 00-15

nnn Code	Error Description	Operational Indicator	Test No. for Log*	Counter Incremented	Log Only	Displayed On		Indicator Displayed	Recovery	Probable Cause/Action	Sense Codes		Applicable Feature
						All	One				SNA	Non-SNA	
310	CCA Machine Check <ul style="list-style-type: none"> <li>Control logic to CCA adapter operation error; if retry OK, is transparent to adapter control code.</li> <li>If recovery attempts are unsuccessful, the error is posted and the adapter is disabled.</li> </ul>	1001	—	—	—	X	—	X 310	● IML	● CCA adapter	—	—	CCA-BSC
311	CCA Invalid Status <ul style="list-style-type: none"> <li>Invalid basic status bit combination has been received from the CCA adapter.</li> <li>Adapter disabled.</li> </ul>	1001		—	—	X	—	X 311	● IML	● CCA adapter	—	—	CCA-BSC
320	CCA Machine Check (SDLC) <ul style="list-style-type: none"> <li>Recovery attempts have failed.</li> <li>Adapter is disabled.</li> </ul>	1001	—	—	—	X		X 320	● IML	● CCA adapter	—	—	CCA-SDLC
321	CCA Invalid Status (SDLC) <ul style="list-style-type: none"> <li>Invalid status has been received from the CCA.</li> <li>Adapter is disabled.</li> </ul>	1001		—	—	X		X 321	● IML	● CCA adapter	—	—	CCA-SDLC
326	X.21 HPCA Machine Check	1001	A0/1	4, 5 or 10	—	X		X 326	● IML	HPCA Failure: <ul style="list-style-type: none"> <li>Invalid status from HPCA (X.21 – Ctr 4)</li> <li>Unexpected status condition from HPCA (X.21 – Ctr 10)</li> <li>Overrun – Receive overrun (Ctr 4)</li> <li>Underrun (Ctr 5) was received and recovery was unsuccessful</li> </ul>	—	—	X.21

\*Where nn = port ID = 00-15

nnn Code	Error Description	Operational Indicator	Test No. for Log*	Counter Incremented	Log Only	Displayed On		Indicator Displayed	Recovery	Probable Cause/Action	Sense Codes		Applicable Feature
						All	One				SNA	Non-SNA	
330	HPCA Machine Check ● Recovery attempts have failed. ● Adapter is disabled.	1001 1001	—	—	—	X		✗ 330	● IML	● HPCA adapter	—	—	HPCA-SDLC
331	HPCA Invalid Status ● Invalid status has been received from the HPCA. ● Adapter is disabled.	1001	—	—	—	X		✗ 331	● IML	● HPCA adapter	—	—	HPCA-SDLC
332	HPCA Machine Check	1001	—	—	—	X	—	✗ 332	● IML	● HPCA adapter wrap failed. ● Adapter is disabled	—	—	Loop
333	LSA Failure	—	—	—	—	X	—	✗ 333	● IML	● LSA failure (Wrap Test) ● Adapter is disabled	—	—	Loop
334	CTS Transition or Shutoff	—	—	—	—	X		✗ 334 ✗ 334	● IML	● LSA failure ● Three shutoffs rec'd from the host ● Adapter is disabled	—	—	Loop
335	DCE Error	—	—	—	—	X		✗ 335	● IML	● LSA failure ● Adapter is disabled	—	—	Loop
336	LSC Error	—	—	—	—	X		✗ 336	● IML	● LSC failure (wrap test) ● Connecting cable ● Adapter is disabled	—	—	Loop

nnn Code	Error Description	Operational Indicators	Test No. for Log*	Counter Incremented	Log Only	Displayed On		Indicator Displayed	Recovery	Probable Cause/Action	Sense Codes		Applicable Features
						All	One				SNA	Non-SNA	
381	Control Logic Error		nn/1	—	—			X	● Device POR	● Invalid control logic command to device	—	—	All Models
	● Recoverable	—											
	● Unrecoverable	0010	A3/1	—	—	X		X	● IML	● Control logic ● Storage ● Microcode			
										<i>Note: For printers, order reject on a load PS causes a machine check 381 non-recoverable error.</i>			
382	RTM Adapter Error	1011	A2/1	15			X	X	● IML	● RTM Adapter	—	—	Models 52C, 61C
386	Overrun (Recovery unsuccessful)		nn/1	13			X	X	● Device POR	● Microcode problem suspected. ● Contact appropriate support structure ● A 3274 dump may be needed.	N/A	N/A	3290
387	Defective Diskette (Found on initialization)	1101/1111 (flashing)	nn/1	12		X		X	● Reinsert or ● Replace Diskette	● Diskette ● Diskette drive ● Diskette adapter	N/A	N/A	3290
388	Defective Diskette, Drive, or Adapter	1100/1111 (flashing)	nn/1	12			X	X	● Reinsert or ● Replace Diskette	● Diskette drive ● Diskette adapter ● Diskette	N/A	N/A	3290
389	Defective Diskette, Drive, or Adapter	1100	nn/1	11		X		X	● IML	● Diskette adapter ● Diskette drive ● Diskette	N/A	N/A	3290

\*Where nn = port ID = 00-15



nnn Code	Error Description	Operational Indicator	Test No. for Log*	Counter Incremented	Log Only	Displayed On		Indicator Displayed	Recovery	Probable Cause/Action	Sense Codes		Applicable Feature
						All	One				SNA	Non-SNA	
390	Storage Parity Error <ul style="list-style-type: none"> <li>Unrecoverable storage parity error.</li> <li>Host communications disabled.</li> </ul>	0001 or 0011 through 0111	—	—		X		✗ 390	<ul style="list-style-type: none"> <li>IML</li> </ul>	<ul style="list-style-type: none"> <li>Storage</li> <li>Control logic</li> <li>For storage card, see Figure 2-8 of Model 51C and 52C MIM and Figure 2-11 of Model 61C MIM.</li> </ul>	—	—	All
391	Control Logic Machine Check <ul style="list-style-type: none"> <li>Unrecoverable control logic error.</li> <li>Host communications disabled.</li> </ul>	0010 or 1101	—	—		X		✗ 391	<ul style="list-style-type: none"> <li>IML</li> </ul>	<ul style="list-style-type: none"> <li>Control logic</li> <li>Storage</li> <li>Microcode</li> </ul>	—	—	
392	Control Storage Error (Model 52C)	0111	A2/1	—	—		X	✗ 392	<ul style="list-style-type: none"> <li>Reset key</li> <li>Retry operation</li> </ul>	Replace card S2**	—	—	Model 52C
393	Control Storage Error (Model 52C)	0111	A2/1	—	—		X	✗ 393	<ul style="list-style-type: none"> <li>Reset key</li> <li>Retry operation</li> </ul>	Replace card T2**			Model 52C
394	Control Storage Error (Model 52C)	0111	A2/1	—	—		X	✗ 394	<ul style="list-style-type: none"> <li>Reset key</li> <li>Retry operation</li> </ul>	Replace card U2**	—	—	Model 52C
395	Control Storage Error (Model 52C)	0111	A2/1	—	—		X	✗ 395	<ul style="list-style-type: none"> <li>Reset key</li> <li>Retry operation</li> </ul>	Replace card V2**	—	—	Model 52C
397	Encrypt/Decrypt Adapter Permanent Error <ul style="list-style-type: none"> <li>All attempts for recovery have been exhausted.</li> <li>Adapter disabled.</li> <li>Non-Encrypt/Decrypt operations may be run.</li> </ul>	1110	A3/1	3	—		X	✗ 397	<ul style="list-style-type: none"> <li>IML</li> </ul>	<ul style="list-style-type: none"> <li>Encrypt/Decrypt logic</li> </ul>	0848	—	Encrypt/Decrypt
398	Encrypt/Decrypt Parity Error <ul style="list-style-type: none"> <li>Master key parity error.</li> <li>Retry attempts failed.</li> <li>Adapter is disabled.</li> <li>Non-Encrypt/Decrypt operations may be run.</li> </ul>		A2/1	9	—		X	✗ 398	<ul style="list-style-type: none"> <li>IML</li> <li>Enter master key</li> </ul>	<ul style="list-style-type: none"> <li>Weak or defective battery</li> <li>Refer to master key entry and verification procedure.</li> </ul>	0848	—	Encrypt/Decrypt

\*Where nn = port ID = 00-15

\*\*See code 0111 in Figure 2-8 of Model 51C and 52C MIM and in Figure 2-11 of Model 61C MIM.

nnn Code	Error Description	Operational Indicator	Test No. for Log*	Counter Incremented	Log Only	Displayed On		Indicator Displayed	Recovery	Probable Cause/Action	Sense Codes		Applicable Feature
						All	One				SNA	Non-SNA	
399	Encrypt/Decrypt Adapter Failure <ul style="list-style-type: none"> <li>● Retry attempts failed.</li> <li>● Adapter is disabled.</li> <li>● Non-Encrypt/Decrypt operations may still be run.</li> </ul>		A2/1	10	—		X	✗ 399	● IML	● Encrypt/Decrypt logic	0848		Encrypt/Decrypt
401	Command Reject	—	A0/1	—	—	—	X	— ✗ PRDG 401	Reset and retry  Host recovery	a. Invalid command received.  b. SFE, MF, SA order with invalid alias.	a. 1003  b. 0863	Com Rej  Op Chk	All Models
402	Invalid Addressing	—	—	—	—		X	— ✗ PRDG 402	Reset and retry  Host recovery	a. Invalid (out-of-range) address received with SBA, RA, EUA order.  b. MF order did not address field-attribute position.	a. 1005  b. 0863	Com Rej  Op Chk	BSC SDLC
403	Incorrect Command Format or Invalid Order Parameters		nn/1	—	—	—	X	— ✗ PRDG 403	Reset and retry  Host recovery (correct data stream)	a. Rd, Rd Mod, or EAU command with data following was received.  b. SFE, MF, SA, GE, or RA order with invalid parameters was received.	1003	Op Chk	BSC SDLC
404	Incomplete Order		nn/1	—	—	—	X	— ✗ PRDG 404	Reset and retry  Host recovery (correct the data stream)	a. Required bytes not received for an SBA, RA, EUA, SF, SFE, MF, or SA order.	1005	Op Chk	BSC SDLC
405	Invalid Copy Command <ul style="list-style-type: none"> <li>● BSC generates an operation check.</li> </ul>		nn/1	—	—	—	X	— ✗ PRDG 405	● Host recovery ● Reset key ● Retry operation	● Host has sent a copy command with invalid parameters.	—	Op Chk	CCA-BSC
406	Invalid Command Sequence <ul style="list-style-type: none"> <li>● Invalid command sequence was detected.</li> </ul>		nn/1	—	—	—	X	✗ PRDG 406	● Reset key ● Retry operation	● A CCW was chained to a write CCW that had the start print bit set in the WCC.	—	Op Chk	BSC

\*Where nn = port ID = 00-15

nnn Code	Error Description	Operational Indicator	Test No. for Log*	Counter Incremented	Log Only	Displayed On		Indicator Displayed	Recovery	Probable Cause/Action	Sense Codes		Applicable Feature
						All	One				SNA	Non-SNA	
408	(BSC) Count Exceeded <ul style="list-style-type: none"> <li>Adapter read buffer unavailable.</li> <li>Sense/status set to OPCHECK and EOT sent to host.</li> </ul>		A0/1	10	—	—	X	✗ PRDG 408	<ul style="list-style-type: none"> <li>Reset key</li> <li>Retry operation</li> </ul>	<ul style="list-style-type: none"> <li>3274 unable to handle host data stream</li> <li>Data stream has excessive program tab orders</li> </ul>	—	Op Ck	BSC
411	RU Length Error <ul style="list-style-type: none"> <li>LU1 RU is greater than BIND specification.</li> </ul>		nn/1	—	—	—	X	✗ PRDG 411	<ul style="list-style-type: none"> <li>Reset key</li> <li>Retry operation</li> </ul>	<ul style="list-style-type: none"> <li>Host software</li> </ul>	1002	—	SNA
412	Short Record <ul style="list-style-type: none"> <li>Program check.</li> <li>A 'short' record was detected.</li> <li>Control unit sends SNA a negative response of X'1002', RU length error.</li> </ul>		nn/1	—	—	—	X	✗ PRDG 412	<ul style="list-style-type: none"> <li>Reset key</li> <li>Retry operation</li> </ul>	<ul style="list-style-type: none"> <li>Host software</li> </ul>	1002		SNA
413	Function Not Supported <ul style="list-style-type: none"> <li>Crypto verification (CRV) received, but no crypto session has been established.</li> <li>See Note 1.</li> </ul>	—	nn/1	—			X	✗ PRDG 413	<ul style="list-style-type: none"> <li>Reset key</li> <li>Retry operation</li> </ul>	<ul style="list-style-type: none"> <li>Host software</li> <li>Procedural error</li> </ul>	1003	—	SNA Encrypt/ Decrypt
414	Encrypt/Decrypt Data Error <ul style="list-style-type: none"> <li>SNA program check.</li> <li>Invalid pad count or non-modulo-8 RU has been received during an Encrypt/Decrypt session.</li> </ul>		nn/1	—	—	—		✗ PRDG 414	<ul style="list-style-type: none"> <li>Reset key</li> <li>Retry operation</li> <li>Inform Host support program</li> <li>Non-Encrypt/Decrypt operations may be run</li> </ul>	<ul style="list-style-type: none"> <li>Host software</li> <li>Procedural error</li> </ul>	1001	—	SNA Encrypt/ Decrypt

\*Where nn = port ID = 00-15

nnn Code	Error Description	Operational Indicator	Test No. for Log*	Counter Incremented	Log Only	Displayed On		Indicator Displayed	Recovery	Probable Cause/Action	Sense Codes		Applicable Feature
						All	One				SNA	Non-SNA	
420	Exception Response Not Allowed ● SNA program check	—	nn/1	—			X	✗ PROG 420	<ul style="list-style-type: none"> <li>● Reset key</li> <li>● Retry operation</li> <li>● Inform Host support program</li> </ul>	<ul style="list-style-type: none"> <li>● Host has sent invalid or incorrect data</li> <li>● LIC carried exception response when BIND specified definite response</li> </ul>	4006	—	SNA
421	Definite Response Not Allowed ● SNA program check	—	nn/1	—			X	✗ PROG 421	<ul style="list-style-type: none"> <li>● Reset key</li> <li>● Retry operation</li> <li>● Inform Host support program</li> </ul>	<ul style="list-style-type: none"> <li>● Host has sent invalid or incorrect data</li> <li>● LIC carried definite response when BIND specified exception response</li> </ul>	4007	—	SNA
422	No Response Not Allowed ● Program check	—	nn/1	—			X	✗ PROG 422	<ul style="list-style-type: none"> <li>● Reset key</li> <li>● Retry operation</li> <li>● Inform Host support program</li> </ul>	<ul style="list-style-type: none"> <li>● Host software</li> </ul>	400A	—	SNA
423	FI (Format Indicator) Bit Not Allowed ● Program check	—	nn/1	—			X	✗ PROG 423	<ul style="list-style-type: none"> <li>● Reset key</li> <li>● Retry operation</li> <li>● Inform Host support program</li> </ul>	<ul style="list-style-type: none"> <li>● Host software</li> </ul>	400F	—	SNA
430	Sequence Number Error ● SNA program check	—	nn/1	—			X	✗ PROG 430	<ul style="list-style-type: none"> <li>● Reset key</li> <li>● Retry operation</li> <li>● Inform Host support program</li> </ul>	<ul style="list-style-type: none"> <li>● Host software</li> </ul>	2001	—	SNA
431	Chaining Error ● SNA program check	—	nn/1	—	—		X	✗ PROG 431	<ul style="list-style-type: none"> <li>● Reset key</li> <li>● Retry operation</li> <li>● Inform Host support program</li> </ul>	<ul style="list-style-type: none"> <li>● Host software</li> <li>● Brackets incorrectly used</li> </ul>	2002	—	SNA

\*Where nn = port ID = 00-15

nnn Code	Error Description	Operational Indicator	Test No. for Log*	Counter Incremented	Log Only	Displayed On		Indicator Displayed	Recovery	Probable Cause/Action	Sense Codes		Applicable Feature
						All	One				SNA	Non-SNA	
432	Bracket Error ● SNA program check	—	nn/1	—	—		X	✗ PROG 432	<ul style="list-style-type: none"> <li>● Reset key</li> <li>● Retry operation</li> <li>● Inform Host support program</li> </ul>	<ul style="list-style-type: none"> <li>● Host software</li> <li>● Brackets incorrectly used</li> </ul>	2003	—	SNA
433	Data Traffic Reset ● SNA program check	—	nn/1	—	—		X	✗ PROG 433	<ul style="list-style-type: none"> <li>● Reset key</li> <li>● Retry operation</li> <li>● Inform Host support program</li> </ul>	<ul style="list-style-type: none"> <li>● Host software</li> </ul>	2005	—	SNA
434	Half-Duplex Error (Direction Error) ● SNA program check	—	nn/1	—	—		X	✗ PROG 434	<ul style="list-style-type: none"> <li>● Reset key</li> <li>● Retry operation</li> <li>● Inform Host support program</li> </ul>	<ul style="list-style-type: none"> <li>● Host software</li> <li>● Normal Flow request was received by SNA while in half-duplex Send state.</li> </ul>	2004	—	SNA
439	Encrypt/Decrypt Protocol Violation ● SNA program check		nn/1	—	—		X	✗ PROG 439	<ul style="list-style-type: none"> <li>● Reset key</li> <li>● Retry operation</li> <li>● Inform Host support program</li> <li>● Non-Encrypt/Decrypt operations may be run</li> </ul>	<ul style="list-style-type: none"> <li>● Host software</li> <li>● An invalid CRU has been received.</li> </ul>	2009	—	SNA Encrypt/Decrypt
440	Session Limit Exceeded ● SNA program check	—	nn/1	—	X			none	<ul style="list-style-type: none"> <li>● Reset key</li> <li>● Retry operation</li> <li>● Inform Host support program</li> <li>● Non-Encrypt/Decrypt operations may be run</li> </ul>	<ul style="list-style-type: none"> <li>● Host software</li> </ul>	0805	—	SNA

\*Where nn = port ID = 00-15

nnn Code	Error Description	Operational Indicator	Test No. for Log*	Counter Incremented	Log Only	Displayed On		Indicator Displayed	Recovery	Probable Cause/Action	Sense Codes		Applicable Feature
						All	One				SNA	Non-SNA	
441	Bracket Bid Reject No Ready to Receive (RTR) Returned or Receiver in Transmit ● SNA program check	—	nn/1	—	X			none	● Reset key ● Retry operation ● Inform Host support program ● Non-Encrypt/Decrypt operations may be run	● Host software	0813 or 081B	— —	SNA
442	Request Not Executable ● SNA program check ● Function request cannot be executed because of a permanent hardware error.	—	nn/1	—	—			✗ PROG 442	● Device POR	● Terminal error - refer to 2nn portion of /1 test.	081C	—	SNA
443	Change Direction Required ● SNA program check	—	nn/1	—	—		X	✗ PROG 443	● Device POR	● Host software ● Request required a Normal Flow reply, but SNA in Receive state.	0829	—	SNA
444	Session Already Bound ● SNA Program Check	—	nn/1	—	X			—	● Device POR	● Host software	0815	—	SNA
445	ACTLU not supported	—	xx/1	3	—		X	✗ PROG 445	● Press Reset	● Invalid ACTLU parameters	081C	—	SNA
450	Bind Reject-Profile Error ● SNA program check: invalid session parameter.	—	nn/1	—	—		X	✗ PROG 450	● Reset key ● Retry operation ● Inform Host support program	● Host software	0821	—	SNA
451	Bind Reject-Primary Protocol Error ● SNA program check: invalid session parameter.	—	nn/1	—	—		X	✗ PROG 451	● Reset key ● Retry operation ● Inform Host support program	● Host software	0821	—	SNA
452	Bind Reject-Secondary Protocol Error ● SNA program check: invalid session parameter.	—	nn/1	—	—		X	✗ PROG 452	● Reset key ● Retry operation ● Inform Host support program	● Host software	0821	—	SNA

\*Where nn = port ID = 00-15

nnn Code	Error Description	Operational Indicator	Test No. for Log*	Counter Incremented	Log Only	Displayed On		Indicator Displayed	Recovery	Probable Cause/Action	Sense Codes		Applicable Feature
						All	One				SNA	Non-SNA	
453	Bind Reject-Common Protocol Error ● SNA program check: invalid session parameter	—	nn/1	—	—		X	✗ PROG 453	● Reset key ● Retry operation ● Inform Host support program	● Host software	0821	—	SNA
454	Bind Reject-Screen Size Spec. Error ● SNA program check: invalid session parameter	—	nn/1	—	—		X	✗ PROG 454	● Reset key ● Retry operation ● Inform Host support program	● Host software	0821	—	SNA
455	Bind Reject-LU Profile Error ● SNA program check: invalid session parameter	—	nn/1	—	—		X	✗ PROG 455	● Reset key ● Retry operation ● Inform Host support program	● Host software	0821	—	SNA
456	Bind Reject-LU1 Error ● SNA program check: invalid session parameter	—	nn/1	—	—		X	✗ PROG 456	● Reset key ● Retry operation ● Inform Host support program	● Host software	0821	—	SNA
457	Bind Reject-Encrypt/Decrypt Parameter Error ● SNA program check		nn/1	—	—	—	X	✗ PROG 457	● Reset key ● Retry operation ● Inform Host support program ● Non-Encrypt/Decrypt operations may be run	● Host software ● Bind specification for Encrypt/Decrypt had an error in byte 26 or 27, Encrypt/Decrypt was specified, and the Encrypt/Decrypt feature is not present, or a CRV was specified in CRV invalid.	0821	—	SNA Encrypt/ Decrypt

\*Where nn = port ID = 00-15

nnn Code	Error Description	Operational Indicator	Test No. for Log*	Counter Incremented	Log Only	Displayed On		Indicator Displayed	Recovery	Probable Cause/Action	Sense Codes		Applicable Feature
						All	One				SNA	Non-SNA	
458	Bind Reject-Encrypt/Decrypt Test	—	nn/1	—	—		X	✗ PROG 458	<ul style="list-style-type: none"> <li>● Host recovery or</li> <li>● Control Unit key must be changed (the customer's security administrator should be notified)</li> <li>● Non-Encrypt/Decrypt operations may be run</li> </ul>	<ul style="list-style-type: none"> <li>● The test value (N) from the host does not match the one sent by the 3274.</li> <li>● There is a master key mismatch between the host and the 3274.</li> <li>● See <i>Planning and Setup Guide</i>.</li> </ul>	0821	—	SNA Encrypt/ Decrypt
460	Printer Authorization Matrix Error	—		—	—		X	✗ PROG 460	<ul style="list-style-type: none"> <li>● Reset key</li> <li>● Retry operation</li> </ul>	<ul style="list-style-type: none"> <li>● An invalid print matrix was sent from the host, or the Load key was hit at a time when the matrix was not on the screen.</li> </ul>			SNA BSC
470	Unsupported Order	—	—	—	—		X	✗ PROG 470	<ul style="list-style-type: none"> <li>● Reset key</li> <li>● Retry operation</li> <li>● Fix application program</li> </ul>	<ul style="list-style-type: none"> <li>● Host software error.</li> <li>● An unsupported order was decoded in the SFAP data stream.</li> </ul>	1003	Op Ck	SNA BSC
471	SFAP (Structured Field and Attribute Processing) Data Stream Error	—	—	—	—		X	✗ PROG 471	<ul style="list-style-type: none"> <li>● Reset key</li> <li>● Retry operation</li> <li>● Fix application program</li> </ul>	<ul style="list-style-type: none"> <li>● Host software error.</li> <li>● See heading B.3.</li> </ul>	1003 or 1005	Op Ck	SNA BSC
472	Read Partition Structured Field State Error	—	—	—	—		X	✗ PROG 472	<ul style="list-style-type: none"> <li>● Reset key</li> <li>● Retry operation</li> <li>● Fix application program</li> </ul>	<ul style="list-style-type: none"> <li>● Host software error.</li> </ul>	0871	Op Ck	SNA BSC

\*Where nn = port ID = 00-15







nnn Code	Error Description	Operational Indicator	Test No. for Log*	Counter Incremented	Log Only	Displayed On		Indicator Displayed	Recovery	Probable Cause/Action	Sense Codes		Applicable Feature
						All	One				SNA	Non-SNA	
473	PS Addressing Error	—	—	—	—		X	✗ PROG 473	<ul style="list-style-type: none"> <li>● Reset key</li> <li>● Retry operation</li> <li>● Fix application program</li> </ul>	<ul style="list-style-type: none"> <li>● Host software error.</li> <li>● See heading B.3.</li> </ul>	084C	Op Ck	SNA BSC
474	No Extended DCB Configured for This Device	—	—	—	—		X	✗ PROG 474	<ul style="list-style-type: none"> <li>● SFAP data stream should not be sent to this device</li> </ul>	<ul style="list-style-type: none"> <li>● SFAP data stream send — no extended DCB available.</li> </ul>	1003	Op Ck	SNA BSC
475	WCC has Start Print Bit Set but Not Last Structured Field	—	nn/1				X	✗ PROG 475	<ul style="list-style-type: none"> <li>● Reset key</li> <li>● Retry operation</li> <li>● Application Program Error</li> </ul>	<ul style="list-style-type: none"> <li>● Host software</li> </ul>	1001	Op Ck	SNA BSC
476	Transmission Block Size Exceeded	—	—	—	—		X	✗ PROG 476	<ul style="list-style-type: none"> <li>● Reset key</li> <li>● Retry operation</li> </ul>	<ul style="list-style-type: none"> <li>● Check Application Program</li> </ul>	N/A	Op Ck	3290
488	Invalid Data Stream in Kanji/Chinese field	—	nn/1	—	—		X	✗ PROG 488	<ul style="list-style-type: none"> <li>● Reset key</li> <li>● Retry operation</li> <li>● Inform Host support program</li> </ul>	<ul style="list-style-type: none"> <li>● Host software</li> </ul>	1003	—	Model 52C
489	Invalid Data Stream in Kanji/Chinese field	—	nn/1	—	—		X	✗ PROG 489	<ul style="list-style-type: none"> <li>● Reset key</li> <li>● Retry operation</li> <li>● Inform Host support program</li> </ul>	<ul style="list-style-type: none"> <li>● Host software</li> </ul>	1005		Model 52C
498	Negative Response Received <ul style="list-style-type: none"> <li>● SNA program check</li> <li>● No SNA sense returned</li> </ul>	—	nn/1	—	—		X	✗ PROG 498	<ul style="list-style-type: none"> <li>● Reset key</li> <li>● Retry operation</li> <li>● Inform Host support program</li> </ul>	<ul style="list-style-type: none"> <li>● Host software</li> </ul>	—	—	SNA
499	Exception Request <ul style="list-style-type: none"> <li>● SNA program check</li> <li>● No SNA sense returned</li> </ul>	—	nn/1	—	—		X	✗ PROG 499	<ul style="list-style-type: none"> <li>● Reset key</li> <li>● Retry operation</li> <li>● Inform Host support program</li> </ul>	<ul style="list-style-type: none"> <li>● Host software</li> </ul>	—	—	SNA

\*Where nn = port ID = 00-15

nnn Code	Error Description	Operational Indicator	Test No. for Log*	Counter Incremented	Log Only	Displayed On		Indicator Displayed	Recovery	Probable Cause/Action	Sense Codes		Applicable Feature
						All	One				SNA	Non-SNA	
501	● 3274 Data Set Ready Line Dropped	—	A0/1	— (SDLC) 9 (SDLC) 10 or 11 (X.25)	—	X	—	✗ → 501	● Indicator is reset when DSR is restored ● Reset keyboard ● Retry operation	● Missing DSR ● Check data set ● Check modem cable wrap switch	—	—	SDLC, BSC
	● 3274 Loop LOCAL/ COMMUNICATE Switch in LOCAL	—	—	—	—	X	—	✗ → 501	● Set LOCAL/ COMM Switch to COMM	● LOCAL COMM Switch in LOCAL	—	—	Loop
502	Clear to Send Not Present ● Clear to Send not present while request to send was on ● Adapter indicates DCE error or write timeout ● DSR is up	—	A0/1	10 or 11 (X.25)	—	X	—	✗ → 502	● Reset key ● Retry operation	● Check data set ● Run wrap test ● Check -8.5 V,F4	—	—	BSC SDLC
504	Switched Network Connection Required (Disc Received)	—	A0/1 (X.25)	X.25 Counter 3	—	X	—	✗ → 504	● A connection should be initiated from the control unit or host.	● Initial status of Control Unit at IML. ● Operator Disconnected. ● DISC received from network. ● Three idle time-outs in succession.	—	—	Switched Network
505	3274 Disconnected from Network.	—	—	—	—	X	—	✗ → 505	● SNRM required from network or X.25 contact required.	● Normal state after IML or disconnect has been received. ● If 505 is displayed for a long time notify the system operator.	—	—	SNA X.25



\*Where nn = port ID = 00-15

nnn Code	Error Description	Operational Indicator	Test No. for Log*	Counter Incremented	Log Only	Displayed On		Indicator Displayed	Recovery	Probable Cause/Action	Sense Codes		Applicable Feature
						All	One				SNA	Non-SNA	
506	<ul style="list-style-type: none"> <li>Waiting for DCE Ready</li> </ul>	—	—	—	—	X	—	 506	<ul style="list-style-type: none"> <li>None. This is normal startup.</li> <li>If 506 is displayed for a long time validate proper operation of the X.25 network.</li> </ul>	<ul style="list-style-type: none"> <li>The 3274 is in process of connecting to the X.25 network.</li> <li>For PVC, the circuit and link have yet not been opened for traffic.</li> <li>For SVC, the link has yet not been opened.</li> </ul>	—	—	X.25
507	No Carrier	—	A0/1	14	—	X	—	 507	<ul style="list-style-type: none"> <li>Refer to nnn code 515, 332, 333, or 336.</li> </ul>	<ul style="list-style-type: none"> <li>Carrier down (no RLSD) for the last 4 seconds.</li> <li>Wrap tests are performed if IML tests are successful. Beaconsing is initiated. See nnn code 515.</li> <li>If wrap tests fail, 332, 333, or 336 is displayed.</li> </ul>	—	—	Loop
508	CNFG RCVD —Monitor Mode	—	—	—	—	X	—	 508	<ul style="list-style-type: none"> <li>CNFG command or Reset or Clear required from host to return to online.</li> </ul>	<ul style="list-style-type: none"> <li>CNFG command from host indicated to enter Monitor mode.</li> </ul>	—	—	Loop
509	CNFG RCVD Suppress Carrier Mode	—	—	—	—	X	—	 509	<ul style="list-style-type: none"> <li>CNFG command or Reset or Clear required from host to return to online.</li> </ul>	<ul style="list-style-type: none"> <li>CNFG command from host indicated to suppress carrier.</li> <li>Station suppresses carrier.</li> </ul>	—	—	Loop
510	Physical Unit Not Active	—	—	—	—	X	—	 510	<ul style="list-style-type: none"> <li>Host issue ACTPU</li> <li>Retry operation</li> </ul>	<ul style="list-style-type: none"> <li>ACTPU is required from host.</li> </ul>	—	—	SDLC, SNA Loop, X.25

\*Where nn = port ID = 00-15



nnn Code	Error Description	Operational Indicator	Test No. for Log*	Counter Incremented	Log Only	Displayed On		Indicator Displayed	Recovery	Probable Cause/Action	Sense Codes		Applicable Feature
						All	One				SNA	Non-SNA	
513	Channel not available	—	A0/1	X.25 Counter 24	—	X	—	X <del>↘</del> 513	<ul style="list-style-type: none"> <li>● If an outgoing call was being attempted, retry.</li> <li>● If no outgoing call was being attempted, wait for network to retry.</li> <li>● If 513 is displayed for a long time, or if the number of retries is excessive, validate proper operation of the X.25 network.</li> </ul>	<ul style="list-style-type: none"> <li>● The X.25 was attempting to initiate an outgoing call and a CLEAR was received from the network.</li> <li>● There has been activity on the channel normally on incoming calls (e.g. CLEAR received) that has prohibited the 3274 from completing the connection (channel in invalid state).</li> </ul>	—	—	X.25
515	Beaconing	—	—	—	—	X	—	X <del>↘</del> 515	<ul style="list-style-type: none"> <li>● Carrier from the loop is required.</li> </ul>	<ul style="list-style-type: none"> <li>● A "no carrier" condition was detected on the loop. See nnn code 507.</li> <li>● Loop tests were successfully run.</li> <li>● Beacon commands were transmitted, and carrier is monitored.</li> <li>● The loop is performing problem determination.</li> </ul>	—	—	Loop

\*Where nn = port ID = 00-15

nnn Code	Error Description	Operational Indicator	Test No. for Log*	Counter Incremented	Log Only	Displayed On		Indicator Displayed	Recovery	Probable Cause/Action	Sense Codes		Applicable Feature
						All	One				SNA	Non-SNA	
517	DCE not available/ open timeout	—	A0/1	X.25 Counter 4	—	X	—	X  517	<ul style="list-style-type: none"> <li>The 3274 is re-trying. Wait.</li> <li>If the problem persists, verify proper operation of the X.25 network.</li> </ul>	<ul style="list-style-type: none"> <li>Disconnect mode (DM) was received from the X.25 network in response to a SABM** by the 3274, or</li> <li>The 3274 waited approx. 25 seconds while trying to connect to the DCE and no activity (Flags) were detected on the communication lines.</li> </ul>	—	—	X.25
518	Segmenting Error <ul style="list-style-type: none"> <li>The terminal is closed and reopened.</li> <li>All physical and logical units are deactivated.</li> </ul>	—	—	—	—	X	—	X  518	<ul style="list-style-type: none"> <li>An SNRM is required from the host.</li> </ul>	<ul style="list-style-type: none"> <li>An SNA segment was received with improper sequencing in the TH MPF bits.</li> </ul>	—	—	SDLC
519	Count Exceeded/Wrong Length Message	—	A0/1	12	—	X	—	X  519	<ul style="list-style-type: none"> <li>Host recovery</li> </ul>	<ul style="list-style-type: none"> <li>CCA: Host sent a message larger than the control unit buffer.</li> <li>HPCA: Host sent a message larger than the CU buffer. Receive count will not be updated, causing retransmission by host.</li> <li>Improper buffer size specified in NCP.</li> </ul>	Com Rej	—	SDLC Loop

\*Where nn = port ID = 00-15

\*\*Set Asynchronous Balanced Mode (Command)

nnn Code	Error Description	Operational Indicator	Test No. for Log*	Counter Incremented	Log Only	Displayed On		Indicator Displayed	Recovery	Probable Cause/Action	Sense Codes		Applicable Feature
						All	One				SNA	Non-SNA	
520	Nonproductive Timeout  Receive Timeout	—	A0/1	1	—	X	—	 520	<ul style="list-style-type: none"> <li>Reset by receipt of a valid frame or a frame containing a poll.</li> <li>The 3274 is waiting for the X.25 network to recover, or if trying to open the link, is itself trying to recover. Wait.</li> <li>If the problem persists, verify proper X.25 network operation.</li> </ul>	<ul style="list-style-type: none"> <li>No valid SDLC frames received in last 20-25 seconds.</li> <li>Line may be inoperable at "space" or valid data character.</li> <li>Communication network problem.</li> <li>The 3274 has not received a valid frame from the X.25 network within the last 30 seconds.</li> </ul>	—	—	SDLC Loop  X.25
521	Idle Timeout  <ul style="list-style-type: none"> <li>No activity on line for last 20 seconds (no flags received)</li> </ul>	—	A0/1	2	—	X	—	 521	<ul style="list-style-type: none"> <li>Reset by receipt of a valid frame or a frame containing a poll.</li> </ul>	<ul style="list-style-type: none"> <li>No host activity</li> <li>Verify operational status of communication network.</li> </ul>	—	—	SDLC
522	Receive Overrun	—	A0/1	4	—	X	—	 522	<ul style="list-style-type: none"> <li>Receipt of a valid frame.</li> </ul>	<ul style="list-style-type: none"> <li>Control Unit Read-control buffer overflows.</li> <li>Line may be hung at space or invalid data character.</li> </ul>	—	—	Loop

\*Where nn = port ID = 00-15

nnn Code	Error Description	Operational Indicator	Test No. for Log*	Counter Incremented	Log Only	Displayed On		Indicator Displayed	Recovery	Probable Cause/Action	Sense Codes		Applicable Feature
						All	One				SNA	Non-SNA	
525	<p>Connection Problem</p> <ul style="list-style-type: none"> <li>Condition exists on lines that prevent establishing or reestablishing communication with host.</li> <li>Status is posted after 20 ROLs, 20 CRs, 20 XIDs, or 20 NSAs</li> </ul>	—	A0/1	6	—	X	—	X → 525	<ul style="list-style-type: none"> <li>Host recovery</li> </ul>	<ul style="list-style-type: none"> <li>Communication problem between host and control unit.</li> </ul>	—	—	SDLC Loop
527	Write Timeout	—	A0/1	3	—	X	—	X → 527	<ul style="list-style-type: none"> <li>IML</li> </ul>	<ul style="list-style-type: none"> <li>Write timeout condition occurred.</li> <li>Wrap tests were run.</li> <li>If wrap fails, 332, 333, or 336 is displayed.</li> <li>Station is closed.</li> </ul>	—	—	Loop
528	<p>Command Reject</p> <ul style="list-style-type: none"> <li>ALL PUs and LUs are deactivated.</li> </ul>		A0/1	9	—	X	—	X → 528	<ul style="list-style-type: none"> <li>Host recovery</li> <li>SNRM required</li> <li>Inform Host support programmer</li> </ul>	<ul style="list-style-type: none"> <li>Adapter received invalid NR sequence count in an information or supervisory frame with good FCS.</li> <li>Received command with data that has no data field defined.</li> <li>Received an undefined or non-implemented command field in a frame with good FCS.</li> </ul>	—	—	SDLC Loop

\*Where nn = port ID = 00-15

nnn Code	Error Description	Operational Indicator	Test No. for Log*	Counter Incremented	Log Only	Displayed On		Indicator Displayed	Recovery	Probable Cause/Action	Sense Codes		Applicable Feature
						All	One				SNA	Non-SNA	
529	DCE Error <ul style="list-style-type: none"> <li>Unexpected communication error has occurred.</li> <li>Host adapter is disabled, and an attempt is made to enable it again.</li> </ul>		A0/1	10	—	X	—	<del>X</del> 529	<ul style="list-style-type: none"> <li>Host recovery</li> <li>SNRM required or contact (X.25)</li> </ul>	<ul style="list-style-type: none"> <li>DCE error other than the loss of DSR (nnn 501) or of CTS (nnn 502). Problem could be in:               <ol style="list-style-type: none"> <li>3274 HPCA</li> <li>DCE or</li> <li>DCE cable</li> </ol> </li> <li>Run wrap test to check 3274 HPCA.</li> <li>Check modem.</li> </ul>	—	—	SDLC X.25
530	Write Timeout <ul style="list-style-type: none"> <li>Microcode has issued a command to the CCA, and, after 1 second, no acknowledgment has been received.</li> <li>In SDLC, host adapter is disabled and an attempt is made to enable it again.</li> <li>All PUs and LUs are deactivated.</li> </ul>		A0/1	11-HPCA CCA-SDLC 8-CCA-BSC	—	X	—	<del>X</del> 530	<ul style="list-style-type: none"> <li>Host recovery</li> <li>SNRM required or contact (X.25)</li> </ul>	<ul style="list-style-type: none"> <li>DSR is OK.</li> <li>CTS may have dropped during transmission, or clocking signal is not available from modem. Problem could be in:               <ol style="list-style-type: none"> <li>3274 HPCA</li> <li>DCE or</li> <li>DCE cable</li> </ol> </li> <li>Run wrap test to check 3274 HPCA.</li> <li>Check modem.</li> </ul>	—	—	SDLC BSC X.25

\*Where nn = port ID = 00-15





nnn Code	Error Description	Operational Indicator	Test No. for Log*	Counter Incremented	Log Only	Displayed On		Indicator Displayed	Recovery	Probable Cause/Action	Sense Codes		Applicable Feature
						All	One				SNA	Non-SNA	
531	NAK Sent <ul style="list-style-type: none"> <li>The contents of the screen are restored to their initial state on detection of the error.</li> </ul>		A0/1	1	—	—	X	✗ <del>531</del> 531	<ul style="list-style-type: none"> <li>Host recovery</li> <li>Retransmit data</li> <li>The Communication Reminder will be turned off upon successful retry from the host.</li> </ul>	<ul style="list-style-type: none"> <li>Adapter detected BCC error on a received message block.</li> <li>During a read operation, 3 seconds elapsed without receipt of SYN, ETX, or ETB.</li> <li>A forward abort (ENQ in text) or TTD (STX ENQ) is received.</li> <li>Verify proper operation of the communication network.</li> </ul>	—	—	BSC
532	BSC Line Idle <ul style="list-style-type: none"> <li>Adapter detected seven successive 3-second intervals without SYN characters on the line while in ADPREP mode (monitor line for poll or selection sequence)</li> </ul>		A0/1	—	—	X	—	✗ <del>532</del> 532	<ul style="list-style-type: none"> <li>Host recovery</li> <li>Reset by valid poll or selection sequence</li> </ul>	<ul style="list-style-type: none"> <li>No host data being received.</li> <li>Run wrap test.</li> <li>Verify communication network operation.</li> </ul>	—	—	BSC
533	ENQ Received <ul style="list-style-type: none"> <li>CCA was overrun during a read operation, and data was lost when the ENQ was received. The control unit will retransmit its last response. The host should retransmit the message that was lost, <i>or</i></li> <li>ENQ character received while adapter was waiting for STX or SOH (entire message lost)</li> <li>Retransmit last response</li> <li>Host will retransmit last message</li> </ul>		A0/1	3	—	—	X	✗ <del>533</del> 533	<ul style="list-style-type: none"> <li>Host recovery</li> <li>Retransmit last message</li> </ul>	<ul style="list-style-type: none"> <li>Communication error.</li> <li>CCA adapter.</li> <li>Run wrap test.</li> </ul>	—	—	BSC

\*Where nn = port ID = 00-15

nnn Code	Error Description	Operational Indicator	Test No. for Log*	Counter Incremented	Log Only	Displayed On		Indicator Displayed	Recovery	Probable Cause/Action	Sense Codes		Applicable Feature
						All	One				SNA	Non-SNA	
534	Control Unit Sent 15 ENQ <ul style="list-style-type: none"> <li>Host did not return an ACK for last transmitted text block.</li> <li>Adapter sent 15 ENQs to attempt to solicit an ACK with no response</li> <li>EOT sent to host, <i>or</i></li> <li>The control unit has acknowledged a selection sequence and has not seen a syn (pad syn) for 45 seconds.</li> <li>Adapter continues to monitor for a synchronization.</li> </ul>		A0/1	4	—	X	—	✗ → 534	<ul style="list-style-type: none"> <li>Host recovery</li> <li>A valid poll or selection will reset symbol</li> <li>Retry operation</li> </ul>	<ul style="list-style-type: none"> <li>Host failed to respond.</li> <li>Communication failure.</li> <li>Run wrap test.</li> </ul>	—	—	BSC
535	15 NAKs Received <ul style="list-style-type: none"> <li>Text block failed to reach host after 15 attempts.</li> <li>EOT is sent to host.</li> <li>Control unit enters ADPREP mode (line monitor for poll or selection).</li> </ul>	—	A0/1	5	—	X	—	✗ → 535	<ul style="list-style-type: none"> <li>Host recovery</li> <li>Valid poll or selection will reset symbol</li> <li>Retry operation</li> </ul>	<ul style="list-style-type: none"> <li>Communication failure between host and control unit.</li> <li>Verify communication network operation.</li> <li>Run wrap test.</li> </ul>	—	—	BSC
536	Error Description 15 Wrong Acknowledge <ul style="list-style-type: none"> <li>Adapter received wrong ACK in response to text block transmission (ACK0 for ACK1 or vice versa), sent ENQ for repeat of ACK, and received wrong ACK 15 times.</li> <li>EOT is sent to host.</li> <li>Control unit enters ADPREP mode (line monitor for poll or selection).</li> </ul>	—	A0/1	6	—	X	—	✗ → 536	<ul style="list-style-type: none"> <li>Host recovery</li> <li>A valid poll or selection will reset symbol</li> <li>Retry operation</li> </ul>	<ul style="list-style-type: none"> <li>Host to control unit communication error (dropped a complete record during transmission).</li> <li>Host returns wrong ACK.</li> </ul>	—	—	BSC

\*Where nn = port ID = 00-15

nnn Code	Error Description	Operational Indicator	Test No. for Log*	Counter Incremented	Log Only	Displayed On		Indicator Displayed	Recovery	Probable Cause/Action	Sense Codes		Applicable Feature
						All	One				SNA	Non-SNA	
537	Call Timeout	—	A0/1	X.25 Counter 17	—	X	—	X  537	<ul style="list-style-type: none"> <li>• The COMM key may be used to reset the nnn.</li> <li>• If in Call Ready state, the call may be retried via a DIAL key sequence.</li> <li>• If the problem persists, verify proper operation of the X.25 network.</li> </ul>	<ul style="list-style-type: none"> <li>• The 3274 waited for a response to a Call Request packet and a timeout occurred.</li> </ul>	—	—	X.25
538	Packet Timeout	—	A0/1	2	—	X	—	X  538	<ul style="list-style-type: none"> <li>• The 3274 is waiting for the X.25 network to recover or, if attempting to open the link, and is itself trying to recover. Wait.</li> <li>• If the problem persists, verify proper operation of the X.25 network.</li> </ul>	<ul style="list-style-type: none"> <li>• A packet timeout occurred after the 3274 sent a clear, reset, or restart packet and no response was received from the X.25 network.</li> </ul>	—	—	X.25

\*Where nn = port ID = 00-15

nnn Code	Error Description	Operational Indicator	Test No. for Log*	Counter Incremented	Log Only	Displayed On		Indicator Displayed	Recovery	Probable Cause/Action	Sense Codes		Applicable Feature
						All	One				SNA	Non-SNA	
539	Bad Network Termination	—	A0/1	X.25 Counters 1, 2, 5, 6 and HPCA counter 9	—	X	—	X <del>→</del> 539	<ul style="list-style-type: none"> <li>The 3274 is waiting for the X.25 network to recover or, if it is attempting to open the link, is itself trying to recover. Wait.</li> <li>If the problem persists, verify proper operation of the X.25 network.</li> </ul>	<ul style="list-style-type: none"> <li>The 3274 sent DISC due to:               <ol style="list-style-type: none"> <li>SABM** received when initialized.</li> <li>FRMR*** received.</li> <li>UA**** received.</li> <li>N(s) not sequencing.</li> <li>FRMR sent.</li> </ol> </li> </ul>	—	—	X.25
555	Format Error	—	A0/1	2 (X.21)	—		—	X <del>→</del> 555	<ul style="list-style-type: none"> <li>Reminder can be reset with COMM key to indicate X.21 state.</li> </ul>	<ul style="list-style-type: none"> <li>CP (Call Progress) or line ID did not end with an IA +5 delimiter.</li> </ul>	—	—	X.21 Switched 51C
556	X.21 Timeout	—	A0/1	3 (X.21)	—	X	—	X <del>→</del> 556	<ul style="list-style-type: none"> <li>Reminder can be reset with COMM key to indicate X.21 state.</li> </ul>	<ul style="list-style-type: none"> <li>X.21 Network Timeout has occurred.</li> </ul>	—	—	X.21 Switched 51C







\*Where nn = port ID = 00-15

\*\*Set Asynchronous Balanced Mode (Command)





\*\*\*Frame Reject

\*\*\*\*Unnumbered Acknowledge

( ) Counter Number Enclosed

nnn Code	Error Description	Operational Indicator	Test No. for Log*	Counter Incremented	Log Only	Displayed On		Indicator Displayed	Recovery	Probable Cause/Action	Sense Codes		Applicable Feature
						All	One				SNA	Non-SNA	
557	Not Ready	—	A0/1	5 (X.21)	—	X		X  557	<ul style="list-style-type: none"> <li>Monitor Mode is entered waiting for DCE to become ready</li> </ul>	<ul style="list-style-type: none"> <li>X.21 Network is not ready.</li> <li>Monitor Mode X  559 is entered.</li> </ul>	—	—	X.21 Switched 51C
558	Lost Data	—	A0/1	6 (X.21)	—	X		X  558	<ul style="list-style-type: none"> <li>Reminder can be reset with COMM key to indicate X.21 state.</li> </ul>	<ul style="list-style-type: none"> <li>Insufficient buffer space was available in the control unit for Call in Progress signals or Line ID from the network.</li> </ul>	—	—	X.21 Switched 51C
559	DCE Cleared	—	A0/1	7 (X.21)	—	X		X  559	<ul style="list-style-type: none"> <li>Reminder can be reset with COMM key to indicate X.21 state.</li> </ul>	<ul style="list-style-type: none"> <li>Clearing sequence has been executed in response to a network Clear request.</li> </ul>	—	—	X.21 Switched 51C
560	Not +/Bell	—	A0/1	11 (X.21)	—	X		X  560	<ul style="list-style-type: none"> <li>Reminder can be reset with COMM key to indicate X.21 state.</li> </ul>	<ul style="list-style-type: none"> <li>Abnormal condition detected while waiting for proceed or Select Incoming Call: <ul style="list-style-type: none"> <li>More characters than expected were received.</li> <li>Character was other than expected.</li> </ul> </li> </ul>	—	—	X.21 Switched 51C
561	Clear Timeout	—	A0/1	18 (X.21)	—	X		X  561	<ul style="list-style-type: none"> <li>Reminder can be reset with COMM key to indicate X.21 state.</li> </ul>	<ul style="list-style-type: none"> <li>Network Clearing Sequence did not terminate properly (T5 or T6 timeout).</li> <li>Monitor mode is entered — waiting for the DCE to become ready.</li> </ul>	—	—	X.21 Switched 51C

\*Where nn = port ID = 00-15

nnn Code	Error Description	Operational Indicator	Test No. for Log*	Counter Incremented	Log Only	Displayed On		Indicator Displayed	Recovery	Probable Cause/Action	Sense Codes		Applicable Feature
						All	One				SNA	Non-SNA	
562	Compare Error	—	A0/1	1 (X.21)	—	X		X  562	<ul style="list-style-type: none"> <li>Reminder can be reset with COMM key to indicate X.21 state.</li> </ul>	<ul style="list-style-type: none"> <li>Control unit detected a mismatch between the signals on the input and output sides of the drivers/receivers</li> </ul>	—	—	X.21 Switched 51C
565	Invalid Operation	—	A0/1	4	—	X	—	X PROG 565	<ul style="list-style-type: none"> <li>Press COMM key (goes to Call Ready State)</li> </ul>	<ul style="list-style-type: none"> <li>Unknown network failure</li> </ul>	—	—	X.21 Switched 51C
566 thru 569	Refer to installed RPO Documentation.												
590	Control Unit (3274) No Longer Polling 3290		nn/1	1, 2 (coax Error count- ers)			X	X  590	<ul style="list-style-type: none"> <li>Device POR</li> </ul>	<ul style="list-style-type: none"> <li>Possible Coax Error</li> </ul>	N/A	N/A	3290
595	Monitor Mode	—	—	—	—	X		X  595	<ul style="list-style-type: none"> <li>Control unit is waiting for DCE ready.</li> </ul>	<ul style="list-style-type: none"> <li>Monitor mode was entered as a result of a Network Not Ready or a Compare error.</li> </ul>	—	—	X.21 Switched 51C
599	Local Mode	—	—	—	—	—	—	X  599	<ul style="list-style-type: none"> <li>Put control unit in Call Ready state (Data Ready state if X.25 PVC) with COMM key sequence.</li> </ul>	<ul style="list-style-type: none"> <li>Control unit has entered local mode state as a result of a Local sequence.</li> </ul>	—	—	X.21 Switched 51C, X.25
6XX and 7XX	Refer to specific Distributed Function device documentation												

\*Where nn = port ID = 00-15

**Notes:**

1. SNA generates code X'1003', function not supported:

- Unsupported session control request
- Unsupported data control request
- Signal code not X'00010000'

- Network control request
- FM data stream
- Invalid command: data after Read, RM, RMA, EAU

2. Parameter error — invalid address after SBA, RA, or EAU order (SBA, RA, EAU without parameters) or SCS parameter error.

## B.2 PROBABLE CAUSE NOTES FOR ERROR CODES

As an aid to problem determination, more detailed *Probable Cause* explanations for selected error codes are given in this part of Appendix B. The error code itself, for example, 2%%, serves as the heading for the discussion.

### 2%%

The circumstances and times when the 2%% error code is displayed are as follows:

1. 2%% is displayed when the display is powered on and a keyboard or feature mismatch exists.
2. 2%% is displayed when an attempt is made to use the Structured Field and Attribute Processing feature (Color, Programmed Symbols, Highlighting) or the APL/Text feature, and the feature itself, or a prerequisite feature, is not installed in the display.

Printers do not give a 2%% indication. When a feature mismatch exists (item 1 preceding), 2EE hex is stored in byte 3C hex of the device control block (DCB) associated with the printer. The /6 test is used to display the control block.

Reasons and examples follow:

- Keyboard Mismatch (Power-On Time)

2%% is displayed when microcode support for the attached keyboard has not been configured, that is, has not been installed in the controller microcode via customization of the system diskette. As an example, typewriter keyboard support was configured (customization question 131) but the attached keyboard is a Data Entry keyboard.

- Feature Mismatches (Power-On Time)

Microcode support for a feature installed in the display or printer has not been configured. Following are examples:

- 2%% is displayed when a Magnetic Stripe Reader (MSR) feature is installed in the display but MSR microcode support (customization question 141) was not configured.
- 2EE is stored in byte 3C hex of the DCB associated with a printer when a feature such as APL/Text, Programmed Symbols, or Text Print is installed on the printer but the microcode support (customization questions 145, 162, 164, etc.) was not configured.
- 2%% is displayed when an Extended Character Set Adapter (ECSA) feature is installed in the device but neither APL (customization question 134) nor Text (customization question 135) microcode support was configured. **Note:** *Applicable only with microcode configurations that do not support Structured Field and Attribute Processing (SFAP).*

- 2%% is displayed when any combination of Programmed Symbols features is installed in the display but no microcode support (customization question 164) was configured.
- 2%% is displayed when the attached display is a 3279 Color Display Station and color convergence microcode support (customization question 161) was not configured.
- 2%% is displayed or 2EE stored when the 3274 attempts to allocate an extended DCB to a device powering on and none are available. The number of extended DCBs available is determined by the answer to customization question 163. The first device requiring an extended DCB that powers on after all the available DCBs have been allocated causes the 2%% or 2EE indication. Any display or printer equipped with the ECSA feature requires an extended DCB.

Refer to /6 test bytes 02, 03, 04, 95, and 96 hex and /2 test byte 23 hex for assistance in troubleshooting feature mismatches.

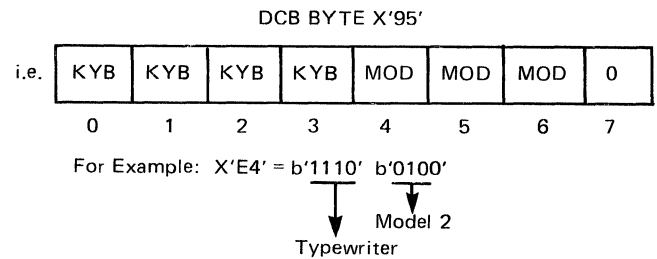

Providing there are no feature problems DCB byte 96 hex MAPS into DCB byte X'04' one for one.

- Operational Mismatches (Attempted-Use Time)

The controller microcode has been configured for the Structured Field and Attribute Processing feature or the APL/Text feature, but the physical feature itself, or a prerequisite feature on which it depends, is not installed in the device. Following are examples:

- 2%% is displayed when a PS set selection key is pressed and the PS feature is not present on the device.
- 2%% is displayed when an APL or Text key function is requested and no ECSA feature is installed in the device. **Note:** *Applicable only with microcode configurations that do not support SFAP.*
- 2%% is displayed when a Color selection key is pressed and the display is not a color display.
- 2%% is displayed when a Programmed Symbol, Color, or Extended Highlighting selection key is pressed and the ECSA feature is not present on the device.
- 2%% is displayed when status is received from an invalid address on the device feature bus.

### B.3 CORRELATION BETWEEN INDICATOR CODES AND LOG AREA

Complementing the PROG 4nn indicator codes, bytes X'170'—X'174' of the extended DCB are used as a log area for additional information. The extended DCB is created during customization for devices supporting Structured Field and Attribute Processing (SFAP).

Bytes X'170', X'171' contain the displacement in hex to the byte in the Write Structured Field that was found to be in error. (The WSF command = byte 1.) Bytes X'172', X'173' contain the displacement into the particular structured field (SF) where the error was detected. Byte X'174' contains the SF type of the SF that contained the error.

Figure B-1 correlates the 4nn numbers, the values found in bytes X'172—174', the SNA sense code, and a description of the error. OP check is the sense set for local attachment (non-SNA) and BSC in all cases.

Bytes X'170—174' may be displayed in the following manner. Enter Test Mode by pressing the Alt and Test keys. Select the DCB in question by typing in AA/6; AA is the coax port number in question (00-31). (If the device being used for the test is the port in question, /6 will suffice.) Press the Enter key. The display should now contain:

```
Line 1 AA/6 (Same as input)
Line 2 00
```

```
Line 3 XXXX XXXX XXXX XXXX XXXX XXXX
      XXXX XXXX
Line 4 XXXX XXXX XXXX XXXX XXXX XXXX
      XXXX XXXX
Line 5 XXXX XXXX XXXX XXXX XXXX XXXX
      XXXX XXXX
Line 6 XXXX XXXX XXXX XXXX XXXX XXXX
      XXXX XXXX
```

Where: 00 = The displacement from the start of the control block (in hex, the low-order digit is dropped) of the portion of the control block currently being displayed.

XXXX = Hex representation of the portion of the control block currently being displayed.

Press the PA1 or Enter key five times. Line 2 should change to 04, 08, 0C, 10, and then 14. The low-order digit being dropped, the values are really X'40', X'80', X'C0', X'100', and X'140'. X'170'—'174' are the first 5 bytes on line 6.

**Note:** *Values exceeding X'0C' on line 2 appear only if an extended DCB (for this device) is present.*



4nn	Bytes X'172-174'	Sense	Error Description (See Note)
471	0003 XX XX = any value but 01, 06, or 09	1003	Unsupported SF type
471	----	1003	WSF command sent to a device without an ECSA feature
471	0004 06	1003	Invalid load format addressed to terminal PS storage
471	000A 06	1005	Invalid horizontal (X) value for LPS SF
	000B 06	1005	Invalid vertical (Y) value for LPS SF
471	000C 06	1003	Byte 11 is not equal to 0 in LPS SF
471	0001 XX XX = 01, 06, or 09	1005	Invalid length SF
471	0004 09	1005	Byte 3 not 0 in SRM SF
471	0005 09	1003	Invalid Mode in SRM SF
471	0005 01	1003	Byte 4 is not X'02' in Read Partition-Query SF
471	0005 06	1003	Symbol set ID out of legal range
471	0006 06	1005	Invalid EBCDIC code point
471	000D 06	1003	Bits 0-4 of byte 12 in LPS SF not 0
471	0009 06	1003	Bits 3-7 of byte 8 in LPS not 0
471	0002 06	Op Chk	(BSC only) Greater than 3K of uncompressed LPS data received
471	0004 01	1003	Byte 3 not X'FF' in Read Partition-Query SF
473	0007 06	084C	ECSA present but addressed RWS in device not physically present
473	000D 06	084C	Color plane invalid

SF = Structured Field  
LPS = Load Programmed Symbols  
RWS = Read/Write Storage  
SRM = Set Reply Mode

**Note:** As part of overall SFAP problem determination, the usage of the following functions should be kept in mind. If the device in question does not have an extended DCB (not enough allocated during customization), the DCB display procedure (described above) inhibits the keyboard with the minus function indicator on the fourth pressing of the PA1 or Enter key. If the device does not have an ECSA feature, Test 8 (Enter test mode, type in /8, press Enter) inhibits the keyboard with a wrong number indicator. However, if the APL/TEXT feature is installed ESCA is installed as a prerequisite. This is also true if SFAP is not configured. If SFAP is not configured, the above nnn numbers do not appear.

Figure B-1. Correlation between Indicator Codes and Log Area



# Appendix C. X.21 Switched Feature (3274 Models 51C and 61C)

## C.1 INTRODUCTION

The 3274 X.21 Switched feature allows the 3274 to be attached to the DCE that electrically matches CCITT Recommendation X.27, and that operates as specified in CCITT Recommendation X.21 at speeds of 2400, 4800, 9600, and 48,000 bps.

To use the X.21 Switched feature, the 3274 must have either a 3278 Display Station or a 3279 Color Display Station or similar display station attached.

## C.2 FUNCTIONAL DESCRIPTION

The 3274 supports the following for the X.21 Switched feature.

- SDLC CAC to support X.21 Switched protocol
- Data Link Control, which is an interface to the SDLC CAC
- X.21 Switched Adapter card.

This section defines the function of the Data Link Control, which issues function requests to the CAC and handles completion codes from the CAC. Figure C-1 outlines the Data Link Control function.

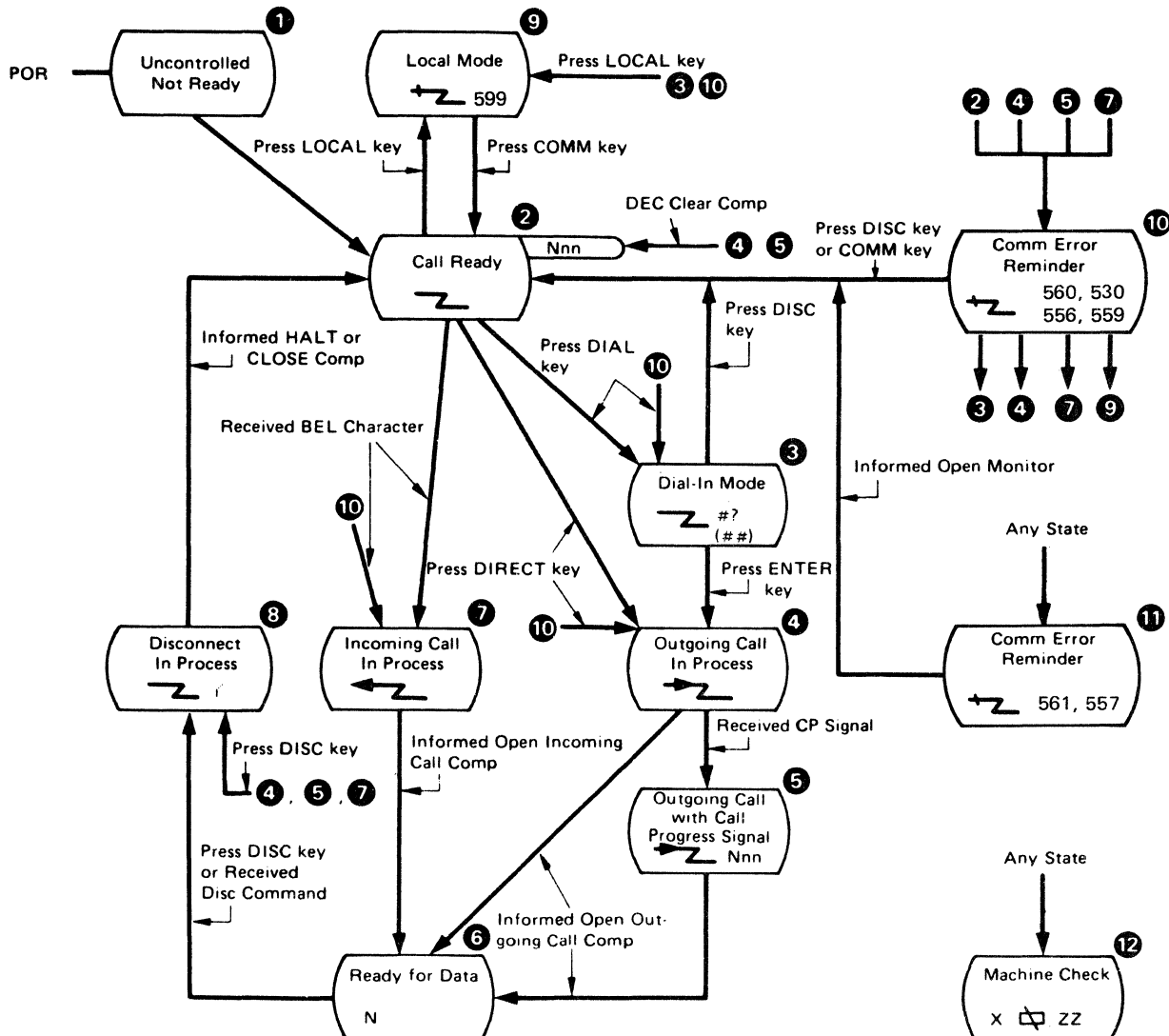

Figure C-1. Data Link Control Function

## C.2.1 X.21 Switched CAC Function

### C.2.1.1 Function Requests

#### 1. OPEN for outgoing call

By this request, the HPCA and the X.21 hardware are reset and enabled, and, after passing through the ready state, proceed with the outgoing call establishment.

The CAC signals the X.21 hardware to enter the call-request state and awaits the reception of an IA5 plus (+) character from the network.

When the request contains selection signals, the CAC/X.21 hardware sends two IA5 sync characters and the selection signals (including dial digits) that were set up by the Data Link Control in the selection signal buffer.

The X.21 hardware monitors the network interface; if Call Progress signals and/or called line identification are received, they are passed on to the CAC. After translation, the CAC will pass the first Call Progress signal (normally two digits) or line ID to the Data Link Control's buffer and post an intermediate completion status.

When the CAC detects that the network is ready for data, the CAC will enter the data-transfer phase after housekeeping and preparing the X.21 hardware and CAC to receive the first SDLC frame. The Data Link Control is notified that the Open is completed.

The process is similar when the outgoing call is direct. A direct call by the Data Link Control identifies a direct call by specifying no dial digits. When the IA5 plus (+) character is received, signifying select from the network, the CAC enters the DTE waiting state for the reception of Call Progress signals, called line identification, or the indication that the network is ready for data.

#### 2. OPEN for incoming call

When the Data Link Control issues the X.21 Open function request for an incoming call, the action of the CAC/X.21 hardware differs slightly from that for an outgoing call.

- The CAC/X.21 hardware determines that the network is ready, then enters the ready state to await an interrupt from the X.21 hardware signifying activity on the network.
- Receipt of one IA5 BEL character identifies the incoming call state. The CAC posts an intermediate completion status (BEL RCVD) and, when it regains control, prompts the X.21 hardware to turn on the control lead that signifies the call-accepted state.

- The CAC now waits for an interrupt to indicate either that the calling line identification has been received or that the network is ready for data. If line identification is received, the CAC moves it to the Data Link Control's buffer, and the completion status is passed on the same way as for an outgoing call.

When Ready-for-Data is detected, the data-transfer phase is entered after the CAC completes appropriate housekeeping and prepares the X.21 hardware for the first SDLC frame. A normal completion to the Open function request is posted by the CAC.

#### 3. OPEN for monitoring

The CAC checks the X.21 interface periodically. If the DCE's status coincides with the condition specified by the Data Link Control, that is, DCE ready or DCE not ready, the CAC reports normal completion.

#### 4. Close

If the clearing sequence is already completed, the CAC merely executes the final housekeeping requirements; otherwise, the CAC starts a clearing sequence. When the clearing ends properly, and no comparator error is indicated by the X.21 hardware, a normal completion is posted. When the clearing sequence does not end properly within its time limit, or if a comparator error exists, appropriate error status is posted. The HPCA and X.21 hardware are always reset prior to posting any completion code to the Close FR. The CAC/X.21 hardware will be in the controlled-not-ready state when this FR ends.

#### 5. HALT

The Data Link Control aborts an OPEN function request by issuing a HALT request. The CAC executes a clearing sequence to the network.

### C.2.1.2 Call Collision

A call-collision condition can exist when a call request is made to the network at the same time the network is making an incoming call. The network will resolve the collision in favor of the call request.

**Note:** *The X.21 recommendation does not permit deliberate call collisions; that is, the DTE entering the call-request state after becoming aware of the incoming-call state.*

*Therefore, the Data Link Control avoids deliberate situations by issuing the proper sequence of function requests; for example, by issuing a HALT request to the Open-for-Incoming request before issuing the Open-for-Outgoing request.*

### C.2.1.3 Call Progress (CP) Signals

The only time the CAC is affected by a particular call progress (CP) signal is if the first digit of a received CP signal is an IA5 "0," "2," or "6."

The IA5 "0" identifies the call-wait class (terminal called or waiting connection). The action of the CAC upon detecting the IA5 "0" is to initiate a 60-second timeout instead of the 2-second timeout, while waiting for the network to become ready for data. Upon detecting the IA5 "2" or "6" (short-term condition when clearing), the CAC prepares for the retry by initiating a clearing sequence. CP signals already received will be moved to the Data Link Control's buffer.

When reacting to a IA5 "0" CP, the CAC will post the intermediate completion status, indicating that CP signals are available in the buffer. When reacting to the IA5 "2" or "6" CPs, the retry intermediate status is posted, indicating that the retry is due to receipt of a retry type CP signal.

## C.2.2 Data Link Control Function

### C.2.2.1 Call Ready

The Call-Ready indicator is displayed in the Operator Information Area of the 3278 or 3279 and the use of either the DIAL key, DIRECT key, or LOCAL key is accepted, as is an incoming call.

This state is the X.21-Ready state and is entered by the Open-for-Incoming request to the CAC under the following conditions:

1. Immediately after POR of the 3274 by the Uncontrolled-Not-Ready state.
2. When the COMM key is pressed while operating in the local mode.
3. When the Dial-In mode is ended by the DISC key.
4. After the line is disconnected normally by the DISC key on the DISC command.
5. When the Open Outgoing request is rejected by CP signals.
6. After the line is disconnected by an error, or after the X.21 open request is completed erroneously, except if condition 7 exists. However, the Call-Ready indicator is overridden by the Comm Error Reminder. This reminder can be reset by the COMM key, and the Call-Ready indicator will appear.
7. If the DCE is not ready, the Comm Error Reminder is displayed, and the Open-Monitor request is issued. When this request is completed, the Call-Ready indicator is displayed in the Operator Information Area.

### C.2.2.2 Incoming Call in Process

When an incoming call comes to the 3274 while in the X.21 Ready state, the CAC returns the intermediate completion code with 'BEL RCVD'. The Data Link Control displays the Incoming-Call-in-Process indicator and returns control to the CAC. When the Ready-for-Data is sent from the DCE, the CAC returns a normal completion code. The Data Link Control turns off the Incoming-Call-in-Process indicator, turns on the In-Use indicator, and prepares for normal data exchange.

### C.2.2.3 Dialing

When the DIAL key is pressed in the Call-Ready state, the Data Link Control issues the HALT request to the CAC to inhibit an incoming call, clears the screen, and puts the cursor at the home position. The Wait indicator is displayed until the HALT request is completed. Then the Dial-In indicator is displayed.

The operator enters dial digits, or any facility request allowed by the network, and presses the Enter key.

The Data Link Control issues an Open-for-Outgoing request to the CAC with parameters that include selection signals entered by the operator, and displays the Outgoing-Call-in-Process indicator.

### C.2.2.4 Direct Call

When the DIRECT key is pressed in the Call-Ready state, the Data Link Control issues the HALT request and the Open-for-Outgoing request, with no selection signal, and displays the Outgoing-Call-in-Process indicator.

### C.2.2.5 Outgoing Call in Process

The CAC processes the Open-for-Outgoing request, as described under heading C.2.1.1, and returns a normal-completion code to the Data Link Control when the X.21 Ready-for-Data signal is sent from the DCE. The Data Link Control turns off the Outgoing-Call-in-Process indicator, turns on the In-Use indicator, and prepares for normal data exchange.

### C.2.2.6 Local Mode

When the LOCAL key is pressed in the Call-Ready state, the Data Link Control issues the HALT request and displays the Local Mode indicator.

The Local mode is the X.21 Controlled-Not-Ready state and inhibits incoming and outgoing calls.

When the COMM key is pressed in the Local mode, the Data Link Control issues an Open-for-Incoming request to the CAC and displays the Call-Ready indicator.

### C.2.2.7 Disconnection

When the DISC key is pressed in the Ready-for-Data state or Outgoing/Incoming Call-in-Process state, the Data Link Control issues a CLOSE request in the Ready-for-Data state, or issues a HALT request in the Outgoing/Incoming-Call-in-Process state to the CAC, and displays the Disconnect-in-Process indicator. When the close-completion code is returned from the CAC, the Data Link Control turns off the In-Use indicator, issues an Open-for-Incoming request to the CAC, enters the Call-Ready state, and displays the Call-Ready indicator. When the halt-competition code is returned, the Data Link Control issues an Open-for-Incoming request to the CAC, enters the Call-Ready state, and displays the Call-Ready indicator.

The line is also disconnected automatically by a timeout condition or by the SDLC DISC command.

### C.2.3 X.21 Switched Adapter (X.21) Card

The X.21SA card is 2W by 3H and is pin-compatible with the integrated modem, the EIA/CCITT interface, the Loop I/F, and the DDS Adapter. Its location is 01A-A1G2 in the Model 51C, and A1K2 in the Model 61C. The X.21SA card has the two interfaces: the HPCA interface and the DCE interface. The HPCA interface connects the X.21SA to the HPCA adapter in the 3274. The DCE interface connects the X.21SA card through X.27 (V.11) level of the X.21 interface, appropriate board wiring, and a communication cable to the external DCE.

## C.3 EXTENSION KEY AND MODIFIER KEYS

### C.3.1 Locations

Figure C-2 defines the positions for the Extension key and the Modifier keys, such as DIAL, DIRECT, DISC, LOCAL, and COMM keys for the X.21 Switched feature operation on the 3278 or 3279 or similar display. The X.21 Switched feature operation is executed by pressing the Extension key, and then one of the modifier keys.

**Note:** A decal and labels are provided to the customer to place on the keyboard to indicate the key positions.

### C.3.2 Extension Mode

- The Extension mode is entered by pressing the Extension key except during the no-security-key condition or in the Test mode.
- All keyboard status indicators, such as KANA, ALPHA, APL, Text, NUM, UPSHIFT, and INSERT, are cleared when entering the Extension mode. The indication '▶' is displayed in column 30 of the information area when in the Extension mode.
- If a modifier key is pressed when in the Extension mode, the Extension mode is reset, and the function defined for the key is executed. The Extension key resets the Extension mode if pressed when in the Extension mode.

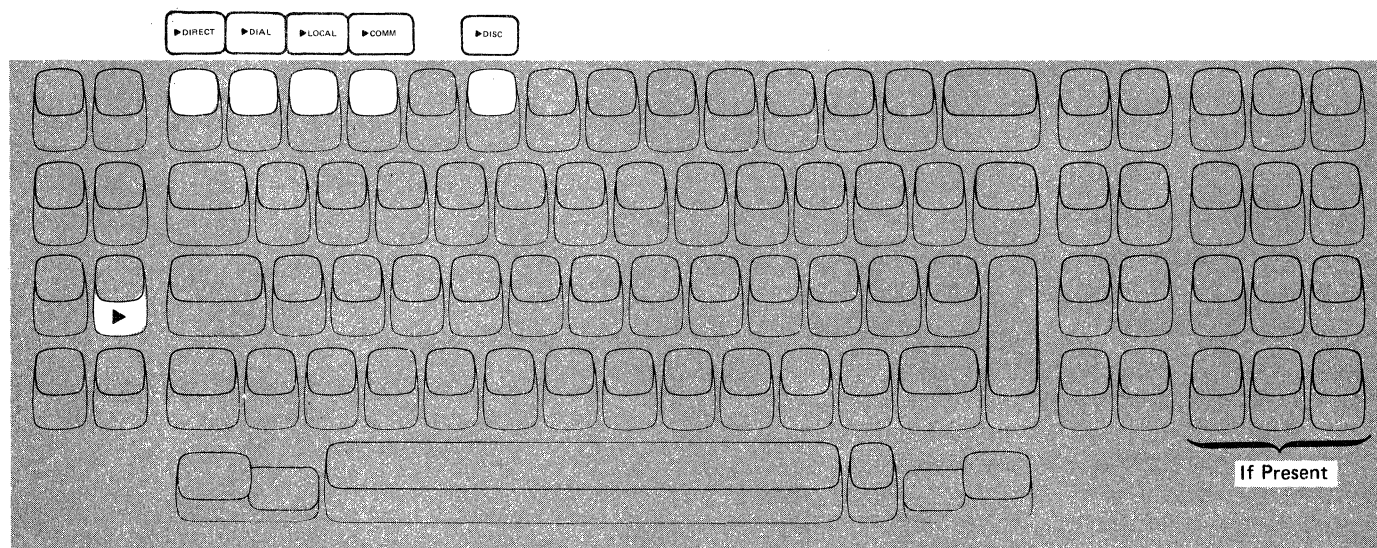

▶ is Extension key (ALT position of the ERASE EOF key).

Figure C-2. Keyboard Layout with X.21 Switched Feature

- The Reset key and the ALT key operate normally in the Extension mode and do not reset the Extension mode.
- If any key other than a modifier key and the Reset key is pressed, the Retry indicator is displayed, and the Extension mode is reset.
- Use of the DIAL key will be rejected in the Extension mode. The Retry indicator will be displayed when the device is busy, very busy, or not functional.
- The Extension key aborts the print ID mode and dead-key sequence.

## C.4 STATUS AND KEY OPERATION

Figures C-3 and C-4 show how keys are treated when pressed in the X.21 Switched states and when in the Dial-In mode.

Status	Operation					
	DIAL Key Pressed	DIRECT Key Pressed	DISC Key Pressed	LOCAL Key Pressed	COMM Key Pressed	AID Key Pressed
Call Ready	Accept Z #? (##)	Accept Z	Ignore Z	Accept Z 599	Ignore Z	X-f Z
Call Ready with Call Progress Signal	Accept Z #? (##)	Accept* Z	Accept* Z	Accept Z 599	Accept* Z	X-f Z Nnn
Outgoing Call In Process	X 夫 Z Z	X 夫 Z Z	Accept Z ☺	X 夫 Z Z	Ignore Z	X-f Z
Outgoing Call In Process with Call Progress Signal	X 夫 Z Z Nnn	X 夫 Z Z Nnn	Accept Z ☺	X 夫 Z Z Nnn	Ignore Z Nnn	X-f Z Nnn
Incoming Call In Process	X 夫 Z Z	X 夫 Z Z	Accept Z ☺	X 夫 Z Z	Ignore Z	X-f Z
Data Ready	X 夫 Z	X 夫 Z	Accept Z ☺	X 夫 Z	Ignore	Same as the base machine
Disconnect In Process	X 夫 Z Z ☺	X 夫 Z Z ☺	Ignore Z ☺	X 夫 Z Z ☺	Ignore Z ☺	X-f Z ☺
Local	X 夫 Z Z 599	X 夫 Z Z 599	X 夫 Z Z 599	Ignore Z 599	Accept Z	X-f Z 599

\* Reset Call Progress Signals.

**Note:** In each box under "Operation", the upper row shows an indicator from column 8 and the lower row shows an indicator from column 20.

Figure C-3. Key Operation (During X.21 Switched States)

Key Pressed	Reaction	
	Dial-Originating Terminal	Other Terminals
DIAL	Clear Screen Z #?	X-f Z Z ##
DIRECT	Z	X-f Z Z ##
LOCAL	Z 599	X-f Z Z ##
COMM	Ignore Z #?	Ignore Z ##
DISC	Z	Z
AID	X-f Z #?	X-f Z ##
CLEAR	Clear Screen* Z #?	Clear Screen Z ##
TEST	Test Abort Dial	Test Z ##
ENTER	Z	X-f Z ##

\* Clear only the dial-in area

**Note:** In each box under "Reaction", the upper row shows an indicator from column 8 and the lower row shows an indicator from column 20.

Figure C-4. Key Operation in Dial-In Mode

### C.5 ERROR CODES AND RECOVERY

The X.21 Switched Adapter feature error codes and recovery are shown in Appendix B.

### C.6 CALL PROGRESS SIGNAL CODE

The Call Progress Signal (CPS) is sent by the network to advise a calling terminal/host about the progress of a call or about the circumstances that have prevented a connection from being established. It is transmitted by the network after receiving end-of-dialing and is not repeated. The CPS codes and meanings are shown in Figure C-5.

**Note:** Meaning of the codes is different in each country. Ask a specialist for details about code meaning.

CPS Code	CPS Meaning
00	Wait
01	Terminal called
02	Redirected call
03	Connect when free
20	No connection
21	Number busy
22	Selection signal procedure error
23	Selection signal transmission error
41	Access barred
42	Changed number
43	Not obtainable
44	Out of order
45	Controlled not ready
46	Uncontrolled not ready
47	DCE power off
48	Invalid facility request
49	Network fault in local loop
51	Call information service
52	Incompatible user class of service
61	Network congestion
71	Long-term network congestion
72	RPOA out of order
81	Registration/Cancellation confirmed

Figure C-5. Call Progress Signal Code



# Appendix D. X.25 Adapter Feature (3274 Models 51C and 61C)

## D.1 INTRODUCTION

The X.25 Adapter feature permits Models 51C and 61C 3274 control units to attach to host systems via an X.25 network. IBM SNA-defined protocols are utilized. Since the SNA protocols used by the 3274 are identical to existing 3274 SNA attachments, they are not detailed here. Descriptions of these SNA protocols are briefly defined in Chapter 5 of this manual and are defined in more detail in X.25 Interface for attaching IBM SNA Nodes to packet switched data networks – *General Information Manual, GA27-3345*.

The International Telegraph and Telephone Consultative Committee (CCITT) Recommendation X.25 defines an interface between customer Data Terminal Equipment (DTE) and Data Circuit-terminating Equipment (DCE) to attach DTEs to Packet Switched Data Networks (PSDN).

The definition includes:

- **Physical Level:** The mechanical, electrical, functional, and procedural characteristics to activate, maintain, and deactivate physical communication links between DTEs and DCEs.
- **Link Level:** The link access procedure for the interchange of data across communication links between DTEs and DCEs.
- **Packet Level:** The packet formats and logical protocols for the exchange of control information and user data between DTEs and DCEs.

## D.2 X.25 ELEMENTS

### D.2.1 Physical Level

- X.21 leased circuit
- X.21 bis (V.24 or V.35) leased circuit
- EIA (CCITT)
- DDSA
- Transmission is NRZ with clocking externally supplied.
- Up to 9600 bps for all 3274 Models.

### D.2.2 Link Level

- Link Access Procedure Balanced (LAPB)
- Modulo 8 Link Level Sequence Numbering

### D.2.3 Packet Level

- Single Virtual Circuit (Switched or Permanent)
- Modulo 8 or 128 Packet Level Sequence Numbering
- Data packet sizes of 64, 128, 256, or 512 bytes
- Packet window sizes of 1 to 7 for modulo 8
- Packet window sizes of 1 to 11 for modulo 128

#### *Logical Link Control*

- Qualified Logical Link Control (QLLC) or,
- Physical Services Header (PSH)

## D.3 HARDWARE/CONFIGURATION SUPPORT

### D.3.1 Configuration Support

Two 3274 configurations support the X.25 function:

- **Configuration Support D:** When X.25 support is added to this microcode version, 256K of storage is required. Note that Configuration Support D requires the 2-sided diskette.
- **Configuration Support P:** This is a new microcode version that supports X.25 only. Configuration Support P requires 128K of storage and a 1-sided diskette.

### D.3.2 Hardware Support

The following matrix defines the hardware support required by the 3274 models that are described in this manual. The high performance communications adapter (HPCA) is required in all cases.

3274 Mode	Configuration Support:		Upgradeable To:		
	P	D	2-Sided Diskette	128K	256K
51C	Yes	Yes	Feature	Feature	Feature
61C	No	Yes	Base	N/A	Feature

N/A = Not applicable

### D.3.2.1 Hardware Required

- HPCA Adapter P/N 6340976 at EC 344593A or higher

One of the following signal converter cards is required:

- EIA/CCITT P/N 5864668
- X.21T P/N 5864683
- DDSA P/N 8527032

### D.3.2.2 Mutually-Exclusive Feature

X.25 support is mutually exclusive with the Encrypt/Decrypt feature (#3680).

## D.4 TIMERS

The following timer values are supplied. The values are derived from the HPCA timers and have an accuracy of the stated value + - 20%.

Timer	Value (In Seconds)	5nn
Receive Timeout	30	520
Packet Timeout	200	538
Transmit Failure (Write Timeout)	36	530
Open Timeout	25.6	517
Tp(T1)/Np(N2)	Customer-specified values (customizing responses 450, 451)	506

## D.5 THE X.25 NETWORK

When using X.25 protocols, the network includes the 3274; an operator at a 3278, 3279, or equivalent display station that is attached to the 3274; the X.25 network; a Network Interface Adapter, or equivalent; a Host CPU; an access method (such as VTAM); and host CPU application programs.

### D.5.1 Virtual Circuits

A Permanent Virtual Circuit (PVC) may be thought of as a point-to-point SDLC leased line. A Switched Virtual Circuit (SVC) may be thought of as a point-to-point switched line.

### D.5.2 Logical Channels

Each virtual circuit is assigned a Logical Channel Group Number (0–15) and a Logical Channel Number (1–255) by the Packet Switched Data Network (PSDN). These two numbers comprise the Logical Channel Identifier (LCID). This LCID may be entered during customizing of the 3274.

The following Logical Channel types may exist:

- Permanent Channel – Used for a PVC dedicated to data transfer between a 3274 and a specific Host DTE.
- Outgoing Channel – Used for an SVC where only the 3274 can initiate a call.
- Incoming Channel – Used for an SVC where only a remote DTE can initiate a call.
- Two-Way Channel – Used for an SVC where either the 3274 or the remote DTE can initiate a call.

## D.6 PACKET TYPES

The following describes each of the X.25 packet types supported by the 3274. The cause and diagnostic codes, mentioned in the Packet Type descriptions, are defined in Chapter 2, "Operator Information Area Layout" in this manual.

### D.6.1 Call Request (SVC)

The Call Request packet is transmitted by the 3274 when an X.25 Dial operation is performed by the operator. This packet contains the called number and optional information to match the user's subscription. The optional information is based on customizing options or operator input.

### D.6.2 Incoming Call (SVC)

The Incoming Call packet is received by the 3274 as a result of a remote DTE transmitting a Call Request packet. The 3274 examines the data in the packet (based on options selected during the customizing procedure) to ensure that it conforms to the information customized or as specified by the display operator via a Dial operation.

### D.6.3 Call Accepted (SVC)

The Call Accepted packet is sent by the 3274 after an Incoming Call packet has been received that conforms to the network facilities specified.

### D.6.4 Call Connected (SVC)

The Call Connected packet is received by the 3274 as confirmation that the remote DTE has accepted the 3274's Call Request. The circuit is now in the Data Ready state and SNA protocols may begin.

### D.6.5 Clear Request (SVC)

The Clear Request packet is sent by the 3274 as a result of an X.25 Disconnect operation by the operator or the network (normal circuit termination) or as a result of certain errors detected by the 3274. Cause and diagnostic codes are included and, if caused by a 3274-detected error, the codes are logged and displayed to the operator.

### D.6.6 Clear Indication (SVC)

The Clear Indication packet is received by the 3274 as a result of a normal clearing sequence or as a result of problems detected by the network or the remote DTE. The circuit is stopped, a Clear Confirmation packet is sent, and non-zero cause and diagnostic codes are logged and displayed to the operator.

### D.6.7 Clear Confirmation (SVC)

The Clear Confirmation packet is sent by the 3274 to acknowledge the receipt of a Clear Indication packet or may be received by the 3274 in a network response to a Clear Request packet.

### D.6.8 Reset Request (PVC)

The Reset Request packet is sent when the 3274 detects certain X.25 errors. Cause and diagnostic codes are included, logged, and displayed to the operator. The 3274 then attempts to re-open the circuit. The Reset Request packet is not sent during normal PVC operation wherein the 3274 remains connected to the circuit/link until powered off. A Reset Request packet is sent as part of a LOCAL key operation when the circuit is connected, or upon detection of certain X.25 network error conditions. The SNA layers must be reactivated via QSM (SNRM), ACTPU, ACTLU sequence.

### D.6.9 Reset Indication (PVC/SVC)

The Reset Indication packet is received by the 3274 as a result of problems detected by the network or the remote DTE. The circuit is stopped, the X.25 Communication Check indicator with cause and diagnostic codes are displayed, and the codes are logged. The SNA layers must be reactivated via QSM (SNRM), ACTPU, ACTLU sequence.

### D.6.10 Reset Confirmation (PVC/SVC)

The Reset Confirmation packet is transmitted by the 3274 to acknowledge receipt of a Reset Indication packet or may be received by the 3274 in confirmation of a Reset Indication packet.

### D.6.11 Restart Request (PVC/SVC)

The Restart Request packet is sent when the 3274 is closing the link because it has detected certain X.25 errors or when a LOCAL key has been accepted. It is also sent when an Open Link operation is performed. Open Link operations are performed when: (1) the 3274 is IML'ed, (2) LOCAL mode has been entered and the COMM key is pressed, or (3) the link has been closed due to an error condition. In this event, the 3274 immediately attempts to reopen the link. Cause and diagnostic codes are included and logged, and when due to error conditions, the codes and the Communication Reminder indicator are displayed.

### D.6.12 Restart Indication (PVC/SVC)

When the Restart Indication packet is received, the 3274 responds with a Restart Confirmation packet, shuts down the link, notifies the operator by displaying an indicator with cause and diagnostic codes, and logs the error.

### D.6.13 Restart Confirmation (PVC/SVC)

When the 3274 has sent a Restart Request packet as a result of attempting to initialize packet level operation, receipt of a Restart Confirmation packet signals the completion of initialization. The 3274 sends a Restart Confirmation packet whenever a Restart Indication packet is received from the DCE.

### D.6.14 Data (PVC/SVC)

The Data packet is used to transmit and receive data once a circuit has been established.

### D.6.15 Receiver Not Ready (PVC/SVC)

When the 3274 receives a Receiver Not Ready packet, the 3274 stops transmission until a Receiver Ready packet is received. The 3274 does not *send* a Receiver Not Ready packet.

### D.6.16 Receiver Ready (PVC/SVC)

The Receiver Ready packet is sent by the 3274 in response to any packet that is received unless an outgoing Data packet is ready for transmission. Receipt of a Receiver Ready packet indicates that transmission by the 3274 may continue.

### D.6.17 Diagnostic (PVC/SVC)

The Diagnostic packet contains diagnostic information and is received when a reset, clear, or restart packet is not appropriate. The cause and diagnostic information is logged and no further action is taken.

## D.7 SWITCHED VIRTUAL CIRCUIT (SVC) DESCRIPTION

The X.25 SVC capability of the 3274 Control Unit permits the operator of an attached 3178, 3278, 3279, or compatible DCA-protocol-attached display station to connect the 3274 and its attached terminals to a remote host system via a public X.25 packet switched data network. Note that this capability is not supported on distributed-function terminals (e.g., the 3290 Information Panel).

The functions necessary to connect the 3274 to the remote host are invoked by operator actions at the keyboard (and incoming calls). The status of the 3274 Control Unit with respect to the network is conveyed to the operator via indicators in the Operator Information Area of the display screen.

To support X.25 SVC functions, additional key functions and indicators are provided at the display. These key functions are a subset of the key functions defined for 3274 support of the X.21 Switched feature. The indicators (symbols in the display screen's Operator Information Area) are the same as those used for the X.21 Switched feature except that the indicators containing Call Progress signals in the X.21 Switched feature are redefined and expanded to contain cause and diagnostic (C&D) codes.

**Note:** *Operator Information Area Indicators and C&D codes are defined in Chapter 2, "Operator Information Area Layout", of this manual.*

### D.7.1 Key Functions

- Extension key
- DIAL key
- DISC (disconnect) key
- LOCAL key
- COMM (communication) key
- LOAD MATRIX key

The device attached to port 0 normally has access to the full complement of X.25 Switched function keys. The LOAD MATRIX key function is assigned to port 0 only. The other keys may optionally be assigned to all ports or certain keys may be deleted, depending on how the 3274 was customized.

See Figure D-4, for details.

### D.7.2 Indicators

The following indicators are displayed in the Reminder area of the Operator Information Area of the display screen:

- Call Ready
- Call Ready with cause and diagnostic (C&D) codes
- Dial In (dialing terminal)
- Dial In (other terminals, same control unit)
- Outgoing Call in Process
- Incoming Call in Process
- Disconnect in Process
- Local (  599)
- X.25 Communication Reminder

The following indicator is displayed in the Do Not Enter area:

- Operator Communication Check (  nnn)

The following indicator is displayed in the Readiness and System Connection area:

- In-Use (N)

The following indicator is displayed in the Shifts and Modes area:

- Extension mode ( > )

## D.8 X.25 STATES

Call Ready

- Circuit is in the disconnected state. It is possible to attempt a connection.

Local

- Link and circuit are disconnected. It is impossible to perform a connecting operation.

In-Use

- Circuit is connected and ready for data.

Incoming Call or Outgoing Call

- Connection operation is in progress.

Disconnection in Process

- Disconnection operation is in progress.

Error

- Error states are displayed via the Machine Check and Communication Check indicators.

## D.9 NORMAL OPERATING PROCEDURE

All the X.25 SVC operations are performed using the display station keyboard, screen, and Operator Information Area. The indicators that are displayed in the Operator Information Area and the layout of the area are defined in Chapter 2 of this manual.

**Note:** *Because there are not enough key positions to execute each X.25 switched operation by a single keystroke, a key called the 'Extension' key is defined. To execute any of the X.25 function keys (and the LOAD MATRIX key), the sequence is: press and hold the ALT key (present on all keyboards), press the Extension key (>), release the ALT and Extension keys, and then press the desired X.25 function key. Except for this section, pressing the ALT and Extension keys is not mentioned in this manual. Thus, "press the DIAL key" means "press the ALT and Extension keys and press the DIAL key.*

When using the X.25 function, the load-matrix-key function is moved from position 38 to position 15.

The X.25 function keys and positions are:

- DIAL key (position 4)
- LOCAL key (position 5)
- COMM (Communication) key (position 6)
- DISC (Disconnect) key (position 8)
- Load Matrix Key (Load Host Print Matrix; port 0 only) (position 15)

Key layout is defined later in this Appendix.

Indicators to show X.25 states are displayed in the Reminder area of the Operator Information Area. The Input-Inhibited indicator (X) is displayed per normal 3274 function. The In-Use indicator (N) is displayed in location 7 of the Readiness and System Connection area. Chapter 2 in this manual, "Operator Information Area Layout", defines the indicators used by the X.25 function.

X.25 state indicators disappear while a Communication Check Reminder indicator is displayed.

The Operator Communication Check indicator has a higher priority than the Communication Check indicator and a lower priority than the Machine Check indicator.

### D.9.1 Call Ready

- After power is on and the link is operational, the Call Ready indicator is displayed.
- The DIAL key, LOCAL key, or an Incoming Call is accepted when the Call Ready indicator is displayed.

### D.9.2 Dialing

When the DIAL key is pressed in Call Ready state, the Dial indicator replaces the Call Ready indicator. The DIAL key initiates keyboard reset and clear functions simultaneously. The reset function restores the keyboard, repositions the cursor to home, reverts to the base character set, and restores all input-inhibit conditions except:

- Wait
- Device Busy
- Device Very Busy
- Device Not Functional
- Security Key

If the keyboard is not reset, the DIAL key performs no function and Extension mode is exited.

The Dial screen is displayed. (See "Dial Mode Screen Description", later in this Appendix for definition of the Dial screen.) The appropriate information is entered by the operator.

After keying in the information, the ENTER key is pressed. If the data is successfully validated by the 3274, the data entered by the operator is stored, a Call Request packet is assembled and transmitted by the 3274, and the Outgoing Call in Process indicator replaces the Dial indicator.

If the ENTER key has not been pressed, or if the entered data was not valid, the information stored by the last successful DIAL/ENTER key operation may be retrieved by pressing the DIAL key again. When Dial mode has been entered by a display station, an attempted entry of Dial mode at any other display station is inhibited and the Operator Communication Check indicator is displayed.

When in Dial mode, the DISC key on other terminals operates normally.

Dial mode operations are shown in Figure D-1.

Pressing the CLEAR key while in Dial mode causes the input fields on the screen to be restored from the previously stored values. Since there is no connection with a host application, no AID-generating operation is attempted.

When the RAS /0 Test is directed to a terminal in Dial mode, Dial mode is reset, Call Ready mode is set, the terminal enters Test mode and the test is executed.

Action Taken	Dialing Terminal	Other Terminals
DIAL key	Accepted. Display Dial screen with saved parameters. —_#?	Rejected. ✕*—_ —_##
LOCAL key	Accepted. (See Note.) ✕*—_ 599	Rejected. ✕*—_ —_##
COMM key	Ignored. —_#?	Ignored. —_##
DISC key	Accepted. (See Note.) —_	Accepted. (See Note.) —_
TEST key	Accepted. Abort Dial In. TEST	Accepted TEST —_##
ENTER key	Validate input. If OK, accept ENTER key, update parameters, initiate outgoing call. (See Note.) →_— If not OK, ✕*#? →_—	Rejected ✕-f —_##
CLEAR key	Accepted. Restore Dial-In. —_#?	Accepted. Clear screen. —_##
PA, PF, ATTN, SYS REQ keys	Rejected. ✕-f —_#?	Rejected. ✕-f —_##

**Note:** This indicator is broadcast to all powered terminals.

**Figure D-1. Control Unit/Terminal Responses in Dial-In State**

### D.9.3 Data Ready

When the circuit D-1 is connected, the Outgoing Call in Process indicator is reset and the In-Use indicator is displayed in the Operator Information Area.

### D.9.4 Disconnection

The DISC key is pressed whenever the operator wants to disconnect the circuit. If there are SNA sessions active (bound), the 3274 may have been customized so that the first disconnect sequence results in the display of the Operator Communication Check indicator. This serves as a reminder that there are sessions active.

If the DISC key sequence is re-initiated with no intervening RESET key action, the 3274 initiates a disconnection from the circuit by sending the appropriate Clear Request packet. If the RESET key is used to reset the input-inhibited condition, the entire sequence is reset and the next DISC key operation is also inhibited. DISC keys pressed when no sessions are active initiate an immediate disconnection.

A customizing option is provided that allows the DISC key to immediately initiate a disconnection regardless of the status of the LU sessions.

Also, any Clear Indication packet received by the 3274 initiates a circuit disconnection and causes the 3274 to send a Clear Confirmation packet. The cause and diagnostic codes from the Clear Indication packet are displayed in the Operator Information Area.

The Disconnect in Process state is entered when the DISC key operation is accepted, when a QDISC packet is received, or when the station is closed due to detected SNA-level errors.

The Call Ready indicator replaces the Disconnect in Process indicator when the line is successfully disconnected. If not in Dial mode, the screen is unchanged. If in Dial mode, the dialing terminal's screen is cleared and Disconnect in Process state is entered. Sessions are reset if they exist, and all session-related indicators, including Online, Ownership, System, Wait, etc., are reset.

The In-Use indicator is turned off when disconnection is complete. A new Call Request packet is required to re-establish the connection.

### D.9.5 Cause and Diagnostic Indicators

Cause and Diagnostic indicators are displayed in the Operator Information Area to aid in user problem determination for abnormal disconnection. They are displayed with the Call Ready indicator when cause and/or diagnostic codes are received by or transmitted from the 3274 due to an error condition. They are not displayed when the 3274 operator causes a normal disconnect via the DISC key function. Cause and diagnostic codes are also displayed with the X.25 Communication Reminder indicator and indicate the cause and diagnostic codes from a restart packet transmitted by or received from the 3274.

*Note: These codes are the CCITT-recommended, and IBM-architected, codes. However, these codes may not apply, nor be common to, all networks. The codes and indicators are defined in Chapter 2, "Operator Information Area Layout", of this manual.*

### D.9.6 Incoming Call

Incoming Call Request packets are accepted in Call Ready state and the Incoming Call in Process indicator is displayed. This indicator is reset when the circuit is connected.

### D.9.7 Local Mode

In Local mode, incoming calls and all outgoing requests are rejected. The 3274 is disconnected from the link.

The LOCAL key is accepted in the Call Ready state and the Local Mode indicator is displayed on all the display station screens.

The COMM key is pressed to reset Local mode. The Call Ready state is entered and the link is initialized.

### D.9.8 Exceptional Case Handling

The operator should take action as follows:

- (1) Call Ready indicator with C&D codes or X.25 Communication Reminder

For a dial request, this indicator means the request has failed with the network reason specified by the C&D codes. In all cases, the operator should consult the appropriate manual which suggests a recovery action for each C&D code.

- (2) Communication Reminder indicator while in X.25 SVC mode.

An operator can re-try the call if appropriate, and can determine the state of the connection by the In-Use indicator. If the In-Use indicator is not displayed, the COMM key can be used to reset the Communication Reminder indicator. X.25 keys that are allowed in a particular X.25 state (that is, do not result in display of the Operator Communication Check indicator) reset the Communication Reminder indicator. If the error persists, the problem determination procedures identified by the particular nnn number should be followed. Refer to Appendix B of this manual for a listing of nnn numbers.

- (3) Machine Check while in X.25 SVC Mode.

This means an error was detected in the 3274 subsystem. The same action as for the base 3274 should be followed.

No unique Machine Check numbers are generated.

### D.10 X.25 SVC STATES AND KEY OPERATION

This section defines how to treat a key when it is pressed in X.25 SVC-specific states.

Figure D-2 summarizes this section.

In this section, keys other than the following are called "Other" keys.

- DIAL, LOCAL, DISC, and COMM keys
- AID keys(\*)
- TEST key
- SYS REQ key(\*\*)

\*The ATTN key is treated in the same way as the AID keys in this section.

\*\*The SYS REQ key is treated as in the base machine.



Status	Operation		
	DIAL Key Pressed	ENTER Key Pressed (Dial In complete)	DISC Key Pressed
Call Ready	Accepted. *1 — #? or — ##	Accepted. ← —	Ignored. — —
Call Ready with C&D Codes	Accepted. *1 — #? or — ##	Accepted. ← —	Accepted. *2 — —
Outgoing Call in Process	Rejected. ✕ — ← —	Rejected. ✕ — ← —	Accepted. — —
Incoming Call in Process	Rejected. ✕ — ← —	Rejected. ✕ — ← —	Accepted. — —
Data Ready	Rejected. ✕ —	Rejected. ✕ —	Accepted. — —
Disconnect in Process	Rejected. ✕ — — —	Rejected. ✕ — — —	Ignored. — —
Local	Rejected. ✕ — — 599	Rejected. ✕ — — 599	Rejected. ✕ — — 599
X.25 Communication Reminder	Rejected. ✕ — — XCCDD	Rejected. ✕ — — XCCDD	Rejected. ✕ — — XCCDD

\*1 See Figure D-1 for indicators displayed by Dialing terminal and Other terminals.

\*2 Reset cause and diagnostic (C&D) codes.

**Figure D-2 (Part 1 of 4). Key Operations During X.25 States**

Status	Operation		
	LOCAL Key Pressed	AID Key Pressed	COMM Key Pressed *4
Call Ready	Accepted. ↘ 599	Rejected. X-f    —	Ignored. —
Call Ready with C&D Codes	Accepted. ↘ 599	Rejected. X-f    ↘ XCCDD	Accepted. *5 —
Outgoing Call in Process	Rejected. X† —    ←	Rejected. X-f    →	Ignored. —
Incoming Call in Process	Rejected. X† —    ←	Rejected. X-f    ←	Ignored. —
Data Ready	Rejected. X† —	Same as base machine. X-f	Ignored.
Disconnect in Process	Rejected. X† —    —	Rejected. X-f    —	Ignored. —
Local	Ignored. ↘ 599	Rejected. X-f    ↘ 599	Accepted. ↘ 506
X.25 Communication Reminder	Accepted. ↘ 599	Rejected. X-f    ↘ XCCDD	Rejected. X† —    ↘ XCCDD

\*4 Reset Operator Communication Check indicator.  
\*5 Reset C&D codes.

Figure D-2 (Part 2 of 4). Key Operations During X.25 States

Status	Operation			
	Extension Key Pressed	TEST Key Pressed	PA, PF, ATTN or SYS REQ Key Pressed	DATA Keys, LOCAL Key, or CLEAR Key Pressed
Extension	Exit Extension mode.	Exit Extension mode. X ? ‡	Exit Extension mode. X ? ‡	Exit Extension mode. X ? ‡
Dial	Accepted. ▶	Abort Dial In. *7  TEST	Rejected. *7  X-f —_#? or —_##	Accepted. *7  —_#? or —_##
Test	X -f TEST	Exit Test mode.	X -f TEST	Accepted.  TEST

▶ = Extension

\*7 See Figure D-1 for indicators displayed by Dialing terminal and Other terminals.

**Figure D-2 (Part 3 of 4). Key Operations During X.25 States**

Status	Operation								
	Extension Key Pressed	TEST Key Pressed	PA Key Pressed	PF Key Pressed	ATTN Key Pressed	SYS REQ Key Pressed	DATA Key Pressed	LOCAL Key Pressed	CLEAR Key Pressed
Print ID	Abort Print ID. ▶	Abort Print ID.  TEST	Abort Print ID.  X ? +	Abort Print ID.  X ? +	Abort Print ID.  X-f	Abort Print ID.  Accepted.	Not Aborted Data Key = Numeric: Printer Status □ □ ■ _____ Alpha: Printer Status □ □ ALPHA _____	Not Aborted  Accepted.	Abort Print ID.  X ? +
Dead-key operation in process	Abort Dead key. ▶	Abort Dead key.  TEST	See Note  X † +?	See Note  X † +?	Accepted.	Accepted.	a, e, i, o, u Accepted. Not a, e, i, o, u X † +? See Note	Accepted.	See Note  X † +?
X.25 Communication Reminder	Accepted. ▶	Enter Test mode.  TEST	X-f —_— XCCDD				Accepted.	X † —_—	Accepted.

▶ = Extension

See Figure D-1 for Indicators displayed by Dialing terminal and Other terminals.

**Note:** Accent symbols shown (˘) may be any valid accent symbols. For example: /, ^, etc.

**Figure D-2 (Part 4 of 4). Key Operations During X.25 States**

## D.11 INDICATORS

### D.11.1 Call Ready

While the Call Ready indicator is displayed:

- DIAL, LOCAL, TEST, and "Other" keys are accepted
- DISC and COMM keys are ignored
- AID keys are rejected with 'X-f' indicator

If the C&D codes are displayed with the Call Ready indicator:

- DISC and COMM keys clear the C&D codes and all the "Other" keys are treated in the same way as above.

### D.11.2 Dial-In

While outgoing Call in Process indicator is displayed:

#### D.11.2.1 At Dial-Originating Station

- DIAL, LOCAL, DISC, TEST\*, ENTER, and "Other" keys are accepted
- COMM key is ignored
- AID keys (except ENTER and CLEAR are rejected with 'X-f' indicator

\* TEST key aborts the Dial-In mode.

#### D.11.2.2 At Other Stations

- DIAL and LOCAL keys are rejected with Operator Communication Check indicator
- DISC key is accepted
- COMM key is ignored
- TEST key and "Other" keys are accepted
- AID keys are rejected with 'X-f' indicator

### D.11.3 Outgoing Call In Process

While outgoing Call In Process indicator is displayed:

- DISC, TEST, and "Other" keys are accepted
- DIAL and LOCAL keys are rejected with Operator Communication Check indicator
- COMM key is ignored
- AID keys are rejected with 'X-f' indicator

### D.11.4 Incoming Call in Process

While Incoming Call in Process indicator is displayed:

- DISC, TEST, and "Other" keys are accepted
- DIAL and LOCAL keys are rejected with Operator Communication Check indicator
- COMM key is ignored
- AID keys are rejected with 'X-f' indicator

### D.11.5 Data Ready (In-Use)

The In-Use indicator is displayed in location 7. No indicator is displayed in Reminder area when the virtual circuit connection with the X.25 network has been established.

- AID, TEST, DISC, and "Other" keys are accepted
- DIAL and LOCAL keys are rejected with Operator Communication Check indicator
- COMM key is ignored

### D.11.6 Disconnect In Process

While Disconnect in Process indicator is displayed:

- TEST and "Other" keys are accepted
- DISC and COMM keys are ignored
- DIAL and LOCAL keys are rejected with Operator Communication Check indicator
- AID keys are rejected with 'X-f' indicator

### D.11.7 Local

Communication Reminder indicator with the number of '599' is displayed in Local mode, and

- COMM, TEST, and "Other" keys are accepted
- LOCAL key is ignored
- DISC and DIAL keys are rejected with Operator Communication Check indicator
- AID keys are rejected with 'X-f' indicator

### D.11.8 X.25 Communication Reminder Indicator

The X.25 Communication Reminder indicator is displayed when the link is closed due to the transmission or receipt of a restart packet.

In SVC applications, it is replaced with the Call Ready indicator with C&D codes when the link has been successfully opened. While the Communication Reminder indicator is displayed, all X.25 keys, except LOCAL, are rejected with the Operator Communication Check indicator displayed. The LOCAL key puts the 3274 in Local mode.

In PVC connections, the indicator is displayed until the circuit is successfully re-opened .

## D.12 EXTENSION KEY

### D.12.1 Extension Mode

Extension mode is defined to create additional key functions for X.25 Switched operation on the keyboards of the 3178, 3278, 3279, and other compatible DCA-protocol-attached display stations.

1. Extension mode is entered at any time, except during Test mode, a Machine Check, or a no-security-key condition, by pressing the Extension key.
2. '>' is displayed in the Shifts and Modes area of the Operator Information Area while in Extension mode.
3. Pressing the Extension key while in Extension mode resets Extension mode.
4. The RESET key operates normally in Extension mode but does not reset Extension mode.
5. The ALT key is treated as a NOP (ignored).

6. While in Extension mode at an authorized display station, if any key other than the X.25 function keys, LOAD MATRIX key, or key #14 (to display the Last Transaction Time indicator), the ALT key, or the RESET key is pressed, the Re-try indicator is displayed and Extension mode is reset.
7. When RAS /0 Test is directed to a terminal in Extension mode, Extension mode is reset, the terminal enters Test mode, and the test is executed.
8. When Extension mode is exited, the shift indicators are restored to the state they were in before the depression of the Extension key.
9. Depression of the Extension key is ignored when the terminal is attached to a 3274 port that is not configured to support the Extension key function.

Figure D-3 summarizes Extension mode.

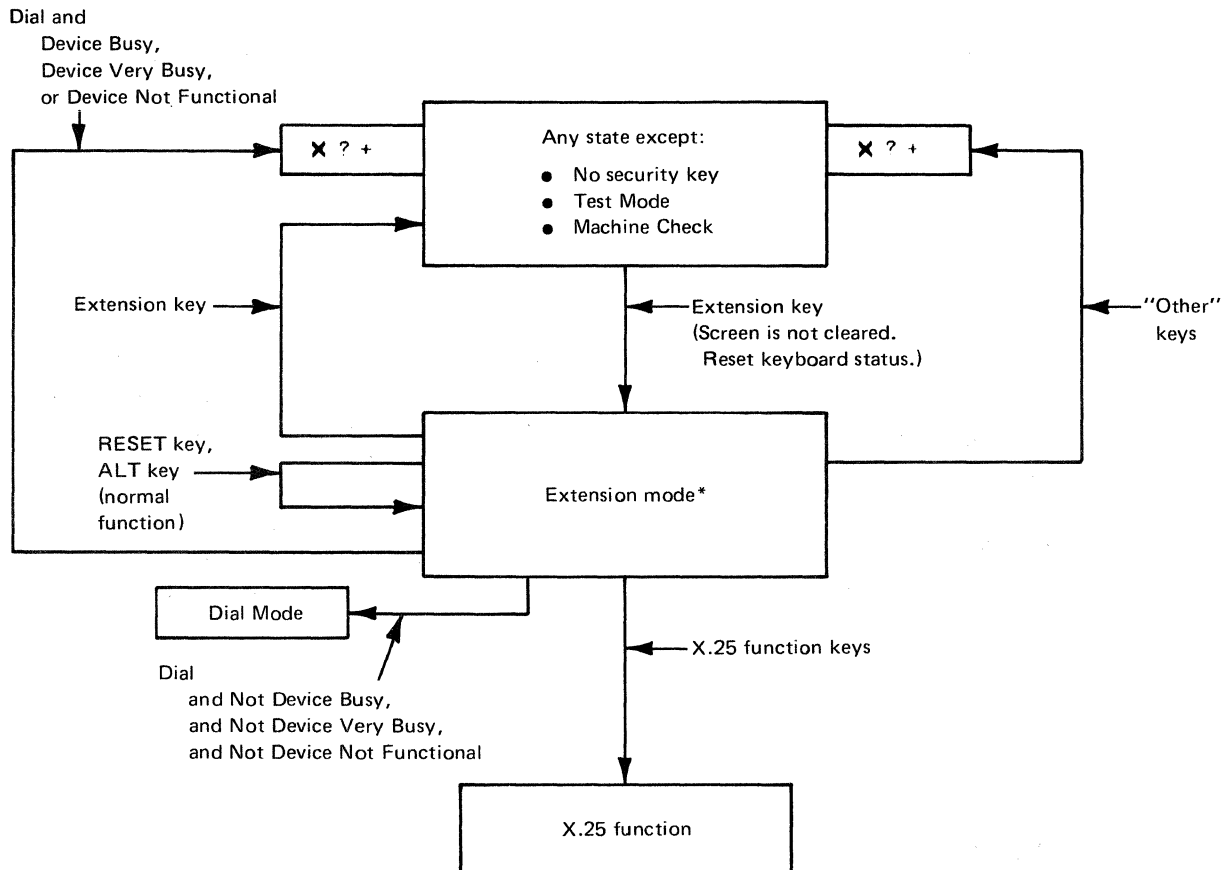

\* Indicate '>' in the shift status field of the Operator Information Area.

Figure D-3. Extension Mode Definition

### D.12.2 Extension Key and X.25 Function Keys

Figure D-4 defines key positions for the Extension key and the X.25 function keys.

**Note:** *These key functions are available on DCA-attached terminals only. They are not available on distributed-function terminals (e.g., the 3290 Information Panel).*

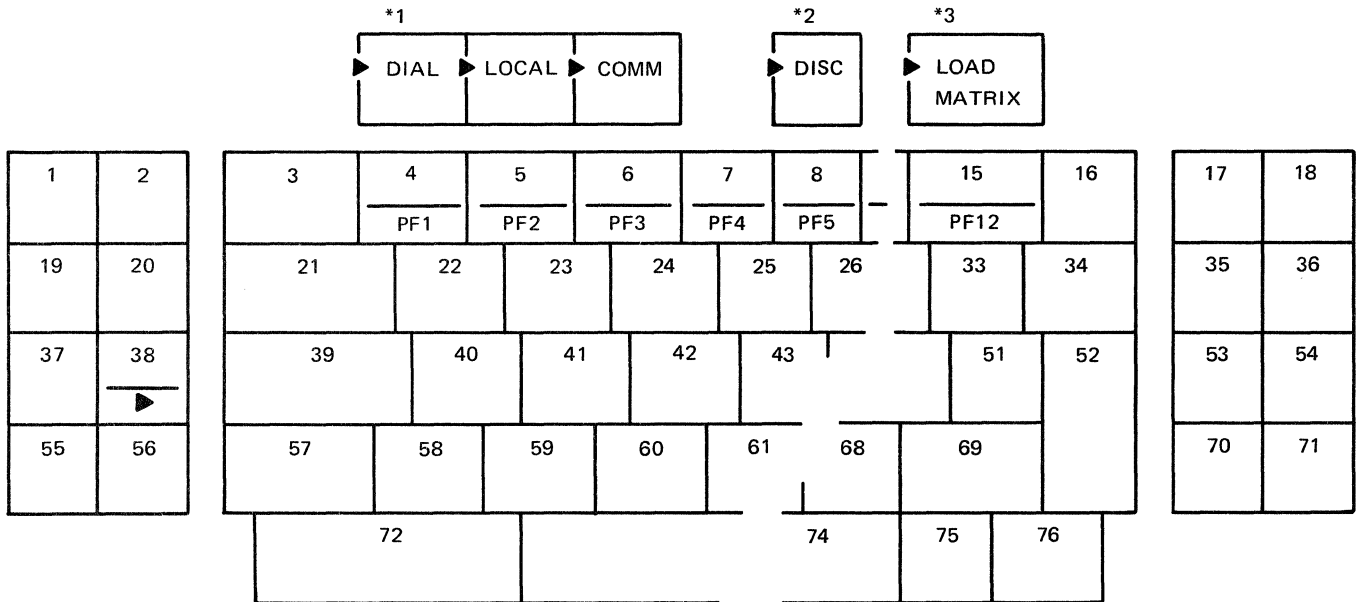

> Label (decal) on keyface identifies Extension key.

\*1 Each of these labels (decals) is applied by the customer to the display station keyboard. The labels are applied as shown next to the key that assumes the corresponding X.25 function following depression of the Extension key.

\*2 The DISC key is separated from the other keys by at least one key space to avoid being pressed in error.

\*3 The LOAD MATRIX key function is available only at a display station attached to port 0 of the 3274 Control Unit.

**Figure D-4. Extension Key and X.25 Function Keys**

## D.13 DIAL MODE SCREEN DESCRIPTION

Figure D-5 shows the layout of the display screen when Dial mode is entered. The screen displays the dial number and the other facility control fields set to the defaults as selected during customizing (or as previously overridden by the operator via a previous Dial operation).

Any values that require change can be updated by the operator. When the screen contains the correct values, the ENTER key is pressed to initiate appropriate action by the 3274.

A customizing option is provided to either display HNAD only or to display all fields shown below on the Dial screen. The default is to display HNAD only.

The cursor is initially positioned in the first character location of the HNAD input field.

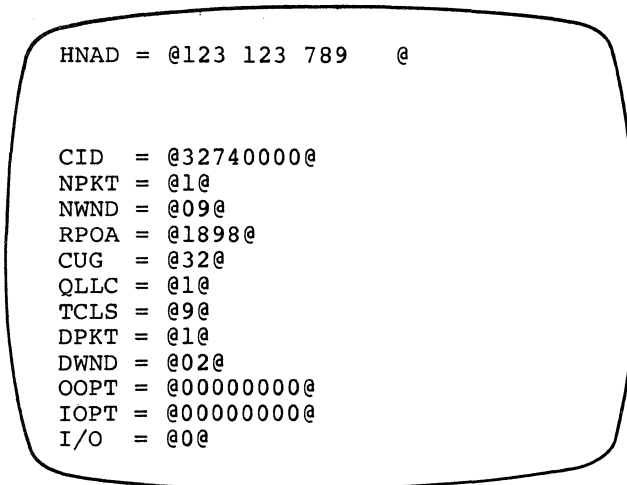

```
HNAD = @123 123 789  @
CID = @32740000@
NPKT = @1@
NWND = @09@
RPOA = @1898@
CUG = @32@
QLLC = @1@
TCLS = @9@
DPKT = @1@
DWND = @02@
OOPT = @00000000@
IOPT = @00000000@
I/O = @0@
```

Where: @ @ delineates an entry field. Rest of screen is protected. Entry is validated. If number of value is invalid, Input-Inhibited and Wrong Number indicators are displayed and the cursor is positioned in the first character location of the invalid field.

Figure D-5. Dial Mode Display Layout

Definition of the input fields shown above follows:

### HNAD

- This 15 character field contains the Host Network (DTE) Address.
- The initial value of this field is set during the customizing procedure (Question 410).

**Note:** A customizing option is provided to inhibit display of the following fields, thereby presenting HNAD only to the operator. Only HNAD is the default.

### CID

- This field contains the CID (connection identifier or network password).
- Input is validated to be 0–9, A–F, blank, or nulls.
- The value in this field may be preset during the customizing procedure (Question 452).
- For security, this is a non-display field.

### NPKT

- This field contains the packet size to be negotiated toward.
- The value of this field is preset during the customizing procedure (Question 430).

### NWND

- This field contains the window size to be negotiated toward.
- The value of this field is preset during the customizing procedure (Question 432).

### RPOA

- This field contains the recognized private operating agency (RPOA) facility ID and is used to select the intermediate network that is to be used between the public networks.
- RPOA may be preset during the customizing procedure (Question 442).

### CUG

- This field allows the closed user group (CUG) facility to be included in an outgoing Call Request packet.
- CUG may be preset during the customizing procedure (Question 441).

## QLLC

- This field defines whether QLLC (Qualified Logical Link Control) or PSH (Physical Service Header) logical link control protocols are used. QLLC is to be used by all "new" IBM products with integrated X.25 support. PSH support will allow the 3274 to communicate with "old" X.25 equipment, namely that equipment attaching to the network via the Network Interface Adapter (NIA) box.  
0 = PSH  
1 = QLLC
- Logical link control may be preset during the customizing procedure (Question 403).

## TCLS

- This field defines the Throughput Class value which the 3274 is to use in throughput class negotiation.
- TCLS may be preset during customizing procedure (Question 440).

## DPKT

- The field contains the default packet size.
- The value of this field is preset during the customizing procedure (Question 434).

## DWND

- This field contains the default window size.
- The value of this field is preset during the customizing procedure (Question 435).

## OOPT

- This field allows the operator to override the outgoing call options (Question 421) selected during the customizing procedure.
- If the circuit type (Question 401) specified during customizing is, incoming call only, this field is not displayed.

## IOPT

- This field allows the operator to override the incoming call options (Question 420) selected during the customizing procedure.
- If the circuit type (Question 401) specified during customizing is, outgoing call only, this field is not displayed.

## I/O

- If the circuit type (Question 401) specified during customizing was two-way call, this input field allows the user to indicate whether the information on the dial screen should be used (when the ENTER key is pressed) to: (1) initiate an outgoing call (value = 0), or (2) only store the (changed) values either to allow an incoming call or as future reference for an outgoing call (value = 1).
- If the circuit type (Question 401) specified during customizing is incoming call only or outgoing call only, this field is not displayed.

## D.14 PERMANENT VIRTUAL CIRCUIT (PVC) DESCRIPTION

### D.14.1 PVC Indicators

An additional indicator is required to convey the network or 3274-supplied cause and diagnostic codes that accompany reset or restart packets. These codes provide the reason for the link being closed. This indicator is called the X.25 Communication Reminder. When a PVC circuit has been connected, the In-Use indicator is displayed in the Operator Information Area.

**Note:** *The Operator Information Area, cause codes and diagnostic codes are described in Chapter 2, "Operator Information Area Layout", in this manual.*

### D.14.2 PVC Keys

Only two of the keys defined earlier in this appendix, "X.25 SVC States and Key Operation", are provided for PVC connections. They are the LOCAL and COMM keys. Optionally, the function of these keys may be deleted from the 3274 via customizing.

#### D.14.2.1 LOCAL Key

The LOCAL key allows a display operator to disconnect the 3274 from the X.25 link. When the LOCAL key is pressed, the 3274 determines if there are any SNA sessions active. The 3274 may have been customized so that if there are no sessions active, the 3274 will immediately initiate a close-link sequence. If there are SNA sessions active, the Operator Communication Check and Input Inhibited indicators are displayed. If the LOCAL key is pressed a second time with no intervening RESET key depression, the close-link sequence is initiated. If the RESET key is pressed to restore the keyboard, two consecutive LOCAL key sequences are required. A customizing option is provided that allows the first depression of the LOCAL key to always perform the close-link sequence. The initiation of a close-link sequence displays the Local indicator.



### D.14.2.2 COMM Key

Pressing the COMM key when in LOCAL mode causes the 3274 to display  $\rightarrow$  506 (which could be displayed for only a split second and therefore not be seen) and try to reopen the link and circuit. When not in local mode, the COMM key is ignored.

## D.15 SUMMARY OF STATES AND INDICATORS

### D.15.1 Primary Virtual Circuit

Figure D-6 provides a summary of PVC States and Indicators.

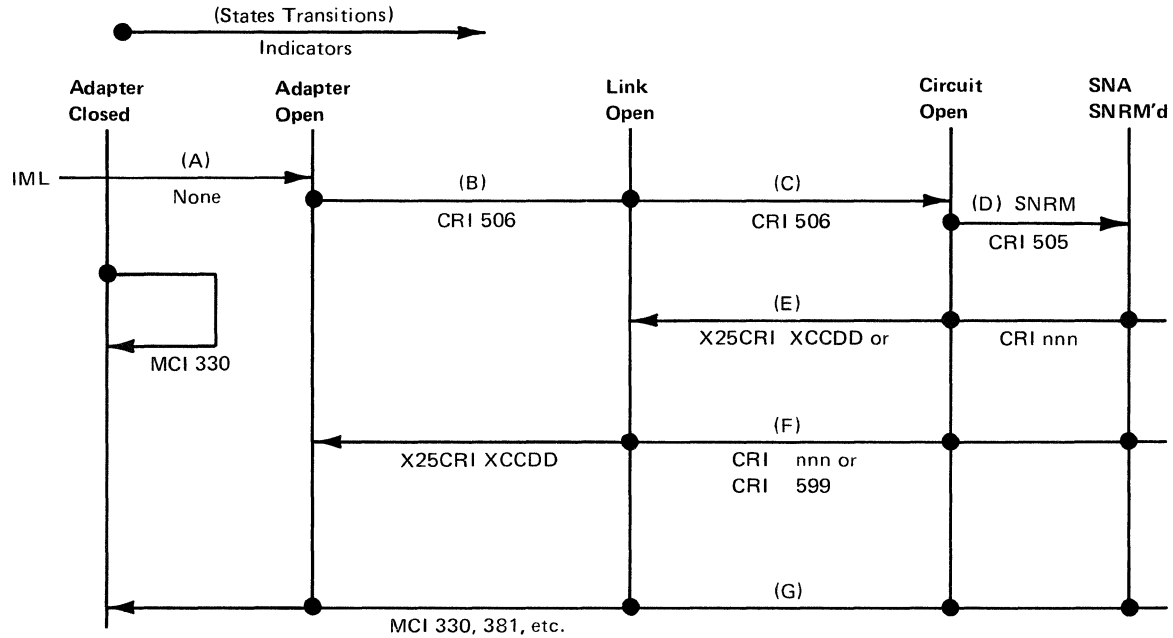

Where: CRI = Communication Reminder indicator (nnn)  
 X25CRI = X.25 Communication Reminder indicator  
 MCI = Machine Check indicator  
 SNRM = set normal response mode

Figure D-6. PVC States and Indicators

## D.15.2 Switched Virtual Circuit

Figure D-7 provides a summary of SVC States and Indicators.

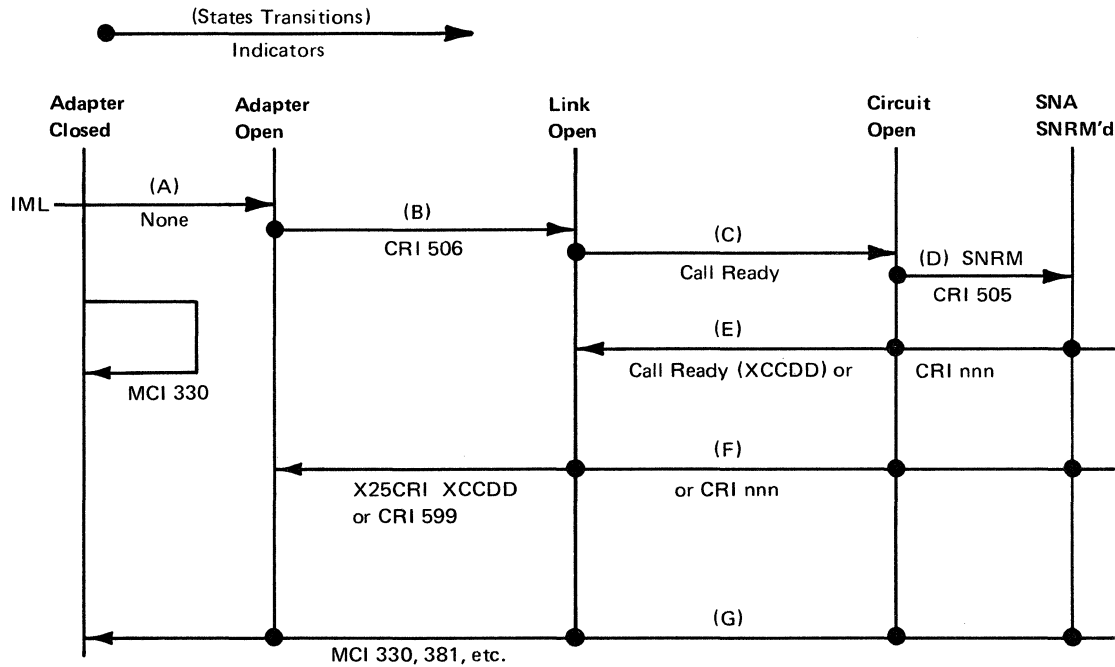

Where:

- CRI = Communication Reminder indicator (nnn)
- X25CRI = X.25 Communication Reminder indicator
- MCI = Machine Check indicator
- Call Ready = Call Ready indicator with C&D codes (XCCDD) when C&D codes are not 0
- SNRM = set normal response mode

Figure D-7. SVC States and Indicators

# List of Abbreviations

## A

**ACK.** Positive acknowledgement.  
**ACTLU.** Active logical unit.  
**ACTPU.** Active physical unit.  
**AID.** Attention Identification.  
**ALT.** Alternate.  
**APL.** A programming language.  
**ARC.** Adapter return code.  
**ASCII.** American Standard Code for Information Interchange.  
**ATT.** Attention.

## B

**B.** Busy.  
**BB.** Begin bracket.  
**BCC.** Block check character.  
**BOC.** Bus out check.  
**bps.** Bits per second.  
**BSC.** Binary synchronous communications.  
**BTDAT.** Buffered Teleprocessing Diagnostic Analyzer and Tester.  
**BTU.** Basic transmission unit.

## C

**C.** Control field.  
**C&D.** Cause and diagnostic (codes).  
**CAC.** Common adapter code.  
**CAW.** Channel address word.  
**CC.** Control check; chain command.  
**CCA.** Common communications adapter.  
**CCITT.** The International Telegraph and Telephone Consultive Committee.  
**CCW.** Channel control word.  
**CD.** Change direction.  
**CDS.** Configuration data set.  
**CID.** Connection identifier.  
**CE.** Channel end.  
**CMDR.** Command reject.  
**CNM.** Communication network management.  
**COAX.** Coaxial (cable).  
**COMM.** Communication.  
**CPS.** Call progress signal.  
**CPU.** Central processing unit.  
**CR.** Command reject; carriage return.  
**CRC.** Cyclic redundancy check.  
**CRV.** Cryptography verification.  
**CSE.** Control storage expansion.  
**CSU.** Channel service unit; customer setup.  
**CSW.** Channel status word.  
**CTR.** Counter.

**CTS.** Clear to send (CCITT 106).  
**CU.** Control unit.  
**CUE.** Control unit end.  
**CUG.** Closed user group.

## D

**DACTLU.** Deactivate logical unit.  
**DACTPU.** Deactivate physical unit.  
**DB.** Device busy.  
**DC.** Device check; data check.  
**DCA.** Device cluster adapter.  
**DCB.** Device control block.  
**DCE.** Data communication equipment.  
**DDSA.** Digital Data Service Adapter.  
**DE.** Device end.  
**DEV.** Device.  
**DFC.** Data flow control.  
**DISC.** Disconnect.  
**DLC.** Data length check.  
**DLE.** Data link escape.  
**DM.** Disconnect mode.  
**DPKT.** Default packet (size).  
**D/R.** Driver/receiver.  
**DSR.** Data set ready (CCITT 107).  
**DTE.** Data terminal equipment.  
**DUP.** Duplicate.  
**DWND.** Default window (size).

## E

**EAU.** Erase all unprotected.  
**EB.** End brackets.  
**EBCDIC.** Extended binary coded decimal interchange code.  
**EC.** Engineering change; equipment check.  
**ECS.** Extended character set.  
**ECSA.** Extended character set adapter.  
**EDS.** Extended data stream.  
**EFCA.** Extended field and character attribute.  
**EIA.** Electronic Industries Association.  
**EM.** End of message.  
**ENQ.** Enquiry.  
**EOF.** End of field.  
**EP.** Emulator program.  
**ERP.** Error recovery procedure.  
**ESC.** Escape.  
**ETB.** End of transmission block.  
**ETX.** End of text.  
**EUA.** Erase unprotected to address.  
**EX.** Exception (response).

## F

**F.** SDLC flag sequence.  
**FCS.** Frame check sequence.  
**FF.** Forms feed.  
**FI.** Format indicator.  
**FM.** Field mark; function management.  
**FMRR.** Frame reject.  
**FRU.** Field replaceable unit.

## G

**GFI.** General format identifier.  
**GP.** General poll.

## H

**HEX.** Hexadecimal.  
**HDLC.** High-level data link control.  
**HNAD.** Host network (DTE) address.  
**HPCA.** High-performance communications adapter.  
**HVPS.** High-voltage power supply.

## I

**I.** Information (format).  
**IC.** Insert cursor.  
**ID.** Identification; identifier.  
**I/D.** Input/output.  
**IML.** Initial machine load.  
**IOPT.** Incoming call option.  
**Ind.** Indicator.  
**IR.** Intervention required.  
**ITB.** End of intermediate transmission block.

## K

**KANA.** Katakana.

## L

**LAPB.** Link access procedure balanced.  
**LC.** Logical channel.  
**LCA.** Local channel attachment (Model 1A).  
**LCID.** Local character set identifier; logical channel identifier.  
**LED.** Light-emitting diode.  
**LF.** Line feed.  
**LHA.** Local host attachment (Model 1B).  
**LIC.** Last in chain.  
**LLC.** Logical link control.  
**LNAD.** Local network address.  
**LRC.** Longitudinal redundancy check.  
**LU.** Logical unit.  
**LUSTAT.** Logical unit status.  
**LVPS.** Low-voltage power supply.

## M

**MAP.** Maintenance analysis procedure.  
**MCM.** Maintenance Concepts Manual.

**MDT.** Modified data tag.  
**MEM.** Memory.  
**MES.** Miscellaneous Equipment Specifications.  
**MHS.** Magnetic hand scanner.  
**MIM.** Maintenance Information Manual.  
**MSR.** Magnetic slot reader.

## N

**NA.** Not applicable.  
**NAK.** Negative acknowledgement.  
**NCCF.** Network communications facility.  
**NCP.** Network control program.  
**NDM.** Normal disconnect mode.  
**NI.** Not initialized.  
**NIA.** Network Interface Adapter.  
**NL.** New line.  
**NOLLC.** No logical link control.  
**NOP.** No operation.  
**NPDA.** Network problem determination application.  
**NPKT.** Negotiated packet (size).  
**Nr.** Next sequence number expected to arrive.  
**NRM.** Normal response mode.  
**NRZ.** Non-return-to-zero (recording).  
**NRZI.** Zero-complemented differential coding (non-return-to-zero inverted).  
**Ns.** Transmitter's sequence number.  
**NS.** Nonsequenced format (C-field).  
**NSA.** Nonsequenced acknowledgement.  
**NSI.** Nonsequenced information.  
**NUL.** Null.  
**NUM.** Numeric.  
**NWND.** Negotiated window (size).

## O

**OAF.** Origin address field.  
**OC.** Operation check.  
**OLT.** Online test.  
**OOPT.** Outgoing call option.

## P

**P.** Printer; protected.  
**PA.** Program access.  
**PCKT.** Packet.  
**P/F.** Poll/final bit.  
**PF.** Program function.  
**PCM.** Plug-compatible mode.  
**PIU.** Path information unit.  
**POR.** Power on reset.  
**PS.** Physical services; Programmed Symbol.  
**PSDN.** Packet switched data network.  
**PSH.** Physical Services Header.  
**PSWD.** Password.  
**PT.** Program tab.  
**PU.** Physical unit.  
**PVC.** Permanent virtual circuit.

## Q

**QFRMR.** Qualified frame reject response.  
**QLLC.** Qualified Logical Link Control.  
**QSM.** Qualified set mode.

## R

**RA.** Repeat to address.  
**Rd. Mod.** Read modified.  
**RECFMS.** Record formatted maintenance statistics.  
**Req.** Request.  
**REQMS.** Request maintenance statistics.  
**RH.** Request/response header.  
**RI.** Ring indicator.  
**RLSD.** Received Line Signal Detector (CCITT 109).  
**RNR.** Received not ready.  
**ROL.** Request online status.  
**RPOA.** Recognized private operating agency.  
**RQI.** Request initialization.  
**RR.** Received ready.  
**RSOR.** Read Start Old Receive.  
**RSP.** Response.  
**RTM.** Response Time Monitor.  
**RTS.** Request to send.  
**RU.** Request/response unit.  
**RVI.** Reverse interruption.

## S

**S.** Sequenced (format).  
**SA.** Switched adapter.  
**SABM.** Set asynchronous balance mode (command).  
**SARM.** Set asynchronous response mode.  
**SBA.** Set buffer address.  
**SC.** Session control.  
**SDLC.** Synchronous data link control.  
**SDT.** Start data traffic.  
**SERDES.** Serializer/Deserializer.  
**SF.** Start field.  
**SFAP.** Structured field and attribute processing.  
**SI.** Suppress index.  
**SIM.** Set initialization mode.  
**SIOF.** Start I/O Fast Release.  
**SLHA.** Simplified local host attachment.  
**SLU.** Secondary logic unit.

**SM.** Status modifier.  
**SNA.** Systems network architecture.  
**SNRM.** Set normal response mode.  
**SOH.** Start of heading.  
**SP.** Space; specific poll.  
**SRM.** Set Reply Mode.  
**SSC.** Subsystem Support Center.  
**SSCP.** System services control point.  
**STX.** Start of text.  
**SVC.** Switched virtual circuit.  
**SYN.** Synchronous idle.  
**SYS REQ.** System request.

## T

**TC.** Transmission check.  
**TCLS.** Throughput class.  
**TH.** Transmission header.  
**TP.** Teleprocessing.  
**TPLM.** TP line monitor.  
**TTD.** Temporary text delay.

## U

**UA.** Unnumbered acknowledge.  
**UC.** Unit check.  
**UCW.** Unit control word.  
**UE.** Unit exception.  
**UI.** Unnumbered informational.  
**UKPSS.** United Kingdom Packet Switching Service.  
**US.** Unit specify.

## V

**VTAM.** Virtual telecommunications access method.

## W

**WACK.** Wait before transmit.  
**WCC.** Write control character.  
**WNO.** Window.  
**WSF.** Write Structured Field.

## X

**XID.** Exchange station identification.

3274 Control Unit  
Models 51C, 52C, and 61C  
Maintenance Concepts  
Order No. SY27-2528-5

READER'S  
COMMENT  
FORM

This manual is part of a library that serves as a reference source for systems analysts, programmers, and operators of IBM systems. This form may be used to communicate your views about this publication. They will be sent to the author's department for whatever review and action, if any, are deemed appropriate. Comments may be written in your own language; use of English is not required.

IBM may use or distribute any of the information you supply in any way it believes appropriate without incurring any obligation whatever. You may, of course, continue to use the information you supply.

Note: Copies of IBM publications are not stocked at the location to which this form is addressed. Please direct any requests for copies of publications, or for assistance in using your IBM system, to your IBM representative or to the IBM branch office serving your locality.

How did you use this publication?

- |                          |                                     |                          |                        |
|--------------------------|-------------------------------------|--------------------------|------------------------|
| <input type="checkbox"/> | As an introduction                  | <input type="checkbox"/> | As a text (student)    |
| <input type="checkbox"/> | As a reference manual               | <input type="checkbox"/> | As a text (instructor) |
| <input type="checkbox"/> | For another purpose (explain) _____ |                          |                        |

Is there anything you especially like or dislike about the organization, presentation, or writing in this manual? Helpful comments include general usefulness of the book; possible additions, deletions, and clarifications; specific errors and omissions.

Page Number:

Comment:

What is your occupation? \_\_\_\_\_

Newsletter number of latest Technical Newsletter (if any) concerning this publication: \_\_\_\_\_

If you want a reply, give your name and address:

IBM branch office serving you \_\_\_\_\_

Thank you for your cooperation. No postage stamp necessary if mailed in the U.S.A. (Elsewhere, an IBM office or representative will be happy to forward your comments or you may mail directly to the address in the Edition Notice on the back of the title page.)

Note: Staples can cause problems with automated mail sorting equipment.  
Please use pressure sensitive or other gummed tape to seal this form.

**Reader's Comment Form**

Cut or Fold Along Line

Fold and tape

Please Do Not Staple

Fold and tape



NO POSTAGE  
NECESSARY  
IF MAILED  
IN THE  
UNITED STATES

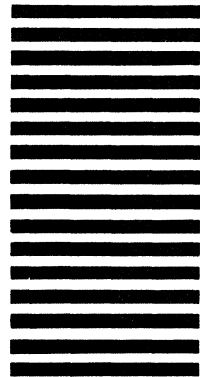

**BUSINESS REPLY MAIL**  
FIRST CLASS      PERMIT NO. 40      ARMONK, N.Y.

POSTAGE WILL BE PAID BY ADDRESSEE:

**International Business Machines Corporation**  
Department 52Q  
Neighborhood Road  
Kingston, New York 12401

Fold and tape

Please Do Not Staple

Fold and tape

3274 Control Unit Models 51C, 52C, and 61C Maintenance Concepts Printed in U.S.A. SY27-2528-5



3274 Control Unit Models 51C, 52C, and 61C Maintenance Concepts Printed in U.S.A. SY27-2528-5

