

INSTITUTE FOR ADVANCED PROFESSIONAL STUDIES

*Technology Consultation and Training Worldwide*

955 MASSACHUSETTS AVENUE

CAMBRIDGE, MASSACHUSETTS 02139-3107

(617) 497-2075 • FAX: (617) 497-4829 • email@iaps.com

# **OSF/1 Internals**

Volume II

For the Technical Staff of

Digital Equipment Corporation

Colorado Springs

Release 1.0

## **Copyright Notice**

The material in this binder is either Copyright 1992 by the Institute for Advanced Professional Studies or Open Software Foundation, or reproduced for use in this course by IAPS with permission from the copyright holder.

All rights reserved. No part of this publication may be reproduced, stored in a retrieval system, or transmitted, in any form or by any means, electronic, mechanical, photocopying or otherwise, without the prior written permission of the Institute for Advanced Professional Studies.

Additional copies of these materials are available strictly through the Institute for Advanced Professional Studies, 955 Massachusetts Avenue, Cambridge, MA 02139.

The ideas and designs set forth in the course materials are the property of the Institute for Advanced Professional Studies. These materials are not to be distributed to third persons without the express written permission of IAPS.

# Contents

---

## Module 5 — File Systems

Objectives .....	5-2
Representing an Open File .....	5-6
Virtual File Systems .....	5-14
The Buffer Cache .....	5-34
Directory Path Searching .....	5-66
S5 File System .....	5-84
UFS File System .....	5-100
NFS File System .....	5-124
Exercises .....	5-166

---

## Module 6 — Terminal I/O and Device Drivers

Objectives .....	6-1
Special Files .....	6-4
Dynamic Configuration .....	6-10
Device Drivers .....	6-16
Terminal I/O .....	6-30
Exercises .....	6-48

---

## Module 7 — Streams

Objectives .....	7-1
Streams Concepts .....	7-4
Message Flow .....	7-24
Implementation of Streams .....	7-38

Parallelization .....	7-50
Exercises .....	7-60

---

**Module 8 — Sockets**

Objectives .....	8-1
Sockets .....	8-4
Mbufs .....	8-10
Implementation .....	8-26
Sockets and Streams .....	8-34
Exercises .....	8-38

---

**Module 9 — Logical Volume Manager**

Objectives .....	9-1
Role of the LVM .....	9-4
Data Structures .....	9-12
Components and Flow of Control .....	9-26
Exercises .....	9-36

---

**Module 10 — Loader**

Objectives .....	10-1
Role of the Loader .....	10-4
Symbol Resolution .....	10-10
Data Structures and Flow of Control .....	10-18
The Run-time Image .....	10-22
Dynamic Loading .....	10-26
Exercises .....	10-30

---

**Module 11 — Security**

Objectives .....	11-1
Security Concerns .....	11-4
Auditing .....	11-12
Access Control .....	11-16
Authorizations and Privileges .....	11-28
Living with Security .....	11-44
Exercises .....	11-46

---

Appendix .....	A-1
----------------	-----

---

**Bibliography** ..... B-1

---

**Glossary** ..... G-1

---

**Index**



# Module 5 —File Systems

---

## Module Contents

1. Representing an Open File .....	5-6
Open file data structures	
Coping with parallelism	
2. Virtual File Systems .....	5-14
Representing multiple file system types	
Mounting file systems	
File-system-independent data structures	
File-system-independent flow of control	
3. The Buffer Cache .....	5-34
Multibuffered I/O	
Representing the cache	
Maintaining consistency	
Parallelizing the cache	
Interaction with mmap	
4. Directory Path Searching .....	5-66
Coping with multiple types of file systems	
Mount points	
Symbolic links	
Concurrency	
Speed	
5. S5 File System .....	5-84
Inodes	
Disk map	
S5 organization	
6. UFS File System .....	5-100
Directories	
Disk layout	
Parallelization	
7. NFS File System .....	5-124
NFS semantics	
Server and client implementation	
Mount protocol	
Effects of crashing	
Reliability	
Parallelization	

## Module 5 — File Systems

### Module Objectives

In order to demonstrate an understanding of the virtual-file-system interface and of OSF/1's implementations of the S5, UFS, and NFS file systems, the student should be able to:

- explain the use of the reference count in the system file table entries
- explain the roles of the *vfsops* and *vnodeops* data structures and the abstraction of the file system concept
- describe how the buffer cache has been parallelized
- describe how directories are protected from concurrent updates
- give the size constraints on files in the S5 and UFS file systems
- explain how two threads may simultaneously extend the size of two different files within the same UFS file system
- explain why it is necessary for a NFS server to maintain a queue of recent NFS requests



# Module 5 — File Systems

# Module 5 — File Systems

## 5-1. The Big Picture

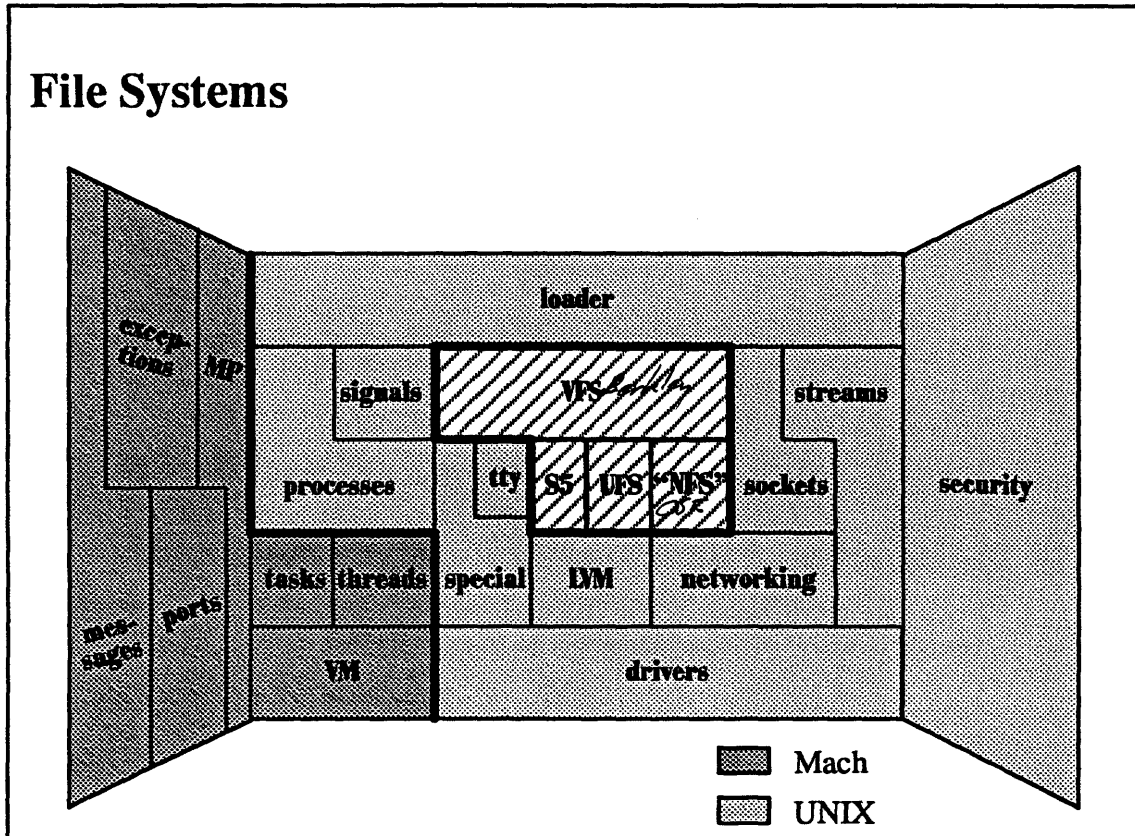

5-1.

© 1990, 1991 Open Software Foundation

## Module 5 — File Systems

---

### Student Notes: File Systems

The file subsystem is part of the UNIX portion of OSF/1. The user interface to the file subsystem is that of UNIX. The implementation is primarily based on that of 4.4BSD. What has been added in OSF/1 is the *parallelization* of the file system.

The VFS implementation is from BSD but has been parallelized. The S5 implementation is from SVR3 and has not been parallelized; it is included mainly for compatibility purposes. The UFS implementation is, of course, from BSD and has been parallelized. The NFS implementation was originally done at the University of Guelph in Canada. It was modified by Berkeley and has been parallelized.

Some of the material of this module is discussed in chapter 11 of Open Software Foundation, 1990a.

# Module 5 — File Systems

## 5-2. Representing an Open File

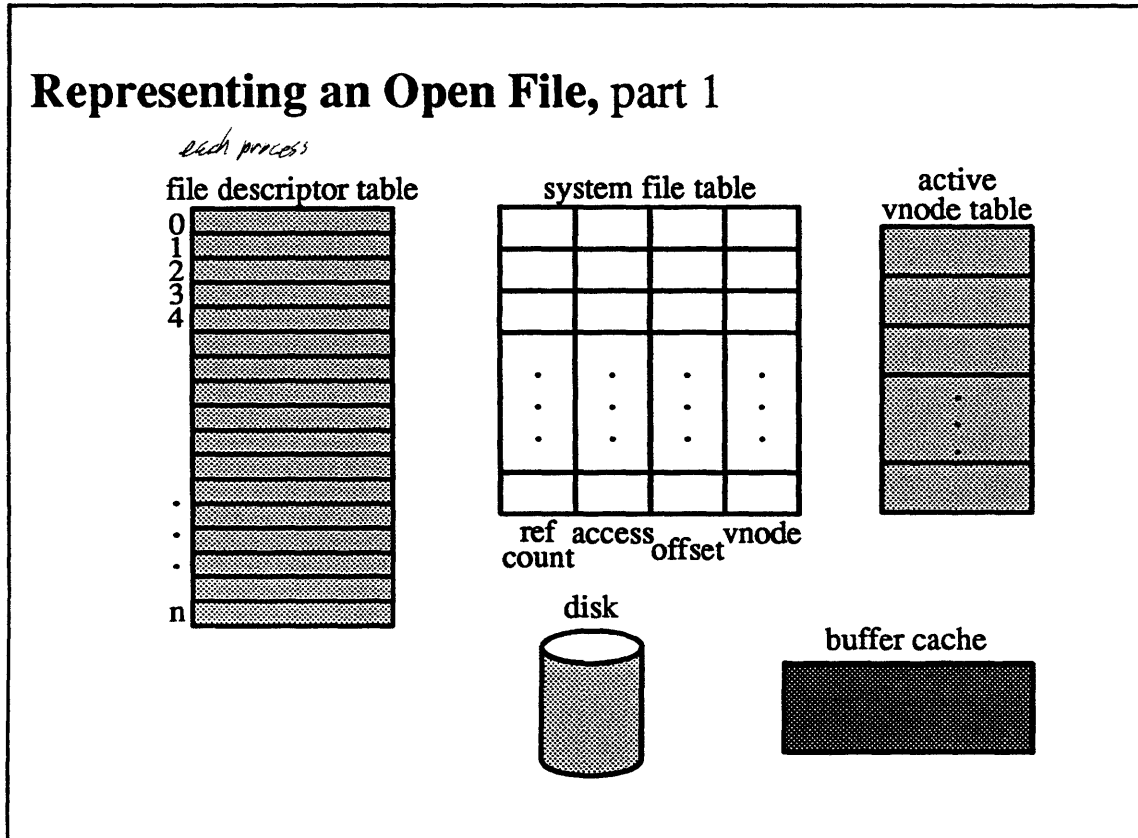

5-2

© 1990, 1991 Open Software Foundation

## Module 5 — File Systems

---

### Student Notes: Representing an Open File, part 1

The set of open files is a property of the process as a whole. Thus, while in traditional UNIX the file descriptor table appears in the *user* structure, in OSF/1 it appears in the *u\_task* structure. This structure is used to map file descriptors representing open files to system file table entries. Each system file table entry represents an open file. As discussed later, each active file (i.e., a file that is open or otherwise being used) is represented by a *vnode* that is entered in the active vnode table. Files are accessed via a kernel-supported *buffer cache* and the file itself is, of course, kept on disk.

# Module 5 — File Systems

## 5-3. Representing an Open File

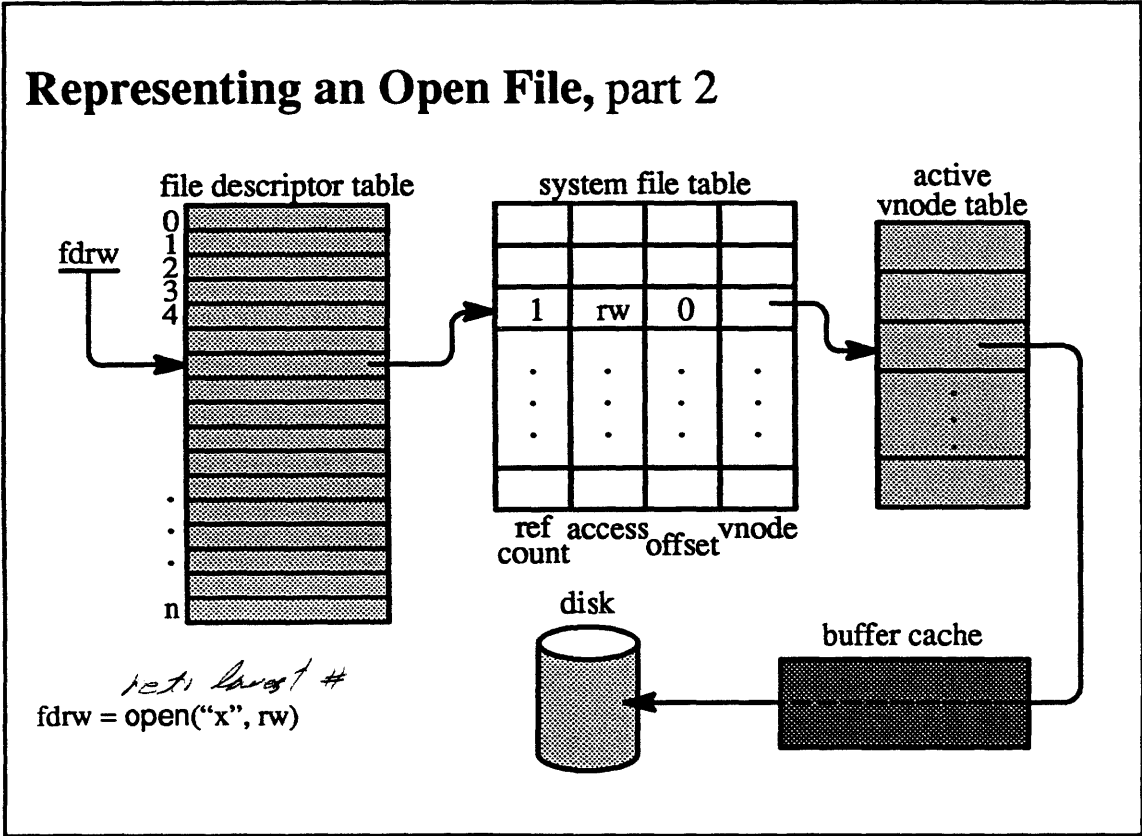

5-3.

© 1990, 1991 Open Software Foundation

## Module 5 — File Systems

### Student Notes: Representing an Open File, part 2

In this picture we illustrate what happens when a file is opened.

The lowest-numbered available file descriptor is allocated from the file descriptor table. Next, an entry in the system file table is allocated, and the file descriptor table entry is set to point to the system file table entry. A vnode for the file is allocated (or found if it already exists) and the system file table entry is set to point to it. Additional fields of the system file table entry are initialized, including:

- a reference count
- the allowed access (i.e., how the file was opened—read-only, read-write)
- the offset (i.e., the location within the file at which the next transfer will start)

In a multithreaded environment like OSF/1's, the reference count takes on particular importance. A reference count of 0, of course, means that the entry is no longer being used. Race conditions, for instance one thread closing the file while another thread within the same task accesses the file, must be guarded against. In addition, data structures such as the system file table entry must not be deallocated while they are in use.

To avoid these problems, when the file is open the reference count is set to 2 (1 for the file descriptor table entry and 1 for the thread performing the open system call). When the thread returns from the call, it removes its reference, reducing the reference count to 1.

If two threads of the same task concurrently close and write the file, the reference count first goes from 1 to 2 (1 for the file descriptor table entry and 1 for the thread within the write system call; the file table's reference count is incremented by 1 at the beginning of each I/O system call, except for the close system call). If the close system call completes first, the reference count will be reduced by 1, to eliminate the file descriptor table entry's reference. But there still is a reference corresponding to the thread performing the write system call, so the file table entry remains allocated and the file remains open until this thread returns from the call. Thus the reference count enables the kernel to ensure that the file table entry and file exist as long as a thread is using them.

Another race condition that must be dealt with concerns the individual file descriptor table entries: when a file is being opened, we need to ensure that the file is not accessed by any other thread until the open has completed. To accomplish this, the file descriptor table entry is not made to point to the allocated file table entry until the open completes. However, we must make certain that this file descriptor table entry is not allocated by some other thread. Thus, when the file descriptor table entry is allocated it is marked as *reserved*. Only when the open completes is it set to point to the file table entry.

# Module 5 — File Systems

## 5-4. Representing an Open File

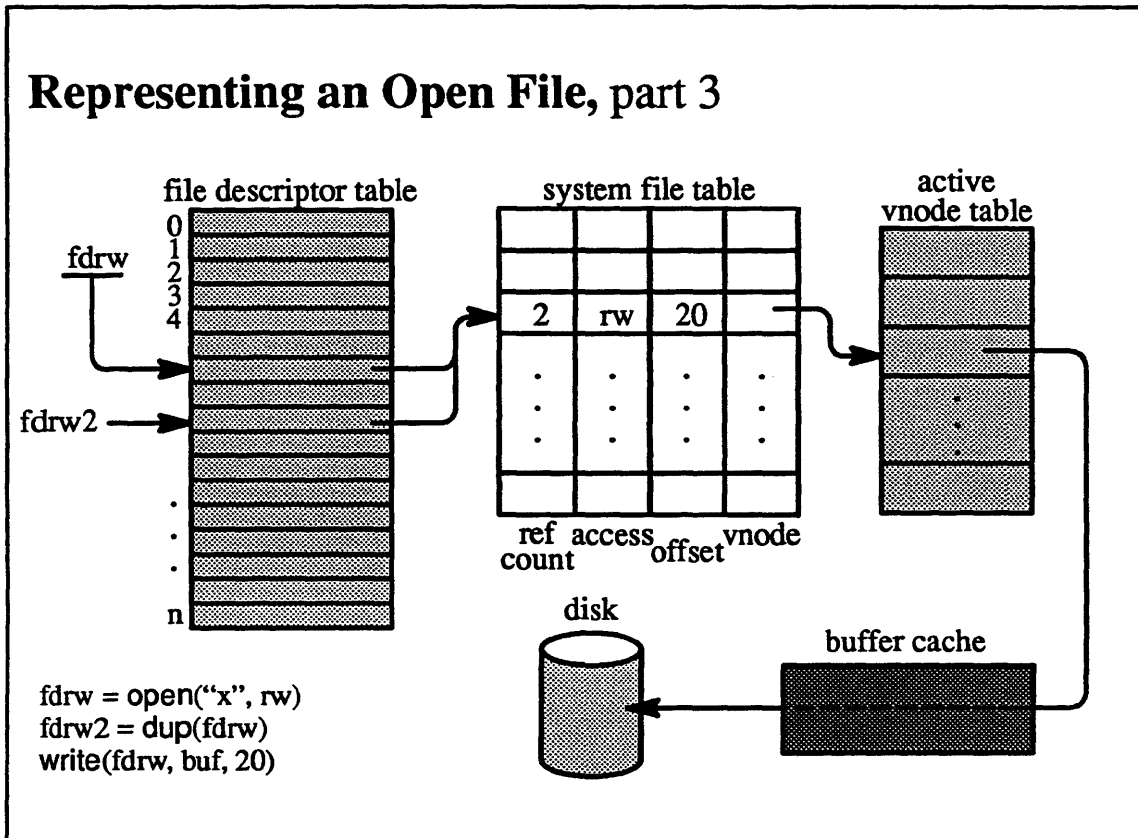

5-4.

© 1990, 1991 Open Software Foundation



## Module 5 — File Systems

---

### Student Notes: Student Notes: Representing an Open File, part 3

Dup was invented to deal with the following problem. By convention, file descriptors 1 and 2 are used for processes' normal and diagnostic output. Normally they both refer to the display, and thus diagnostic output is intermingled with normal output. Suppose, however, one wanted to redirect both file descriptors so that all output, normal and diagnostic, was sent to a file. One might open this file twice, once as file descriptor 1 and again as file descriptor 2, thereby creating two system file table entries. As file descriptor 1 receives output, the offset field of its file table entry advances with each write. After 1000 bytes have been written (sequentially), the offset field is set to 1000, representing the current end-of-file.

If at this point a diagnostic message is written to file descriptor 2, it will start at the beginning of the file, overwriting the data already there, since file descriptor 2's file table entry's offset is still at 0. This outcome is certainly not desirable.

To solve this problem, the dup system call makes file descriptors 1 and 2 both refer to the same file table entry and hence share the offset.

# Module 5 — File Systems

## 5-5. Representing an Open File

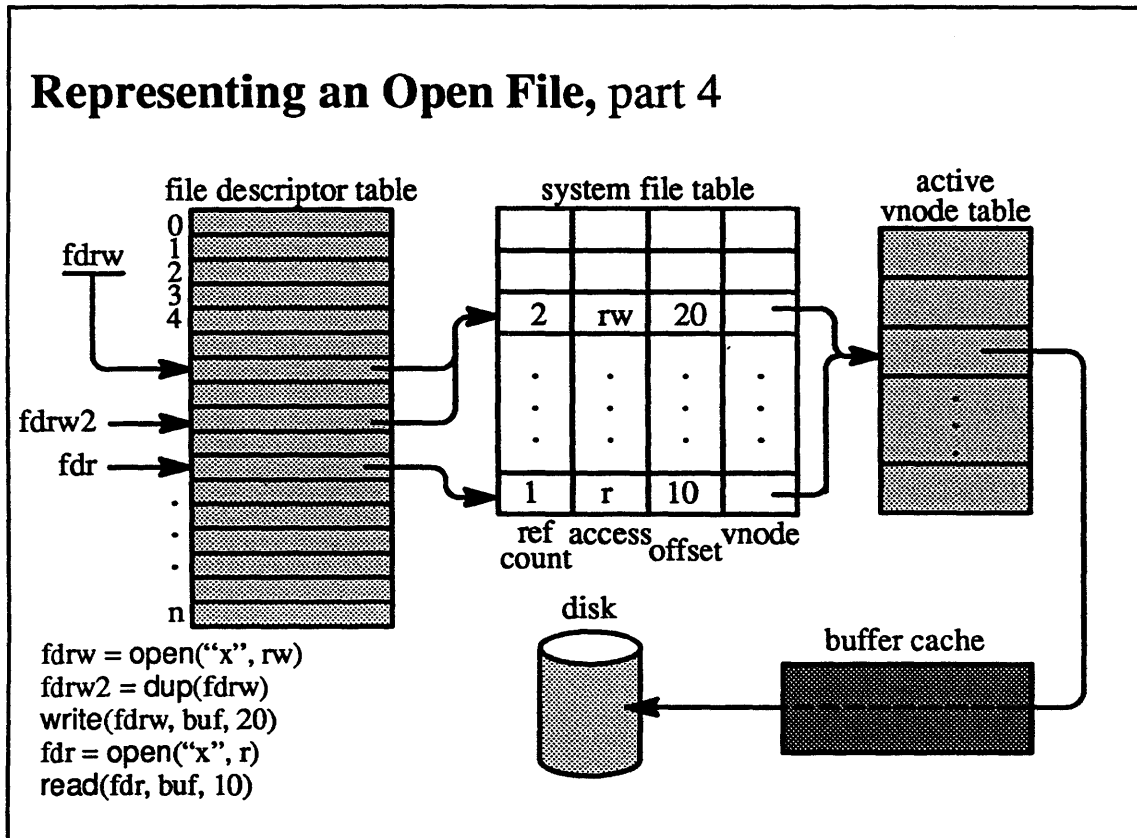

5-5.

© 1990, 1991 Open Software Foundation

## Module 5 — File Systems

---

### Student Notes: Representing an Open File, part 4

In this slide we see the effect of two opens of the same file within the same task.

# Module 5 — File Systems

## 5-6. Virtual File Systems

### Generalizing the File System Concept

*Sun's idea*

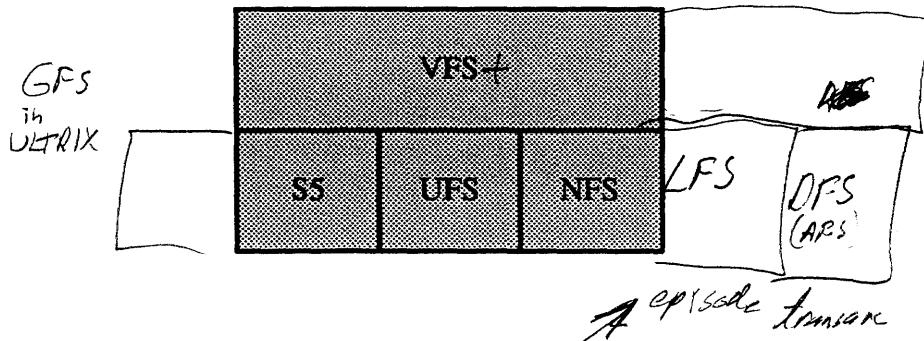

5-6.

© 1990, 1991 Open Software Foundation

*DCE in about a year*

## Module 5 — File Systems

---

### Student Notes: Generalizing the File System Concept

In the beginning, UNIX supported only one type of file system. Modern UNIX systems now support multiple file system types. To represent different file system types, generalizations of the standard file system data structures are used. The scheme adopted in OSF/1 is based on Sun's *virtual file system* (VFS) technology (though the code has been entirely rewritten—it is adapted from 4.4BSD).

# Module 5 — File Systems

## 5-7. Virtual File Systems

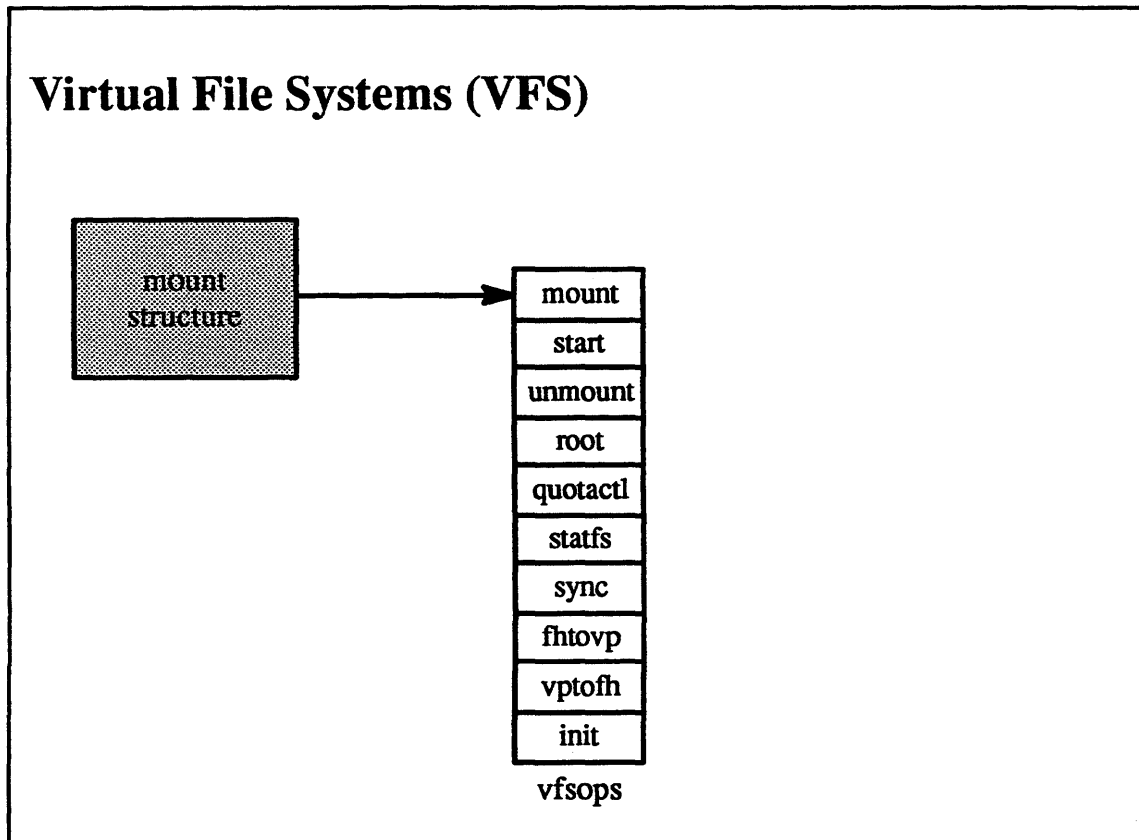

5-7.

© 1990, 1991 Open Software Foundation

## Module 5 — File Systems

---

### Student Notes: Virtual File Systems (VFS)

VFS is the abstraction of a file system that provides a common interface to many different file systems. OSF/1 currently supports the local UNIX file systems (S5 and UFS) and a reimplementation of Sun's NFS.

Each instance of a file system is represented by a *mount structure*. The interface to the file system is represented by an array of entry points, the *vfsops* array, that is attached to the mount structure and defines operations on the file system as a whole.

# Module 5 — File Systems

## 5-8. Virtual File Systems

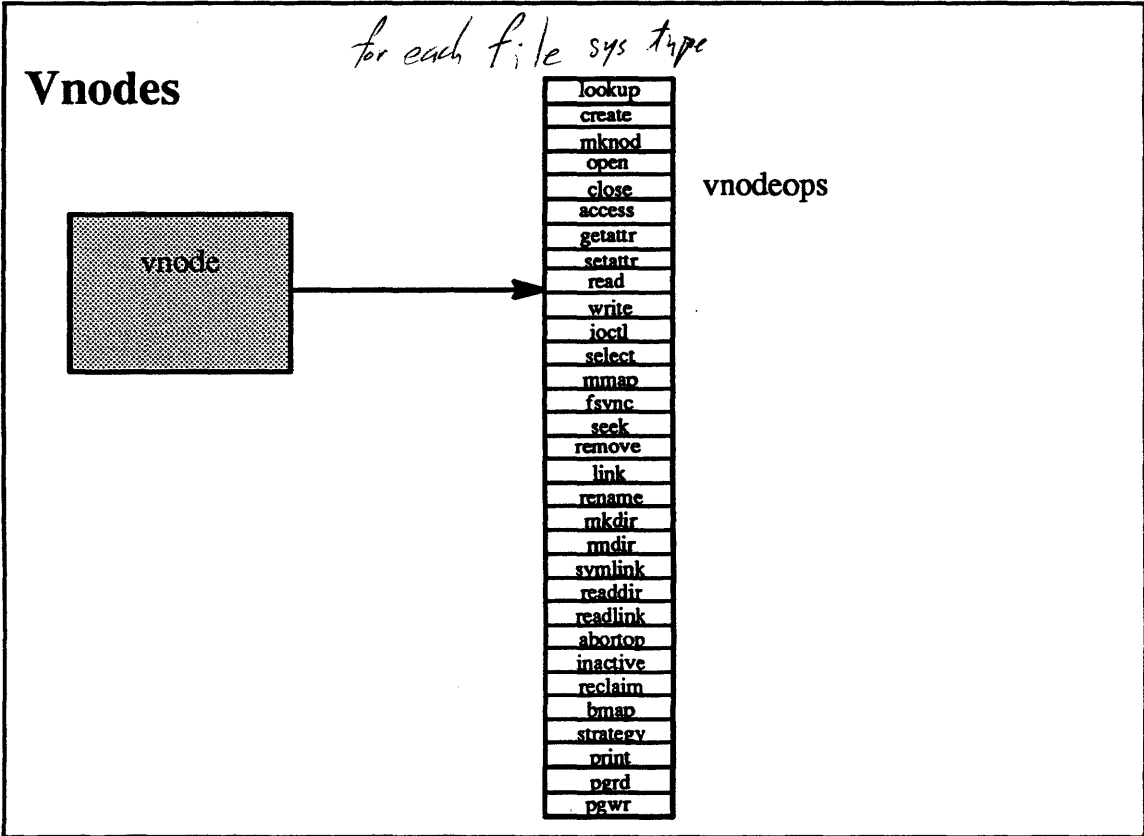

5-8.

© 1990, 1991 Open Software Foundation



## Module 5 — File Systems

---

### Student Notes: Vnodes

Vnodes are the abstractions of files. They represent individual files; they contain generic information about files and refer to the file-system-specific information on files (to *inodes* for UNIX files and to *nfsnodes* for NFS files). They also provide access to the various operations on the files—each vnode refers to an array of entry points called *vnodeops*.

**5-9. Virtual File Systems**

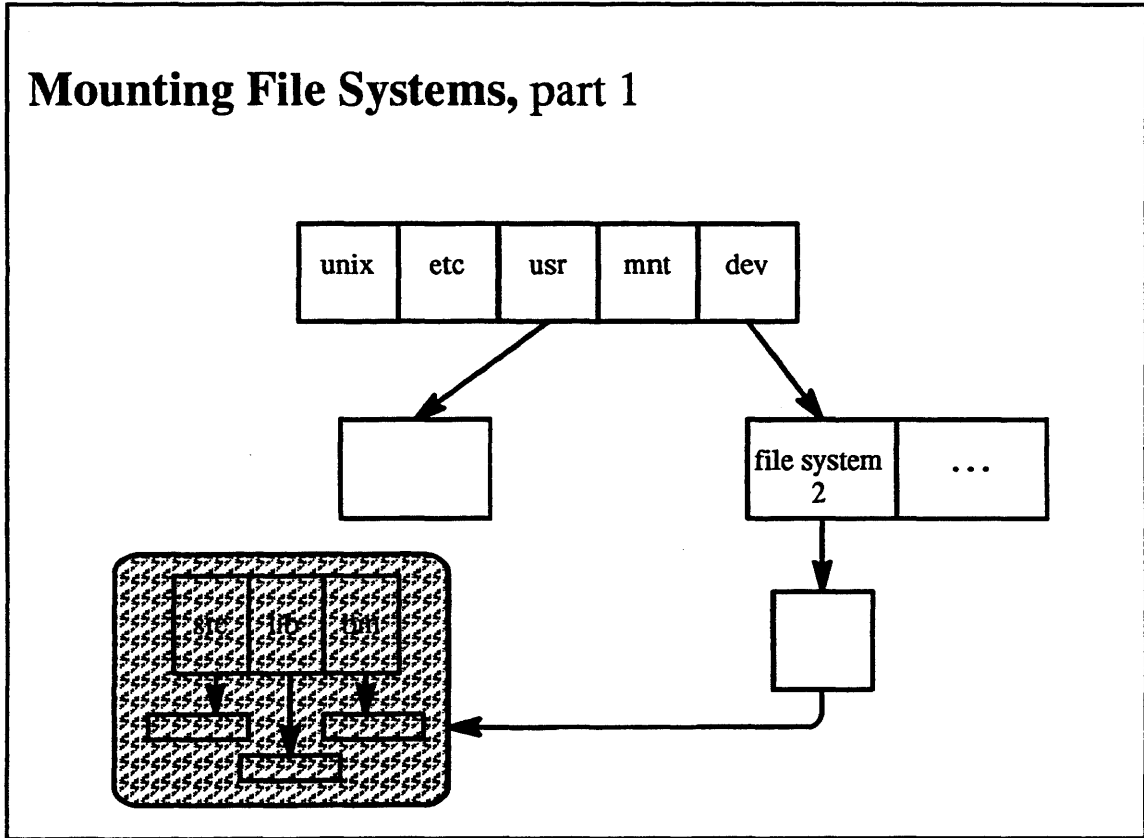

5-9.

© 1990, 1991 Open Software Foundation

## Module 5 — File Systems

---

### Student Notes: Mounting File Systems, part 1

To place a file system in the tree structure directory hierarchy, one must mount it. A file system as a whole is a device that is named as a special file in the /dev directory. In order that the contents of this device be treated as files, they must be made to appear in the directory hierarchy.

# Module 5 — File Systems

## 5-10. Virtual File Systems

### Mounting File Systems, part 2

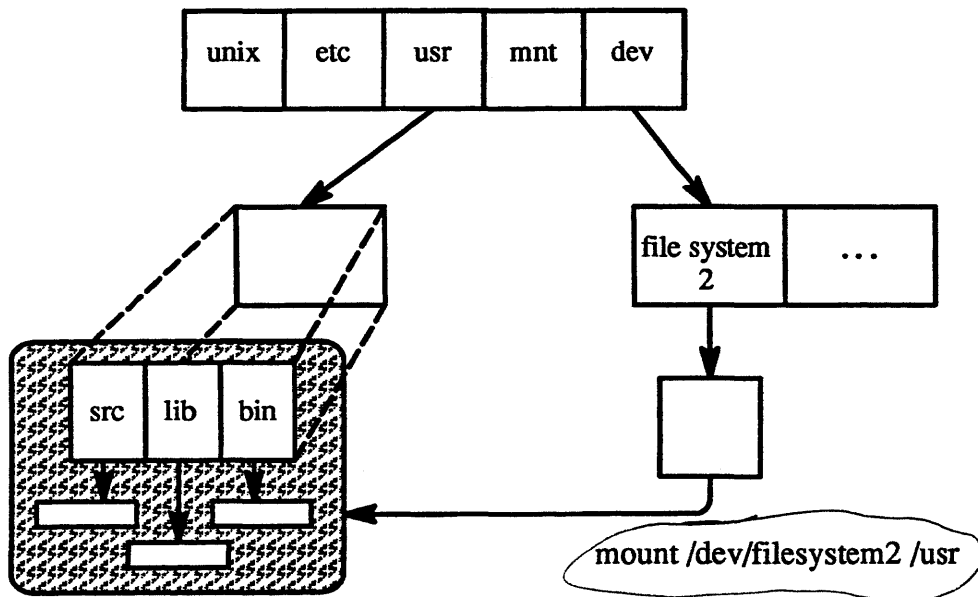

5-10.

© 1990, 1991 Open Software Foundation

## Module 5 — File Systems

---

### Student Notes: Mounting File Systems, part 2

The contents of the file system are placed in the directory hierarchy when one issues the *mount* command. The *mount* command superimposes the root directory of the file system on top of the directory given in the *mount* command. Any attempt to follow a path to this directory leads one instead to the root directory of the file system. Thus the prior contents of the mounted-upon directory become invisible.

5-11. Virtual File Systems

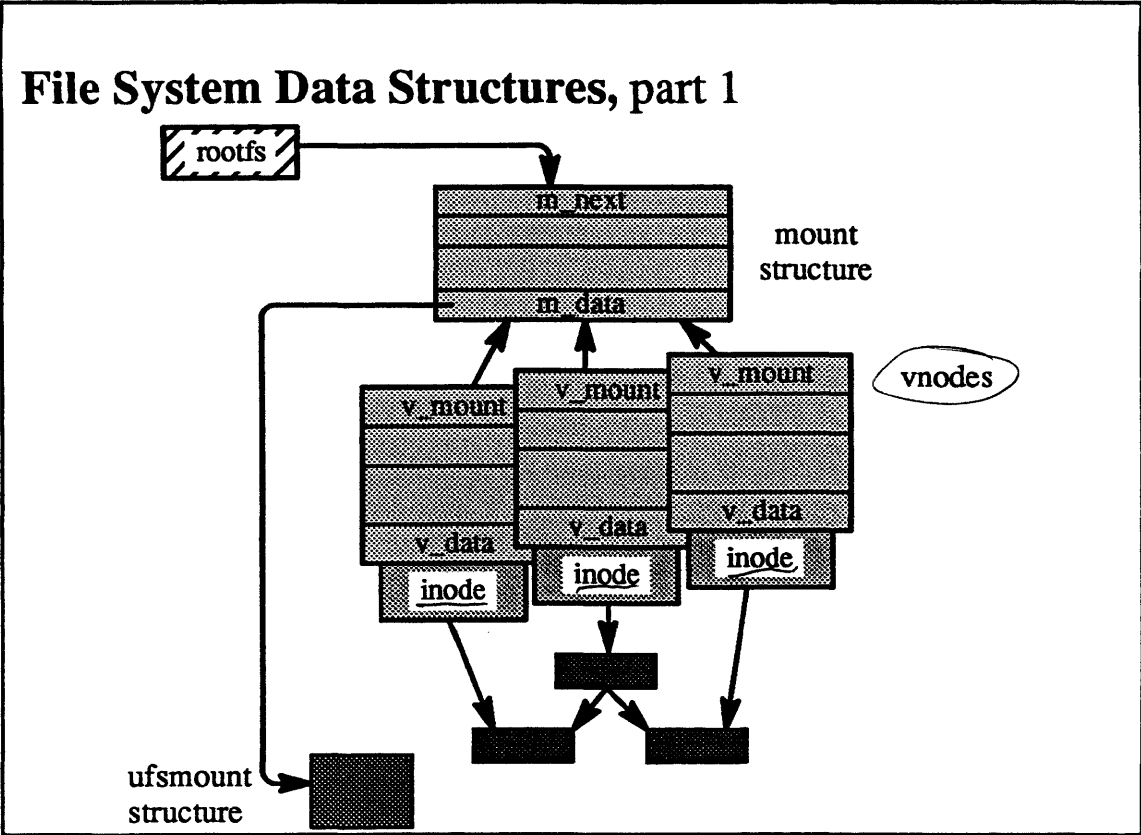

5-11.

© 1990, 1991 Open Software Foundation

## Module 5 — File Systems

---

### Student Notes: File System Data Structures, part 1

The data structures in this picture show a single mounted file system, the *root file system*, which happens to be a UFS file system. The field *rootfs* points to the *mount structure* of the root file system. The mount structure points to a file-system-specific mount structure, in this case the UFS mount structure. Each active file within this file system is represented by a vnode that in turn points to the mount structure. Attached to the vnode is a file-system-specific per-file data structure, in this case the *inode*. The inode represents the file within the UFS file system and is stored permanently on disk.

# Module 5 — File Systems

## 5-12. Virtual File Systems

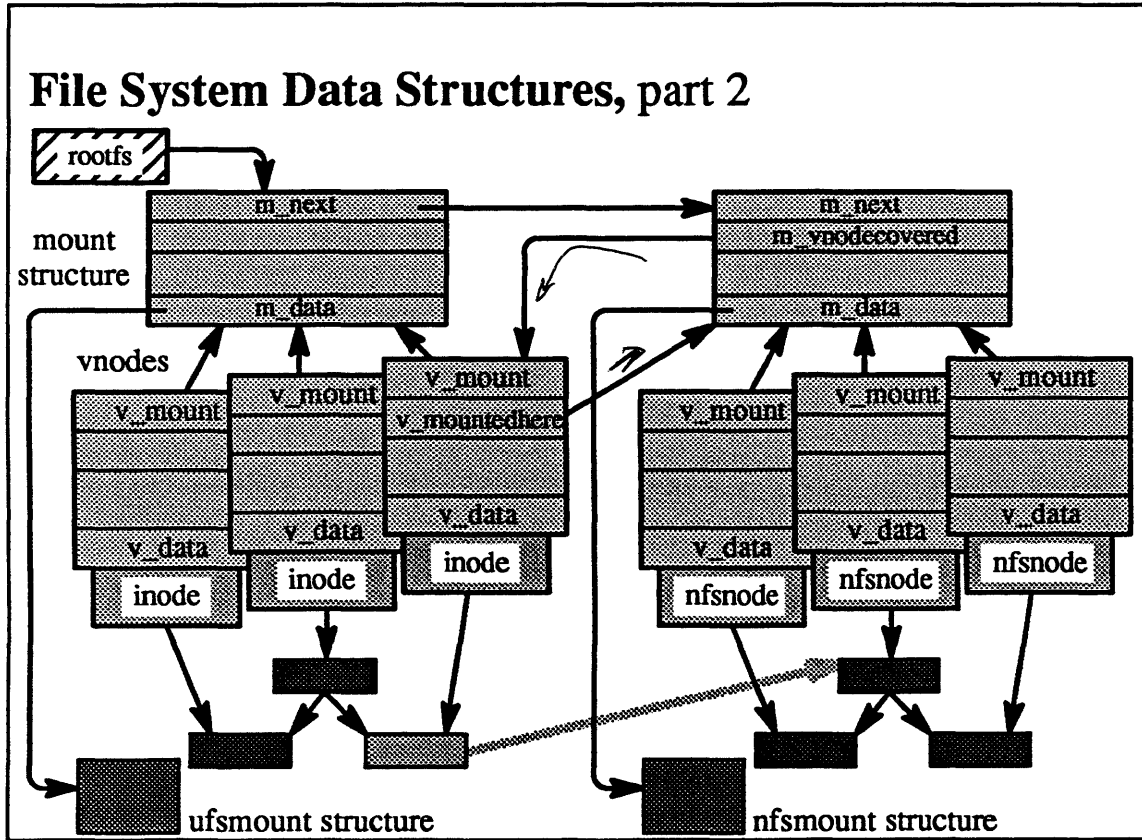

5-12.

© 1990, 1991 Open Software Foundation



## Module 5 — File Systems

---

### Student Notes: File System Data Structures, part 2

Here we see the effect of mounting an NFS file system in the root file system of the previous picture. The mount structure for this file system is linked to the mount structure of the root file system. The mounted file system's mount structure also points to the file-system-specific mount structure, in this case the NFS mount structure. The vnode of the mounted-upon directory is set to point to the mounted file system's mount structure to represent where the file system has been mounted. This mount structure in turn points back to the vnode. Attached to the vnodes of the active files of the mounted file system are *nfsnode* data structures, which represent the remote files.

# Module 5 — File Systems

## 5-13. Virtual File Systems

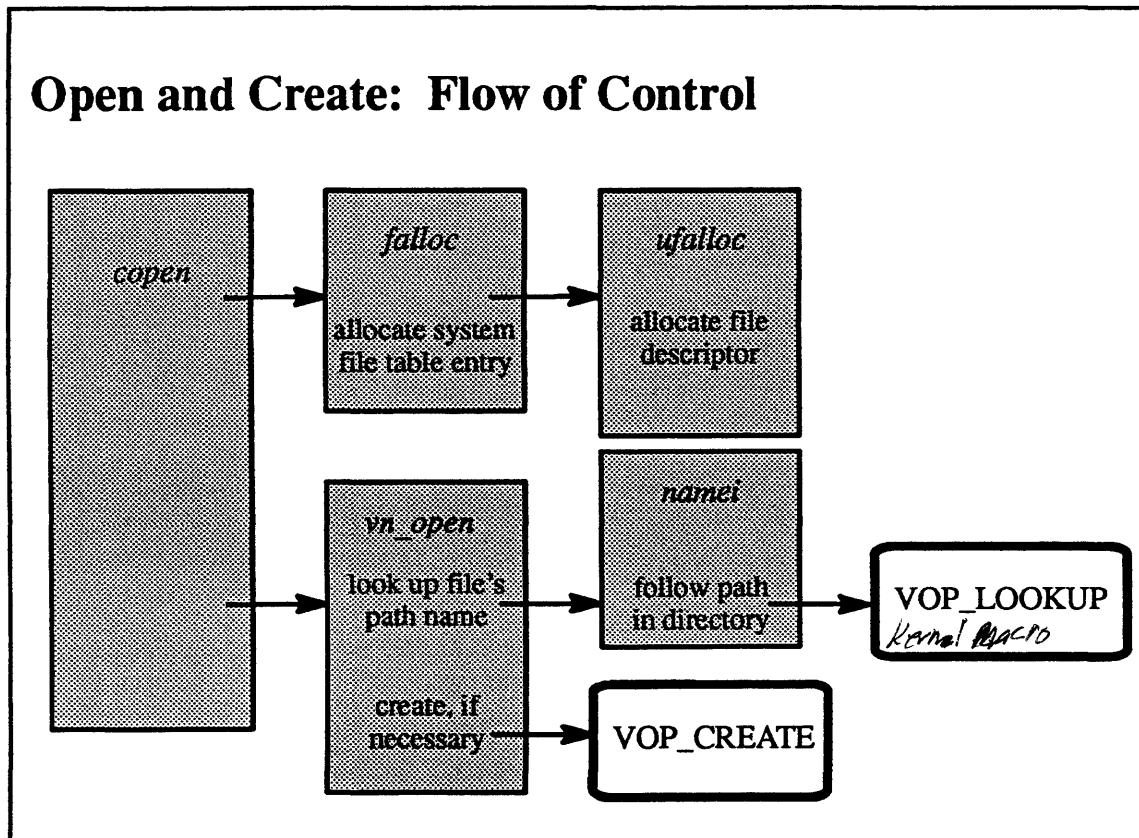

5-13.

© 1990, 1991 Open Software Foundation

## Module 5 — File Systems

---

### Student Notes: Open and Create: Flow of Control

*Copen* is called in the kernel in response to create and open system calls. As shown in the picture, *copen* calls *falloc*, which then calls *ufalloc*. On return from these, i.e., after the open file data structures have been set up, *copen* calls *vm\_open* to initiate locating the file in the directory hierarchy. *vm\_open* calls *namei*, which for each directory in the path calls the *lookup* routine associated with the directory's file system. The boxes with heavy outlines represent indirect references to a routine via a vector such as *vnodeops*. In particular, VOP\_LOOKUP means to call the lookup routine listed in the *vnodeops* array attached to the vnode.

# Module 5 — File Systems

## 5-14. Virtual File Systems

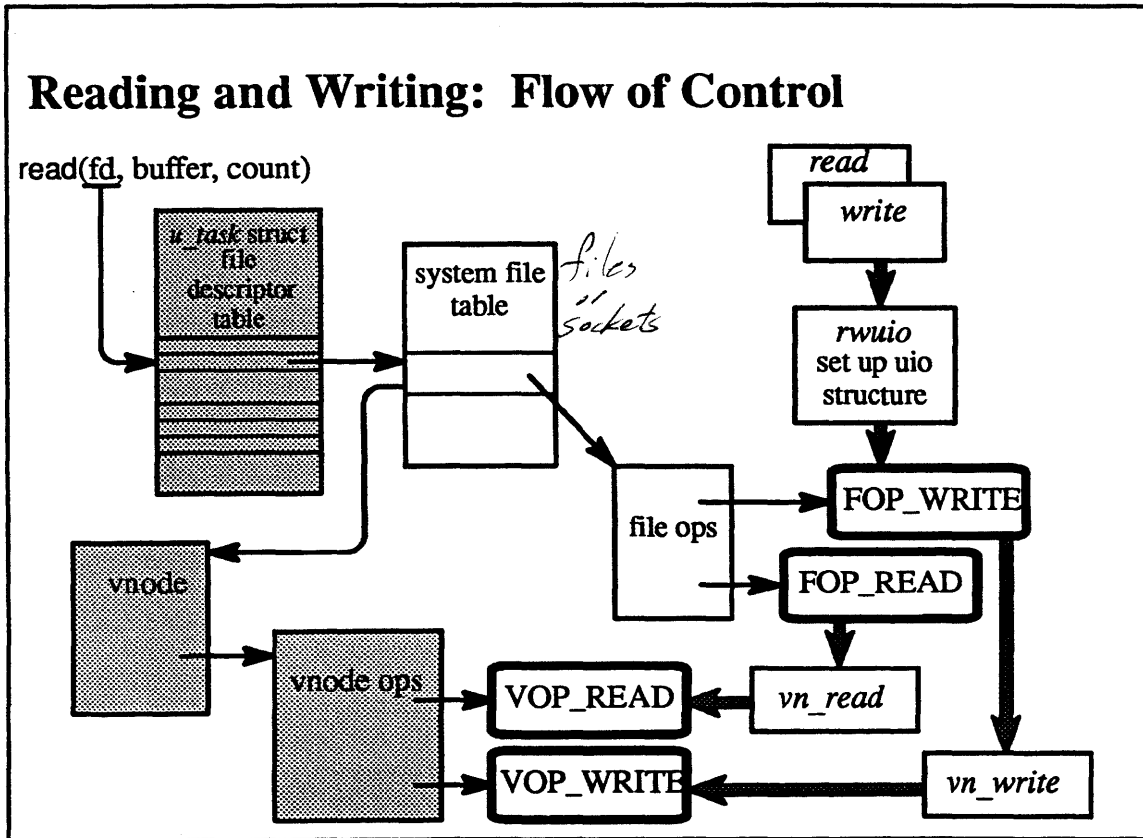

5-14.

© 1990, 1991 Open Software Foundation

## Module 5 — File Systems

---

### Student Notes: Reading and Writing: Flow of Control

Most of the work performed in reading and writing a file occurs within the file system. However, some of the work occurs at the file-system-independent level. The first step in any I/O request is to copy the parameters of the I/O request into the *uio structure* (see the next slide). The next step is to find the file table entry and the vnode and to verify that the user has permission to perform the desired operation.

An important next step for regular files and directories is to lock the file offset in the file table entry (using a blocking read-write lock) so as to make the operation *atomic*. This is done to avoid a race condition in which two threads that share the same file table entry concurrently access the file. (Locking has been done incorrectly in some versions of UNIX.)

## 5-15. Virtual File Systems

### The Uio Structure

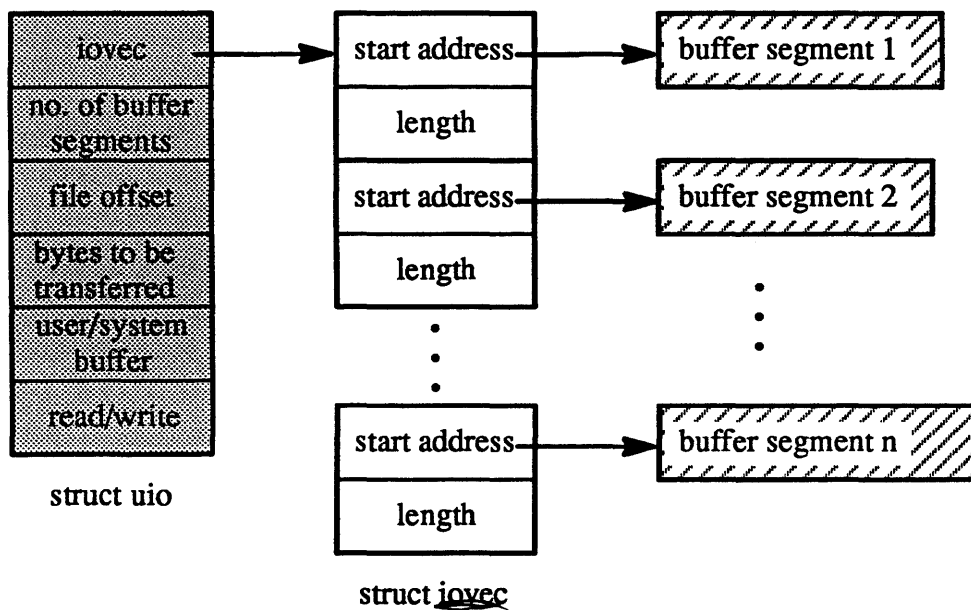

## Module 5 — File Systems

---

### Student Notes: The Uio Structure

The *uio* structure represents a logical I/O request. Its contents represent what needs to be done to complete an I/O request; these contents are updated as the I/O request progresses through the system. The buffer may, in general, be composed of multiple segments, and hence an array of *iovec* structures is needed to refer to each of the pieces of the buffer. This organization is made necessary by the `readv` and `writv` system calls, which use such multicomponent buffers.

# Module 5 — File Systems

## 5-16. The Buffer Cache

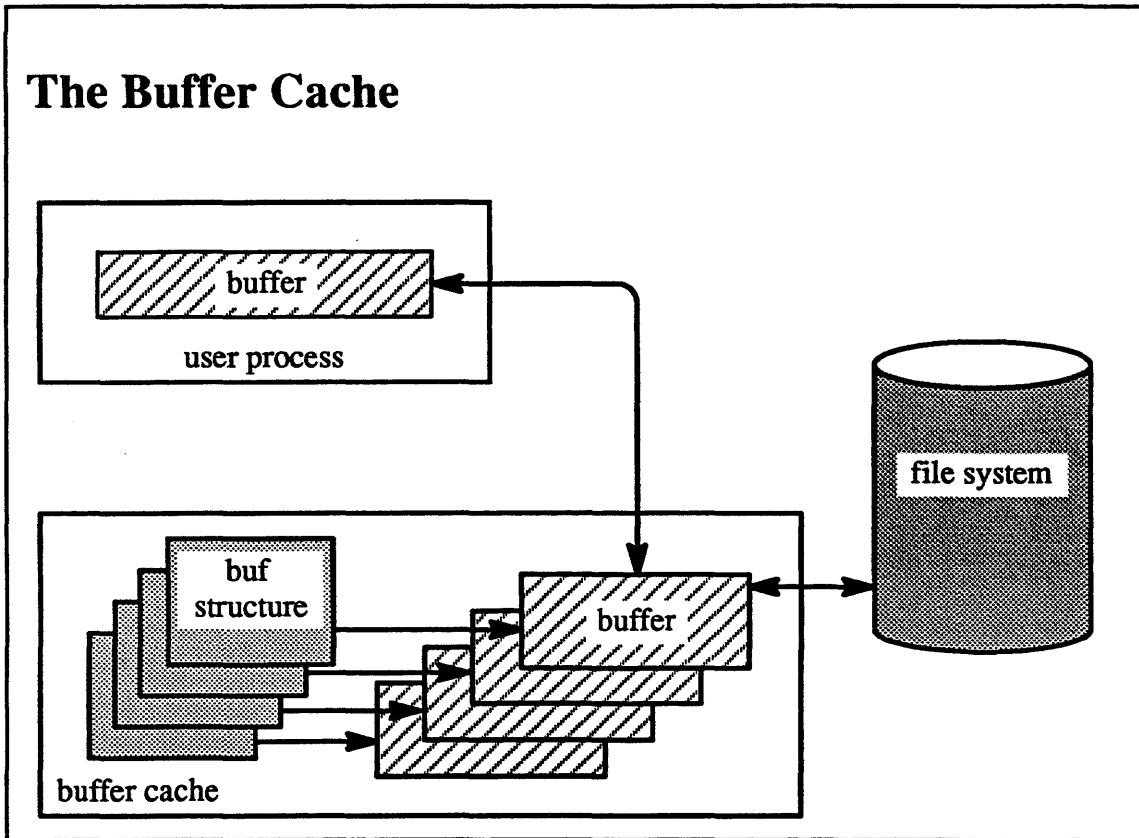

5-16.

© 1990, 1991 Open Software Foundation

*allows async I/O*



## Module 5 — File Systems

---

### Student Notes: The Buffer Cache

The buffer cache has two primary functions. The first, and most important, is to make possible concurrent I/O and computation within a UNIX process. The second is to insulate the user from physical block boundaries.

From a user thread's point of view, I/O is *synchronous*. By this we mean that when the I/O system call returns, the system no longer needs the user-supplied buffer. For example, after a `write` system call, the data in the user buffer has either been transmitted to the device or copied to a kernel buffer—the user can now scribble over the buffer without affecting the data transfer. Because of this synchronization, from a user thread's point of view, no more than one I/O operation can be in progress at a time. Thus user-implemented multibuffered I/O is not possible (in a single-threaded process). In OSF/1, however, the user can utilize multiple threads within a task to program concurrent I/O and computation.

The buffer cache provides a kernel implementation of multibuffering I/O, and thus concurrent I/O and computation are possible even for single-threaded processes.

## 5-17. The Buffer Cache

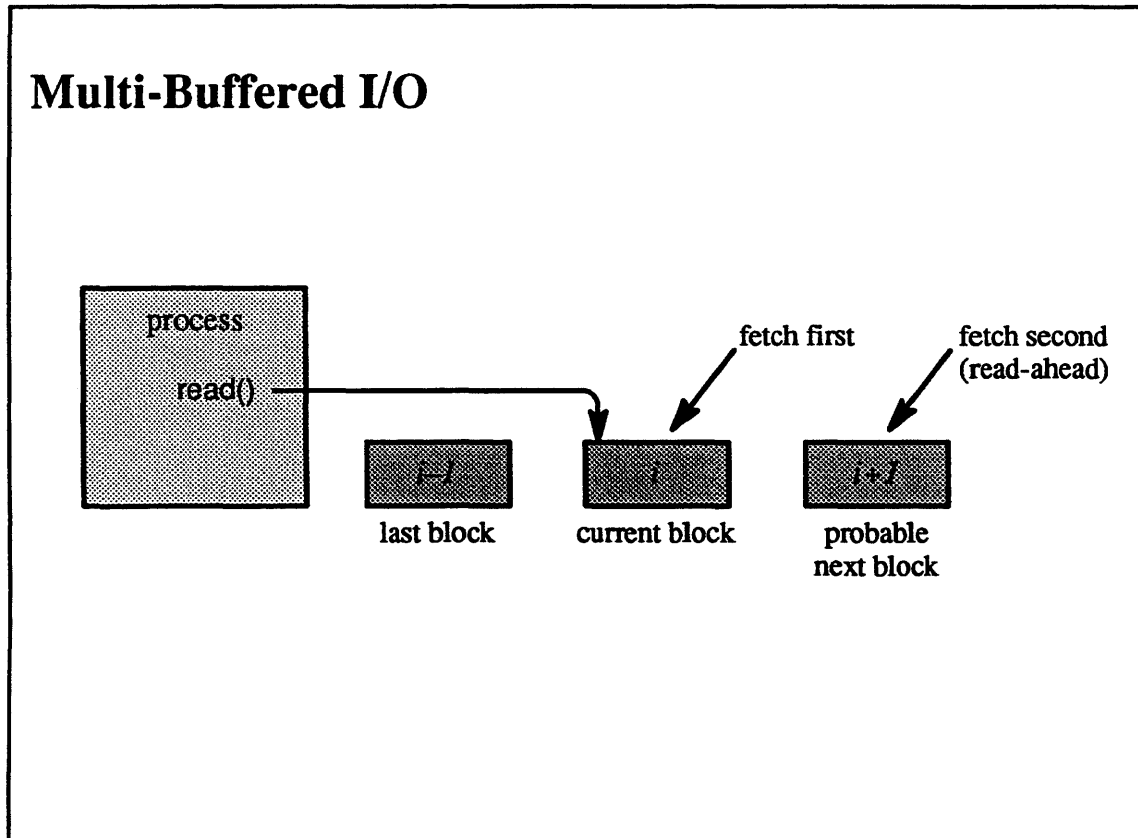

5-17.

© 1990, 1991 Open Software Foundation

## Module 5 — File Systems

---

### Student Notes: Multi-Buffered I/O

The use of *read-aheads* and *write-behinds* makes concurrent I/O and computation possible: if the block currently being fetched is block  $i$  and the previous block fetched was block  $i-1$ , then block  $i+1$  is also fetched. Modified blocks are normally not written out synchronously but are instead written out sometime after they were modified, asynchronously.

**5-18. The Buffer Cache**

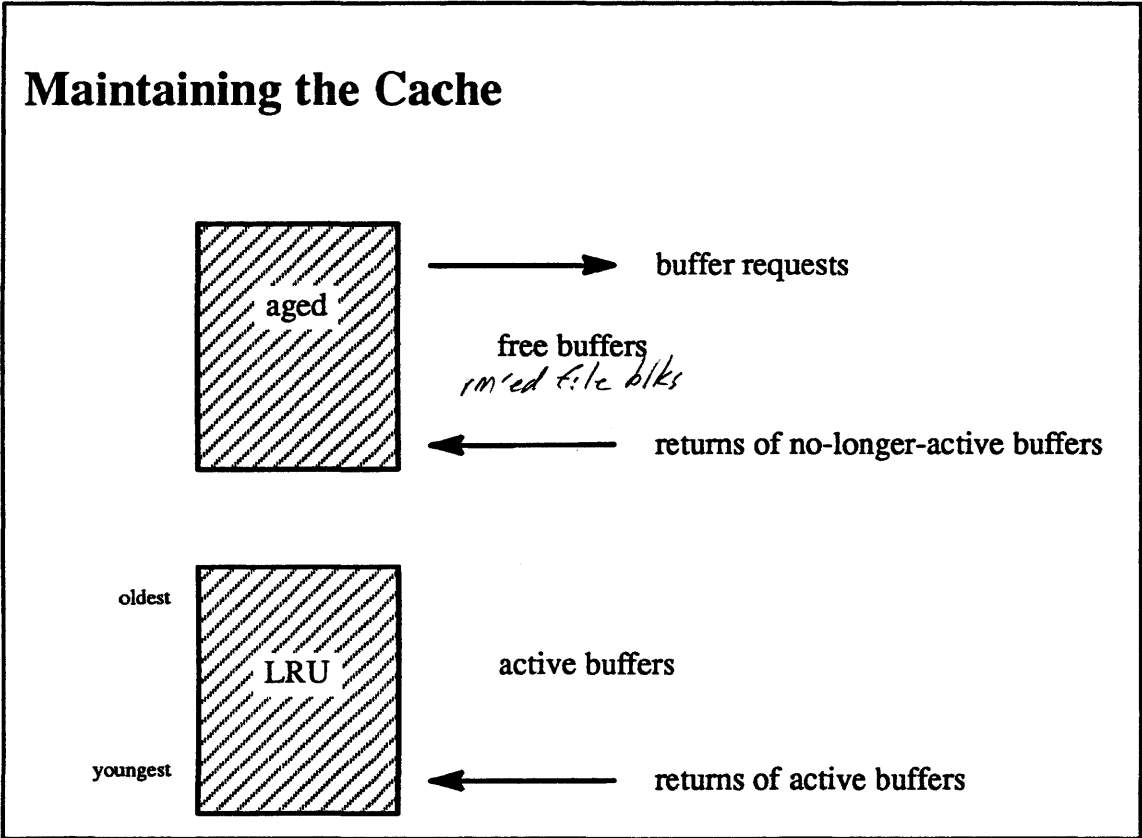

5-18.

© 1990, 1991 Open Software Foundation

## Module 5 — File Systems

---

### Student Notes: Maintaining the Cache

Active buffers are maintained in least-recently-used (LRU) order in the system-wide LRU list. Thus after a buffer has been used (as part of a read or write system call), it is returned to the end of the LRU list. The system also maintains a separate list of “free” buffers called the *aged* list. Included in this list are buffers holding no-longer-needed blocks, such as blocks from truncated files.

Fresh buffers are taken from the aged list. If this list is empty, then a buffer is obtained from the LRU list, as follows. If the first buffer (least recently used) in this list is clean (i.e., contains a block that is identical to its copy on disk), then this buffer is taken. Otherwise (i.e., if the buffer is dirty), it is written out to disk asynchronously and, when written, is placed at the end of the aged list. The search for a fresh buffer continues on to the next buffer in the LRU list, etc.

When a file is deleted, any buffers containing its blocks are placed at the head of the aged list. Also, when I/O into a buffer results in an I/O error, the buffer is placed at the head of the aged list.

In BSD, buffers that have been read (or written) in their entirety are placed at the end of the aged list. The assumption is that, since files are normally accessed sequentially, these buffers won't be needed for a while. This technique has not been found to improve performance and thus is not used in OSF/1.

**5-19. The Buffer Cache**

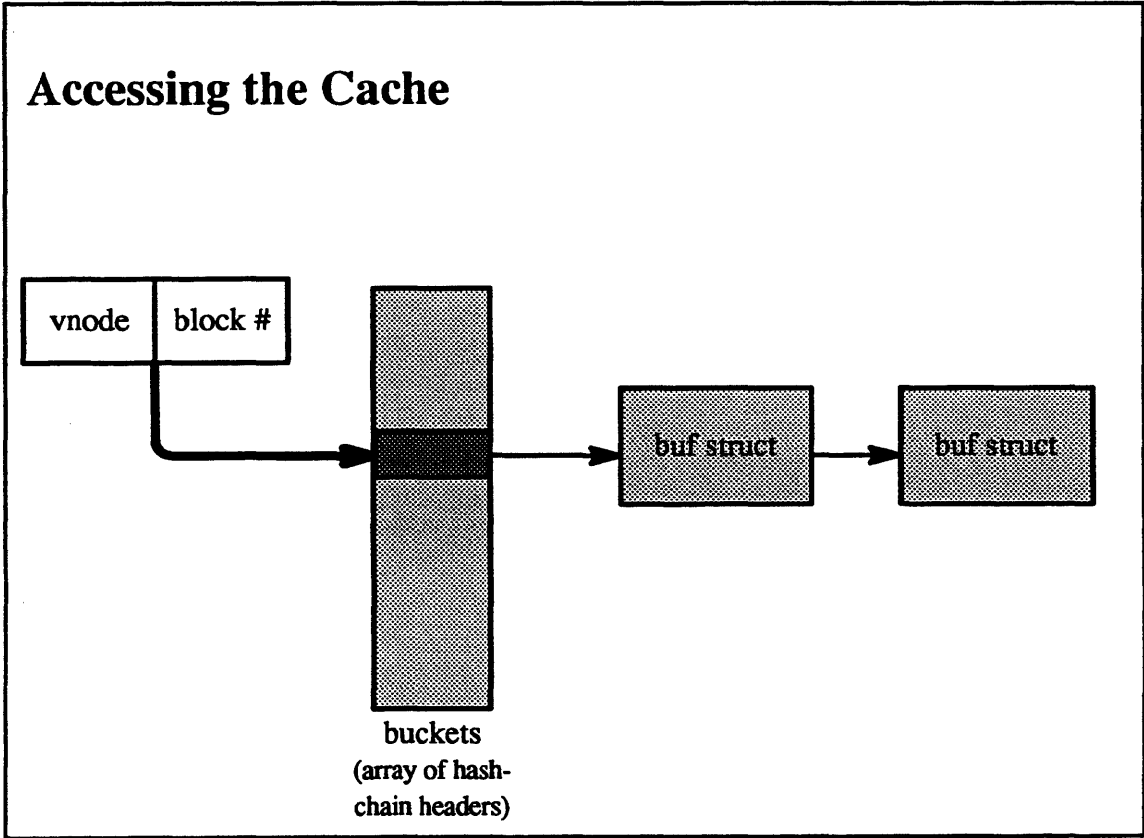

5-19.

© 1990, 1991 Open Software Foundation

## Module 5 — File Systems

---

### Student Notes: Accessing the Cache

Buffers in the cache are accessed via a hash table. In older versions of UNIX, buffers in the cache were identified by file-system number and block number (within the file system). With remote file systems such as NFS, the client does not know the block number within the file system, but only knows the block number relative to the beginning of the file. OSF/1 thus uses the address of the vnode and the block number relative to the beginning of the file to identify blocks of files of not only remote but also local file systems.

This approach does not work for the *indirect blocks* and other *metadata structures* of UNIX file systems (both S5 and UFS). These are identified by the address of the vnode of the underlying file system (i.e. block special file) and the block number relative to the beginning of the file system. (A possible consistency problem that would arise when blocks of open files in a mounted file system are accessed via the block special interface is prevented by not allowing the block special interface to a mounted file system to be accessed.)

In order to improve the performance of operations such as fsync that affect the cached blocks of a particular file, each vnode heads a list of incore clean buffers and incore dirty buffers.

**5-20. The Buffer Cache**

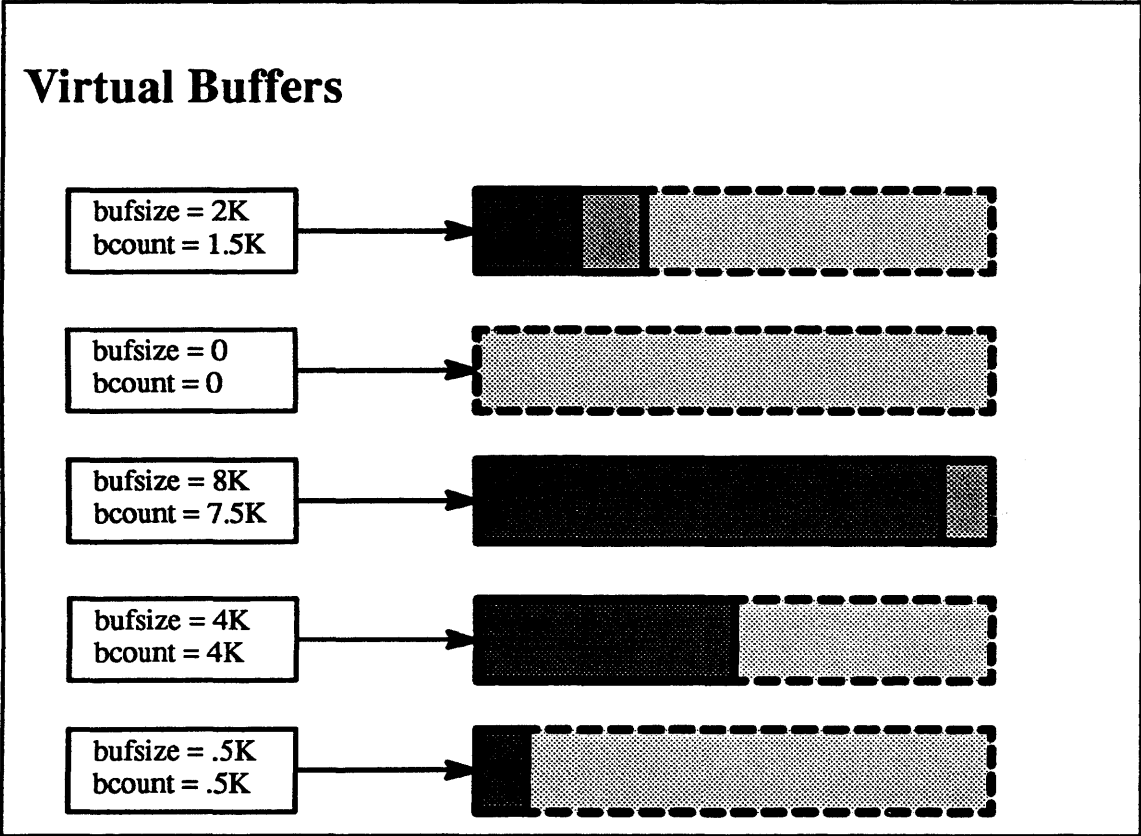

5-20.

© 1990, 1991 Open Software Foundation



## Module 5 — File Systems

---

### Student Notes: Virtual Buffers

If buffers were all of the same size and files were allocated in fixed-size blocks, then allocating a buffer would be trivial. However, the UFS file system allows different file systems to have different block sizes and, within a file system, it allows the last block of a file to be smaller than the others.

Each *buf* structure is assigned a maximum-block-size amount of virtual memory ( $\text{MAXBSIZE} = 8\text{K}$ ) for its buffer.

The total amount of real memory allocated for buffers is divided up among the *buf* structures; a possible result is that not all buffers will have the maximum 8K of real memory backing them up. If such an underendowed buffer is allocated when a full allotment of real memory is needed, space is “stolen” from another *buf* structure’s buffer (by remapping the memory). *Buf* structures without real memory for their buffers are placed on an *empty list*. If a *buf* structure is allocated whose buffer is larger than is needed, its extra space is given to a *buf* structure on the empty list.

## 5-21. The Buffer Cache

### File System Consistency, part 1

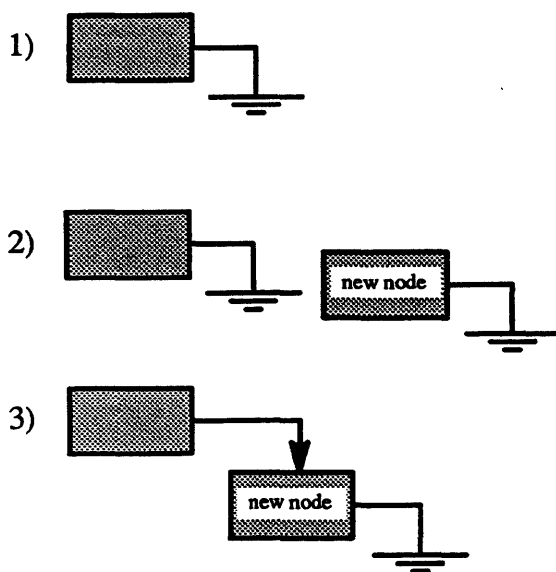

5-21.

© 1990, 1991 Open Software Foundation

## Module 5 — File Systems

---

### Student Notes: File System Consistency, part 1

In the event of a crash, the contents of the file system may well be inconsistent with any view of it the user might have. For example, a programmer may have carefully added a node to the end of the list, so that at all times the list structure is well-formed.

# Module 5 — File Systems

## 5-22. The Buffer Cache

### File System Consistency, part 2

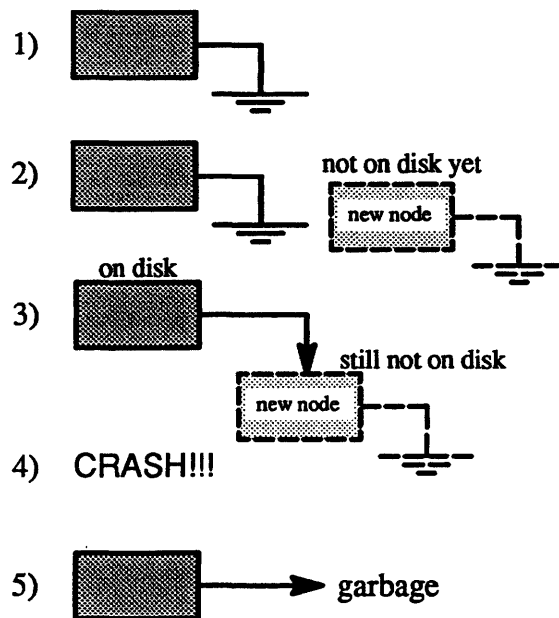

5-22.

© 1990, 1991 Open Software Foundation

## Module 5 — File Systems

---

### Student Notes: File System Consistency, part 2

But, if the new node and the old node are stored on separate disk blocks, the modifications to the block containing the old node might be written out first; the system might well crash before the second block is written out.

**5-23. The Buffer Cache**

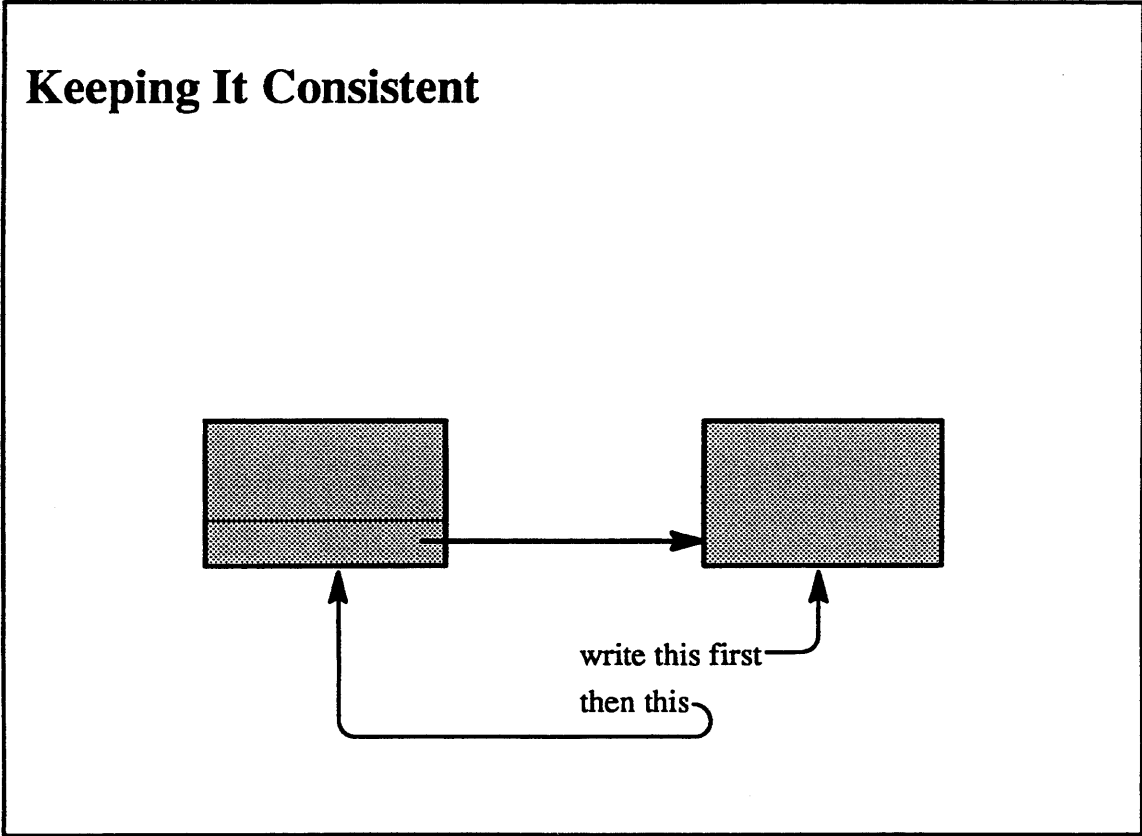

5-23.

© 1990, 1991 Open Software Foundation

## Module 5 — File Systems

---

### Student Notes: Keeping It Consistent

To deal with this problem, system data structures are written out synchronously and in the correct order (i.e., the block containing the target of a pointer is updated before that containing the pointer). This is done for directory entries, inodes, indirect blocks, etc.

No such synchronization is done for user data structures: not enough is known about the semantics of user operations to make this possible. However, a user process called *update* executes a `sync` system call every 30 seconds, which initiates the writing out to disk of all dirty buffers. Alternatively, the user can open a file with the *synchronous* option so that all writes are waited for; i.e., the buffer cache acts as a *write-through cache* (N.B. that this is expensive!).

### 5-24. The Buffer Cache

#### Parallelizing the Buffer Cache

**Locks:** buf structure (blocking)  
free lists (LRU and aged) (spin)  
hash chains (spin)

**Precedence:** buf structure > free list  
buf structure > hash chain



## Module 5 — File Systems

---

### **Student Notes: Parallelizing the Buffer Cache**

The buffer cache is parallelized by using blocking locks on the buffers. Thus many operations may proceed simultaneously, as long as they involve different buffers. To avoid race conditions when updating the free lists and hash table, spin locks are employed. A partial precedence order on these locks is used, as shown on the slide.

5-25. The Buffer Cache

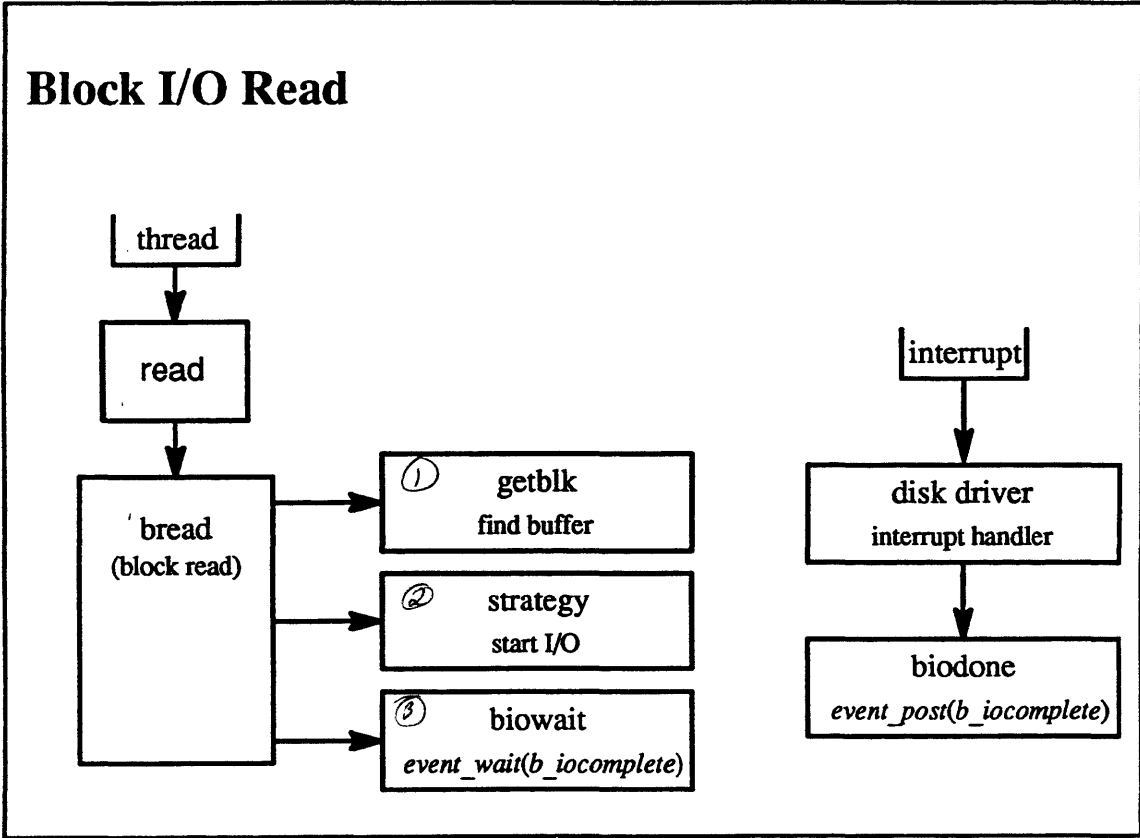

5-25.

© 1990, 1991 Open Software Foundation

## Module 5 — File Systems

---

### Student Notes: Block I/O Read

Note that the use of events avoids the race condition between the *biodone* and the *biowait*: the interrupt could be handled on a different processor from the one on which the thread calling *biowait* is running.

### 5-26. The Buffer Cache

#### Block I/O Read (Pseudocode)

```
bread(vnode, blkno)
    buffer = getblk(vnode, blkno)
    if (event_posted(buffer->b_iocomplete))
        return(buffer)
    VOP_STRATEGY(vnode, buffer)
    event_wait(buffer->b_iocomplete)
    return(buffer)
```

## Module 5 — File Systems

---

**Student Notes: Block I/O Read (Pseudocode)**

**5-27. The Buffer Cache**

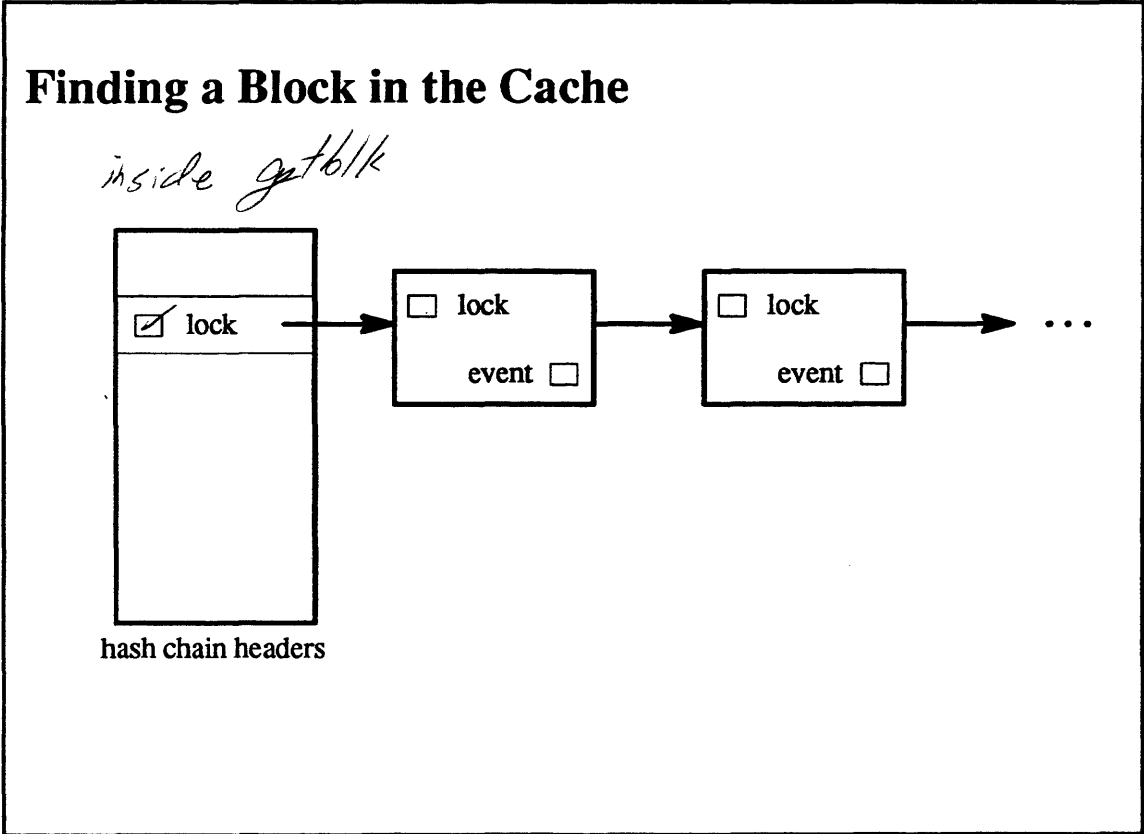

5-27.

© 1990, 1991 Open Software Foundation

## Module 5 — File Systems

---

### Student Notes: Finding a Block in the Cache

First the thread takes the lock on the hash chain header (simple lock). If it finds the desired buffer, then it unlocks the header and takes the lock on the buffer (blocking lock). If, after the thread waits for the lock, it finds that the buffer no longer contains the desired block, then the thread repeats the procedure from the beginning.

## 5-28. The Buffer Cache

### Finding a Block in the Cache (Pseudocode)

```
getblk(vnode, blkno)
    hash(vnode, blkno)
restart: lock(hash chain) -
    for each buffer in chain {
        if (buffer.blkno == blkno) {
            unlock(hash chain)
            lock(buffer)
            if (buffer.blkno != blkno) { recheck
                unlock(buffer)
                goto restart
            }
            return(buffer)
        }
    }
    /* block is not in cache */
    unlock (hash chain)

    buffer = getnewbuf( )
    /* has someone else just now allocated a different
    buffer for the same block? */
    lock(hash chain)
    if (hash chain has been modified) { /*(check
    timestamps) */
        if (blkno is in hash chain) {
            return buffer to free list
            unlock (hash chain)
            goto restart
        }
    }
    insert (buf, hash chain)
    unlock (hash chain)
    return(buffer)
```



## Module 5 — File Systems

---

### Student Notes: Finding a Block in the Cache (Pseudocode)

Associated with each hash chain is a timestamp that is incremented by one when the hash chain is modified (a buffer is either inserted or removed).

There is a potential race condition when *getnewbuf* is called: two threads may simultaneously discover that a particular block is not in the cache, and both call *getnewbuf* to allocate a buffer for it (and two buffers are indeed allocated). Due to the lock on the hash chain, one buffer will be inserted in the hash table first. To prevent both buffers (representing the same block) from being inserted, a check has to be made to insure that the buffer being inserted is not a duplicate. This check would involve searching the hash chain (again). To minimize the number of times this must be done, the current value of the timestamp on the hash chain is compared with its value when it was originally ascertained that the block was not present. Only if the timestamps are now different is the hash chain searched.

# Module 5 — File Systems

## 5-29. The Buffer Cache

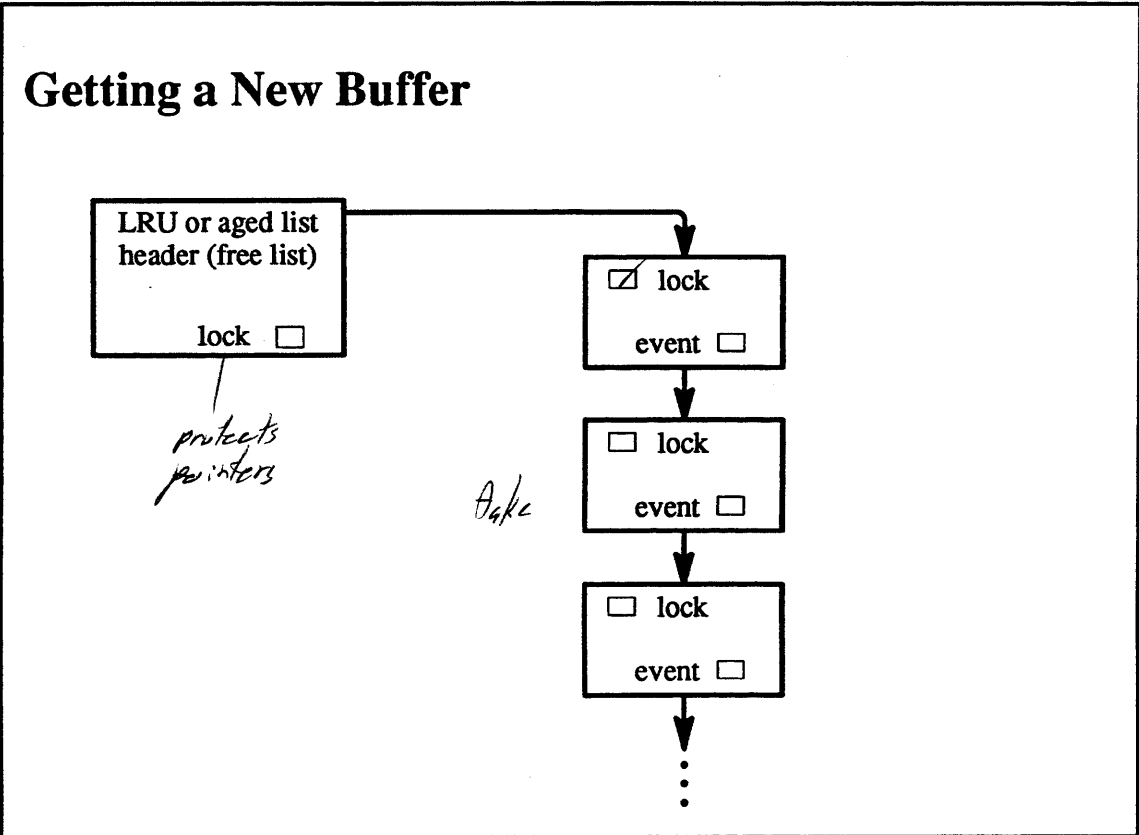

5-29.

© 1990, 1991 Open Software Foundation

## Module 5 — File Systems

---

### **Student Notes: Getting a New Buffer**

First the thread takes the lock on the header (simple lock). Then it conditionally takes the lock on the buffer. If the buffer is already locked, then the thread skips it and tries the next one. If no buffers are available, then the thread sleeps until one is.

### 5-30. The Buffer Cache

#### Getting a New Buffer (Pseudocode)

```
getnewbuf()  
  
    lock (free list)  
  
    for each buffer in free list {  
        if (lock_try (buffer))  
            break;  
    }  
  
    remove buffer from free list  
  
    unlock (free list)  
  
    event_clear (buffer->b_iocomplete)  
  
    return(buffer)
```

## Module 5 — File Systems

---

### Student Notes: Getting a New Buffer (Pseudocode)

**5-31. The Buffer Cache**

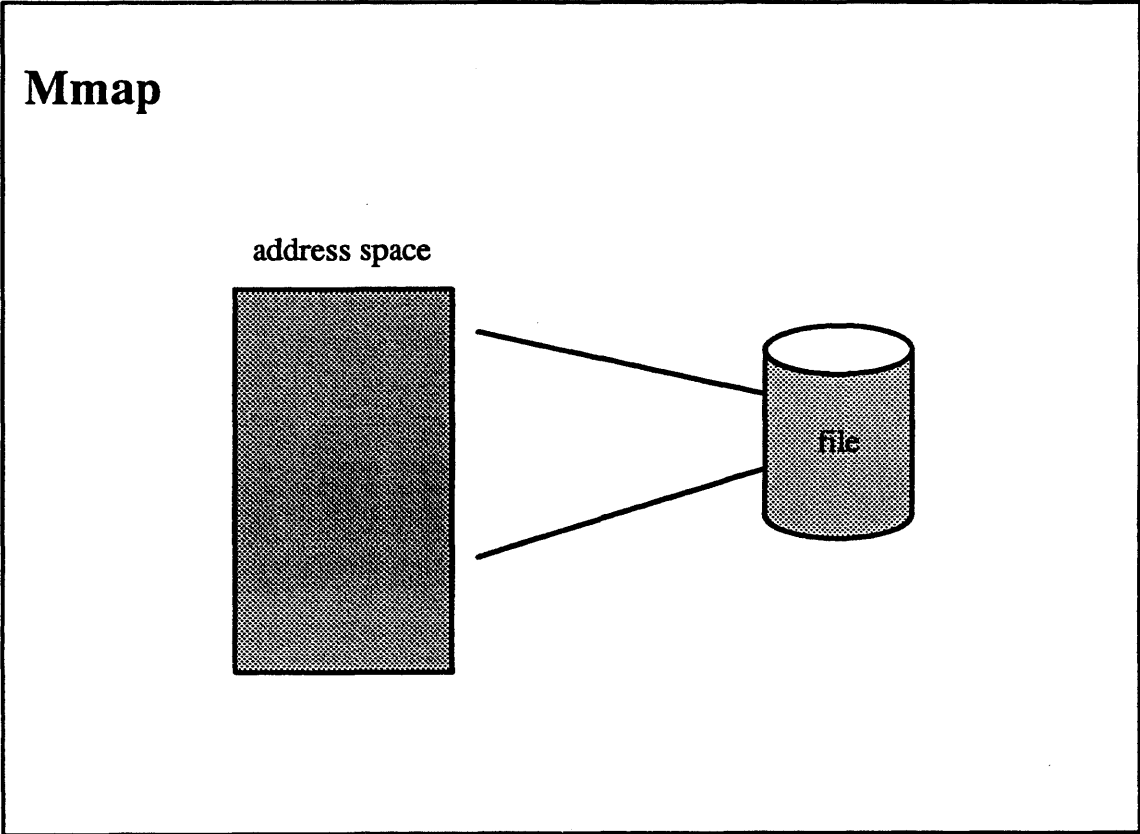

5-31.

© 1990, 1991 Open Software Foundation

## Module 5 — File Systems

---

### Student Notes: Mmap

The `mmap` system call is used either to map a file into a process's address space or to create an anonymous memory region. Anonymous memory is shared with all of the process's descendants.

A mapped file may be *private*, meaning that changes to the mapped memory are not shared with other processes and are not reflected back to the file.

A mapped file may be *shared*, meaning that changes to the mapped memory are shared with other processes that have a shared mapping of the file, and these changes are reflected back to the file.

Two important issues arise with `mmap`. First, does a process that has a private mapping of a file "see" the changes made by processes with shared mappings? In OSF/1, the answer is no.

The other issue involves the simultaneous access of a file via `mmap` and read/write system calls. In the current implementation there is a consistency problem, since two copies of blocks of the file may exist in primary memory: one in the buffer cache and one in a page frame to which a virtual page has been mapped.

### 5-32. Directory Path Searching

#### Directory Path Searching

```
start with root vnode or current-directory vnode
while (not at end of path) {
    search for next component in file represented by current vnode
    if not found
        terminate
    fetch associated vnode, assign it to current vnode
}
```



## Module 5 — File Systems

---

### Student Notes: Directory Path Searching

Following directory paths would seem to be quite trivial. The basic algorithm is shown in the picture. However, as will be discussed, the actual procedure is fairly complex, and this subsystem is a very important part of the operating system.

### 5-33. Directory Path Searching

#### Complications in Directory Path Searching

- Multiple file system types
- Mount points
- Symbolic links
- Concurrency
- Speed

## **Module 5 — File Systems**

---

### **Student Notes: Complications in Directory Path Searching**

### 5-34. Directory Path Searching

#### Multiple File Systems

- The top-level path-searching routine is *namei*
- *Namei* breaks the path into components and, for each component, calls the appropriate file system (via VOP\_LOOKUP) to look it up in the current directory

## Module 5 — File Systems

---

### Student Notes: Multiple File Systems

One might think that a more efficient technique for following a path would be to give the file system lookup routine all of the remaining portion of the path so that it can follow it as far as possible. This technique is not easy, however, for a number of reasons.

In NFS, it is up to the client to determine which character separates components; the server is not involved. For example, UNIX clients use “/” as the component separator, whereas MS-DOS uses “\”. Only the client can break a pathname into its components (though one might argue that the client could pass the component-separator as an argument to the server). But, furthermore, mount points are interpreted strictly by the client, and server mount points mean nothing to the client.

**5-35. Directory Path Searching**

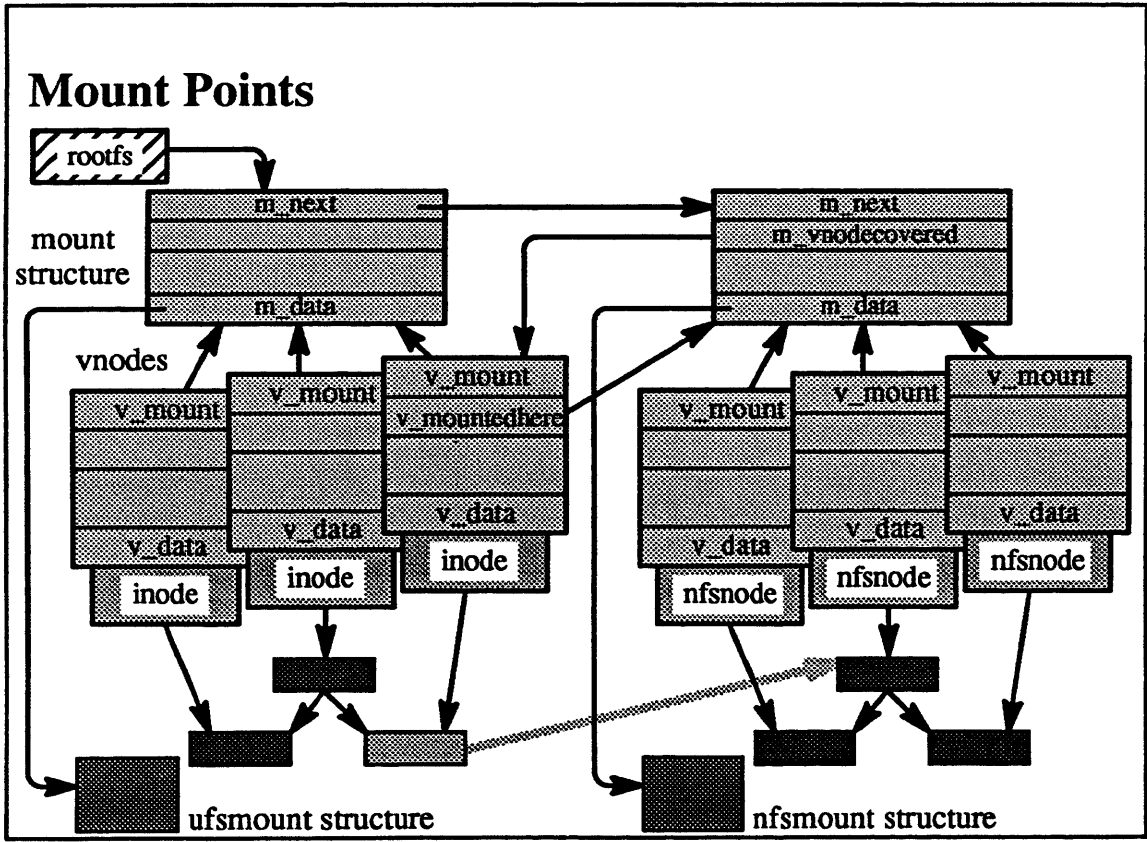

5-35.

© 1990, 1991 Open Software Foundation

## Module 5 — File Systems

---

### Student Notes: Mount Points

Mount points are encoded in the *vnode* and *mount* structures. This system makes it not only possible but obligatory that clients view a file system independent of mounts done by the server. *Namei* tests each directory it encounters to determine if it is a mount point; if it is, *namei* calls the mounted file system's `VFS_ROOT` routine to obtain its root *vnode*.

A related scenario is following “..” links out of a mounted file system. In this case, *namei* consults the mounted file system's mount structure to find the address of the *vnode* that it covers, and then it follows that directory's “..” link of the directory represented by that *vnode*.

5-36. Directory Path Searching

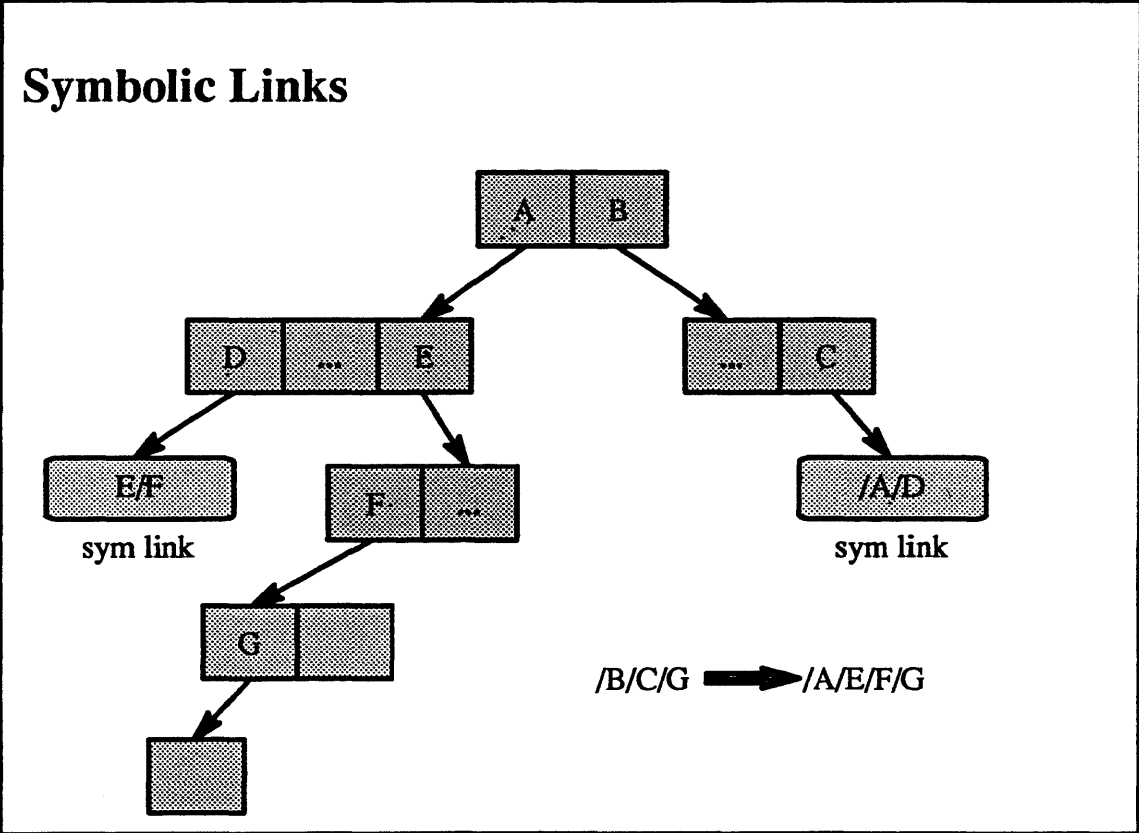

5-36.



## Module 5 — File Systems

---

### Student Notes: Symbolic Links

If a vnode marked as a symbolic link is encountered, then the file system's VOP\_READLINK routine is called to get the link. The routine replaces that portion of the path that has already been followed with the value of the symbolic link, and then restarts the search from the beginning of the newly modified path name.

To avoid loops caused by careless placement of symbolic links, no one path may be composed of more than MAXSYMLINKS (32) symbolic links.

### 5-37. Directory Path Searching

#### Concurrency

Must guard against two types of race conditions:

- a directory is modified while it is being searched
- a directory is modified after a lookup, but before the result is acted upon

## Module 5 — File Systems

### Student Notes: Concurrency

OSF/1 deals with the first case by requiring that a thread hold a *read lock* on a directory while searching it and hold a *write lock* on the directory while modifying it.

*Timestamps* are used to deal with the second case. Each time a thread modifies a directory, it increments the directory's timestamp by one. When a thread searches a directory it records the directory's current timestamp. Before the thread modifies a directory, it compares the timestamp it obtained in the lookup request to the directory's current timestamp. If the timestamps are different, then the directory must have been modified since the lookup, and the thread repeats the lookup. If the lookup fails a second time, then the operation fails.

For example, suppose two threads issue concurrent delete requests for the same directory entry. The net result should be that one succeeds and the other fails. Both threads do a successful lookup of the entry and one thread succeeds in deleting the entry. The other thread will note before it attempts to remove the entry that the timestamp has changed. It will thus repeat the lookup, the lookup will fail, and so the delete system call will fail.

An example of the destructive effects of the second race condition is the following set of operations, each performed by a separate thread:

thread 1: rm /A

thread 2: rm /A

thread 3: cp /C /B

The two *rms* are executed concurrently: both threads do a successful lookup to determine that /A exists; as a side effect the lookup returns the position of the component A within the / directory. This lookup is performed while holding a read lock; thus both threads can do it in parallel. Modifying the directory to delete the entry A, however, requires an exclusive write lock. Thus one thread blocks while the other thread removes the entry A. However, it happens that immediately after thread 1 removes entry A, thread 3 creates the entry B in the directory slot just vacated by A. When thread 2 wakes up and completes its operation, it removes what it thinks is entry A but is in fact entry B.

### 5-38. Directory Path Searching

#### Speed

- Fancier file-naming facilities result in longer lookup times
- Solution: more caching

## Module 5 — File Systems

---

### Student Notes: Speed

4.2BSD added many new facilities not present in earlier versions of UNIX. One result of these additions was that 4.2BSD was considerably slower than 4.1BSD. Kernel profiling showed that approximately 25% of system time spent in the kernel was spent in routines translating directory paths. This was much too much time for such chores, so to speed things up, two forms of caching were introduced. Both forms were designed for use with the UFS file system, but may be used with any file system. With the addition of the two types of caching, the system time devoted to name translation dropped from 25% to less than 10%.

## 5-39. Directory Path Searching

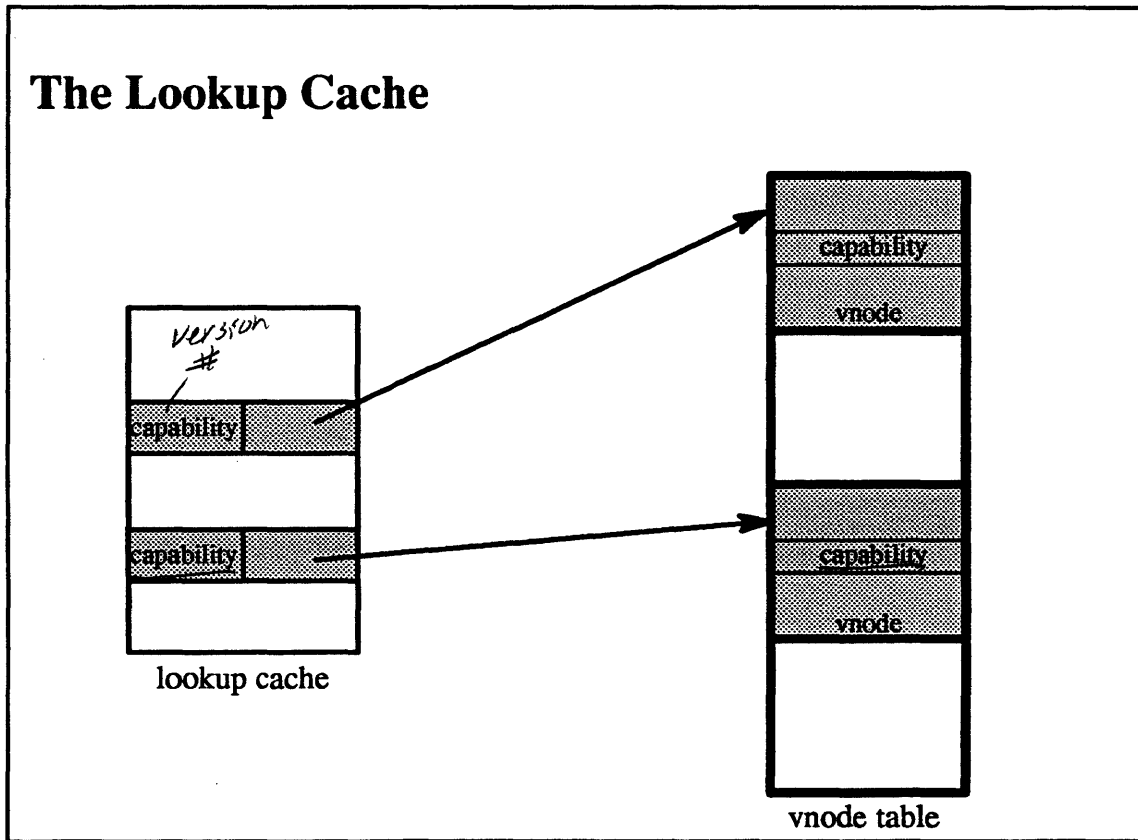

5-39.

© 1990, 1991 Open Software Foundation

## Module 5 — File Systems

### Student Notes: Lookup Cache

*high payoff*  
The lookup cache is a cache of the most recent component-name-to-vnode translations. Searching a directory for a component name can be expensive, so the most recent lookups are kept in a cache. (Note that this is not a cache of path names, but merely of component names.)

A vnode reference presents a problem in representing the result of a translation. If the cache contains actual “reference-counted” references to the vnode, then the reference count on vnodes themselves remains positive, and incore vnodes are not freed. (SVR4 actually does employ this technique: when the system is low on available vnodes, it makes a pass through the cache and frees those vnodes whose only reference is due to the cache.)

The OSF/1 cache, derived from 4.4BSD, contains “soft” references to vnodes, i.e. references that do not show in the reference count. The problem here is that if a file is deleted and its vnode reused for another file, the cache continues to contain a reference to the vnode in its previous incarnation, since there is no indication in the vnode that a cache entry refers to it. To deal with this, vnodes and the cache contain capabilities (version numbers)—32-bit integers. Each vnode has an assigned capability. When the vnode is invalidated, the version number is incremented by one. Each cache translation also contains a version number, which is set equal to that of the vnode. If the version numbers do not match when the translation is accessed, then the cache entry is considered invalid and is flushed. Berkeley’s figures indicate that this cache has a “hit rate” of 70–80%.

## 5-40. Directory Path Searching

### The Search Cache

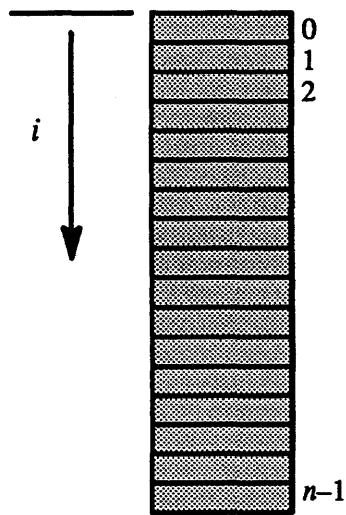



## Module 5 — File Systems

---

### Student Notes: The Search Cache

The second form of caching deals with repeated lookups of one directory. Consider a command such as `ls -l`: its implementation involves reading the contents of the directory, then performing a stat system call on each entry. It takes time proportional to  $i$  to search for the  $i$ th entry, since the search always starts at the beginning of the directory. Thus, for  $n$  entries, time proportional to  $n^2$  is needed to find each entry in the directory. For a large directory this could be rather significant.

By storing in the inode the offset of where the last search terminated, a linear algorithm for `ls -l` (and others) can be devised, since the search for the next item in the directory will start where the previous item was found.

Note that 4.2BSD and 4.3BSD stored the offset in the *user* structure. This approach seems better, especially if multiple threads are each doing the equivalent of `ls -l` on the same directory. However, storing the offset in the inode makes this technique work when `ls -l` is applied to directories other than the current directory (i.e., when each directory lookup involves searching a path).

The search cache has a “hit rate” of 5–15%.

### 5-41. S5 File System

#### The S5 File System

The original UNIX file system:

- extremely simple
- no attempt to optimize the layout of files

## Module 5 — File Systems

---

### Student Notes: The S5 File System

The S5 file system, provided primarily for compatibility reasons, is generally always slower than the UFS file system. However, it has a few things in common with the UFS file system, in particular the notion of inodes (including the disk map).

# Module 5 — File Systems

## 5-42. S5 File System

### Inodes

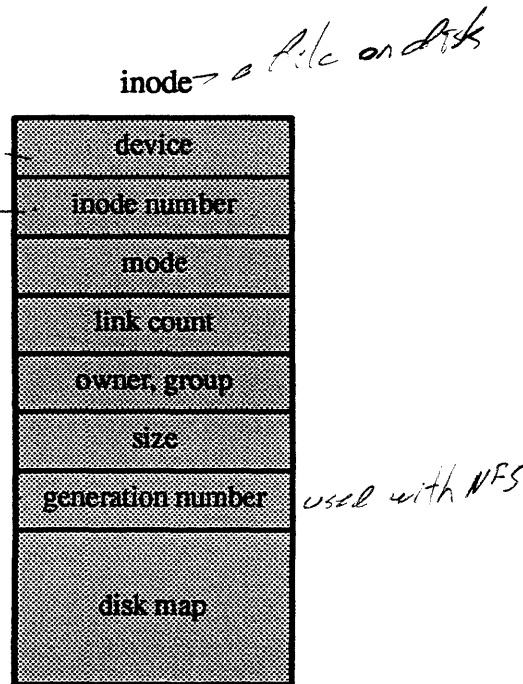

## Module 5 — File Systems

---

### Student Notes: Inodes

Inodes are the focus of all file activity, i.e., every access to a file must go through the inode. Every file has a inode on permanent storage; this on-disk inode is of type *struct dinode* in the S5 file system. All open files, current directories, mounted-on directories, and the root have incore inodes of type *struct S5inode*. Once brought into primary storage, an inode stays there until its associated file is deleted or its storage is needed for some other purpose.

# Module 5 — File Systems

## 5-43. S5 File System

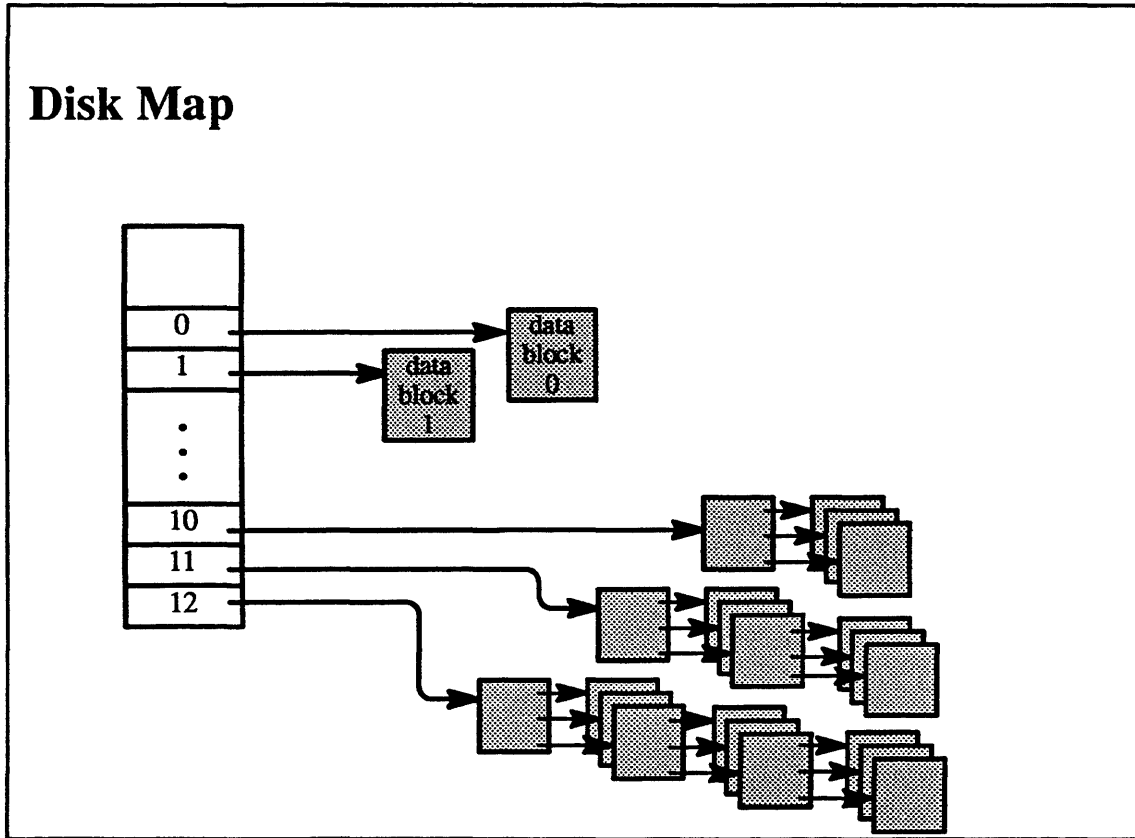

5-43.

© 1990, 1991 Open Software Foundation

## Module 5 — File Systems

### Student Notes: Disk Map

The purpose of the disk-map portion of the inode is to map block numbers relative to the beginning of a file into block numbers relative to the beginning of the file system. An S5 file system may be configured with a 512-byte, 1K-byte, or 2K-byte block size. We assume a 1K block size from here on.

The disk map consists of 13 pointers to disk blocks, the first 10 of which point to the first 10 blocks of the file. Thus the first 10Kb of a file are accessed directly. If the file is larger than 10Kb, then pointer number 10 points to a disk block called the *indirect block*. This block contains up to 256 (4-byte) pointers to data blocks (i.e., 256Kb of data). If the file is bigger than this (256K + 10K = 266K), then pointer number 11 points to a double indirect block containing 256 pointers to indirect blocks, each of which contains 256 pointers to data blocks (64Mb of data). If the file is bigger than this (64Mb + 256Kb + 10Kb), then pointer number 12 points to a triple indirect block containing up to 256 pointers to double indirect blocks, each of which contains up to 256 pointers pointing to single indirect blocks, each of which contains up to 256 pointers pointing to data blocks (potentially 16Gb, although, as will be discussed, the real limit is either 2Gb or 4Gb).

The structure of the UFS file system is similar, except that the block size is either 4K or 8K and the disk map consists of 15 pointers, the first 12 of which point to the first 12 data blocks. Because of the larger block size, the triple indirect block is unusable, since the double indirect block can represent a file size larger than 4Gb. A hard limit on file size for 32-bit architectures is 4Gb (or perhaps 2Gb, depending on one's feelings about sign bits), since the offset into a file must fit in a word!

This data structure allows the efficient representation of *sparse* files, i.e., files whose content is mainly zeros. Consider, for example, the effect of creating an empty file and then writing one byte at location 2,000,000,000. Only four disk blocks are allocated to represent this file: a triple indirect block, a double indirect block, a single indirect block, and a data block. All pointers in the disk map, except for the last one, will be zero. If the file is read, all bytes up to the last one will read as zero. This is because a zero pointer is treated as if it points to a block containing all zeros: a zero pointer to an indirect block is treated as if it points to an indirect block filled with zero pointers, each of which is treated as if it points to a data block filled with zeros. However, one must be careful about copying such a file, since commands such as *cp* and *tar* actually attempt to write all the zero blocks! (The *dump* command, on the other hand, copes with sparse files properly.)

The units of the pointers in the disk map in the S5 file system are in blocks (1K). For the UFS file system, the units are in fragments that can be any multiple of 512 bytes, from 512 bytes to 8K bytes (this value is fixed for each instance of the file system).

5-44. S5 File System

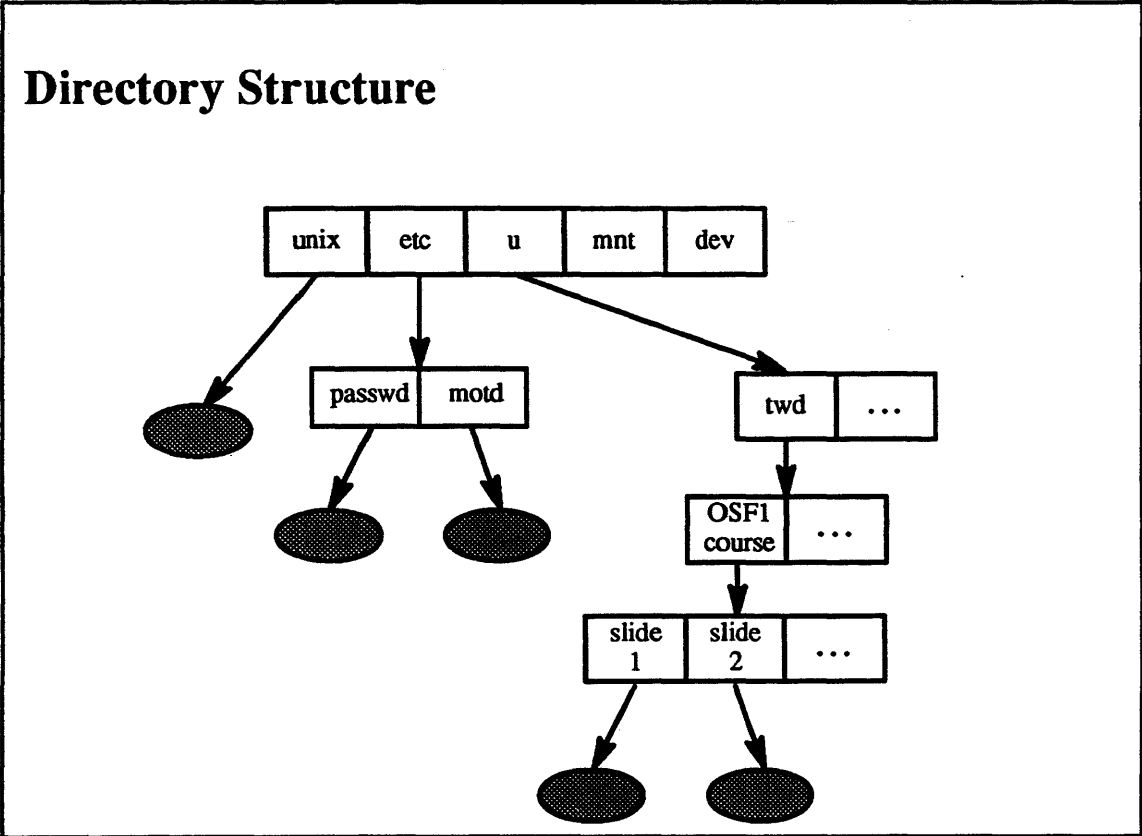

5-44.

© 1990, 1991 Open Software Foundation



# Module 5 — File Systems

---

## Student Notes: Directory Structure

# Module 5 — File Systems

## 5-45. S5 File System

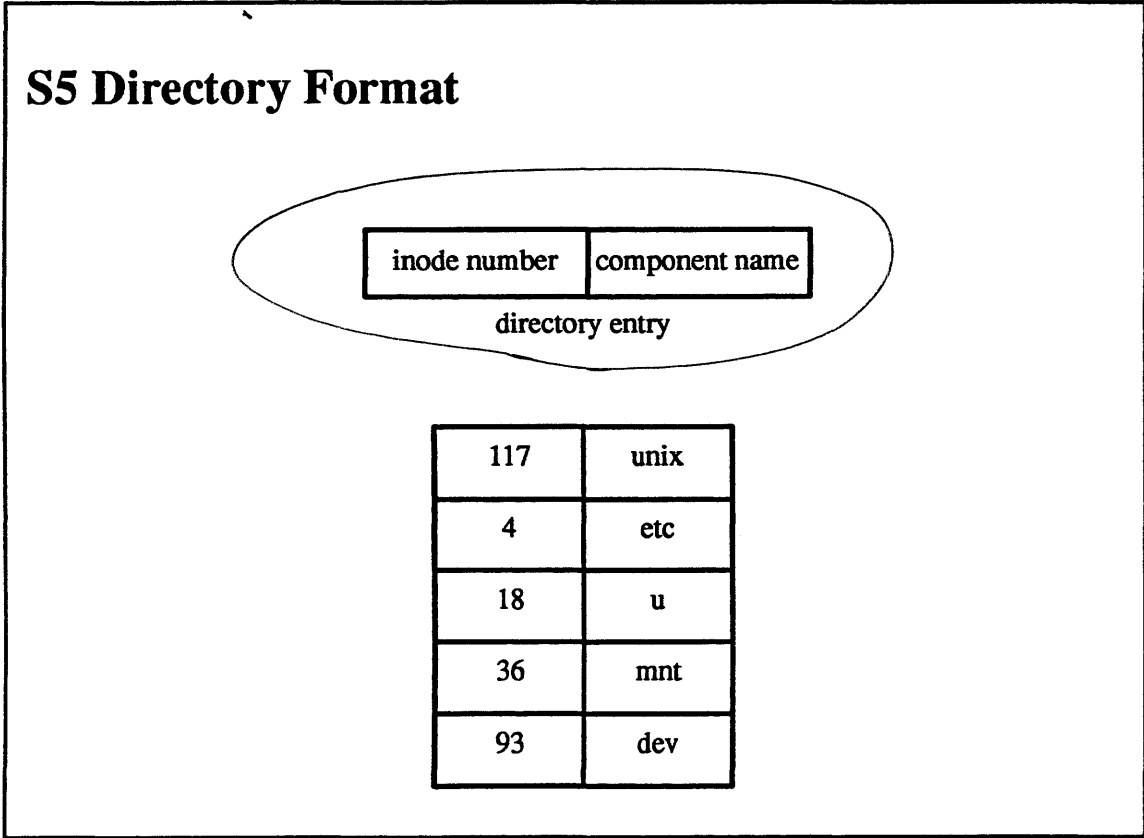

5-45.

© 1990, 1991 Open Software Foundation

## Module 5 — File Systems

---

### Student Notes: S5 Directory Format

The S5 directory consists of an array of pairs of inode number and component number. An important restriction is that the component name may be no longer than 14 bytes, thereby making a fixed length format possible. Note that identifying a file requires a reference to the file system as well as the inode number, but only the latter is supplied in each directory. The file system is assumed to be the one that contains the directory. Thus the only way a path can cross a file system boundary is via mount points.

## 5-46. S5 File System

### File System Layout

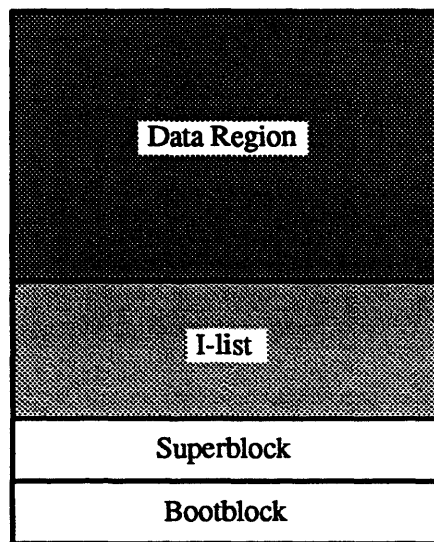

5-46.

© 1990, 1991 Open Software Foundation

## Module 5 — File Systems

---

### Student Notes: File System Layout

- **Bootblock**
  - used on some systems to contain a bootstrap program
  
- **Superblock**
  - describes the file system:
    - ◆ total size
    - ◆ size of inode list (I-list)
    - ◆ header of free-block list
    - ◆ list of free inodes
    - ◆ modified flag
    - ◆ read-only flag
    - ◆ number of free blocks and free inodes
    - ◆ resides in a buffer borrowed from the buffer cache while the file system is mounted
  
- **I-list**
  - area for allocating inodes
  
- **Data region**
  - remainder of file system is for data blocks and indirect blocks

A problem with this organization is that the I-list and the data region are separated from each other. Since one must always fetch the inode before reading or writing the blocks of a file, the disk head is constantly moving back and forth between the I-list and the data region.

## 5-47. S5 File System

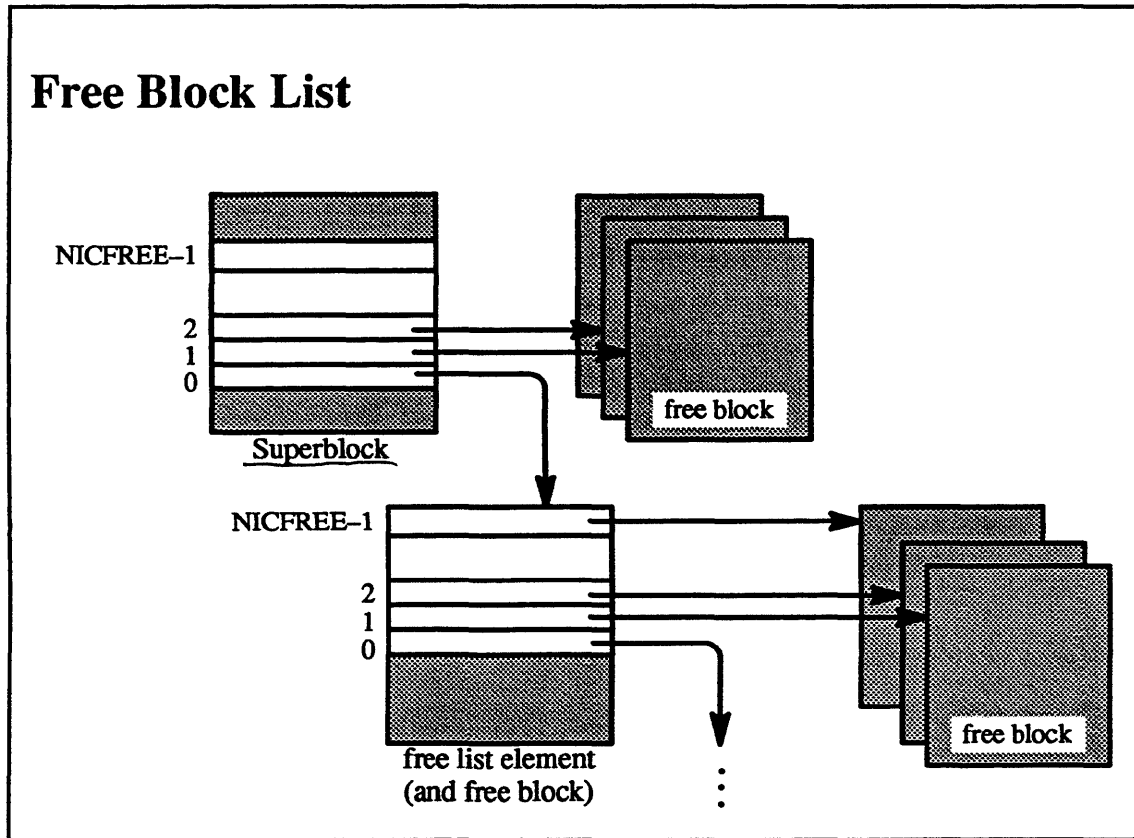

5-47.

© 1990, 1991 Open Software Foundation

## Module 5 — File Systems

---

### Student Notes: Free Block List

Free disk blocks are organized as shown in the picture. The superblock contains the address of up to NICFREE (= 100) free disk blocks. The last of these disk blocks contains NICFREE pointers to additional free disk blocks. The last of these pointers points to another block containing up to NICFREE free disk blocks, etc., until all free disk blocks are represented. Thus most requests for a free block can be satisfied by merely getting an address from the superblock. When the last block reference by the superblock is consumed, however, a disk read must be called to fetch the addresses of up to 100 more free disk blocks. Freeing a disk block results in reconstructing the list structure.

This organization, though very simple, scatters the blocks of files all over the surface of the disk. When allocating a block for a file, one must always use the next block from the free list; there is no way to request a block at a specific location. No matter how carefully the free list is ordered when the file system is initialized, it becomes fairly well randomized after the file system has been used for a while.

# Module 5 — File Systems

## 5-48. S5 File System

### Managing Inodes

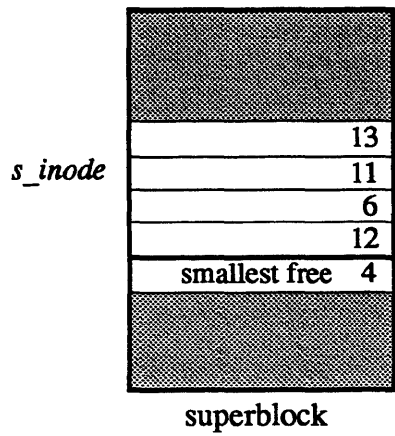

mode

15	0
14	
13	0
12	0
11	0
10	
9	0
8	
7	
6	0
5	
4	0
3	
2	
1	

I-list



## Module 5 — File Systems

---

### Student Notes: Managing Inodes

Inodes are allocated from the I-list. Free inodes are represented simply by zeroing their mode bits. The superblock contains a cache of indices of free inodes in an array called *s\_inode* (of size NICINOD). When a free inode is needed (i.e., to represent a new file), its index is taken from this cache. If the cache is empty, then the I-list is scanned sequentially until enough free inodes are found to refill the cache.

To speed this search somewhat, the cache contains a reference to the inode with the smallest index that is known to be free. When an inode is free, it is added to the cache if there is room, and its mode bits are zeroed on disk.

### 5-49. UFS File System

#### The UFS File System

- The goal is to lay out files on disk so that they can be accessed as quickly as possible and so that no more than a minimal amount of disk space is wasted
- Component names of directories can be much longer than in the S5 file system
- Fully parallelized

## **Module 5 — File Systems**

---

### **Student Notes: The UFS File System**

# Module 5 — File Systems

## 5-50. UFS File System

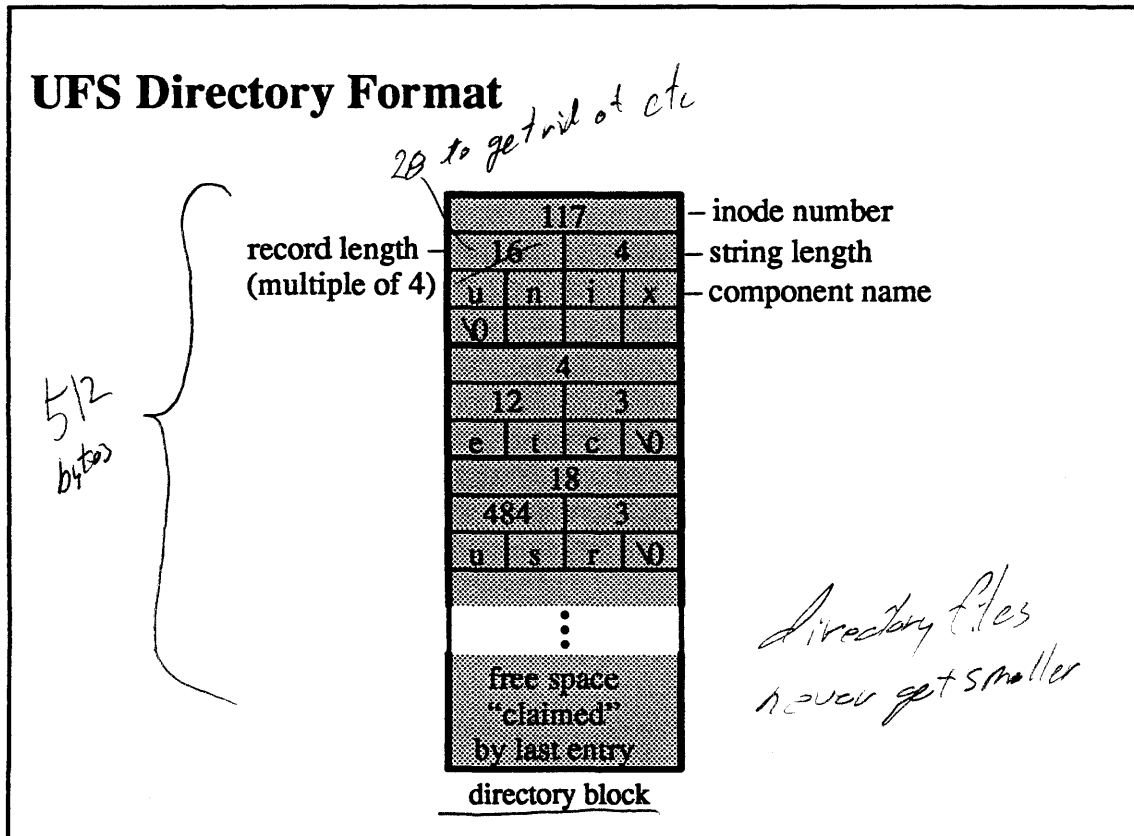

## Module 5 — File Systems

---

### Student Notes: UFS Directory Format

UFS allows component names to be up to 255 characters long, thereby necessitating a variable-length field for components. Directories are composed of 512-byte blocks and entries must not cross block boundaries. This design adds a degree of atomicity to directory updates. It should take exactly one disk write to update a directory entry (512 bytes was chosen as the smallest conceivable disk sector size). If it takes two disk writes to modify a directory entry, then clearly the disk will crash between the two disk writes!

Like the S5 directory entry, the UFS directory entry contains the inode number and the component name. Since the component name is of variable length, there is also a string length field (the component name includes a null byte at the end; the string length does not include the null byte). In addition to the string length, there is also a record length, which is the length of the entire entry (and must be a multiple of four to ensure that each entry starts on a four-byte boundary). The purpose of the record length field is to represent free space within a directory block. Any free space is considered a part of the entry that precedes it, and thus a record length longer than necessary indicates that free space follows. If a directory entry is free, then its record length is added to that of the preceding entry. However, if the first entry in a directory block is free, then this free space is represented by setting the inode number to zero and leaving the record length as is.

Compressing directories is considered to be too difficult. Free space within a directory is made available for representing new entries, but is not returned to the file system. However, if there is free space at the end of the directory, the directory may be truncated to a directory block boundary.

### 5-51. UFS File System

#### How to Do Disk I/O Quickly

1. Transfer as much as possible with each I/O request
2. Minimize seek time (i.e. reduce head movement)
3. Minimize latency time

## Module 5 — File Systems

---

### Student Notes: How to Do Disk I/O Quickly

The UFS file system uses three techniques to improve I/O performance. The first technique, which has perhaps the greatest payoff, maximizes the amount of data transferred with each I/O request by using a relatively large block size. UFS block sizes may be either 4K bytes or 8K bytes (the size is fixed for each individual file system). A problem with using a large block size is the wastage due to internal fragmentation: on the average, half of a disk block is wasted for each file. To alleviate this problem, blocks under certain circumstances may be shared among files.

The second technique to improve performance is to minimize seek time by attempting to locate the blocks of a file so that they are near to one another.

Finally, UFS attempts to minimize latency time, i.e. to reduce the amount of time spent waiting for the disk to rotate to bring the desired block underneath the desired disk head (many modern disk controllers make it either impossible or unnecessary to apply this technique).

# Module 5 — File Systems

## 5-52. UFS File System

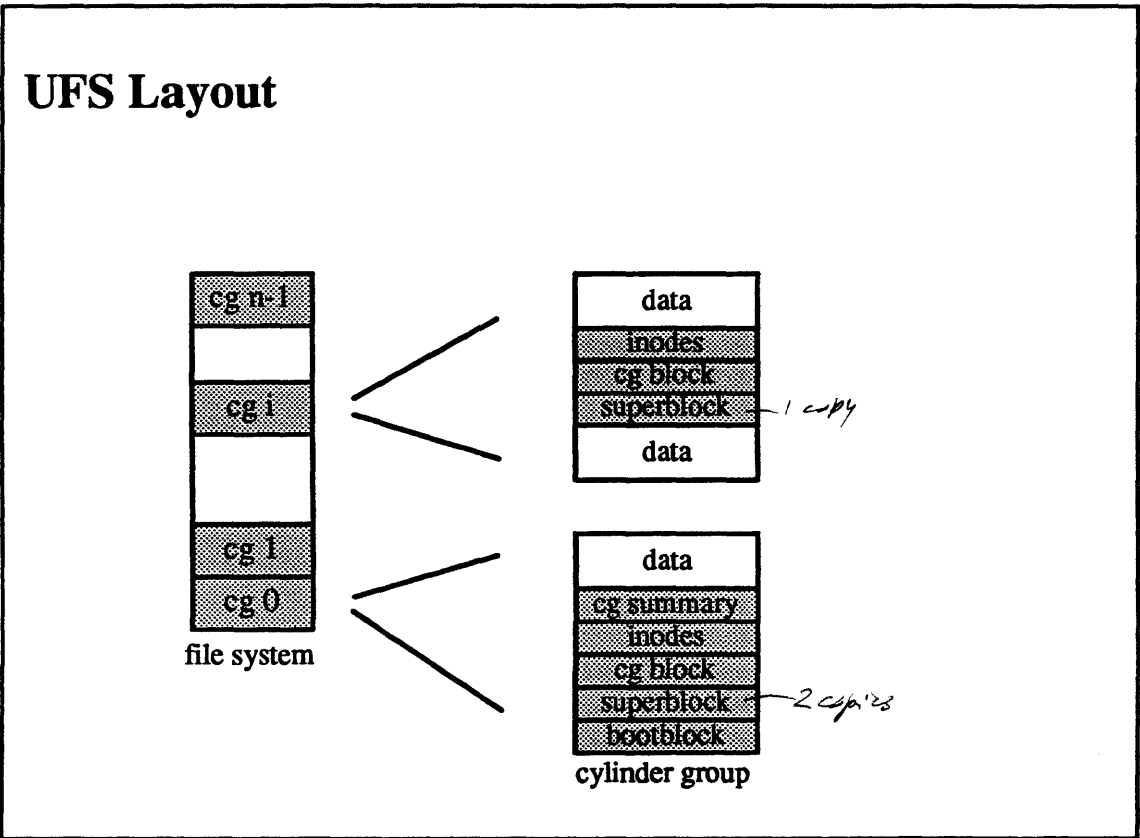

5-52.

© 1990, 1991 Open Software Foundation

*Loss of SBs on disk label*



## Module 5 — File Systems

---

### Student Notes: UFS Layout

- Superblock (*struct fs*)
  - incore while the file system is mounted
  - contains the parameters describing the layout of the file system
  - for paranoia's sake, one copy is kept in each cylinder group, at a rotating track position
- Cylinder group summary (*struct csum*, one for each cylinder group)
  - incore while the file system is mounted
  - contains a summary of the available storage in each cylinder group
  - allocated from the data section of cylinder group 0
- Cylinder group block (*struct cg*)
  - resides in the buffer cache "as needed"
  - contains free block map and all other allocation information

Note: the superblock contains two sorts of information, *static* and *dynamic*. The *static* information describes the layout of the entire file system and is essential to make sense of the file system. The *dynamic* information describes the file system's current state and can be computed from redundant information in the file system. If the static portion of the superblock is lost, then the file system cannot be used. To guard against this, each cylinder group contains a copy of the superblock (just the static information needs to be copied).

A possible (though unlikely) failure condition might be that the entire contents of one surface are lost, but the remainder of the disk is usable. However, if this surface contains all copies of the superblock, then the rest of the disk would be effectively unusable. To guard against this, the copy of the superblock is placed on a different surface in each cylinder group. Of course, the system must keep track of where these copies are. This information is kept in the disk label (along with information describing how the physical disk is partitioned).

### 5-53. UFS File System

#### Minimizing Fragmentation Costs

- A file system block may be split into fragments that can be independently assigned to files
  - fragments assigned to a file must be contiguous and in order
- The number of fragments per block (1, 2, 4, or 8) is fixed for each file system
- Allocation in fragments may only be done on what would be the last block of a file, and only if the file does not contain indirect blocks

*last block of small file*

## Module 5 — File Systems

---



### Student Notes: Minimizing Fragmentation Costs

# Module 5 — File Systems

## 5-54. UFS File System

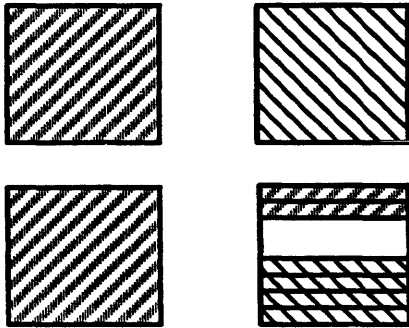
### The Use of Fragments, part 1



 file A  
 file B

## Module 5 — File Systems

---

### Student Notes: The Use of Fragments, part 1



This example illustrates a difficulty associated with the use of fragments. The file system must preserve the invariant that fragments assigned to a file must be contiguous and in order, and that allocation of fragments may be done only on what would be the last block of the file. In the picture, the direction of growth is downwards. Thus file A may easily grow by up to two fragments, but file B cannot easily grow within this block.

In the picture, file A is 18 fragments in length, file B is 12 fragments in length.

**5-55. UFS File System**

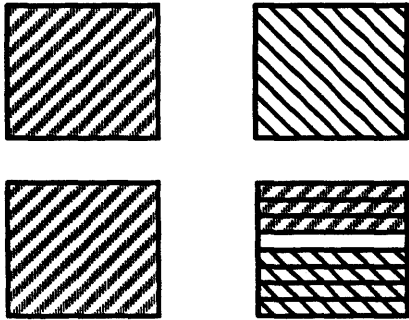
**The Use of Fragments, part 2**



 file A  
 file B

5-55.

© 1990, 1991 Open Software Foundation

## Module 5 — File Systems

---

### Student Notes: The Use of Fragments, part 2

File A grows by one fragment.

# Module 5 — File Systems

## 5-56. UFS File System

### The Use of Fragments, part 3

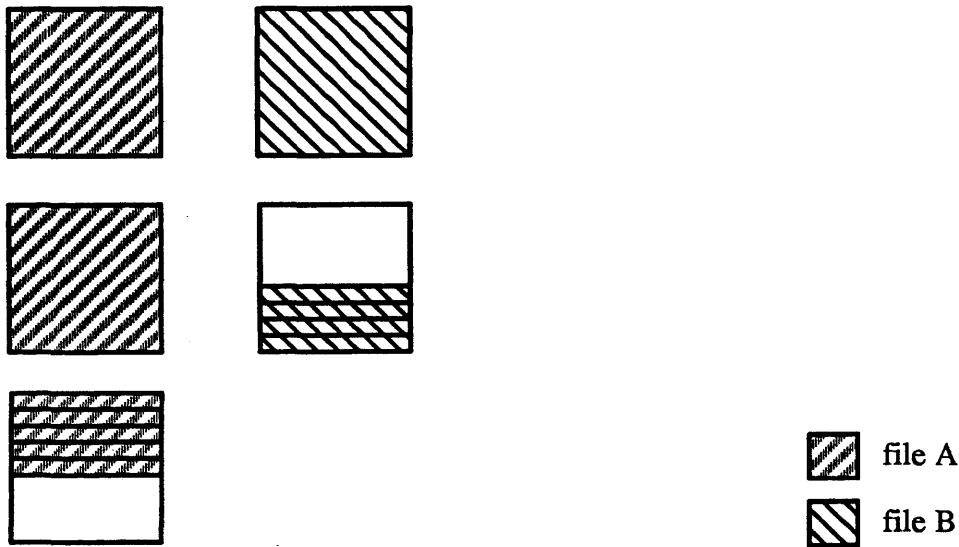

5-56.

© 1990, 1991 Open Software Foundation



## Module 5 — File Systems

---

### Student Notes: The Use of Fragments, part 3

File A grows by two more fragments, but since there is no space for it, the file system allocates another block and copies file A's fragments into it. How much space should be available in the newly allocated block? If the newly allocated block is entirely free, i.e., none of its fragments are used by other files, then further growth by file A will be very cheap. However, if the file system uses this approach all the time, then we do not get the space-saving benefits of fragmentation. An alternative approach is to use a "best-fit" policy: find a block that contains exactly the number of free fragments needed by file A, or if such a block is not available, find a block containing the smallest number of contiguous free fragments that will satisfy file A's needs.

Which approach is taken depends upon the degree to which the file system is fragmented. If disk space is relatively unfragmented, then the first approach is taken ("optimize for time"). Otherwise, i.e., when disk space is fragmented, the file system takes the second approach ("optimize for space").

The points at which the system switches between the two policies is parameterized in the superblock: a certain percentage of the disk space, by default 10%, is reserved for superuser. (Disk allocation techniques need a reasonable chance of finding free disk space in each cylinder group in order to optimize the layout of files.) If the total amount of fragmented free disk space (i.e., the total amount of free disk space not counting that portion consisting of whole blocks), increases to 8% of the size of the file system (or, more generally, increases to 2% less than the reserve), then further allocation is done using the best-fit approach. Once this approach is being used, if the total amount of fragmented free disk space drops below 5% (or half of the reserve), then further allocation is done using the whole-block technique.

### 5-57. UFS File System

#### Minimizing Seek Time

- The principle:

- keep related information as close together as possible
- distribute information sufficiently to make the above possible

- The practice:

- attempt to put new inodes in the same cylinder group as their directory
- put inodes for new directories in cylinder groups with “lots” of free space
  - put the beginning of a file (direct blocks) in the inode’s cylinder group
  - put additional portions of the file (each 2Mb) in cylinder groups with “lots” of free space

## **Module 5 — File Systems**

---

### **Student Notes: Minimizing Seek Time**

# Module 5 — File Systems

## 5-58. UFS File System

### Minimizing Latency, part 1

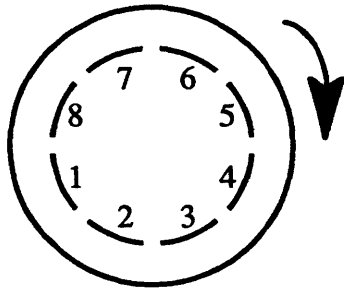

5-58.

© 1990, 1991 Open Software Foundation

## Module 5 — File Systems

---

### Student Notes: Minimizing Latency, part 1

A naive way of laying out consecutive blocks of the file on a track would be to put them in consecutive locations. The problem with this is that some amount of time passes between the completion of one disk request and the start of the next. During this time, the disk rotates a certain distance, probably far enough so that the disk head is positioned after the next block. Thus it will be necessary to wait for the disk to rotate almost a complete revolution for it to bring the beginning of the next block underneath the disk head. This delay could cause a significant slowdown.

## 5-59. UFS File System

### Minimizing Latency, part 2

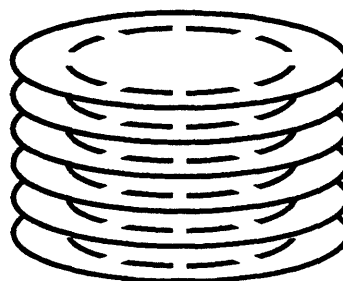
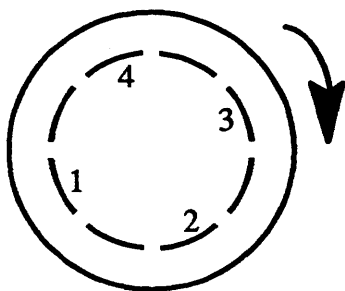

stacks of rotationally  
equivalent blocks

## Module 5 — File Systems

---

### Student Notes: Minimizing Latency, part 2

A better technique is not to lay out the blocks on the track consecutively, but to leave enough space between them so that the disk will rotate no further than to the position of the next block during the time between disk requests.

It may be that when a new block is allocated for a file, the optimal position for the next block is already occupied. If so, one may be able to find a block that is just as good. If the disk has multiple surfaces (and multiple heads), then we can make the reasonable assumption that the blocks underneath each head can be accessed equally quickly. Thus the stack of blocks underneath the disk heads at one instant are said to be *rotationally equivalent*. If all of these blocks are occupied, then the next stack of rotationally equivalent blocks in the opposite direction of disk rotation is almost as good as the first. If all of these blocks are taken, then the third stack is almost as good, and so forth all the way around the cylinder. If all of these are taken, then any block within the cylinder group is chosen.

This technique is perhaps not as useful today as in the past, since many disk controllers buffer entire tracks and hide the relevant disk geometry.

# Module 5 — File Systems

## 5-60. UFS File System

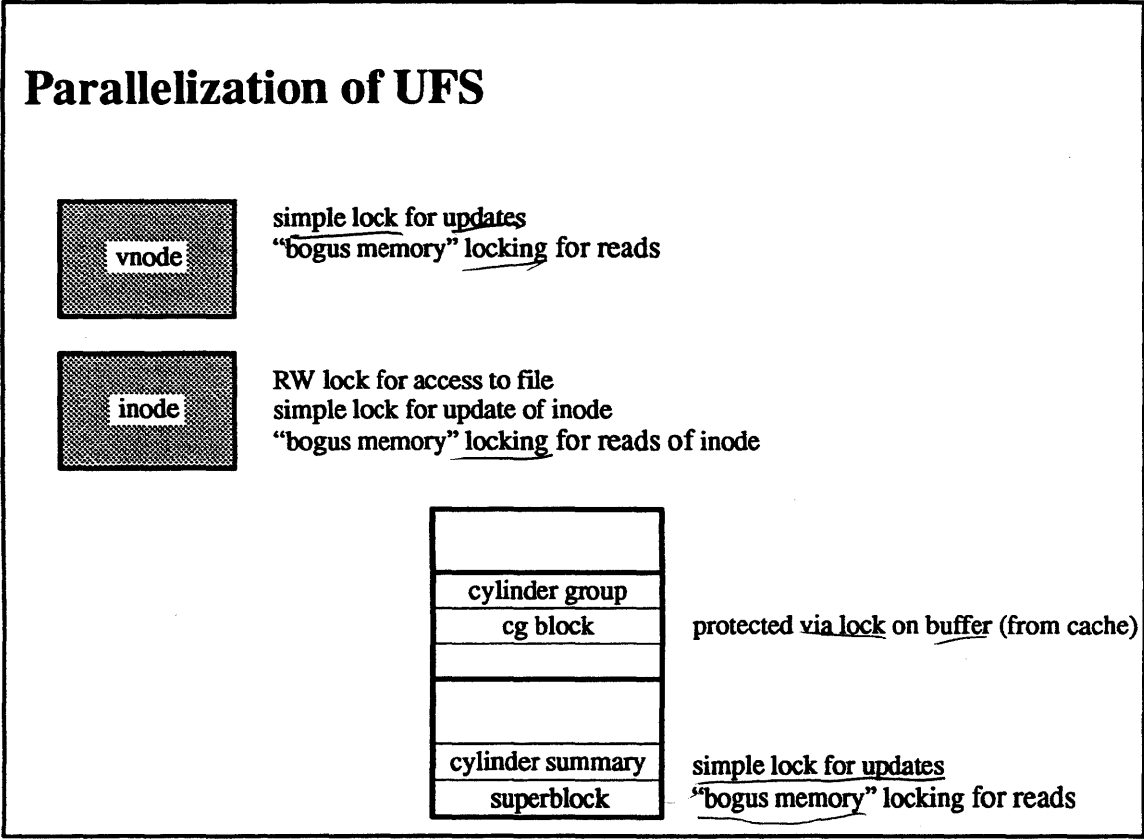

5-60.

© 1990, 1991 Open Software Foundation



## Module 5 — File Systems

---

### Student Notes: Parallelization of UFS

Two sorts of locking are used with UFS, blocking RW locks and simple locks (spin locks):

1. *blocking RW locks* (on inodes): used to protect the file across logical operations. I.e., synchronization is supplied at the granularity of the operations described by *uio* structures. As a special case, *cg blocks* reside in the buffer cache and are locked via the blocking lock on the buffer from the cache.
2. *simple locks* (spin locks): used to protect important system data structures (*inodes*, *vnodes*, and *superblocks*). Modifications to these data structures are always synchronized with simple locks. However, on many architectures, such synchronization is not necessary for reads: if the architecture guarantees that 32-bit, aligned items can be read atomically, then no locking is required. Thus, for example, a thread can read the *mode* bits from the inode and be guaranteed that they make sense.

Parallel architectures that do not supply such atomicity guarantees are deemed to have *bogus memory*. These cases are dealt with in the source code with the *BM* macro: *BM(lock(x))* expands to *lock(x)* on bogus-memory machines and expands to the null string on other machines. Thus locking is compiled conditionally.

# Module 5 — File Systems

## 5-61. NFS File System

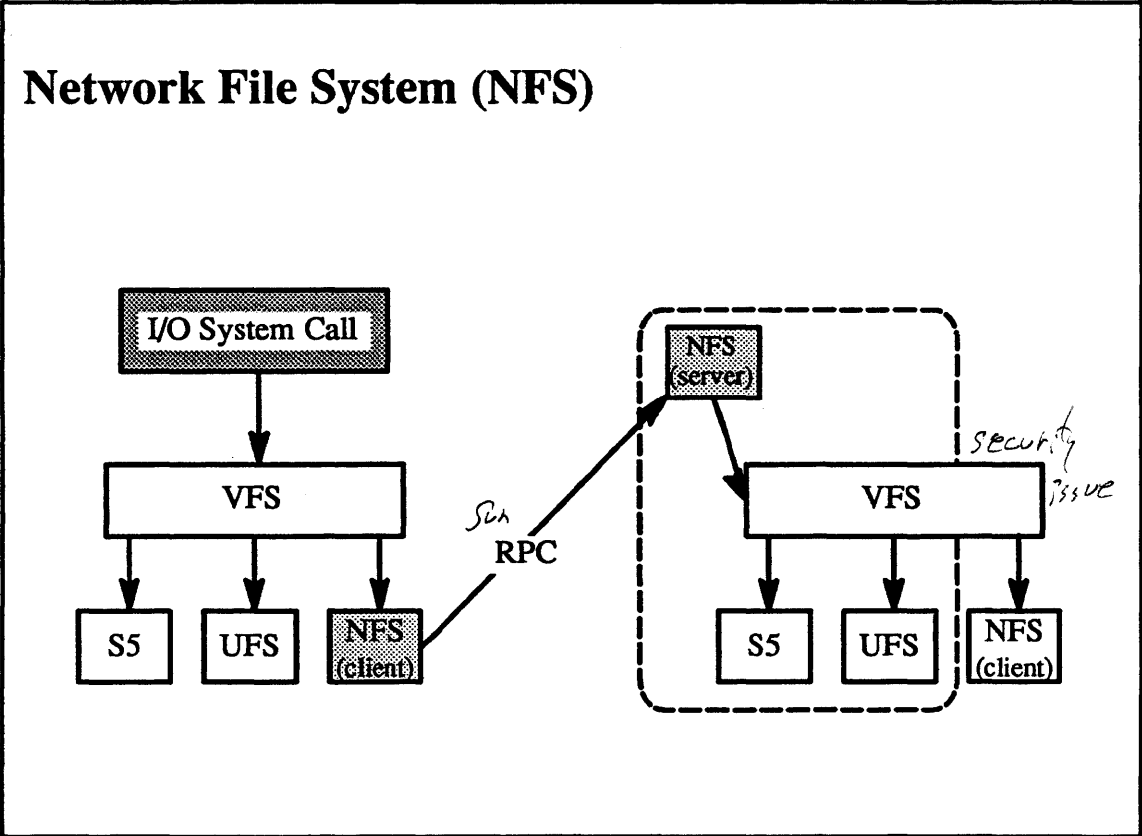

5-61.

© 1990, 1991 Open Software Foundation

## **Module 5 — File Systems**

---

**Student Notes: Network File System (NFS)**

### 5-62. NFS File System

#### NFS Highlights

Servers are stateless:

- server crash recovery is trivial
- NFS does not support full UNIX semantics
- NFS is “easily” supported on other operating systems

## Module 5 — File Systems

### Student Notes: NFS Highlights

Since servers contain no information about their clients, crash recovery is trivial in NFS: there is no information to be recovered after a crash. However, some state information is required for implementing certain UNIX I/O calls, and thus NFS cannot duplicate UNIX semantics exactly.

For example, a common technique for creating a temporary file is for a process to create a file and then to unlink the newly created file. Since the file is open, it continues to exist even though it has a zero link count (the reference count on its vnode is positive). The file is removed only when it is closed.

If this technique is practiced over NFS, the server does not know that the file is open (since this would be state information), and thus removes the file as it is unlinked. Since a number of important applications use this technique for creating a temporary file, the method must be accommodated. The client-side NFS code (executing in the kernel) converts *unlink* requests into *rename* requests, changing the name of the file to a temporary name. When the client application finally closes the file, the close is converted into an unlink and the file is removed.

Another example of the difference between UNIX and NFS semantics arises when an application changes the access permissions of an open file. Access checks for UNIX files are performed only when the file is opened. Thus, if the user successfully opens a file for read-write access and subsequently changes the permissions to read-only, write access to the already open file is still allowed. However, since the NFS server must check access permissions with each access to a file, write access would be denied in this case.

OSF/1 (and other UNIX implementations of NFS) provides only a partial solution to this problem. The NFS server allows the owner of a file read-write-execute access regardless of the permissions associated with the file; the NFS client filters requests to the NFS server on the basis of how the file was opened. Thus if the file was opened successfully for read-write access, then the client side allows read and write calls to be processed. However, if the file was opened as read-only, then the client side denies write requests.

A further difference between UNIX and NFS semantics is caused by the fact that NFS clients cache blocks from files provided by NFS servers. This means that processes on different machines do not necessarily have a consistent view of shared files.

**5-63. NFS File System**

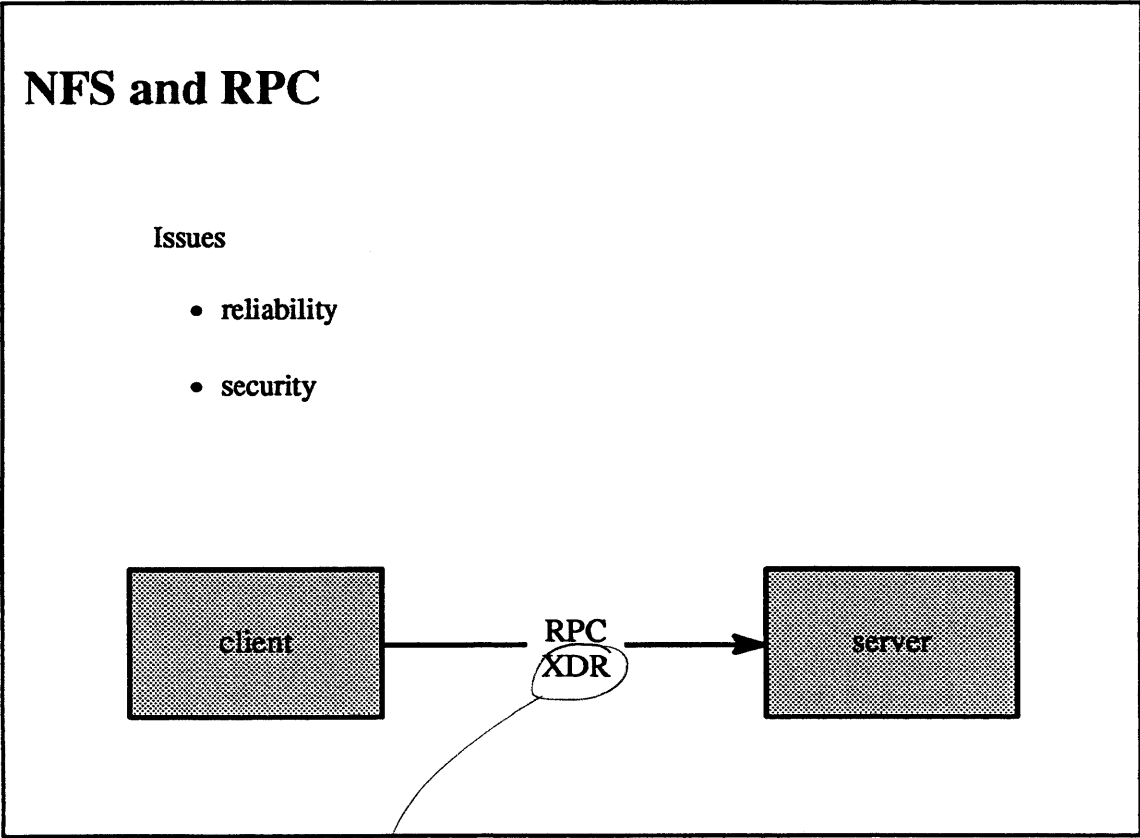

5-63.

© 1990, 1991 Open Software Foundation

*External  
Data  
Representation*

## Module 5 — File Systems

### Student Notes: NFS and RPC

The client and server communicate via Sun's RPC protocol. The XDR protocol copes with the heterogeneous environment. The two major issues are reliability and security.

The transport protocol is typically UDP, an <sup>but quick</sup> unreliable protocol. Thus NFS itself must provide reliability. NFS accomplishes this by taking advantage of the request/response semantics of the client-server interaction.

For example, suppose that a client issues a *write* request but receives no response. The client will repeat the request under the assumption that the original request was lost.

However, suppose that it was the response that was lost, and not the request. Now the server receives the *write* request twice. This usually presents no problems, because most NFS requests, such as *write*, are idempotent, meaning that the effect of performing the request twice is the same as performing it once. The *write* request is idempotent since it contains the location in the file to which the data is to be written. However, there are additional problems with reliability, as will be seen.

Security has always been a problem in NFS. The model for authentication is essentially "Trust me." Each NFS RPC request contains as part of its header the numeric user id of the caller. Servers refuse requests from the superuser but will trustingly honor any other requests. Sun uses an enhanced authentication technique for RPC involving a combination of DES and public-key encryption. OSF will deal with such problems through its *distributed computing environment* (DCE).

**5-64. NFS File System**

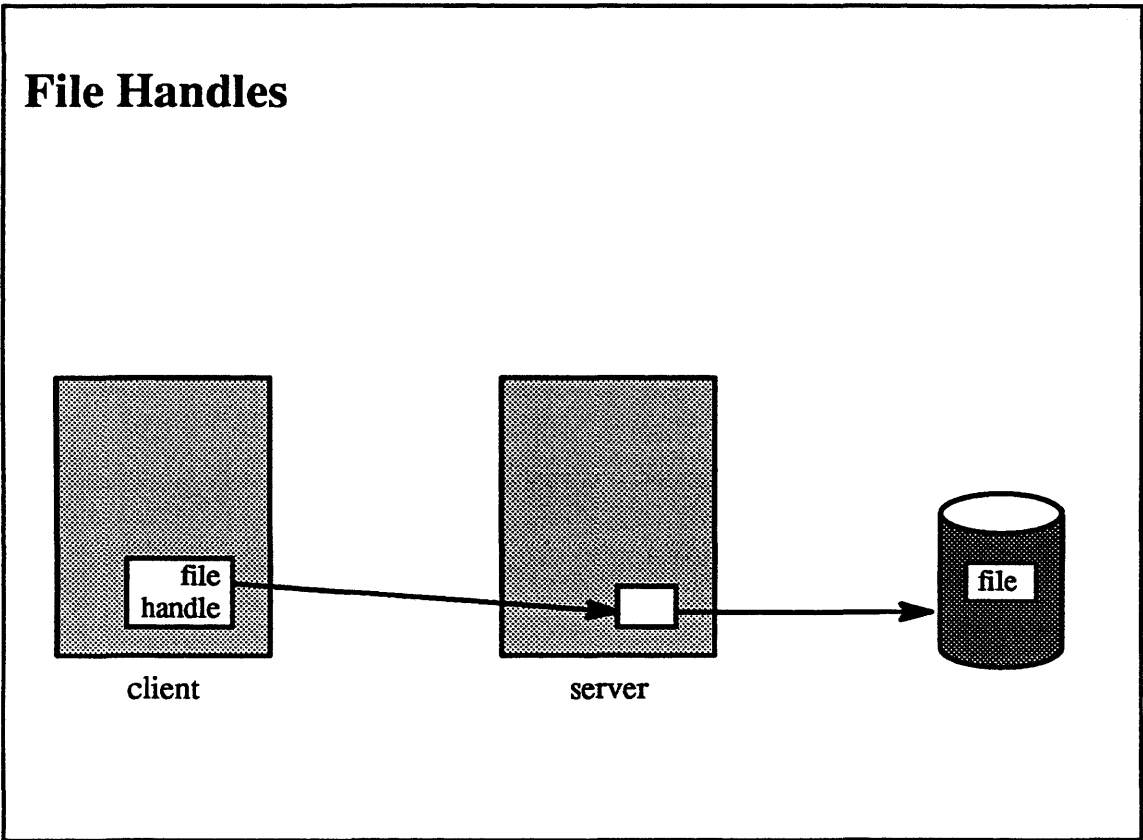

5-64.

© 1990, 1991 Open Software Foundation



## Module 5 — File Systems

---

### Student Notes: File Handles

When a file is opened, it is identified by its path name. The NFS server verifies that the file exists, checks that the desired access is currently allowed, and returns a *file handle* that the client will use to identify the file on subsequent accesses. Using the file handle for subsequent accesses thus avoids expensive path traversal for each access. This file handle is of an *opaque* data type meant not to be interpreted by the client but only to be passed back to the server.

UNIX servers pass back a handle consisting of:

- file system number ✓
- inode number ✓
- inode generation number ✓

The *generation number* copes with the confusion that could arise from the reuse of inodes. One client may open a file, another delete it, and a third might reuse the inode when it creates an entirely new file. When the first client attempts to access the original file, the server must be able to determine that the desired file no longer exists. So, when a client reuses an inode, the inode receives a new generation number to distinguish its current use from past uses. When a client accesses a no-longer-extant file, a “stale file handle” error message is returned to the client. The generation number is stored on disk in the inode.

**5-65. NFS File System**

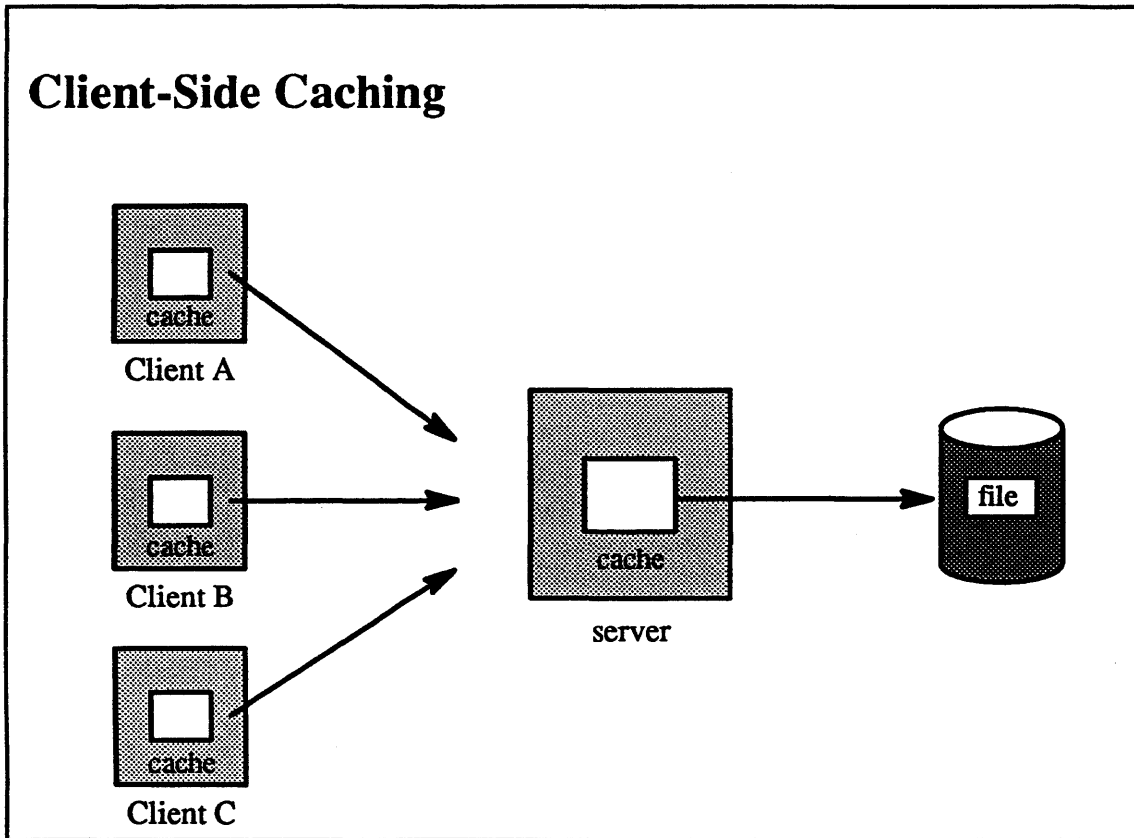

5-65.

© 1990, 1991 Open Software Foundation

## Module 5 — File Systems

---

### Student Notes: Client-Side Caching

Remote disk blocks are cached in the client's buffer cache. If multiple clients use the same file, there may be a consistency problem. While it is considered too expensive to keep the various caches consistent, an attempt is made to keep things from being too inconsistent. In each *nfsnode* is a copy of the associated remote file's attributes (i.e., what is obtained from a stat system call—information such as the file's modification time). Every time the attributes are fetched from the server, an *expiration time* of some number of seconds is set (five seconds in OSF/1). If the file is accessed before the attributes expire, then it is assumed that any locally cached blocks of the file are valid. If the attributes have expired, the new attributes must be obtained from the server and, if the file has been modified, then the locally cached blocks are flushed. (Modified cached blocks are written to the server.)

The cache is cleaned in response to close, sync, and fsync system calls (fsync is performed synchronously over NFS).

### 5-66. NFS File System

#### nfsbiiod Processes

- Concurrent I/O and computation require asynchronous *read-aheads* and *write-behinds*
- NFS's RPC requests are synchronous
- Solution: use additional kernel threads

## Module 5 — File Systems

---

### Student Notes: `nfsbiiod` Processes

When a process accesses files through the buffer cache, concurrency between I/O and computation is achieved by exploiting *read-aheads* and *write-behinds*. This is easy to do for I/O for local files, because the interface to the device driver is asynchronous. For example, when reading a file sequentially, one can start I/O *read* requests for the current block and the next block without waiting for the request to the latter. When writing a block, the user process merely modifies the buffer cache and the file itself is modified later, asynchronously.

The interface between the client and the NFS server is synchronous, since RPC requests are inherently synchronous. To achieve the desired concurrency, separate threads are used on the client to perform many NFS client RPC calls. These threads are pre-created and are known as *nfsbiiod* processes (these are user processes that have executed the `async_daemon` system call). Whenever an asynchronous I/O request is desired, the client checks to see if an *nfsbiiod* process is available. If so, then the request is given to it to perform in its own context. Otherwise, the caller performs the request in the caller's context (and blocks until the request is completed).

### 5-67. NFS File System

#### **nfsd Processes**

- Kernel processes that handle NFS requests on the server
- Must deal with “authentication” and access checking

## Module 5 — File Systems

---

### Student Notes: *nfsd* Processes

Each server has a number of *nfsd* processes that handle the incoming RPC requests for NFS. (These are user processes that have executed the *nfssvc* system call.) Unlike the *nfsbiocd* processes, the *nfsd* processes are essential. NFS requests are handled only in their context on the server. When such a process receives a request, it acts on behalf of the caller and temporarily assumes its identity. This is accomplished through the use of *credentials structures*, which contain *groupids* and a *userid* and are passed to the access-checking routines.

# Module 5 — File Systems

## 5-68. NFS File System

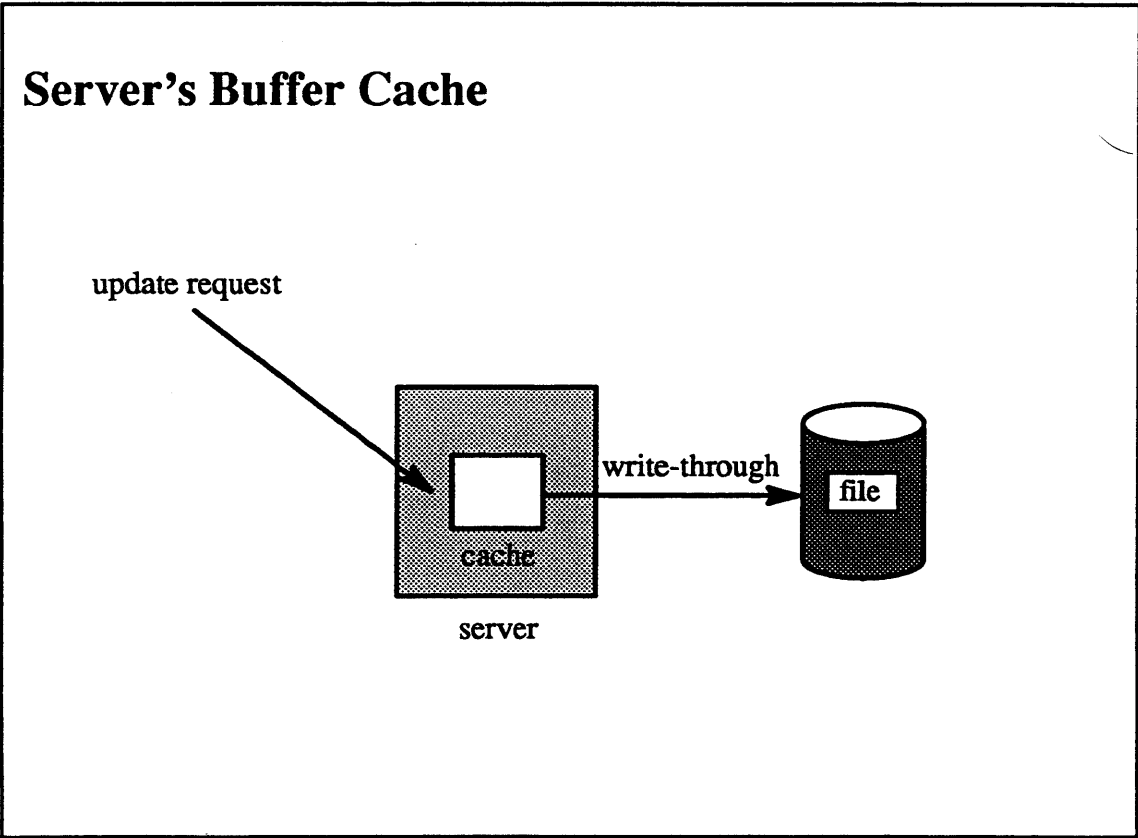

5-68.

© 1990, 1991 Open Software Foundation



## Module 5 — File Systems

---

### Student Notes: Server's Buffer Cache

The server's buffer cache is used for handling client requests, but it is treated as a write-through cache: when an *nfsd* process handles a *write* request, not only is the cache modified but also the data is written to the disk immediately and the RPC call does not return until the disk-write completes. This technique is consistent with the idea that NFS servers are stateless: data that is in the cache but not on disk is state information that the client would not want the server to lose if the server were to crash. The client is assured that, when an NFS RPC request returns, any requested changes to a file have been reflected on disk.

**5-69. NFS File System**

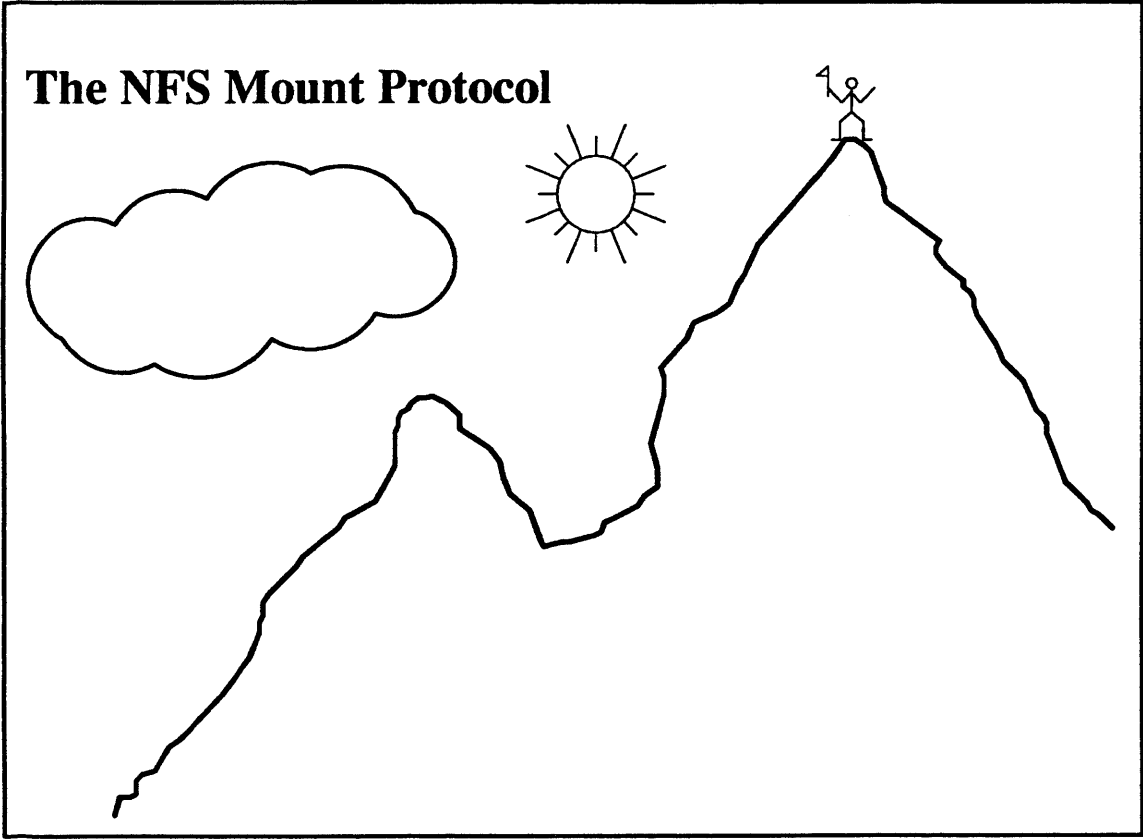

5-69.

© 1990, 1991 Open Software Foundation

## Module 5 — File Systems

---

### Student Notes: The NFS Mount Protocol

Like local file systems, in UNIX a remote file system must be *mounted* in the client's directory hierarchy in order to be used.

In OSF/1, the mount shell command makes an RPC request to the server's *mountd* process to obtain a file handle for the mount point. The *mountd* process is a user process that implements the server side of the mount protocol (the mount shell command implements the client side). Each server maintains in the */etc/exports* file a list of exported file systems and the clients to which they are exported. The *mountd* process first makes certain that the client is allowed to mount the requested file system, then returns to it the file handle for the root of the file system. The mount shell command then issues a `mount` system call, passing to the kernel the file handle and the path name of the mount point.

# Module 5 — File Systems

## 5-70. NFS File System

### Remote Mounting, part 1

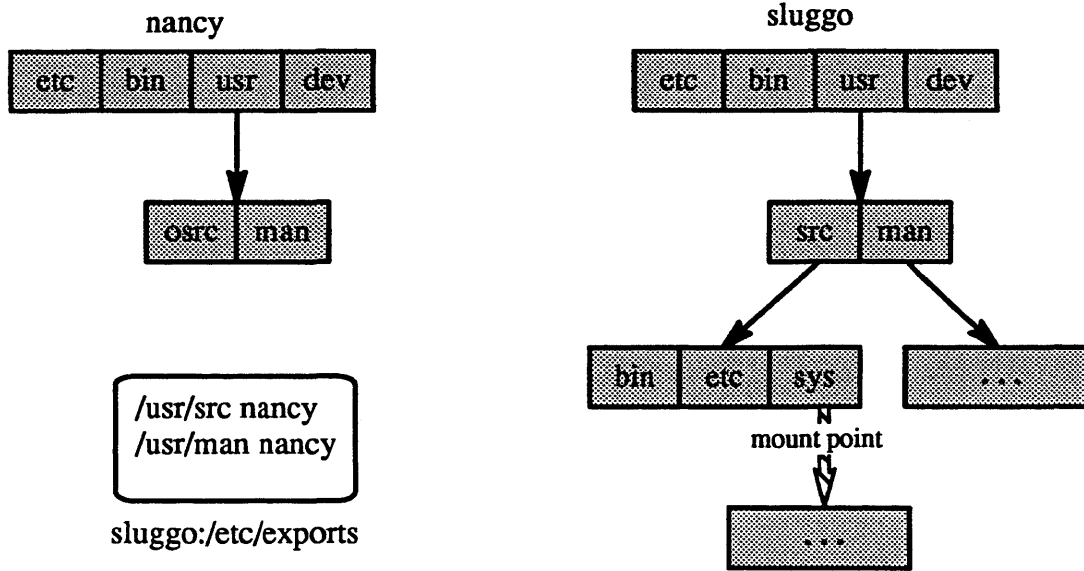

5-70.

© 1990, 1991 Open Software Foundation

## Module 5 — File Systems

---

### Student Notes: Remote Mounting, part 1

In this picture we have two machines, nancy and sluggo. Sluggo exports two file systems to nancy, identified as */usr/src* and */usr/man*.

# Module 5 — File Systems

## 5-71. NFS File System

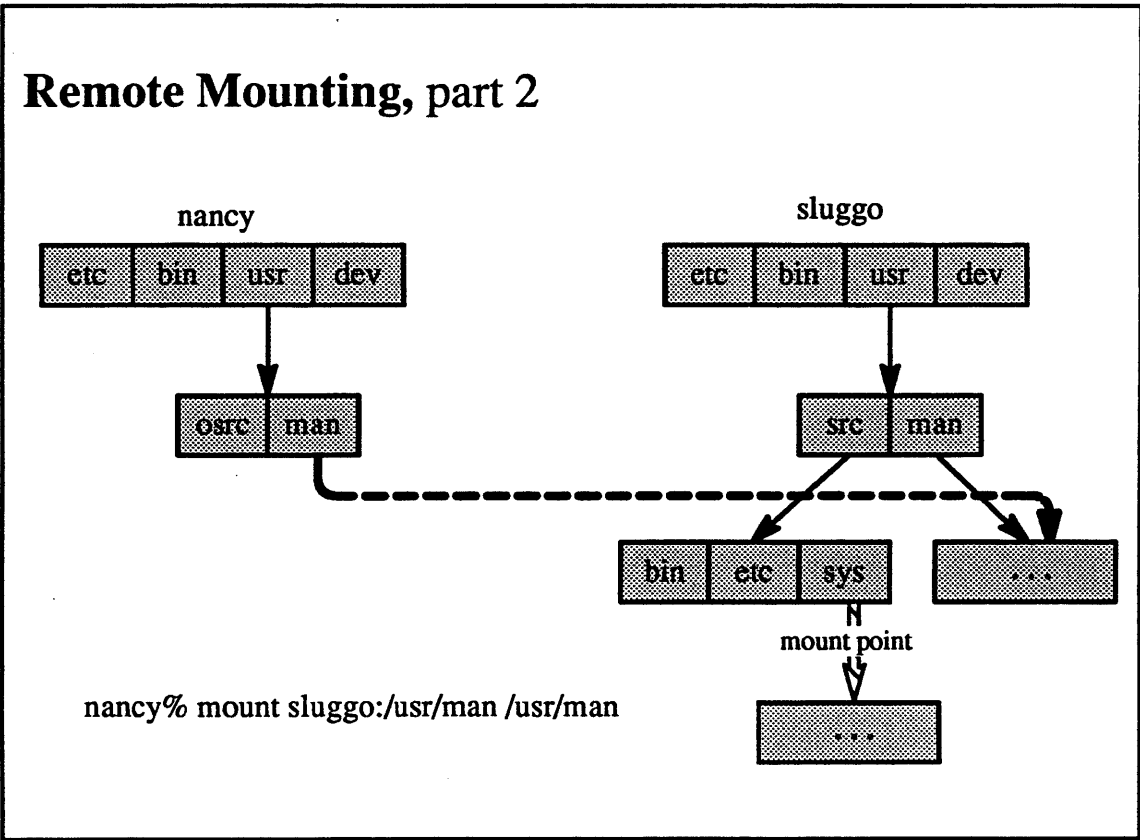

5-71.

© 1990, 1991 Open Software Foundation

## Module 5 — File Systems

---

### Student Notes: Remote Mounting, part 2

Nancy mounts sluggo's */usr/man* on its own */usr/man* directory.

**5-72. NFS File System**

**Remote Mounting, part 3**

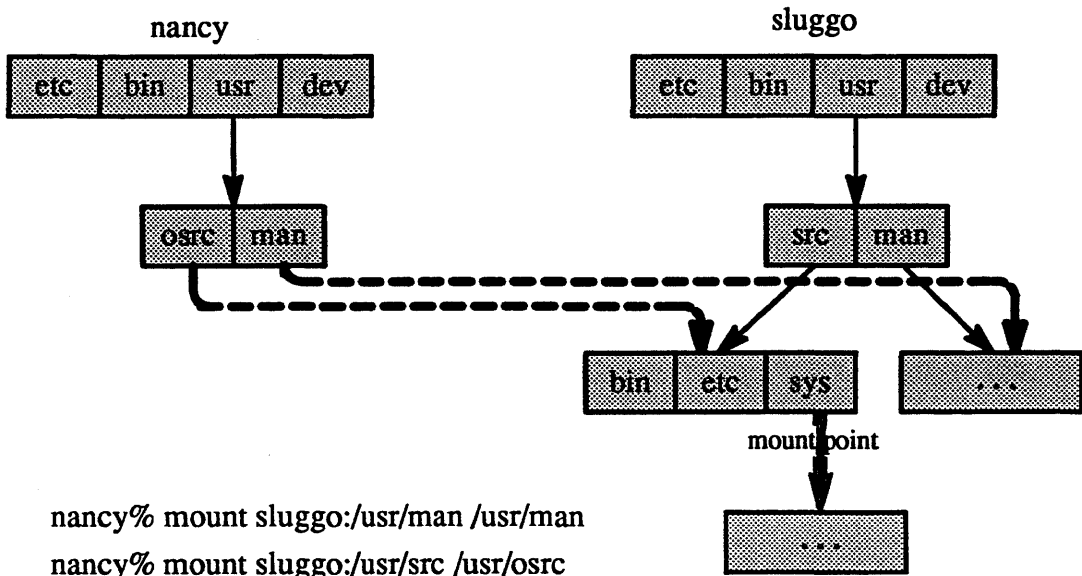

```
nancy% mount sluggo:/usr/man /usr/man
nancy% mount sluggo:/usr/src /usr/osrc
```



## Module 5 — File Systems

---

### Student Notes: Remote Mounting, part 3

Nancy now mounts sluggo's */usr/src* on nancy's */usr/osrc*. On sluggo, */usr/src/sys* is a mount point: another file system, *X*, has been mounted here and, from sluggo's point of view, the root directory of this file system is superimposed on top of the directory */usr/src/sys* (thus the original contents of this directory are invisible to sluggo). However, nancy does not see this mount point.

The directory (on nancy) */usr/osrc/sys* is not mounted upon. Unlike sluggo, nancy sees the actual contents of this directory. If it is desired that this mount point exist in nancy's view as it does in sluggo's, then nancy could explicitly mount file system *X* on top of the directory */usr/osrc/sys*.

The reasons for not having a client use the server's mount points are partly for security, but mainly for simplicity. Suppose on server B, file system *Y* (from server C) is mounted on a directory within file system *X* and file system *Z* (on the same server as *X*) is also mounted within file system *X*. If client A mounts *X* (and thus appears in B's */etc/exports* list), what would be required for it to be able to follow the mount point to *Y* on server C? A must appear in C's */etc/exports* list. But C has only verified that B is there. If B were to pass on A's requests to C, it would have to ensure that C approves of A. Rather than do this complicated checking, the convention is that A must mount *Y* itself.

Note that it wouldn't be very difficult for B to allow A to follow the mount point to *Z*, but, again, for simplicity, this is not done.

### 5-73. NFS File System

#### When the Server Crashes ...

- Hard mounts
  - Soft mounts
  - Interruptible hard mounts
- } original NFS*

## Module 5 — File Systems

---

### Student Notes: When the Server Crashes ...

The client's response to server crashes depends upon an option specified when the remote file system was mounted. If the client specified a *hard mount*, then any system call involving a file on the remote machine blocks until the machine comes back up (whether this takes seconds or weeks). Such system calls block *uninterruptibly*, so there is no way to abort the process making the system call. This can be very annoying.

Another option is the *soft mount*. Any system calls involving files on the dead remote machine will return (eventually) with the error code ETIMEDOUT. This option might seem a good idea, but there are difficulties. A number of UNIX applications pay no attention to error returns on I/O system calls (if the `open` succeeded, there could not possibly be any problems with reads and writes...). Thus damage may be done because the client is unaware of the crash.

A <sup>few</sup> more reasonable way of mounting the remote file system is the *interruptible hard mount*. With this option, as before, system calls involving a file on the remote machine block until the machine comes back up, but the wait is *interruptible* (i.e., by signals). However, the interrupt is not immediate: the underlying RPC layer performs many retries before checking to see if a signal is pending.

# Module 5 — File Systems

## 5-74. NFS File System

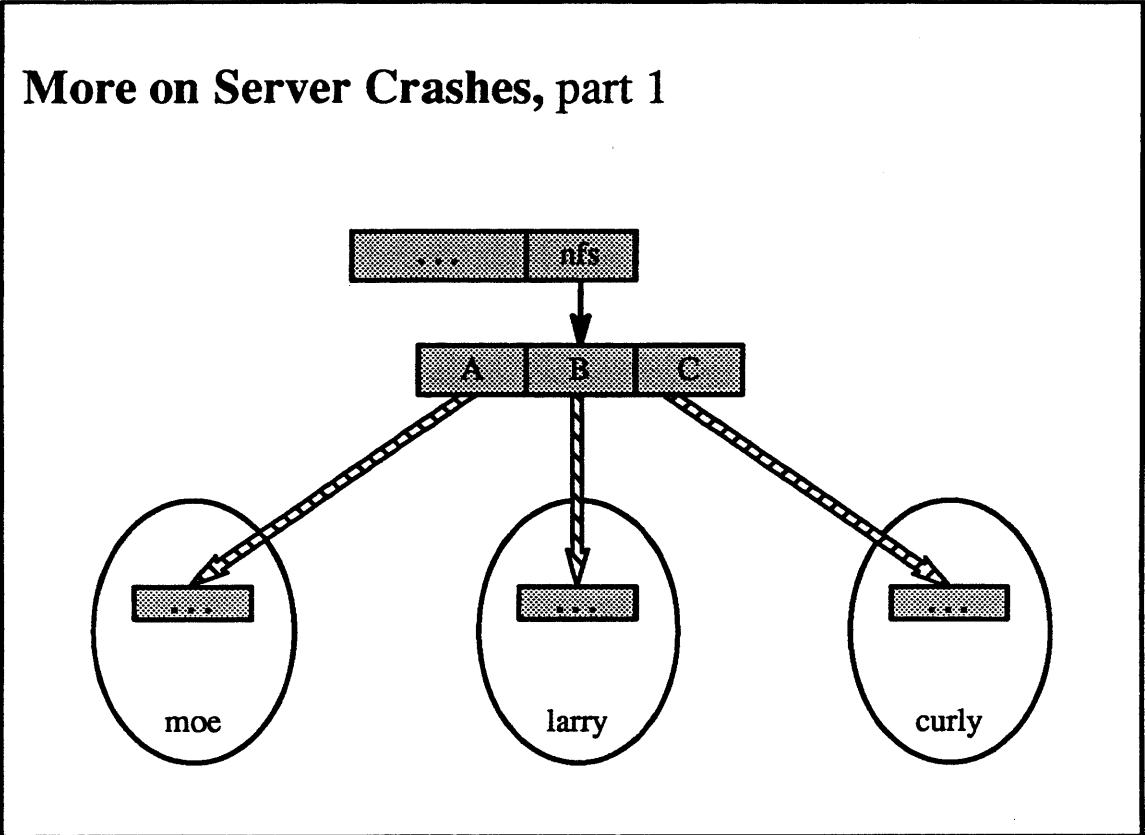

5-74.

© 1990, 1991 Open Software Foundation

## Module 5 — File Systems

### Student Notes: More on Server Crashes, part 1

Here moe, larry, and curly are the names of NFS servers. Each contains a file system that has been mounted, respectively, in */nfs/A*, */nfs/B*, and */nfs/C* (i.e., the client has set up its directory hierarchy so that all NFS mounts are in one directory). Suppose one's current directory is in the root directory of curly's file system and one executes the *pwd* command. The result should be */nfs/C*. How does the *pwd* command work? It determines the inode of the current directory ("."), and then searches the parent directory ("..") until it finds the component name associated with the matching inode number. It then repeats this procedure backwards along the path until it reaches the root directory.

However, when a mount point is encountered, the parent directory of the mount point does not contain the inode number of the root directory of the mounted file system. Instead, the *pwd* command must issue the *stat* system call for each entry of the parent directory until it finds the entry that refers to the mounted file system.

Back to our example. Suppose that NFS server moe is down. When the *pwd* command is executed starting with curly's root directory, it will be necessary to *stat* each of the entries in the */nfs* directory to determine which of them refers to curly. But, since moe is down, the *stat* call will hang when it is applied to */nfs/A*. Thus it will be impossible to complete the *pwd* command until machine moe comes back up, even though there is no logical connection between the path */nfs/C* and the machine moe.

This is especially annoying because both *csh* and *ksh* perform a *pwd* when starting up.

• • B, which is my inode

• stat to get my inode

# Module 5 — File Systems

## 5-75. NFS File System

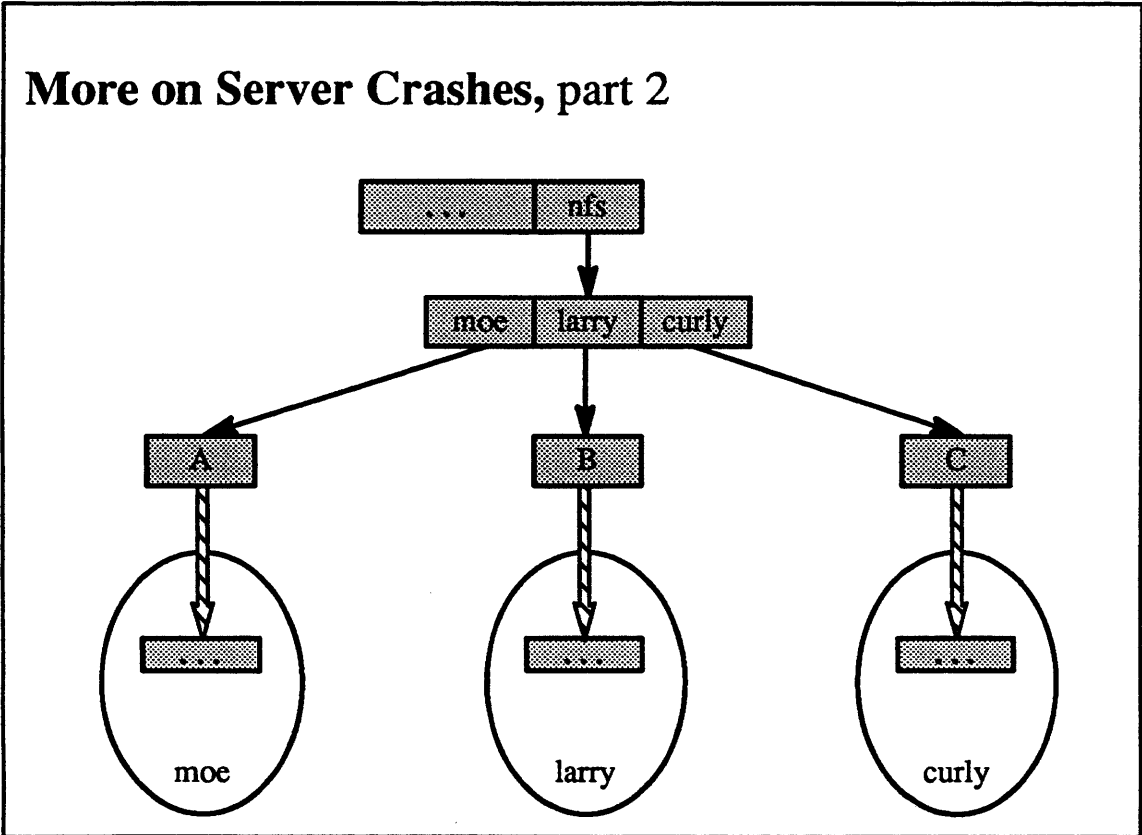

5-75.

© 1990, 1991 Open Software Foundation

## Module 5 — File Systems

---

### Student Notes: More on Server Crashes, part 2

This picture illustrates a safer NFS mount technique. An extra level of directories has been added so as to avoid the problems with *pwd*.

# Module 5 — File Systems

## 5-76. NFS File System

### The Problem of (Non)Idempotency

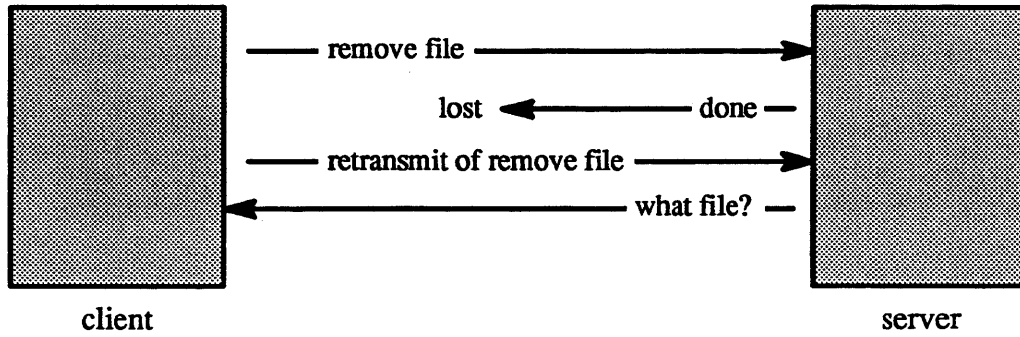

5-76.

© 1990, 1991 Open Software Foundation



## Module 5 — File Systems

---

### Student Notes: The Problem of (Non)Idempotency

As previously mentioned, NFS is typically implemented on top of an unreliable protocol and thus must implement reliability guarantees itself. To accomplish this, it exploits the request/response nature of its interaction: if a client receives no response to its request, it assumes that the request was lost and repeats it. However, difficulties can occur if it was the response that was lost, not the request.

This situation should be no problem as long as the requests are *idempotent*, as was discussed on page 5-129. Certain requests, however, are known to be *nonidempotent*. For example, suppose that a *remove file* request is repeated because the first response was lost. The response to the second request indicates an error because the file no longer exists. But, other than the error, the desired effect has been achieved—the file has been removed, though the programmer may end up somewhat confused.

With some cooperation by the server, this sort of nonidempotency, known as *nondestructive nonidempotency*, can be made transparent. In the original reference port for NFS, the server maintains a queue of completed nonidempotent requests and their responses. If a nonidempotent request fails, the server checks this queue to see if this is a repeat of an earlier request (the RPC headers contain a *transmission id (xid)* to facilitate this duplicate detection). If it is, then the server repeats the previous response.

However, as the next slide shows, there are other, more subtle cases that are not dealt with.

# Module 5 — File Systems

## 5-77. NFS File System

### A Problem Case\*

Time	Client Activity	Server Activity
t0	process starts	idle
t1	transmit <i>creat</i> request (C0)	idle
t2	wait for <i>creat</i> response	receive C0; schedule <i>nfsd1</i>
t3	retransmit <i>creat</i> request (C1)	<i>nfsd1</i> : complete C0, truncate file, send <i>creat</i> response
t4	receive <i>creat</i> response; process resumes	receive C1; schedule <i>nfsd1</i>
t5	transmit <i>write</i> request (W0)	<i>nfsd1</i> : starts but blocks on a system resource
t6	wait for <i>write</i> response	receives W0, schedules <i>nfsd2</i>
t7	wait for <i>write</i> response	<i>nfsd2</i> : complete W0, send <i>write</i> response
t8	receive <i>write</i> response; process completes	<i>nfsd1</i> : complete C1, truncate file, send <i>creat</i> response
t9	receive <i>creat</i> response—discard it	idle

\* from "Improving the Performance and Correctness of an NFS Server," by Chet Juszczak, *Conference Proceedings of 1989 Winter USENIX Technical Conference*. Used with permission.

## Module 5 — File Systems

---

### Student Notes: A Problem Case

A side effect of a *creat* request is to truncate the file to zero length if it already exists. In this example, the intention was to truncate the file and then write to it, but the result was the opposite: the file was written to, then truncated. The problem is that, though the *write* request and the *creat* request are by themselves idempotent, more complicated interactions have occurred. That is, idempotency itself is not sufficient.

# Module 5 — File Systems

## 5-78. NFS File System

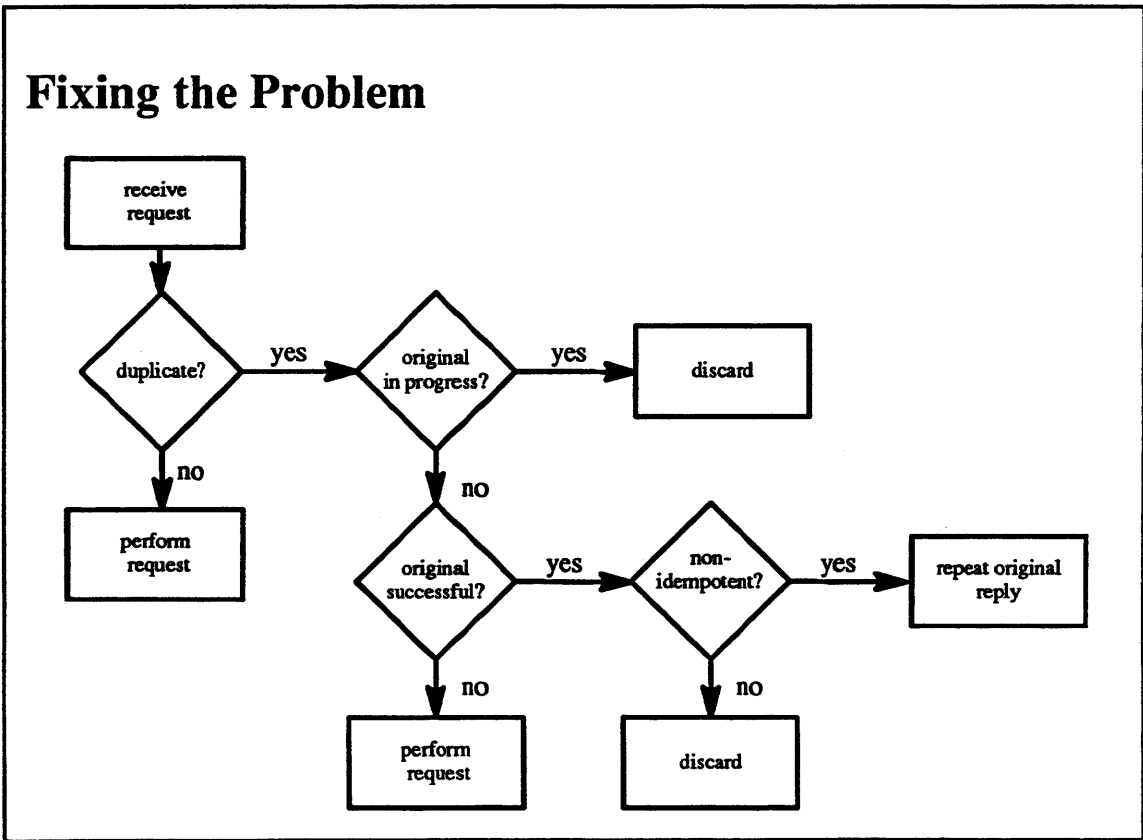

5-78.

© 1990, 1991 Open Software Foundation

## Module 5 — File Systems

---

### Student Notes: Fixing the Problem

OSF/1 solves this problem by using the technique described in the paper referenced on the previous slide. The NFS server maintains a cache of active and completed requests. Items stay in this cache for a finite period (2 seconds). When the server receives a request, it immediately checks if it is a duplicate of a request still in the cache. If it is, and if the original is still in progress, then the duplicate is discarded, i.e. the client timed out prematurely. If the original completed successfully, the duplicate is again discarded. (Here we are assuming that the response was not lost but that the client again timed out prematurely—from observation, this is the usual case.)

If the response was indeed lost, the client will continue to retry the request; eventually the original request will have been removed from the cache, so that a retry will not be recognized as such and will actually be retried. The problem outlined in the previous slide will not occur, since the client does not move on to its next request until it finally gets a response from its current request. If the original failed, the server retries the duplicate (there is no particular rationale for retrying the duplicate other than that this is the behavior of the original implementation of NFS).

# Module 5 — File Systems

## 5-79. NFS File System

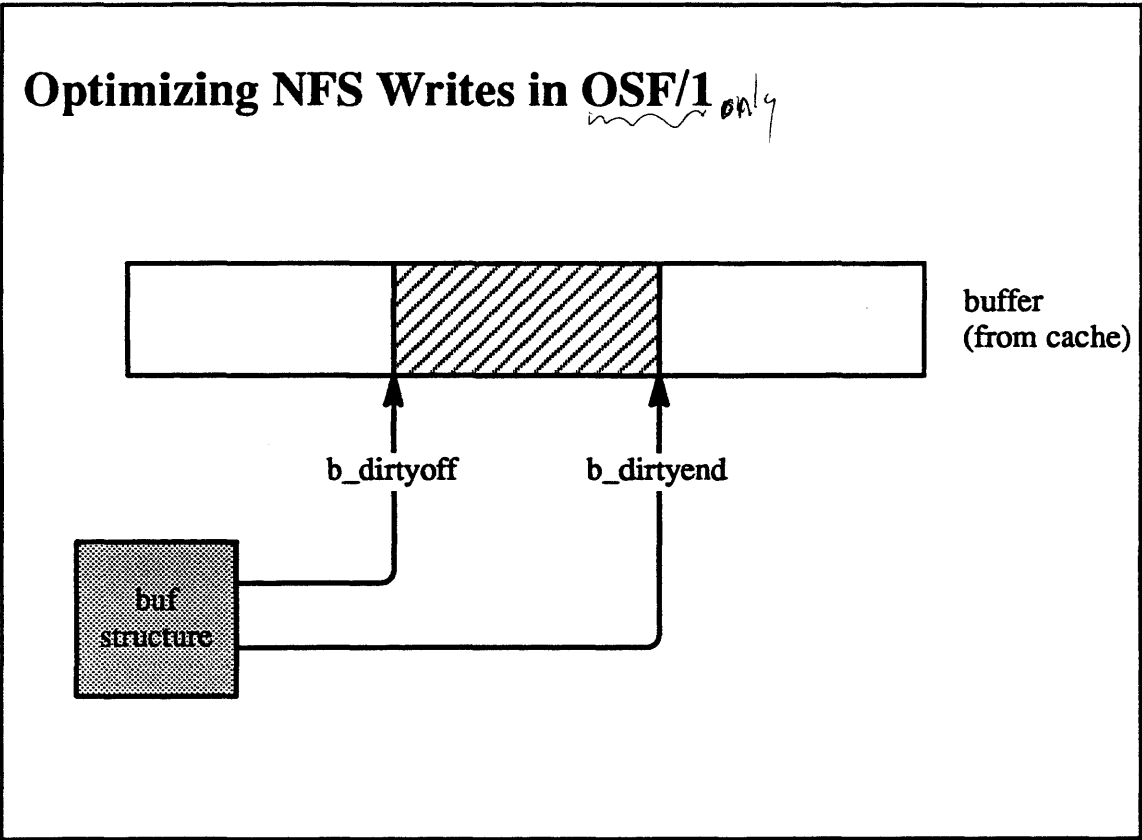

5-79.

© 1990, 1991 Open Software Foundation

## Module 5 — File Systems

---

### Student Notes: Optimizing NFS Writes in OSF/1

Normally (i.e., when using a local file system), when one writes to a file a span of data that does not fill an entire buffer from the cache, the block I/O subsystem first reads a whole block, then modifies the desired portion of the block. To eliminate the need for these (expensive) reads when writing to an NFS file, the block I/O subsystem keeps track of what portion of a buffer has been modified (using two new fields in the buf structure: *b\_dirtyoff* and *b\_dirtyend*). Thus when the buffer is “cleaned,” just the modified portion is written to the server.

This presents a problem if the entire buffer is read by an application before the modified portion is sent to the server: consider a situation in which bytes 2048 through 8191 of a file are modified on the client, and no blocks of the file currently reside in the client’s cache. An 8K buffer is allocated on the client, but only locations 2048 through 8191 are written. At this point, a thread on the client attempts to read the entire 8K portion of the file. Rather than complicate the client-side code so that it will recognize that it must first fetch bytes 0 through 2047 from the server, the client, whenever it reads from an NFS file that it has recently written to, first cleans its buffer cache of blocks from this file (by sending dirty blocks to the server). Then it checks the attributes of the file with the server and fetches the block from the server if necessary.

For further discussion about this implementation of NFS, see Macklem, 1991.

## 5-80. NFS File System

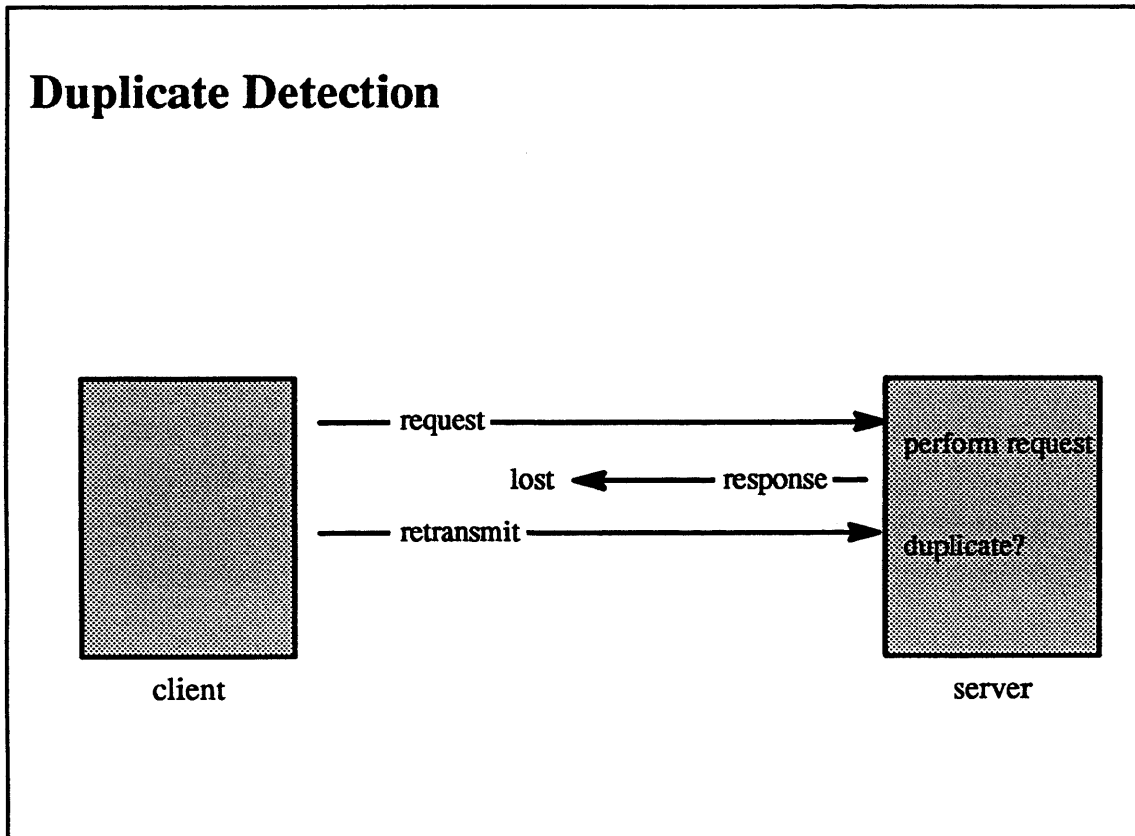

5-80.

© 1990, 1991 Open Software Foundation



## Module 5 — File Systems

---

### Student Notes: Duplicate Detection

As mentioned previously, duplicate detection relies on an *xid* supplied by the RPC level. However, retransmissions are performed by a pair of nested loops. In the inner loop, retransmissions are done by the RPC layer, which does not modify the value of the *xid*. However, after this loop is performed a finite number of times, control passes to the outer loop, which is performed by the NFS layer (client side). In the original reference port, at each iteration of this loop the *xid* would change. OSF/1 (which does not have separate NFS and RPC layers, but combines them into a single layer) fixes this by ensuring that the *xid* never changes during retransmissions.

## 5-81. NFS File System

### Parallelization of NFS

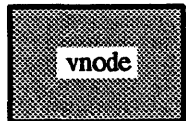

simple lock for updates  
"bogus memory" locking for *reads*

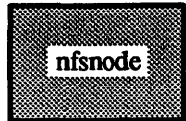

RW lock for access to file  
simple lock for update of *nfsnode*  
"bogus memory" locking for *reads* of *nfsnode*

## Module 5 — File Systems

---

### Student Notes: Parallelization of NFS

At the higher levels, the parallelization is very similar to that of UFS: there are blocking RW locks on *nfsnodes* to protect access to files at the level of operation described by *uio* structures. Simple locks are used to synchronize updates to *vnodes* and *nfsnodes*. Reads of these data structures need only be protected on architectures with “bogus memory.”

Simple locks are used at lower levels for synchronization of NFS data structures. For example, the client side maintains a queue of NFS RPC requests (which are waiting for responses). The server side maintains a table of active and completed requests, accessed via a hash table.

## Module 5 — File Systems

---

### Exercises:

1. Explain the use of the reference count in the system file table entries.
2.
  - a. What are the roles of the *vfsofs* and *vnodeops* data structures in the abstraction of the file system concept?
  - b. Some versions of UNIX maintain a “mount table” in the kernel, representing in tabular form which file systems are mounted where. How is this sort of information represented in OSF/1?
  - c. Why is it necessary for a thread to hold a lock over the entire period during which it is using the offset field of the system file table entry?
3.
  - a. How does the buffer cache facilitate concurrent I/O and computation?
  - b. Why are blocks in the buffer cache identified by vnode and block number?
  - c. What happens when two threads simultaneously access a file block that is not currently in the cache?
4.
  - a. How are directories protected from concurrent conflicting updates?
  - b. Explain the concept and use of *capabilities* in the directory lookup cache.
5.
  - a. What aspects of the operating system limit the maximum possible size of the file?
  - b. What are the performance problems inherent in the standard S5 file system?
6.
  - a. How is free space represented in a UFS directory?
  - b. List the techniques used in the UFS file system to improve performance.
  - c. What are the two different policies for allocating fragments for a file? Under what circumstances is each policy used?
  - d. Suppose that two threads are extending the size of two different files within the same file system. What data structures need to be protected from concurrent access? What types of locks are employed for this protection? Under what circumstances can the two threads proceed without one having to wait for the other?
7.
  - a. List three differences between NFS semantics and UNIX semantics.
  - b. Explain how generation numbers are used.
  - c. What is the function of *nfsbioid* processes?
  - d. Why is the server’s buffer cache accessed in a synchronous write-through fashion?
  - e. What are the differences between hard mounts, soft mounts, and interruptible hard mounts?

## Module 5 — File Systems

- f. Why is it necessary for the server to maintain a queue of recent NFS requests?

### Advanced Questions:

- 8. A thread executing an I/O system call involving an ordinary file must obtain blocking locks on the *file table entry* and on *buffers* in the *buffer cache*. On a multiprocessor, a simple lock is needed for operations on the *vnode*. Why are all of these locks necessary? Could fewer be used?
- 9. On page 5-77, we discuss the use of timestamps to avoid a race condition. Why isn't this race condition dealt with by combining the lookup and delete operations into a single operation?

**Module 5 — File Systems**

# Module 6 — Device Drivers and Terminal I/O

---

## Module Contents

1. Special Files .....	6-4
Identifying devices and drivers	
Flow of control	
Data structures	
2. Dynamic Configuration .....	6-10
3. Device Drivers .....	6-16
Summary of the interface	
4. Terminal I/O .....	6-30
Line disciplines	
POSIX session management	
Data structures	
Flow of control	
Pseudo terminals	

## Module Objectives

In order to demonstrate an understanding of device drivers and terminal I/O, the student should be able to:

- explain the problem of aliasing in special files and how it is dealt with in OSF/1
- list the steps necessary to dynamically add a module to the operating system
- list what has been done in the OSF/1 kernel to support internationalization
- list the data structures supporting terminals and sessions

# Module 6 — Device Drivers and Terminal I/O

## 6-1. The Big Picture

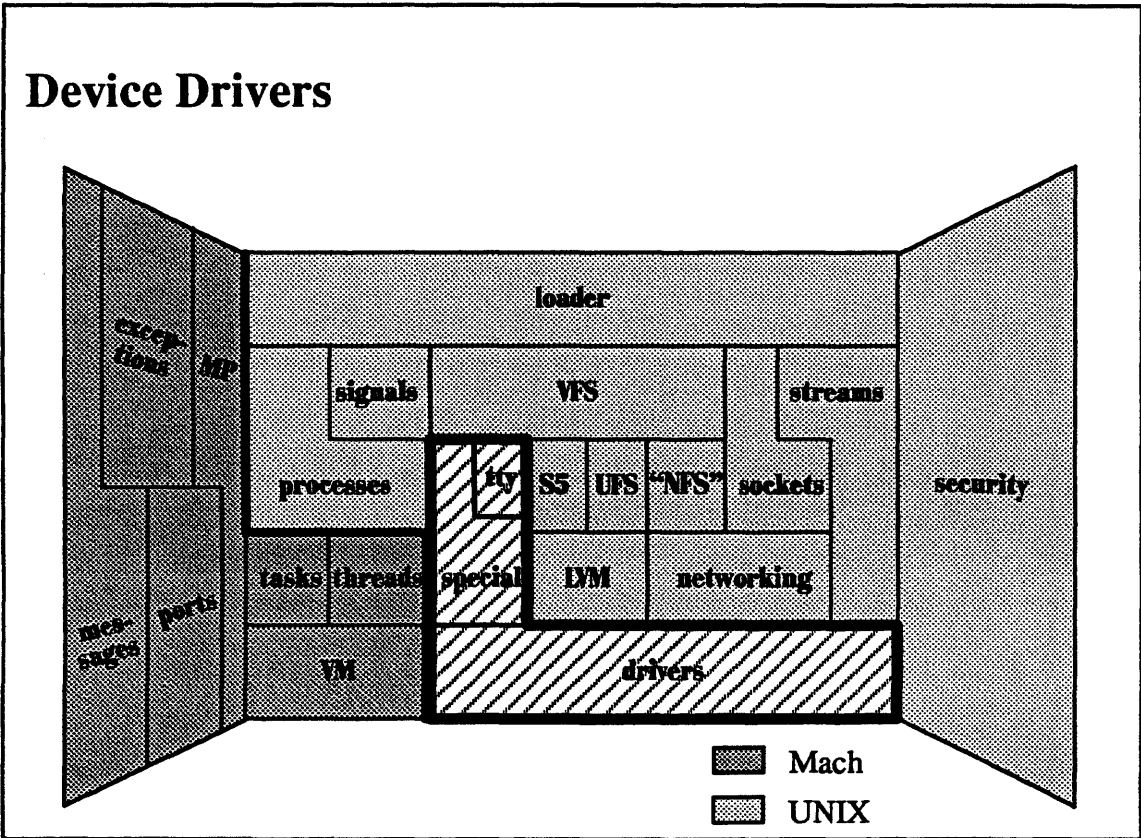

6-1.

© 1990, 1991 Open Software Foundation

DFS  
LFS  
S L VM



## Module 6 — Device Drivers and Terminal I/O

### Student Notes: Device Drivers

OSF/1 does not provide any device drivers itself, since they are necessarily extremely machine-dependent. Device drivers are, however, supplied with the reference ports, and they can be used as a guide for constructing one's own device drivers. OSF has added the dynamic configurability and loading of device drivers. In particular, one of the reference ports is for a symmetric multiprocessor, and its device drivers provide an example of how other device drivers may be parallelized.

This material is discussed in chapters 17 and 18 of Open Software Foundation, 1990a.

*ULTRIX drivers are OSF drivers*

## 6-2. Special Files

### Devices

- Accessed via special files
  - block interface *buffer cache*
  - character interface *no buffer cache*
- Identified by *device number* *int*
  - *major portion* identifies driver *- 8bits*
  - *minor portion* interpreted by driver *8bits*

## Module 6 — Device Drivers and Terminal I/O

---

### Student Notes: Devices

Devices are treated as a special form of a file in that they are named by paths in the directory hierarchy. A device may be accessed via two different interfaces: the *block* interface, meaning that all access is through the buffer cache, and the *character* interface, meaning that the buffer cache is not used.

A device is identified by a device number that has two parts: the major portion, identifying the driver, and a minor portion to be interpreted by the driver but usually identifying the device, among other things.

## 6-3. Special Files

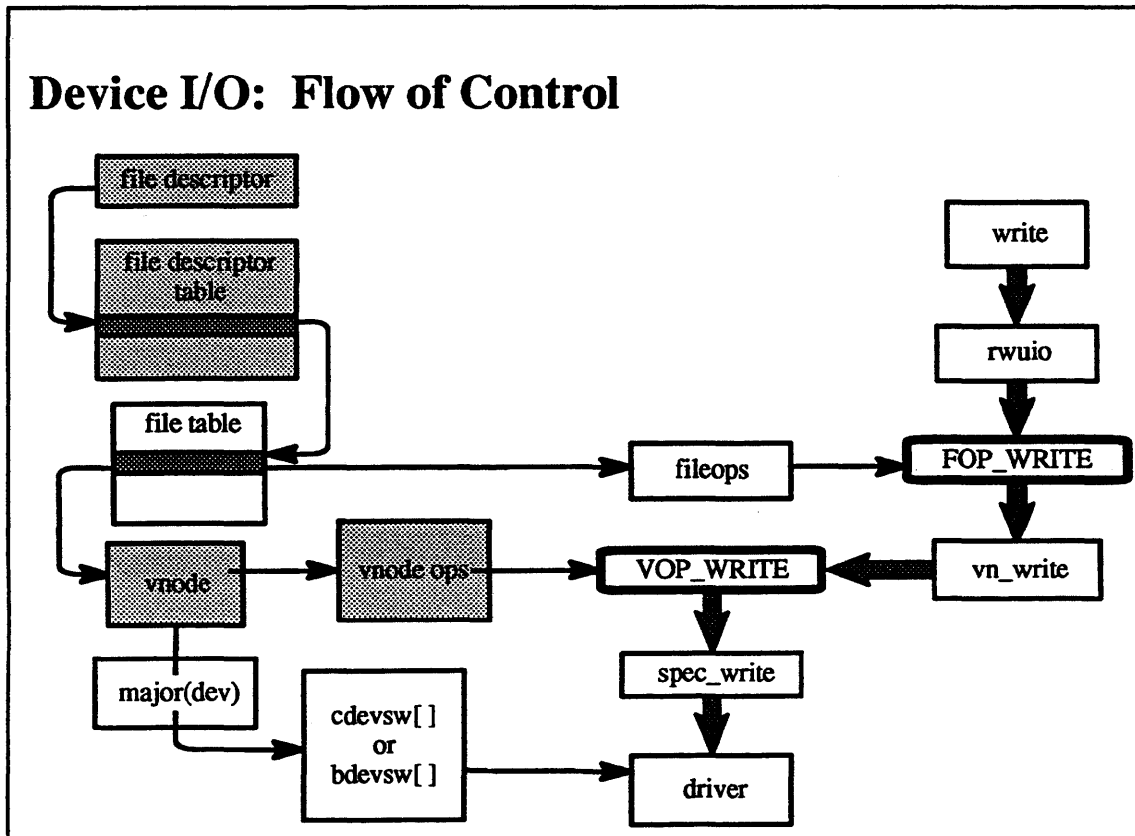

6-3.

© 1990, 1991 Open Software Foundation

## Module 6 — Device Drivers and Terminal I/O

---

### Student Notes: Device I/O: Flow of Control

Special files are represented by inodes in both the S5 and UFS file systems. However, the vnode set up for the inode refers to the vnode operations for special files. Thus, for example, a write system call results in a call to *spec\_write*.

These special file vnode operations must identify the device driver that controls the device. They do so by using the major portion of the device number as an index into the *cdevsw* table for the character interface and the *bdevsw* table for the block interface. (However, for the block interface, the driver is actually called from the block I/O routines.) Each entry in the *cdevsw* and *bdevsw* tables is a structure containing entry points of the associated driver.

6-4. Special Files

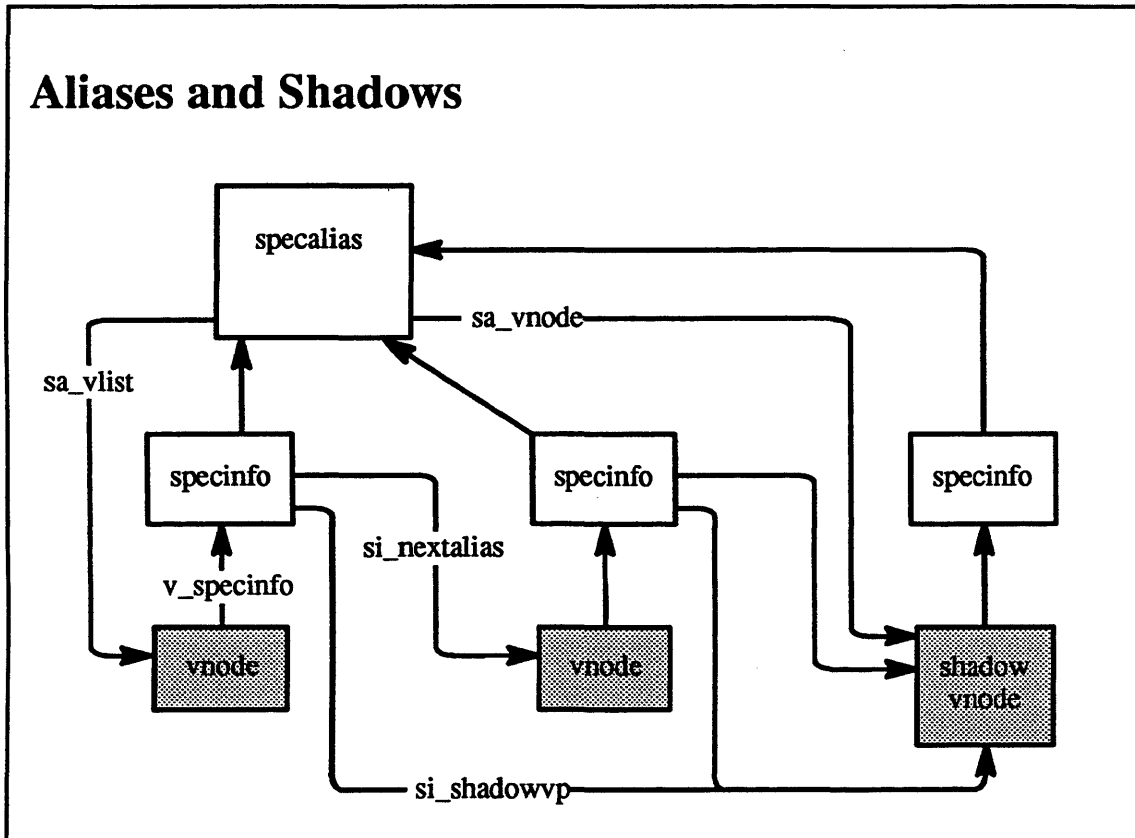

6-4.

© 1990, 1991 Open Software Foundation

## Module 6 — Device Drivers and Terminal I/O

---

### Student Notes: Aliases and Shadows

A difficulty with devices is that one device might have multiple names (*special files*). This arrangement could lead to problems: for example, when a device driver's *close* routine is called, the driver must be assured that this is the last *close* of the device, regardless of the name used to *open* it. For accesses to a device via its block interface, we must ensure that, no matter which name of the device is used, all accesses use the same buffers in the cache.

All vnodes (representing open files) of the same device are linked on a chain headed by a *specalias* structure. The actual links are contained in *specinfo* structures, which are allocated along with the vnodes when the underlying inodes are brought into primary memory.

Another problem occurs when one block device has multiple names. Since blocks in the buffer cache are identified by the pair of vnode address (of the block device) and block number, there would be multiple names for each block of the device, one for each of the device's path names. Thus, depending upon which special file is used to access a particular block, the block would be identified differently in the cache. This problem is avoided through the use of *shadow vnodes*.

If a device is opened via its block interface, then the system allocates a shadow vnode. If the same device is subsequently opened via its block interface but with a different name, then the same shadow vnode is used. This vnode is used to refer to the device in all accesses to the buffer cache, thus ensuring consistency.

A related problem might occur when a mounted file system is accessed via its block special interface. In this situation, a single block might have two identities in the cache; it is a block within an ordinary file and it is a block within the block device. This problem is dealt with by prohibiting access to a mounted file system via its block device interface.

### 6-5. Dynamic Configuration

#### System Configuration

- Boot-time activation of driver (BSD) *70s*
- Dynamic loading and configuring of subsystems (OSF/1)



## Module 6 — Device Drivers and Terminal I/O

---

### Student Notes: System Configuration

In BSD-style autoconfiguration, device drivers are statically linked into the kernel. At boot time, autoconfiguration code determines which devices are present and “activates” the appropriate drivers.

OSF/1 supports *dynamic* configuration of:

- device drivers
- file systems
- streams modules and drivers
- network protocols

Drivers and other modules may be loaded into or unloaded from a running system.

# Module 6 — Device Drivers and Terminal I/O

## 6-6. Dynamic Configuration

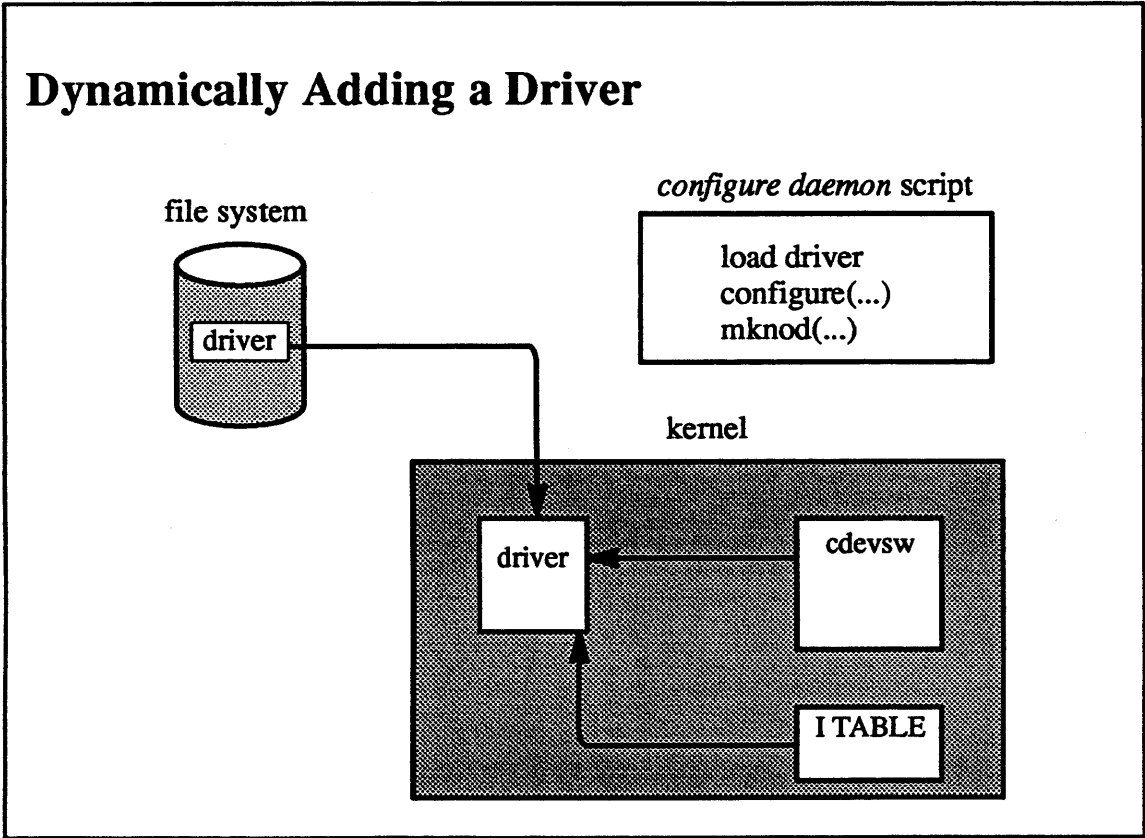

6-6.

© 1990, 1991 Open Software Foundation

## Module 6 — Device Drivers and Terminal I/O

### Student Notes: Dynamically Adding a Driver

A driver is loaded into the operating system with the aid of the run-time loader, as will be discussed in Module 10. The run-time loader links the driver to the rest of the operating system, but the loaded driver is responsible for linking the rest of the operating system to itself.

Each dynamically configurable driver has a *configure* entry point that is called after it has been loaded. The bottom half of the driver, i.e. that portion of the driver that responds to interrupts, must link its interrupt handler into the rest of the kernel. It accomplishes this linkage by calling a pair of routines:

- *handler\_add* registers a new interrupt handler
- *handler\_enable* “turns on” a registered interrupt handler

The top half of the driver, i.e. that part of the driver called in the thread context in response to system calls, must make itself known to the rest of the kernel. It does this by creating entries in one or both of the *cdevsw* and the *bdevsw* by calling:

- *cdevsw\_add*
- *bdevsw\_add*

In both cases, the caller either supplies a major device number or is assigned one.

For further information on dynamic configuration, see chapters 1 through 6 in Open Software Foundation, 1990a.

6-7. Dynamic Configuration

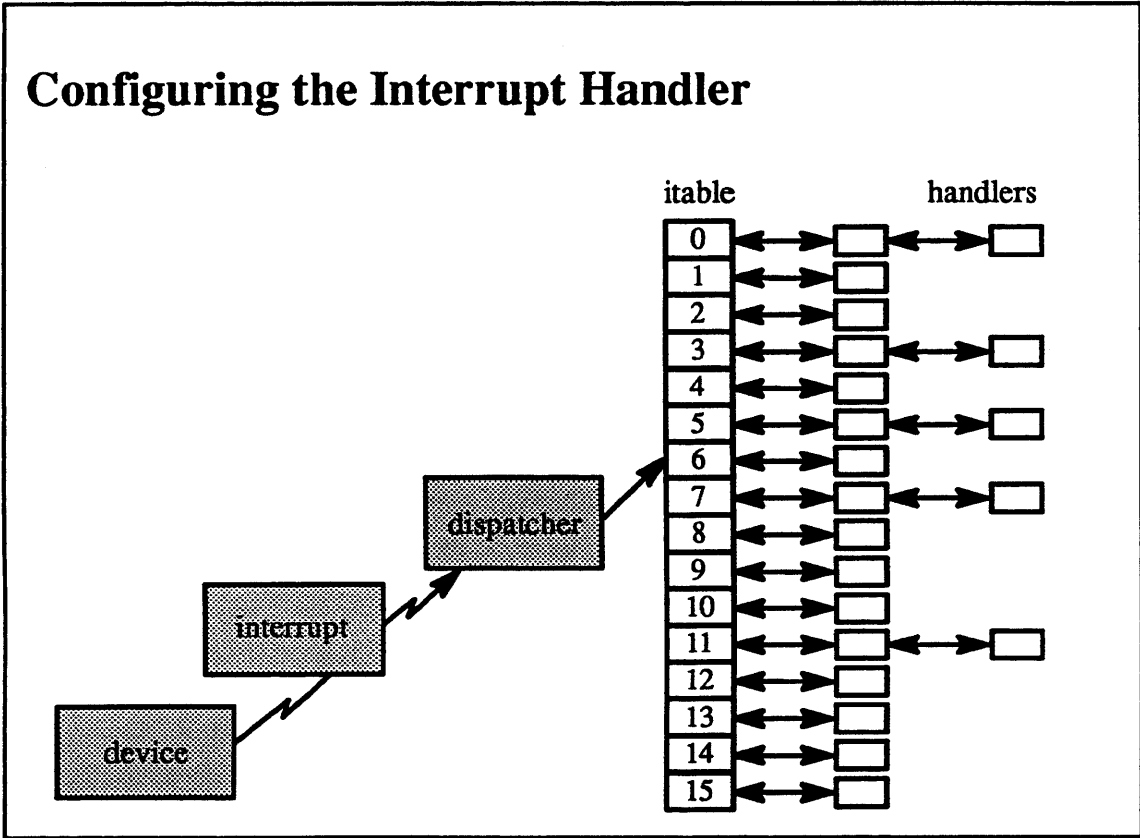

6-7. simple MIPs

## Module 6 — Device Drivers and Terminal I/O

---

### Student Notes: Configuring the Interrupt Handler

In the BSD kernel, the notion of interrupt vectoring is “wired into” the kernel; i.e., there is no convenient technique for adding interrupt handlers dynamically. OSF/1 provides an approach for adding and removing interrupt handlers dynamically, though the method involves some very machine-dependent facilities and must be tailored for each architecture.

When an interrupt occurs, an *interrupt dispatcher* is invoked in some machine-dependent fashion. The dispatcher, using machine-dependent techniques, consults the *itable* for the appropriate handler and forwards the interrupt to it (i.e. calls it).

A typical *itable* might be an array indexed by the interrupt level, as shown in the picture. Each element of the array would head a linked list of handlers for interrupts at that level. Choosing the correct handler would depend upon machine-dependent information, such as a vector address.

### 6-8. Device Drivers

#### Major Driver Entry Points

<i>configure</i>	called after a driver has been dynamically loaded to link itself into the rest of the kernel
<i>probe</i>	called at boot time to determine if the device is present; used with BSD-style autoconfiguration
<i>attach</i>	called at boot time after it is known that the device exists to perform device initialization; used with BSD-style autoconfiguration
<i>open</i>	called on every open of a special file (device)
<i>close</i>	called on the <u>last close</u> of a special file
<i>read, write</i>	called to initiate transfers for character special files
<i>strategy</i>	called to initiate transfers represented by <i>buf</i> structures
<i>ioctl</i>	called to handle miscellaneous requests to the driver
<i>intr</i>	called in response to interrupts

## Module 6 — Device Drivers and Terminal I/O

---

### Student Notes: Major Driver Entry Points

The *probe* and *attach* routines are called only at boot time and only with BSD-style autoconfiguration. If they are used, then *configure* is not needed, and vice versa.

## 6-9. Device Drivers

### Driver Entry Points: Open

*open*(dev, flag, type)



## Module 6 — Device Drivers and Terminal I/O

---

### Student Notes: Driver Entry Points: Open

- *dev*: device number (major and minor)
- *flag*: *flags* parameter from the open system call
  - O\_RDONLY, O\_RDWR, O\_NDELAY, etc.
- *type*: indicates whether the character or block interface is being used (this argument is new and rarely used)

#### Possible actions:

- initialize per-device state information
- “turn on” device
- wait for device to be ready (e.g. wait for carrier-detect)
- check device status (e.g. opening for write, but no write ring on a tape drive)
- etc.

Requirements: return 0 if everything is ok, error code otherwise (e.g. ENXIO if device does not exist, EBUSY if device must be used exclusively but is busy)

**6-10. Device Drivers**

**Driver Entry Points: Close**

*close(dev, flag, type)*

## Module 6 — Device Drivers and Terminal I/O

---

### Student Notes: Driver Entry Points: Close

- *dev*: device number (major and minor)
- *flag*: *flags* parameter from the *open* system call
- *type*: indicates whether the character or block interface is being used (this argument is new and rarely used)

#### Possible actions:

- turn device “off”
- hang up phone line
- etc.

Requirements: none

### 6-11. Device Drivers

#### Driver Entry Points: Read/Write

*read(dev, uio), write(dev, uio)*

## Module 6 — Device Drivers and Terminal I/O

---

### Student Notes: Driver Entry Points: Read/Write

- *dev*: device number (major and minor)
- *uio*: pointer to the *uio structure* describing the request

#### Actions:

- does I/O directly in simplest drivers
- for terminal I/O drivers: calls *line discipline* transfer routine
- for drivers which transfer directly into or out of the buffer provided by the user: calls *physio* (which fetches and wires the user's buffer into primary memory), which then calls *strategy*

#### Requirements:

- if this routine is doing the transfer, it should set *uio->uio\_resid* to the number of bytes not transferred
- returns 0 if no errors, or returns an error code (e.g. EIO for an I/O error, EFAULT if an invalid address was given for a buffer)

**6-12. Device Drivers**

**Driver Entry Points: Strategy**

*strategy(bp)*

## Module 6 — Device Drivers and Terminal I/O

---

### Student Notes: Driver Entry Points: Strategy

- *bp*: pointer to the *buf* structure describing the request
  - either initiates the I/O request or queues it for eventual action

## 6-13. Device Drivers

### Driver Entry Points: Ioctl

*ioctl*(dev, cmd, data, flag)



## Module 6 — Device Drivers and Terminal I/O

---

### Student Notes: Driver Entry Points: Ioctl

- *dev*: device number (major and minor)
- *cmd*: command code (second argument of the `ioctl` system call)
  - encoded in this command code is a description of the *data* that needs to be transferred from user to system or from system to user; this allows the higher-level code to perform this transfer for all drivers
- *data*: pointer to the argument (either *in* or *out*) of the `ioctl`; these are interpreted differently by each driver
- *flag*: *flags* parameter from the `open` call

#### Possible actions:

- turn terminal modes
- rewind a tape drive
- etc.

Requirements: return an appropriate error code (usually `ENOTTY` if the command makes no sense)

**6-14. Device Drivers**

**Driver Entry Points: Interrupt**

*intr(dev)*

## Module 6 — Device Drivers and Terminal I/O

---

### Student Notes: Driver Entry Points: Interrupt

- *dev*: the *hardware device number* of the interrupting device, not its major and minor device numbers

#### Possible actions:

- check for and react to errors
- *wake up* threads waiting for the I/O completion
- acknowledge the interrupt in the controller registers

#### Requirements:

- be quick!
- don't sleep; execution is in the interrupt context and not in the context of any thread

### 6-15. Terminal I/O

#### Terminals

- Internationalization
  - Session control
  - *Line discipline technology*
- } Relevant for 1.1*
- ↳, not 1.1*

## **Module 6 — Device Drivers and Terminal I/O**

---

**Student Notes: Terminals**

### 6-16. Terminal I/O

#### Internationalization

- 8-bit clean
- Shift-JIS support for Asian character sets

## Module 6 — Device Drivers and Terminal I/O

---

### Student Notes: Internationalization

Earlier versions of UNIX were designed strictly for use with the ASCII character set. This is a seven-bit character set and, programmers being programmers, the extra eighth bit was used for a variety of purposes. The seven-bit/eight-bit problem has been cleaned up in OSF/1, and the entire kernel and all of the libraries are eight-bit clean: no special use is made of the eighth bit in characters, and thus eight-bit character sets can be supported.

A much more difficult problem is dealing with character sets in which characters are larger than bytes. OSF/1 includes support for Shift-JIS, but this is not considered the final word on the subject and more will be available in Release 1.1.

6-17. Terminal I/O

Sessions

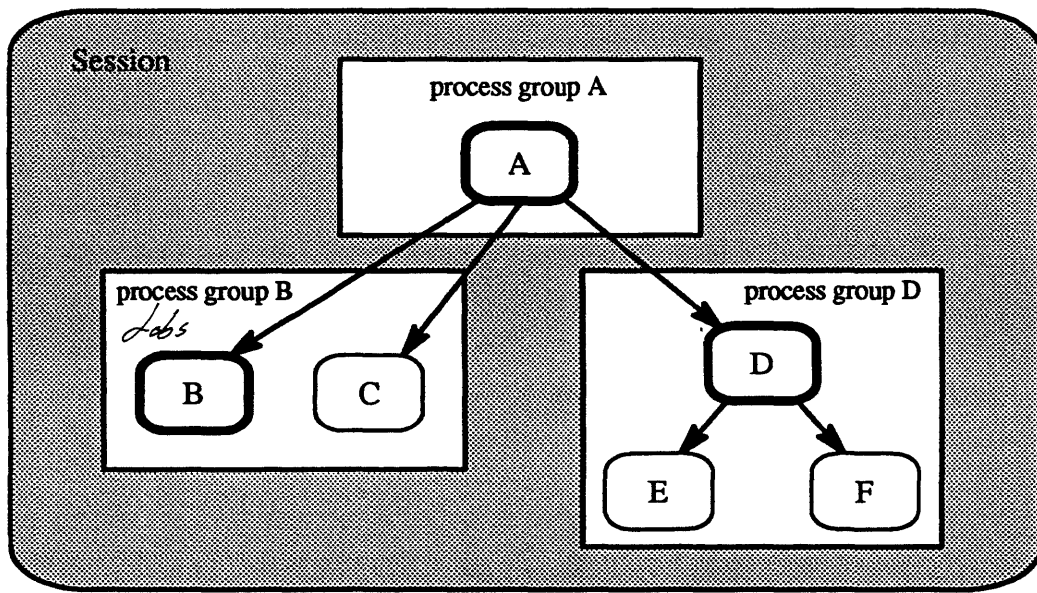

6-17.

© 1990, 1991 Open Software Foundation



## Module 6 — Device Drivers and Terminal I/O

### Student Notes: Sessions

POSIX introduced the concept of sessions to clean up the BSD notion of job control. A session is a terminal session, and hence a collection of processes sharing a terminal. Traditionally there has been the notion of foreground processes and background processes: foreground processes are affected by signals generated by key strokes, background processes are not. Job control is a means for moving processes back and forth between the foreground and the background.

The picture shows three process groups whose names are the process id of their first and founding members.

- Process A formed the session and spawned processes B, C, and D
  - process A is in its own process group
  - process B formed a new process group with itself as leader (giving its name to the group) and C as another member
  - process D formed another new process group and spawned two children that stayed in the group
- Each process group forms a “job” that can be suspended or placed in the foreground or background
- A *stop signal* suspends a process group
  - sent by a thread in another process (usually an ancestor)
  - sent by the kernel due to actions on the terminal (e.g., a background process reading from a terminal)
  - all threads within each process of the process group are suspended (using *task\_suspend*)
- A *continue signal* (usually from an ancestor) resumes a stopped process
  - if an orphaned process receives a *stop* signal because of actions on the terminal (if, say, it is a background process and is reading from the terminal, and thus receives the SIGTTIN signal), it is unlikely that any thread will send it a *continue* signal; such a *stop* signal should be ignored (the I/O system call will return the error EIO). Note that this differs from BSD’s solution—in BSD the process would have been sent the SIGKILL signal (and hence would have been terminated)
  - the generalization of the orphaned process is the orphaned process group: a process group whose members have no parents within the session

6-18. Terminal I/O

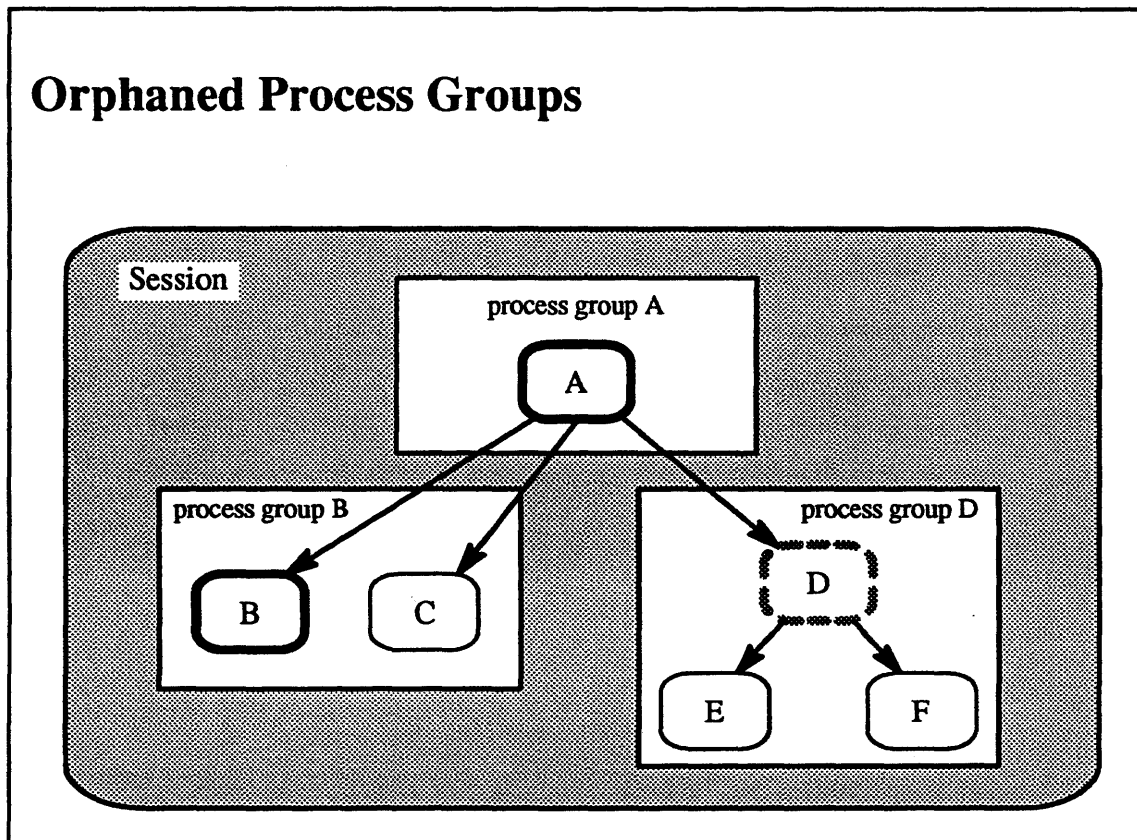

6-18.

© 1990, 1991 Open Software Foundation

## Module 6 — Device Drivers and Terminal I/O

---

### Student Notes: Orphaned Process Groups

- If process D terminates, then the *init* process adopts processes E and F
  - process group D is thus an orphan, since it has no processes with a parent in the session
  - processes E and F receive the EIO error if they attempt to read from their terminal

A process group is considered an orphan if none of its members have an ancestor that is the session leader. Thus in the picture, if process C is moved to process group D, then process group D is no longer an orphan.

# Module 6 — Device Drivers and Terminal I/O

## 6-19. Terminal I/O

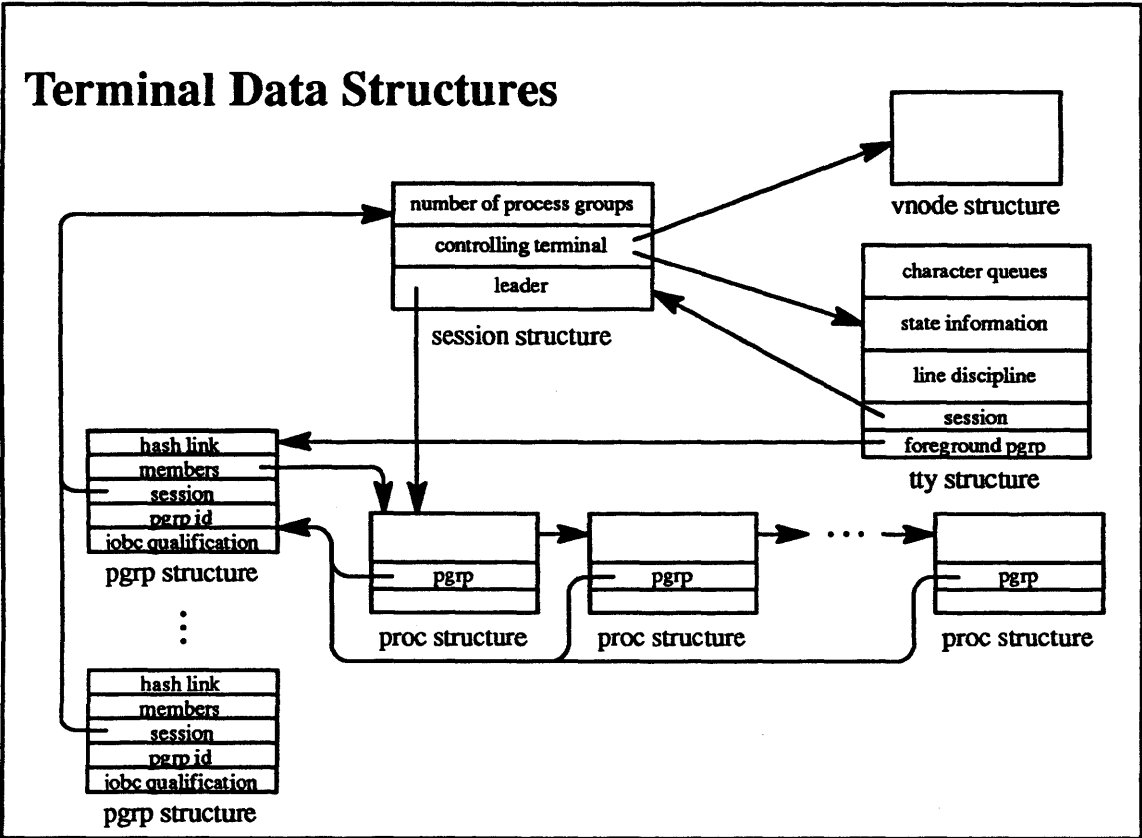

6-19.

© 1990, 1991 Open Software Foundation

## Module 6 — Device Drivers and Terminal I/O

---

### Student Notes: Terminal Data Structures

The *jobc qualification* field of the *pgrp* structure is used to indicate whether or not the process group is an orphan (and hence not qualified to receive job control). The field contains a count of the number of processes in the process group whose parents are both outside of the process group and qualified for job control.

# Module 6 — Device Drivers and Terminal I/O

## 6-20. Terminal I/O

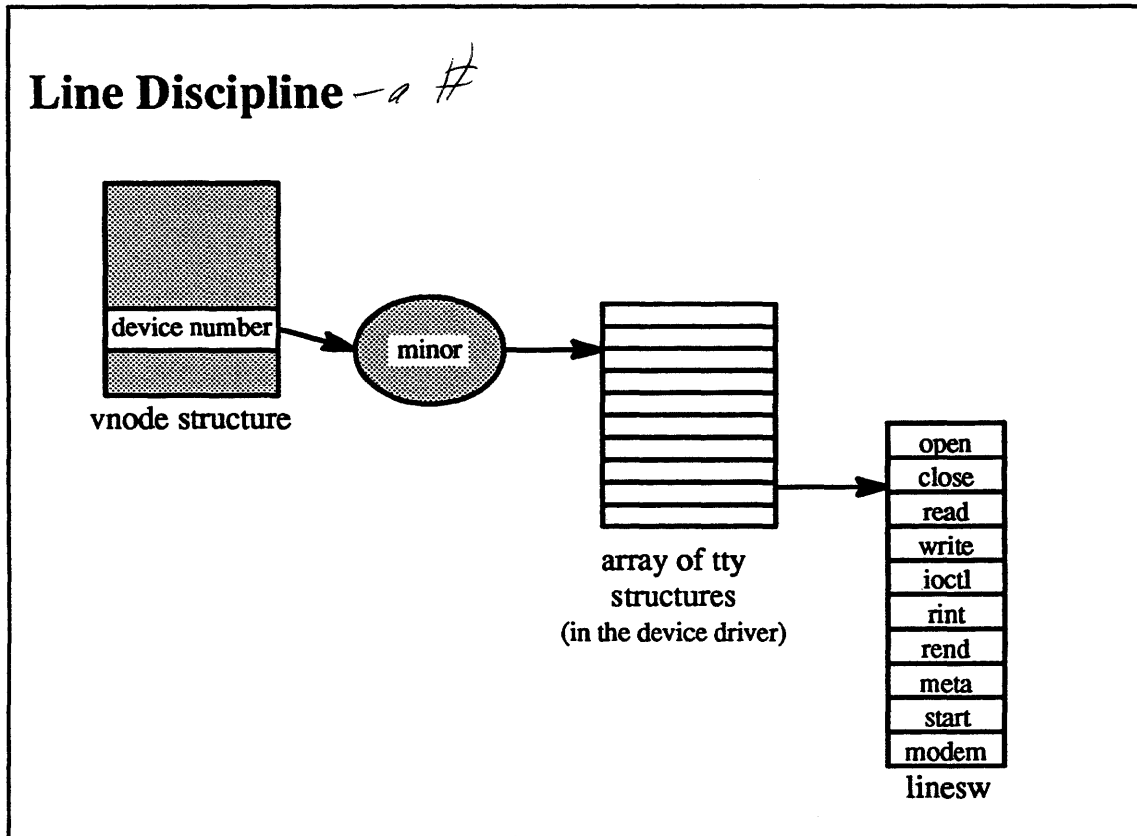

6-20.

© 1990, 1991 Open Software Foundation

## Module 6 — Device Drivers and Terminal I/O

---

### Student Notes: Line Discipline

This slide illustrates how the device number (from the vnode structure) is used to identify the *tty* structure and hence to identify the entry points into the terminal's line discipline. Each terminal device driver maintains a table mapping minor device numbers into pointers to *tty* structures.

# Module 6 — Device Drivers and Terminal I/O

## 6-21. Terminal I/O

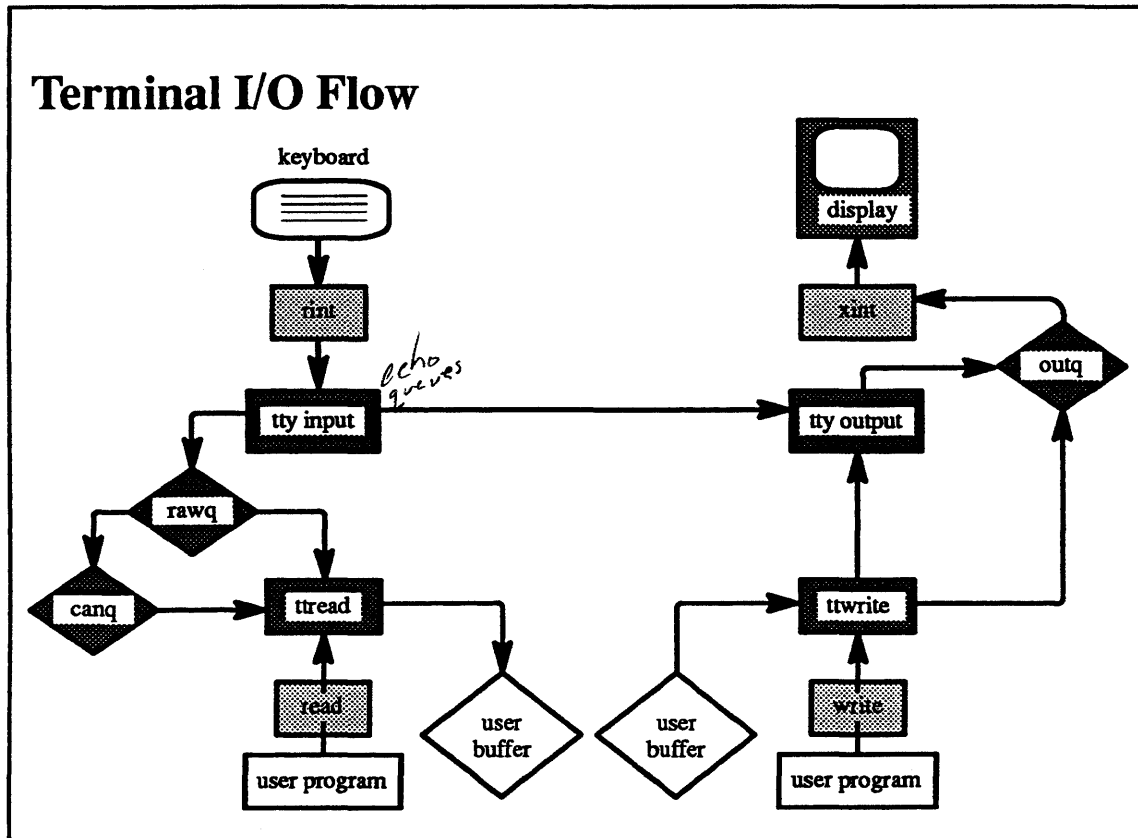

6-21.

© 1990, 1991 Open Software Foundation



## Module 6 — Device Drivers and Terminal I/O

### Student Notes: Terminal I/O Flow

When a character is typed on the keyboard, the driver's read interrupt routine (*rint*) is called (in the interrupt context). It determines which *line discipline* is being used by consulting the *ty* data structure associated with the terminal. In this example we assume that the standard *ty* line discipline is being used. Thus control is passed to the *tyinput* routine. This routine looks at the *ty* structure to determine the terminal's *mode*. If it is in *cooked* mode, then the incoming characters are interpreted as parts of lines of text which may be edited. Characters are first placed on the *raw* queue, where they may be edited in response to edit characters. Once a line delimiter (e.g., carriage return) is received, the line of text is copied to the *can* (canonical) queue. Otherwise, if the terminal is in either *raw* mode or *cbreak* mode, incoming characters cannot be edited, and are left on the *raw* queue. If echoing is enabled, then the *tyinput* routine calls the *tyoutput* routine to echo the characters. Since this processing occurs in the interrupt context, the interrupted context is resumed after *tyinput* returns.

In the context of a thread performing a *read* system call, control enters the device driver's *read* routine which consults the *ty* structure and, in our case, calls the *ty* line discipline's *tread* routine. This routine determines the mode of the terminal. If the terminal is in *cooked* mode, *tread* looks in the *can* queue for characters. Otherwise it looks in the *raw* queue. If there are no characters in the appropriate queue and if blocking is permitted, the calling thread blocks until characters are received. If characters are available then they are copied to the user's buffer.

In the context of a thread performing a *write* system call, control enters the device driver's *write* routine, which, in our case, calls the line discipline's *tywrite* routine. This routine copies characters into the kernel from the user's buffer. Those characters requiring no special processing are appended to the *out* queue. Characters requiring special processing are processed by the *tyoutput* routine (the primary purpose of this routine is to deal with characters not present in the terminal's character set; this routine is rarely needed in modern systems).

The device driver, usually executing in the interrupt context, transfers characters from the *out* queue to the device.

**6-22. Terminal I/O**

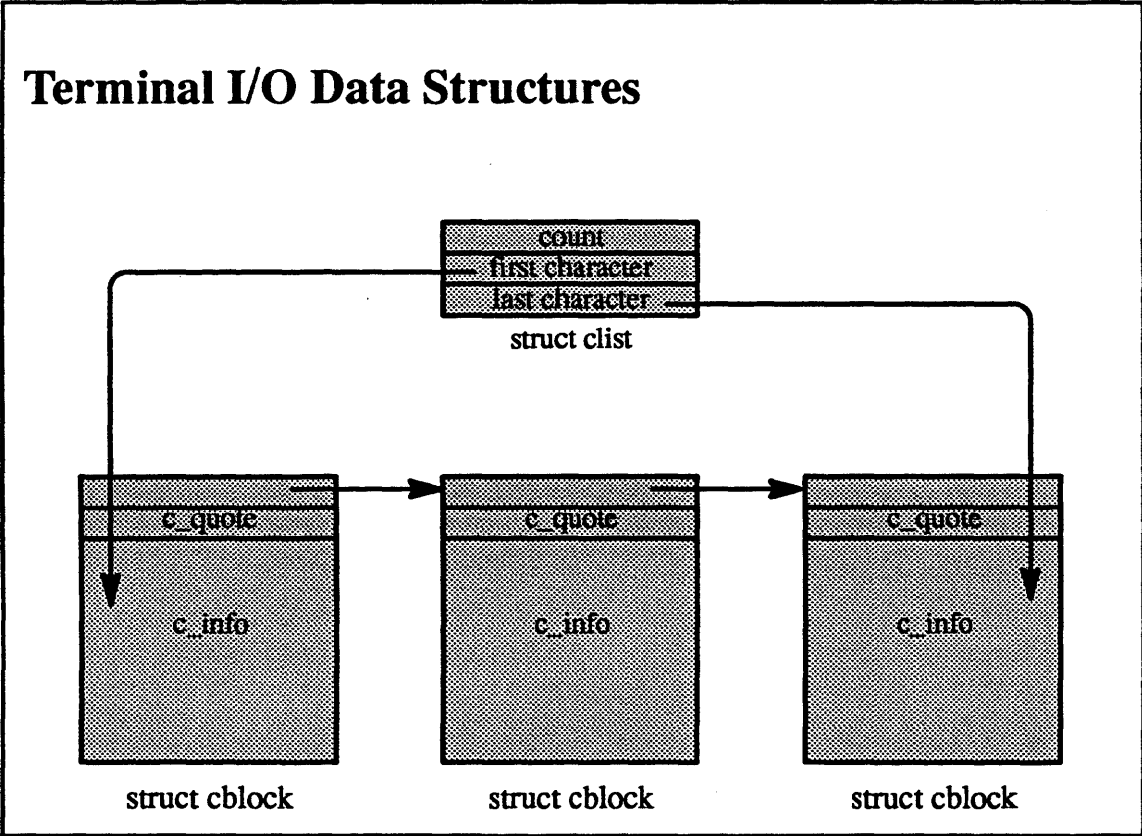

6-22.

© 1990, 1991 Open Software Foundation

## Module 6 — Device Drivers and Terminal I/O

---

### Student Notes: Terminal I/O Data Structures

The *raw* queue, *can* queue, and *out* queue of the previous slide are instances of data structures known generically as *clists*, which represent queues of 8-bit characters. The format of the list, shown in the accompanying picture, consists of a header followed by a number of fixed-size *cblocks*. The *cblocks* are typically 64 bytes in length, with 12 bytes of overhead and 52 bytes of data (*c\_info*).

Of particular interest is the *c\_quote*, which is used to indicate which characters within *c\_info* have been “quoted,” meaning that they are not to be interpreted as providing any sort of special function such as erasing a character or suspending the process group. In earlier versions of UNIX, such quoting was done by setting the eighth bit of a character. However, this technique only works with English character sets.

# Module 6 — Device Drivers and Terminal I/O

## 6-23. Terminal I/O

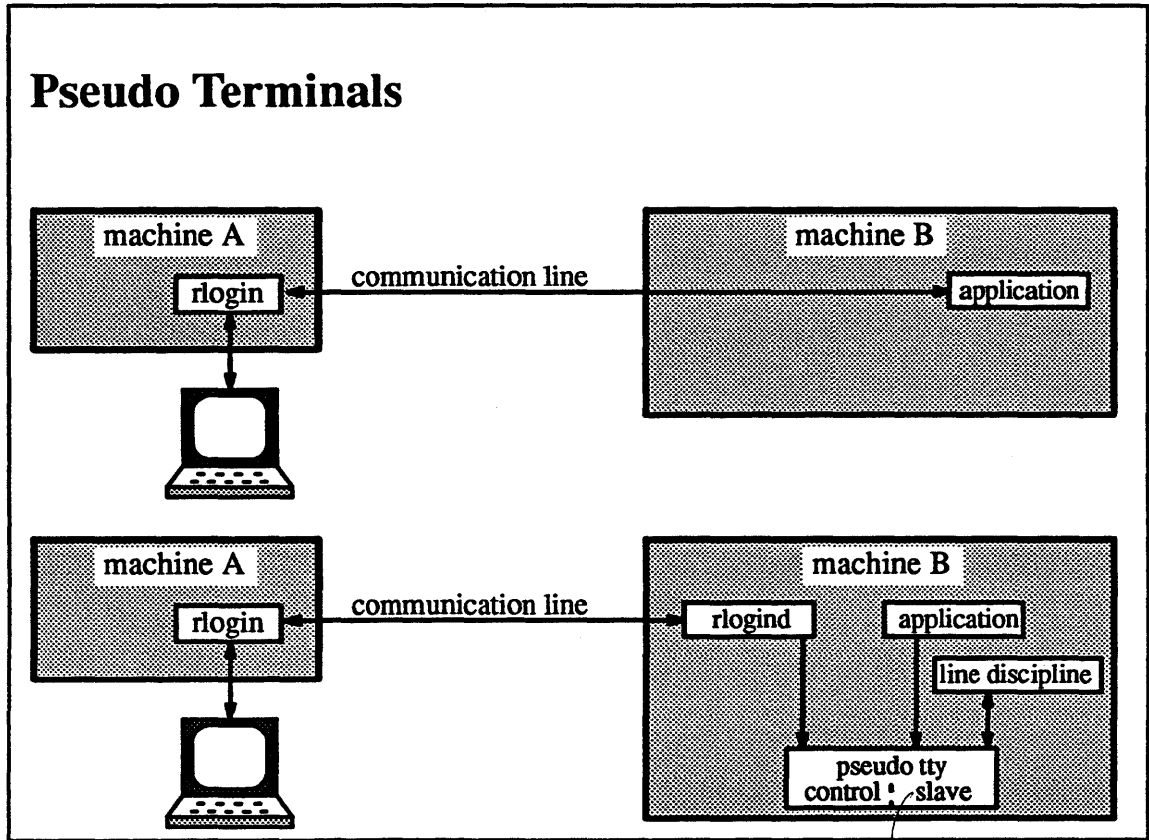

6-23.

© 1990, 1991 Open Software Foundation

*looks like real device*

## Module 6 — Device Drivers and Terminal I/O

---

### Student Notes: Pseudo Terminals

Pseudo terminals are used to present a terminal interface to an application that is not connected to a real terminal. As an example, consider a remote-login-type application. In the top portion of the picture, the real terminal is connected to machine A, and the user is running *rlogin* so as to run an application on machine B. This application might be an editor, which might attempt to make changes to the terminal's mode, e.g., switch from *cooked* mode to *cbreak* mode. However, such attempts would fail because it is actually connected to a communication line that is different from a terminal and does not respond to requests to change modes.

One can think of two approaches to this problem. The first would be to forward the terminal-oriented system calls to the machine to which the terminal is connected. The other would be to run the line-discipline code on the application's machine (machine B in this example). Berkeley UNIX, and hence OSF/1, use the latter approach.

A *pseudo device driver* or a *pseudo terminal* is set up in machine B's kernel. It appears to the rest of the operating system to be a pair of ordinary device drivers, but the pair of drivers communicate with each other instead of with devices. A user process, in this case the *rlogind*, communicates with *rlogin* via the communication line. Incoming bytes are written to one of the pseudo devices—the control device. Output through this device is made to reappear as input from the slave device, i.e. as if a character had just been received from a terminal. This character is then processed by the line discipline code discussed on page 6-43: characters are queued on either the *raw* queue or the *can* queue. When the application issues a *read* system call, it receives these characters after they have been processed by the line discipline. Output from the application is processed by the line discipline as if the characters were being sent to a real terminal, but instead they are made to appear as incoming characters in the control pseudo device. These characters are read by the *rlogind*, which sends them across the communication line to *rlogin*.

## Module 6 — Device Drivers and Terminal I/O

---

### Exercises:

1.
  - a. Is there any difference between a special file whose inode is in an S5 file system and one whose inode is in a UFS file system?
  - b. Why are the *specialias* and *specinfo* structures necessary?
2.
  - a. List the steps necessary to add a module to the operating system dynamically.
  - b. Why is it necessary that dynamically loadable modules have *configure* routines (for example, why couldn't the work performed by the *configure* routine be performed by user-level code?)?
3. What are the differences between BSD device drivers and OSF/1 device drivers?
4.
  - a. What is an "orphaned" process group?
  - b. How is it determined what a terminal's line discipline is?
  - c. Explain the relationship between pseudo terminals and device drivers.

# Module 7 — Streams

---

## Module Contents

1. Streams Concepts .....	7-4
Streams components	
Pipelines	
Multiplexers	
2. Message Flow .....	7-24
Messages	
Standard entry points	
Flow of control	
3. Implementation of Streams .....	7-38
Standard data structures	
OSF/1-specific data structures	
Representing an open stream	
Cloning	
4. Parallelization .....	7-50
Synchronization options	
Data structures	
Flow of control	

## Module Objectives

In order to demonstrate an understanding of the concept of streams and their implementation in OSF/1, the student should be able to:

- list the three types of streams components
- list and show the interconnections between the data structures used to represent a streams message
- explain why it is necessary for streams-oriented service calls to be serialized
- list the data structures used to represent and access an open stream
- explain the purpose of cloning
- list the synchronization options available in the OSF/1 implementation of streams

# Module 7 — Streams

## 7-1. The Big Picture

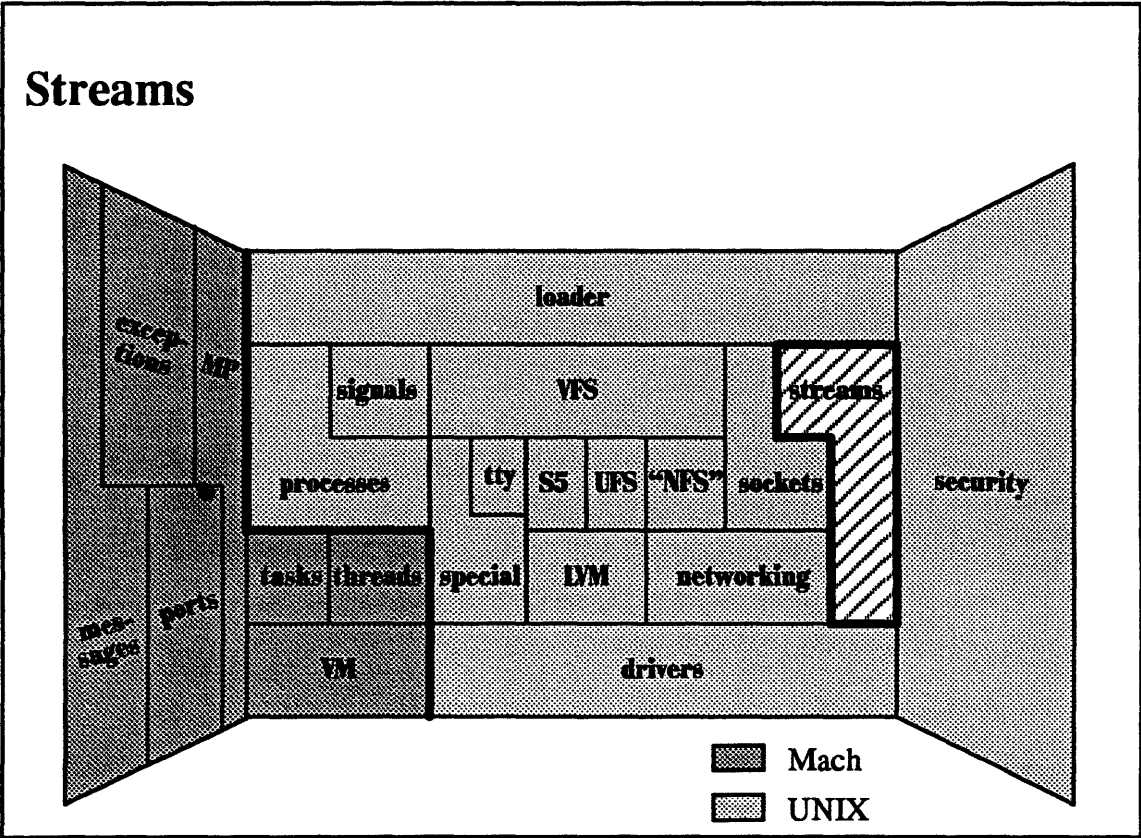

7-1.

© 1990, 1991 Open Software Foundation



## Module 7 — Streams

---

### Student Notes: Streams

The best general introduction to streams is AT&T, 1989. The OSF/1 implementation of streams is discussed in chapter 13 of Open Software Foundation, 1990a.

## Module 7 — Streams

### 7-2. Streams Concepts

#### Streams

- Kernel analog of the shell concept of a *pipeline*
- OSF/1 streams are a reimplementation of SVR3 streams, with the important addition of parallelization

## Module 7 — Streams

---

### Student Notes: Streams

A *shell pipeline* is a unidirectional stream of bytes processed by one or more filters. A *kernel stream* is a bidirectional stream of messages being processed in one or more modules. The endpoints of a kernel stream can be in two user processes, or, most commonly, one endpoint may be in a user process and the other in a device driver.

In shell pipelines, each filter is implemented as a separate process. This technique could be extended to kernel streams through the use of kernel threads. However, the original designer of streams, Dennis Ritchie, felt that so many streams modules would be active at once that, even with very lightweight kernel threads, a thread per module would be too expensive. Thus each module is a collection of procedures that can be called in a variety of contexts. Associated with each module are data structures to contain its state, so that the module's execution can be started in the context of one caller and continued in the context of another.

# Module 7 — Streams

## 7-3. Streams Concepts

### Stream Components, part 1

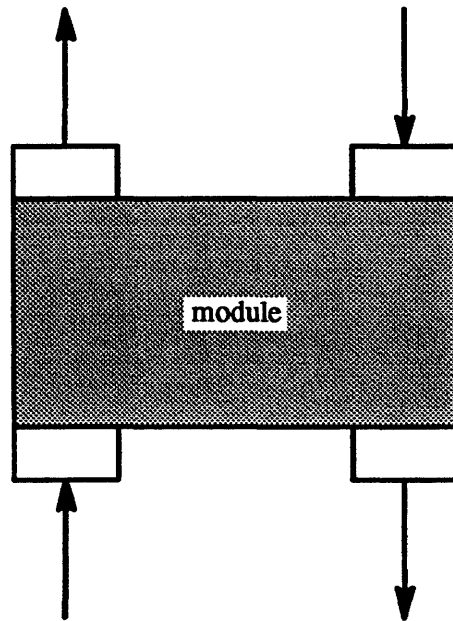

7-3.

© 1990, 1991 Open Software Foundation

## Module 7 — Streams

---

### Student Notes: Stream Components, part 1

Each *module* consists of a set of routines to process data and (possibly) a pair of queues, one for each direction.

A simple example of a module is one that capitalizes all characters going in either direction. A more complicated module might be one that encrypts data going downstream and decrypts data going upstream.

## 7-4. Streams Concepts

### Stream Components, part 2

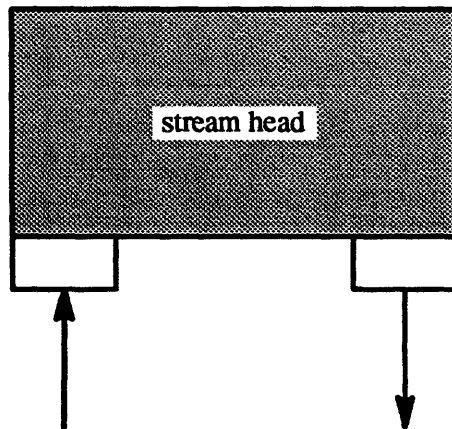

7-4.

© 1990, 1991 Open Software Foundation

## Module 7 — Streams

---

### Student Notes: Stream Components, part 2

Stream head is a special case of a stream module: it supplies the interface to the system-call layer, converts system calls into messages sent down a stream, and converts messages arriving from the stream into responses to system calls.

# Module 7 — Streams

## 7-5. Streams Concepts

### Stream Components, part 3

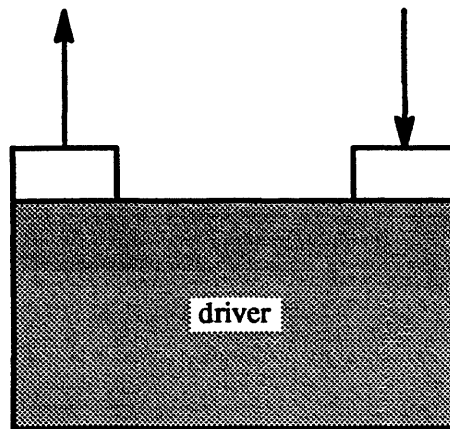

7-5.

© 1990, 1991 Open Software Foundation



## Module 7 — Streams

---

### Student Notes: Stream Components, part 3

A streams driver can be an interface to a real device or can be an interface to other streams, as will be seen.

# Module 7 — Streams

## 7-6. Streams Concepts

### Stream Setup

```
fd = open("/dev/stream_device", O_RDWR);
```

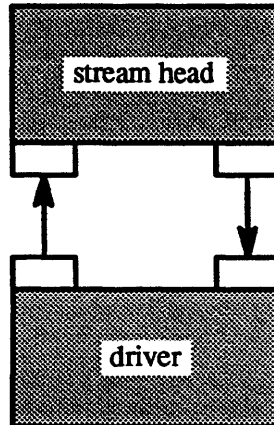

7-6.

© 1990, 1991 Open Software Foundation

## Module 7 — Streams

---

### Student Notes: Stream Setup

A stream may be created by opening a streams device.

Streams devices appear as character special devices, i.e., they are identified as special files and have entries in the *cdevsw*.

A streams device may be read from and written to immediately after being opened, but, at this point, it doesn't supply much additional functionality over non-streams devices.

# Module 7 — Streams

## 7-7. Streams Concepts

### Stream Push

```
ioctl(fd, I_PUSH, "module name");
```

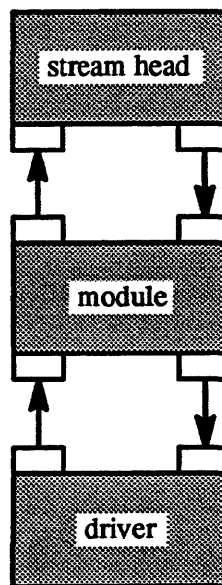

7-7.

© 1990, 1991 Open Software Foundation

## Module 7 — Streams

---

### Student Notes: Stream Push

A module may be inserted at the top (*pushed*) by executing an `ioctl` with the `I_PUSH` command. Data being sent in either direction through the stream will now be processed by the module.

## 7-8. Streams Concepts

### Linking Streams, part 1

```
fdtop = open("/dev/top", O_RDWR);  
fdbottom = open("/dev/bottom", O_RDWR);
```

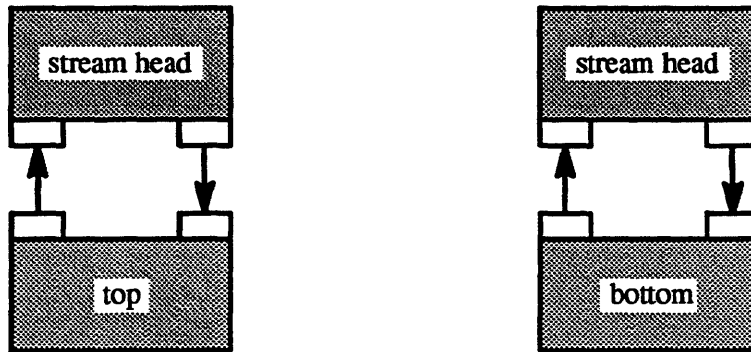

## Module 7 — Streams

---

### Student Notes: Linking Streams, part 1

In this picture the streams driver module *top* is a multiplexer, i.e., it is an interface between a stream and other streams, not an interface between a stream and a device.

## 7-9. Streams Concepts

### Linking Streams, part 2

```
ioctl(fdtop, I_LINK, fdbottom);
```

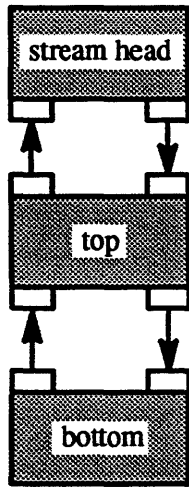



## Module 7 — Streams

---

### Student Notes: Linking Streams, part 2

The *bottom* pipeline of the previous picture has been linked beneath the streams driver *top*. The streams driver *top* now has an upper and a lower part. Part of *top*'s function will be to transfer data from the upper part to the lower part and vice versa.

**7-10. Streams Concepts**

**Multiplexing Streams, part 1**

```
fdbottom2 = open("/dev/bottom2", O_RDWR);  
ioctl(fdtop, I_LINK, fdbottom2);
```

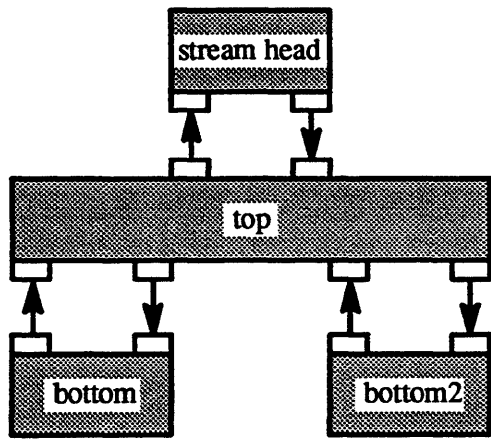

7-10.

© 1990, 1991 Open Software Foundation

## Module 7 — Streams

---

### Student Notes: Multiplexing Streams, part 1

In this picture the driver for *top* is responsible for the multiplexing/demultiplexing of messages coming up from below or going down from above. For messages going downwards, code supplied in the *top* module must decide through which lower stream the data should be sent. It uses its own criteria for doing so, but is likely to base its decision on the contents of the message itself.

Here *top* is a *one-to-many* multiplexer.

# Module 7 — Streams

## 7-11. Streams Concepts

### Multiplexing Streams, part 2

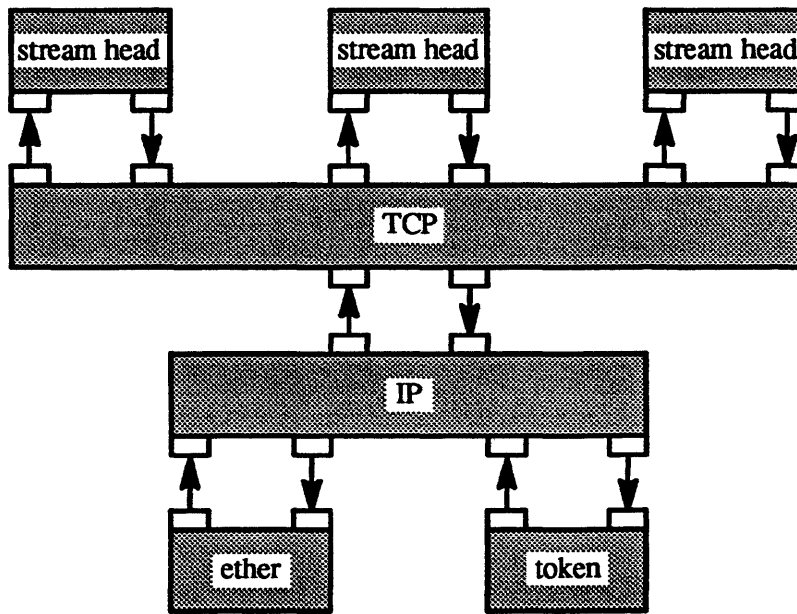

7-11.

© 1990, 1991 Open Software Foundation

## Module 7 — Streams

---

### Student Notes: Multiplexing Streams, part 2

In this example we show a more complicated arrangement of multiplexers. TCP is a *many-to-one* multiplexer. IP in the picture is a *one-to-many* multiplexer, though in practice it is a *many-to-many* multiplexer.

To create this arrangement, first the IP, ether, and token streams are opened, and then the latter two streams are linked to IP. Then the TCP stream is opened and the IP stream linked beneath it. Each stream connected to the top of the TCP module represents a separate TCP connection.

(N.B.: in OSF/1, the TCP/IP protocols are implemented not in the streams framework, but in the socket framework. TCP/IP is used here merely as an example.)

# Module 7 — Streams

## 7-12. Message Flow

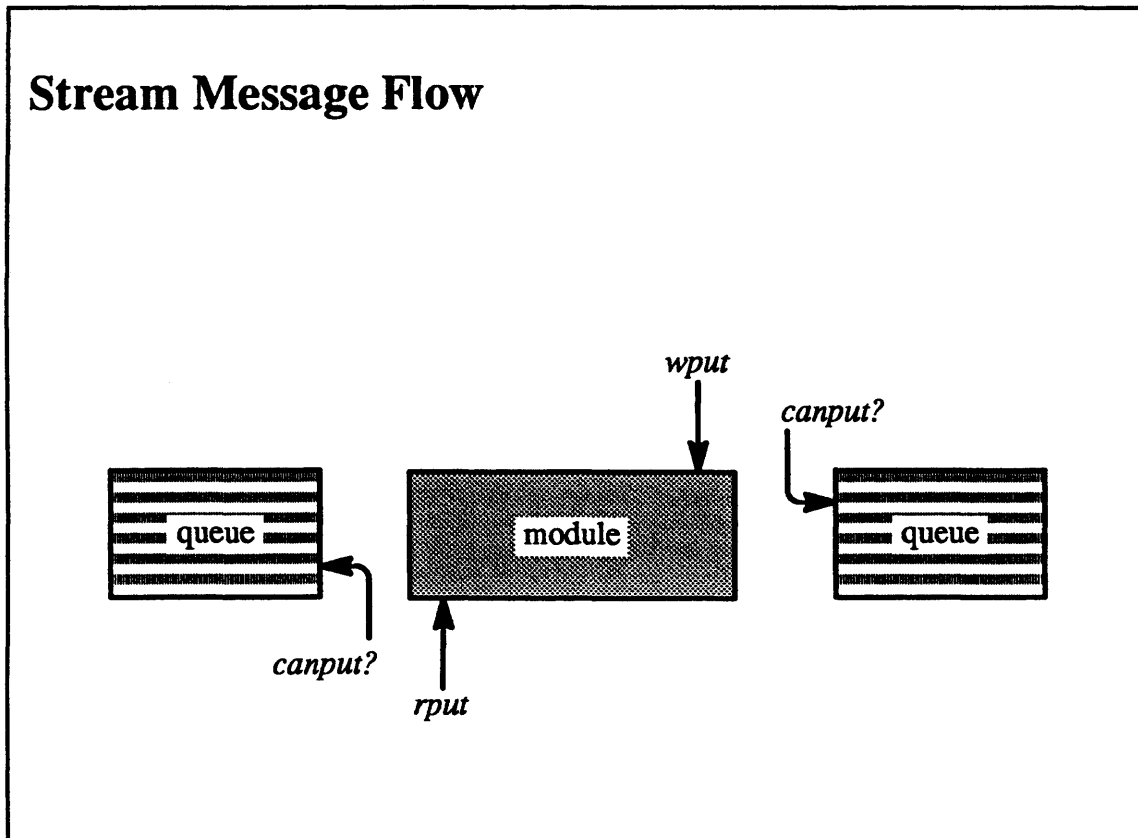

7-12.

© 1990, 1991 Open Software Foundation

## Module 7 — Streams

---

### Student Notes: Stream Message Flow

Each module defines (usually) a *wput* routine and an *rput* routine to be called when a message arrives from above (*wput*) or below (*rput*). From within a module, the appropriate *put* procedure of the next module is called by calling the routine *putnext*.

Simple modules modify incoming messages in-place and pass them on to the next module (by calling *putnext*). Other modules may need additional resources to process a message, or may need to defer processing. These modules have the ability to queue messages. Associated with these queues (one for each direction) is a size limit known as the *high-water mark*.

Because of the finite capacities of these queues, *flow control* must be established. A module that is itself capable of queueing must check for queue space ahead of it (by calling *canput*) before sending the message. The *canput* routine looks ahead for the first module that is capable of queueing and returns *true* if and only if there is room for another message in that queue. If there is no room, then the calling module must put the message in its own queue (the previous module's *canput* routine checked that there was room on the queue before it sent the message). A module may also defer the processing of a message by placing the message at the end of its queue (in either case, enqueueing is accomplished by calling *putq*).

Note that if flow control propagates upwards to the stream head, threads issuing *write* system calls will eventually block waiting for space. However, if flow control propagates downwards to a streams driver serving as an interface to a real device, then incoming data will be lost since there is no more buffer space and no notion of blocking the source of the data.

# Module 7 — Streams

## 7-13. Message Flow

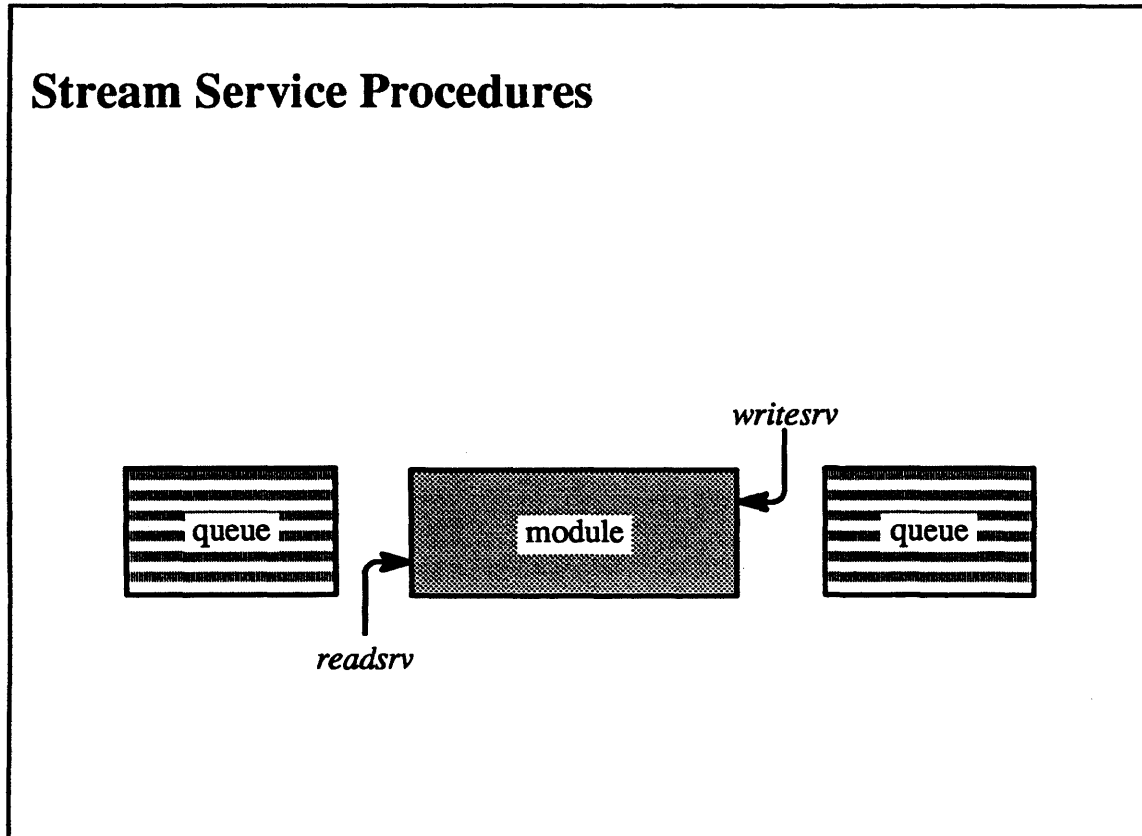

7-13.

© 1990, 1991 Open Software Foundation



## Module 7 — Streams

---

### Student Notes: Stream Service Procedures

A module that may defer the processing of a message must have a *service procedure* that can be called when further processing is possible. Processing may be deferred because of:

- flow control
- yielding to more important processing
- shortage of buffer space

To cause a service procedure to be called sometime in the future, it is *enabled*, which puts it on a list of enabled service procedures. Enabled service procedures are called by members of a special streams thread pool.

A service procedure is automatically enabled whenever *putq* is called (and the queue was previously empty) and whenever a *getq* is called that removes sufficient messages from a forward queue that the queue size falls below the queue's *low-water mark*.

## 7-14. Message Flow

### Messages in Streams

A message as viewed by the designer of a protocol:

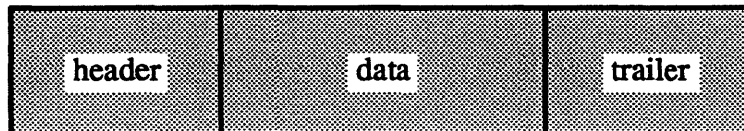

## Module 7 — Streams

---

### Student Notes: Messages in Streams

The simplest stream module merely passes its input to the next module in the stream. This transfer is very efficient, since the data is represented by a linked list of message blocks and is passed by reference. A message consists of a linked list of message blocks, each of which points to a data block, each of which points into a variable-length buffer. The justification for the data blocks is that they allow multiple message blocks to refer to the same data block and avoid the overhead of copying (the data block contains a reference count). Representing a message as a sequence of message blocks makes it easy, for example, to add headers or trailers to messages (and to strip them off).

The message shown in the picture would be implemented as a linked list of three submessages, one for the header, one for the data, and one for the trailer. Stripping off the header and trailer or appending additional information is then very easy.

## 7-15. Message Flow

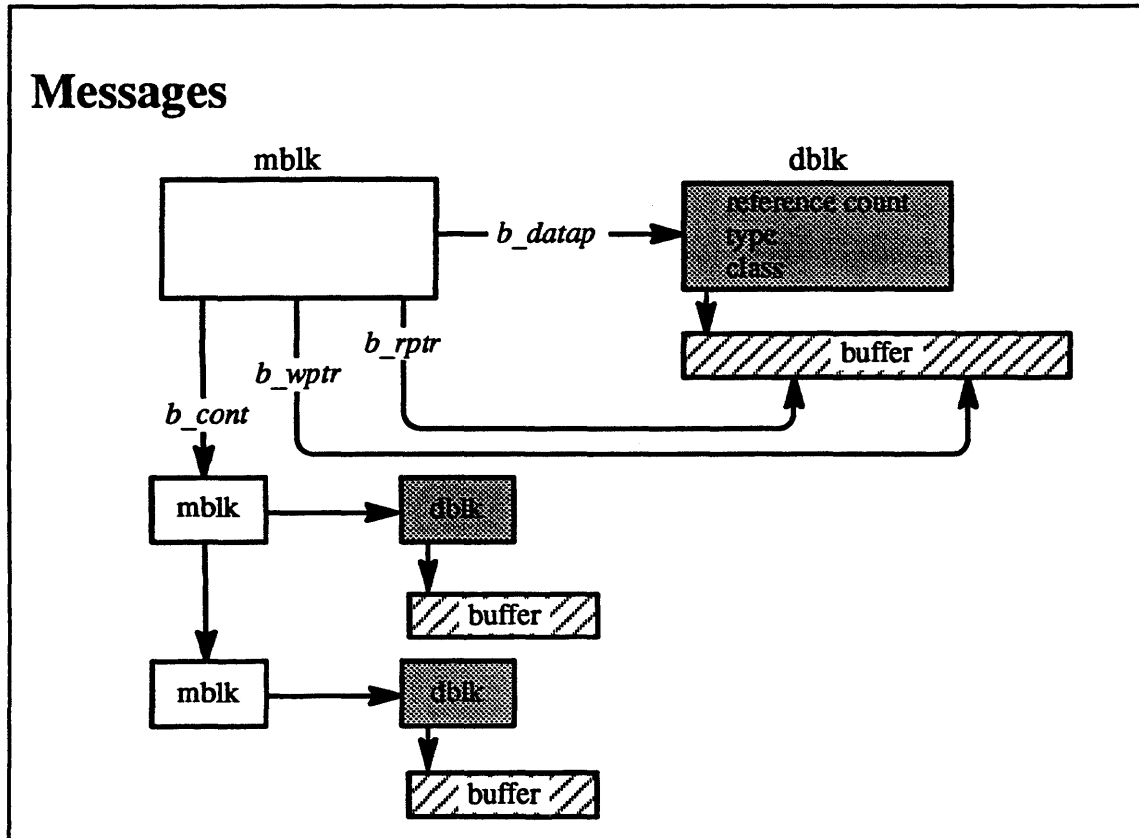

7-15.

© 1990, 1991 Open Software Foundation

## Module 7 — Streams

---

### Student Notes: Messages

A message is represented as a linked list of *mbks*. Each *mbk* indirectly refers to a buffer via a *dbk*. The *dbk*, as is discussed further on page 7-35, contains the reference count and other information about the buffer. The *mbk* contains a pair of pointers pointing directly into the buffer. These pointers allow the easy representation of consuming data from the buffer and putting data into the buffer.

**7-16. Message Flow**

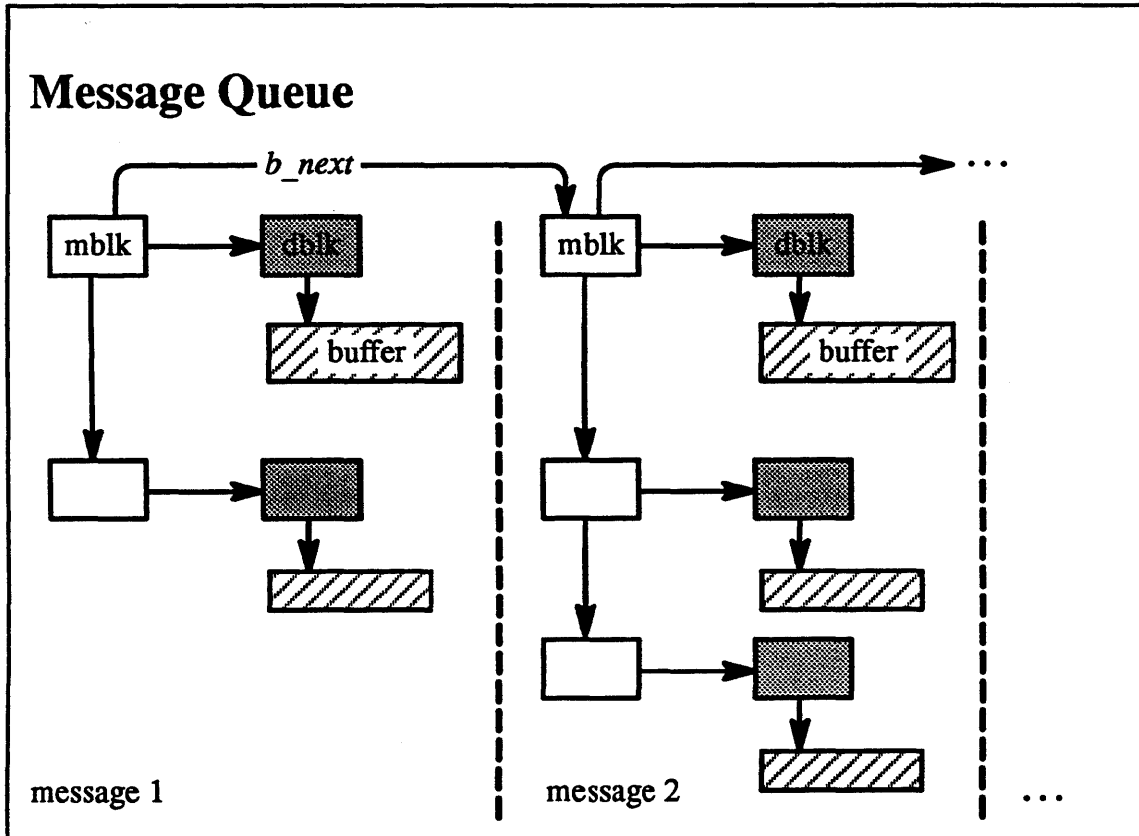

7-16.

© 1990, 1991 Open Software Foundation

## Module 7 — Streams

---

### Student Notes: Message Queue

A queue of messages is represented by linking together the first *mbks* of each message.

## 7-17. Message Flow

### Virtual Copy (Streams Style)

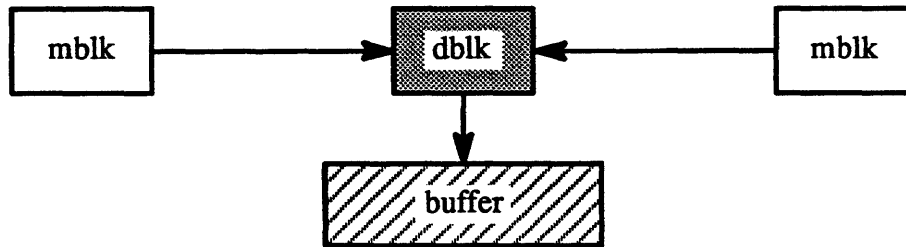

7-17.

© 1990, 1991 Open Software Foundation



## Module 7 — Streams

---

### Student Notes: Virtual Copy (Streams Style)

In many situations, it is necessary for a streams module both to pass a reference to data and to retain a reference to the same data. For example, the TCP protocol would send data to be transmitted to the IP protocol, but would retain a copy of the data just in case it is never acknowledged and thus must be retransmitted. This “virtual copy” is implemented with reference counts: each buffer’s *dbl* contains the buffer’s reference count. Creating a virtual copy of the buffer merely involves incrementing the reference count. Freeing a buffer causes its reference count to be decremented; if the reference count is reduced to 0, then the storage is actually liberated.

### 7-18. Message Flow

#### Types of Messages

- Ordinary message types:
  - M\_DATA
  - M\_PROTO
  - M\_IOCTL
  - M\_CTL
  - M\_BREAK
  - M\_DELAY
  - M\_PASSFP
  - M\_SETOPTS
  - M\_SIG
- Priority message types:
  - M\_PCPROTO
  - M\_ERROR
  - M\_HANGUP
  - M\_IOCACK
  - M\_IOCNAK
  - M\_FLUSH
  - M\_PCSIG
  - M\_START
  - M\_STOP

## Module 7 — Streams

---

### Student Notes: Types of Messages

Each message block is assigned a type that streams modules use to determine what sort of processing is required. There are two classes of messages: those that are subject to flow control (*ordinary messages*) and those that are not (*priority messages*).

Since priority messages are not subject to flow control, they are forwarded even if subsequent queues are full.

For example, an `ioctl` system call might be implemented within a streams component. In this case, a message is created whose first *mbk* points to a *dbl* of type `M_IOCTL`, which points to a buffer containing the command. Subsequent *mbks* of this message point to *dbls* of type `M_DATA`, which point to buffers containing the associated data. This message is passed down the pipeline until it reaches a component that recognizes the `ioctl` request. This component performs the desired action and sends back a priority message whose first *mbk* points to a *dbl* of type `M_IOCACK`. Being a priority message, it is passed up to the stream head immediately without being queued, and thus it is dealt with at the stream head before any ordinary messages that might be in the queues. This prioritized delivery is necessary because the thread performing the `ioctl` system call does not move on to make, for example, `read` system calls until the `ioctl` system call completes.

If no component recognizes the `ioctl` request, then the last component, a streams driver, sends back a priority message of type `M_IOCNAK`.

## 7-19. Implementation of Streams

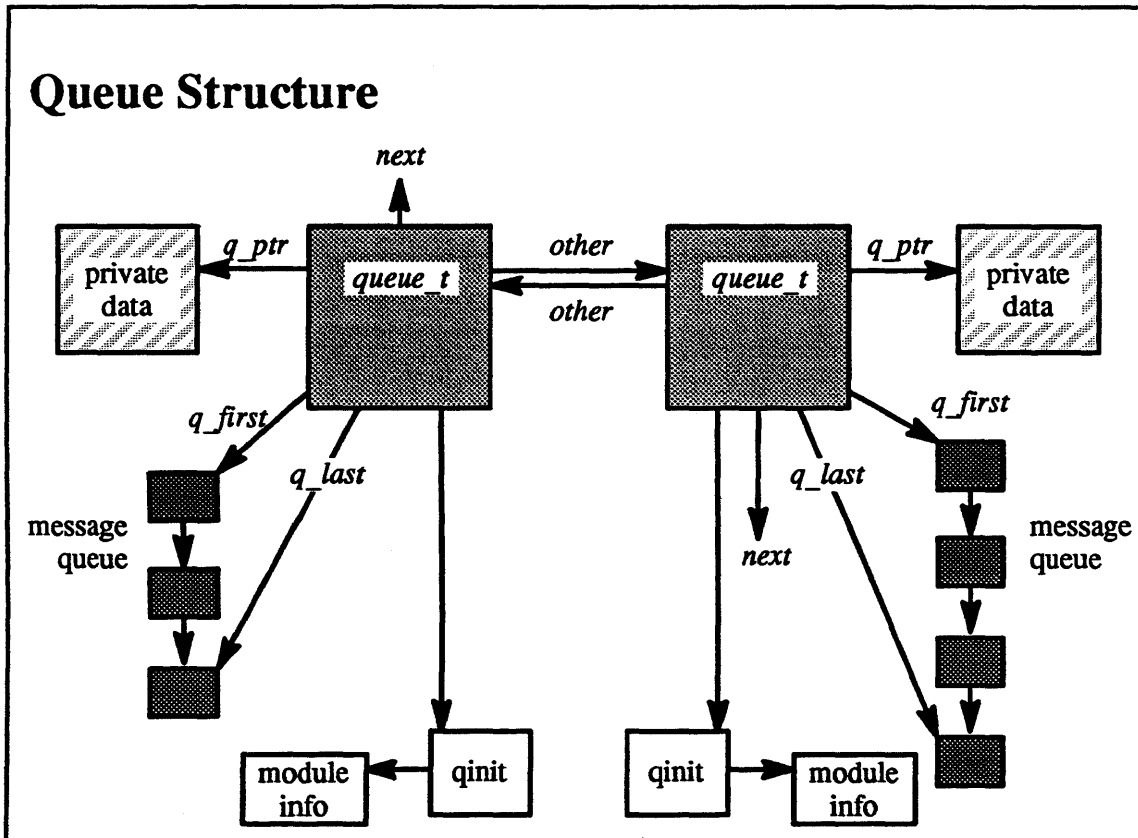

7-19.

© 1990, 1991 Open Software Foundation

## Module 7 — Streams

---

### Student Notes: Queue Structure

Each instance of a streams component, whether stream head, module, or driver, is represented by a pair of *queue\_t* structures. Each such structure links the component to the next component in the pipeline, points to the associated queue of messages, and points to two types of data structures.

The first type of data structure, the *qinit* structure, contains information shared by all instances of the component. It contains the addresses of the *put* and *service* procedures for either the read or write half of the component and points to the *module info structure*, which gives the default values for various parameters.

The second type of data structure, pointed to by *q\_ptr*, contains information that is private to each instance of a component. The contents of this data structure depend upon the component.

# Module 7 — Streams

## 7-20.<sup>OSF</sup> Implementation of Streams

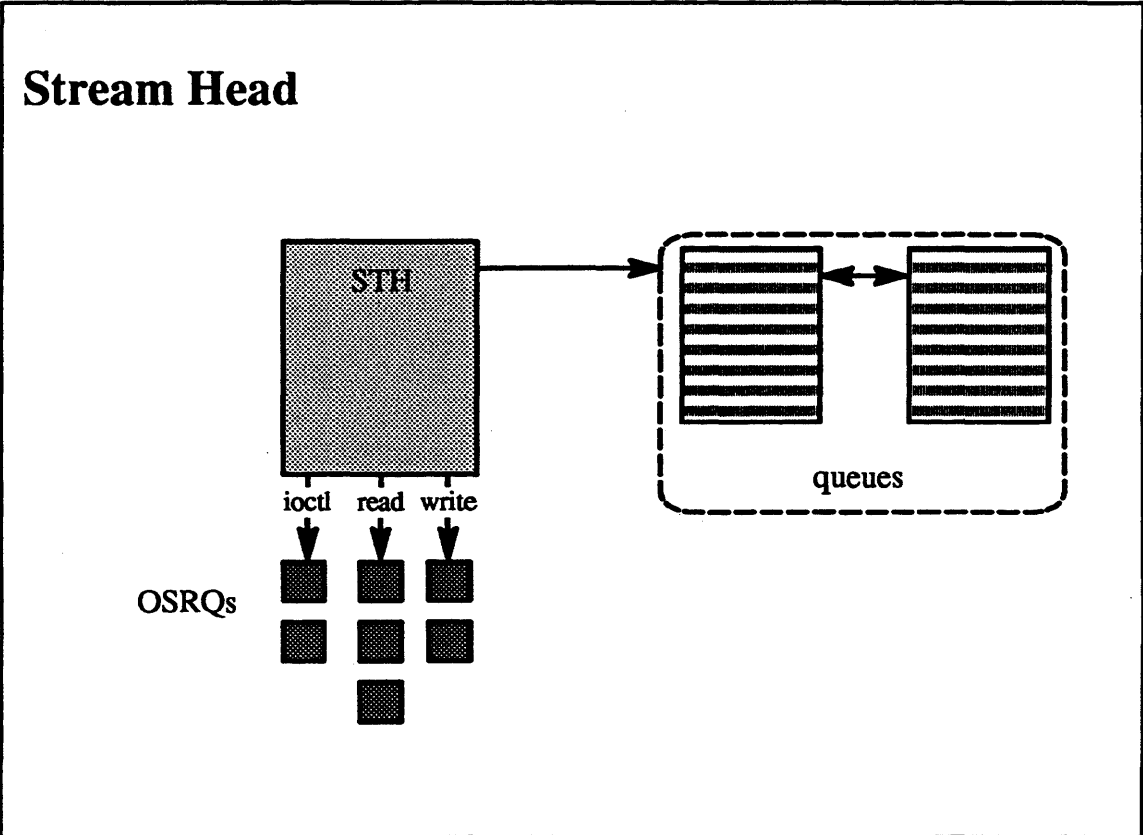

7-20.

© 1990, 1991 Open Software Foundation

## Module 7 — Streams

---

### Student Notes: Stream Head

The *stream-head module* provides the interface between system calls and the stream. It is the only portion of streams in which threads may block: a thread making a system call must necessarily block until it can return.

The module is represented by a STH (stream head) structure. It contains various pieces of information about the stream and refers to the stream-head queue data structures.

Multiple threads may access the stream concurrently. Three types of system calls involve messages and streams: *ioctls*, *reads* and *getmsgs*, and *writes* and *putmsgs*. A user thread (executing a streams system call) creates an operating system request (OSR) structure to represent the system call. If the request cannot be satisfied immediately, then the OSR is queued on one of the STH's OSRQs (one queue for each system call type).

7-21. Implementation of Streams

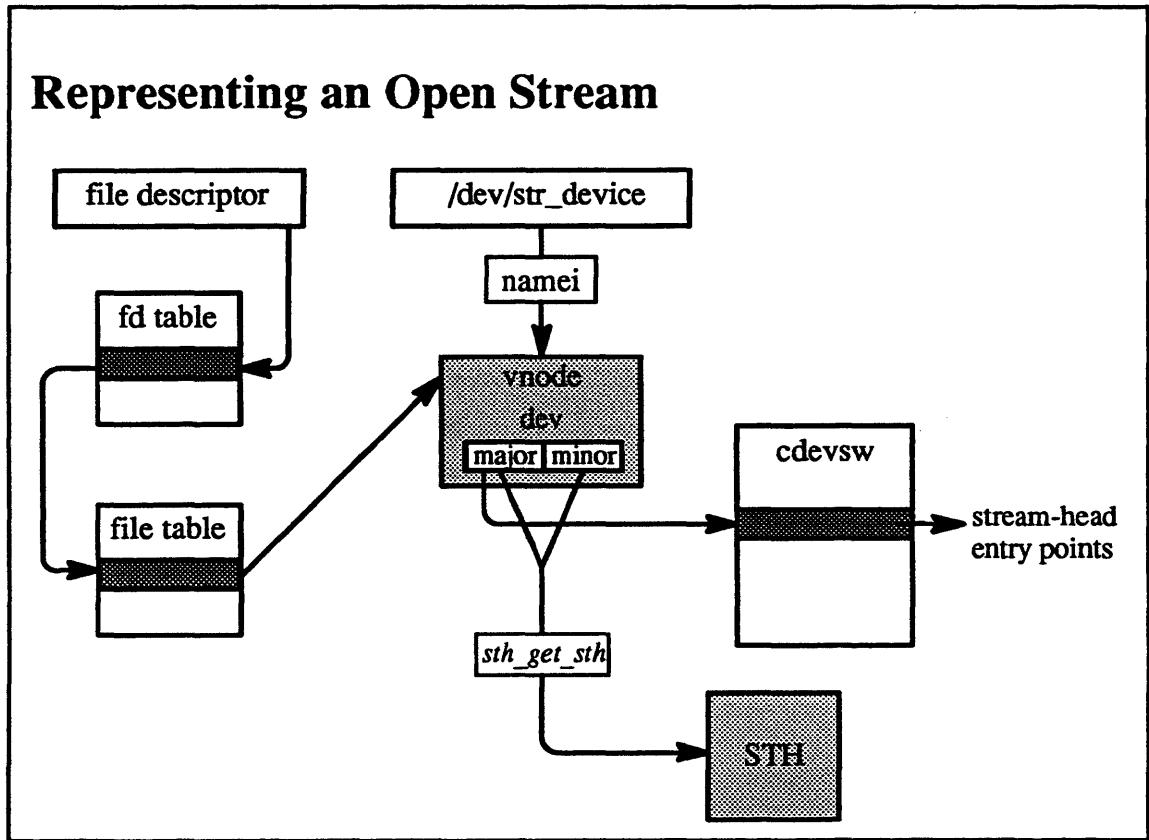

7-21.

© 1990, 1991 Open Software Foundation



## Module 7 — Streams

---

### Student Notes: Representing an Open Stream

An open stream appears to the rest of the operating system as if it were a character special file. The *cdevsw* entry contains not the addresses of the streams driver's entry points but the entry points of the more general stream-head routines. This is important since the interface to the system-call layer is at the stream head and not at the streams driver. The stream-head code itself finds the desired stream by accessing the STH structure.

# Module 7 — Streams

## 7-22. Implementation of Streams

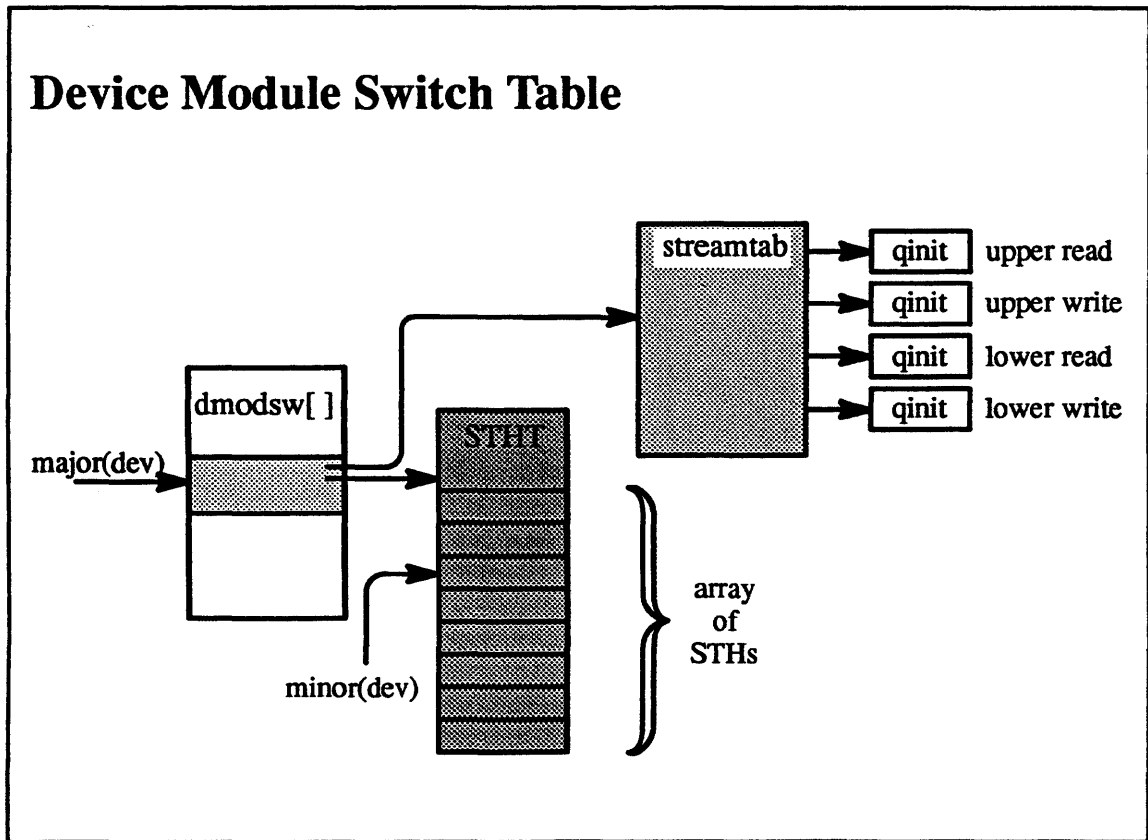

7-22.

© 1990, 1991 Open Software Foundation

## Module 7 — Streams

---

### Student Notes: Device Module Switch Table

The device module switch table is an array of *dmodsw* structures, one for each type of streams driver. It is accessed by the major portion of the device number and refers to the device's *streamtab* structure. This structure contains the addresses of the *qinit* structures for each portion of the device (the device may be a multiplexer, so the *streamtab* structure refers to the *qinit* structures for the lower-side queues as well).

Each *dmodsw* entry also refers to an STHT (stream header table) structure, which is an array of STH structures, one per minor device. The STH structure, as we have seen, represents the stream head of a particular stream and is allocated when the stream (i.e. minor device) is opened.

Each stream appears to the rest of the operating system as if it were a character-special device. Thus associated with each streams device is an entry in the *cdevsw* table. However, this entry refers not to the entry points of the streams driver, but to the general stream-head entry points. Additional information is needed to find the entry points of the streams device itself and to find the STH structure identifying the specific instance of the stream. This information is obtained from the *dmodsw* structure as we have just seen. The major portion of the device number is used twice: once to index the *cdevsw* table to determine that this is a stream, and again to index the *dmodsw* table to find the *streamtab* data structure and the STHT. Finally, the minor portion of the device number is used to index the STHT to find the STH that identifies the actual instance of the stream.

## 7-23. Implementation of Streams

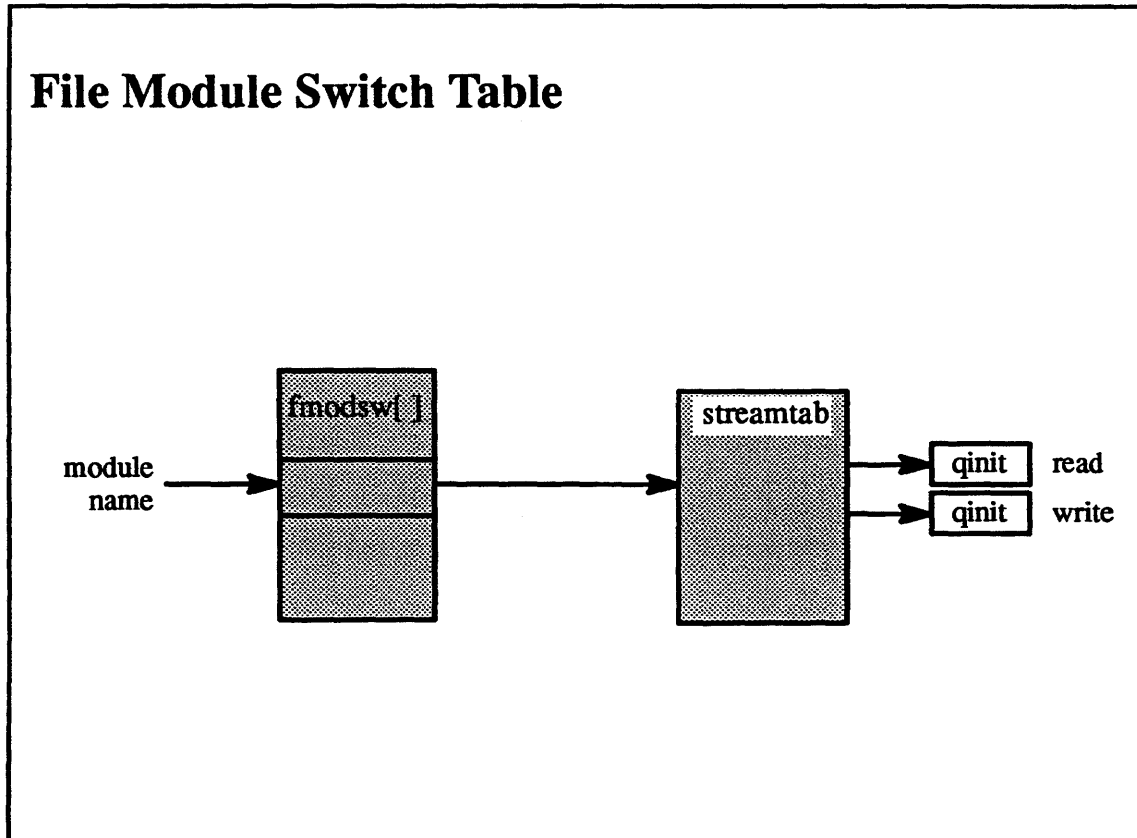

7-23.

© 1990, 1991 Open Software Foundation

## Module 7 — Streams

---

### Student Notes: File Module Switch Table

The *file module switch table* is an array of *fmodsw* structures. It is accessed by the module name and refers to each module's *streamtab* structure, which in turn refers to the module's *qinit* structures. Thus individual streams modules are identified through the file module switch table.

# Module 7 — Streams

## 7-24. Implementation of Streams

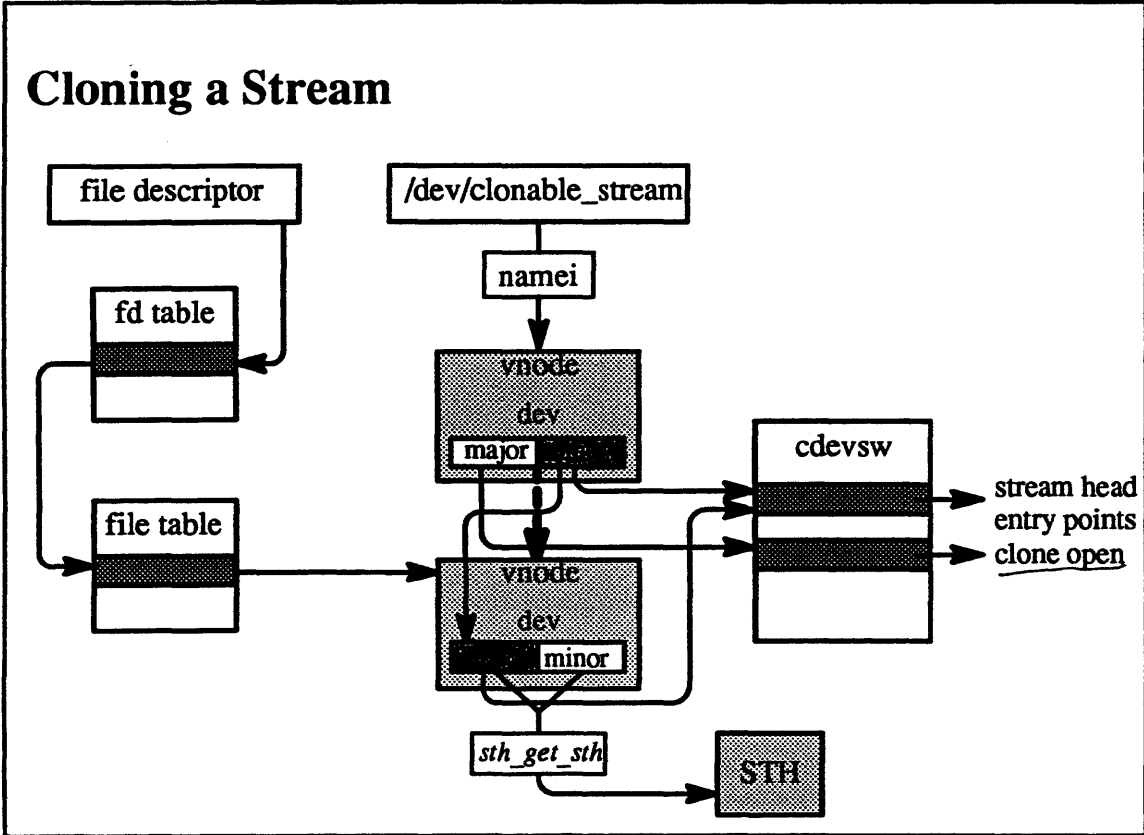

7-24.

© 1990, 1991 Open Software Foundation

## Module 7 — Streams

### Student Notes: Cloning a Stream

The notion of *cloning* is an important concept that was introduced in SVR3 for the support of streams and has been extended in OSF/1 for use in any character-special file. Cloning is used in situations in which there is a varying number of logical devices.

For example, each connection over a streams implementation of TCP/IP is a logical device; each such logical device is represented by a separate minor device. Since the user of the logical device does not really care which minor device member is chosen, it is inconvenient to represent each logical device as a separate special file (in the `/dev` directory). Cloning allows one to use just one special file to represent the major device, and to have the minor device numbers automatically produced internally in response to opening the major device.

A clonable device is represented by a special file whose major device number is that of the *clone driver* and whose minor device number is equal to the major device number of the clonable device. Opening this special file results in a call to the open entry point of the clone driver, *clone\_open*, which returns the error code `ECLONEME`. The caller of this routine, *spec\_open*, then calls *spec\_clone*, which creates a new vnode, and then calls the open routine given in *cdevsw* as indexed by the original minor device number (i.e., the major device number of the clonable device).

For the case of streams, the call to open results in a call to *osr\_open*, which sets up a stream head and the device driver module, and calls the device driver *open* routine with the clone flag set. The device driver then finds an available minor device number and returns it to the caller and the caller's caller, and so forth, who will eventually put this in the new vnode. The effect then is that all further I/O requests use the newly created vnode and access the newly created stream.

## 7-25. Parallelization

### Parallelization of Streams

- Transparent
- Synchronization options:
  - queue-level — 1 Thread in each half at one time
  - queue-pair-level / Thread in either half-like terminal
  - module-level
  - elsewhere
  - global



## Module 7 — Streams

### Student Notes: Parallelization of Streams

Streams are parallelized in a fully transparent manner: streams modules from an SVR3 system can be put into an OSF/1 kernel so as to allow fully parallel execution with essentially no changes to the code. Certainly some synchronization is necessary. This synchronization is implemented within the standard routines that are called for communication between streams and modules. The finest degree of parallelization is at the individual-queue level (SQLVL\_QUEUE). Associated with the queue is a lock; only one thread may execute within the queue at a time. One may also request synchronization across a pair of queues within a module (SQLVL\_QUEUEPAIR), across all instances of a module (SQLVL\_MODULE), and across a group of modules (SQLVL\_ELSEWHERE). For debugging purposes, one may request a single lock for the entire streams system, i.e. only one thread at a time may be executing anywhere (SQLVL\_GLOBAL). -like S5P4

We first look at queue-level synchronization. Whenever a module is entered (e.g. via *putnext*), a check is made to see if the queue is locked. If so, then instead of waiting for the queue to be unlocked, the request is queued on a *synchronization queue*, and the call returns immediately. Thus while a thread operates within a module, further requests to enter that module queue up on the synchronization queue. When the thread leaves the module, it must check if there are any requests in the synchronization queue and then handle each of these requests as if it had made them itself.

The synchronization queue is headed by an SQH data structure, which, for queue-level synchronization (SQLVL\_QUEUE), is in the queue data structure. This contains a pair of simple locks, one that is the lock on the entire queue, and the other that is the lock for operations on the synchronization queue. Each request in the queue is represented by an SQ data structure, which refers to the queue being accessed, the routine being called, and the message being transmitted. The SQ data structure itself is allocated within the *mblk* data structure.

The technique for single-queue parallelization can be extended for coarser parallelization. To achieve queue-pair synchronization (SQLVL\_QUEUEPAIR), one effectively merges the synchronization queues of the two individual queues. This is accomplished through the use of the *sq\_parent* field of the SQH data structure. This field normally points to the SQH data structure itself, but it may point to another SQH data structure. In the latter case, the target SQH structure is used instead of the source SQH structure. So, for queue-pair parallelization, the write-side queue's SQH structure points to that of the read-side queue, and there is one set of blocks and one synchronization queue for both queues of the module.

For module-wide synchronization (SQLVL\_MODULE), each queue in each instance of the module refers to an SQH structure in the module's *fmodsw* structure (or the *dmodsw* structure if it is a driver).

# Module 7 — Streams

## 7-26. Parallelization

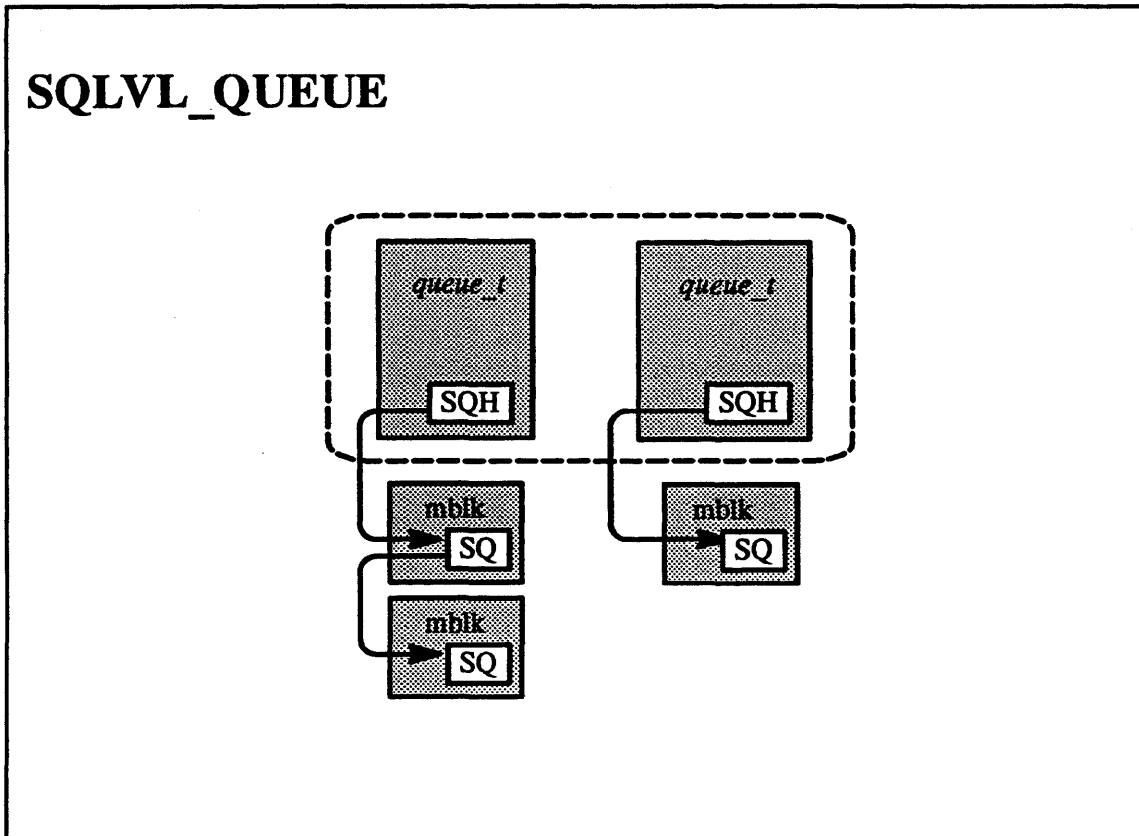

7-26.

© 1990, 1991 Open Software Foundation

## Module 7 — Streams

---

### Student Notes: SQLVL\_QUEUE

In this picture queue-level synchronization is used. There is space in each *queue\_t* for an SQH structure, which heads the queue's synchronization queue. For queue-level synchronization, each of the synchronization queues is totally independent of the others. Thus each queue may have no more than one thread active at a time, but there may be two active threads within each instance of the streams component.

# Module 7 — Streams

## 7-27. Parallelization

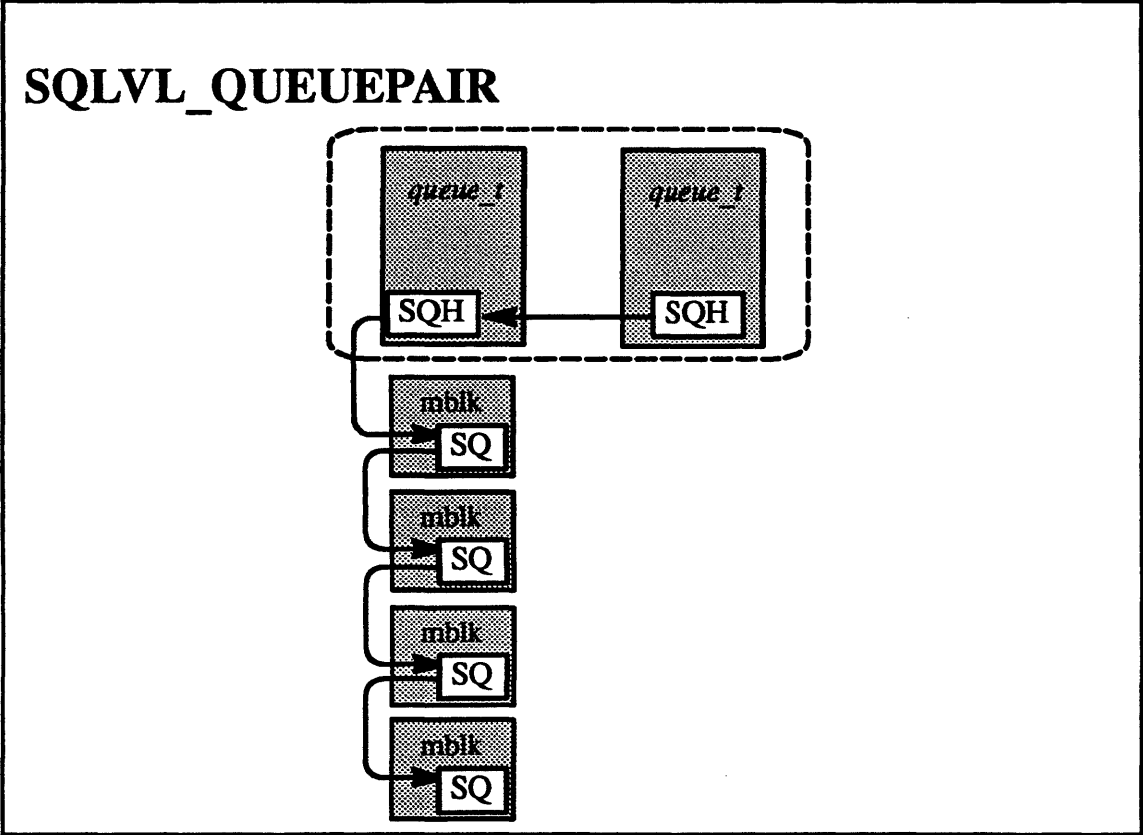

7-21.

© 1990, 1991 Open Software Foundation

## Module 7 — Streams

---

### Student Notes: SQLVL\_QUEUEPAIR

This picture illustrates queue-pair-level synchronization. The *sq\_parent* field of one queue's SQH structure points to the other SQH structure, effectively merging the two synchronization queues. Thus we are assured that only one thread can be in either queue at a time.

# Module 7 — Streams

## 7-28. Parallelization

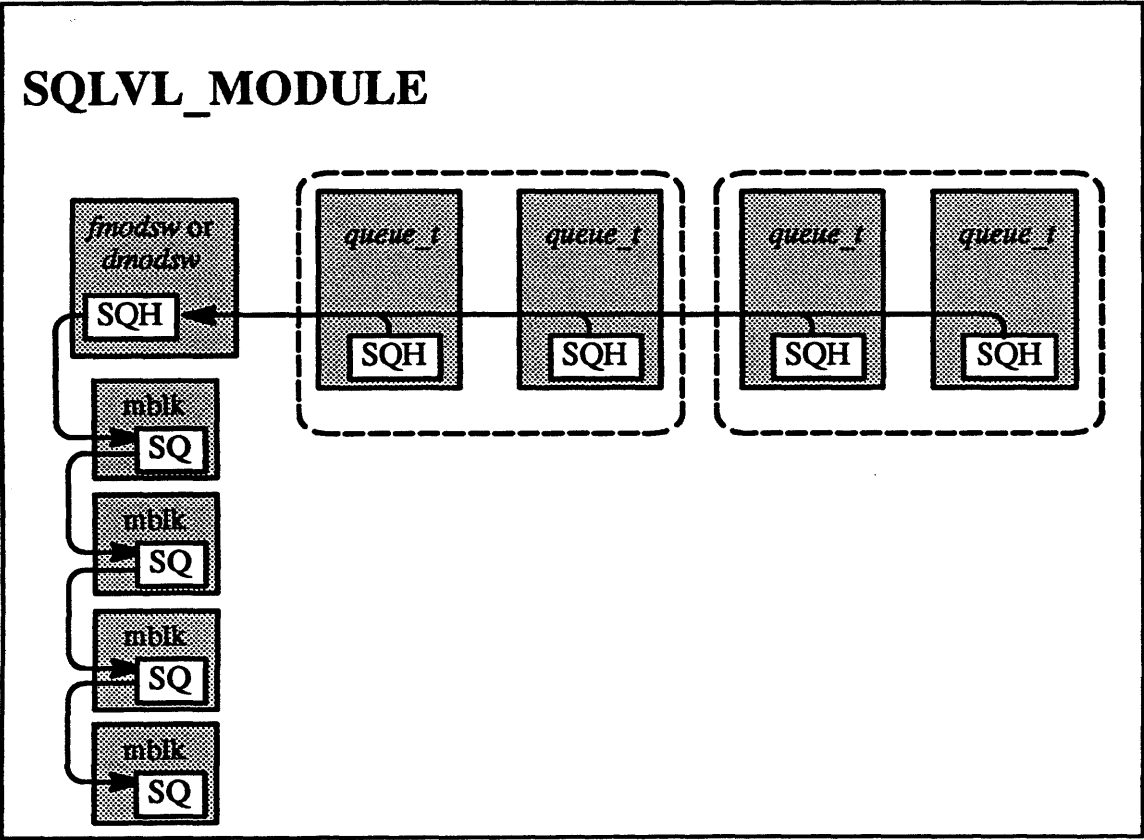

7-28.

© 1990, 1991 Open Software Foundation

*module  
halves of Q?  
See AT&T streams reference*

## Module 7 — Streams

---

### Student Notes: SQLVL\_MODULE

This picture shows module-level synchronization. The *sq\_parent* fields of each queue's SQH structure points to the SQH structure stored in the *fmodsw* structure (modules) or the *dmodsw* structure (drivers). Thus the synchronization queues for all queues within all instances of a module are effectively merged: at most one thread can be active in any instance of the module at a time.

## 7-29. Parallelization

### Implementation of Synchronization Queues

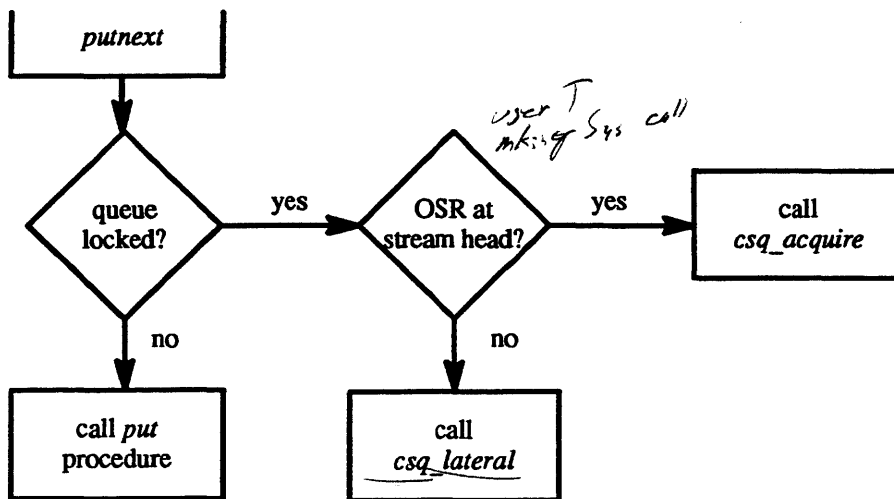

7-29.

© 1990, 1991 Open Software Foundation



## Module 7 — Streams

---

### Student Notes: Implementation of Synchronization Queues

In order to enter a streams module (for example, as part of a *putnext* request), a thread encodes a request in the message's SQ structure and calls the *csq\_lateral* routine. This routine checks the lock on the appropriate synchronization queue. If the lock is taken, the routine puts the request on the synchronization queue and returns. When a thread finishes a request inside of the module, as mentioned earlier, it checks the synchronization queue and handles any queued requests.

This arrangement could result in a race condition. The calling thread might determine that the queue is busy, but, before it can enqueue an SQ on the synchronization queue, the thread that owned the streams queue determines that the synchronization queue is empty and releases the lock. Thus the SQ will soon be enqueued, but no thread will be available to process it. To deal with this, *csq\_lateral* checks the lock after it has enqueued the SQ, and, if it has been released, then processes the SQ itself.

When a user thread (executing in kernel mode in response to a system call) operating within a stream head calls *putnext* to send a message to the first module, it calls *csq\_acquire* instead of *csq\_lateral*. This routine blocks waiting for the lock. When the thread holding the lock is finished with its operation, instead of processing the synchronization queue itself, it hands the work over to the user thread blocked in *csq\_acquire*.

## Module 7 — Streams

### Exercises:

1.
  - a. List the three types of streams components.
  - b. What happens when one stream is linked to another stream?
  - c. What are the functions of a multiplexer?
2.
  - a. What is the purpose of the *dbl* data structure?
  - b. How is data prepended to the beginning of a message?
  - c. From what routines is a module's *put* procedure called? In whose context are *service* procedures called?
3.
  - a. When are *queue\_t* structures allocated?
  - b. Explain why it is necessary for streams-oriented system calls to be serialized. What mechanism is used to perform this serialization?
4.
  - a. When a *read* or *write* system call is issued to an open stream, at what point does the flow of control first differ from the flow when an ordinary character-special device is called?
  - b. Explain the role of the streams device driver in cloning.
5.
  - a. List the synchronization options available in streams.
  - b. When is it permissible for a thread to block within a streams call?
  - c. Explain how synchronization queues differ from ordinary streams queues.

### Advanced Question:

6. Synchronization queues add another set of queues to a streams pipeline. Explain what effects this might have on data in the pipeline. For example, does the use of synchronization queues affect the order of messages? Does it affect the number of messages that may exist within a pipeline?

# Module 8—Sockets

---

## Module Contents

1. Sockets .....	8-4
Types of sockets	
Integrations into the operating system	
2. Mbufs .....	8-10
Representing messages	
Memory allocation and liberation	
3. Implementation .....	8-26
Protocol integration	
Socket data structure	
Parallelization	
4. Sockets and Streams .....	8-34

## Module Objectives

In order to demonstrate an understanding of sockets and their use in supporting networking in OSF/1, the student should be able to:

- explain the difference between communication using datagram sockets and communication using stream sockets
- describe how messages are represented by *mbufs*
- list the set of actions that may be taken when the list of free *mbufs* is exhausted
- explain how kernel threads are used in the socket networking subsystem
- explain how OSF/1 supports both a streams and a socket interface to networking

# Module 8 — Sockets

## 8-1. The Big Picture

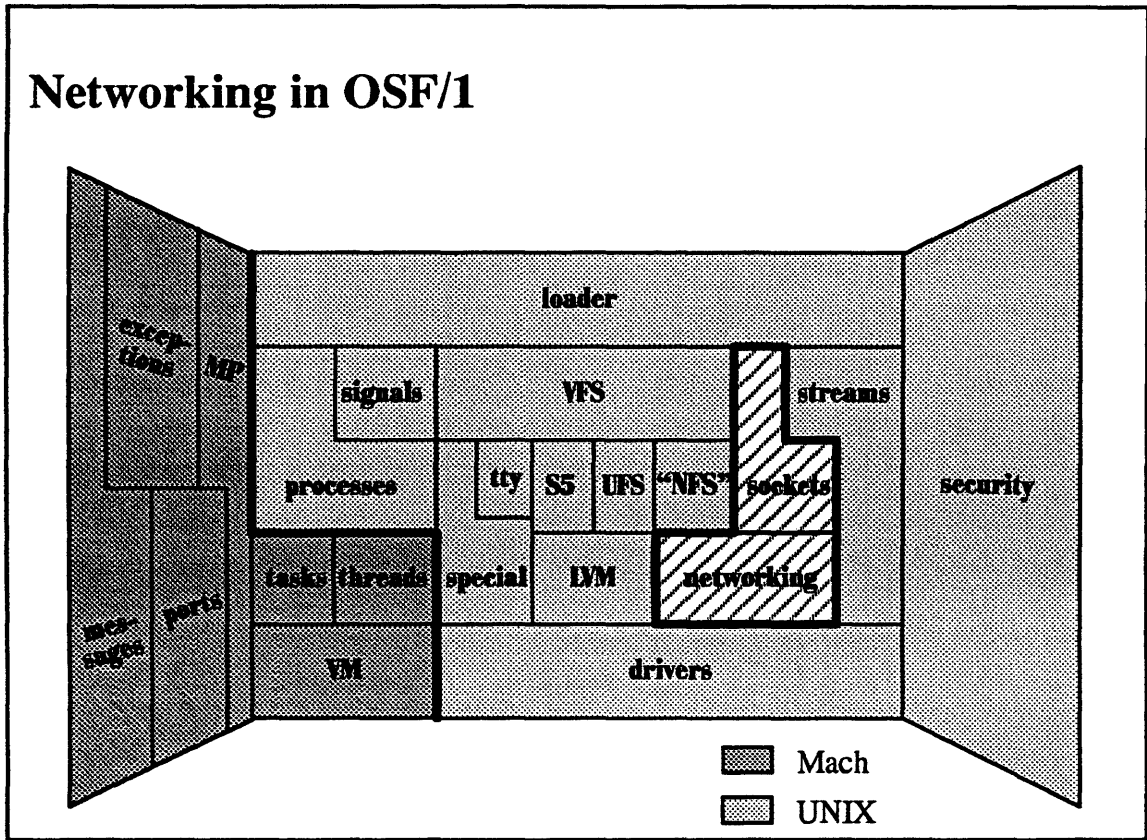

8-1.

© 1990, 1991 Open Software Foundation

## Module 8 — Sockets

### Student Notes: Networking in OSF/1

OSF/1 uses Berkeley's *socket* model to implement its communication protocols. The code is a parallelized version of that in 4.4BSD. The recommended user interface for networking is the X/Open Transport Interface (XTI), which is an enhancement of AT&T's Transport Layer Interface (TLI). While user code can communicate directly with the socket layer, XTI is more likely to be portable.

OSF/1 implements XTI in a user-level library that communicates with the operating system via the streams interface. Since OSF/1 implements the network protocols in the socket framework rather than in the streams framework, the system provides a conversion layer. This conversion layer is a stream whose device driver converts stream requests into socket requests.

Some of the material in this module is discussed in chapter 14 of Open Software Foundation, 1990a.

### 8-2. Sockets

#### Interprocess Communication with Sockets

- Sockets are an extension of the I/O interface for general-purpose interprocess communication
- Sockets support a number of communication styles, as implemented by a variety of protocols

## **Module 8 — Sockets**

---

**Student Notes: Interprocess Communication with Sockets**

## 8-3. Sockets

### Socket Types

- Datagram *DUP*
  - unreliable
  - order not guaranteed
  - allows broadcast (connectionless) *ok for Ethernet*
  - record-oriented
- Reliable packet
  - reliable
  - order not guaranteed
  - connection-oriented
  - record-oriented
- Sequenced packet
  - reliable
  - guaranteed order
  - connection-oriented
  - record-oriented
- Stream *TCP*
  - reliable
  - guaranteed order
  - connection-oriented
  - record boundaries not preserved *-best for UNIX*



## Module 8 — Sockets

---

### Student Notes: Socket Types

OSF/1 includes only protocols supporting datagram and stream-type sockets. The UNIX domain contains both a datagram and a stream protocol, as does the Internet domain. (UDP is the datagram protocol; TCP is the streams protocol.)

# Module 8 — Sockets

## 8-4. Sockets

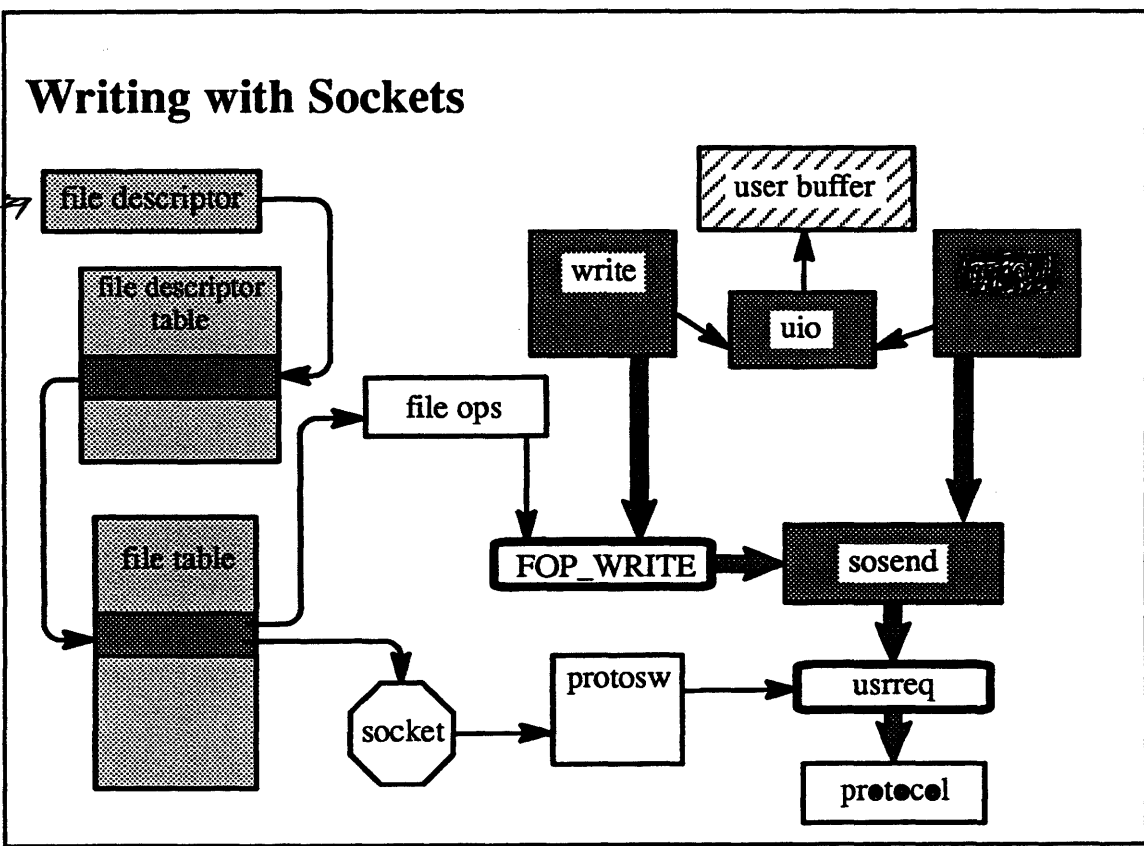

8-4.

© 1990, 1991 Open Software Foundation

*{ write  
writer*

*send ← sockets only*

## Module 8 — Sockets

---

### Student Notes: Writing with Sockets

In Module 5 we saw that the *fileops* array contained the vector of entry points for operations on files. In this case it contains the vector of entry points for operations on sockets.

The *protosw* contains the entry points into the selected protocol.

### 8-5. Mbufs

#### Data Management

- Streams
  - data passed by reference using *mbks*
- Sockets
  - data passed by value and by reference using *mbufs*

## Module 8 — Sockets

---

### Student Notes: Data Management

As with streams, data structures must be provided to facilitate the efficient movement of data through the various layers of the system. The data structures used with sockets, known as *mbufs*, are very similar to the data structures used with streams (*mblks*). The major difference is that while with *mblks* all data is passed by reference, with *mbufs* small amounts of data can be passed by copying (though larger amounts of data are passed by reference).

8-6. Mbufs

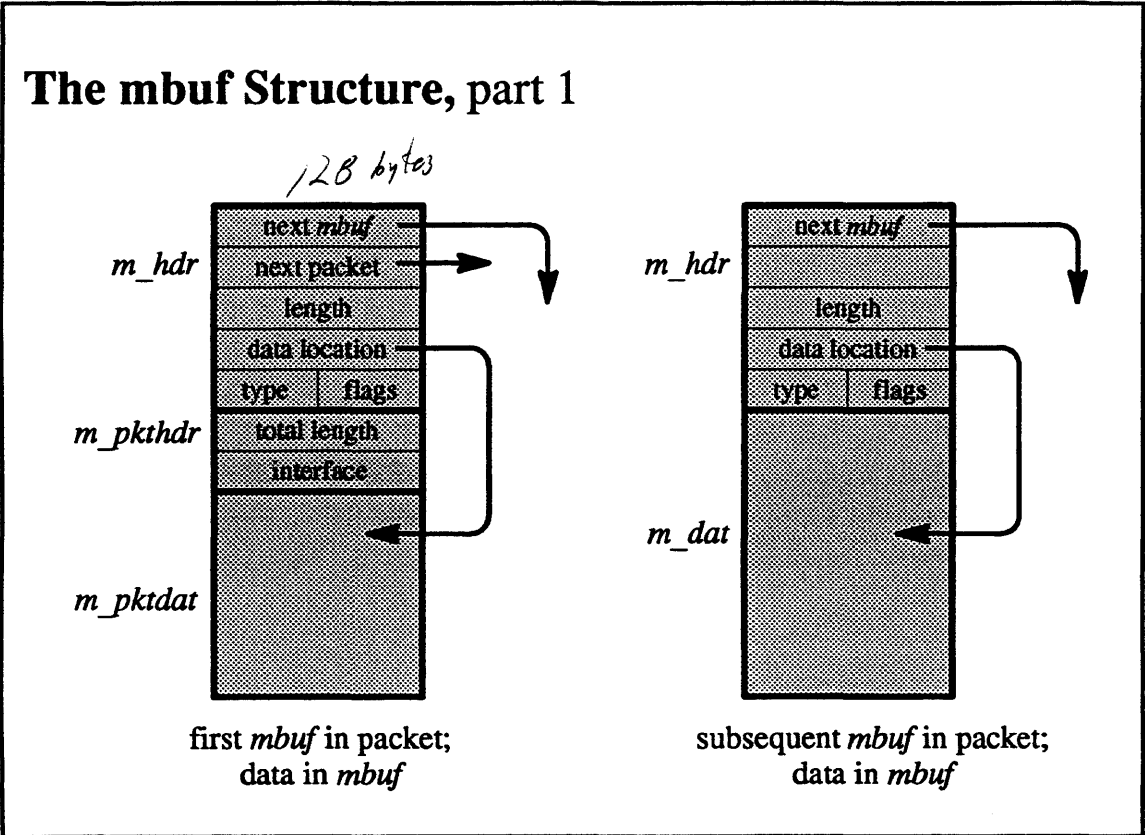

8-6.

© 1990, 1991 Open Software Foundation

## Module 8 — Sockets

---

### Student Notes: The mbuf Structure, part 1

*Mbufs* either contain a small amount of data (up to 108 bytes) or refer to a larger amount of data. As with *mbks*, a packet is represented by chaining a sequence of *mbufs*, and a queue of packets is represented by chaining the first *mbuf* of each packet. The header of each *mbuf*, besides containing the links in the various chains, describes the contents of the *mbuf* and includes a pointer to the first byte of data, wherever it may be. The first *mbuf* contains additional information: the length of the entire packet and possibly a reference to the network interface from which the packet came, or to which it is going.

## 8-7. Mbufs

### The mbuf Structure, part 2

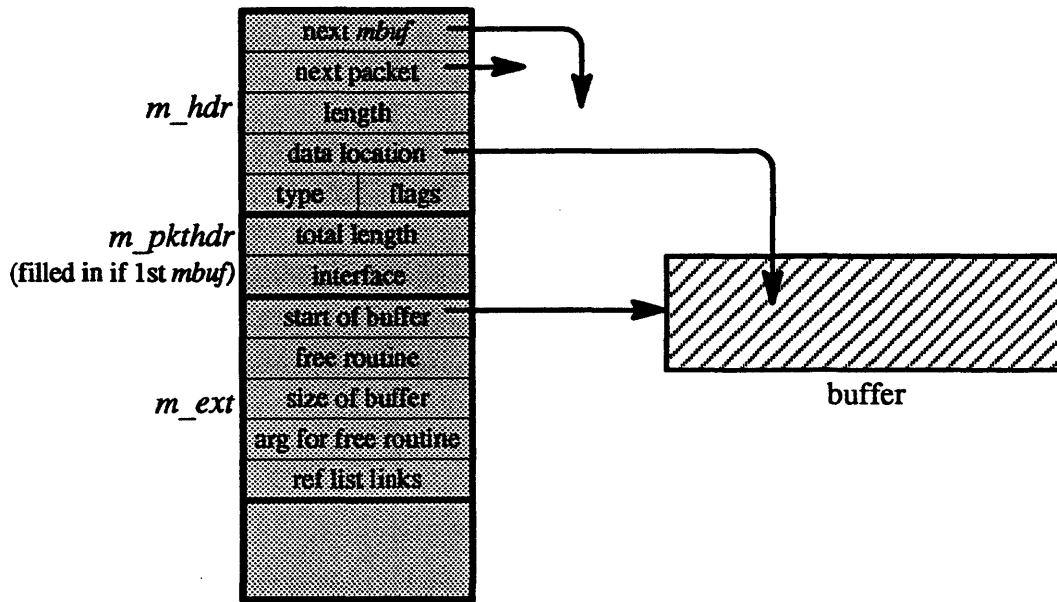

8-7.

© 1990, 1991 Open Software Foundation



## Module 8 — Sockets

---

### Student Notes: The mbuf Structure, part 2

If an *mbuf* does not contain its data but instead refers to it, then the *mbuf* contains an *m\_ext* structure to refer to the buffer.

8-8. Mbufs

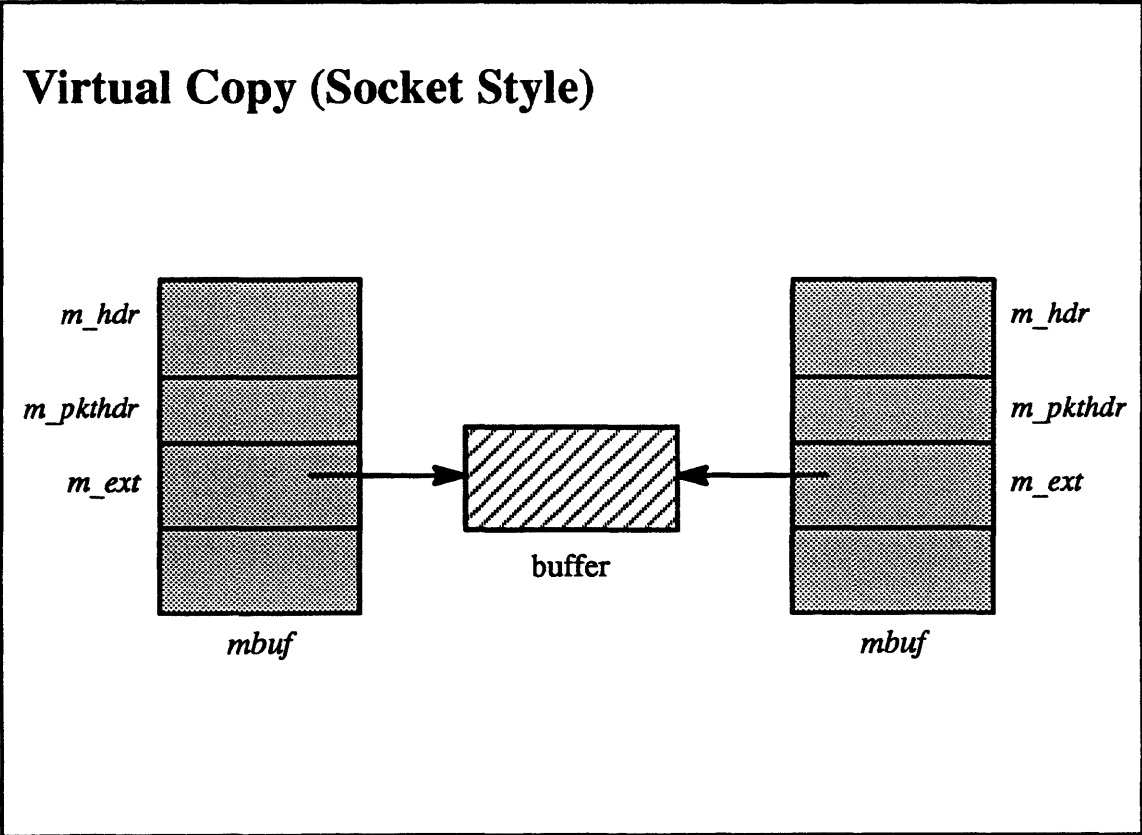

8-8.

© 1990, 1991 Open Software Foundation

## Module 8 — Sockets

---

### Student Notes: Virtual Copy (Socket Style)

Buffers may be passed by reference; different layers of the protocol may each contain references to the same buffer.

8-9. Mbufs

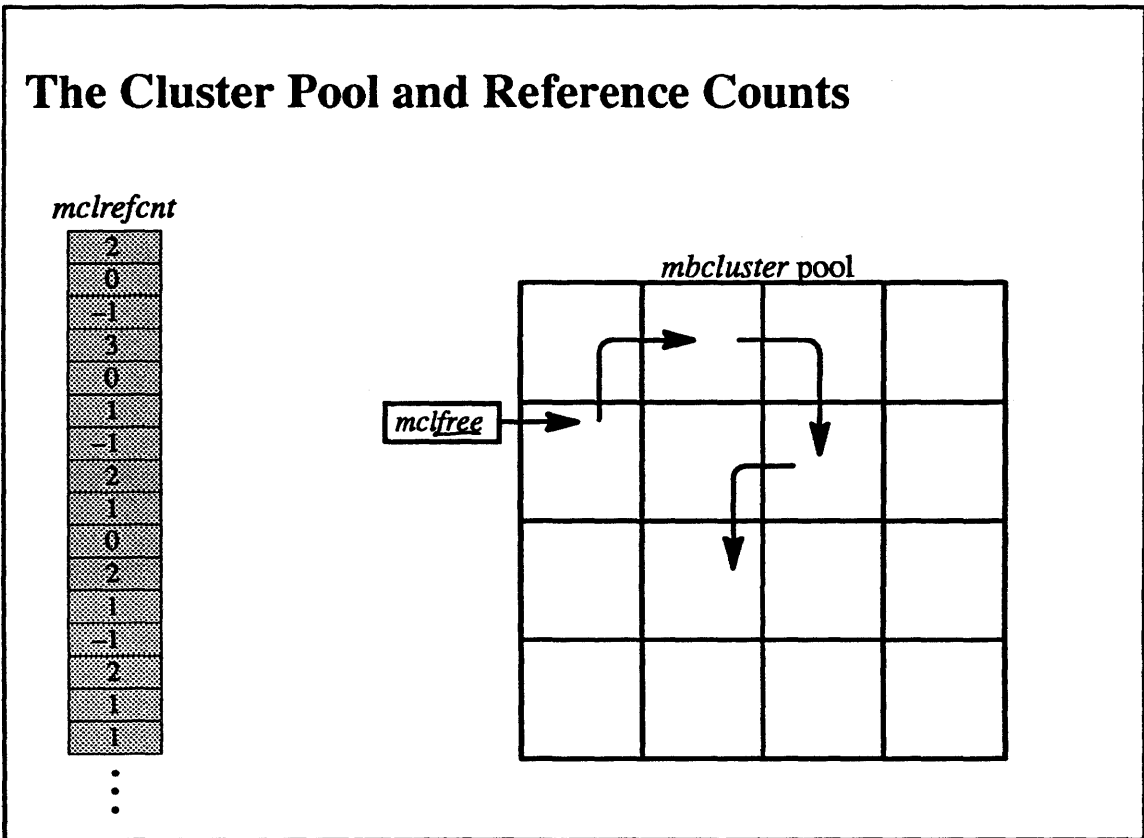

8-9.

© 1990, 1991 Open Software Foundation

## Module 8 — Sockets

---

### Student Notes: The Cluster Pool and Reference Counts

The system maintains a pool of *mbclusters*, which are buffers to which *mbufs* may refer. Thus, for example, to buffer data going to the network, the system allocates *mbclusters* to hold the data and *mbufs* to hold the protocol headers.

Free *mbclusters* are linked together in a free list headed by *mclfree*. The *mclrefcnt* array contains the reference counts to the *mbclusters*. A reference count of 0 indicates no references to a particular *mbcluster*. A reference count of -1 indicates that no real memory is backing up the associated virtual address.

8-10. Mbufs

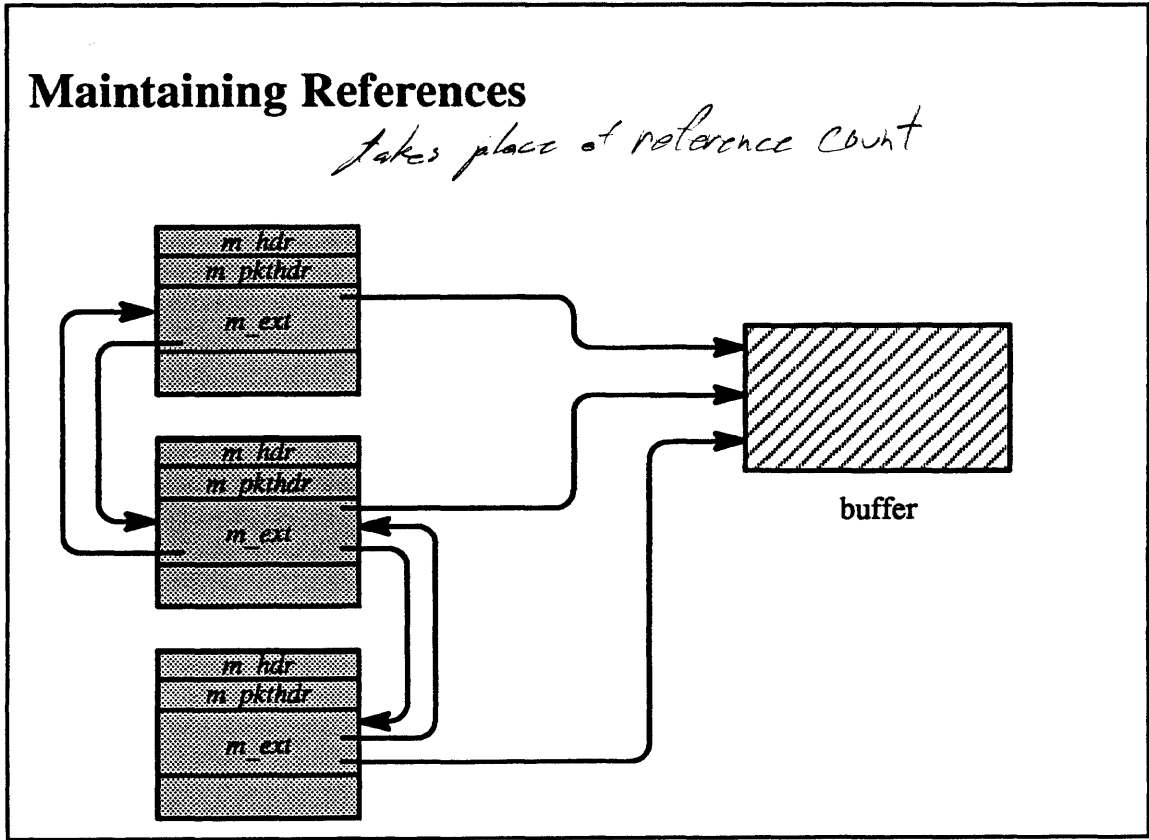

8-10.

## Module 8 — Sockets

### Student Notes: Maintaining References

Buffers need not be allocated from the *mbcluster* pool. In particular, the streams system can allocate buffers and pass them on to the socket system via the XTISO driver. The only difficulty in doing this is maintaining the reference count. The *mclrefcnt* array cannot be used, since these buffers are not coming from the *mbcluster* pool.

All *mbufs* referring to the same buffer are doubly linked via their *m\_ext* structures. Each *m\_ext* structure contains the address of a storage liberation routine to be called when the last reference to a buffer goes away.

*free*

**8-11. Mbufs**

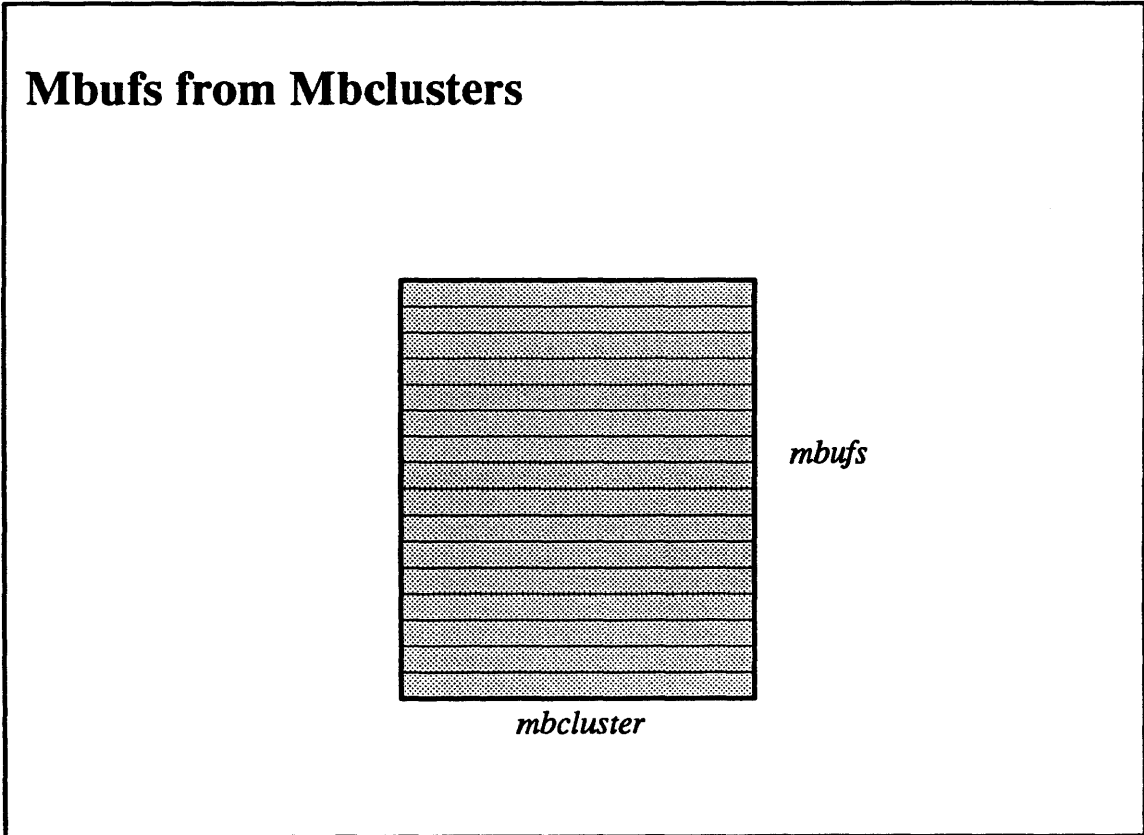

8-11.

© 1990, 1991 Open Software Foundation



## Module 8 — Sockets

---

### Student Notes: Mbufs from Mbclusters

The system allocates a fixed amount of virtual memory and a smaller amount of real memory for the pool of *mbclusters*. Free *mbclusters* (backed up with real memory) are linked into a free list. When the supply of free *mbclusters* becomes too low, it is replenished with pages from the free page list.

*Mbufs* are obtained by allocating *mbclusters* and breaking them up into *mbufs*. Free *mbufs* are linked together. When this supply of *mbufs* becomes too low, more *mbufs* are allocated from *mbclusters*.

The system invokes a *garbage collector* every five seconds to examine the *mbuf/mbcluster* situation and free up storage when necessary: if there are more than enough *mbufs*, then some are coalesced back into *mbclusters* and returned to the free *mbcluster* list. If there are more than enough *mbclusters*, then some are deallocated by returning their pages to the free page list.

The *mclrefcnt* array is used to aid the coalescing *mbufs* into *mbclusters*. When an *mbcluster* is on the free list, its reference count is 0. When it is broken up into *mbufs*, its reference count is set to 1. When an *mbuf* is allocated from the free list of *mbufs*, the reference count of the associated *mbcluster* is incremented by 1 (and decremented by 1 when the *mbuf* is freed).

## 8-12. Mbufs

### Responding to Memory Shortages

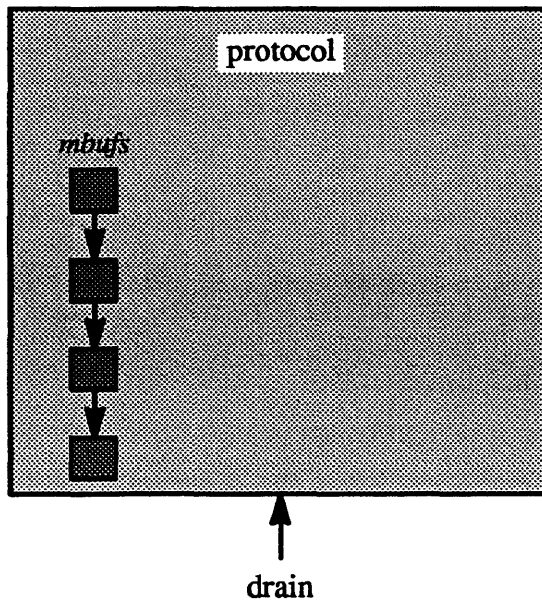

8-12.

© 1990, 1991 Open Software Foundation

## Module 8 — Sockets

---

### Student Notes: Responding to Memory Shortages

Many protocols hold on to data maintained in *mbufs* for a period of time. For example, the IP protocol maintains a reassembly queue to hold on to pieces of fragmented packets. When further pieces arrive the IP protocol reassembles them into a whole packet. If the operating system is extremely short of real memory, it calls each protocol's *drain* routine to ask the protocol to liberate as much memory as possible. In response to a call to its *drain* routine, the IP protocol releases the *mbufs* in all of its reassembly queues.

# Module 8 — Sockets

## 8-13. Implementation

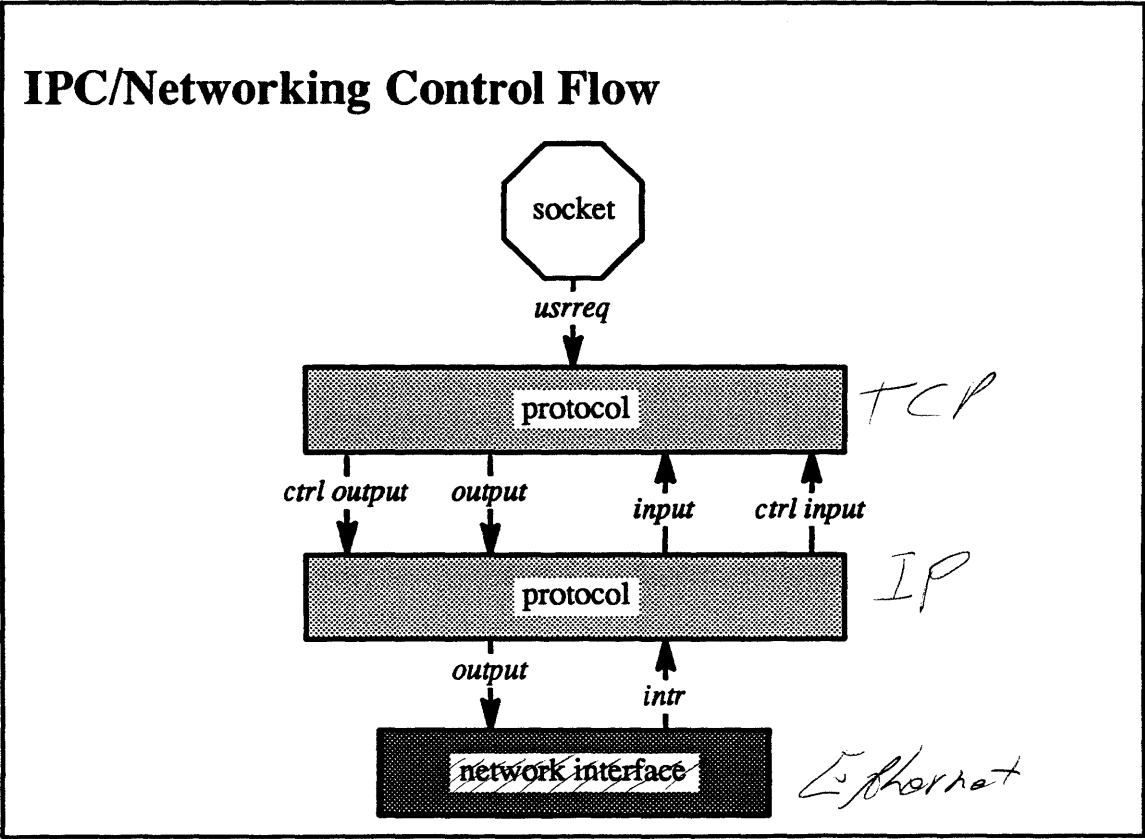

8-13.

© 1990, 1991 Open Software Foundation

*BSF 1 TCP/IP in Thread context  
Have more kernel threads than processors -4*

## Module 8 — Sockets

---

### Student Notes: IPC/Networking Control Flow

In a typical protocol stack, the top-level protocol might be TCP, the bottom-level protocol IP, and the network interface an *ethernet* interface. A user thread making a system call enters the socket layer and calls the top-level protocol's *usrreq* entry point. Control may continue via a call to the next level of protocol, which may then queue an output request by calling the network interface.

Packets coming from the network are dealt with in the interrupt context by the network-interface module, and then queued for processing by the bottom-level protocol. A kernel thread, one of a number of *netisr* threads, calls the bottom-level protocol's *intr* entry point and then processes the queued packets. The kernel thread might then continue by calling the top-level protocol's *input* entry point. This protocol processes the data, which is queued on the socket either immediately or sometime later.

The protocols will also be called periodically by *netisr* threads to handle timeouts. Because the *netisr* threads may block, there should be a few more of them than there are processors (so as to maximize the utilization of the available processors).

# Module 8 — Sockets

## 8-14. Implementation

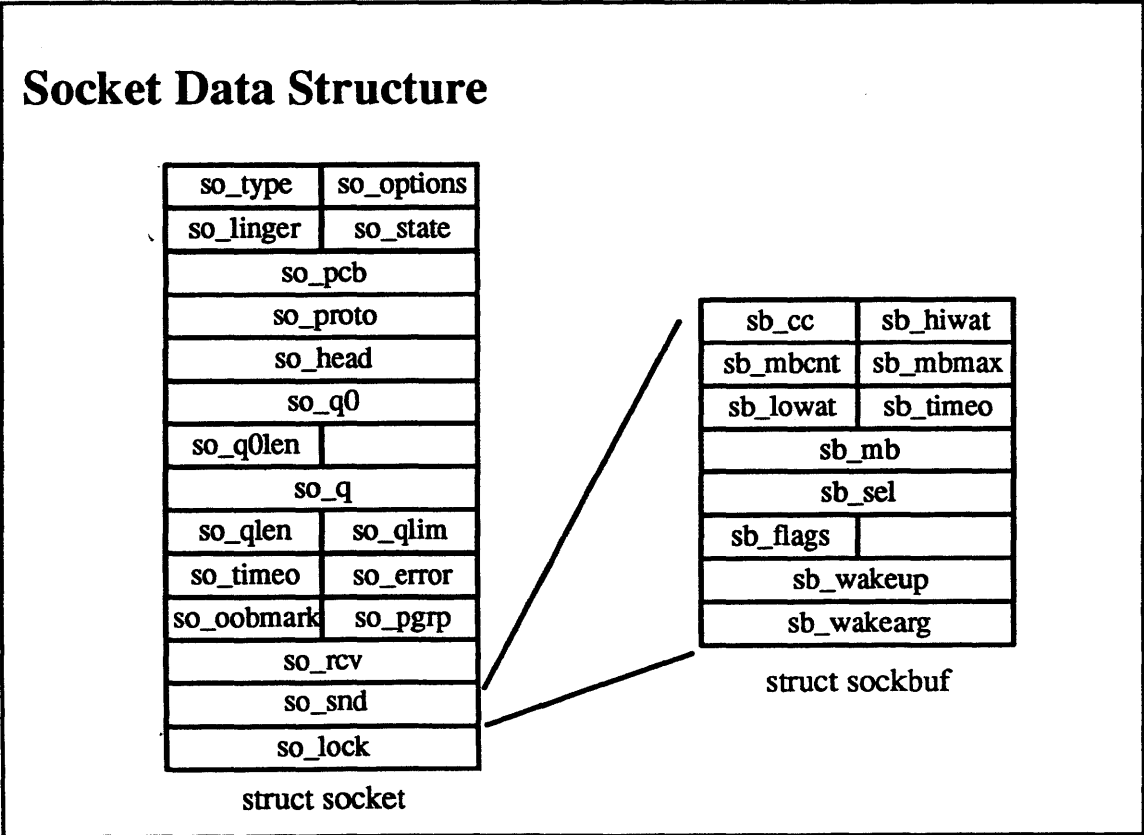

## Module 8 — Sockets

---

### Student Notes: Socket Data Structure

All of the fields of the socket data structure are illustrated in the picture. Of particular importance to this discussion are the socket send and receive queues (*so\_snd*, *so\_rcv*) of type *struct sockbuf*. This data structure contains:

1. a byte count
2. a high-water mark (the maximum allowable size of the queue)
3. a message count
4. a maximum message count
5. a low-water mark (used for flow control: any thread blocked waiting for a space in the queue is woken when the queue size drops below the low-water mark)
6. a pointer to the queue itself (a linked list of *mbufs*)
7. the address of a routine to be called to wake up anyone blocked on the queue

In addition, there is a blocking lock on the entire socket structure.

**8-15. Implementation**

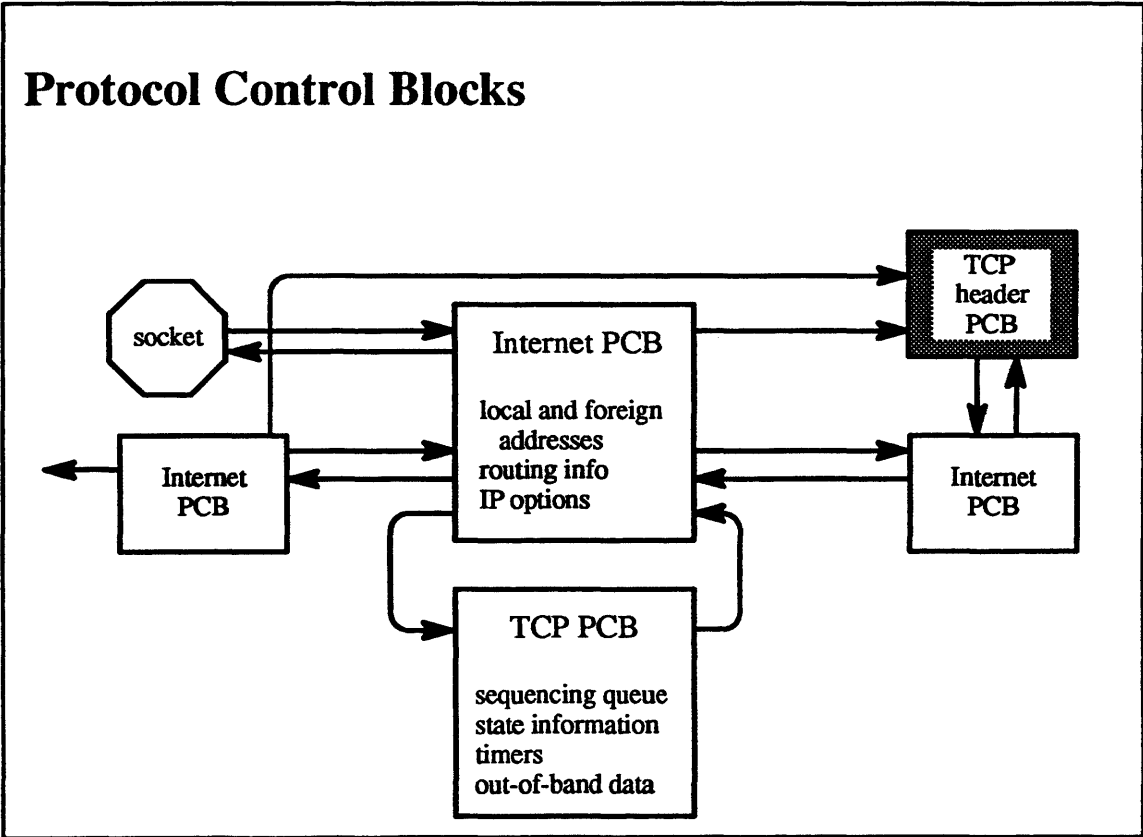

8-15.

© 1990, 1991 Open Software Foundation



## Module 8 — Sockets

---

### Student Notes: Protocol Control Blocks

This picture illustrates the protocol control blocks used by TCP/IP. Each connection is represented by a pair of protocol control blocks: an Internet PCB and a TCP PCB. The Internet PCBs of all the active TCP connections are doubly linked (necessitating a sequential search to associate a packet with a connection).

### 8-16. Implementation

#### Parallelizing TCP/IP

- Each domain may supply a *funnel* to specify processor constraints
  - the OSF/1 implementation of the Internet protocols has no such constraints
- Blocking locks on *socket* and *Internet PCB* structures, simple locks on *interface queues*

## Module 8 — Sockets

---

### Student Notes: Parallelizing TCP/IP

Associated with each family of protocols (*domain*) is a *funnel* structure, as discussed on page 2-103..

The Internet family of protocols (TCP/UDP/IP, etc.) have been parallelized. Blocking locks are in the *socket* and *Internet PCB* structures. The locking order is first to acquire the *socket lock* and then, when necessary, acquire the *Internet PCB* lock. Since these locks are blocking locks, they must be acquired by threads.

Simple locks are used on data structures such as the interface queues, which must be accessed in the interrupt context.

# Module 8 — Sockets

## 8-17. Sockets and Streams

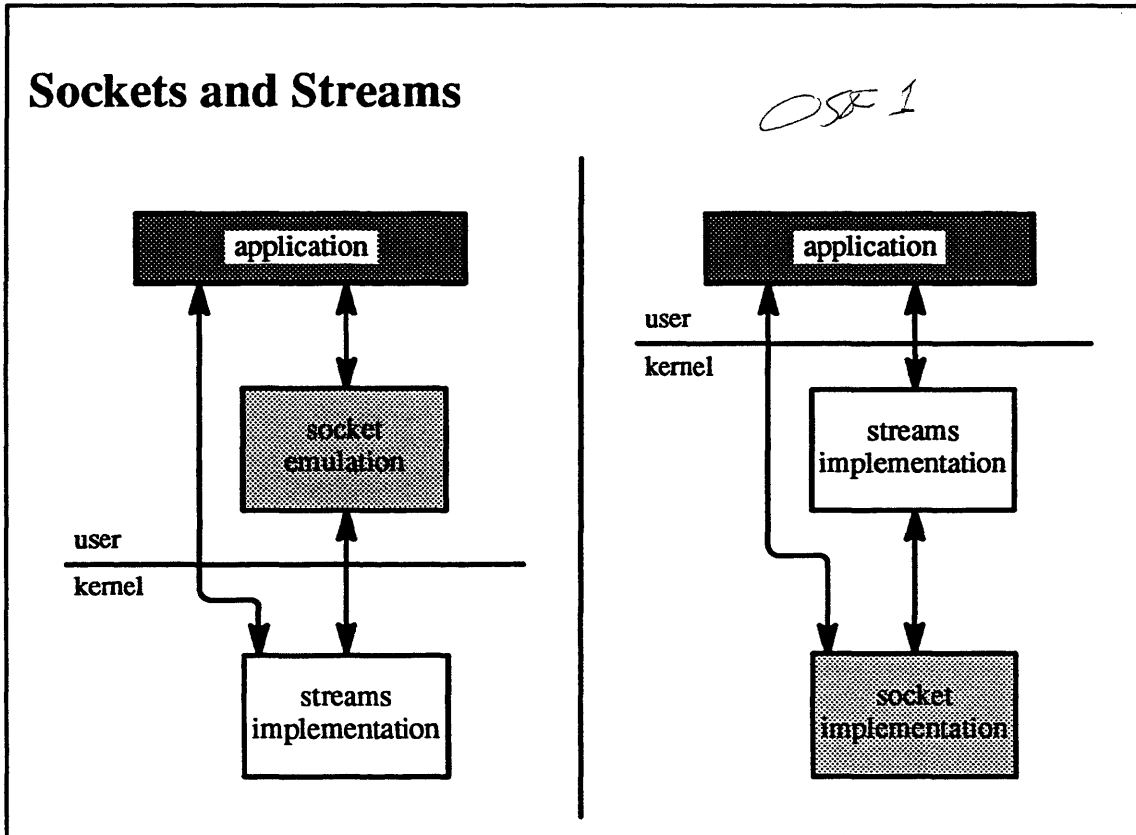

8-17.

© 1990, 1991 Open Software Foundation

## Module 8 — Sockets

---

### Student Notes: Sockets and Streams

A perhaps unfortunate fact of life is that there are two competing network interfaces: streams and sockets. There are probably more applications currently built on sockets than on streams, but this may be changing. A modern UNIX system should be able to support both interfaces.

SVR4 does so by providing a socket emulation library (in user mode). OSF/1, which supports both sockets and streams in the kernel, has no need for an emulation library, but instead provides a means whereby a protocol implemented in the socket framework can be accessed via the streams interface.

# Module 8 — Sockets

## 8-18. Sockets and Streams

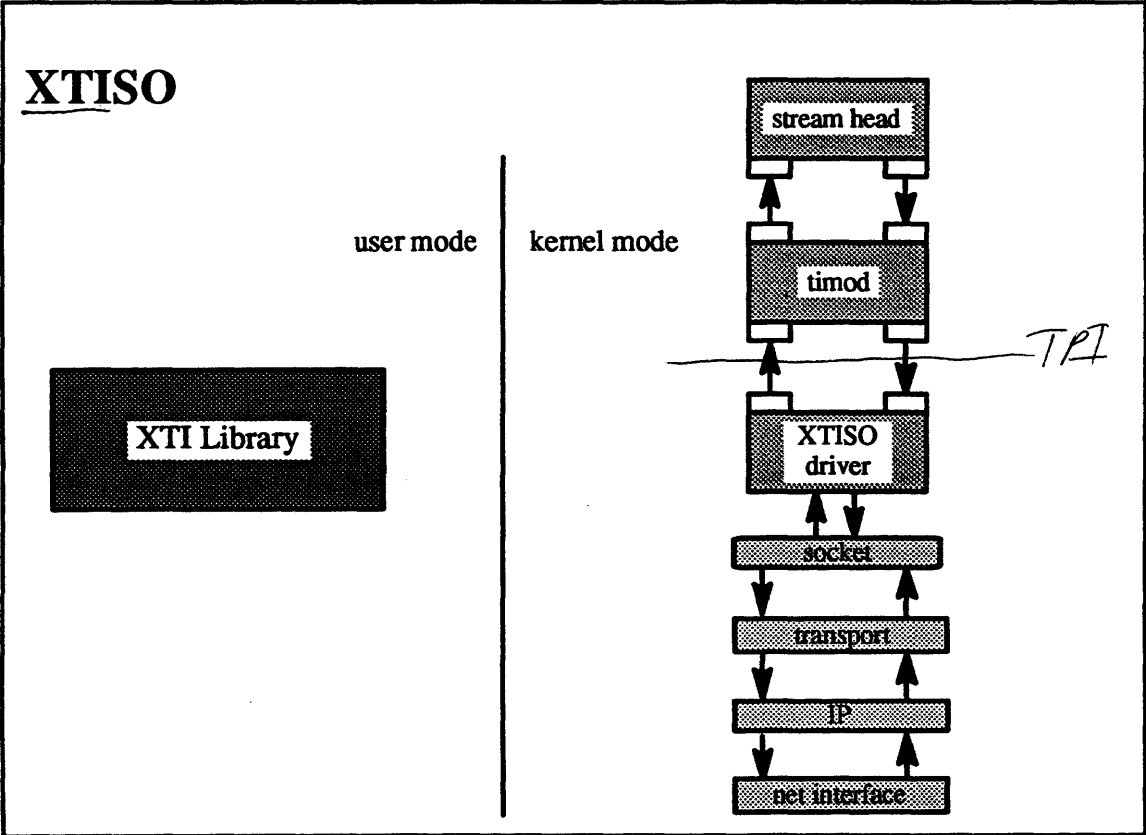

8-18.

© 1990, 1991 Open Software Foundation

## Module 8 — Sockets

### Student Notes: XTISO

XTISO (X/Open Transport Interface to Sockets) is a technique for supporting a streams-based XTI library with a socket-based protocol implementation. The XTISO stream consists of a standard stream-head module, a fairly simple *timod* module, and the XTISO driver module, which is the interface to the socket level. The XTISO driver takes *transport interface* (TPI) messages and converts them into operations on sockets. This transformation requires converting messages represented as *mblks* into messages represented as *mbufs*. These messages are passed to the <sup>provider</sup> socket layer by calling the socket code as if a socket system call had just been made.

Messages coming up from the transport layer are queued on the socket's *receive* queue. Normally the next step is to wake up any process waiting for this message. What happens instead is that the XTISO driver's *read service* procedure is enabled. This procedure is called to pull messages represented as *mbufs* from the socket's *receive* queue, converts them into messages represented as *mblks*, and converts these into a TPI message which is sent upstream.

The *timod* module converts messages sent to it from the XTI library via the stream head into the TPI format. This conversion primarily involves changing IOCTL-type messages into PROTO-type messages. Upstream messages are converted from PROTO-type into IOACK-type as required.

## Module 8 — Sockets

---

### Exercises:

1. What are the differences between communication through datagram sockets and communication through streams sockets?
2.
  - a. Why do some *mbufs* contain data while others point to data that is external to the *mbuf*?
  - b. How is it determined whether any *mbufs* refer to a buffer?
  - c. List the set of actions that may be taken when the list of free *mbufs* is exhausted.
3.
  - a. How are kernel threads used in the socket and networking subsystem?
  - b. Which socket/networking data structures need locks? What types of locks are required? What is the precedence relation of these locks?
4. How does the XTISO driver serve as an interface between streams and sockets?



# Module 9 — Logical Volume Manager

---

## Module Contents

1. Role of the LVM .....	9-4
Physical volume spanning	
Mirroring	
Logical volume resizing	
Bad-sector remapping	
2. Data Structures .....	9-12
Logical volumes	
Physical volumes	
3. Components and Flow of Control .....	9-26
Request serialization	
Consistency management	
Logical-to-physical mapping	
Request scheduling	
Handling bad sectors	

## Module Objectives

In order to demonstrate an understanding of the concepts and implementation of the logical volume manager, the student should be able to:

- list the functionality provided by the LVM but not provided by the standard file systems and disk device drivers
- explain how the LVM can be certain that it has an accurate description of a volume group, even when some of the underlying physical volumes are inaccessible
- list the benefits of mirroring

# Module 9 — Logical Volume Manager

## 9-1. The Big Picture

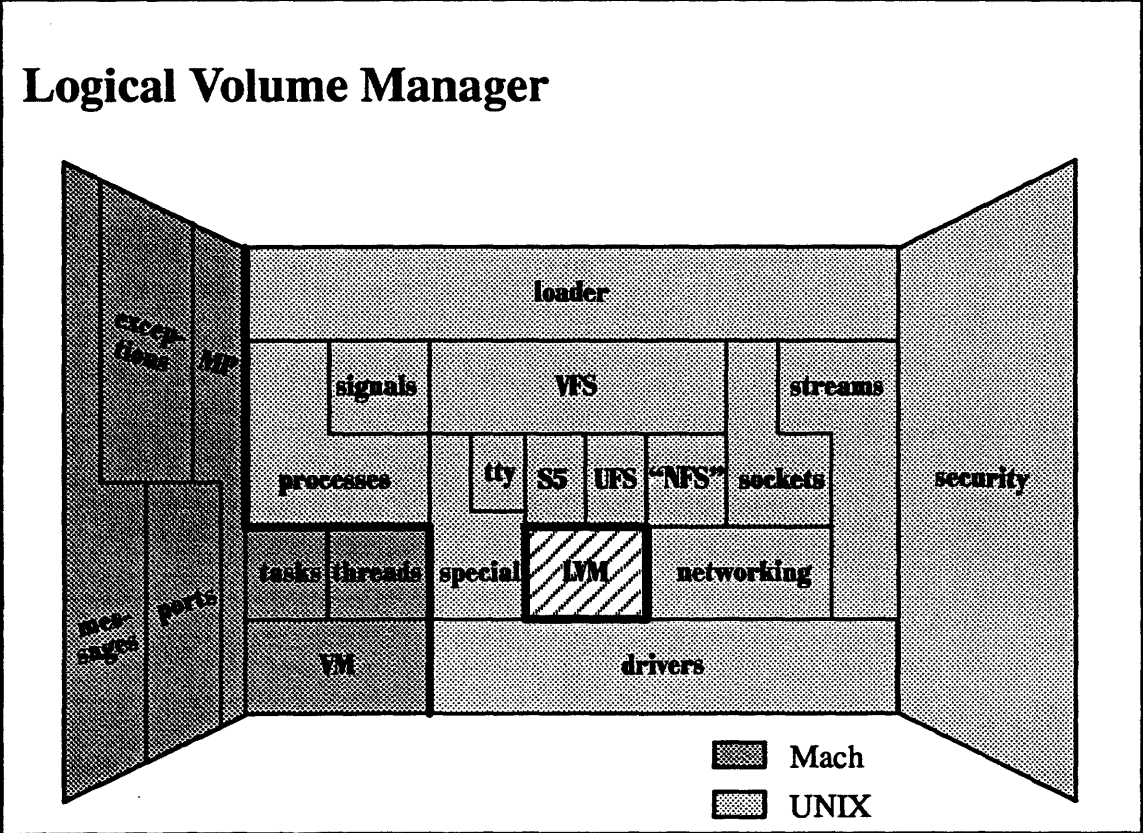

9-1.

© 1990, 1991 Open Software Foundation

## **Module 9 — Logical Volume Manager**

---

### **Student Notes: Logical Volume Manager**

This material is discussed in chapter 15 of Open Software Foundation, 1990a.

## Module 9 — Logical Volume Manager

### 9-2. Role of the LVM

#### Logical Volume Manager (LVM)

- A layer fitting between physical volumes and file systems
  - presents a device-driver interface to the file system
- Provides the notion of a logical volume:
  - logical volumes may span multiple physical volumes
  - logical volumes may be mirrored on multiple physical volumes
  - logical volumes may grow and shrink under the control of the administrator
  - logical volumes support software bad-sector remapping

9-2.

© 1990, 1991 Open Software Foundation

IBM-AIX

## Module 9 — Logical Volume Manager

---

### Student Notes: Logical Volume Manager (LVM)

UNIX files have always been limited by their inability to span multiple volumes. Since logical volumes can span multiple physical volumes, this restriction is pretty much removed in OSF/1.

# Module 9 — Logical Volume Manager

## 9-3. Role of the LVM

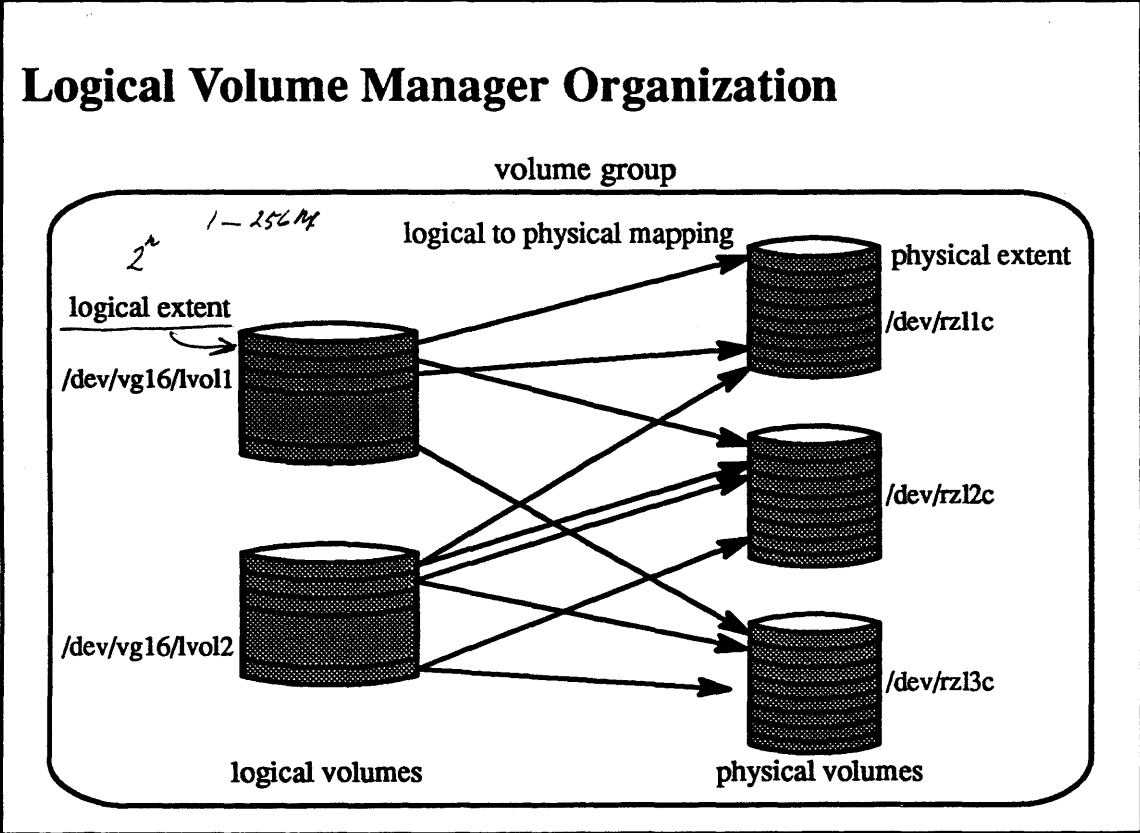

9-3.

© 1990, 1991 Open Software Foundation

## Module 9 — Logical Volume Manager

### Student Notes: Logical Volume Manager Organization

Logical volumes are organized within *volume groups* that contain both logical volumes and physical volumes. Logical volumes are divided into *logical extents*, the size of which may be any power of 2 between 1Mb and 256Mb. Each logical extent is mapped to one, two, or three *physical extents* on physical volumes. The size of physical extents is equal to the size of logical extents, which is the same throughout a volume group. Logical volumes appear to be real devices to most of the system, so they have a name as a special file within the /dev directory.

Each logical volume contains a single file system. The size of the logical volume may be easily changed by adding or removing logical extents and associating with them physical extents. In OSF/1 release 1, neither the S5 nor the UFS file system supports the notion of growth or shrinkage in a file system's underlying volume. However, in OSF/1 release 1.1 these file systems will be "growable."

If set up properly, the organization of logical volumes will not interfere with the organization of the UFS file system. Each UFS file system is built with the assumption that each cylinder group is composed of contiguous cylinders, but there is no built-in assumption that adjacent cylinder groups are actually near one another. Thus the UFS disk-allocation strategies will continue to work as long as cylinder groups do not cross logical extent boundaries.

# Module 9 — Logical Volume Manager

## 9-4. Role of the LVM

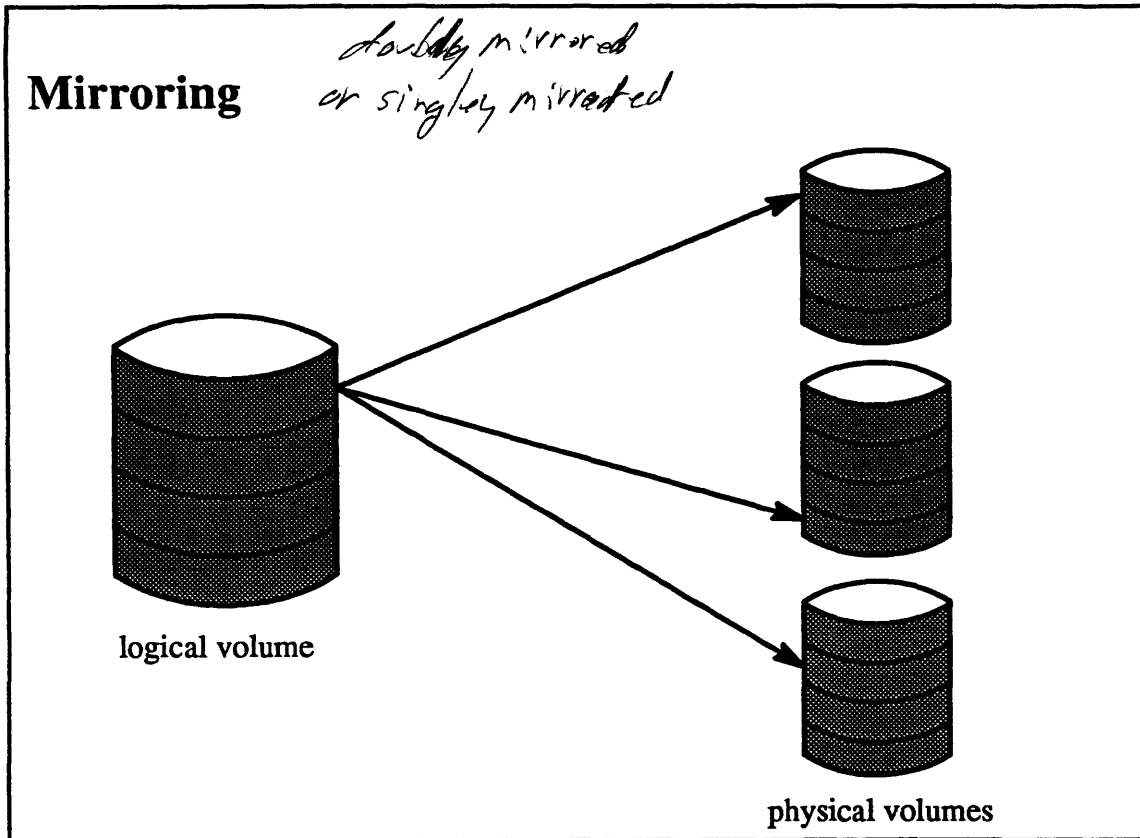

9-4.

© 1990, 1991 Open Software Foundation



## Module 9 — Logical Volume Manager

---

### Student Notes: Mirroring

There are two motivations for *mirroring*: speed and crash recovery.

Mirroring can be used to speed *read accesses* to a logical volume: read requests to a mirrored logical extent can be translated into reads of a physical extent on the least busy physical volume. This approach is particularly useful for logical volumes that are “read-mostly,” such as a logical volume containing binaries.

Most importantly, disk mirroring provides sufficient redundancy to survive crashes. If a physical volume is lost, the data contained in it can be recovered from copies maintained in other physical volumes—the mirrors. It is very important to insure that all mirrors containing the same data are identical. If an update was in progress at the time of a crash, only one mirror may have been updated. Recovery procedures are needed to reestablish the consistency of the data. Since it may not be known which mirror is the most recent, the recovery procedures select one mirror and copy it to the others. Thus the primary goal of recovery is to regain consistency among the mirrors.

### 9-5. Role of the LVM

#### Bad Sector Remapping

- Augments remapping provided by the device and its driver
- Hard errors
  - offending sector is remapped
  - sector copied from mirror if possible
- Soft errors
  - offending sector is verified and remapped if necessary

## Module 9 — Logical Volume Manager

---

### **Student Notes: Bad Sector Remapping**

The logical volume manager (LVM) augments the bad-sector remapping provided by the hardware. For mirrored volumes, the LVM can fix newly detected bad sectors by relocating the sector, reading the mirror, and writing the data into the relocated sector.

If a “soft” read error occurs (an error that was detected and corrected by the disk controller), the data is rewritten and verified. If a “hard” error now occurs, then the offending sector is remapped. Errors are not passed back to the file system unless a hard error occurs on a read from an unmirrored physical extent.

# Module 9 — Logical Volume Manager

## 9-6. Data Structures

### Logical Volume Manager: Physical Volumes

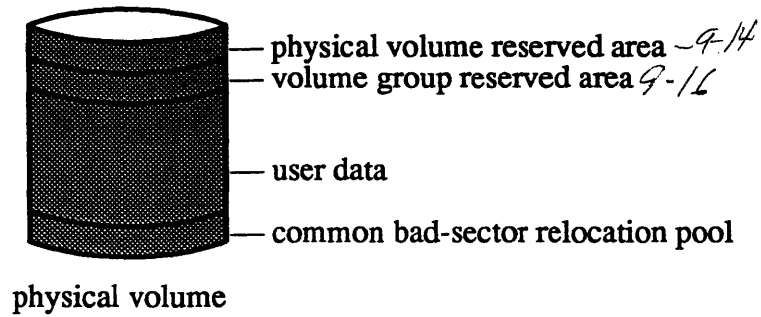

9-6.

© 1990, 1991 Open Software Foundation

## Module 9 — Logical Volume Manager

---

### Student Notes: Logical Volume Manager: Physical Volumes

A *physical volume* may be either an entire physical disk or a portion of a partitioned disk. That is, physical drives may be partitioned as they have always been in UNIX, or volume groups can effectively partition the physical volumes. By physical volume, from here on, we mean either a portion of a partitioned disk drive or the entire disk drive, depending upon how the drives are organized.

A certain amount of overhead is required within each physical volume. This consists of:

- physical volume reserved area
  - this describes the individual physical volume
- volume group reserved area (VGRA)
  - this describes the entire volume group
- common bad-sector relocation pool

As an option, space for bad sectors may be reserved at the end of each physical extent. This reduces the long seeks that would otherwise be required for remapping.

# Module 9 — Logical Volume Manager

## 9-7. Data Structures

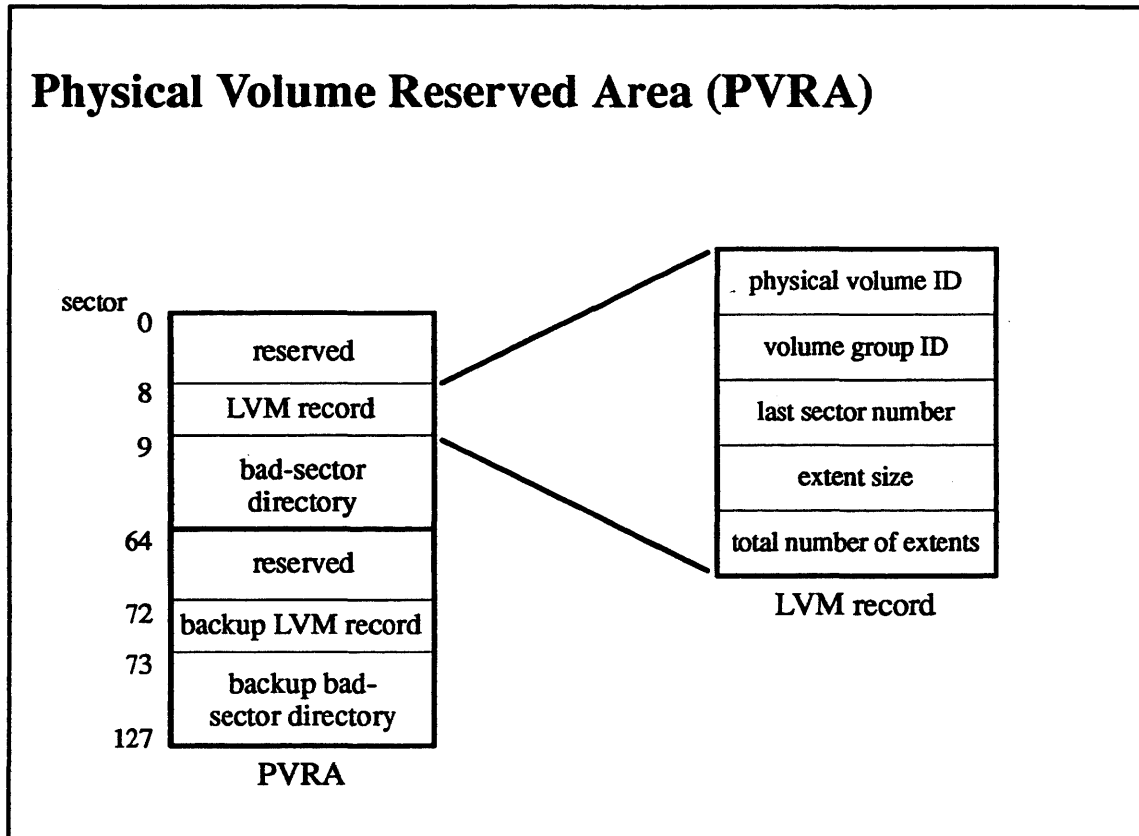

9-7.

© 1990, 1991 Open Software Foundation

## Module 9 — Logical Volume Manager

---

### Student Notes: Physical Volume Reserved Area (PVRA)

- At a fixed location on the volume (*must* be good sectors!)
- Identifies the physical volume
- Gives its size
- Gives layout of rest of volume
- Contains bad-sector directory

# Module 9 — Logical Volume Manager

## 9-8. Data Structures

### Volume Group Reserved Area (VGRA)

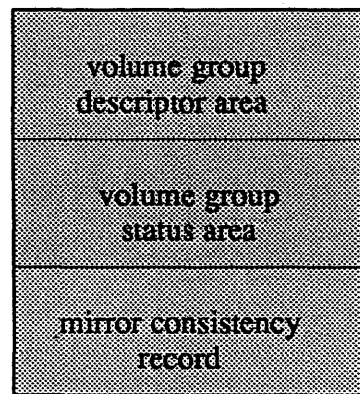

volume group reserved area



## **Module 9 — Logical Volume Manager**

---

### **Student Notes: Volume Group Reserved Area (VGRA)**

- **Volume group descriptor area (VGDA)**
  - identifies all physical and logical volumes in volume group
  - gives mapping (for entire volume group) of physical extent to logical extent
  
- **Volume group status area (VGSA)**
  - lists missing/present status of each physical volume
  - lists stale/ok status of each physical volume's physical extents
  
- **Mirror consistency record (MCR)**
  - lists updates in progress

# Module 9 — Logical Volume Manager

## 9-9. Data Structures

### Volume Group Descriptor Area (VGDA)

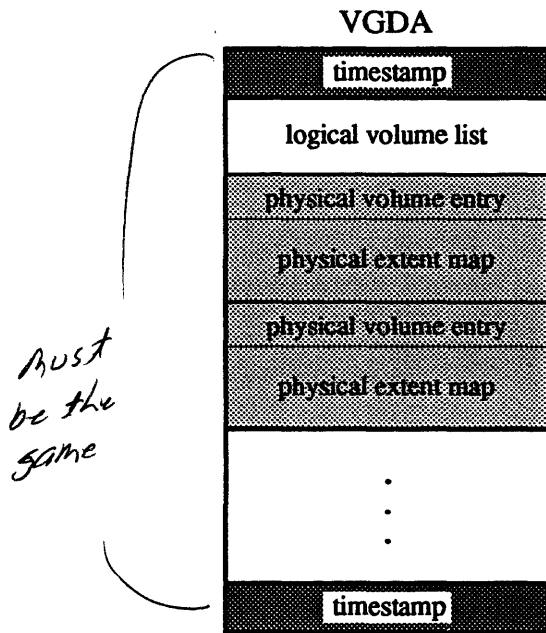

9-9.

© 1990, 1991 Open Software Foundation

## Module 9 — Logical Volume Manager

---

### Student Notes: Volume Group Descriptor Area (VGDA)

Usually each physical volume contains two copies of the VGDA, one of which is up to date. However, if there are many physical volumes in the volume group, it would be excessively redundant for each physical volume to contain copies of the VGDA, so some may have no copies of it.

Each copy of the VGDA contains a timestamp. The copy with the most recent timestamp is considered to be the valid copy. When the VGDA is to be modified, the older copy of the two (per physical volume) is modified and thus becomes the newer version. To protect against failures while updating the VGDA, two timestamps are used, one at the beginning and one at the end of the area. The sectors containing the VGDA are written out synchronously and in order. When the VGDA is read, if the beginning timestamp and the ending timestamp are not equal, then a failure must have occurred during the update, and this copy of the VGDA is invalidated.

To guarantee consistency with the volume group, a *quorum* (more than half) of physical volumes must have identical VGDA's. If such a quorum is not available (i.e. some physical volumes are "down"), then no operations are permitted that would result in updating the VGDA's.

**9-10. Data Structures**

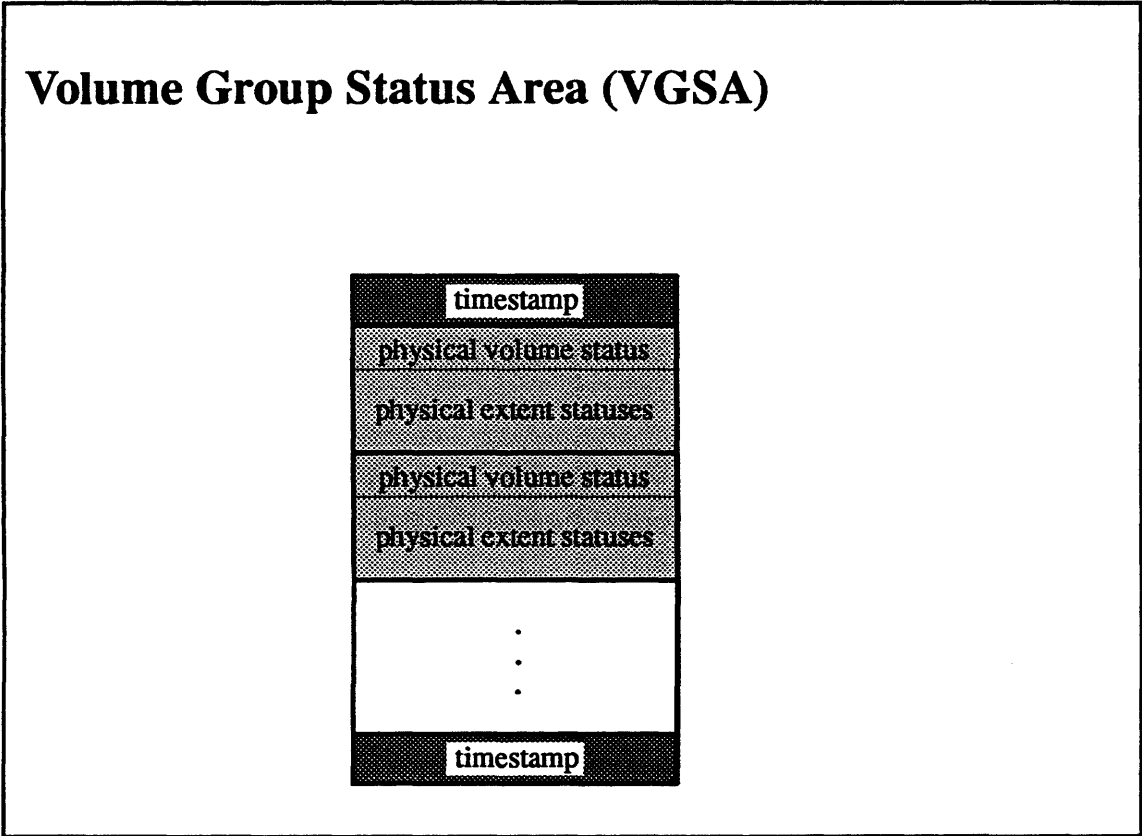

9-10.

© 1990, 1991 Open Software Foundation

## Module 9 — Logical Volume Manager

---

### Student Notes: Volume Group Status Area (VGSA)

Each physical volume that has a VGDA has two copies of a volume group status area (VGSA) indicating whether the physical volume is available or missing. Like the VGDA, each of these copies is timestamped at the beginning and end. The VGSA is of particular importance after the system resumes operation following a crash, since the system must determine which of the volumes that had been available are now missing. In addition, this area indicates, for each physical extent within each volume, whether it is stale or ok. A physical extent on an available volume marked *stale* must be made *ok* by copying into it an *ok* version of its data.

## 9-11. Data Structures

### Mirror Consistency Record (MCR)

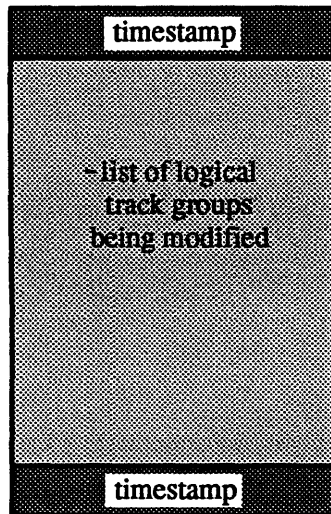

9-11.

© 1990, 1991 Open Software Foundation

## Module 9 — Logical Volume Manager

---

### Student Notes: Mirror Consistency Record (MCR)

The mirror consistency record (MCR), like the VGSA, is maintained to help restore consistency following a crash. It indicates which portions of the logical volume were being modified at the time of the crash. Each physical extent is divided into logical track groups, as will be discussed.

# Module 9 — Logical Volume Manager

## 9-12. Data Structures

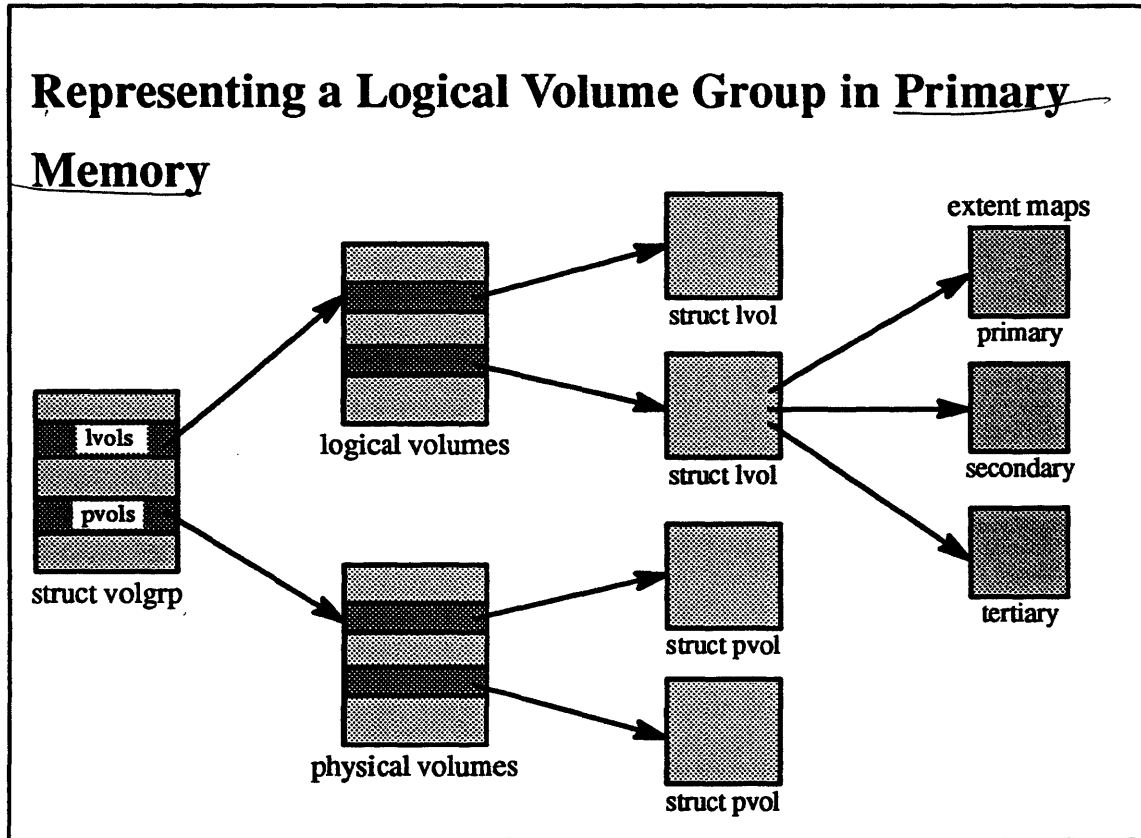

9-12.

© 1990, 1991 Open Software Foundation



## Module 9 — Logical Volume Manager

---

### Student Notes: Representing a Logical Volume in Primary Memory

The extent maps are the inverse of those provided in the VGDA's, i.e., they provide mappings from the logical extent to the physical extent.

The *struct pvols* contain status information about each of the physical volumes and their physical extents.

# Module 9 — Logical Volume Manager

## 9-13. Components and Flow of Control

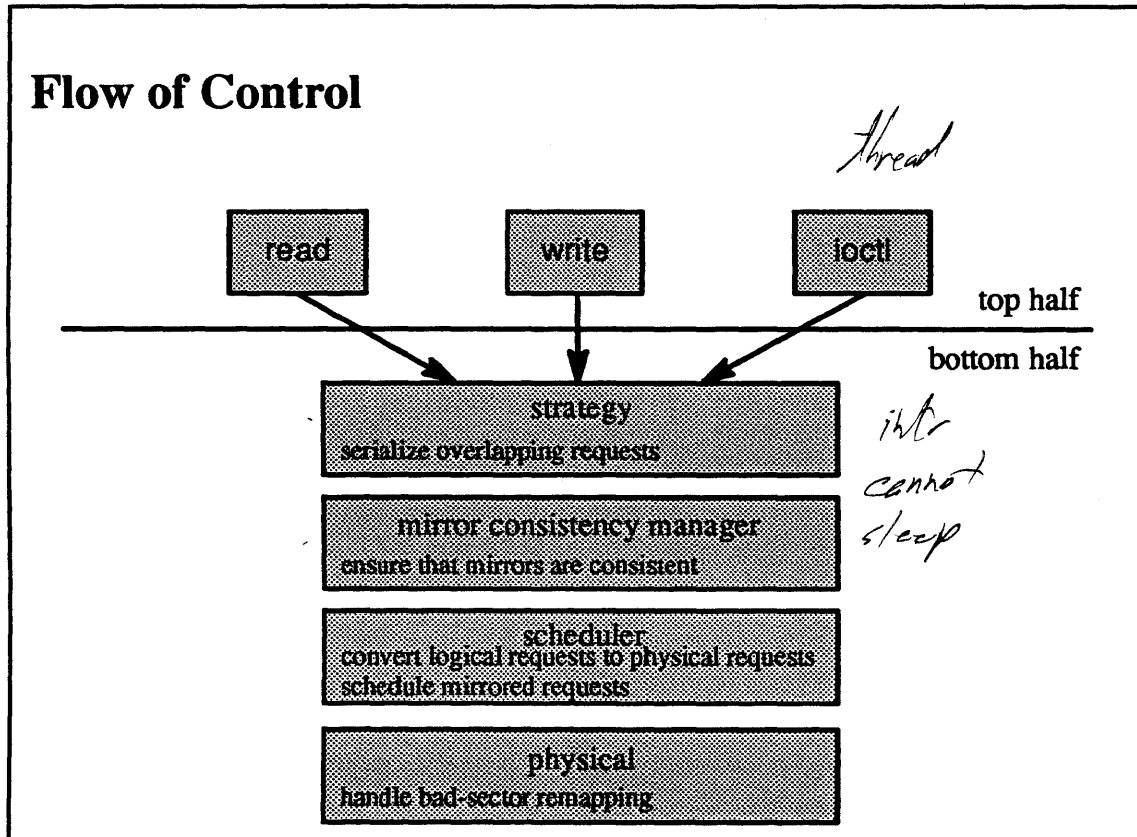

9-13.

© 1990, 1991 Open Software Foundation

## Module 9 — Logical Volume Manager

---

### Student Notes: Flow of Control

The primary purpose of the *strategy layer* is to synchronize requests with respect to changes in progress at lower levels. For example, while a sector is being relocated, the strategy layer blocks all further requests for that sector. This sort of synchronization is accomplished by *serializing* requests at the strategy layer: whenever a new request arrives, it is held up until all earlier requests to overlapping sectors have been completed. When administrative commands change information in the VGDA regarding a particular logical volume, all operations on that volume are held up until the change is complete.

The *mirror consistency manager* maintains the consistency of mirrors. It keeps a list of update operations in progress, so that it can regain consistency in the event of a crash.

The *scheduler layer* is responsible for translating logical requests into physical requests. If the logical volume is mirrored, then each logical request may correspond to two or more physical requests.

The *physical layer* is responsible for bad sector relocation. It communicates directly with the real device driver and responds to disk errors by relocating sectors.

# Module 9 — Logical Volume Manager

## 9-14. Components and Flow of Control

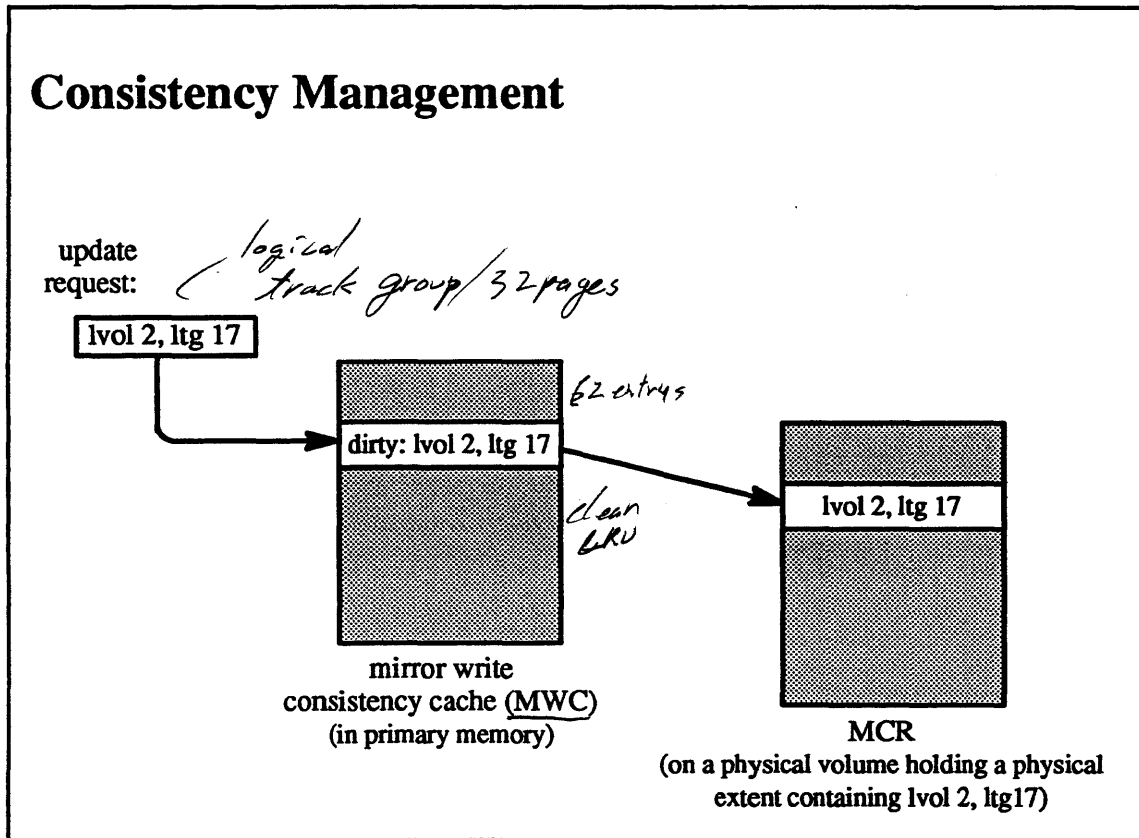

9-14.

© 1990, 1991 Open Software Foundation

## Module 9 — Logical Volume Manager

### Student Notes: Consistency Management

The basic approach to consistency management is to maintain a record on disk of the write operations currently in progress to mirrored extents. Thus, after a crash, those operations that were in progress can be identified and the mirrors involved can be made consistent with one another. A straightforward but amazingly expensive application of this approach would be to update this MCR before and after each disk write. The approach taken instead minimizes the number of extra disk writes at the expense of a longer crash recovery procedure.

An up-to-date listing of updates in progress is kept incore. The on-disk record, however, lists update operations as being in progress for some time longer than they actually are in progress.

The incore data structure for representing update operations in progress is the *mirror write consistency cache* (MWC). This cache contains 62 entries. Each active entry is marked either “clean” or “dirty”. The clean entries are arranged in LRU (least recently used) order. Whenever an update operation starts, an entry representing a *logical track group* (LTG) in a logical event is allocated in the MWC and marked “dirty”. Each physical volume contains a recent copy of the MWC called the mirror consistency record. These copies are timestamped; the copy with the most recent timestamp is the valid one. Whenever a new entry is added to the MWC, the contents of the MWC are copied to the MCR of at least one of the physical volumes involved in the update. The MCRs contain no indication of “dirty” or “clean”; thus all entries marked “clean” in the MWC are interpreted as “dirty” in the MCR.

Each physical extent is divided into logical track groups of 32 pages each, where a “page” here is the disk block size. Each entry in the MWC and the MCRs corresponds to an LTG. Before any portion of an LTG is modified, an entry for it is allocated in the MWC and marked “dirty,” and a new MCR reflecting the updated MWC is written. When the update completes (to all mirrors), the MWC entry is marked “clean” but no new MCR is written (thus if the system were to crash at this moment, the MWC would disappear and the most recent mirror consistency record would indicate that an update to this LTG is still in progress). If the LTG is updated again, then the MWC entry is changed to “dirty” but, again, no new MCR needs to be written. At some point there will be a period of no updates to the LTG, and its MWC entry will become the least recently used clean entry. When the next update request arrives for any other LTG, this entry is used to represent the new LTG and a new MCR will reflect this change, with the effect that the original LTG is no longer indicated as having an update in progress in the most recent MCR.

# Module 9 — Logical Volume Manager

## 9-15. Components and Flow of Control

### Consistency Management: Crash Recovery

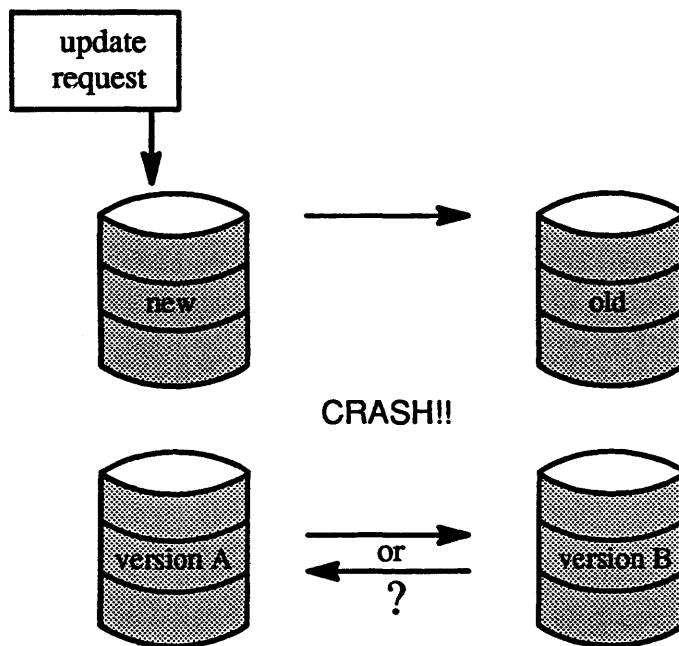

9-15.

© 1990, 1991 Open Software Foundation

## Module 9 — Logical Volume Manager

---

### Student Notes: Consistency Management: Crash Recovery

When a crash occurs, some number of update operations may be in progress. If a mirrored volume was in the process of being updated, the crash may cause the mirrors to be different. The mirror consistency manager must *restore consistency*, i.e. make mirrors identical with one another.

Crash recovery begins with locating the most recent MCR, which contains a list of the LTGs that were being modified. Since it is not known which mirror of each LTG contains the most recent information, the mirror consistency manager chooses one arbitrarily (actually, it issues a *read* request to the logical volume: the scheduler layer, using its rules for *read* scheduling, reads the data from a single LTG) and copies this LTG onto each of the others.

Another possible problem is that a physical volume may become unavailable (e.g., because of controller or media failures). This physical volume might contain only the most recent version of the MCR. If this volume was lost in a crash, then it cannot be known whether or not it contained the most recent MCR, so we must assume that it did. To cope with this, OSF/1 assumes the worst case: that *every* LTG on the volume was being modified at the time of the crash. We then must indicate that all associated mirrors may be inconsistent. This is done at the physical-extent level by marking all physical extents of this volume as “stale” in the VGSA. Then, for all logical extents that were double-mirrored, resynchronization is done by copying one of the accessible physical extents to the other (the second physical extent is also marked stale). If the logical extent was single-mirrored, then only one accessible physical extent remains, which by definition is consistent. (Due to the drastic steps taken for recovery when a physical volume becomes unavailable (e.g., an entire disk might be copied), this procedure is performed only if explicitly permitted by the operator.)

# Module 9 — Logical Volume Manager

## 9-16. Components and Flow of Control

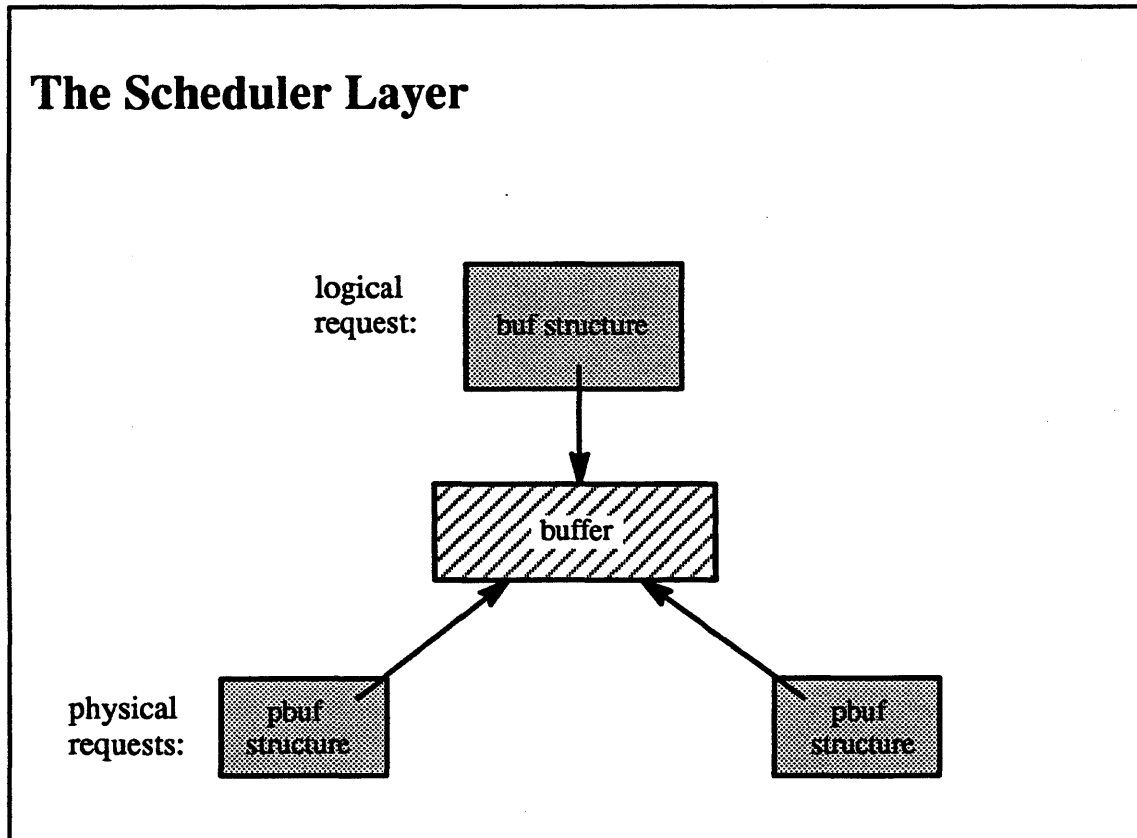

9-16.

© 1990, 1991 Open Software Foundation



## Module 9 — Logical Volume Manager

---

### Student Notes: The Scheduler Layer

The *scheduler layer* converts the logical request represented by a *buf* structure into one or more physical requests represented by *pbuf* structures. For a *write* request, all mirrors must be modified; in a *read* request it is only necessary to access a single mirror. Two general policies are used for scheduling the requests: a *parallel* and a *sequential policy*.

In the *parallel policy*, a *read* request is always sent to the physical volume with the fewest outstanding I/O operations. *Write* requests are issued in parallel to the physical volumes.

In the *sequential policy*, a *read* request is performed by attempting *reads* from mirrors in a predefined order. If the first *read* succeeds, then the operation completes; otherwise a *read* from the next physical volume is attempted, and so on. *Write* requests are performed sequentially; a *write* request to one physical volume is complete before a *write* request to the next physical volume begins.

Clearly, the parallel policy is more efficient than the sequential policy. However, the sequential policy is safer. For example, if the system crashes in the middle of an update, the updates of each of the mirrors are affected with the parallel policy, while with the sequential policy, only the update of one of the mirrors is affected.

# Module 9 — Logical Volume Manager

## 9-17. Components and Flow of Control

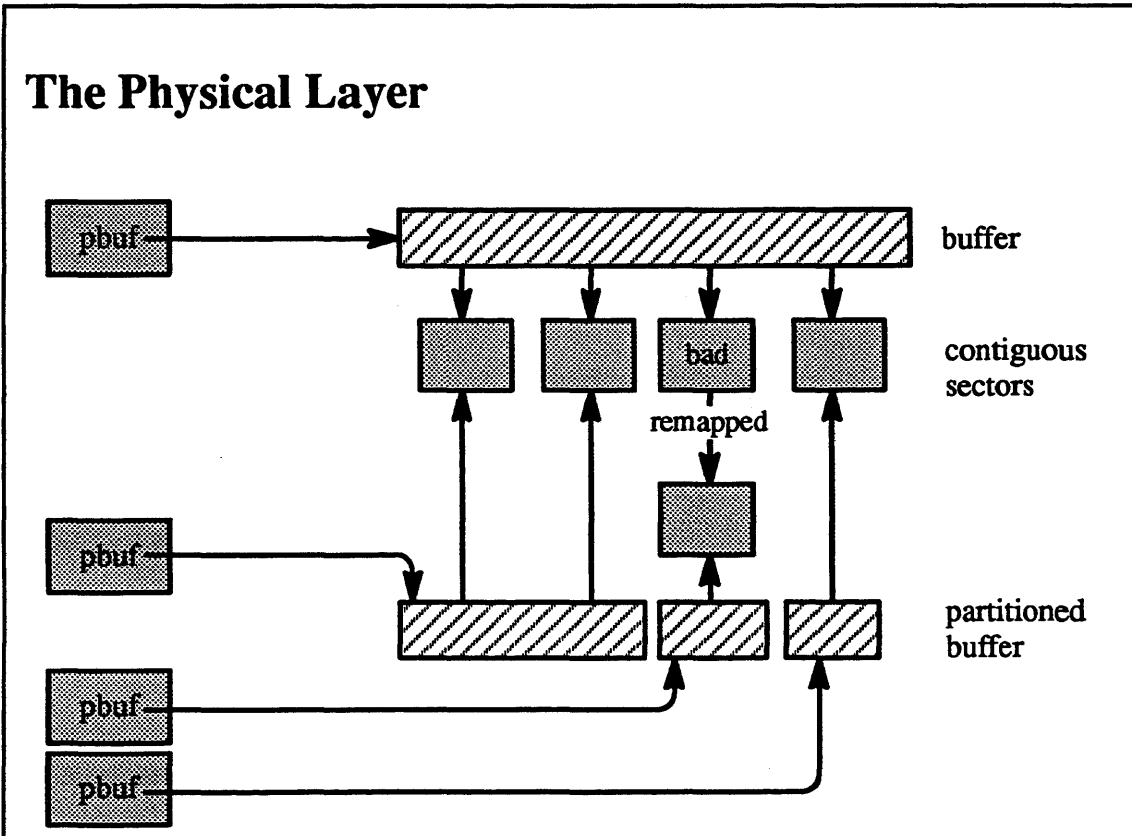

9-17.

© 1990, 1991 Open Software Foundation

## Module 9 — Logical Volume Manager

---

### Student Notes: The Physical Layer

The *physical layer's* main responsibility is to handle bad-sector remapping. It must examine each physical request for references to any known bad sectors. If a request does refer to a bad sector, then (assuming only a single bad sector for ease of exposition) the physical layer breaks the request into three pieces: the first piece for the request up to the bad sector, the second piece for the relocated bad sector, and the third piece for the remaining portion of the request. The pieces are then treated as separate requests and are processed sequentially.

The device driver detects new bad sectors during an I/O operation and reflects the error back to the physical layer. There are essentially two types of errors: soft errors and hard errors. Soft errors have been detected and corrected by the disk controller. The physical layer attempts to test the sector by sending a "write-verify" request to the disk driver. If this succeeds, then nothing else need be done. However, if it fails, the sector is remapped.

If a non-mirrored *read* operation encounters a hard error, then there is no choice but to reflect the error to the caller. However, an entry is made in the bad-block directory indicating that relocation is desired and this is done the next time this sector is written.

If a mirrored *read* operation encounters a hard error, the scheduler layer performs a *read* to a mirror, then sends a *write* request to the original sector specifying that hardware relocation is desired. The physical layer passes this on to the device driver. If hardware relocation fails or is not supported, then software relocation is performed.

## Module 9 — Logical Volume Manager

---

### Exercises:

1.
  - a. What functionality does the LVM provide that the standard file systems and disk device drivers do not?
  - b. Which LVM-related information is replicated over most of the physical volumes? Which is only maintained on a single physical volume?
2.
  - a. What is the purpose of timestamps in the on-disk data structures?
  - b. How can the LVM be certain that the volume group descriptor information is valid even when some physical volumes are inaccessible?
3.
  - a. Why is it necessary to serialize overlapping requests?
  - b. What information is contained in the MCR?
  - c. Suppose that, as part of crash recovery, it is discovered that the MCR contains a single entry and this entry pertains to a doubly mirrored volume. Assuming that all physical volumes are present, list the actions taken as part of the recovery of the logical volume group.
  - d. Explain the differences between the parallel and sequential scheduling policies.

### Advanced Question:

4. What must be changed in the UFS file system so that it can exploit the ability of logical volumes to grow?

# Module 10 — Loader

---

## Module Contents

1. Role of the Loader .....	10-4
Loader functions	
Interaction with <code>exec</code>	
Shared libraries	
2. Symbol Resolution .....	10-10
Packages and libraries	
Known package tables	
3. Data Structures and Flow of Control .....	10-18
Format-independent aspects and format-dependent aspects	
4. The Run-time Image .....	10-22
Relocation and shared libraries	
Address space layout	
5. Dynamic Loading .....	10-26
Loading into the current process	
Loading into the kernel	

## Module Objectives

In order to demonstrate an understanding of shared libraries, dynamic loading, and symbol resolution, the student should be able to:

- describe the functionality provided by the OSF/1 loader that is not provided by traditional `ld` and `exec`
- explain the role of packages in symbol resolution
- explain the phases of the run-time load procedure
- list the three techniques for implementing shared libraries and their advantages and disadvantages
- describe the differences between loading into the current process and loading into the kernel

# Module 10 — Loader

## 10-1. The Big Picture

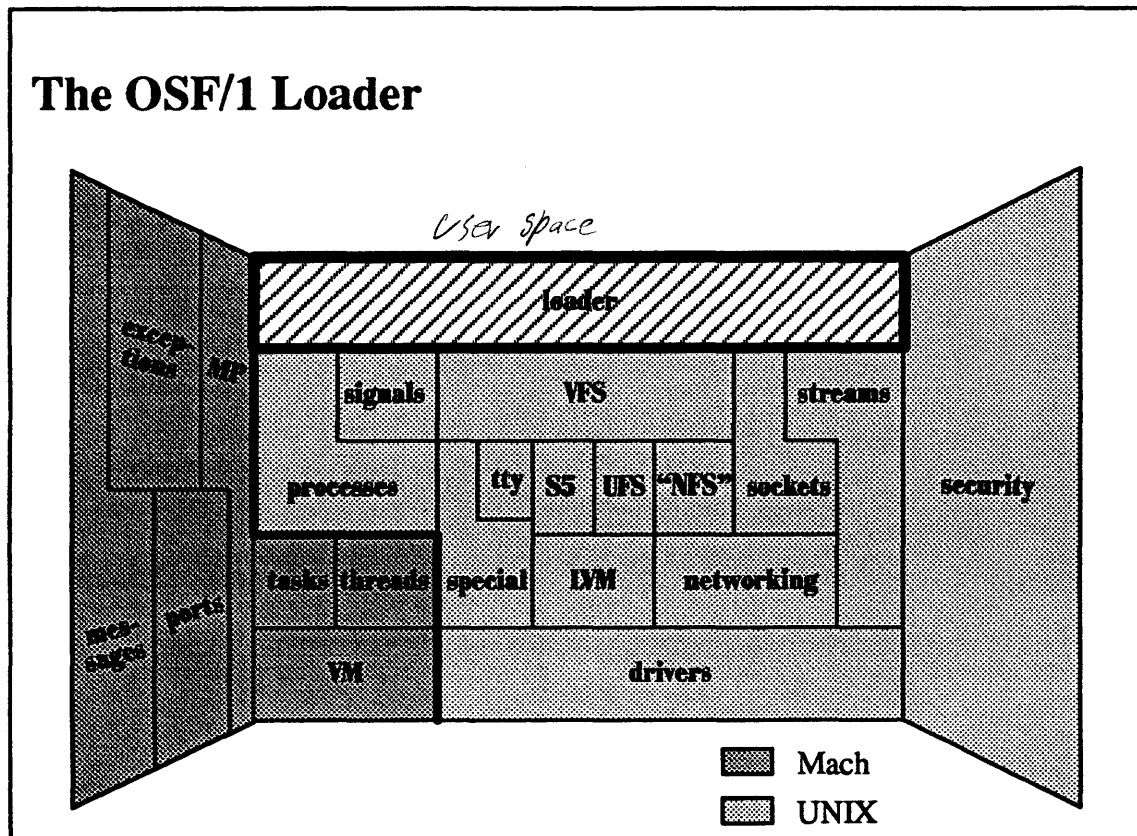

10-1.

© 1990, 1991 Open Software Foundation

## **Module 10 — Loader**

---

### **Student Notes: The OSF/1 Loader**

The material in this module is discussed in chapter 6 of Open Software Foundation, 1990a. Additional information about the OSF/1 loader can be found in Allen, 1991.

## 10-2. Role of the Loader

### Loader Goals

- Multiple load formats *① A new load fmt can be defined*  
*② Can mix different load fmts*
- Shared libraries
- Dynamic loading (via explicit call) *MULTIX*
- Dynamic kernel loading



## Module 10 — Loader

---

### Student Notes: Loader Goals

A *library* is a collection of *modules* contained in a file. A module is a component of an executable image. For example, a module might be a result of compiling or assembling a file containing a program in source form.

### 10-3. Role of the Loader

#### The exec System Call and the Loader

- Standard exec
- Run-time loader

## Module 10 — Loader

---

### Student Notes: The exec System Call and the Loader

As in any UNIX system, the `exec` system call can invoke a program. In older UNIX systems, such a program must have been fully bound and relocated. While OSF/1 certainly supports this mode of operation, the system also allows much of the binding and relocation to be postponed until run time.

When a program is `exec'd`, the system-call handler examines the program: if the program is in a recognizable load format, is fully relocated and contains no unresolved references, then it is loaded directly and control is passed to it on return to user mode (as usual). Otherwise, `exec` loads the (user-mode) run-time loader into the address space and passes control to it on return to user mode, giving it the name of the program to be loaded. The run-time loader then completes the load process. It copes with load formats unrecognized by the kernel, linking the image to shared libraries, loading additional modules as required, and relocating the entire image as necessary.

## 10-4. Role of the Loader

### Constructing an Executable Image

- Linking *ld*
  - matching symbols to packages
- Loading *exec*
  - symbol resolution
    - ◆ pull in all necessary modules
  - relocation

## Module 10 — Loader

---

### Student Notes: Constructing an Executable Image

The first step in the creation of an executable image is the construction of the component modules. These modules are created by *linking* together the object code produced by compilers and assemblers. Some of the symbols referenced in the resulting module might not be defined there, but are instead defined in some library. In older UNIX systems, the routines from the libraries that define these symbols would be copied and bound into the resulting module. With the OSF/1 loader, the linker may merely augment the symbol name with the library name (package name) that defines it, and postpone until later fetching the routine defining the symbol. Thus the result of linking is to create an *imported symbol table* that contains a list of unresolved symbol-name/package-name pairs.

The loading procedure may be completed at run time. The first step involves final *symbol resolution*. All of the packages mentioned in the imported symbol table must be tracked down and the routines containing the unresolved symbols must be extracted. This is in general an iterative procedure, since the routines so extracted may have their own imported symbol tables, causing further symbol resolution. As symbol resolution is performed, relocation is also performed.

### 10-5. Symbol Resolution

#### Packages and Libraries

- Two-dimensional name space
  - package name/symbol name
- Packages are mapped to libraries at run time
  - binaries need not contain path names

## Module 10 — Loader

---

### Student Notes: Packages and Libraries

The concept of *packages* was invented to deal with the following issues:

- symbols should not be bound to library path names, since libraries may move
- naming conflicts may occur between symbols of different libraries
- symbol resolution should be *flexible*: the user should be able to alter resolution at compile, link, and load time

Packages are the *abstraction* of libraries: they normally correspond to libraries, but the programmer is free to split a library into sub-libraries by breaking it up into a number of packages. Currently, package names are assigned to symbols only at link time, but with sufficient compiler support they could also be assigned at compile time.

# Module 10 — Loader

## 10-6. Symbol Resolution

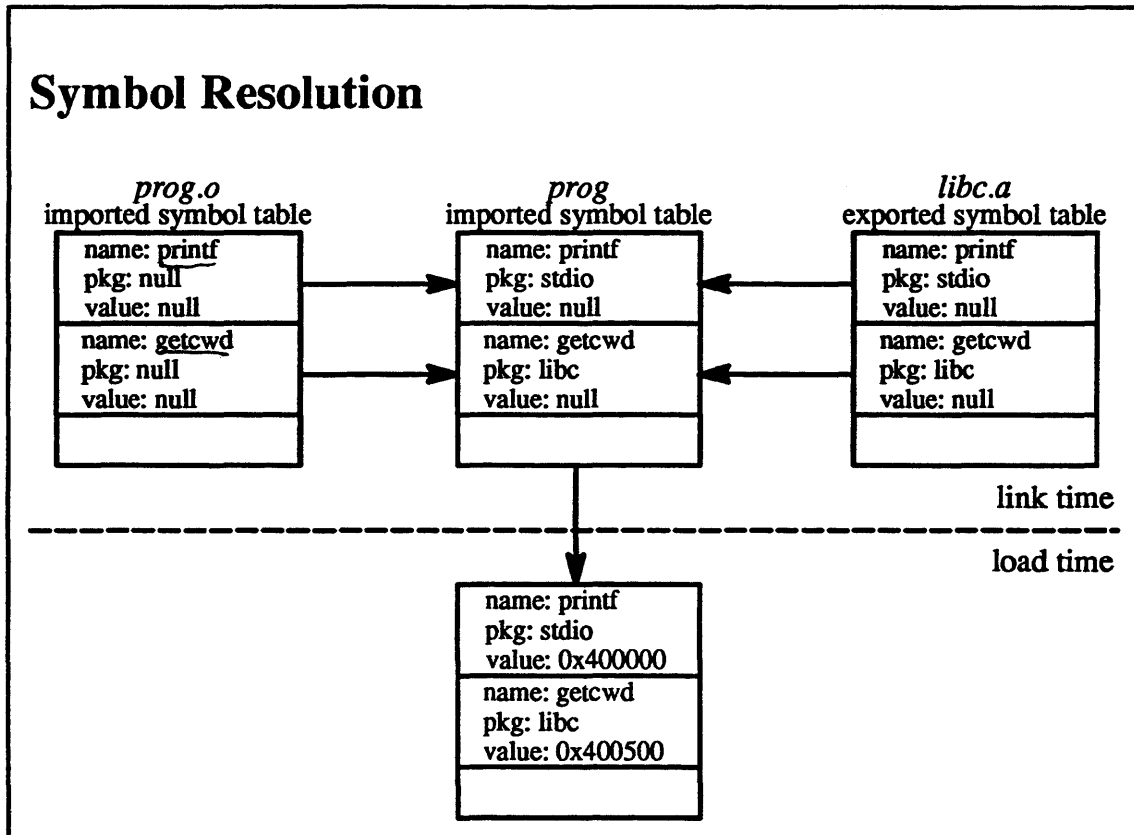

10-6.

© 1990, 1991 Open Software Foundation



## Module 10 — Loader

---

### Student Notes: Symbol Resolution

*Prog.o* is produced by the compiler. Its imported symbol table contains the names of unresolved symbols, but little is known about these symbols. At link time, the *ld* program finds definitions for the symbols in libraries, but instead of extracting the code, it augments the imported symbol table by filling in the package for each of the symbols listed. Finally, at load time, the *ld* program somehow brings the desired packages into the address space and fills in the value fields of the imported symbol tables with the addresses of the component routines.

# Module 10 — Loader

## 10-7. Symbol Resolution

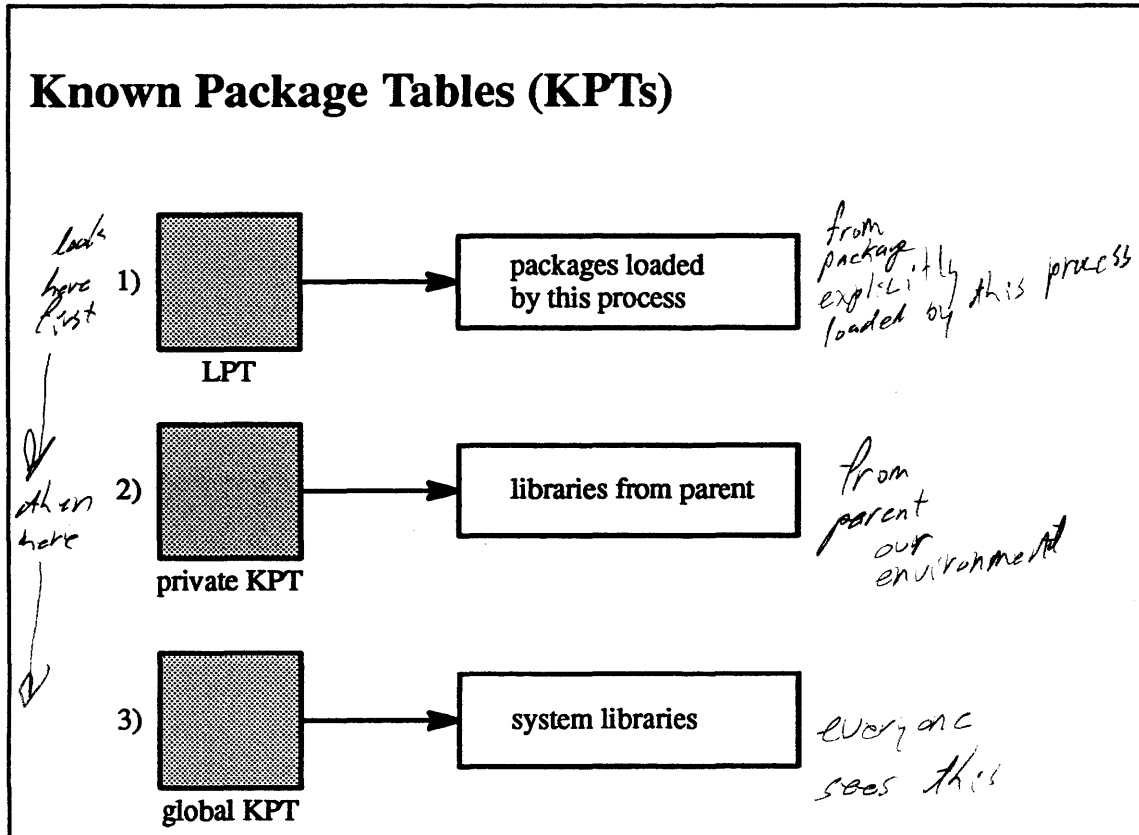

10-7.

© 1990, 1991 Open Software Foundation

## Module 10 — Loader

---

### Student Notes: Known Package Tables (KPTs)

Known package tables (KPTs) contain mappings from package names to actual code. They are used to translate a package-name/symbol-name pair into a symbol within a particular library. Each process has a sequence of KPTs which it searches to resolve a particular package-name/symbol-name pair. The order of search is:

1. loaded package table (LPT): a per-process table referring to packages from modules that have been explicitly loaded into the program; this includes the loader itself, the “main” module (whose name was given in `exec`), modules loaded because they are dependencies of other modules, and modules that have been dynamically loaded
2. private known package table (private KPT): maintained by the user and inherited copy-on-write from the parent process (this is contained in anonymous memory that is retained across `execs`)
3. global known package table (global KPT): a system-wide table maintained by the system administrator (used to define the standard system libraries)

# Module 10 — Loader

## 10-8. Symbol Resolution

### Package Substitution

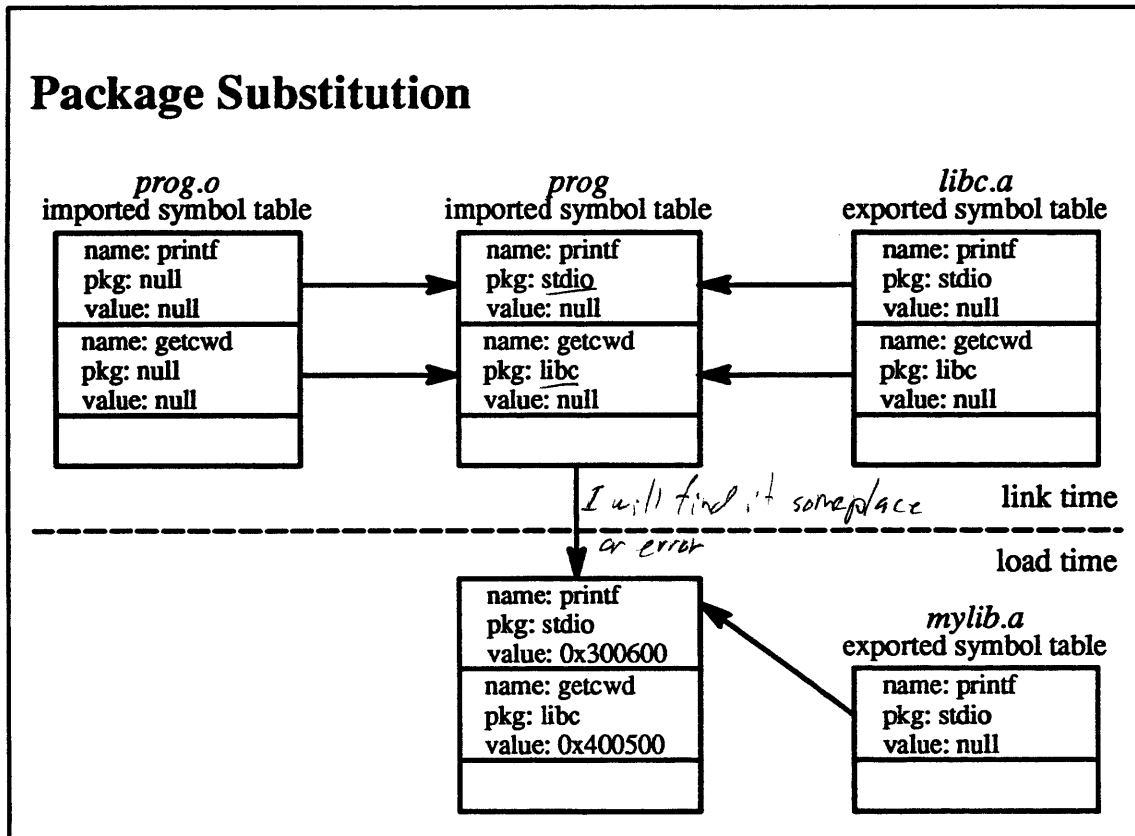

10-8.

© 1990, 1991 Open Software Foundation

## Module 10 — Loader

---

### Student Notes: Package Substitution

By modifying the contents of the private KPT, the user can effect changes in symbol resolution. In this example, by *inlibing mylib.a*, we have created a private package containing a redefinition of *printf*. Since at link time the symbol *printf* in our program has been associated with the package *stdio*, we have to call our private package *stdio* as well, so that it is used to define the *printf* mentioned in our program. Our private *stdio* package, containing only *printf*, will appear in the private package table.

At load time, since the program searches the private KPT before the global KPT, it uses the new version of *printf*. However, any reference to any other member of the standard *stdio* package is satisfied via the global KPT, since we have only replaced *printf* of the standard *stdio* package.

# Module 10 — Loader

## 10-9. Data Structures and Flow of Control

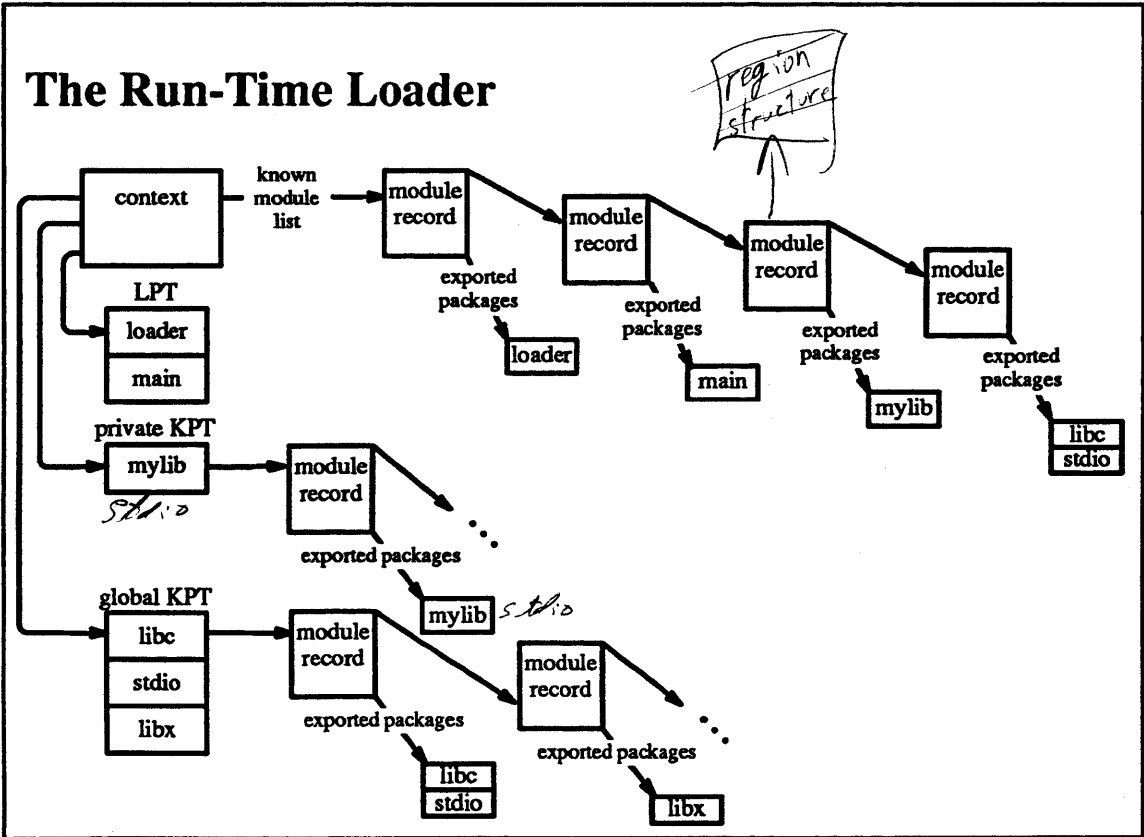

10-9.

© 1990, 1991 Open Software Foundation

## Module 10 — Loader

### Student Notes: The Run-Time Loader

This picture gives a simplified view of the data structures used by the loader. There is a *context* structure for each image maintained by the loader. Typically there will be just one context structure, representing the image in the current address space. However, the kernel loader, for example, would have a *context* structure for another image—the kernel image. The *context* structure is initialized to refer to the global KPT and the inherited private KPT. The LPT is initialized to refer to the loader itself. Each module loaded into the address space is represented by a *module record* structure, which is linked into the *known module list*, which is headed by the *context* structure. Each *module record* points to an array listing all of the packages contained in the module and made available to other modules (exported). Associated with the private and global KPTs are *module records* for each of the modules supplying packages for the associated KPT. Unlike the *module records* in the *known module list*, which contain detailed information about the module such as the imported symbol table, these *module records* only list the exported packages of the module.

Initially the *known module list* contains a *module record* for the loader. The next step is to append a *module record* for the main routine, i.e., the one given in the EXEC system call. The goal of the loader is now to build a complete *known module list*, containing all modules that are required for the image. It does this by identifying for each module record in the list the additional modules it needs and adding the record for these additional modules to the *known module list*.

The packages exported by these modules are added to the loaded package table. Modules are added to the *known module list* when they are needed to resolve symbols listed in a module's imported symbol table. *Module records* for these modules are appended to the end of the *known module list*. In some load formats, the names of these modules are supplied explicitly. The technique intended is that the symbol-name/package-name pairs given in the imported symbol table will be looked up in the loaded package tables, as discussed on page 10-15. The next step is for the loader to traverse the *known module list* and to map in (if not already mapped) the *regions* (e.g., text, data, BSS) of each module. At the same time the loader can determine the values of each module's exported symbols.

Finally, the loader traverses the *known module list* again and performs relocation in each module.

In summary, run-time loading consists of three phases:

- ① • *discovery*—locating the desired modules based upon translating symbol-name/package-name pairs to routines in libraries
- ② • *mapping*—map the modules into memory
- ③ • *relocation*—convert symbolic reference to actual addresses

## 10-10. Data Structures and Flow of Control

### Multiple Load Formats

- Format-dependent loader
  - format recognition
  - construction of imported symbol table
  - provision of exported symbol table
  - mapping of regions
  - relocation
  - unloading



## Module 10 — Loader

---

### Student Notes: Multiple Load Formats

Associated with each object format is a set of routines known as the *format-dependent loader*. Adding a new object format merely involves writing another version of these routines. The primary duties of these routines include:

1. *format recognition*: whenever the loader encounters a new module, it calls upon each of the format-dependent loaders in turn, essentially asking them “Is this one of yours?”
2. *construction of imported symbol table*: each module’s format-dependent loader is called upon to fill its imported symbol table
3. *provision of exported symbol table*: each module provides a list of exported symbols in format-dependent form. Thus each module also provides a routine to return the value of each of the symbols it defines
4. *mapping of regions*: each module’s format-dependent loader maps the regions of the module into memory as required
5. *relocation*: the format-dependent loader performs all necessary relocation
6. *unloading*: if the module is to be unloaded, the format-dependent loader performs the necessary chores

A detailed discussion on the format-dependent portion of the loader can be found in chapter 7 of Open Software Foundation, 1990b.

10-11. The Run-time Image

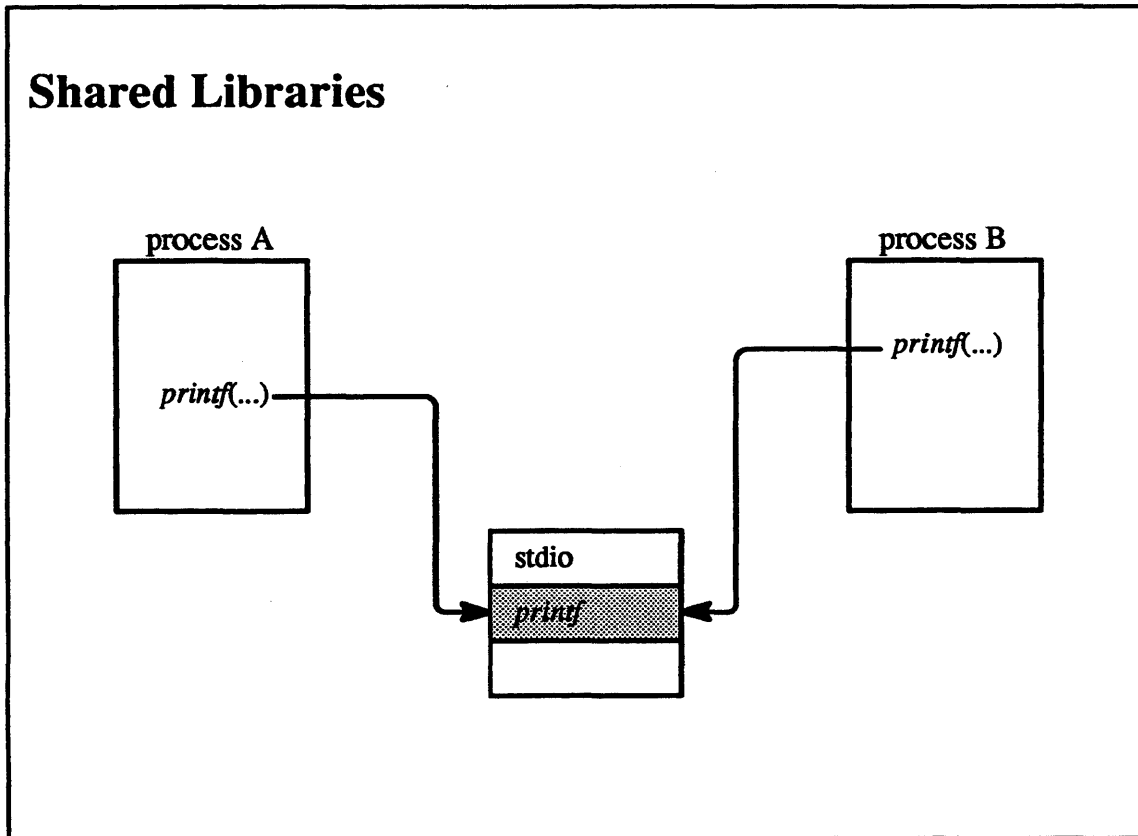

10-11.

© 1990, 1991 Open Software Foundation

## Module 10 — Loader

---

### Student Notes: Shared Libraries

Shared libraries is one of the most important features of the OSF/1 loader. There are a variety of ways to share code. The simplest is merely to map the shared routine into the address space. If relocation is required, the routine may be mapped copy-on-write and then appropriately modified to effect the relocation. However, if appreciable relocation is required, this technique cuts down on the amount of sharing that actually takes place.

Another approach is to use position-independent code (PIC) to eliminate the need for pre-relocation. This technique is not currently supported by the OSF/1 compilers, but might be supplied by vendor-supplied compilers.

What OSF/1 does is to use pre-relocated shared libraries. Such libraries are combined into a single image which is pre-relocated to fit at a fixed location in the address space. They are thus available for linking to programs without any further relocation. The standard libraries are provided in this format and are linked in this form (as described on page 10-9) with the standard UNIX commands.

Note that symbol substitution is still possible, e.g., an alternative version of *printf* can be substituted at load time for the version in the shared library. Also, because final symbol resolution can occur at load time, the locations to which shared routines have been pre-relocated can be changed without the need for relinking.

# Module 10 — Loader

## 10-12. The Run-time Image

### Typical Address Space Layout

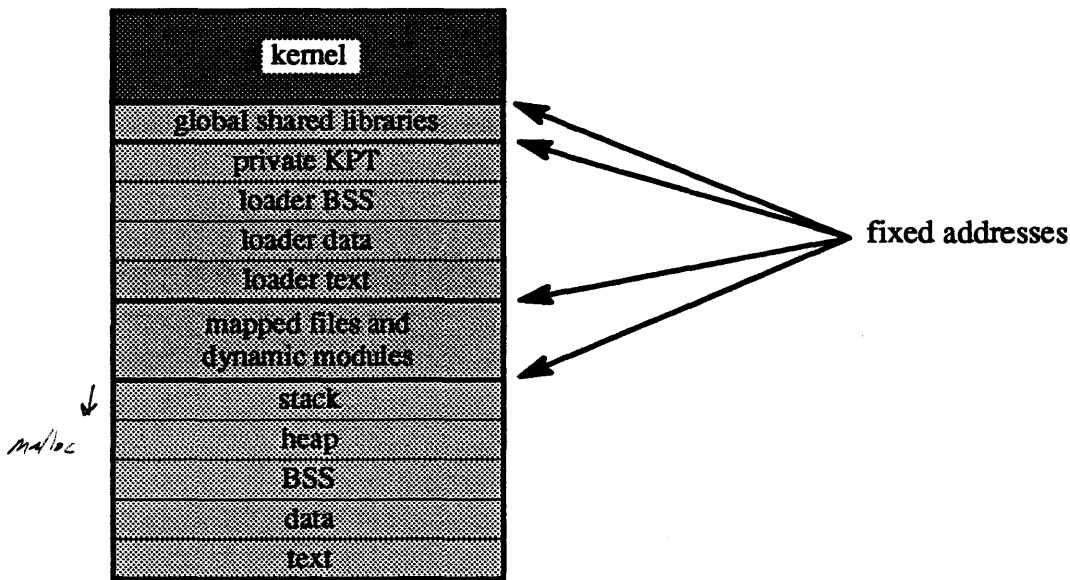

10-12.

© 1990, 1991 Open Software Foundation

## Module 10 — Loader

---

**Student Notes: Typical Address Space Layout**

**10-13. Dynamic Loading**

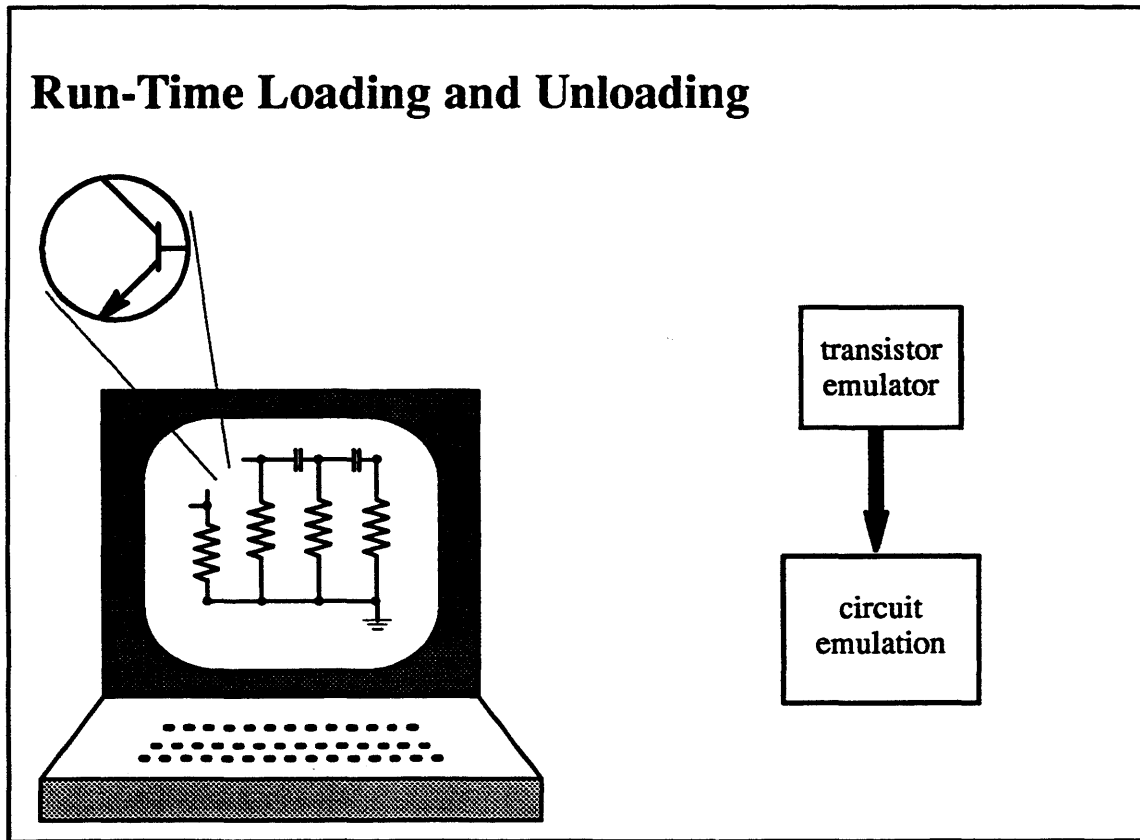

10-13.

© 1990, 1991 Open Software Foundation

## Module 10 — Loader

---

### Student Notes: Run-Time Loading and Unloading

Modules may be explicitly loaded into or unloaded from a running program. For example, a user of a CAD/CAM application might put a transistor into a diagram. The CAD/CAM application might then call upon the loader to load a transistor-emulation module into the program. If the user subsequently decides to remove the transistor from the diagram, then the CAD/CAM application would call the loader to unload the emulation module as well.

To make this possible, the run-time loader remains in the address space even after the program starts up. The user program can call the loader via its load and unload entry points; all of the loader's data structures still exist, and they are updated by the loader to reflect the presence of the new module.

### 10-14. Dynamic Loading

#### Kernel Loading

- Handled by *kernel loader server*
  - maintains loader data structures for the kernel
  - maps modules into its own address space but relocates with respect to kernel's address space
  - copies relocated module into kernel via special system call



## Module 10 — Loader

---

### Student Notes: Kernel Loading

The OSF/1 loader can be used to load modules into or unload modules from the kernel. This feature is used in conjunction with dynamic configuration to support loadable/unloadable device drivers, streams modules and drivers, file systems, and protocols. Kernel loading is managed by a privileged user-mode task, the *kernel-loader server*. This server maintains the data structures describing the kernel address space (i.e., the same types of data structures that describe a user task).

Loading into the kernel is essentially identical to loading into a user task, except that the actual loading is done remotely: modules to be loaded into the kernel are mapped into the server's address space, but are relocated with respect to their final position in the kernel address space. Special system calls perform the actual loading into the system address space (such modules go into wired memory) and call the module's *configure* routine (so that it can link itself into kernel tables).

## Module 10 — Loader

---

### Exercises:

1. What functionality is provided by the OSF/1 loader that is not provided by the standard *ld* and *exec*?
2.
  - a. Explain the role of packages in symbol resolution.
  - b. How can one replace a routine supplied by a system library?
3.
  - a. Why can't the LPT and the private KPT be combined into a single table?
  - b. Why is it necessary to separate the format-dependent loaders from the format-independent loader?
4.
  - a. List three techniques for implementing shared libraries.
  - b. Why are loader text, data, and BSS kept separate from the standard text, data, and BSS?
5.
  - a. List the actions taken to load a module into a running program.
  - b. In what ways is loading into the kernel treated differently from loading into the current process?

# Module 11 — Security

---

## Module Contents

1. Security Concerns .....	11-4
Orange-book model	
Security in OSF/1	
2. Auditing .....	11-12
3. Access Control .....	11-16
Discretionary access control	
Mandatory access control	
Implementation architecture	
4. Authorizations and Privileges .....	11-28
Representing authority	
Principle of least privilege	
Using and transferring privileges	
5. Living with Security .....	11-44

## Module Objectives

In order to understand security in the OSF/1 environment, the student should be able to:

- describe how OSF/1 is compliant with the Orange Book security model
- describe how audit information is collected
- explain how it is determined whether a particular subject has the desired access to a particular object
- explain how authorizations and privileges exceed traditional security measures

# Module 11 — Security

## 11-1. The Big Picture

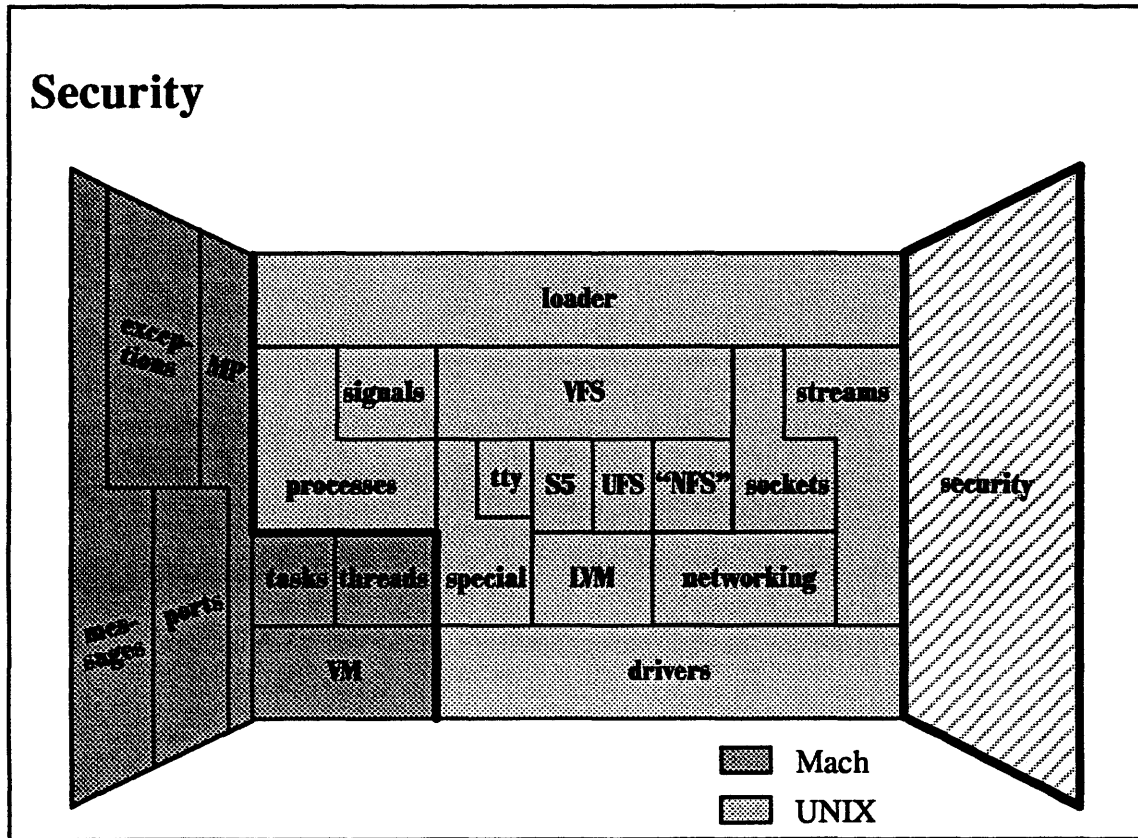

11-1.

© 1990, 1991 Open Software Foundation

## **Module 11 — Security**

---

### **Student Notes: Security**

This material is discussed in chapter 16 of Open Software Foundation, 1990a.

## 11-2. Security Concerns

### Security Concerns

- Protect *objects* from *subjects*

— subjects: users and processes

— objects: files and processes

— potential evil doers  
" victims

## **Module 11 — Security**

---

**Student Notes: Security Concerns**

## 11-3. Security Concerns

### The “Orange Book” Model

- division D: minimal protection *fail*
- division C: discretionary protection
  - class C1: discretionary security protection — *most UNIX systems people like each other*
  - OSF* — class C2: controlled access protection — *stronger passwords & auditing*
- division B: mandatory protection — *people don't like each other*
  - class B1: labeled security protection
  - class B2: structured protection
  - class B3: security domains
- division A: verified protection *pushing state of the art*
  - class A1: verified design



# Module 11 — Security

## Student Notes: The “Orange Book” Model

The U. S. Department of Defense (DoD) trusted-computer-evaluation criteria, known as the “Orange Book” model (so called because of the color of its cover), define criteria for classifying computer systems according to their degree of protection.

Division D contains those systems whose security features have been evaluated and have flunked.

Division C, a very minimal level of security, contains two classes. To be in class C1, a system must provide controls so that users can protect private information and keep others from *accidentally* reading or destroying data. The model is of cooperating users processing data at the same levels of security. Most UNIX systems should fit within this class easily.

To be in class C2, a system must meet all of the requirements for class C1 and, in addition, users of the system must be individually accountable for their actions through login procedures, auditing, and resource isolation. UNIX systems may relatively easily aspire to be in this class.

If a system is certified to be in division B, then it must be realistically considered secure. To be in class B1, a system must meet all the requirements for class C2. In addition, it must have an informal statement of the security model and must provide data labeling and mandatory access control over named subjects and objects. The capability must exist for accurately labeling exported information (e.g., in a defense environment, Top Secret printouts must be clearly labeled as such).

To be in class B2, a system must meet all the requirements for class B1 but, instead of an informal statement of the security policy model, there must be a clearly defined and documented *formal* security policy model. The discretionary and mandatory access controls of B1 must extend to *all* subjects and objects, much more thorough testing and review is required, and very stringent configuration management controls are necessary.

To be in class B3, a system must meet all requirements for class B2. In addition, its trusted computing base (TCB), i.e. that portion of the system that runs in privileged mode, must be small enough to be subjected to rigorous analysis and test. All accesses of subjects to objects must be mediated, the system must be tamper-proof, a security administrator must be supported, audit mechanisms must be expanded to *signal* security-relevant events, and detailed system recovery procedures must be in place.

The primary difference between class A1 and class B3 is that the formally specified design must be formally verified. Going beyond class A1, if such classes were defined, might involve a formally verified implementation, which is considered beyond the state of the art.

## 11-4. Security Concerns

### Compliant vs. Certified

- Certification requires a (lengthy) formal evaluation process
  - platforms, not operating systems, are certified

## Module 11 — Security

---

### Student Notes: Compliant vs. Certified

Certification requires a formal evaluation process. It is not merely the operating system that is being evaluated, but also the implementation of the operating system on a particular architecture with a given set of options. OSF supplies most of the voluminous documentation required for certification.

The “Orange Book” criteria are strictly for stand-alone systems. A system that is networked cannot be secure under these criteria. Thus, for example, a B1-certified system cannot contain NFS.

## 11-5. Security Concerns

### Security in OSF/1

- OSF/1 can be compiled to be C2-compliant, B1-compliant, or neither
- Components:
  - auditing C2
  - discretionary access control (DAC) B1
  - mandatory access control (MAC) B1
  - authorizations and privileges B1

## **Module 11 — Security**

---

**Student Notes: Security in OSF/1**

## 11-6. Auditing

### Auditing

- system calls
  - I/O
  - exec
  - fork
  - etc.
- user events
  - login
  - su
  - etc.

## Module 11 — Security

---

### Student Notes: Auditing

Auditing may be used selectively; i.e., under the control of the system administrator, selected system calls and user events may be recorded.

Stub routines inserted in the control path collect information for system calls. The status of each system call is maintained in the *audit\_info* structure, which is allocated on the kernel stack. When an audited system call completes, the *audit\_info* structure is put into a buffer maintained by the *audit device driver*. This driver makes the information available to the *audit daemon*, which compacts it and stores it in a database.

# Module 11 — Security

## 11-7. Auditing

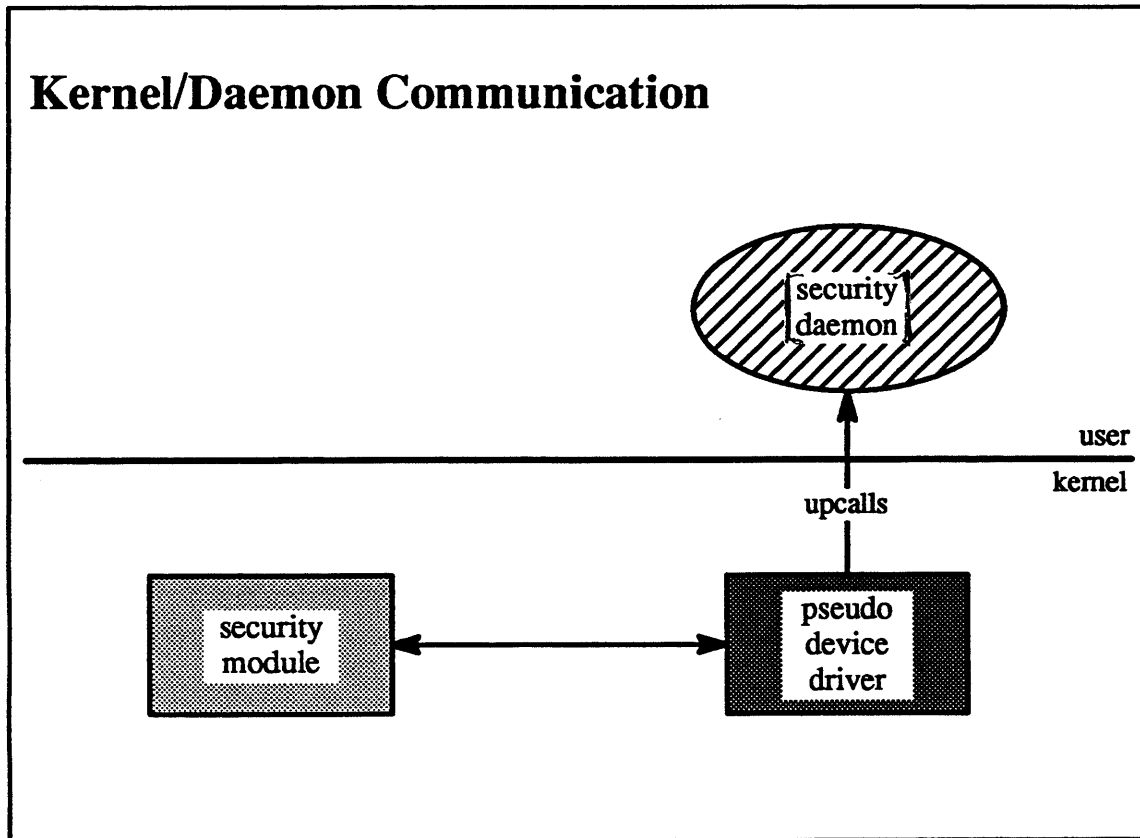

11-7.

© 1990, 1991 Open Software Foundation



## Module 11 — Security

---

### Student Notes: Kernel/Daemon Communication

A fair amount of the processing performed by the security system is done within user-level *daemons*. The security architecture was designed for general UNIX systems: it does not assume the communication facilities of OSF/1. Thus communication between the daemons and the kernel must be implemented in a way that can be easily ported to any UNIX system. The interface chosen is that of a *pseudo device*. The security daemons may perform standard *read*, *write*, and *ioctl* system calls on their associated pseudo devices. These devices are represented in the kernel as *pseudo-device drivers*.

*Upcalls*, e.g. requests sent to the daemons by the kernel, are implemented by having the daemon make a *read* system call. The call blocks until the pseudo-device driver has an *upcall* to make. When the *read* returns in the daemon, the result contains the *upcall* request.

## 11-8. Access Control

### Discretionary Access Control (DAC)

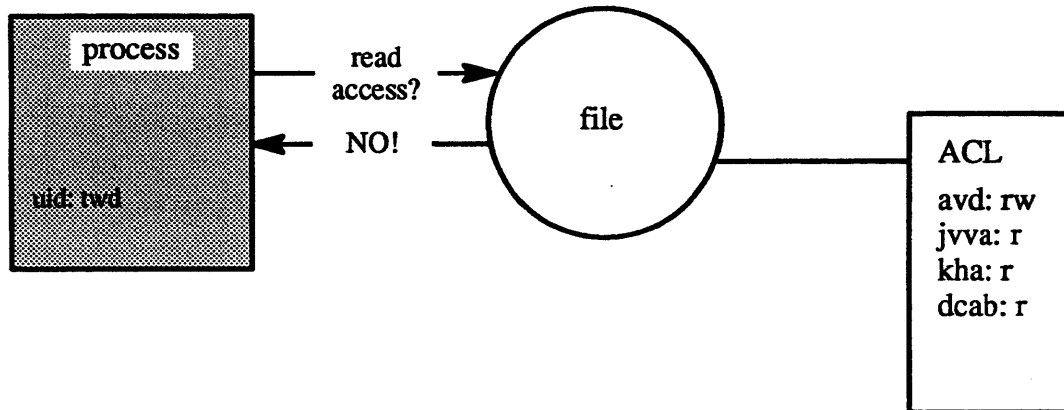

11-8.

© 1990, 1991 Open Software Foundation

## Module 11 — Security

### Student Notes: Discretionary Access Control (DAC)

By *discretionary access control* we mean the ability of an object's creator/owner to specify who has what sort of rights to the object. In OSF/1, the traditional UNIX security policy (a discretionary policy) has been augmented with the use of access control lists (ACLs). Associated with each object (i.e. file) is a list of all users allowed to access it and what their access rights are. ACLs extend the normal UNIX discretionary policy by increasing its flexibility. For example, with ACLs it is easy to prohibit access to certain individuals.

POSIX 1003.6  
ACLs

11-9. Access Control

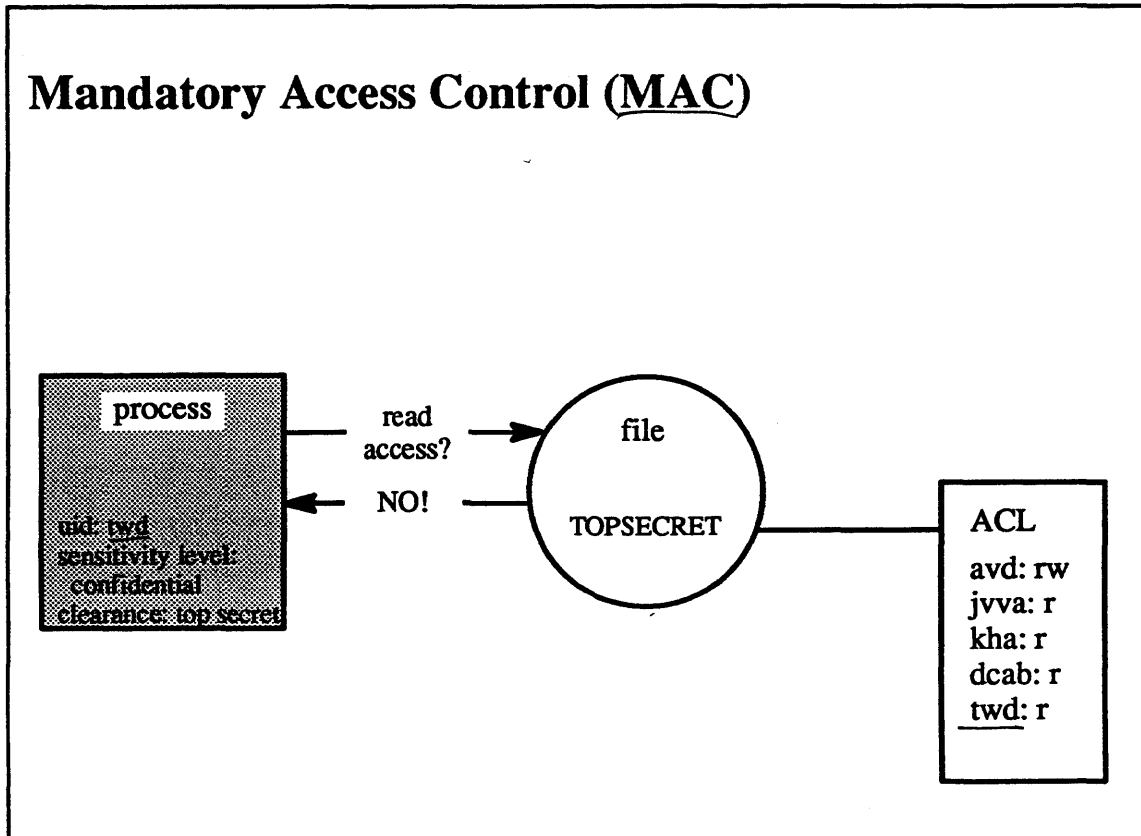

11-9.

© 1990, 1991 Open Software Foundation

*Compartments*

NATO

NORAD

## Module 11 — Security

---

### Student Notes: Mandatory Access Control (MAC)

Mandatory access control involves enforced restrictions on objects that cannot be changed at the discretion of the creator or owner or user. Subjects are assigned *levels of trust* (clearances) and objects are assigned *degrees of sensitivity*. Both notions are represented with *sensitivity labels* and combine a hierarchical classification with a non-hierarchical set of categories (or compartments).

DoD security classifications are an example of a hierarchical classification—Unclassified < Confidential < Secret < Top Secret < Eyes-Only. Combined with this is the non-hierarchical notion of compartments, e.g. NATO, NORAD. Thus, to view a Top Secret NATO document, it is not enough to be cleared for Top Secret; one must also be working within NATO.

Various rules are established governing access to information. For example, one cannot modify a Secret file while executing in a Top Secret domain, but one can read a Secret document while in a Top Secret domain.

11-10. Access Control

**Mandatory Access Control: Multilevel Directories**

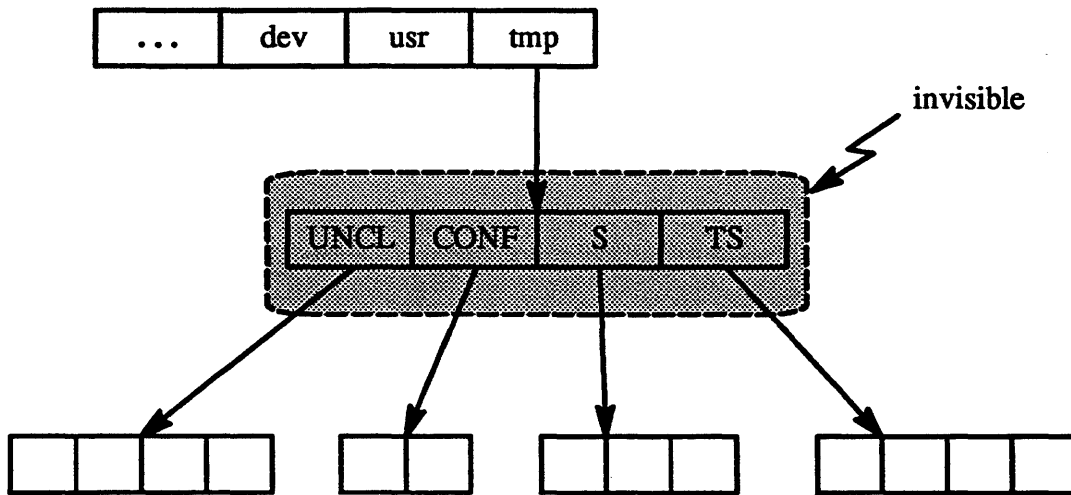

11-10.

© 1990, 1991 Open Software Foundation

## Module 11 — Security

---

### Student Notes: Mandatory Access Control: Multilevel Directories

Public directories (such as /tmp) need special treatment when used in conjunction with the mandatory access control policy. For example, various programs such as the C compiler use the /tmp directory to hold their temporary files. Even though the contents of these files may be securely protected, the existence of a temporary file as well as its name could be easily discovered by anyone performing an *ls* on the /tmp directory. Such information about Top Secret temporaries, for example, should not be known to those operating in the Secret domain.

Furthermore, if a directory is, for example, Top Secret, then a process whose sensitivity level is Secret wouldn't be able to add files to it, since this would require modifications to the directory. If the directory was Secret, then a Top Secret process couldn't write to it, because this would allow the leakage of information to a lower sensitivity level.

One approach to dealing with this problem might be to change all applications so that they do not use public directories but instead find directories at appropriate security levels. A better approach is to deal with the problem transparently. A directory such as /tmp may be set up as a *multilevel* directory. It is then transparently split into a number of subdirectories, one for each security classification. Thus a reference to the file /tmp/xyz by a process executing as Top Secret would be translated into a reference to the file /tmp/topsecret/xyz.

### 11-11. Access Control

#### Attributes

- Examples:
  - UID/GID
  - security classification
  - security compartment
  - access control list
- Each is represented by a 32-bit tag



## Module 11 — Security

---

### Student Notes: Attributes

Each security policy must deal with a set of *attributes* on subjects and objects. These attributes can be very complicated; for example, an ACL can be arbitrarily long. A direct representation of such attributes would be too complex for the kernel to manipulate easily. Instead, each attribute is represented by a 32-bit tag (thus when a new ACL is used, a new 32-bit tag is created).

Every security policy has a policy daemon that is responsible for translating tags to attributes and vice versa. Each such daemon maintains a database to aid this process; it must ensure that tags are unique. Inside the kernel, the policy modules deal only with tags. Since they are not capable of interpreting the tags, they can only make equality comparisons; any other manipulation must be forwarded to the user-level policy daemon.

## 11-12. Access Control

### Tag Pools

- Each security policy uses a fixed set of attribute types
  - DAC uses one each for subjects and objects (UID/GID, ACL)
  - MAC uses two for subjects (sensitivity level, clearance level) and one for objects (sensitivity level)
- Each subject's and object's tags are organized into a *tag pool*

## Module 11 — Security

---

### Student Notes: Tag Pools

Each subject and object must be associated with its attributes with respect to each security policy. In OSF/1, each subject must have three tags (one for DAC and two for MAC) and each object must have two tags (one each for DAC and MAC). The collection of tags associated with a subject or an object is known as a *tag pool*.

**11-13. Access Control**

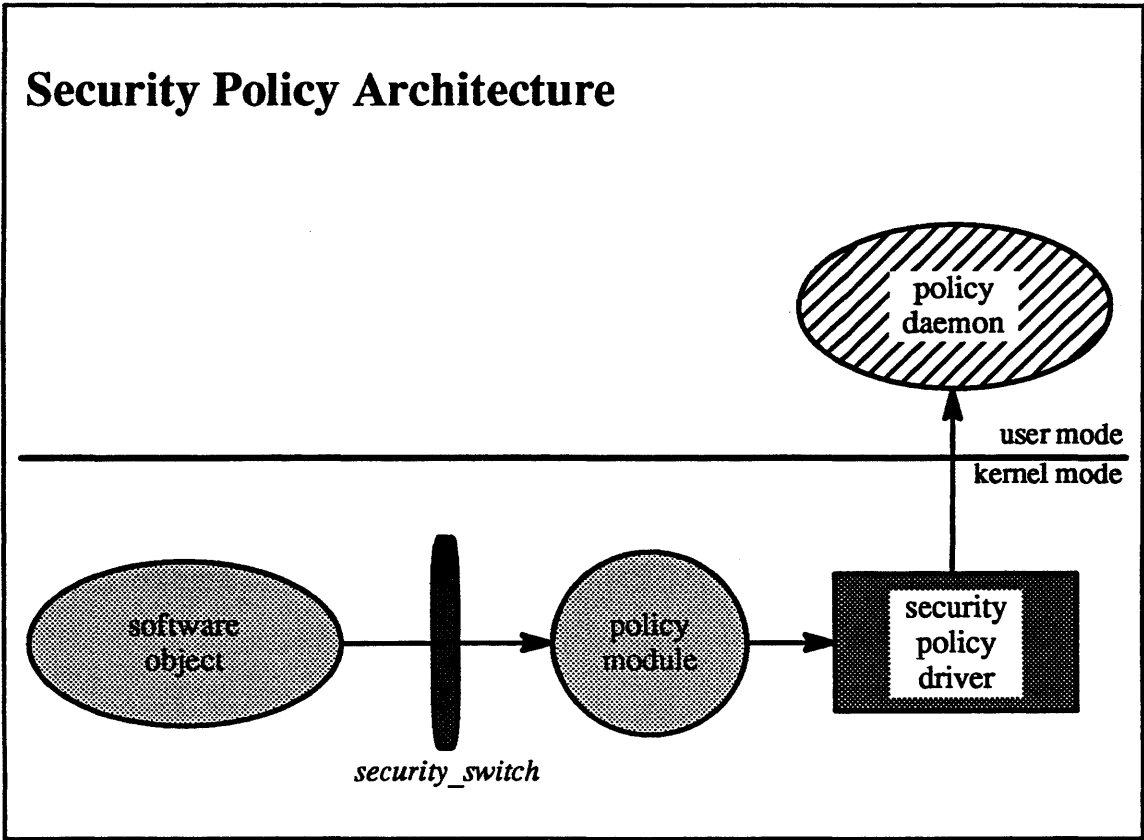

11-13.

© 1990, 1991 Open Software Foundation

## Module 11 — Security

---

### Student Notes: Security Policy Architecture

Whenever a security decision has to be made or action taken, each security policy must be consulted. In OSF/1, there are two such policies, DAC and MAC. Thus, for example, if a process attempts to open a file, both DAC and MAC are consulted to ensure that both will allow the access. If either says no, the access is denied.

The security decisions are implemented through the *security switch*. Each security policy provides a *policy module* in the kernel whose entry points are contained in the security switch. When a subject attempts to access an object, the macro `SP_ACCESS` is called, which calls the access entry point of each policy (via the security switch), passing to the policy module the subject's attributes and the object's attributes. Each policy module maintains a cache of recent security decisions, which consists of relations on attributes as represented by tags. If the decision cannot be made based upon the contents of the cache, then the policy module forwards the request via an *upcall* to its policy daemon, which then makes the decision.

### 11-14. Authorizations and Privileges

#### Authorizations and Privileges

- **Authorizations**
  - *command authorizations* are used to restrict certain subsystems and commands to designated users
  - *kernel authorizations* grant certain security policy overrides to trusted applications
- **Privileges**
  - rights to access operating-system functions
  - used partly to implement kernel authorizations

## Module 11 — Security

---

### Student Notes: Authorizations and Privileges

A manager of an object finds out if the subject process is *authorized* by checking a list of authorized subjects, whereas a *privilege* is an actual property of the process, stored with the process.

## 11-15. Authorizations and Privileges

### Authorizations

- Command authorization
  - specific
  - role
  - subsystem



## Module 11 — Security

### Student Notes: Authorizations

Command authorizations are associated with particular users and are maintained by user-level code and databases. These authorizations are broken into the following categories:

- specific
  - allows the user to execute a command to perform a specific functions. E.g., the *mknod* authorization allows the user to invoke the *mknod* command to create special files
- role *operator*
  - allows the user to perform tasks associated with some specific system role. E.g., the *issd* authorization allows the user to administer the security system
- subsystem
  - grants the user additional rights in certain subsystems. E.g., the *lp* authorization allows the user to use the administrative and command options of the *lp* subsystem

## 11-16. Authorizations and Privileges

### Privileges

- Root replacements
- UNIX mode
- Trusted mode
- Trusted function

## Module 11 — Security

---

### Student Notes: Privileges

Instead of the superuser/mere-mortal dichotomy of UNIX, OSF/1 uses a much finer breakdown of privileges, dividing them into the following categories:

- root replacements
  - a breakdown of the privileges once reserved for the root into a set of rights that can be individually granted; e.g., the *sysattr* privilege allows one to invoke system calls that change system attributes such as the time of day.
- UNIX mode
  - privileges that ordinary users have in UNIX but may be restricted in OSF/1; e.g., one must have the *execsuid* privilege to execute SETUID programs.
- trusted mode
  - privileges allowing a process to operate in modes that gain it special treatment with respect to trusted system features; e.g., the *suspendaudit* privilege allows a process to stop the kernel from collecting audit records.
- trusted function
  - privileges allowing a process to define new trusted functions; e.g., the *writeaudit* privilege allows a process to append records to the audit trail.

## 11-17. Authorizations and Privileges

### Use of Privileges

Associated with the process:

*bit vector*

- base privilege set
- kernel authorizations set
- effective privilege set

Associated with the executable file:

- potential set
- granted set

## Module 11 — Security

---

### Student Notes: Use of Privileges

The *base privilege set* is the set of privileges that is always granted to a process when it `execs` a file.

The *kernel authorization set* is the set of privileges for which the process's user is authorized.

The *effective privilege set* is the set of privileges that are currently being used when the kernel checks for privileges.

The *potential set* is the set of privileges that a program may use.

The *granted set* is the set of privileges that is placed in a process's effective privilege set when the file is `exec'd`.

11-18. Authorizations and Privileges

Exec'ing a File

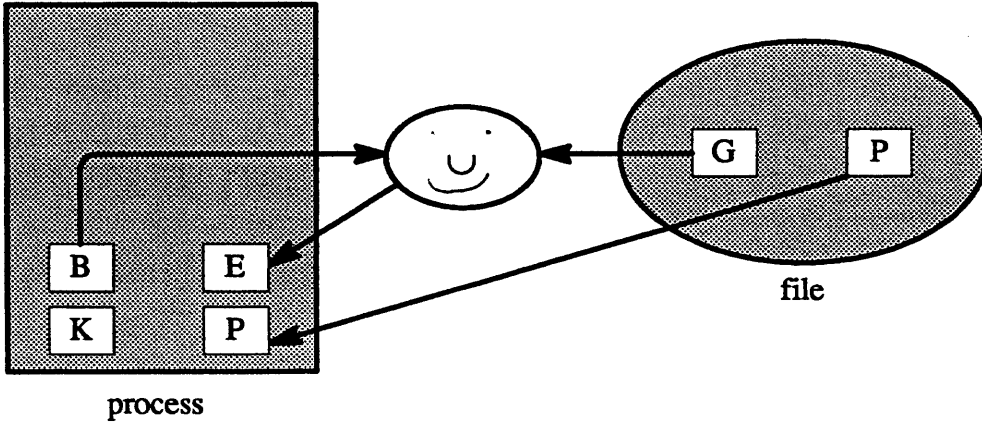

11-18.

© 1990, 1991 Open Software Foundation

## Module 11 — Security

---

### Student Notes: Exec'ing a File

Privilege sets are represented as bit vectors. Associated with each process are four such bit vectors, for the *base privilege set*, the *kernel authorization set*, the *effective privilege set*, and the *potential set*.

Each inode contains bit vectors for the *granted* and *potential* sets.

When a user `execs` a program provided by another user, we have two mutually suspicious parties. Each party, i.e., the owner of the process and the owner of the executable file, provides an initial set of privileges that form the initial effective set of this joint venture. This effective set may be enlarged, but only subject to constraints provided by both parties. Privileges can be added to the effective set that are either in the potential set or the base set. The base set can itself be enlarged, but only by adding to it privileges that are in both the kernel authorization set and the potential set. This protects both parties in the event that another file is `exec'd`. The base set used with this new file would contain only those privileges allowed by both parties. This technique prevents privileges from being combined in unforeseen ways.

**11-19. Authorizations and Privileges**

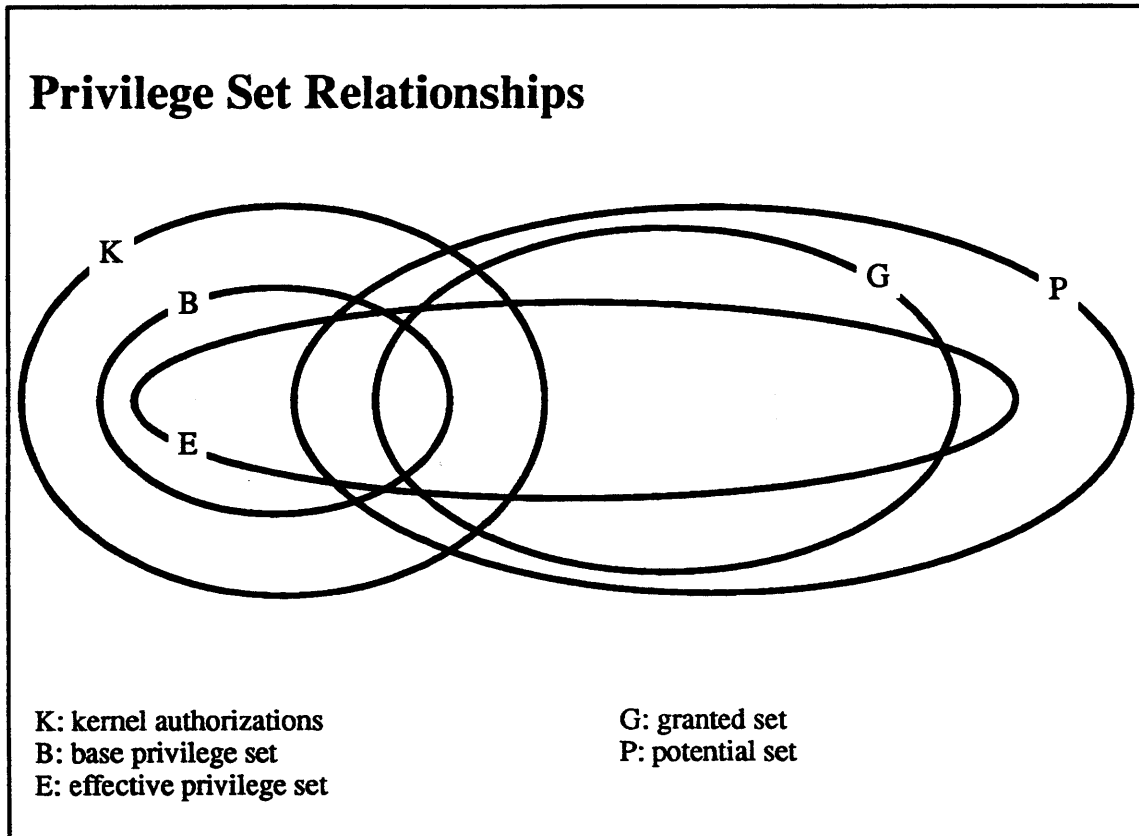

11-19.

© 1990, 1991 Open Software Foundation



## Module 11 — Security

---

### Student Notes: Privilege Set Relationships

A set of kernel authorizations defines the limit of what privileges this process is allowed to have. It is a subset of the privileges available to the user. The potential set limits the privileges of a process executing the program contained in a file.

$$B \subseteq K$$

$$E \subseteq (P \cup B)$$

$$G \subseteq P$$

## Module 11 — Security

### 11-20. Authorizations and Privileges

#### Principle of Least Privilege *B2*

*Trusted applications use the smallest effective privilege sets possible*

## Module 11 — Security

---

### Student Notes: Principle of Least Privilege

Good practice dictates that the effective privilege set should be kept as small as possible. The `setpriv` system call allows a process to adjust its sets  $K$ ,  $B$ , and  $E$ , subject to the constraints:

$$K' \subseteq K$$

$$B' \subseteq (K \cap P) \cup B$$

$$E' \subseteq P \cup B$$

(where  $K'$ ,  $B'$ , and  $E'$  are the sets  $K$ ,  $B$ , and  $E$  after a `setpriv` request).

### 11-21. Authorizations and Privileges

#### Operations on File Privilege Sets

Processes that have the *chpriv* privilege may change a file's *granted* and *potential* sets

## Module 11 — Security

---

### Student Notes: Operations on File Privilege Sets

Using the `chprv` system call, a process may propagate to files only those privileges for which the process is authorized:

$$P' \subseteq K$$

$$G' \subseteq P \cap K$$

If an executable file is modified, then all privileges are removed from its granted and potential sets. This is analogous to the effects of modifying a *setuid* file in standard UNIX.

### 11-22. Living with Security

#### Living with Security

- Secure systems are inherently slower than non-secure systems
  - OSF/1 can be configured to be either C2 or B1
  - the degree of auditing can be set by the system administrator

## Module 11 — Security

---

### **Student Notes: Living With Security**

Not all installations will desire the B1 security features in OSF/1. The system can be configured to be either C2 or B1. This decision is implemented as a compile-time option; it is not a run-time option because too many tests would be necessary. However, the degree of auditing is selectable at run time.

## Module 11 — Security

---

### Exercises:

1.
  - a. To which security class are most UNIX systems probably compliant?
  - b. To which security classes can OSF/1 be made compliant?
  - c. What is the difference between compliant and certified?
2.
  - a. In whose context is audit information collected?
  - b. How is audit information collected in an audit file?
3.
  - a. In what ways are ACLs more flexible than standard UNIX file protection?
  - b. If DAC and MAC disagree on an access decision, how is the issue resolved?
  - c. How is it determined whether a particular subject has the desired access to a particular object with respect to a particular access control policy?
4.
  - a. Explain the difference between how an authorization is implemented and how a privilege is implemented.
  - b. The effective privilege set is restricted to be a subset of the potential set unioned with the base privilege set. Why isn't the kernel authorizations set used instead of the base privilege set?
  - c. List the kernel data structures that were modified to support the OSF/1 security features.
5. Why isn't security compliance a run-time or boot-time option?



## Appendix — Answers to Exercises

---

### Module 1

1. page 1-2
2. page 1-11
3. page 1-15
4. a. page 1-21  
b. pages 1-12—1-15  
c. pages 1-16—1-17  
d. pages 1-18—1-19  
e. pages 1-24—1-25
5. pages 1-36—1-45
6. Mach provides the facilities to allow the efficient transfer and sharing of information across address space boundaries. This is particularly useful for efficient communication with servers. In addition, Mach provides support for multiple threads of control within an address space.
7. OSF/1 includes the logical volume manager, support for dynamic configuration, support for shared libraries and dynamic loading, and B1-level security.

### Module 2

1. a. pages 2-8—2-9  
b. pages 2-8—2-9  
c. pages 2-10—2-15  
d. page 2-11
2. pages 2-16—2-25
3. a. pages 2-40—2-47  
b. pages 2-38—2-39, 2-58—2-59

## Appendix — Answers to Exercises

- c. pages 2-62—2-63
  - d. pages 2-50—2-51
4. a. pages 2-68—2-69
- b. pages 2-70—2-71
  - c. pages 2-70—2-71
  - d. pages 2-76—2-77
5. a. page 2-799
- b. page 2-81
  - c. pages 2-84—2-85
6. a. pages 2-92—2-93
- b. page 2-93
  - c. pages 2-100—2-101
  - d. page 2-89
  - e. page 2-89
7. a. pages 2-104—2-105
- b. pages 2-104—2-105
8. pages 2-106—2-107
9. Separate *u\_task* and *proc* structures are maintained in OSF/1 primarily because the separateness of these two structures is inherent in the Berkeley UNIX source code. There is no particular reason that they could not be merged, but there is no compelling reason to go to the effort of doing so.
10. OSF/1's kernel threads are cheaper than UNIX's kernel processes because kernel threads have no private address space associated with them. Thus the system can switch from the context of any task into the context of a kernel thread without changing address maps.
11. a) There are three primary reasons for nonpreemptibility in kernel mode. The first, which is not a problem in multiprocessor-safe operating systems such as OSF/1, is that certain data structures, if not accessed in the interrupt context, might have no synchronization to protect them other than the assurance that any thread in kernel mode will not be preempted. A second problem, which does affect OSF/1, is that a thread might be updating a data structure that can be accessed in the interrupt context and thus has a class of interrupts masked off. If this thread is preempted (because the mechanism causing preemption, e.g. clock interrupts, has not been masked off), then one of two things might happen, both of them bad. (1) Interrupts remain masked off when the system switches to the preempting thread; this is not good because the interrupt will be masked off much too long and may perhaps interfere with interrupt–masking done by the preempting thread.

## Appendix — Answers to Exercises

(2) Interrupts become unmasked as the system enters the preempting thread's context; thus the system might now enter the previously masked interrupt context and access the data structure that was in the midst of modification by the preempted thread. This data structure, being in the middle of an update, is in an inconsistent state that is totally unexpected by the interrupt handler. The third reason is also a problem with OSF/1: if the preempted thread is holding a spin lock, the preempting thread might attempt to take this lock. This thread will of course spin, with no hope of taking the lock, until the preempted thread is allowed to execute again.

b) The constraints on preemption points are: they must be executed only in the context of a thread, this thread must not be holding any locks, and no interrupts may be masked.

### Module 3

1. a. pages 3-6—3-7  
b. pages 3-6—3-7
2. a. pages 3-12—3-13  
b. pages 3-14—3-17  
c. pages 3-14—3-17  
d. pages 3-14—3-17  
e. pages 3-14—3-17  
f. pages 3-22—3-27
3. a. pages 3-28—3-31  
b. pages 3-28—3-31
4. The main problem with utilizing copy-on-write techniques to improve the implementation of UNIX system calls such as `write` is that the best use of these techniques requires page alignment of data structures such as buffers. Since typical UNIX programs are not written with such alignment requirements in mind, it is unlikely that very many buffers would actually be properly aligned. If such alignment problems could be dealt with, then any UNIX system call that transfers large amounts of data could be improved. In particular, this means I/O-related system calls operating on files, devices, sockets, and streams.

### Module 4

1. a. pages 4-4—4-5, 4-49  
b. page 4-5
2. a. pages 4-10—4-11  
b. pages 4-13, 4-23, 4-73

## Appendix — Answers to Exercises

- c. pages 4-58—4-59
  - d. page 4-11
- 3.
- a. pages 4-46—4-47
  - b. pages 4-46—4-47
  - c. pages 4-50—4-51
  - d. page 4-37
  - e. pages 4-32—4-43
  - f. page 4-37
  - g. pages 4-54—4-55
  - h. pages 4-56—4-57
- 4.
- a. pages 4-58—4-101
  - b. pages 4-62—4-65
  - c. page 4-77
  - d. pages 4-86—4-97
  - e. page 4-99
- 5.
- a. pages 4-108—4-109
  - b. pages 4-108—4-109
  - c. pages 4-108—4-114
  - d. pages 4-108—4-119
6. If we want to enjoy the advantages of lazily evaluating the allocation of backing store, then we must deal with the problem that a thread's execution may fail at an arbitrary point in time. The best we can hope for is that the extent of the damage be limited: for example, that it be necessary to terminate only one task. If this sort of behavior is intolerable, we may have to use a more conservative preallocation backing-store policy.
7. The primary difficulty in replacing the vnode pager with an external pager is that this external pager, being the "pager of last resort," must never encounter page faults itself. Thus one technique might be to wire the external pager's pages into primary memory.

### Module 5

- 1. page 5-9
- 2. a. pages 5-16—5-19

## Appendix — Answers to Exercises

- b. pages 5-24—5-27
  - c. page 5-31
3. a. page 5-35
- b. pages 5-40—5-41
  - c. pages 5-52—5-63
4. a. pages 5-76—5-77
- b. pages 5-80—5-81
5. a. pages 5-88—5-89
- b. pages 5-94—5-97
6. a. pages 5-102—5-103
- b. page 5-104
  - c. page 5-115
  - d. pages 5-122—5-123
7. a. page 5-127
- b. page 5-131
  - c. pages 5-134—5-135
  - d. pages 5-138—5-139
  - e. pages 5-148—5-149
  - f. pages 5-156—5-157
8. All three locks are necessary. The lock on the file table entry is necessary to protect the offset stored there from being used prematurely by another thread. This ensures that I/O system calls executed by threads sharing a file table entry are atomic. The lock on buffers from the buffer cache is necessary to prevent a buffer from being stolen for some other purpose while one thread is using it. A simple lock is required for updates to the vnode because, for example, two threads concurrently reading the same file, but using different file table entries, might update the access time of the vnode.
9. One might argue that, if it is known that a directory is being searched and the result of this search will be used very soon as part of a delete operation, the directory should be searched while holding a write lock. The primary reason that this is not done is that it is highly unlikely that there will be two concurrent updates to the same directory. Thus the optimistic approach described on page 5-75 works out very well in what is by far the more usual case. The fact that concurrent updates, if they occur, can be quite expensive is thus of little consequence.

## Appendix — Answers to Exercises

### Module 6

1. a. page 6-7  
b. pages 6-8—6-9
2. a. pages 6-12—6-13  
b. pages 6-12—6-13
3. pages 6-16—6-17
4. a. pages 6-36—6-37  
b. pages 6-40—6-41  
c. pages 6-46—6-47

### Module 7

1. a. pages 7-6—7-10  
b. pages 7-16—7-19  
c. pages 7-20—7-23
2. a. pages 7-31—7-35  
b. pages 7-30—7-31  
c. pages 7-24—7-27
3. a. pages 7-38—7-39  
b. pages 7-40—7-41
4. a. pages 7-42—7-43  
b. pages 7-48—7-49
5. a. pages 7-50—7-51  
b. pages 7-58—7-59  
c. pages 7-50—7-59
6. The use of synchronization queues has no effect on the order of message processing within a streams module: the synchronization queues preserve the order of calls to the module's procedures, and thus any ordering constraints imposed on messages by the code within a streams module is preserved. However, it is certainly the case that with synchronization queues there might be more messages within a streams pipeline than there

## Appendix — Answers to Exercises

would be without such queues. For example, while one thread is executing within a module, other threads might queue more requests on this module's synchronization queue than are allowed by the high-water limit on the module's normal streams queue. In practice this is unlikely to be a problem: the only situation in which it could be a problem is if the rate at which messages are processed by a module is slower than the rate at which messages are arriving to the module. Given that streams threads execute nonpreemptively and without blocking, this situation is highly unlikely.

### Module 8

1. page 8-6
2. a. page 8-11  
b. pages 8-20—8-21  
c. page 8-5
3. a. pages 8-26—8-27  
b. pages 8-32—8-33
1. pages 8-36—8-37

### Module 9

1. a. pages 9-4—9-5  
b. pages 9-12—9-23
2. a. pages 9-18—9-19, 9-31  
b. page 9-19
3. a. page 9-27  
b. page 9-22  
c. page 9-31  
d. page 9-33
4. Only two data structures in the UFS file system depend upon the size of the entire file system: the superblock and the cg summary. These of course must be modified to reflect the larger file system and the modified superblock must be copied to all of its alternative locations.

## Appendix — Answers to Exercises

### Module 10

1. page 10-4
2. a. pages 10-10—10-17  
b. page 10-17
3. a. pages 10-14—10-19  
b. pages 10-20—10-21
4. a. page 10-23  
b. pages 10-23—10-24
5. pages 10-26—10-27  
a. pages 10-28—10-29

### Module 11

1. a. page 11-7  
b. page 11-10  
c. pages 11-8—11-9
2. a. page 11-13  
b. pages 11-14—11-15
3. a. pages 11-16—11-17  
b. page 11-27  
c. page 11-27
4. a. pages 11-28—11-29  
b. page 11-37
5. page 11-45



# Glossary

---

<b>address space</b>	a set of virtual locations, such as those locations that can be referenced by a task or process.
<b>authorizations</b>	indications of whether a particular user is allowed to use a particular command or subsystem, perform a particular role, or gain a particular privilege.
<b>blocking lock</b>	a lock which a thread waits for by yielding the processor.
<b>bogus memory</b>	type of memory in a parallel architecture that does not guarantee atomicity of reads of aligned words.
<b>buffer cache</b>	the collection of buffers maintained in the kernel for use in accessing files and block special devices.
<b>channel</b>	address of a relevant data structure that specifies an awaited event.
<b>concurrency</b>	multiple threads are in progress at one time; their execution might be multiplexed on a single processor.
<b>cooked mode</b>	a terminal mode in which input lines can be edited, and certain characters cause signals to be sent to the process group.
<b>copy-on-write</b>	optimization using lazy evaluation in which copying is postponed until a task actually modifies a page.
<b>devices</b>	hardware.
<b>disposition</b>	indicates whether or not the sleep is interruptible by a signal.
<b>exceptions</b>	deviations to a thread's flow of control that are caused by actions of the thread itself (such as addressing errors, arithmetic errors, etc.).
<b>external</b>	outside the kernel.
<b>file handle</b>	data that is used to identify a file. After a client opens a file, the server gives it a file handle, which the client gives to the server to speed subsequent accesses.
<b>funnel</b>	a kernel data structure used to represent the parallel/sequential constraints of a particular subsystem.
<b>handoff scheduling</b>	a form of thread scheduling in which one thread gives its processor to another.

# Glossary

<b>idempotent</b>	when the effect of performing an operation once is the same as performing it multiple times, the operation is idempotent.
<b>inode</b>	the (ondisk and incore) data structure that describes a file (both S5 and UFS).
<b>internal</b>	inside the kernel.
<b>lazy evaluation</b>	technique of postponing everything until the last possible moment, since if you put it off long enough, maybe you won't have to do it.
<b>local port</b>	port that the message comes back through.
<b>logical volume</b>	an abstraction that behaves like a disk drive to file system code, but is in fact a collection of separate regions of real disk drives (physical volumes).
<b>lookup cache</b>	cache of the most recent component-name-to-vnode translations.
<b>memory object</b>	a "thing" that can be mapped into a task's address space. It might be temporary storage (e.g., UNIX's BSS and stack), a file, or an object defined by user-provided servers.
<b>memory object manager</b>	responsible for supplying initial values for a range of virtual memory and for backing up virtual memory when the physical memory cache becomes full. One may be used, for example, to map files into the address spaces of tasks, to provide shared memory in a distributed system, or to implement a transaction-management system.
<b>message</b>	a collection of data to be sent through a port to the task that has receive rights for the port.
<b>microkernel</b>	a simple, pure Mach kernel with no built-in UNIX (or other operating system) functionality. Such functionality would be provided by user tasks.
<b>mmap</b>	a system call that is used either to map a file into a process's address space or to create an anonymous memory region.
<b>multithreaded</b>	composed of a number of threads.
<b>NICFREE</b>	number of incore free blocks. Equal to 100.
<b>package</b>	an abstraction of a library.
<b>parallelism</b>	the simultaneous execution of multiple threads; requires multiple processors.
<b>parallelization</b>	the act of making a system parallelized.
<b>physical volume</b>	a real disk drive or a portion of a disk drive.

# Glossary

<b>pmap</b>	the data structure and code encapsulating the architecture-dependent portion of the virtual memory system.
<b>port</b>	a protected queue of messages or an object reference.
<b>port set</b>	two or more ports whose message queues have been consolidated into a single queue by the server task.
<b>priority depression</b>	option to the <code>thread_switch</code> system call; a calling thread's priority is "depressed" to the worst possible value for a given period of time, and is then restored.
<b>privileges</b>	properties of a process that gain it special treatment by the operating system.
<b>process</b>	an address space, one or more threads of control and additional information necessary to represent a UNIX context.
<b>processor allocation</b>	distributing the processors of a multiprocessor among the various applications.
<b>processor set</b>	mechanism for processor allocation.
<b>processor sharing</b>	scheduling or multiplexing processors.
<b>raw mode</b>	the terminal mode in which incoming characters are passed immediately to user threads and outgoing characters are sent to the terminal with no further processing.
<b>read-ahead</b>	reading the next unit of data at the same time as the current unit of data.
<b>read-write lock</b>	a lock that can be taken as either a read lock, allowing multiple readers by no writers, or as a write lock, allowing a single writer and no readers.
<b>remote port</b>	port for sending messages.
<b>search cache</b>	a cache in the inode that contains the offset at which the last search terminated.
<b>sharing</b>	what one is taught in nursery school.
<b>simple lock</b>	a spin lock.
<b>socket</b>	a data structure representing the end point of a communication
<b>spin lock</b>	a lock which a thread waits for by repeatedly testing a bit.
<b>stream</b>	the kernel analog of a shell pipeline.
<b>submap</b>	a data structure representing a portion of the kernel address space which is probably managed by a single subsystem.

# Glossary

<b>swapping</b>	unwiring or wiring the kernel stack.
<b>task</b>	a holder of capabilities, such as address space and communication channels.
<b>thread</b>	usual notion of thread of control.
<b>thread pool</b>	a collection of threads used to handle events generated in the interrupt context.
<b>timed pause</b>	when a thread calls <code>thread_switch</code> with the wait option, it can be suspended for a fixed period of time and then automatically woken up.
<b>translation-lookaside buffer</b>	a hardware cache which translates virtual addresses to real addresses.
<b>upcall</b>	a call from a lower level of a system to a higher level (e.g. from kernel mode to user mode).
<b>virtual copy</b>	an optimized copy operation.
<b>virtual file system</b>	the abstraction of the file system concept: the layer of the kernel which provides the standard interface to the real file systems.
<b>vnode</b>	an abstraction of a file; it contains generic information about files and refers to the file-system-specific information on individual files. It also refers to an array of entry points called <code>vnodeops</code> , which provides access to the various operations.
<b>write-behind</b>	delaying the update of a file until sometime after the write system call has been completed.
<b>write-through cache</b>	a buffer cache that requires that the data it buffers be written onto the disk before the system call returns.
<b>zone</b>	a collection of fixed-size blocks: a separate zone is created for each kernel data structure that is so managed. A zone is initialized with a pre-allocated free list, an allocation size, and a maximum size.

## A

- Access control, 11-17—11-27
- Access control list (ACL), 11-17
- Access permissions, in NFS, 5-127
- Active list, 4-55
- Address space, 2-7, 4-3, 4-7—4-9
  - growth, 4-27
- Address space layout, 10-25
- Aliases, 6-9
- ASCII character set, 6-33
- Attach, 6-17
- Attributes, 11-23
- Audit daemon, 11-13
- Audit device driver, 11-13
- Auditing, 11-13—11-15
- Authorizations, 11-29—11-31

## B

- Backing storage allocation, 4-49
- Backup ports, 3-25—3-27
- Bad-sector remapping, 9-11
- Base priority, 2-93
- bdevsw table, 6-7, 6-13
- bdevsw\_add, 6-13
- Block interface, 6-5—6-9
- Block skip section (BSS), 4-25
- Blocked threads, 2-67
- Blocking locks, 5-51, 5-123
- Blocking threads, 2-45—2-47
- Bogus memory, 5-123, 5-165
- Bootblock, 5-95
- Bootstrap port, 1-27
- bp, 6-25
- buf structures, 5-43
- Buffer cache, 5-7, 5-35—5-65
  - access to, 5-41
  - finding a block, 5-57—5-59
  - getting a new buffer, 5-61—5-63
  - maintenance of, 5-39

- server's, 5-139

## C

- Can queue, 6-43—6-45
- Capabilities, 1-21, 5-81
- cdevsw table, 6-7, 6-13
- cdevsw\_add, 6-13
- Character interface, 6-5—6-7
- Client-side caching, 5-133
- Clipping, 4-79
- Close, 6-17, 6-21
- Cluster pool, 8-19
- cmd, 6-27
- Collapsing objects, 4-81
- Compliance, UNIX, 1-5
- Compliant vs. certified, 11-9
- Concurrency, 1-13, 5-77
- Configure, 6-17
- Configure entry point, 6-13
- Consistency
  - devices, 6-9
  - file systems, 5-45—5-49
- Continue signal, 6-35
- copen, 5-29
- Copy link, 4-87
- Copy object, 3-29
- Copy-on-write, 4-59, 4-83
- Crash recovery, 9-9, 9-31
  - in NFS, 5-127
- Crashes, server, 5-149—5-153
- Credentials structures, 5-137
- Cylinder group block, 5-107
- Cylinder group summary, 5-107

## D

- Data, 6-27
- dblk, 7-31
- Deadlock, 2-65
  - avoiding, 2-63

- Debugging, 2-73
- Default memory object manager, 4-31
- Dev, 6-19—6-29
- Device drivers, 6-3, 6-17—6-31, 6-43
- Device I/O, flow of control, 6-7
- Device module switch table, 7-45
- Device number, 6-5
- device\_inuse, 2-33
- Devices, 6-5, 6-9
- Directory path searching, 5-67—5-83
  - complications in, 5-69
- Discretionary access control (DAC), 11-17
- Disk I/O performance, 5-105
- Disk map, 5-89
- Disposition, 2-29
- Distributed computing environment (DCE), 5-129
- Drain routine, 8-25
- Driver entry points, 6-17
  - close, 6-21
  - interrupt, 6-29
  - ioctl, 6-27
  - open, 6-19
  - read/write, 6-23
  - strategy, 6-25
- Dup, 5-11
- Duplicate detection, 5-163
- Dynamic configuration, 6-11—6-15
  - interrupt handler, 6-15
- Dynamic loader, 10-27—10-29
- Dynamic loading, drivers, 6-13

## E

- Eighth-bit character sets, 6-33
- Events, 2-57
- Exception handling, in Mach, 2-75
- Exception port, 1-27, 2-77
- Exceptions, 2-69, 2-77
- Exported symbol table, 10-13, 10-17, 10-21
- Extensible loader, 1-3
- External events, 2-69

- External memory object managers, 1-35

## F

- Family, 2-7
- File handles, 5-131
- File module switch table, 7-47
- File-system-independent data structures, 5-25—5-27
- Flags, 4-15, 4-19, 6-19—6-21, 6-27
- Flow of control, 3-29—3-31
  - LVM, 9-27
  - open and create, 5-29
  - read and write, 5-31
- Format-dependent loader, 10-21
- Forward-mapped segmented-paged architecture, 4-111
- Fragments, cost of, 5-109—5-115
- Free block list, 5-97
- Free list, 4-55
- Free-space hint, 4-17
- Funnels, 2-103

## G

- Gangs, 2-89
- getnewbuf, 5-59
- Global run queue, 2-91

## H

- Handler, 2-69, 2-75
- handler\_add, 6-13
- handler\_enable, 6-13
- Hard mount, 5-149
- Hardware device number, 6-29
- Hint, 4-17

## I

- I/O request, 6-25
- I-list, 5-95, 5-99
- Idle thread, 2-91
- Imported symbol table, 10-9, 10-21

- Inactive list, 4-55
- Indirect block, 5-89
- Inode, 5-25, 5-87, 5-99
  - generation number, 5-131
- Internationalization, 6-31, 6-33—6-34
- Interrupt, 6-29
- Interrupt dispatcher, 6-15
- Interrupt handler, dynamic configuration of, 6-15
- Interrupt priority level (IPL), 2-31, 2-65
- Interruptible hard mount, 5-149
- Interrupts, protection from, 2-31
- intr, 6-17
- ioctl, 6-17, 6-27
- itable, 6-15

## K

- Kernel loading, 10-29
- Kernel memory allocation, zones, 2-107
- Kernel mode, 2-11
- Kernel port structure, 3-13
- Kernel stack, 2-11
- Kernel stream, 7-5
- Kernel thread pools, 2-105
- Kernel/daemon communication, 11-15
- Kernel-loader server, 10-29
- Known module list, 10-19
- Known package table (KPT), 10-15

## L

- Latency time, minimization of, 5-105, 5-119—5-121
- Lazy evaluation, 1-31, 4-5, 4-45, 4-59
- ld, 10-13
- Libraries, 10-11
- Line discipline, 6-23, 6-31, 6-41—6-43, 6-47
- Loaded package table (LPT), 10-15
- Loader
  - functions, 10-5
  - role of, 10-5—10-9
  - with exec, 10-7—10-9

- Local port, 3-7
- Local run queue, 2-91
- lock\_wait\_time, 2-59
- Locks, in interrupt context, 2-65
- Logical track group (LTG), 9-23, 9-29
- Logical volume manager (LVM), 1-3
  - flow of control, 9-27—9-35
  - mirroring, 9-9
  - organization, 9-7
- longjmp, 2-29, 2-67
- Lookup cache, 5-81

## M

- Mach, 1-3, 1-7
- Mach abstractions, 1-21
- Mach Interface Generator (MIG), 2-25
- Mach/UNIX interaction, 1-11
- Mandatory access control (MAC), 11-21
- mblk, 7-31
- mbufs, 8-11—8-25
  - from mbclusters, 8-23
  - structure of, 8-13—8-15
- mc\_lrefcnt array, 8-19—8-23
- Memory object management, interfaces, 4-33
- Memory object managers, 4-31
  - default, 4-31
- Memory object port, 4-51
- Memory objects, 1-21, 4-31—4-57
- Memory shortages, 8-25
- Message descriptor, 3-7
- Message flow, 7-24
- Messages, 1-21, 1-33, 3-5—3-7
  - data structures, 3-7
  - in Mach, 1-23
  - receiving, 3-31
  - sending, 3-29
- Microkernel project, 1-7, 1-11
- Mirror consistency manager, 9-27
- Mirror consistency record (MCR), 9-23, 9-29
- Mirror write consistency cache (MWC), 9-29
- mmap, 5-65
- Mode
  - cbreak, 6-43

- cooked, 6-43
- raw, 6-43
- Mode bits, 5-123
- Module record, 10-19
- Mount point, 5-73
- Mount protocol, of NFS, 5-141
- Mount structure, 5-17, 5-25, 5-73
- Mounting file systems, 5-21—5-23
- Multi-buffered I/O, 5-37
- Multilevel directory, 11-21
- Multiple file systems, 5-15
  - directory path searching in, 5-71
- Multithreaded processes, 1-7, 1-19
  - server, 1-17
  - signals, 2-9
  - standard libraries, 2-9
  - system calls, 2-9

## N

- Namei, 5-73
- Netisr threads, 8-27
- Network shared memory, 1-37, 1-39, 1-41, 1-43, 1-45
- NFS, 5-125—5-165
- nfsbiod processes, 5-135
- nfsd processes, 5-137
- nfsnode, 5-27, 5-133
- nice routine, 2-93
- Non-homogeneous multiprocessors, 2-89
- Non-parallelized code, 2-103
- Nonidempotency, problems with, 5-155—5-159
- Notify port, 1-27

## O

- Object cache, 3-21
- Object creation, lazy evaluation, 4-45
- Object manager, 4-11
- Object references, 1-21
- Objects, 11-5
- Open, 6-17, 6-19

- Open file data structures, 5-7—5-13
- Open files, 2-7
- Orange Book, 11-7
- Orphaned process groups, 6-37
- Orphaned processes, 6-35
- Out queue, 6-43—6-45

## P

- Packages, 10-11
  - substitution of, 10-17
- Page tables, 4-115
- Pagein, 4-35, 4-37
- Pageout, 4-39, 4-41, 4-43
- Pageout daemon, 4-55
- Pager, 4-19
- pager\_file structure, 4-47
- Pages, 1-31
  - locating, 4-29
  - replacement of, 4-55
  - representation of in primary memory, 4-21
- Parallelism, 1-15
- Parallelization
  - file systems, 5-51
  - NFS, 5-165
  - sockets, 8-33
  - streams, 7-51—7-59
  - UFS, 5-123
- Physical layer, 9-27
- Physical volume reserved area (PVRA), 9-15
- Physical volumes, 9-13
- Physio, 6-23
- pmaps, 4-11, 4-17, 4-103—4-119
  - operations, 4-105—4-111
- Port names, 3-15
  - interpretation of, 3-19
  - translation of, 3-17
- Port sets, 3-11, 4-51
- Ports, 1-21, 1-25, 3-9—3-27
  - backup, 3-25—3-27
  - destruction of, 3-23
- POSIX threads (Pthreads), 2-85
- Priority depression, 2-101
- Privileged mode, 2-11



- Privileges, 11-29, 11-33
  - and exec, 11-37
  - operations on file privilege sets, 11-43
  - principle of least privilege, 11-41
  - set relationships, 11-39
  - use of, 11-35

- Probe, 6-17

- Proc structure, 2-11

- Process group, 6-35—6-37

- Processes, 2-7, 2-11—2-15

- Processor allocation, 2-89

- Processor sets, 2-89

- prog.o, 10-13

- Protocol control blocks, 8-31

- Pseudo device drivers, 6-47, 11-15

- Pseudo terminals, 6-47

- Pthreads, 2-85

- Ptrace, 2-73

- PV list, 4-113

## R

- Race condition, 2-33, 2-41, 2-53, 5-9, 5-59, 7-59

- Raw queue, 6-43—6-45

- Read, 6-17

- Read/Write, 6-23

- Read-aheads, 5-135

- Read-write locks, 2-59

- Reaper thread, 2-83

- Reference count, 4-17, 4-19, 5-9, 8-19, 8-21

- Reference ports, 6-3

- Remote mounting, 5-143, 5-145, 5-147

- RPC protocol, 5-129, 5-135

- Run-time image, 10-23—10-25

- Run-time loader, 10-19, 10-27

## S

- S5 file system, 5-85—5-99
  - directory format, 5-93
  - directory structure, 5-91
  - layout, 5-95

- sched\_average, 2-95

- Scheduler layer, 9-27

- Scheduler priority, 2-93

- Scheduling, 2-87—2-103
  - influencing, 2-101

- Scheduling policies, 2-93
  - fixed priority, 2-93
  - time shared, 2-93

- Search cache, 5-83

- Security
  - in OSF/1, 11-11
  - policy architecture, 11-27

- Security switch, 11-27

- Seek time, minimization of, 5-105, 5-117

- Sensitivity level, 11-19

- Serialization, 9-27

- Session control, 6-31

- Sessions, 6-35—6-37

- setjmp, 2-67

- Shadow chain, 4-81

- Shadow vnodes, 6-9

- Share map, 4-73

- Shared libraries, 10-23

- Shared memory, 1-21

- Shared-memory multiprocessor, 1-19

- Sharing, 4-73—4-78

- Sharing pages, 4-115

- Shell pipeline, 7-5

- Shift-JIS, 6-33

- Signal state, 2-7

- Signal subsystem, 2-103

- Signals, 2-67
  - and multithreading, 2-71
  - in UNIX, 2-69

- Simple locks, 2-39, 5-123

- Slave threads, 4-51

- Sleep, 2-27—2-29
  - UNIX-style, 2-53
  - with unlock, 2-41

- Sockets, 8-5—8-9
  - and streams, 8-35—8-37
  - data structure, 8-29
  - implementation of, 8-27—8-33

- types of, 8-7
- virtual copy, 8-17
- writing with, 8-9

Soft mount, 5-149

specialias structure, 6-9

Special files, 6-5—6-9

specinfo structures, 6-9

Speed, 5-79

Spin locks, 2-39

STH structure, 7-45

STHT structure, 7-45

Stop signal, 6-35

Strategy, 6-17, 6-25

Strategy layer, 9-27

Streams, 1-3

- cloning, 7-49
- definition of, 7-5
- driver, 7-11
- implementation of, 7-39
- linking, 7-16—7-19
- message queues, 7-33, 7-39
- message types, 7-37
- module, 7-7
- multiplexing, 7-21
- push, 7-15
- representing an open, 7-43
- service procedures, 7-27
- setup, 7-13
- stream head, 7-9, 7-41
- synchronization, 7-53—7-57
- TCP/IP example, 7-23
- virtual copy, 7-35

Subjects, 11-5

Submaps, 4-23

Superblock, 5-95, 5-99, 5-107

Suspending threads, 2-49

Swapping, 4-57

Symbol resolution, 10-9—10-17

Symbol substitution, 10-23

Symbolic links, 5-75

Symmetric multiprocessor, 6-3

Synchronization

- calls, 2-61, 2-67
- Mach/UNIX, 2-37, 2-61
- OSF/1, 2-35
- reader-writer type, 2-59
- UNIX, 2-27—2-29
- sleep/wakeup, 2-33

Syscall, 2-19

System calls, 2-17

- Mach, 2-25
- UNIX, 2-19—2-23

System configuration, 6-11

System mode, 2-11

System stack, 2-11

## T

Tag pool, 11-25

Task kernel port, 1-27

Task/local table (TL table), 3-17

Task/port table (TP table), 3-17

Tasks, 1-21, 1-27, 2-11

- system calls, 1-27

Temporary memory objects, 4-47

Terminals

- data structures, 6-39
- I/O, 6-31—6-47
- I/O data structures, 6-45
- I/O flow, 6-43

Thread exception port, 1-29, 2-77

Thread kernel port, 1-29

Thread pools, 2-105

Thread reply port, 1-29

Threads, 1-21, 1-29, 2-11, 2-79—2-85

- creation, 2-79
- dispatching, 2-91
- states, 2-51
- suspension, 2-81
- switching, 4-105
- system calls, 1-29
- termination, 2-83

Threads and parallelism, 1-13—1-19

Time measurement, 2-97

Time slicing, 2-99

Time-shared threads, 2-95

Timestamp, 4-17, 5-59, 9-19, 9-21

TLB shutdown algorithm, 4-119

Trace bit, 2-73

- Translation entry, 3-17
- Translation entry chain, 3-17
- Translation-lookaside buffers (TLBs), 4-117
- Trusted computing base (TCB), 11-7
- tthread routine, 6-43
- tty line discipline, 6-43
- tty structures, 6-41, 6-43
- ttyinput routine, 6-43
- ttyoutput routine, 6-43
- ttywrite routine, 6-43
- Type, 6-19, 6-21

## U

- u\_task component, 2-11
- u\_thread component, 2-11
- UDP protocol, 5-129
- UFS file system, 5-101—5-123
  - directory format, 5-103
  - layout, 5-107
- Uio structure, 5-31, 5-33, 5-123, 6-23
- UNIX master, 2-91
- UNIX/Mach interaction, 1-11
- UNIX\_master, 2-103
- Unlock, with sleep, 2-41
- Upcall, 11-15
- User mode, 2-11
- User stack, 2-11
- User stack pointer (USP), 2-21
- User structure, 2-11

## V

- VFS, 5-15—5-33
- vfsops array, 5-17
- Victim thread, 2-75, 2-83
- Virtual address space, 1-31
- Virtual buffers, 5-43
- Virtual copy, 4-59—4-77, 4-83
  - copy\_call, 4-101

- copy\_delay, 4-87—4-102
- copy\_none, 4-99
- optimization of, 4-85

- Virtual memory, in Mach, 1-31
- Virtual memory (VM), 4-3
- VM components, 4-7—4-29
- VM maps, 4-13
- VM objects, 4-3
- vm\_map, 4-11, 4-17
- vm\_map\_entry, 4-11—4-15
- vm\_object, 4-11, 4-19
- Vnode, 5-19, 5-73, 5-81
- Vnode pager, 4-31
- Vnode pager task, 4-51
  - address space, 4-53
- vnnode\_pager\_set, 4-51
- vnnodeops, 5-19
- Volume group descriptor area (VGDA), 9-19
- Volume group reserved area (VGRA), 9-17
- Volume group status area (VGSA), 9-21
- vs\_pmap, 4-47
- vstruct structure, 4-47

## W

- Wait-result field, 2-55
- Wakeup, 2-27—2-29
- Wakeup routines, 2-55
- Waking up, 2-55
- Write, 6-17
- Write-behinds, 5-135

## X

- XDR protocol, 5-129
- XTISO, 8-37

## Z

- Zones, 2-107

