

[54] COMPUTER OR SIMILAR ARTICLE

[75] Inventors: Matthew H. L. Sanders, Cupertino; Scott H. Stillinger, Los Gatos; Michael J. Nuttall, Palo Alto, all of Calif.

[73] Assignee: Convergent Technologies, Inc., Santa Clara, Calif.

[**] Term: 14 Years

[21] Appl. No.: 322,593

[22] Filed: Nov. 18, 1981

[52] U.S. Cl. D14/106; D14/113

[58] Field of Search D14/100-117; 340/365 R, 700, 711, 720, 750, 235/145 R; 248/441.1, 447.2, 441.2; 400/718

[56] References Cited

U.S. PATENT DOCUMENTS

D. 235,655 7/1975 Clement D14/113

OTHER PUBLICATIONS

Computer Design, 5-1980, p. 36, Starplex TM Data System.

Computer Products, 9-1979, p. 8, F-85 Business-Oriented Microcomputer.

Primary Examiner—Susan J. Lucas

Attorney, Agent, or Firm—C. Michael Zimmerman

[57] CLAIM

The ornamental design for a computer or similar article, as shown and described.

DESCRIPTION

FIG. 1 is a front perspective view of a computer or similar article showing our new design;

FIG. 2 is a front elevational view of the computer, the display component being rotated to an alternate position;

FIG. 3 is a rear elevational view thereof;

FIG. 4 is an end elevational view thereof;

FIG. 5 is an opposite end elevational view thereof;

FIG. 7 is a bottom plan view thereof;

FIG. 8 is a perspective view of a computer or similar article showing a second embodiment of our new design;

FIG. 9 is a front elevational view of the computer of the second embodiment, the display component being rotated to an alternate position;

FIG. 10 is a rear elevational view thereof;

FIG. 11 is an end elevational view thereof;

FIG. 12 is an opposite end elevational view thereof;

FIG. 13 is a top plan view thereof;

FIG. 14 is a bottom plan view thereof;

FIGS. 15 and 16 are top plan views of third and fourth embodiments of our design, the third and fourth embodiments being identical to the second embodiment from the front, rear, bottom and ends.

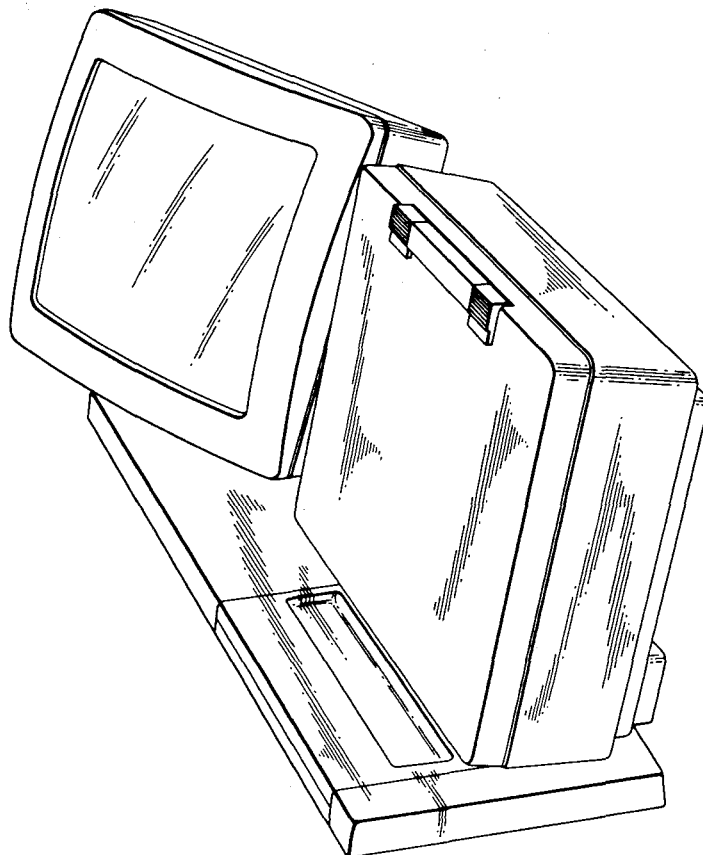

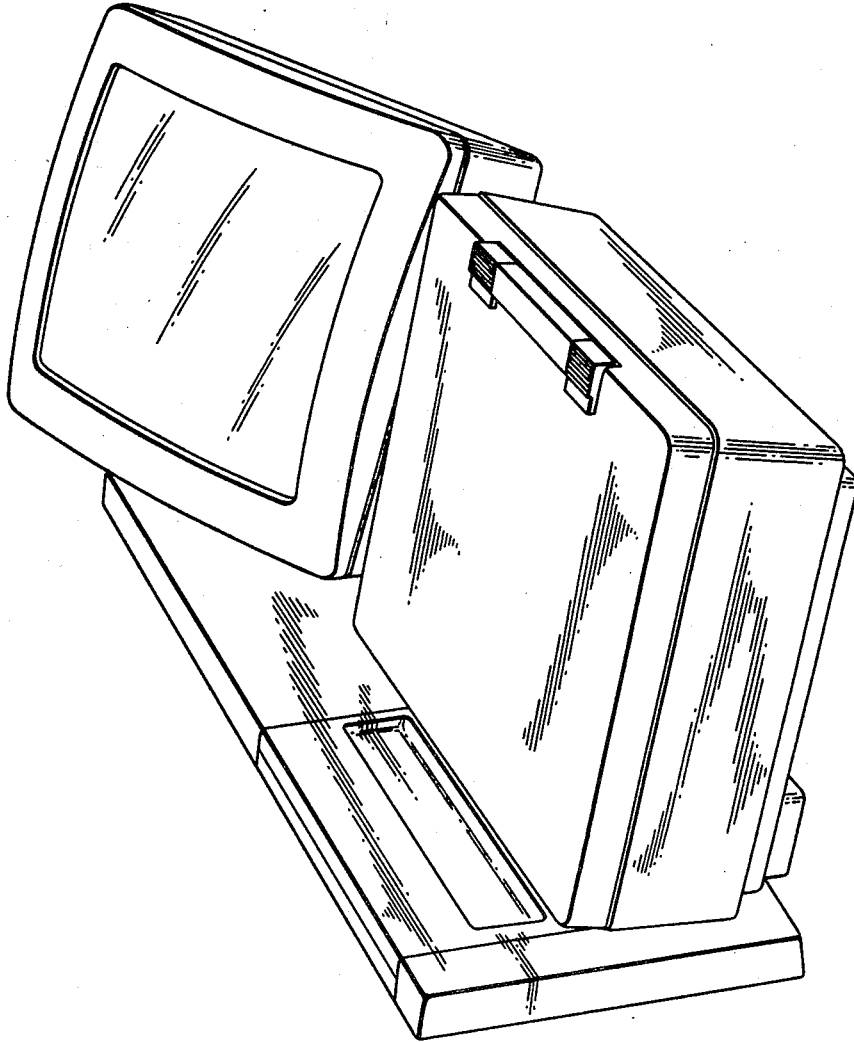

FIG. 1

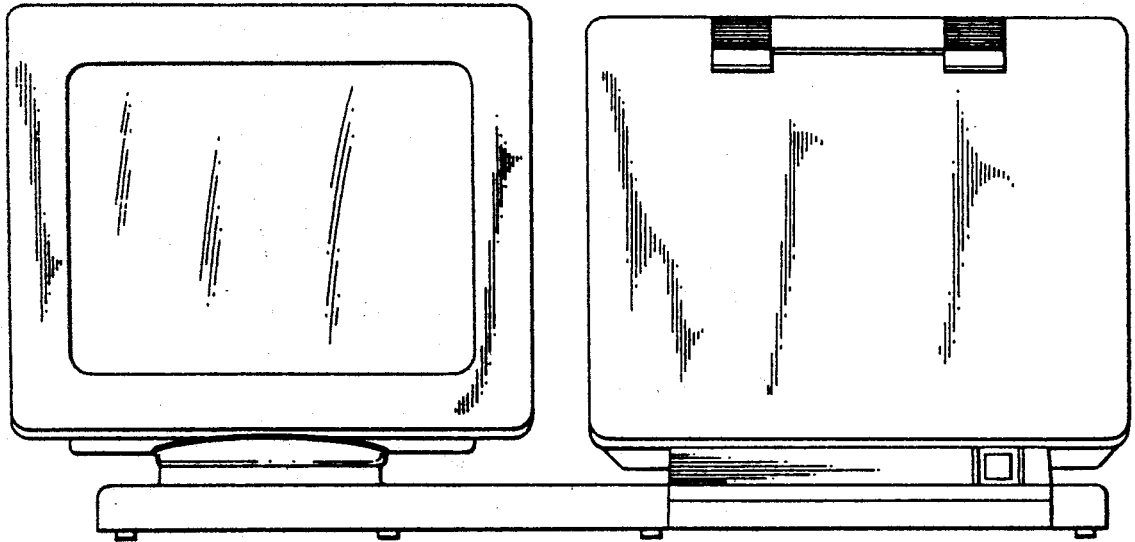

FIG. 2

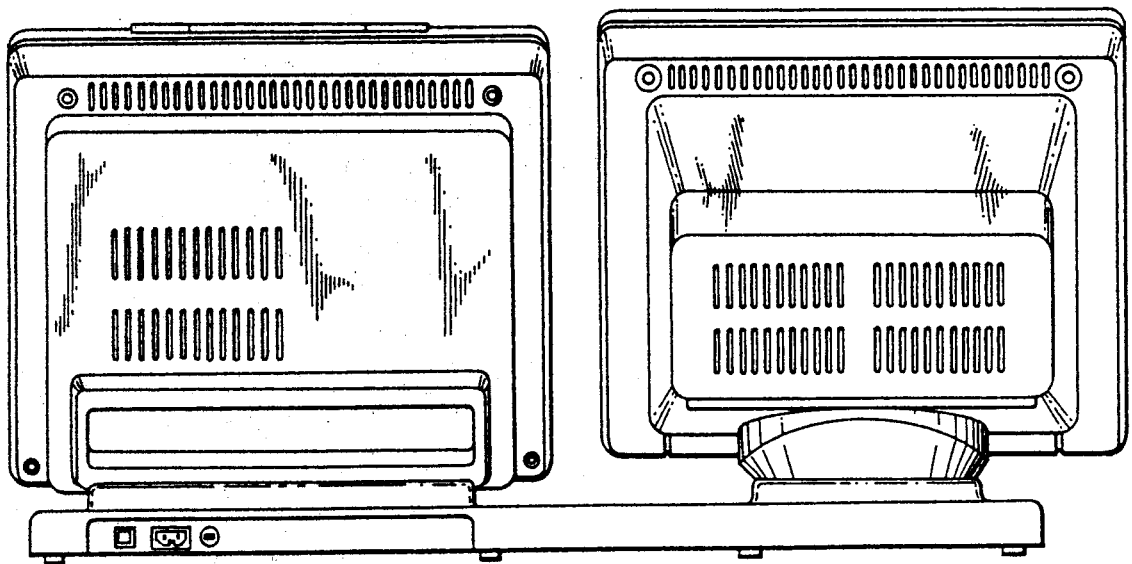

FIG. 3

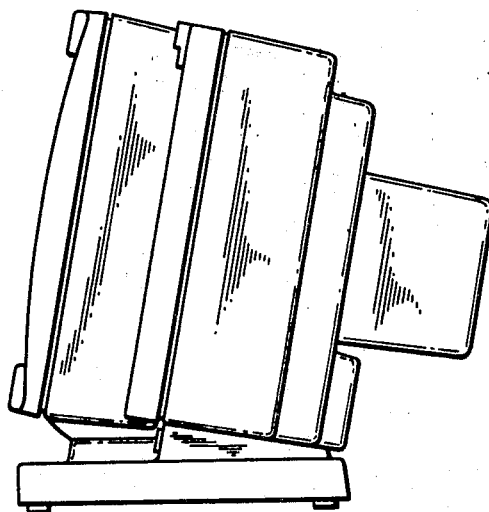

FIG. 4

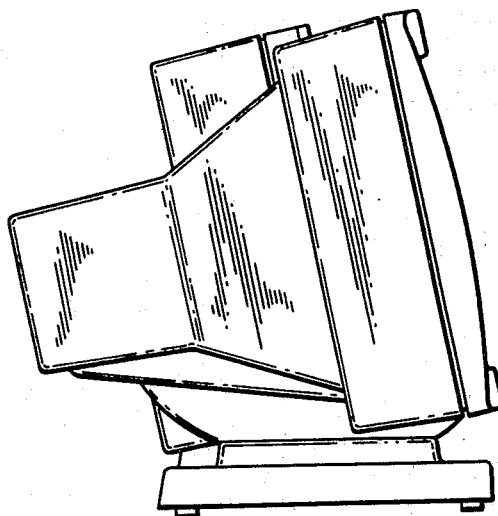

FIG. 5

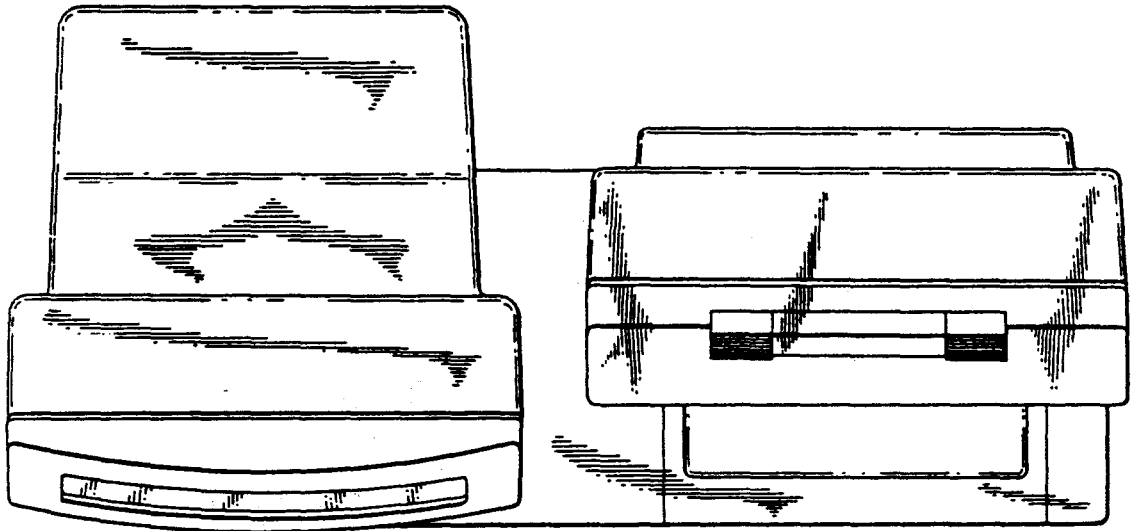

FIG. 6

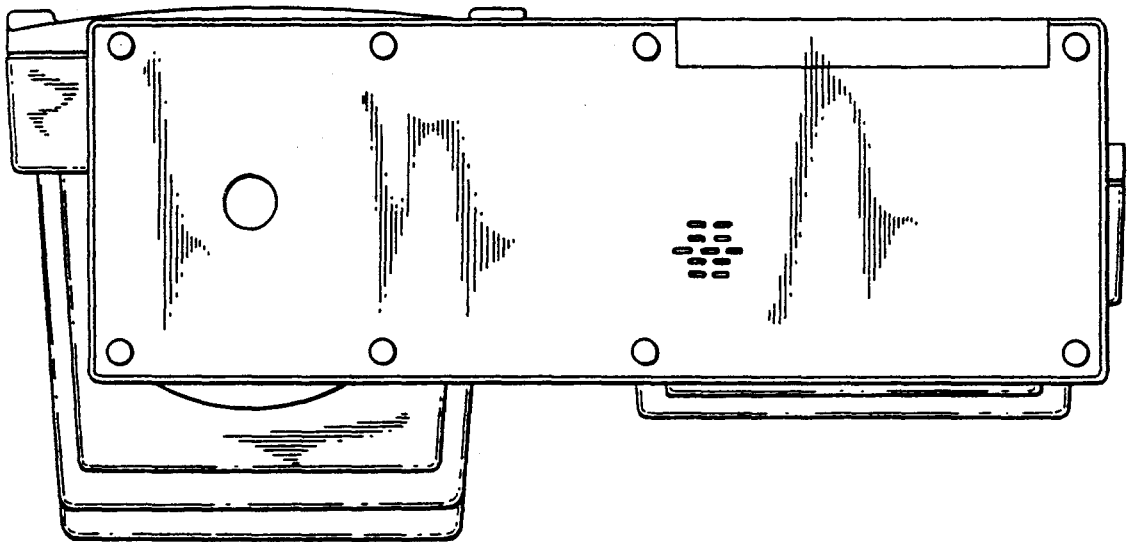

FIG. 7

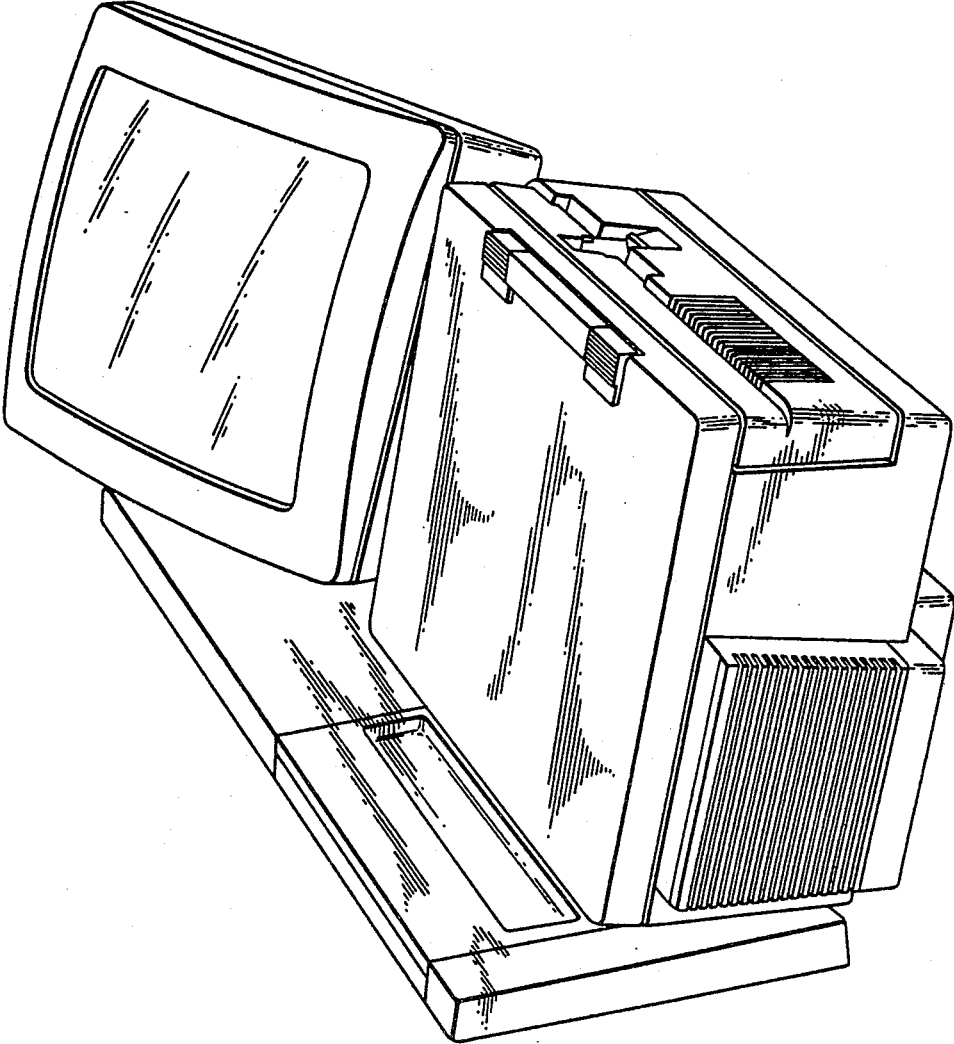

FIG. 8

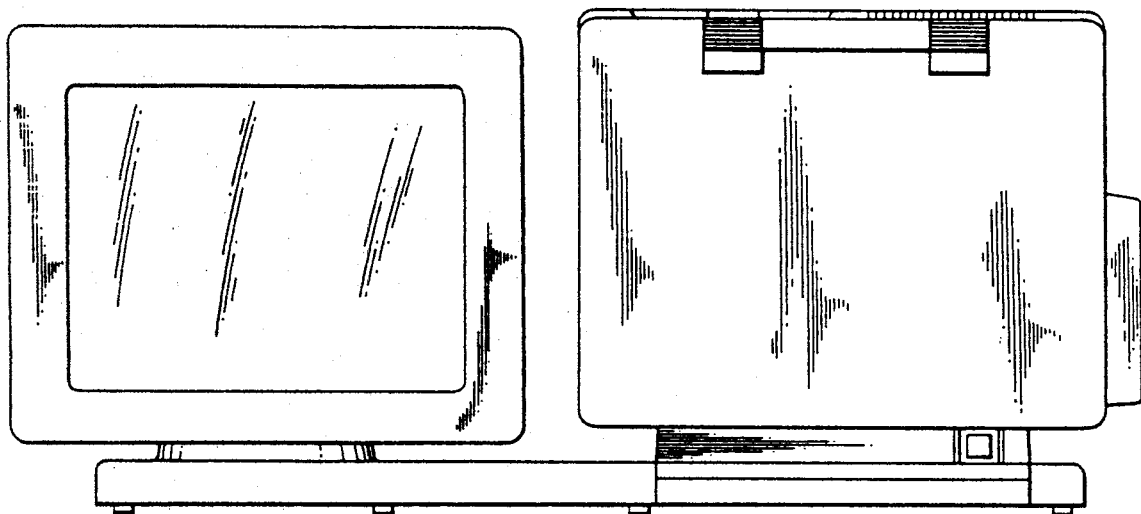

FIG. 9

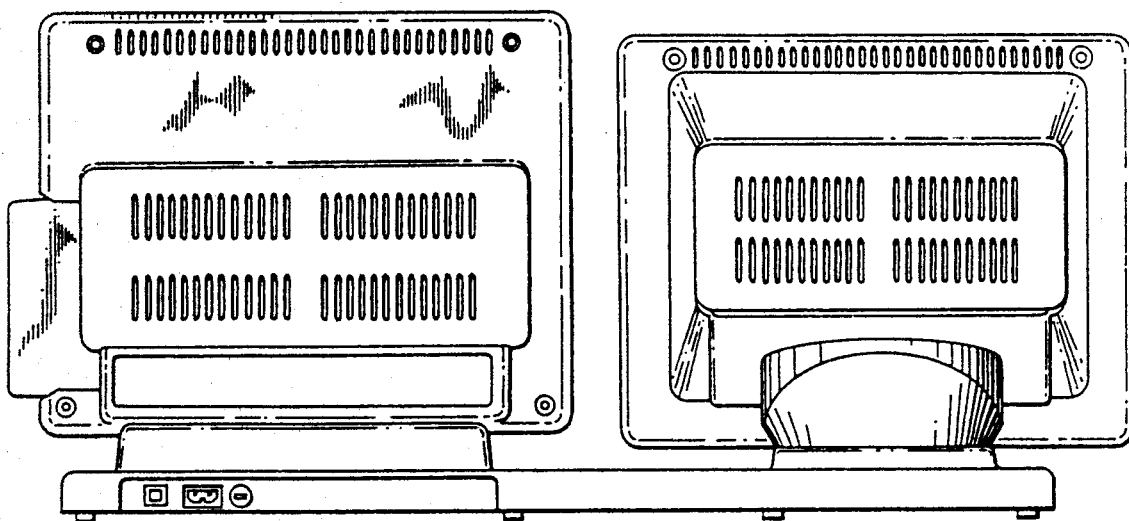

FIG. 10

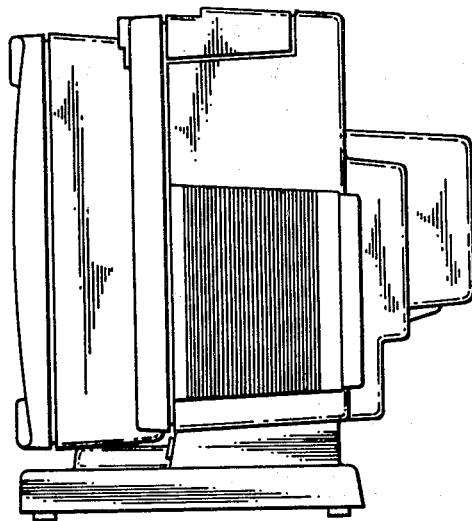

FIG. 11

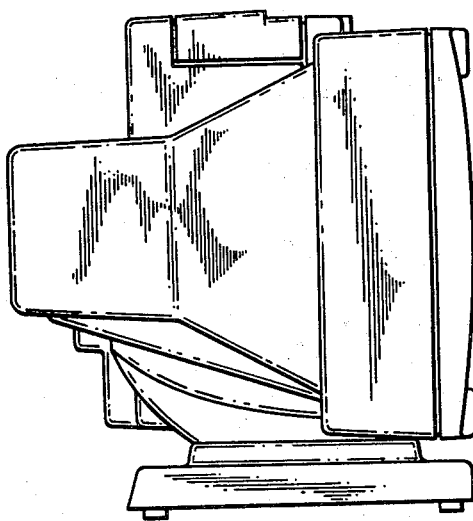

FIG. 12

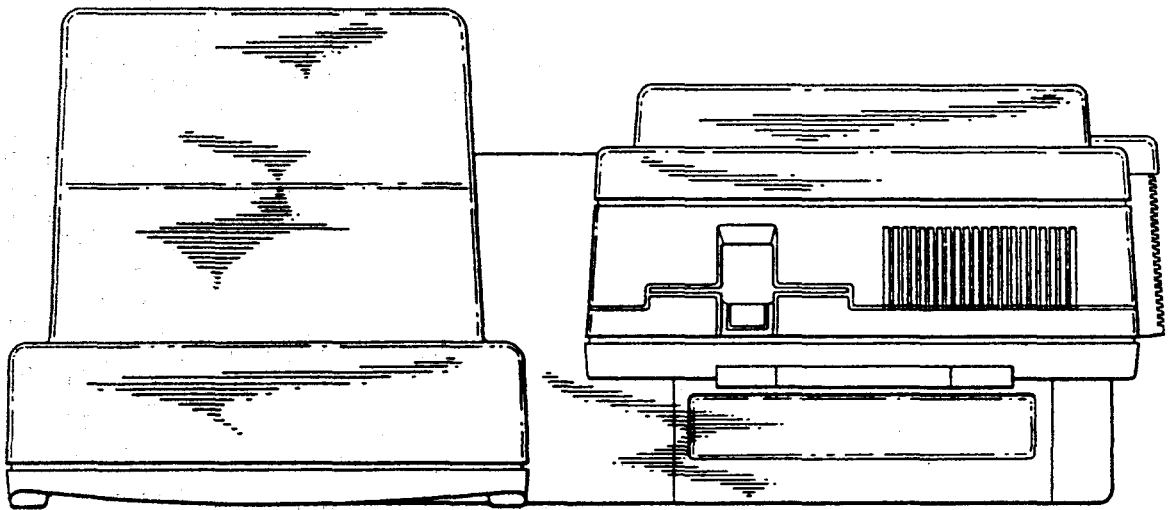

FIG. 13

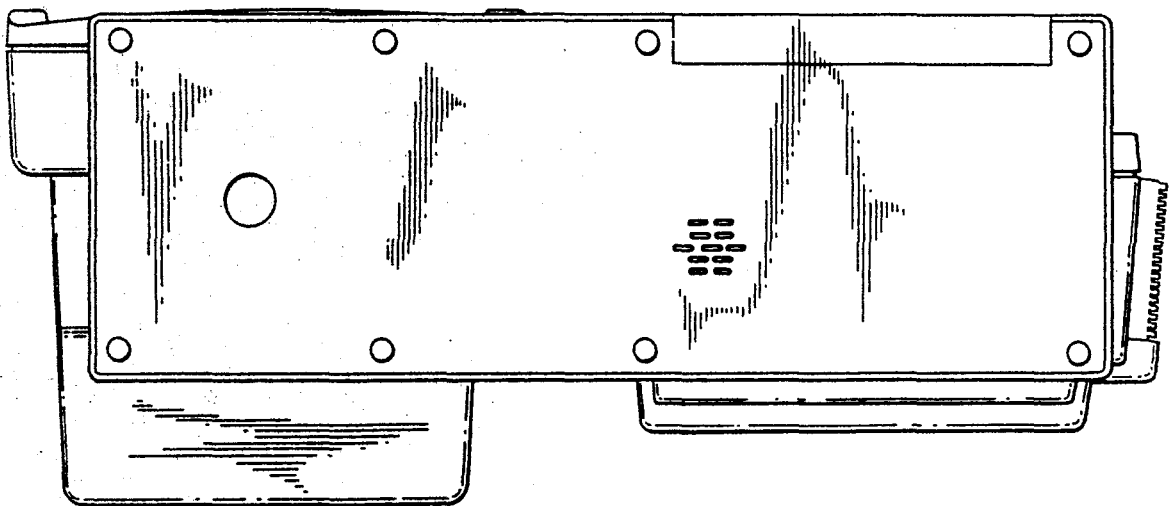

FIG. 14

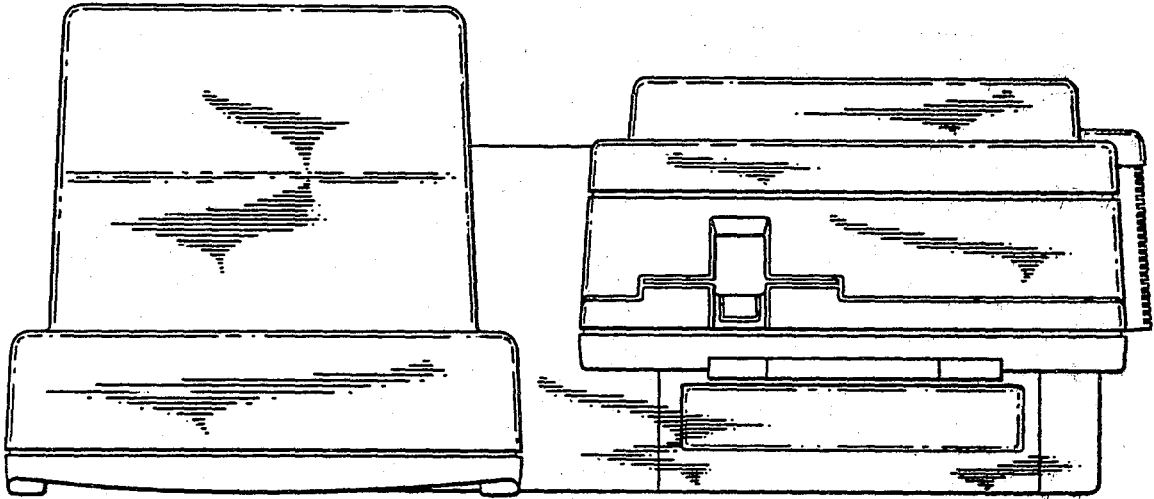

FIG 15

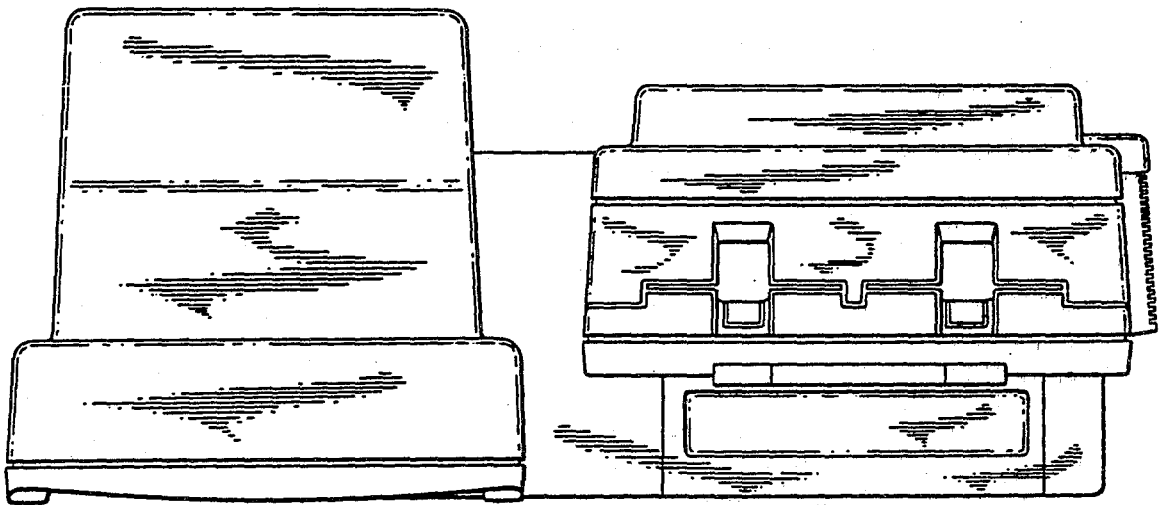

FIG 16