

ICEM Design/Drafting

Data Management for NOS

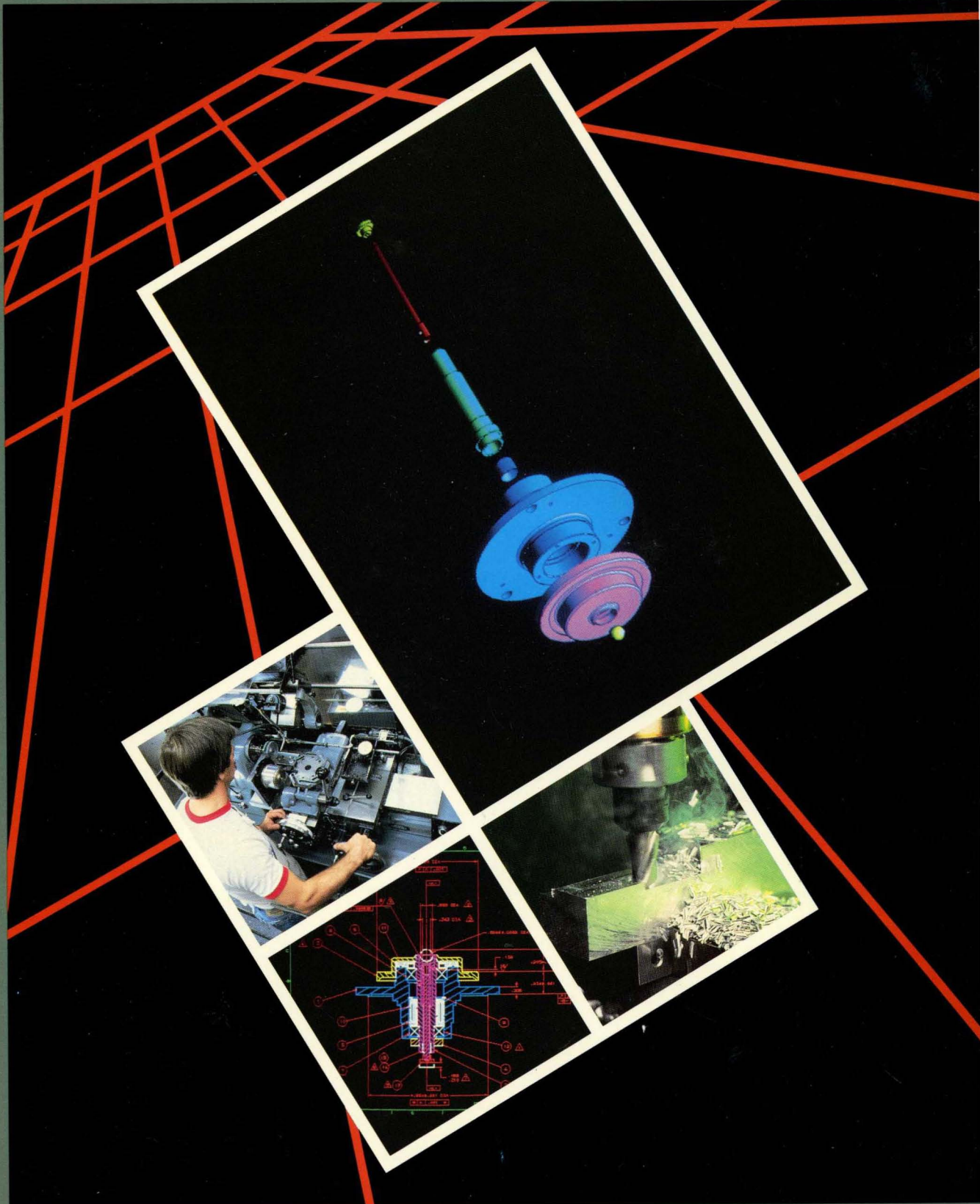

**ICEM Design/Drafting
Data Management
for NOS**

Reference

This product is intended for use only as described in this document. Control Data cannot be responsible for the proper functioning of undescribed features and parameters.

Related Manuals

Background:

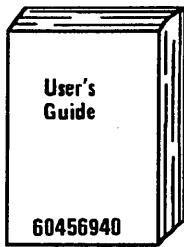

Manual Set:

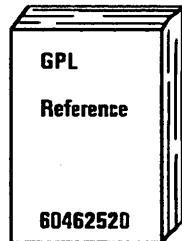
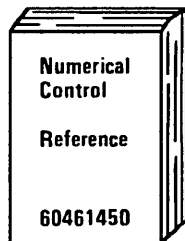
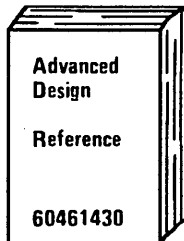
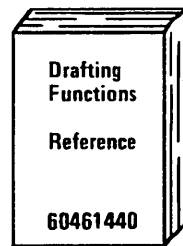
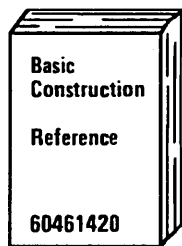
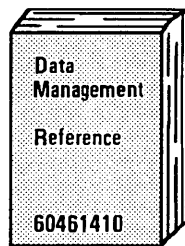
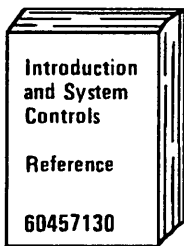

Additional:

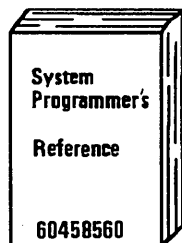
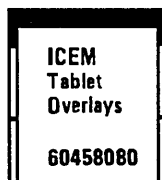

©1984, 1985 by Control Data Corporation.
All rights reserved.
Printed in the United States of America.

Manual History

Revision D documents ICEM DDN Version 1.6, printed December 1985. This revision includes enhancements and corrections to existing features or the addition of new features. The most significant changes occur within the following menu choices:

5.5 LEVEL MANAGEMENT

5.6 ATTRIBUTE MANAGEMENT (Global Attribute Modification)

6.1 PART MANAGEMENT (Global File Save and Global File Restore)

6.2 PATTERN MANAGEMENT

7.2 PLOT

7.13 TABLET MANAGEMENT

8.7 VIEW LAYOUT CONSTRUCTION (View Alignment)

This revision also includes other technical and editing changes.

Previous Revision	System Version	Date
A	1.53	November 1984
B	1.53	January 1985
C	1.57	May 1985

Contents

About This Manual	7	7.8 Regen from N1 to N2	3-9
Audience	7	7.9 Regen All	3-9
Organization	7	7.10 Bulk Data Input	3-10
Conventions	8	7.11 Reserved for Future Use	3-18
Additional Related Publications	8	7.12 Mesh Generator Interface	3-19
Ordering Manuals	9	7.13 Tablet Management	3-21
Submitting Comments	9		
MENU 5: Special Functions	1-1	MENU 8: Display Control	4-1
Using Menu 5	1-1	Using Menu 8	4-1
5.1 Canon	1-3	Suggestions for Using This Menu	4-3
5.2 GRAPL	1-10	Isometric Drafting	4-5
5.3 Manage Variables	1-17	8.1 Modals	4-6
5.4 User-Defined Symbols	1-19	8.2 Change Depth	4-23
5.5 Level Management	1-25	8.3 Display a Single View	4-23
5.6 Attribute Management	1-30	8.4 Display Multiple Views	4-25
5.7 Reserved for Future Use	1-51	8.5 Change Work View	4-30
5.8 User Text Entry	1-52	8.6 Zoom	4-31
5.9 Misc. Construction	1-53	8.7 View Layout Construction	4-42
5.10 Nesting	1-54	8.8 Display Name Management	4-59
5.11 Named Entities	1-65	8.9 Define Auxiliary View	4-65
5.12 Pipework Interference	1-68	8.10 Z-Clip	4-68
5.13 GPL	1-69	8.11 Change Work Space	4-69
		8.12 Define Work Space	4-70
		8.13 Align View/Work Spaces	4-77
MENU 6: Data Base Management	2-1	Glossary	A-1
Using Menu 6	2-1	 	
6.1 Part Management	2-2	Uniplot Interface Utility Package	B-1
6.2 Pattern Management	2-26	 	
6.3 Template Management	2-56	Files Used in ICEM DDN	C-1
6.4 Reserved for Future Use	2-66	 	
6.5 User Tech File Management	2-67	ICEM DDN to ICEM TEKROUTE	
6.6 Data Base Information	2-71	Interface	D-1
6.7 Dump Current Part	2-79	 	
 		IGES-ICEM DDN (IGES V2.0,	
MENU 7:		Translators V1.0)	E-1
Input/Output/Regeneration	3-1	 	
Using Menu 7	3-1	Index	Index-1
7.1 Reserved For Future Use	3-2	 	
7.2 Plot	3-2	Figures	
7.3 Display Last Seq. No. Used	3-8	1-1. Entity Information Tables	1-3
7.4 Display Entity Seq. No.	3-8	1-2. TAB1 Data	1-4
7.5 Identify Entity #N	3-8	1-3. CATALOG Statement of	
7.6 Identify Entities N1 to N2	3-8	GRAIOF.	1-17
7.7 Regen Entity #N	3-9		

1-4. Grids for User-Defined Symbols	1-20	3-5. Tablet Page with Defined Squares	3-42
1-5. Nesting a Part at a Plate Edge or Check Curve	1-64	3-6. User Tablet Pages List	3-43
2-1. Part Management	2-3	4-1. Eight Standard Views with Names.	4-29
2-2. Parts List	2-15	4-2. Before Zooming	4-32
2-3. Entity Name Deletion Table	2-21	4-3. Zoom Work View (1/2 Scale)	4-32
2-4. Check and Renew Current Part Problem Report	2-25	4-4. Zoom All Views (1/2 Scale)	4-33
2-5. Pattern Management	2-26	4-5. Zoom Entire Layout (1/2 Scale)	4-33
2-6. Primary Pattern Library List	2-46	4-6. Aligning Views Using Reference View Scale	4-56
2-7. Secondary Pattern Library List	2-47	4-7. Aligning Views with Scale Unchanged	4-57
2-8. Template Management	2-56	4-8. Front and Auxiliary Views-- Cannot be Aligned Because of Rotation.	4-58
2-9. Listing of On-line Templates	2-66	4-9. Front and Auxiliary Views-- Cannot be Aligned Because of Fold Angle	4-58
2-10. UTF Management	2-67	4-10. Listing of 8.8.2 LIST VIEWS	4-60
2-11. UTF List	2-68	4-11. Listing of 8.8.5 LIST SAVED ZOOM SCALES.	4-62
2-12. Count of Entities Defined in Each View	2-72	4-12. Listing of 8.8.8 LIST LAYOUTS.	4-64
2-13. Count of Entities Defined on Each Level	2-73	4-13. Listing of 8.8.9 LIST VIEWS IN A LAYOUT	4-64
2-14. Count of Entity Types in View and Level Range	2-74	B-1. Steps in Creating a Plot Using UNIPOST with the UNIPLOT Interface	B-3
2-15. Entity Data in View and Level Range	2-76		
2-16. Current Part Space Display	2-76	Tables	
2-17. Part File Space Display	2-76	1-1. Code Numbers of Entity Types (2.TYPE in Figure 1-2)	1-6
2-18. Pattern File Space Display	2-77	1-2. Text Editing Commands	1-11
2-19. UTF Space Display	2-77	1-3. Attribute Data Format	1-46
2-20. View Transformation Matrix Display	2-78	1-4. Text Editing Commands	1-52
2-21. View Translation Vector Display	2-78	3-1. Tablet Programming Control Characters	3-51
2-22. Common Values (Integer Array).	2-81	C-1. ICEM DDN Local Files	C-1
2-23. Common Values (Real Array).	2-83	C-2. Default File Content Limits	C-2
3-1. Plot Paper Offset Distances	3-4		
3-2. Bulk Data File	3-10		
3-3. Bulk Data Display	3-11		
3-4. MSTRING File Format	3-32		

About This Manual

This manual describes the CONTROL DATA® Integrated Computer-aided Engineering and Manufacturing Design/Drafting/Numerical Control (ICEM DDN) software system. This volume describes the ICEM DDN system's capability to store, manage, and display information on entities and parts.

Audience

This manual is a reference source for design engineers and drafting personnel who have already had initial training in the use of the ICEM DDN system. It is not intended to be a tutorial guide to ICEM DDN. New users should refer to the ICEM Design/Drafting User's Guide for a step-by-step introduction to the ICEM DDN system.

Organization

This manual documents the following ICEM DDN menus: Chapter 1 describes menu 5 SPECIAL FUNCTIONS, chapter 2 describes menu 6 DATA BASE MANAGEMENT, chapter 3 describes menu 7 INPUT/OUTPUT/REGENERATION, and chapter 4 describes menu 8 DISPLAY CONTROL.

This manual is part of the ICEM DDN manual set.

The ICEM Design/Drafting Introduction and System Controls manual gives an overview of the major ICEM DDN concepts and describes menus 1 through 4 of the main menu: modals and fonts, blank/unblank operations, delete operations, and the file/terminate sequence.

The ICEM Design/Drafting Basic Construction manual describes menus 9 through 14 of the main menu: point construction, line construction, arc construction, special curve construction, entity manipulation, and data verification.

The ICEM Design/Drafting Drafting Functions manual describes menus 16, 18, and 19: drafting functions, analysis, and SI/US resize.

The ICEM Advanced Design manual describes menu 15 ADVANCED DESIGN, which covers three-dimensional curves and surfaces.

The ICEM Numerical Control manual describes menu 17 NUMERICAL CONTROL, the numerical control programming part of ICEM DDN.

The ICEM GPL manual describes menu 5.13 GPL and the GPL programming language.

Conventions

In this manual, headings contain a series of numbers separated by periods. These numbers represent the selections available within the ICEM DDN menu hierarchy. The first number in the heading is the main menu choice, the second number is from the second-level menu, and so on. For example, menu choice 12.7.3 HEXAGON is from the third level of the menu hierarchy.

When the word *system* is used, it refers to the ICEM DDN software system. When the Network Operating System is referred to, it is called either NOS or the operating system.

All text that the system displays is shown in uppercase letters and highlighted with a special typeface, as shown below:

```
PEN THICKNESS
 1.ON
 2.OFF
 3.SET PEN THICKNESS
```

Additional Related Publications

You can find related information in the following publications:

Manual Title	Publication Number
Network Products Interactive Facility Version 1 Reference Manual	60455250
Network Products Interactive Facility Version 1 User's Guide	60455260
NOS Version 1 Reference Manual, Volume 1	60435400
UNIPLLOT Version 3 User's Guide/Reference Manual	60454730
Automatically Programmed Tooling System (APT IV)	17326900
XEDIT Version 3 Reference Manual	60455730
Graphics Terminal Assist Version 1 User's Guide/Reference Manual	60476100
NOS Full Screen Editor User's Guide	60460420
Remote Batch Facility Version 1 Reference Manual	60499600
NOS 2 Reference Set, Volume 1 Introduction to Interactive Usage	60459660
NOS 2 Reference Set, Volume 2 Guide to System Usage	60459670
NOS 2 Reference Set, Volume 3 System Commands	60459680
ICEM Design/Drafting GRAPL Programming Language	60461460
ICEM Schematics Reference Manual	60456540

Manual Title	Publication Number
ICEM Schematics User's Guide	60462490
ICEM User-Defined Tablet Overlay	60457650
ICEM Engineering Data Library Reference Manual	60459740
ICEM TEKROUTE Reference Manual	60455880

Ordering Manuals

Control Data manuals are available through Control Data sales offices or through Control Data Corporation Literature Distribution Services (308 North Dale Street, St. Paul, Minnesota 55103).

Submitting Comments

The last page of this manual is a comment sheet. Please use it to give us your opinion of the manual's usability, to suggest specific improvements, and to report technical or typographical errors. If the comment sheet has already been used, you can mail your comments to:

Control Data Corporation
Publications and Graphics Division ARH219
4201 Lexington Avenue North
St. Paul, Minnesota 55126-6198

Please indicate whether you would like a written response.

Menu 5: Special Functions

1

Using Menu 5	1-1
5.1 CANON	1-3
Select the Entity	1-3
Display TAB1 (Entity Master List)	1-4
Display TAB2	1-7
Display TAB3	1-7
Modify TAB2 and TAB3	1-8
5.2 GRAPL	1-10
5.2.1 Variable Calculation	1-10
5.2.2 Input/Edit GRAPL Program	1-11
5.2.3 Auto GRAPL	1-13
5.2.4 Run GRAPL Program	1-14
5.2.5 Continue GRAPL Program	1-14
5.2.6 Delete GRAPL from UTF	1-14
5.2.7 Input GRAPL to UTF	1-15
5.2.8 Output GRAPL from UTF	1-15
5.2.9 Input GRAPL to GUTF	1-16
5.3 Manage Variables	1-17
5.3.1 Move Variables from UTF to RTL	1-17
5.3.2 Move Variables from RTL to UTF	1-18
5.3.3 List Technology File Variables	1-18
5.3.4 List Run Time Library Variables	1-18
5.4 User-Defined Symbols	1-19
Terminate	1-21
Define or Replace Symbol	1-22
Delete Symbol	1-23
Display Symbol	1-24
List Symbols	1-24
5.5 Level Management	1-25
5.5.1 Change Current Level/Pen Numbers	1-25
5.5.2 Define Levels	1-26
5.5.3 List Levels	1-27
5.5.4 Delete Levels	1-27
5.5.5 Create/Assign Level Table	1-28
5.5.6 Create/Modify Pen Table	1-29
5.5.7 Execute Pen Table	1-29
5.6 Attribute Management	1-30
5.6.1 Create	1-31
5.6.2 Modify	1-32
5.6.2.1 Screen Select Entity	1-33
Inserting New Attributes	1-34
Deleting Attributes	1-35
Replacing Attributes	1-35
5.6.2.2 Search for Named Attribute	1-36
5.6.3 Copy	1-42
5.6.4 Delete	1-43
5.6.5 Display	1-43

5.6.6 Identify	1-43
5.6.7 Search	1-44
5.6.8 List on File	1-46
5.6.9 Report Generation	1-47
Retrieving the Entities	1-47
Describing the Report Ordering	1-48
Formatting the Report	1-49
5.7 Reserved for Future Use	1-51
5.8 User Text Entry	1-52
5.9 Misc. Construction	1-53
5.9.1 Girth Point - Dist Along a Curve	1-53
5.9.2 Line - at Angle with a Curve	1-53
5.9.3 Arc - Polar from an Arc	1-54
5.9.4 Verify Screen Position	1-54
5.10 Nesting	1-54
Kerf Distance Definition	1-54
Boundary Plate Definition	1-55
Original Placement	1-56
Absolute	1-57
Relative to Plate	1-60
Relative to a Single Check Curve	1-61
Relative to Two Check Curves	1-61
Regional Translate-Rotate	1-62
Delete Part	1-63
Adjustment Placement	1-65
5.11 Named Entities	1-65
5.11.1 List Names	1-66
5.11.2 Attach Name to Entity	1-67
5.11.3 Detach Name from Entity	1-67
5.11.4 Search for Name	1-68
5.12 Pipework Interference	1-68
5.13 GPL	1-69
5.13.1 Recover Last File	1-69
5.13.2 Continue GPL Program	1-69
5.13.3 Run GPL Program	1-69
5.13.4 List GPL Names	1-69
5.13.5 Change Library Name	1-70

Using Menu 5

Special Functions provides you with a variety of specialized functions for the management of variables, levels and attributes, user text entry, and user-defined symbols. In addition, it includes named entities, CANON, nesting, pipework interference, and miscellaneous constructions. All of these functions are used mainly by the experienced system user.

The menu for this chapter is:

- SPECIAL FUNCTIONS
- 1. CANON
- 2. GRAPL
- 3. MANAGE VARIABLES
- 4. USER-DEFINED SYMBOLS
- 5. LEVEL MANAGEMENT
- 6. ATTRIBUTE MANAGEMENT
- 7.
- 8. USER TEXT ENTRY
- 9. MISC. CONSTRUCTION
- 10. NESTING
- 11. NAMED ENTITIES
- 12. PIPEWORK INTERFERENCE
- 13. GPL

The Special Functions menu offers these functions:

Menu Title	Function Description
5.1 CANON	Displays and modifies data base information about an entity in a current part. This is an advanced user capability.
5.2 GRAPL	Allows for customized parts or logic sequences to create a part or process. Refer to the ICEM Design/Drafting GRAPL Programming Language manual for a complete description of GRAPL.
5.3 MANAGE VARIABLES	Moves variables in the user technology file and run-time library. Also lists the variables in the user technology file.
5.4 USER-DEFINED SYMBOLS	Defines special sets of characters or symbols.
5.5 LEVEL MANAGEMENT	Defines, lists, modifies, and deletes level numbers and names. Also, creates and modifies pen numbers.
5.6 ATTRIBUTE MANAGEMENT	Assigns attributes (such as names and values) to individual entities in a part.
5.7 Reserved for Future Use	

Menu Title	Function Description
5.8 USER TEXT ENTRY	Enters and edits lines of text into user technology files (UTF).
5.9 MISC. CONSTRUCTION	Performs less common entity construction operations.
5.10 NESTING	Allows nesting of templates with or without a plate boundary.
5.11 NAMED ENTITIES	Assigns names to specified entities.
5.12 PIPEWORK INTERFERENCE	Indicates whether two pipes interfere in space.
5.13 GPL	Executes precompiled GPL programs.

The remainder of this chapter describes the choices in menu 5.

5.1 CANON

With this choice, you can display information about an entity stored in the data base for the current part. You can also modify certain pieces of that information. CANON is an advanced user capability.

The system stores entities defined in ICEM DDN on disk. ICEM DDN considers an entity definition page in computer memory as a table. Entities can have three tables, TAB1, TAB2, and TAB3 (refer to figure 1-1). TAB1 is a master list of data associated with an entity. Every entity has an entry in TAB1.

TAB2 stores integer data associated with the entity, and TAB3 stores real data associated with the entity. A given entity may or may not have TAB2 and TAB3 information associated with it. You can use CANON to modify TAB2 and TAB3 data, in the following sequence:

1. Select the entity.
2. Display the entity master list (TAB1).
3. Display and modify entity data (TAB2 and TAB3).
4. Insert and delete entity data (TAB2 and TAB3).

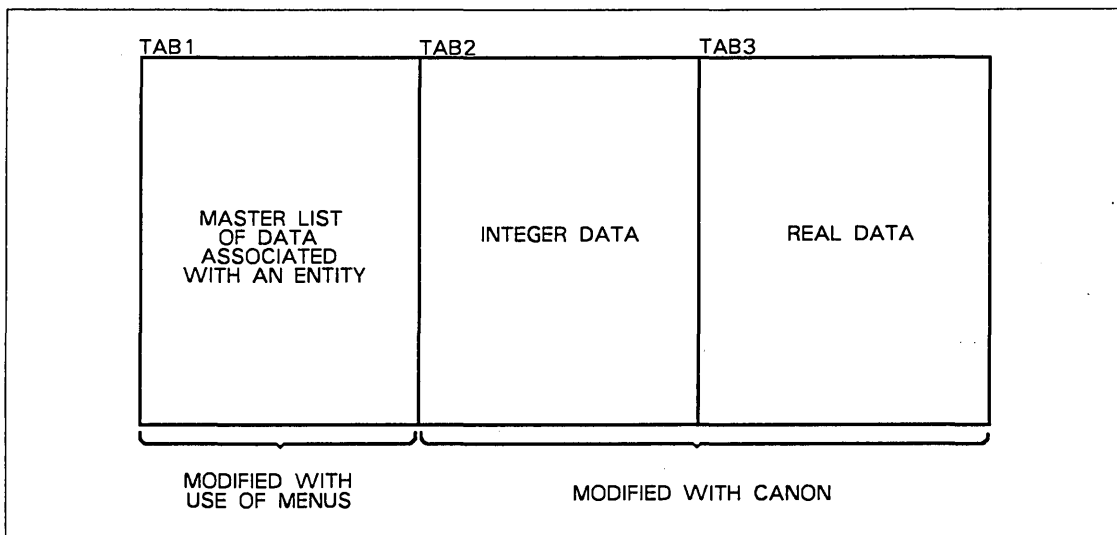

Figure 1-1. Entity Information Tables

Select the Entity

When you select this choice, the system displays:

INDICATE ENTITY

Use the graphics cursor to screen select the entity for which you want to display data base information.

If you want to use another method of selection, enter E or CTRL-E to receive the following menu:

ENTITY SELECTION

- 1.SCREEN SELECT
- 2.CHAIN
- 3.REGION IN

⋮

Use the Entity Selection menu to select the entity. For more information, refer to the ICEM Design/Drafting Introduction and System Controls manual.

Display TAB1 (Entity Master List)

When the entity is selected, the system displays the characteristics of the entity by listing the TAB1 data. Figure 1-2 shows an example of a TAB1 data listing.

TAB1 DATA	
1.POINTER:	1038
2.TYPE:	8
3.FORM:	1
4.BLANKED?:	NO
5.DELETABLE?:	YES
6.DORMANT?:	NO
7.FONT:	SOLID
8.DISPLAY:	ALL VIEWS
9.GROUP CTR:	0
10.SEQ NO:	3
11.ATTRIBUTES CTR:	0
12.ATTN PT U,V:	644, 2596
13.NO OF TAB2 WORDS:	1
14.NO OF TAB3 WORDS:	11
15.LEVEL:	0
16.VIEW NO:	1
17.PEN NO:	0
18.NAME:	NOT NAMED
19.COLOR NO:	0

Characteristic	Description
1.POINTER	The pointer number of the entity selected.
2.TYPE	The data type of the entity. The entity types and codes are listed in table 1-1.
3.FORM	The data subtype of the entity. This item indicates how the entity was created.
4.BLANKED?	The entity has not been blanked and is to be displayed if it is within screen limits.
5.DELETABLE?	The entity can be deleted. If you attempt to delete an entity on which the definitions of other entities are dependent, the system makes it dormant.

Figure 1-2. TAB1 Data

(Continued)

(Continued)

Characteristic	Description
6.DORMANT?	The entity is not dormant (a dormant entity is stored in the part, but is not displayed).
7.FONT	The type of line used to display the entity.
8.DISPLAY	The entity is to be displayed in all views requested.
9.GROUP CTR	The number of groups in which this entity is included.
10.SEQ NO	The sequence number of the entity.
11.ATTRIBUTES CTR	The number of entities in whose definitions this entity is used.
12.ATTN PT U,V	The attention pointer position. These values locate the attention point in the addressable space on the terminal in use. For example, on a Tektronix model 4014 terminal, the u and v directions (horizontal and vertical) each contain 4096 addressable points.
13.NO OF TAB2 WORDS	The number of integer words of memory used to hold TAB2 data for this entity.
14.NO OF TAB3 WORDS	The number of real words of memory used to hold TAB3 data for this entity.
15.LEVEL	The level at which this entity is defined.
16.VIEW NO	The view of definition or work view when the entity was defined.
17.PEN NO	The pen number associated with the entity for plotting.
18.NAME	The entity has not been named.
19.COLOR NO	The color number associated with the entity.
Enter] to display the next screen of TAB1 data.	
TAB1 DATA CONTINUED	
1.COMPOSITE MEMBER: NO	
Characteristic	Description
1.COMPOSITE MEMBER	The entity is not a member of a composite curve.

Figure 1-2. TAB1 Data

Enter] to continue by displaying TAB2 data.

Enter [to return to menu 5.1 CANON.

Table 1-1. Code Numbers of Entity Types (2.TYPE in Figure 1-2)

Code Number	Entity Type Description	Code Number	Entity Type Description
0	Entity deleted	37	General note
1	Point	38	Center line
2	Line	39	Section lining
3	Arc/Circle/Fillet	40	Feature frame
4	Conic	41	Template
5	Spline	42	Reserved for future use
6	Composite curve	43	Reserved for future use
7	Vector	44	Reserved for future use
8	Point set	45	NC modal (GPG)
9	Three-dimensional spline	46	Lathe/profile/pocket/3-axis/ 5-axis
10	Machining curve		
11	String	47	Composite toolpath
12	Rectangular array	48	N/C utility (copious data)
13	Circular array	49	Tool
14	Copious data	50	Systems entity
15	Group	51	Reserved for future use
16	Variable	52	Hexahedron
17	Reserved for future use	53	Reserved for future use
18	Plane	54	Reserved for future use
19	Surface of revolution	55	Reserved for future use
20	Tabulated cylinder	56	Reserved for future use
21	Ruled/developable surface	57	Reserved for future use
22	Curve mesh surface	58	Reserved for future use
23	Fillet surface	59	Reserved for future use
24	Reserved for future use	60	Data point set
25	Reserved for future use	61	Data curve
26	Reserved for future use	62	Reserved for future use
27	Reserved for future use	63	Reserved for future use
28	Offset surface	64	Reserved for future use
29	Composite surface	65	Reserved for future use
30	Curve-driven surface	66	Reserved for future use
31	Bezier curve	67	Reserved for future use
32	Linear dimension	68	Reserved for future use
33	Radius dimension	69	Reserved for future use
34	General label/taper dimension	70	Schematic element
35	Diameter dimension	71	Schematic connect table entity
36	Angular dimension		

Display TAB2

If the selected entity has TAB2 data, the system displays:

DISPLAY TAB2?

Enter:

Y To display TAB2 data.

N To omit the display of this information.

If you enter Y, the system displays up to 10 TAB2 values at a time. Enter] to display values in sets of 10. The meaning of the information in TAB2 depends on how the entity was defined.

1.VALUE 1 = value 1
2.VALUE 2 = value 2
:
n.VALUE n = value n

Inspect the TAB2 values. You can modify any displayed value by entering a new value. The new value can be a constant or a variable name, but not a variable expression.

NOTE

Use caution when modifying entity data in TAB2; the system does not check for illegal data.

Enter] or [to continue.

Display TAB3

If the selected entity has TAB3 data, the system displays:

DISPLAY TAB3?

Enter:

Y To display TAB3 data.

N To omit the display of this information.

If you enter Y, the system displays up to 10 TAB3 values at a time. Enter] to display values in sets of 10. The meaning of the information in TAB3 depends on how the entity was defined.

1.VALUE 1 = value 1
2.VALUE 2 = value 2
:
n.VALUE n = value n

Inspect the TAB3 values. You can modify any displayed value by entering a new value. The new value can be a constant or a variable name, but not a variable expression.

Modify TAB2 and TAB3

The system prompts you for modifications to selected items (words) within these blocks.

- INSERTIONS AND DELETIONS
- 1.INSERT TAB2
 - 2.INSERT TAB3
 - 3.DELETE TAB2
 - 4.DELETE TAB3
 - 5.REDISPLAY TAB2 AND TAB3

Enter:

- 1 To insert information into the TAB2 block. The system displays:

INSERT LOCATION =

Enter the location of the word after which additional data is to be inserted. For example, enter 1 to specify that the additional data is to be inserted between the current first and second words of data. Enter 0 to insert data before the first word.

VALUE =

Enter the values for one or more consecutive words to be inserted after the specified location. The format for the entry and the allowable range of values depends on the entry selected. Pressing] before you enter a value for any given word terminates the entry.

- 2 To insert information into the TAB3 block. (The prompts and actions are the same as for entry 1.)
- 3 To delete information from the TAB2 block.

1.START =

2.END =

Enter the starting and ending word number of the words to be deleted. For example, START = 1 and END = 3 indicate that the current first three words of data are to be deleted.

If either the starting or the ending word number is omitted, the system displays:

START > END--REENTER VALUES!

- 4 To delete information from the TAB3 block. (The prompts and actions are the same as for entry 3.)

5 To redisplay information in either TAB2 or TAB3. The system displays:

DISPLAY TAB2 ?

Enter:

Y To display TAB2.

N To continue to the TAB3 display prompt.

If you display TAB2, you can modify values in TAB2 as previously described. The system displays:

DISPLAY TAB3 ?

Enter:

Y To display TAB3.

N To return to the entity selection prompt.

You can modify TAB3 values as previously described.

5.2 GRAPL

With this choice, you can access GRAPL functions. Using the GRAPL language, you can write programs to generate ICEM DDN part drawings.

The menu for this chapter is:

- ```

GRAPL
1.VARIABLE CALCULATION
2.INPUT/EDIT GRAPL PROGRAM
3.AUTO GRAPL
4.RUN GRAPL PROGRAM
5.CONTINUE GRAPL PROGRAM
6.DELETE GRAPL FROM UTF
7.INPUT GRAPL TO UTF
8.OUTPUT GRAPL FROM UTF
9.INPUT GRAPL TO GUTF

```

The following sections describe the choices in menu 5.2.

### 5.2.1 Variable Calculation

With this choice, you can define a simple variable and assign a value to it. The name of the variable must be from 1 to 6 characters, the first of which must be an alphabetic character. The value can be specified as either a constant or an expression. After successful evaluation, the variable is automatically stored in the RTL. Any variables in the right-hand part of the statement must have been previously defined and must exist in the RTL. The system displays:

```

ENTER EXPRESSION (6 CHAR NAME) Enter the assignment statement for the
 variable to be evaluated.

```

The assignment statement is entered in the following format:

```
variable = expression
```

| Parameter  | Description                                                                                  |
|------------|----------------------------------------------------------------------------------------------|
| variable   | Six-character alphanumeric name.                                                             |
| expression | Any FORTRAN-like expression using simple values, functions, or previously defined variables. |

The system calculates and displays the value of the variable.

```
variable = n.nnnn
```

The system returns to the ENTER EXPRESSION prompt. You can continue to enter variables at this time. Enter ] to return to 5 SPECIAL FUNCTIONS.

The variables stored in the RTL can be referenced in a GRAPL program. These variables can also be used wherever ICEM DDN requests a value.

## 5.2.2 Input/Edit GRAPL Program

With this choice, you can create or edit GRAPL programs, compile them, and store them in the UTF for subsequent execution. When you select this choice, the system displays:

ENTER SIX CHARACTER NAME

Enter the name of the program to be created or modified.

The system searches the UTF for the specified program name. If the program is found, it is assigned to the editor so you can modify it. If the program is not in the UTF, a new program can be created with that name. In either case, the system displays:

LAST LINE = n

Use the GRAPL text editor to create or modify the GRAPL program. If the specified program was found in the UTF, n indicates the line number of the last line of the program. If a new program is being created, n=0.

#

The number sign indicates that you have entered the GRAPL editor, and you can enter an editor command. Each time an editor command is processed, the number sign is displayed to indicate that the editor is ready for the next editor command. Table 1-2 lists the text editing commands.

**Table 1-2. Text Editing Commands**

| Command  | Description                                                                                                                                                                                                                                                                                                                                                                                                                                                 |
|----------|-------------------------------------------------------------------------------------------------------------------------------------------------------------------------------------------------------------------------------------------------------------------------------------------------------------------------------------------------------------------------------------------------------------------------------------------------------------|
| Dn1[,n2] | Deletes lines n1 through n2 from the GRAPL program. If n2 is omitted, only line n1 is deleted. If both n1 and n2 are omitted, the system issues the message INVALID DELETION.                                                                                                                                                                                                                                                                               |
| F        | Instructs the editor to: <ul style="list-style-type: none"> <li>• File the updated source copy of the current GRAPL program in the UTF as type 4.</li> <li>• Compile the source code.</li> <li>• Store the object code in the UTF as type 7 if there are no compilation errors.</li> </ul> If compilation errors occur, error messages are displayed with their associated line numbers. Object programs with compilation errors are not stored in the UTF. |
| In       | Adds or inserts lines. Lines you enter after this command are inserted after line n. Press the RETURN key once to indicate the end of a line of inserted data. To terminate an insert operation, press the RETURN key twice in succession. To create a new program, use I0, that is, n=0.                                                                                                                                                                   |

*(Continued)*



**Table 1-2. Text Editing Commands (Continued)**

| <b>Command</b>    | <b>Description</b>                                                                                                                                                                                                                                                                                                                                                                                                     |
|-------------------|------------------------------------------------------------------------------------------------------------------------------------------------------------------------------------------------------------------------------------------------------------------------------------------------------------------------------------------------------------------------------------------------------------------------|
| <b>Q</b>          | Terminates the edit session without updating the GRAPL program in the UTF. All work performed since entering the editor is lost.                                                                                                                                                                                                                                                                                       |
| <b>Rn1[,n2]</b>   | Replaces lines n1 through n2 with the lines you enter after this command. If n2 is omitted, only line n1 is replaced. You can enter any number of lines to replace the lines deleted. Press the RETURN key once to indicate the end of a line. To terminate the replace operation, press the RETURN key twice in succession. A replace operation is equivalent to a delete operation, followed by an insert operation. |
| <b>T[n1][,n2]</b> | Displays lines n1 through n2 of the GRAPL program. If n2 is omitted, only line n1 is displayed. If both n1 and n2 are omitted, all lines of the program are displayed.                                                                                                                                                                                                                                                 |

Individual lines cannot contain more than 63 characters. If the line contains more than 63 characters, the system displays:

LINE TOO LONG

If the program is too long to be filed in the UTF (approximately a 4000-character limit), the system displays:

PROGRAM TOO LONG

See menu 5.2.9 INPUT GRAPL TO GUTF for compilation of longer programs.

### 5.2.3 Auto GRAPL

With this choice, you can direct the system to automatically generate a GRAPL program for a geometric part created using ICEM DDN. The system uses the same values or variables that defined the entities in the part to construct GRAPL statements. This menu choice operates only on points, lines, circles, linear dimensions, and circular dimensions. All other entity types are ignored.

ENTER SIX CHARACTER NAME

Enter the name of the program to be generated.

INTERMEDIATE OUTPUT MODE

Enter:

- 1.DISPLAY ON SCREEN
- 2.SEND TO LFN PRINTR
- 3.NO OUTPUT

- 1 To display the automatically generated GRAPL program on the screen.
- 2 To output the program to a local file named PRINTR. The program is printed on local file named PRINTR, even if it is too long to be filed in the UTF.
- 3 To have no display of the program.

The system displays the sequence numbers of the entities above the geometric centers of the entities as it generates the program. The system files the GRAPL program in the UTF, unless it exceeds approximately 4000 characters in length. If this limit is exceeded, the system displays:

OUTPUT IS TOO BIG FOR UTF - USE LFN PRINTR

This menu choice maintains the chain of ancestry used to define entities in the part. To avoid breaking this chain by deleting entities, you can put all the construction entities on one level, so that they can be blanked, but still be available in the data base for AUTO GRAPL generation.





## 5.2.9 Input GRAPL to GUTF

With this choice, you can compile a GRAPL program that resides on a local, external source file named GRAIOF. The system then stores the object program automatically in another local external file named GUTF, providing no errors are encountered. If no GUTF exists, one is created.

---

### NOTE

This menu choice's primary function is compiling long GRAPL, that is, programs that are too long for the UTF.

---

Each GRAPL program must be contained in one record on GRAIOF, followed by an end-of-record mark (EOR), and preceded by the program name (from 1 to 6 alphanumeric characters, the first of which must be an alphabetic character) as the first line of the record.

If the specified program is found on GRAIOF, the statements are compiled to executable object format and input to GUTF.

---

### NOTE

This long program format is incompatible with the UTF object format; therefore programs stored on the UTF and saved in the GUTF by menu 6.5.3 SAVE ON GLOBAL UTF will execute from the UTF, but not directly from the GUTF. Refer to 6.5.3 SAVE ON GLOBAL UTF and 6.5.4 RESTORE FROM GLOBAL UTF for UTF/GUTF file management.

---

The system rewinds GRAIOF and searches for a text record with the given name until it encounters an EOF. If the system cannot find the text record, it displays:

PROGRAM NOT FOUND

If there is a text record with the specified name, but the record does not contain any other lines, the system displays:

NO PROGRAM ON FILE

Any errors encountered during compilation are listed with their respective line numbers on the screen, and the compiled object program is not filed. In this case, subsequent execution is impossible.

The contents of GRAIOF or GUTF can be listed external to ICEM DDN using the NOS system CATALOG statement (refer to the NOS 1 Reference Manual, Volume 1, or to the NOS 2 Reference Set, Volume 3).

Figure 1-3 shows a sample CATALOG statement of GRAIOF.

```

GET, GRAIOF
/CATALOG, GRAIOF, N, R
 CATALOG OF GRAIOF FILE 1
 REC NAME TYPE LENGTH CKSUM DATE
 1 PISTNS TEXT 153 3723
 2 SS1 TEXT 13 5524
 3 SS2 TEXT 13 2745
 4 SS3 TEXT 11 4463
 5 SS4 TEXT 14 5455
 6 SS5 TEXT 53 2653
 7 DRAW TEXT 134 6755
 8 * EOF * SUM = 435
 CATALOG OF GRAIOF FILE 2
 REC NAME TYPE LENGTH CKSUM DATE
 * EOI * SUM = 0
CATALOG COMPLETE.
/

```

Figure 1-3. CATALOG Statement of GRAIOF

The contents of a local GUTF can be listed without exiting from ICEM DDN by selecting 3.LIST from 6.5.4 RESTORE FROM GLOBAL UTF.

## 5.3 Manage Variables

With this choice, you can perform variable management functions.

The menu for this section is:

- ```

MANAGE VARIABLES
1.MOVE VARIABLES FROM UTF TO RTL
2.MOVE VARIABLES FROM RTL TO UTF
3.LIST TECHNOLOGY FILE VARIABLES
4.LIST RUN TIME LIBRARY VARIABLES

```

The following sections describe the choices in this menu.

5.3.1 Move Variables from UTF to RTL

With this choice, you can move variables (and their values) from permanent storage in the UTF to the RTL for use in current part construction. This operation provides a way of retrieving variables and values that were saved in the UTF during a previous session with the system. After execution of this operation, the variables requested are available for use during your current session.

ENTER VARIABLE NAME(S)

Enter the names of the variables to be retrieved. The names should be separated by commas. A maximum of 34 characters can be entered.

5.3.2 Move Variables from RTL to UTF

With this choice, you can copy variables (and their values) from the RTL to permanent storage in the UTF. The variables and their values in the RTL are not altered. You can use this operation to produce backup for variables in the UTF or to save variables for use in a later session with the system. Since the UTF is common to all parts in the data base, this operation can also move variables from one part to another.

ENTER VARIABLE NAME(S)

Enter the names of the variables to be saved. The variable names should be separated by commas. A maximum of 34 characters can be entered.

5.3.3 List Technology File Variables

With this choice, you can clear the screen and display the name and value of each variable in the UTF. This operation has no system prompts or actions. If the display fills the screen, the system displays:

CONTINUE?

Enter:

Y To clear the screen and display the rest of the variables.

N To return to the next higher menu.

5.3.4 List Run Time Library Variables

With this choice, you can clear the screen and display the name and value of each simple variable in the RTL; subscripted variables are not listed. This operation has no system prompts or actions. If the display fills the screen, the system displays:

CONTINUE?

Enter:

Y To clear the screen and display the rest of the variables.

N To return to the next higher menu.

5.4 User-Defined Symbols

With this choice, you can define a special set of characters or symbols. These characters or symbols can be used in dimensions, notes, and labels created by operations in 16 DRAFTING FUNCTIONS, if 16.1.1.2 CHARACTER SET TYPE is set to 2.USER-GENERATED.

ENTER SYMBOL-SET NAME

Enter the name of the symbol set to be created or modified (maximum of 6 characters).

If a symbol set with this name does not exist, a symbol set is created. If a symbol set with this name does exist, it is retrieved from the UTF and made available so that you can modify it. The system displays:

RETRIEVED

Enter] to continue to the next prompt.

You can define a new symbol by creating lines that connect points within a grid. The system requests the density of the grid to be used.

GRID DENSITY

- 1. 9 x 9
- 2. 17 x 17
- 3. 33 x 33
- 4. 65 x 65

Select the density of the grid. Enter 1, 2, 3, or 4 to use a 9 by 9, 17 by 17, 33 by 33, or 65 by 65 grid, respectively.

The system displays the chosen grid. Figure 1-4 shows samples of each grid.

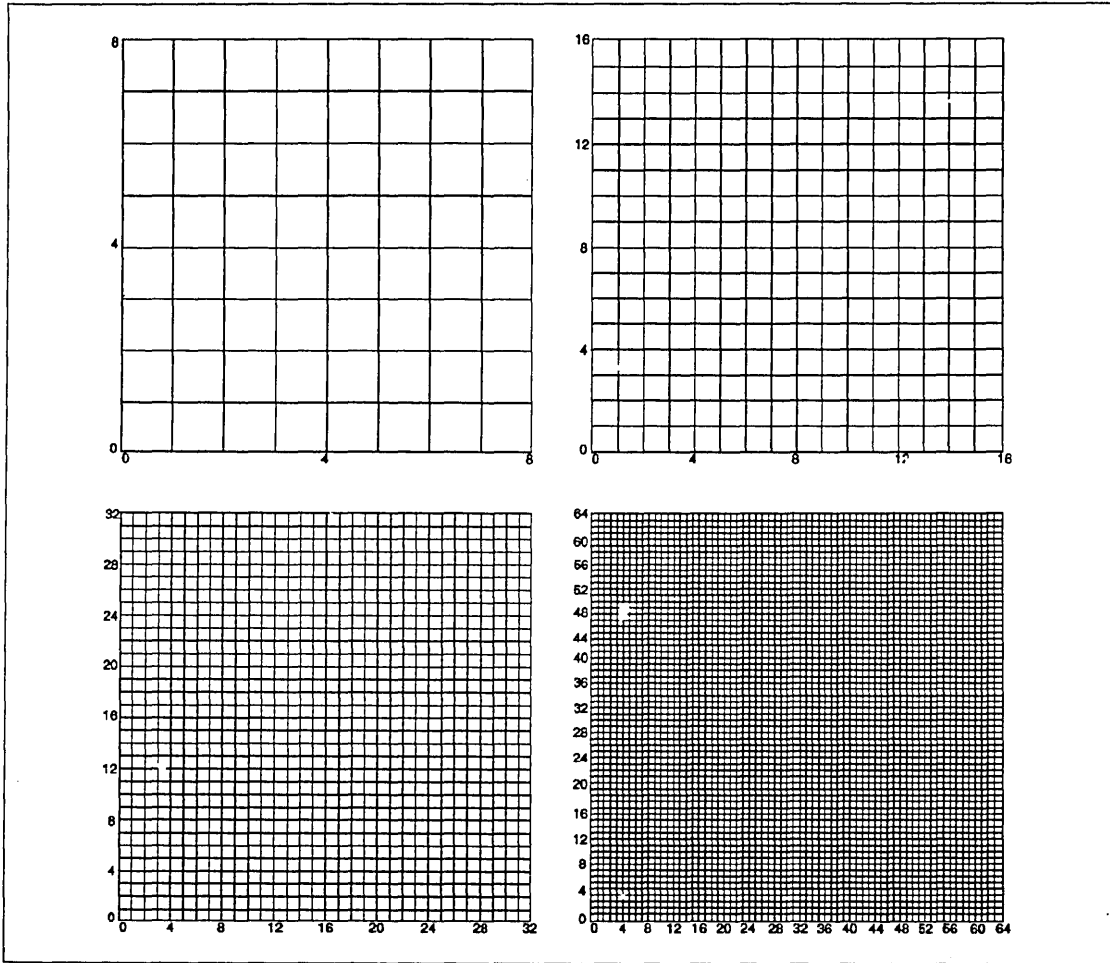

Figure 1-4. Grids for User-Defined Symbols

The system requests the type of operation to be performed.

SELECT MODE

- 1. DEFINE/REPLACE
- 2. DELETE
- 3. DISPLAY
- 4. LIST

Enter:

-] To file the symbol set and exit from this operation. Continue to Terminate.
- [To return to the GRID DENSITY prompt.
- 1 To define a new symbol or to replace an existing symbol. Continue to Define or Replace Symbol.
- 2 To delete an existing symbol. Continue to Delete Symbol.
- 3 To display a symbol. Continue to Display Symbol.
- 4 To list the characters in the symbol set. Continue to List Symbols.

Terminate

If you enter], you can file the symbol set and exit from this operation. The system displays:

DONE?

Enter:

- Y To file the symbol set.
- N To redisplay the SELECT MODE prompt.

If you enter Y, the system displays:

FILE?

Enter:

- Y To file the symbol set in the UTF and exit from this operation. If an old copy of a symbol set with this name exists in the UTF, the old copy is overwritten.
- N To exit from this operation without filing the symbol set.

If the UTF is full, the system displays:

CANNOT FILE

Define or Replace Symbol

With this choice, you can create a new symbol or character, or replace an existing symbol in the symbol set being modified. You draw the symbol in a displayed grid. You can begin with one or two existing symbols and add lines to these.

The system requests that you indicate which key on the terminal keyboard is to be associated with the symbol to be defined, replaced, deleted, or displayed. Keys that you have not defined retain their standard meaning.

GIVE KEY CORRESPONDENCE

Enter a single uppercase or lowercase key.
This key is used as the name for the symbol.

Enter [or] to return to the SELECT MODE prompt (refer to 5.4 USER-DEFINED SYMBOLS).

EXISTING BASE?

Enter:

Y To create a symbol by modifying a copy of an existing user-defined symbol (without altering the existing symbol).

N To create a new symbol.

If you enter Y, the system displays:

ENTER EXISTING BASE

Enter the key that is associated with the existing symbol being used as a basis for the new symbol.

After you enter one or two existing bases or enter N to the EXISTING BASE? prompt, the system displays:

START PT

Either use the graphics cursor to indicate the square on the grid where building the symbol is to begin or enter one of the following.

Enter:

[To return to the EXISTING BASE? prompt.

] To return to the SELECT MODE prompt (refer to 5.4 USER-DEFINED SYMBOLS).

The system requests that you build the symbol.

DRAW

Use the graphics cursor to indicate the next square to be connected with the preceding one.

You can either continue using the graphics cursor to indicate additional lines in the symbol or enter the following.

Enter:

- [To erase the previous line. Any number of lines can be erased consecutively. Use the graphics cursor to indicate the point on the grid where the process of building the symbol is to be continued.

MOVE

Use the graphics cursor to indicate where the next point starts or enter one of the following.

Enter:

[To return to the DRAW prompt.

] To continue to the next prompt.

SYMBOL COMPLETE?

Enter:

Y To store the symbol in the UTF.

N To continue to the next prompt.

CONTINUE?

Enter:

Y To continue drawing by returning to the DRAW prompt.

N To return to the SELECT MODE prompt and erase the symbol.

-] To indicate the completion of this symbol, or to continue drawing from another starting point.

If there is no more room in the work area for definition of symbols, the system displays:

TABLES ARE FULL

Enter Y or N to exit from the operation.

Delete Symbol

With this choice, you can delete a symbol from the character set currently being modified.

GIVE KEY CORRESPONDENCE

Enter the key associated with the symbol to be deleted.

The system displays:

DELETED

Display Symbol

With this choice, you can display an existing symbol in the character set currently being modified.

GIVE KEY CORRESPONDENCE

Enter the key associated with the symbol to be displayed.

The system clears the screen, redisplay the grid, and displays the symbol on the grid. If no symbol in the current character set is associated with the key, the system displays:

NOT FOUND

Enter] to continue.

List Symbols

With this choice, you can list the keys that correspond to the special symbols defined in the symbol set. This operation has no prompts or actions.

5.5 Level Management

With this choice, you can use the level facilities to:

- Change the current level and/or pen numbers.
- Give a level a name and description.
- List the name and description of a level.
- Delete the name and description associated with a level.
- Assign a new or existing level table to a part.
- Create and modify a pen table.
- Modify the pen number of all entities in a part according to your pen table.

A level table is a reference list stored in the UTF that describes the level structure of a part. Each level in the table has a name of up to 12 characters and a description of up to 50 characters. This combination of a name and description assists you in identifying the purpose of any given level.

Level tables have names of up to 4 characters. Zero or more tables may exist in the UTF at one time. This allows you to use level tables across parts in TAPE3 if the assignment of levels is consistent across parts.

A pen table is used to assign pen numbers to all entities in a part according to the level on which they reside or the entity type. Pen tables have names of up to 4 characters and are stored in the UTF.

The menu for this section is:

```

LEVEL MANAGEMENT
1.CHANGE CURRENT LEVEL/PEN NUMBERS
2.DEFINE LEVELS
3.LIST LEVELS
4.DELETE LEVELS
5.CREATE/ASSIGN LEVEL TABLE
6.CREATE/MODIFY PEN TABLE
7.EXECUTE PEN TABLE

```

5.5.1 Change Current Level/Pen Numbers

With this choice, you can change the current level and pen numbers. These values are assigned to any new entities you create after the change. The default level and pen numbers for a new part are 0. The current level and pen numbers are shown in the main ICEM DDN menu header.

```

1.LEVEL = n
2.PEN   = n

```

Enter the new level and pen numbers.
Levels range from 0 to 1023. Pen numbers range from 0 to 15.

5.5.3 List Levels

With this choice, you can list descriptions of levels in the current level table.

If the current part does not have a level table, the system displays:

NO LEVEL TABLE IS ASSIGNED TO THIS PART

You return to the Level Management menu. Select 5.CREATE/ASSIGN LEVEL TABLE to assign a level table to the part.

If the current part has a level table, the system prompts you for the way to structure the list:

LIST MODE
1.BY LEVEL NUMBER
2.BY LEVEL NAME

Enter:

- 1 To list the descriptions of a range of level numbers.

FROM LEVEL = 0
TO LEVEL = 1023

Enter the desired level range.

- 2 To list the description of the level by name.

ENTER LEVEL NAME

Enter up to 12 characters for the level name.

5.5.4 Delete Levels

With this choice, you can delete level descriptions from the current level table. Only the descriptions assigned to the levels are deleted; the entities defined at each level are not deleted.

If the current part does not have a level table, the system displays:

NO LEVEL TABLE IS ASSIGNED TO THIS PART

You return to the Level Management menu. Select 5.CREATE/ASSIGN LEVEL TABLE to assign a level table to the part.

The system prompts for the level to delete:

LEVEL NUMBER =

Enter the level number of the description you want to delete.

You receive the following message:

LEVEL DELETED

5.5.5 Create/Assign Level Table

With this choice, you can assign a new or existing level table to a part. The level table may already exist in the UTF or you can create a new one.

If a level table is already assigned to the part, before releasing it you can delete it from the UTF. The system displays:

```
LEVEL TABLE 'xxxx' IS ALREADY ASSIGNED,  
DELETE IT?
```

Enter:

Y To delete the current level table from the UTF.

N To leave the current level table in the UTF to recall later by name.

To create/assign a level table, the system prompts you for a name:

```
ENTER LEVEL TABLE NAME
```

Enter the 4-character name of the level table you want to assign to this part.

If a level table by this name does not exist in the UTF, a new one is created. The system displays:

```
LEVEL TABLE 'xxxx' CREATED AND ASSIGNED
```

The system then goes directly to 5.5.2 DEFINE LEVELS.

If a level table already exists by the name you entered, the system displays:

```
LEVEL TABLE 'xxxx' ASSIGNED
```

The system then returns to 5.5 LEVEL MANAGEMENT.

5.5.6 Create/Modify Pen Table

With this choice, you can create and/or modify a pen number table. Use pen tables to assign pen numbers to entities in your part according to the level on which they reside or based on the entity types. The system displays:

ENTER PEN TABLE NAME Enter the 4-character name of the pen table you want to modify. The system retrieves an existing pen table by this name from the UTF or creates a new table if the name does not match an existing pen table.

DEFINITION MODE
1. BY LEVEL
2. BY ENTITY TYPE

Enter:

- 1 To assign pen numbers to entities according to the level on which they reside. The system prompts you for a default pen number for entities not assigned by the pen table.

DEFAULT PEN = 1 Enter the default pen number for entities not assigned by the pen table.

1. FROM LEVEL = Enter the level range to assign to the pen number you enter. Enter [to remove your last entry from the pen table.
2. TO LEVEL =
3. PEN NUMBER =

- 2 To assign pen numbers to entities according to their type. The system prompts you for a default pen number for entities not assigned by the pen table.

DEFAULT PEN = 1 Enter the default pen number for entities not assigned by the pen table.

1. FROM TYPE = Enter the range of entity type numbers to assign to the pen number you enter. Entity type numbers are listed in table 1-1 at the beginning of this manual.
2. TO TYPE = Enter [to remove your last entry from the pen table.
3. PEN NUMBER =

5.5.7 Execute Pen Table

With this choice, you can change the pen numbers of all entities in your part according to the pen table name you enter. This choice overrides pen numbers assigned when the entity was originally created.

ENTER PEN TABLE NAME TO EXECUTE Enter the 4-character name of the pen table you want to execute. If the given pen table does not exist in the UTF, the system displays:

PEN TABLE DOES NOT EXIST

You return to the ENTER PEN TABLE NAME TO EXECUTE prompt.

5.6 Attribute Management

With this menu, you can assign attributes (such as names and values) to individual entities in the part. Each attribute has an attribute name. In addition, you can assign subattribute names and values to any entity that has an attribute name. Using operations in this submenu, you can search the entities in the part for the following:

- The quantity of entities with a specified attribute name.
- The entities with a specified attribute name.
- The entity with a specified attribute name and the minimum or maximum value for that attribute.
- The number of entities with a specified attribute which satisfy a specified condition.
- The sum of the values of a specified attribute.
- The attributes and subattributes of an entity.

The menu for this section is:

```
ATTRIBUTE MANAGEMENT
1.CREATE
2.MODIFY
3.COPY
4.DELETE
5.DISPLAY
6.IDENTIFY
7.SEARCH
8.LIST ON FILE
9.REPORT GENERATION
```

The following sections describe the choices in this menu.

5.6.2 Modify

These prompts continue until you enter]. The first [key rejects the last entered subattribute name and/or value. A subsequent [key rejects all entered names and/or values and returns to ENTER ATTRIBUTE NAME.

There is a limited number of attributes and subattributes that can be associated with any single entity. This limit depends upon the amount of information stored with the entity, as well as the number and length of attribute and subattribute names. In the event that the limit is reached, the system displays an error message:

```
CREATE NOT COMPLETE ON MARKED ENTITIES,  
NO MORE SPACE FOR ATTRIBUTES
```

If this message appears, you must either delete unneeded attributes and subattributes to make additional space, or you can accept the current attributes and subattributes with no further additions.

5.6.2 Modify

This feature allows you to modify attributes on an entity-by-entity basis (to change several attributes of one entity), or to change one attribute or subattribute shared by several entities. Your initial choice is to pick entities or to specify an attribute name:

```
SELECTION MODE  
1.SCREEN SELECT ENTITY  
2.SEARCH FOR NAMED ATTRIBUTE
```

5.6.2.1 Screen Select Entity

With this choice, you can modify the attributes or subattributes of a single entity.

INDICATE ENTITY

Indicate the entity you want to modify. Enter E or CTRL-E to receive the Entity Selection menu and use another method of selection. For more information, refer to the ICEM Design/Drafting Introduction and System Controls manual.

The system displays an attention indicator and all the existing attributes/subattributes associated with the selected entity line by line. Each line is prefixed by an attribute/subattribute number.

SELECTION OK?

Enter:

Y To accept the selection.

N To release the entity selected and make another selection.

If there are no attributes, the system displays:

THIS ENTITY HAS NO ATTRIBUTES

If no attributes were found, you answer Y to the SELECTION OK? prompt and create new attributes for the selected entity using the procedure described in 5.6.1 CREATE.

After successful selection, the attributes and subattributes can be modified. The system displays:

INDICATE MODIFICATION LINE BY:
NO. ATTR/NO. SUB-ATTR.

Enter the type of modification and the attribute or subattribute number.

You can use the following format to indicate the type of modification and attribute or subattribute number:

prefix att/sub

prefix The type of modification to be done.

+ Insert.

- Delete.

none Replace.

att The number of the relevant attribute.

sub The number of the relevant subattribute.

If only

prefix att

is entered, the operation deals with the attribute itself.

If you enter], the system returns to 5.6 ATTRIBUTE MANAGEMENT.

The following are examples of modification commands:

Command	Description
+3/2	Insert new subattribute(s) after the second subattribute of the third attribute.
+1	Insert a new attribute (with subattributes, if desired) after the first attribute and its associated subattributes.
-1/3	Delete the third subattribute of the first attribute.
-2	Delete the second attribute with all its associated subattributes.
2/1	Replace the first subattribute of the second attribute.
3	Replace the third attribute name.

The following illustrates the special use of the zero attribute and zero subattribute:

Command	Description
+0	Insert a new attribute (with subattributes, if desired) before the first attribute.
+2/0	Insert new subattribute(s) so that the second attribute is before the existing subattributes.

The following prompts and actions occur after you indicate the type of modification and the line to be modified.

Inserting New Attributes

To insert new attributes, the system prompts:

ENTER ATTRIBUTE NAME	Enter up to 32 characters for the new attribute name.
SUBATTRIBUTE TYPE	Enter:
1. NAME	1 To select names only.
2. VALUE	2 To select values only.
3. BOTH	3 To select names and values for subattributes.
] To create an attribute with no subattributes.

Following this choice, you enter new subattributes as described in 5.6.1 CREATE.

It is possible to modify subattribute values based on conditional information; that is, to search for all subattribute values less than 5, and so on. To conduct such a search, select a conditional search option from the displayed list. Options include finding entities with values less than, less than or equal to, equal to, not equal to, greater than or equal to, and greater than the entered value.

Entering] at any prompt terminates input for this series of prompts. If you terminate input immediately after entering the attribute name, the system searches for attributes that have no subattributes. If you terminate input at the SUBATTRIBUTE SEARCH CONDITION prompt, the system searches for type 1 subattributes only (those with names). Entering] at the ENTER ATTRIBUTE NAME prompt terminates the modification operation because no attribute was identified.

The system puts attention indicators on all the entities with the particular attribute/subattribute combination specified. The following message appears if there are offscreen entities that meet the search criteria:

```
nnn OFFSCREEN ENTITIES MATCH  
THEY WILL NOT BE MODIFIED
```

If you want to include the offscreen entities for modification, press [and then rescale the display.

A similar message is displayed if blanked entities have the specified combination of attribute and subattribute values:

```
nnn BLANKED ENTITIES MATCH  
THEY WILL NOT BE MODIFIED
```

If you want the entities included for modification, press [and then unblank the entities.

Next you are asked if you want to modify all the identified entities without reviewing them (global modification) or have them brought up one by one for modification.

```
MODIFICATION MODE  
1.MODIFY GLOBALLY  
2.MODIFY INDIVIDUALLY
```

If you select 1.MODIFY GLOBALLY, the next set of prompts appears once. If you select 2.MODIFY INDIVIDUALLY, the prompts appear once for each entity.

5.6.2.2 Search for Named Attribute

For individual modifications, the attention indicators are erased and then redrawn one by one to show which entity is being modified. For global modifications, the attention indicators remain on the screen.

Entering] at this prompt ends attribute modification with no changes made. Entering [returns you to the SEARCH VALUE prompt.

Now make modifications to the attributes using the following menu. Menu choice 5.DO NOT MODIFY appears only if you chose 2.MODIFY INDIVIDUALLY from the Modification Mode menu.

```
MODIFY FUNCTION
1.REPLACE
2.INSERT BEFORE
3.INSERT AFTER
4.DELETE
5.DO NOT MODIFY
```

Enter:

1 To replace the attribute, the subattribute, or both.

```
OLD ATTRIBUTE NAME IS
attname
ENTER NEW ATTRIBUTE NAME
```

Enter the new name for the attribute.
Enter a return to preserve the old name.

```
OLD SUBATTRIBUTE NAME IS
subattname
ENTER NEW SUBATTRIBUTE NAME
```

Enter the new name for the subattribute. Enter a return to preserve the old name.

```
SUBATTRIBUTE VALUE = oldval
```

Enter a new value for the subattribute.
Enter a return to preserve the old value.

Enter] at any prompt to keep the remaining attributes/subattributes unchanged. Enter [to back up one prompt. The subattribute prompts appear only if you entered subattribute information for searching purposes. In this case, the prompts appear one after the other.

- 2 To insert a new attribute or subattribute before the displayed attribute or subattribute.

If you are searching for an attribute with subattributes, the following prompt appears:

INSERT BEFORE
1.ATTRIBUTE
2.SUBATTRIBUTE

Enter:

- 1 To insert a new attribute (with a subattribute, if you want one) before the attribute containing the subattribute for which you are searching.
- 2 To insert a new subattribute before the subattribute for which you are searching.

If you are searching for an attribute, the following prompt appears:

INSERT NEW ATTRIBUTE BEFORE
attname
ENTER NEW ATTRIBUTE NAME

Enter up to 32 characters for the new attribute name.

SUBATTRIBUTE TYPE
1.NAME
2.VALUE
3.BOTH

Enter:

- 1 To specify named subattributes only.
- 2 To specify subattribute values only.
- 3 To specify names and values.
-] To specify no subattributes.

Now enter a new subattribute as described in 5.6.1 CREATE.

If you are searching for a subattribute, the following prompt appears:

INSERT NEW SUBATTRIBUTE BEFORE
subattname
ENTER NEW SUBATTRIBUTE NAME

Enter up to 32 characters for the name of the subattribute to be inserted (appears only for named or name and value subattribute types).

SUBATTRIBUTE VALUE = 0.00

Enter the value of the new subattribute (appears only for value or name and value subattribute types).

- 3 To insert a new attribute or subattribute after the displayed attribute or subattribute.

If you are searching for an attribute with subattributes, the following prompt appears:

INSERT AFTER
1.ATTRIBUTE
2.SUBATTRIBUTE

Enter:

- 1 To insert a new attribute (with a subattribute, if you want one) after the attribute containing the subattribute for which you are searching.
- 2 To insert a new subattribute after the subattribute for which you are searching.

If you are searching for an attribute, the following prompt appears:

INSERT NEW ATTRIBUTE AFTER
attname
ENTER NEW ATTRIBUTE NAME

Enter up to 32 characters for the new attribute name.

SUBATTRIBUTE TYPE
1.NAME
2.VALUE
3.BOTH

Enter:

- 1 To specify named subattributes only.
- 2 To specify subattribute values only.
- 3 To specify names and values.
-] To specify no subattributes.

If you are searching for a subattribute, the following prompt appears:

INSERT NEW SUBATTRIBUTE AFTER
subattname
ENTER NEW SUBATTRIBUTE NAME

Enter up to 32 characters for the name of the subattribute to be inserted (appears only for named or name and value subattribute types).

SUBATTRIBUTE VALUE = 0.00

Enter the value of the new subattribute (appears only for value or name and value subattribute types).

- 4 To delete the displayed attribute with all its subattributes, or the displayed subattribute.

If you are searching for an attribute with subattributes, the following prompt appears:

```
DELETE
1.ATTRIBUTE
2.SUBATTRIBUTE
```

Enter:

- 1 To delete the attribute containing the subattribute for which you are searching. All that attribute's subattributes are also deleted.
- 2 To delete the subattribute for which you are searching.

If you are searching for an attribute, the following prompt appears:

```
DELETE ATTRIBUTE
attname
WITH ALL SUBATTRIBUTES?
```

Enter Y or N to continue.

If you are searching for a subattribute, the following prompt appears:

```
DELETE SUBATTRIBUTE
subattname?
```

Enter Y or N to continue.

- 5 To skip modification of this entity. (This menu choice appears only if you chose 2.MODIFY INDIVIDUALLY from the Modification Mode menu.)

5.6.4 Delete

With this choice, you can delete all the attributes assigned to specific entities without deleting the entities from the data base. The system displays:

INDICATE ENTITY

Use the graphics cursor to select an unlimited number of entities from which to delete attributes and subattributes.

If you want to use another method of selection, enter E or CTRL-E to receive the following menu:

ENTITY SELECTION

1.SCREEN SELECT

2.CHAIN

3.REGION IN

:

Use the Entity Selection menu to select additional entities. For more information, see the ICEM Design/Drafting Introduction and System Controls manual.

5.6.5 Display

With this choice, you can display the attributes and subattributes of a selected entity.

INDICATE ENTITY

Select the entity whose attributes are to be displayed.

The system displays all attribute names and subattribute names or values. If no attributes are found, the system displays:

NO ATTRIBUTES

5.6.6 Identify

With this choice, you can display the first 20 characters of the first attribute name of selected entities, provided that the entities have attributes associated with them. The display appears close to the entity on the screen.

INDICATE ENTITY

Use the graphics cursor to select the entities for which you want to display the associated attributes and subattributes.

If you want to use another method of selection, enter E or CTRL-E to receive the following menu:

ENTITY SELECTION

1.SCREEN SELECT

2.CHAIN

3.REGION IN

:

Use the Entity Selection menu to select additional entities. For more information, see the ICEM Design/Drafting Introduction and System Controls manual.

5.6.7 Search

With this choice, you can search the current part for those entities having specified attributes or subattributes which satisfy given conditions.

Indicate the search function to be performed.

SEARCH FUNCTION

1. NUMBER OF OCCURRENCES
2. SUBATTRIBUTE MINIMUM
3. SUBATTRIBUTE MAXIMUM
4. SUBATTRIBUTE TOTAL
5. CONDITIONAL SEARCH
6. DISPLAY VALUES

Enter:

- 1 To find the number of entities in the part having the specified attribute or subattribute.
- 2 To find the entity that has the smallest value associated with the specified subattribute for all entities in the part having that subattribute.
- 3 To find the entity that has the greatest value associated with the specified subattribute for all entities in the part having that subattribute.
- 4 To find the sum of the values associated with a subattribute for all entities in the current part.
- 5 To find the number of entities that have a given subattribute with a value which satisfies a condition specified by you.
- 6 To display values for which a given attribute or subattribute is found. Entities for which the information is found are marked and the information displayed, one at a time.

ENTER SEARCH NAME

Enter the attribute or subattribute name for which the system is to search.

The search can be performed on either attributes or subattributes. To determine which type, the system displays:

SEARCH TYPE

1. ATTRIBUTE
2. SUBATTRIBUTE
3. BOTH

Enter:

- 1 To search attributes only for the given name.
- 2 To search subattributes only for the given name.
- 3 To search both attributes and subattributes for the given name.

NOTE

If you have specified subattributes with values but no names, the associated attribute name produces a search through its subattribute values.

If you enter 1.NUMBER OF OCCURRENCES, the system reports the number of occurrences of the attribute or subattribute you entered at the ENTER SEARCH NAME prompt:

```
attribute or subattribute
number FOUND
```

Enter] to continue.

If you enter 2.SUBATTRIBUTE MINIMUM, the system reports the minimum value for the attribute or subattribute you entered at the ENTER SEARCH NAME prompt:

```
attribute or subattribute
MINIMUM = value
```

Enter] to continue.

If you enter 3.SUBATTRIBUTE MAXIMUM, the system reports the maximum value for the attribute or subattribute you entered at the ENTER SEARCH NAME prompt above:

```
attribute or subattribute
MAXIMUM = value
```

Enter] to continue.

If you enter 4.SUBATTRIBUTE TOTAL, the system reports the total value for the subattributes you entered at the ENTER SEARCH NAME prompt above:

```
subattribute
TOTAL = value
```

Enter] to continue.

If you enter 5.CONDITIONAL SEARCH, you must specify the relationship that a subattribute value must have for the entity to be retrieved.

```
CONDITIONAL RELATIONS
1.LESS THAN
2.LESS THAN OR EQUAL TO
3.EQUAL TO
4.NOT EQUAL TO
5.GREATER THAN OR EQUAL TO
6.GREATER THAN
```

Select one of the displayed relations.

```
VALUE =
```

Enter the value to which the attribute values are compared.

The system retrieves the entity only if the value of the attribute assigned to the entity is correctly related to the value entered in response to 1.VALUE.

If no value is found which satisfies the conditional relation, the system displays:

NONE FOUND

If values that satisfy the relation are found, the system reports the number of values satisfying the relation:

attribute or subattribute
number FOUND

Enter] to continue.

5.6.8 List on File

With this choice, you can write the attributes and subattributes of all entities in the part to local file LIST. After finishing the session with ICEM DDN, you can make this local file permanent. The system does not rewind LIST after writing the attribute data on it.

The format of the attribute data written to file LIST is shown in table 1-3.

Table 1-3. Attribute Data Format

Line	Character/ Position	Data
1	1-70	Part name.
1	77-80	Sheet number.
2	1-6	Sequence number of entity.
2	7-9	Number of attributes.
3	10-12	Attribute number.
3	13-15	Number of subattributes.
3	16-47	Attribute name (up to 32 characters).
4,5,6...	16-47	Subattribute name (up to 32 characters).
4,5,6...	56-...	Subattribute value (real number with the number of decimal places determined by 1.4 SYSTEM DECIMAL PLACES. Refer to the ICEM Design/Drafting Introduction and System Controls manual).

The system writes data for the entity with the largest sequence number first and in descending sequence number order after that. Subsequent entity data begins on line 2.

If the system finds no attributes in the part, it displays:

NO ATTRIBUTES

5.6.9 Report Generation

With this choice, you can generate a report from the ICEM DDN data base of entities and their associated attribute data.

You must provide four basic elements for the report:

- The way in which entities should be extracted for inclusion in the report.
- The rules for ordering the extracted entities.
- The report format.
- The report origin.

Following these responses, a report is constructed using lines and notes to build the template, and notes to fill in the report. You can designate upper left origin, character size, and display level.

Retrieving the Entities

To create a report, the entities whose values you want to see in the report must be selected. This selection is made by specifying the particular attributes and subattributes an entity must have to be included. These attributes and subattributes are specified and you are allowed to place certain restrictions on the values associated with them. First, you must define the attributes and their value restrictions:

ENTER ATTRIBUTE NAME name

Where names run consecutively (1,2,3,...), enter the name of an attribute which an entity must have to be included in the report.

Enter] to end the attribute specification process and begin defining entities to be retrieved by their subattribute names and values.

Select the condition by which the attribute is to be used in the retrieval. Remember that an unnamed subattribute value is associated with its attribute name. By placing a condition on the retrieval of an attribute, you are really placing a condition on any unnamed subattribute values associated with this attribute name.

CONDITIONAL RELATIONS

- 1.UNCONDITIONAL
- 2.LESS THAN
- 3.LESS THAN OR EQUAL TO
- 4.EQUAL TO
- 5.NOT EQUAL TO
- 6.GREATER THAN OR EQUAL TO
- 7.GREATER THAN

Enter 1 to have no restriction on this specific attribute.] has the same effect.

Enter 2-7 to restrict the conditional value.

VALUE = number

Enter the conditional value for this specific subattribute value.

These prompts continue for entering additional attribute names until you enter] for the attribute name. At this point, you can begin specifying any subattribute names and conditions on their values.

ENTER SUBATTRIBUTE NAME name

Where names run consecutively (1,2,3,...), enter the subattribute name which an entity must have to be included in the report.

Enter] to end specifying subattribute names.

Select the condition by which the subattribute is to be used in the retrieval. This condition is related to the subattribute value for this subattribute name.

CONDITIONAL RELATIONS

1.UNCONDITIONAL

2.LESS THAN

3.LESS THAN OR EQUAL TO

4.EQUAL TO

5.NOT EQUAL TO

6.GREATER THAN OR EQUAL TO

7.GREATER THAN

Enter 1 to have no restriction on this specific subattribute.] has the same effect.

Enter 2-7 to restrict the conditional value.

VALUE = number

Enter the conditional value for this specific subattribute value.

The prompts for entering additional subattribute names continue until you enter] and ordering prompts begin.

NOTE

A maximum of 123 entities can be included in one report. In addition, there is a limit to the number of attribute and subattribute names which can be given for identifying the entities. These limits depend upon the length of the attribute and subattribute names. For example, you may give a maximum of 17 attribute names of 32 characters each and a maximum of 15 subattribute names of 32 characters each.

Describing the Report Ordering

After extraction has been completed, you must describe the way in which the information in the report is to be ordered. This ordering is also used for computing quantity and total values to appear in the report. You may describe as many or as few orderings as necessary.

When names run consecutively, first describe which piece of extracted information is to be ordered:

ORDERED ITEM name

1.SUBATTRIBUTE NAME

2.SUBATTRIBUTE VALUE

Enter:

1 To order the report alphabetically by the subattribute names of a given attribute.

2 To order the report numerically by the values of a given subattribute.

If you enter 1.SUBATTRIBUTE NAME, the system prompts:

ENTER ATTRIBUTE NAME Enter the name of the attribute which has
the appropriate subattribute name.

If you enter 2.SUBATTRIBUTE VALUE, you must describe the correct value and
choose the numeric ordering:

ENTER ATTRIBUTE NAME Enter the attribute name of the item.
ENTER SUBATTRIBUTE NAME Enter the subattribute name of the item.
Enter] if no specific subattribute name
applies.

NUMERIC ORDERING Enter:
1.ASCENDING 1 The chosen values are reported in
2.DECENDING ascending order.
2 The chosen values are reported in
descending order.

After you enter the appropriate attribute or subattribute name, the system allows you
to define additional items to be ordered. These rules are applied in the order in which
they are defined.

NOTE

There is a limit to the number of names you can use to specify ordering. This limit
depends on the length of the names. For example, you can specify up to 36 attribute
and subattribute names if each name is 32 characters in length.

Formatting the Report

You now indicate how the report is to be formatted.

ENTER TITLE LINE Enter a maximum of 72 characters for each
title line. Entering] ends title line
specification.

A carriage return indicates a blank title
line.

ENTER COLUMN HEADING name Enter the heading for this column.

After entering the column heading, you can define the contents that appears in the
column.

COLUMN CONTENTS
1.ATTRIBUTE NAME
2.SUBATTRIBUTE NAME
3.SUBATTRIBUTE VALUE
4.LITERAL STRING
5.QUANTITY
6.TOTAL

Enter:

- 1 To print an attribute name.

ENTER ATTRIBUTE NAME

Enter the desired attribute name.

If an entity has this attribute name, the attribute name is printed in the column. If an entity does not have this attribute name, the column is left blank.

- 2 To print a subattribute name.

ENTER ATTRIBUTE NAME

Enter the name of the attribute whose subattribute name is printed in the column.

- 3 To print a subattribute value.

ENTER ATTRIBUTE NAME
ENTER SUBATTRIBUTE NAME

Enter the attribute and subattribute name whose subattribute value is to be printed in the column.

Enter] to ENTER SUBATTRIBUTE NAME if no specific subattribute name applies.

DECIMAL PLACES = number

Enter the number of decimal places to be printed.

- 4 To print a literal string.

ENTER LITERAL STRING

Enter the character string to appear in the column.

- 5 To compute the quantity and display it in the column. The quantity is the number of entities that have identical ordering rules.

- 6 To print a computed total.

ENTER ATTRIBUTE NAME
ENTER SUBATTRIBUTE NAME

Enter the attribute and subattribute name whose subattribute values is totaled and printed in the column.

Enter] to ENTER SUBATTRIBUTE NAME if no specific subattribute name applies.

DECIMAL PLACES = number

Enter the number of decimal places to be printed.

After you enter all information on the column content, the system repeats the sequence for each additional column until each one has been defined.

NOTE

There is a limit on the number of title lines and column headings which can be assigned. This limit depends on the number of characters in each character string. For example, there is a maximum of 256 character strings of 10 characters each.

Finally, the system displays:

REPORT DATA	Enter the desired values for the character size and construction level to be used for the report.
1.CHARACTER SIZE = current character size	
2.LEVEL = current level	
INDICATE REPORT ORIGIN	Indicate the upper left corner of the report.
DEFINE AS GROUP?	Enter:
	Y To indicate that the entities created by attribute report generation are to be defined as a group entity.
	N To indicate that the entities created by attribute report generation are not to be defined as a group entity.

NOTE

There is a maximum of 240 entities in any group. If the report is made up of more than 240 entities, you are not given the opportunity to define the report as a single group entity.

The system displays the report.

5.7 Reserved for Future Use

5.8 User Text Entry

With this choice, you can enter and edit files in the UTF that contain lines of text.

ENTER SIX CHARACTER NAME

Enter the name of the text file.

You can make additions and changes to the file, display the file, or file it in the UTF. (Refer to table 1-4 for a list of the text editing commands.)

Table 1-4. Text Editing Commands

Command	Description
Dn1[,n2]	Deletes lines n1 through n2 from the text file. If n2 is omitted, only line n1 is deleted. If both n1 and n2 are omitted, the command is ignored.
F	Instructs the editor to: <ul style="list-style-type: none"> • File the updated copy of the current text file in the UTF. • Store the text file in the UTF.
In	Adds or inserts lines. Lines you enter after this command are inserted after line n. Press the RETURN key once to indicate the end of a line of inserted data. To terminate an insert operation, press the RETURN key twice in succession. To create a new program, insert lines after line 0.
Q	Terminate the edit session without updating the text file in the UTF. All work performed since entering the editor is lost, unless the additions and changes were filed previously using the F command.
Rn1[,n2]	Replaces lines n1 through n2 with the lines you enter after this command. If n2 is omitted, only line n1 is replaced. You can enter any number of lines to replace the lines deleted. Press the RETURN key once to indicate the end of a line. To terminate the replace operation, press the RETURN key twice in succession. A replace operation is equivalent to a delete operation, followed by an insert operation.
T[n1][,n2]	Displays lines n1 through n2 of the text file. If n2 is omitted, only line n1 is displayed. If n1 and n2 are omitted, all the lines of the file are displayed.

UTF text files can be a maximum of 63 characters in length.

5.9 Misc. Construction

With this choice, you can perform miscellaneous construction features. These operations:

- Define a point at a distance along a curve.
- Define an infinite line tangent to and at an angle to a circle.
- Define an identical arc at a distance and at an angle from the original arc.
- Verify workspace coordinates of a cursor position.

The menu for this section is:

```
MISC. CONSTRUCTION
1.GIRTH POINT - DIST ALONG A CURVE
2.LINE - AT ANGLE WITH A CURVE
3.ARC - POLAR FROM AN ARC
4.VERIFY SCREEN POSITION
```

The following sections describe the choices in this menu.

5.9.1 Girth Point – Dist Along a Curve

With this choice, you can define a point at a specified distance along a two-dimensional curve. For example, this can be a straight distance along a line or a circumferential distance along an arc.

INDICATE 2-D CURVE

Use the graphics cursor to select an existing curve.

CURVE DISTANCE =

Enter the distance along the curve.

5.9.2 Line – at Angle with a Curve

With this choice, you can define an infinite line tangent to a circle, arc, extension of an arc, or curve. The angle specified and the selected side of the arc determine the point of tangency.

INDICATE ARC OR CIRCLE

Use the graphics cursor to select an existing arc or circle. Select the arc on the side where the line is to be defined.

ANGLE = n.nnnn

Enter the angle (in degrees) of the line to be defined. The angle is defined by the line tangent to the circle and counterclockwise from the x-axis.

5.9.3 Arc – Polar from an Arc

With this choice, you can define an arc, identical to an existing arc, at a specified angle and distance from the original arc. The new arc has the same position relative to the xt- and yt-axes as the original arc.

INDICATE ARC OR CIRCLE

Use the graphics cursor to select an existing arc or circle.

1.ANGLE =
2.DISTANCE =

Enter the angle (in degrees) and distance for the new arc.

5.9.4 Verify Screen Position

With this choice, you can display the transform coordinates of a selected location.

INDICATE POSITION

Use the graphics cursor to indicate a position.

1.COORDINATE XT = n.nnnn
2. YT = n.nnnn
3. ZT = n.nnnn

The system displays the transform coordinates of the selected position.

Continued selections provide you with the following information:

1.COORDINATES XT = n.nnnn
2. YT = n.nnnn
3. ZT = n.nnnn
4.DELTA XT = n.nnnn
5. YT = n.nnnn
6. ZT = n.nnnn
7.ANGLE = n.nnnn
8.DISTANCE = n.nnnn

Enter 1-3 to display the transform coordinates of the selected position.

Enter 4-6 to display the delta between this position and the previous positions.

Enter 7-8 to display the angle (in degrees) from the positive xt-axis distance between the points.

5.10 Nesting

With this choice, you can nest templates (templates are described in 6.3 TEMPLATE MANAGEMENT) with or without a plate boundary. This operation is divided into four main divisions: kerf distance definition, boundary plate definition, original placement, and adjustment placement.

Kerf Distance Definition

When you select this operation, the system displays:

KERF DIST. =

Enter the kerf distance, which is the minimum distance between parts and plate boundaries.

The default value is 3.0 mm (0.125 in).

Boundary Plate Definition

After you enter the kerf distance, the system displays:

PLATE DESIRED? Enter:
 Y To continue defining the plate.
 N To continue to the Nesting Placement menu.

If you enter Y, the system displays:

CLOSE PLATE? Enter:
 Y To display all four edges of the plate rectangle.
 N To display only the bottom and left edge of the plate.

Closure has no effect on the nesting functions and is used as a visual aid only.

ENTER PLATE DIMENSIONS
 1.LENGTH = 1 Enter the distance dimension in the x direction.
 2.WIDTH = 2 Enter the distance dimension in the y direction.

The origin of the plate is set at 0.0, 0.0. The nesting plate is displayed after the dimensions are entered.

The system displays:

NESTING PLACEMENT Enter:
 1.ORIGINAL 1 To proceed to the Original Placement menu.
 2.ADJUSTMENT 2 To proceed to the Adjustment Placement menu.
] To use the create/modify mode.

If you enter], the system asks if you wish to create or modify a plate:

CREATE/MODIFY PLATE? Enter:
 Y To select the create/modify mode.
 N To continue to the next step.

5.10 Nesting

If you enter Y, the system displays:

```
CREATE/MODIFY PLATE
1.KEY IN LENGTH/WIDTH
2.DIAGONAL PARTS
3.4 EXTREME PARTS
```

Enter:

- 1 To define the plate by using length and width.

```
ENTER PLATE DIMENSIONS          Enter the length and width of the plate.
1.LENGTH =
2.WIDTH =
```

- 2 To define the plate by using diagonal parts.

```
INDICATE DIAGONAL PARTS        Indicate two diagonal parts.
INDICATE TEMPLATE
```

- 3 To define the plate by using four extreme parts.

```
INDICATE EXTREME PARTS        Indicate the four extreme parts.
INDICATE TEMPLATE
```

After you define the plate, the system displays:

```
CLOSE PLATE?                   Enter:
                                Y To display all four edges of the plate.
                                N To display only the bottom and left edge
                                of the plate.
```

After answering the Create/Modify Plate menu prompts, the system displays the nesting plate and asks the following question:

```
FINISHED?                     Enter:
                                Y To return to 5 SPECIAL FUNCTIONS.
                                N To return to the Nesting Placement
                                menu.
```

Original Placement

If you enter 1.ORIGINAL from the Nesting Placement menu, the system displays:

```
ORIGINAL PLACEMENT
1.ABSOLUTE
2.RELATIVE TO PLATE
3.RELATIVE TO A SINGLE CHECK CURVE
4.RELATIVE TO TWO CHECK CURVES
5.REGIONAL TRANSLATE-ROTATE
6.DELETE PART
```

Enter:

- 1 To transform a part independent of the plate boundary (refer to Absolute).
- 2 To place a part relative to a plate corner or edge (refer to Relative to Plate).
- 3 To place a part relative to a single template or line (refer to Relative to a Single Check Curve).
- 4 To place a part relative to two templates or lines (refer to Relative to Two Check Curves).
- 5 To translate or rotate a region (refer to Regional Translate-Rotate).
- 6 To delete a part (refer to Delete Part).

If you enter any selection other than 5.REGIONAL TRANSLATE-ROTATE, the system displays:

SELECT PRIMARY PART FIRST
INDICATE TEMPLATE

With the exception of translate, rotate, and scale, primary part selection uses the screen position as the basis for selection of part side and check curves. The screen position also determines what part of the curve is selected; that is, either the end or center of the curve.

Rotation angle calculations are determined from a delta angle generated from the position point to a normal point on the curve. Therefore, positioning should be performed outside the figure or curve for favorable results.

After you select the primary part, the system displays:

SELECTION OK ?
SELECT SECONDARY PARTS
INDICATE TEMPLATE

Enter] to continue.

Secondary part selection continues until it is terminated by entering].

Absolute

If you enter 1.ABSOLUTE, the system displays:

ABSOLUTE
1. TRANSLATE
2. ROTATE
3. MIRROR
4. SCALE

Enter:

- 1 To translate a part.
- 2 To rotate a part.
- 3 To mirror a part at the kerf distance.
- 4 To scale a part.

5.10 Nesting

If you enter 1.TRANSLATE from the Absolute menu, the system displays:

TRANSLATE FROM
1.SCREEN POSITION
2.VERTEX
3.LOWER CORNER
4.UPPER CORNER
5.CENTER

Enter:

- 1 To translate from a screen position.
- 2 To translate from a screen-selected vertex on the primary part.
- 3 To translate from the lower left or right corner of the primary part.
- 4 To translate from the upper left or right corner of the primary part. Refer to the prompts for entry 3.
- 5 To translate from the geometric center of the primary part.

If you enter 3.LOWER CORNER, the system displays:

LEFT CORNER?

Enter:

- Y To use the lower left or upper left corner.
- N To use the lower right or upper right corner.

After you select the translate from position, the system displays:

TRANSLATE TO
1.SCREEN POSITION
2.DELTA X/Y
3.DISTANCE ALONG A VECTOR

Enter:

- 1 To translate a part to a screen position.
- 2 To translate a part by delta x and delta y.
- 3 To translate a part along a check curve vector at a distance.

If you selected 2.DELTA X/Y, the system displays:

ENTER DELTA COORDS
1.DELTA X =
2. Y =

Enter the values of delta x and delta y.

If you selected 3.DISTANCE ALONG A VECTOR, the system displays:

SELECT CHECK CURVE FACE
INDICATE TEMPLATE

Select the check curve using the graphics cursor.

DISTANCE =

Enter the distance at which the part is to be translated along the selected check curve vector.

The system displays the translated/duplicated entity and returns to the Original Placement menu.

If you enter 2.ROTATE from the Absolute menu, the system displays:

ROTATION POINT	Enter:
1.SCREEN POSITION	1 To rotate from a screen position.
2.VERTEX	2 To rotate from a screen-selected vertex on the primary part.
3.LOWER CORNER	3 To rotate from the lower left or right corner of the primary part.
4.UPPER CORNER	4 To rotate from the upper left or right corner of the primary part. Refer to the prompts for entry 3.
5.CENTER	5 To rotate from the geometric center of the part.

If you enter 3.LOWER CORNER, the system displays:

LEFT CORNER?	Enter:
	Y To use the lower left or upper left corner.
	N To use the lower right or upper right corner.

After you select the rotation point, the system displays:

DIRECTION OF ROTATION	Enter:
1.CLW	1 To rotate a part clockwise.
2.CCLW	2 To rotate a part counterclockwise.
DEGREES =	Enter the number of degrees by which the part is rotated.

The system displays the rotated/duplicated entity and returns to the Original Placement menu.

If you enter 3.MIRROR from the Absolute menu, the system mirrors the part on the indicated (face) side of the primary part at the kerf distance separation.

The system displays the mirrored/duplicated entity and returns to the Original Placement menu.

5.10 Nesting

If you enter 4.SCALE from the Absolute menu, the system displays:

SCALE ABOUT
1. VERTEX
2. LOWER CORNER
3. UPPER CORNER
4. CENTER

Enter:

- 1 To scale from a screen-selected vertex on the primary part.
- 2 To scale from the lower left or right corner of the primary part.
- 3 To scale from the upper left or right corner of the primary part. Refer to the prompts for entry 3.
- 4 To scale from the geometric center of the primary part.

If you enter 2.LOWER CORNER, the system displays:

LEFT CORNER?

Enter:

- Y To use the lower left or upper left corner.
- N To use the lower right or upper right corner.

After you select the scaling position, the system displays:

SCALE =

Enter the scale factor.

The system displays the scaled/duplicated entity and returns to the Original Placement menu.

Relative to Plate

If you enter 2.RELATIVE TO PLATE, the system displays:

PLACEMENT ON PLATE EDGE
1. CORNER
2. POSITION

Enter:

- 1 To place a part to the plate corner.

INDICATE CORNER

Screen select a position. The plate edge closest to the screen position becomes the primary edge to which the part is nested.

The part is moved to the kerf distance away from the secondary plate edge and thus, nested to the corner.

2 To place a part to the plate edge closest to the position.

INDICATE POSITION

Screen select a position. The part is nested to the closest plate edge at the indicated position.

The system displays the nested/duplicated part and returns to the Original Placement menu.

Relative to a Single Check Curve

If you enter 3.RELATIVE TO A SINGLE CHECK CURVE, the system displays:

SELECT PART FACE

Indicate the part face which will be at the kerf distance from the check curve.

SELECT FIRST CHECK CURVE
INDICATE ENTITY

Indicate the plate edge or part side as the check curve.

The system nests to the side and portion of the check curve; for example, either the end or center, as indicated by the screen positions at the kerf distance separation. The system displays the nested/duplicated part and returns to the Original Placement menu.

Relative to Two Check Curves

If you enter 4.RELATIVE TO TWO CHECK CURVES, the system displays:

SELECT PART FACE

Indicate the part face which will be at the kerf distance from the check curve.

SELECT FIRST CHECK CURVE
INDICATE ENTITY

Indicate the plate edge or part side as the check curve.

SELECT SECOND CHECK CURVE
INDICATE ENTITY

Indicate the second check curve.

The system asks if the selection is satisfactory after each check curve is selected to allow you to change the selection, if necessary.

The system nests the part along the vector of the first check curve until it is the kerf distance from the second check curve. The system displays the nested/duplicated part and returns to the Original Placement menu.

Regional Translate-Rotate

If you enter 5.REGIONAL TRANSLATE-ROTATE, the system displays:

REGION TRANSLATE-ROTATE
SELECT REGION

INDICATE A CORNER OF THE REGION

Select a corner of the region.

INDICATE THE OPPOSITE CORNER

Select the opposite (diagonal) corner.

SELECTION OK?

Enter:

Y To proceed to the next prompt.

N To allow reselection of the region.

If you enter Y, the system displays:

TRANSLATE-ROTATE
1. TRANSLATE
2. ROTATE

Enter:

1 To translate the region.

INDICATE POSITION

Indicate the translate from position.

TRANSLATE TO
1. SCREEN POSITION
2. DELTA X/Y
3. DISTANCE ALONG A VECTOR

Enter:

1 To translate the region to a screen position.

2 To translate the region by delta x and delta y.

3 To translate the region along a check curve vector at a distance.

If you enter 2.DELTA X/Y, the system displays:

ENTER DELTA COORDS
1. DELTA X =
2. Y =

Enter the values of delta x and delta y.

If you enter 3.DISTANCE ALONG A VECTOR, the system displays:

SELECT CHECK CURVE FACE
INDICATE TEMPLATE

Select the check curve using the graphics cursor.

DISTANCE =

Enter the distance at which the region is to be translated along the selected check curve vector.

The system displays the translated/duplicated entity and returns to the Original Placement menu.

2 To rotate the region.

INDICATE POSITION

Select the rotation point.

DIRECTION OF ROTATION

Enter:

- 1.CLW
- 2.CCLW

1 To rotate clockwise.

2 To rotate counterclockwise.

DEGREES =

Enter the degrees of rotation.

The system displays the rotated/duplicated entity and returns to the Original Placement menu.

Delete Part

If you enter 6.DELETE PART, the system displays:

INDICATE TEMPLATE

Select the part to be deleted.

DELETE?

Enter:

Y To delete the indicated part and return to the Original Placement menu.

N To return to the Original Placement menu without deleting the indicated part.

Figure 1-5 shows the result obtained when nesting a template to a plate edge or a check curve. The result depends on the cursor position with respect to the part side and the plate edge or check curve. The angle of the perpendicular from the position to the line is used to determine the angle of part rotation. The direction of kerf is determined by the position of the cursor with respect to the plate or check curve.

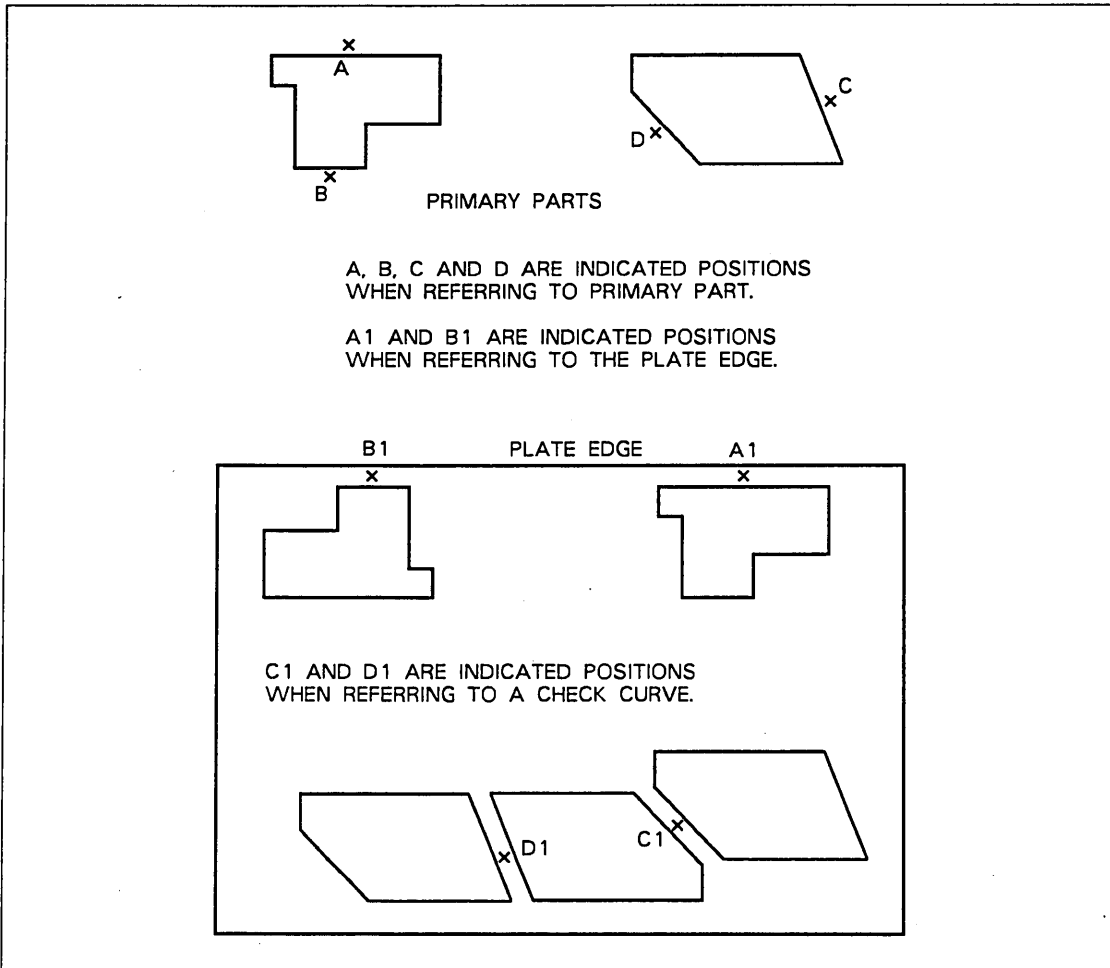

Figure 1-5. Nesting a Part at a Plate Edge or Check Curve

Adjustment Placement

If you enter 2.ADJUSTMENT from the Nesting Placement menu, the system displays:

ADJUSTMENT PLACEMENT

- 1.ABSOLUTE
- 2.RELATIVE TO PLATE
- 3.RELATIVE TO A SINGLE
CHECK CURVE
- 4.RELATIVE TO TWO CHECK CURVES
- 5.REGIONAL TRANSLATE-ROTATE
- 6.DELETE PART

Enter:

- 1 To transform a part independent of the plate boundary.
- 2 To place a part relative to a plate corner or edge.
- 3 To place a part relative to a single template or line.
- 4 To place a part relative to two templates or lines.
- 5 To translate or rotate a region.
- 6 To delete a part.

All main and subselections from the Adjustment Placement menu are the same as for the Original Placement menu, except for the following:

- The Adjustment Placement menu deals with adjusting parts that were placed previously using the Original Placement menu. It does not include duplication.
- After the adjusted part is displayed, the system returns to the Adjustment Placement menu.
- The translation and rotation functions are repeated until you enter] .

Entering] returns the system to the Nesting Placement menu.

5.11 Named Entities

With this choice, you can manage the names of entities. When an operation requires you to select an entity on the screen, you can use the entity's name to identify it (assigned using this menu or by running a GRAPL program) if 1.11.1 SEQ.NO./ POINTER/NAME SELECT (discussed in the ICEM Design/Drafting Introduction and System Controls manual) is turned on. Selecting by name is faster than selecting with graphics cursor because the system does not search the data base for the nearest entity.

The menu for this section is:

- 1.LIST NAMES
- 2.ATTACH NAME TO ENTITY
- 3.DETACH NAME FROM ENTITY
- 4.SEARCH FOR NAME

The following sections describe the choices in this menu.

5.11.1 List Names

With this choice, you can list all the names used as entity names by their pointer numbers:

LISTING OF NAMED ENTITIES

NAME	POINTER
entity names	pointer numbers

If this listing fills the screen, the system displays:

CONTINUE?

Enter:

Y To continue.

N To return to 5.11 NAMED ENTITIES.

After all the names are listed, the system displays:

RETURN TO TOP MENU?

Enter:

Y To return to 5 SPECIAL FUNCTIONS.

N To return to 5.11 NAMED ENTITIES.

If no entities are named, the system displays:

NO NAMED ENTITIES

5.11.2 Attach Name to Entity

With this choice, you can assign a name to an entity.

INDICATE ENTITY

Use the graphics cursor to select the entity to be named.

If you want to use another method of selection, enter E or CTRL-E to receive the following menu:

ENTITY SELECTION

1.SCREEN SELECT

2.CHAIN

3.REGION IN

:

Use the Entity Selection menu to select entities. For more information, see the ICEM Design/Drafting Introduction and System Controls manual.

ENTER NAME

Enter a name for the entity. The name can be from 1 to 10 characters.

The system attaches the name to the indicated entity. If the entity was previously named, the new name replaces the old name.

If the entered name is already attached to another entity, the system displays:

DUPLICATE NAME ---

Control is returned to 5.11 NAMED ENTITIES. Detach the name from the previous entity if it is to be used on a different one.

5.11.3 Detach Name from Entity

With this choice, you can delete the name from an entity.

INDICATE ENTITY

Use the graphics cursor to select the entity to have its name detached.

If you want to use another method of selection, enter E or CTRL-E to receive the following menu:

ENTITY SELECTION

1.SCREEN SELECT

2.CHAIN

3.REGION IN

:

Use the Entity Selection menu to select entities. For more information, see the ICEM Design/Drafting Introduction and System Controls manual.

The system detaches the name from the selected entity and deletes it from the listing of named entities. The entity is not changed.

5.11.4 Search for Name

With this choice, you can search for a name of an entity in the listing of entities.

ENTER NAME

Enter the name for which the system is to search.

If the system finds the specified name, it displays the entity's sequence number and pointer number. It also indicates the entity with an attention indicator if the entity is currently displayed.

If the name does not exist, the system displays:

NAME NOT FOUND

5.12 Pipework Interference

With this choice, you can determine whether a pair of pipes interfere in space near two selected points on the center line of the pipes, without calculating the intersection. It is not necessary to define a pipe's outer surface explicitly before using this operation, because a pipe can be specified by a central curve and an outer radius.

The graphics cursor is used to select two points on the curves that you think are closest points between the center lines of the pipes. The algorithm converges to the actual closest points. This operation gives only local closeness between the pipes; if you select different points farther down the center lines as candidates for closest points, different closest points can be obtained.

PIPEWORK INTERFERENCE CHECK
INDICATE ENTITY

Use the graphics cursor to select either a curve-driven surface using the ARC OF SPECIFIED RADIUS option (refer to 15.3.16 CURVE DRIVEN SURFACE in the ICEM Advanced Design manual), or any two-dimensional curve, including a composite curve.

If a curve-driven surface is selected, the system obtains its radius from the entity and returns to the INDICATE ENTITY prompt for specification of the other pipe. If a curve is selected, the system displays:

PIPE RADIUS = nn.nnnn

Enter the outer pipe radius.

After you enter the pipe radius, the system returns to the INDICATE ENTITY prompt for specification of the other pipe. After both pipes have been specified, the system displays one of the following:

PIPES INTERFERE
MAX INTERFERENCE = nn.nnnn

PIPES CLEAR
MIN. CLEAR. = nn.nnnn

CHECK TERMINATED -
INTERFERENCE OR CLEARANCE
IS AT END OF PIPE(S)

The closest points on each center line are marked with x's. If you need more information on the nature of the interference between a specific pair of pipes, define both of them as curve-driven surfaces using the ARC OF SPECIFIED RADIUS option (refer to 15.2.16 CURVE DRIVEN SURFACE), followed by SURFACE INTERSECTION CURVE (refer to 15.1.3 INTERSECTION CURVE in the ICEM Advanced Design manual) to determine where and how the pipes interfere.

5.13 GPL

With this choice, you can execute precompiled Graphics Programming Language (GPL) programs. These programs are custom applications ranging from family of parts generators to interactive tutorials. These programs must be contained in a local GPL library.

The menu for this section is:

```

GPL
1.RECOVER LAST FILE
2.CONTINUE GPL PROGRAM
3.RUN GPL PROGRAM
4.LIST GPL NAMES
5.CHANGE LIBRARY NAME

```

The following sections describe these menu choices.

5.13.1 Recover Last File

With this choice, you can continue program execution following a FILE command in a GPL program. Execution continues at the next statement following the last FILE command.

5.13.2 Continue GPL Program

With this choice, you can continue program execution following a PAUSE statement in the GPL program. If there is no PAUSE statement in the current GPL program, you return to 5 SPECIAL FUNCTIONS.

5.13.3 Run GPL Program

With this choice, you execute the GPL program.

ENTER SIX CHARACTER NAME

Enter the name of the GPL program you want to run. This name can consist of 1 to 6 characters.

5.13.4 List GPL Names

With this choice, you can display the names of GPL programs and subprograms contained in a local GPL library.

5.13.5 Change Library Name

With this choice, you can change the name of the local GPL library you want to access. The default name of this library is GPLLIB.

CURRENT GPL LIBRARY IS name
ENTER NEW GPL LIBRARY NAME

Enter the name of the local GPL library
you want to access. The name of the library
can consist of 1 to 7 characters.

For more information about GPL, refer to the ICEM GPL manual.

Menu 6: Data Base Management

2

Using Menu 6	2-1
6.1 Part Management	2-2
6.1.1 Global File Save	2-3
6.1.1.1 Single	2-4
6.1.1.2 All	2-5
6.1.1.3 List	2-6
6.1.1.4 Edit	2-7
6.1.1.5 Change File Name	2-8
6.1.1.6 Part Overwrite Mode	2-8
6.1.2 Global File Restore	2-9
6.1.2.1 Single	2-9
6.1.2.2 All	2-11
6.1.2.3 List	2-12
6.1.2.4 Edit	2-13
6.1.2.5 Change File Name	2-14
6.1.2.6 Part Overwrite Mode	2-14
6.1.3 List On-line Part File	2-15
6.1.4 Rename Current Part	2-16
6.1.5 Delete a Part	2-17
6.1.6 Change Part Status	2-18
6.1.7 Merge into Current Part	2-19
Origin Mode	2-20
6.1.8 Pack Part	2-21
6.1.9 Independent Save	2-21
6.1.10 Independent Restore	2-22
6.1.11 Part Integrity	2-23
6.1.11.1 Check Current Part	2-24
6.1.11.2 Renew Current Part	2-25
6.2 Pattern Management	2-26
6.2.1 Pattern Modals	2-27
6.2.1.1 Retrieve Modals	2-27
6.2.1.1.1 Origin Method	2-28
6.2.1.1.2 Scale Factor	2-29
6.2.1.1.3 Rotation Angle	2-29
6.2.1.1.4 Rotation Axis	2-30
6.2.1.1.5 Orientation	2-30
6.2.1.1.6 Reserved for Future Use	2-30
6.2.1.1.7 Entity Grouping	2-31
6.2.1.1.8 Level	2-32
6.2.1.1.9 Pen	2-33
6.2.1.1.10 Color	2-34
6.2.1.1.11 Entity Names	2-35
6.2.1.1.12 Set When Used	2-35
6.2.1.2 Restore Retrieve Modals	2-36
6.2.1.3 Copy Overwrite Mode	2-36
6.2.2 Create	2-37
6.2.3 Retrieve	2-39
Origin Method	2-40
6.2.4 Delete	2-44

6.2.5 List	2-45
6.2.5.1 Primary Library	2-46
6.2.5.2 Secondary Library	2-47
6.2.6 Copy	2-48
6.2.7 Change Primary Library	2-53
6.2.8 Change Secondary Library	2-54
Update of Pattern Libraries within ICEM DDN	2-55
6.3 Template Management	2-56
6.3.1 Create in UTF	2-58
6.3.2 Retrieve from UTF	2-59
6.3.3 Unlink a Master	2-60
6.3.4 Redefine a Master	2-61
6.3.5 Delete a Master	2-62
6.3.6 Delete from UTF	2-63
6.3.7 Create an Instance	2-64
6.3.8 Unlink an Instance	2-65
6.3.9 List On-line Templates	2-66
6.4 Reserved for Future Use	2-66
→ 6.5 User Tech File Management	2-67
6.5.1 List	2-68
6.5.2 Delete	2-68
6.5.3 Save on Global UTF	2-69
6.5.4 Restore from Global UTF	2-70
6.5.5 Initialize	2-71
6.6 Data Base Information	2-71
6.6.1 Entity Information	2-72
6.6.2 Current Part Space	2-76
6.6.3 Part File Space	2-76
6.6.4 Pattern File Space	2-77
6.6.5 User Tech Space	2-77
6.6.6 View Transformation Matrix	2-78
6.7 Dump Current Part	2-79
6.7.1 Inspect Common Values	2-80

Using Menu 6

Data Base Management provides you with the opportunity to store information concerning the important features of parts, patterns, and templates. It also allows you to inspect the data base of the current part, inspect the total data base for all parts, and to maintain a reference (user technology) file in which details about parts data may be stored and retrieved.

The menu for this chapter is:

- DATA BASE MANAGEMENT
- 1. PART MANAGEMENT
- 2. PATTERN MANAGEMENT
- 3. TEMPLATE MANAGEMENT
- 4.
- 5. USER TECH FILE MANAGEMENT
- 6. DATA BASE INFORMATION
- 7. DUMP CURRENT PART

The Data Base Management menu offers these functions:

<u>Menu Title</u>	<u>Function Description</u>
6.1 PART MANAGEMENT	Creates, names, manages, and stores parts information.
6.2 PATTERN MANAGEMENT	Creates, manages, and stores pattern information.
6.3 TEMPLATE MANAGEMENT	Defines several combined entities as a single template.
6.4 Reserved for Future Use	
6.5 USER TECH FILE MANAGEMENT	Files and stores information in the user technology file (GUTF).
6.6 DATA BASE INFORMATION	Displays the contents of the system data base.
6.7 DUMP CURRENT PART	Displays the contents of the current part data base.

The remainder of this chapter describes the choices in menu 6.

6.1 Part Management

With this choice, you can provide backup services for your parts (refer to figure 2-1). These operations provide the following services:

- Store a part on a random access file.
- Retrieve a part from a random access file.
- List your parts.
- Copy a part under a new name.
- Delete a part.
- Change the status of a part.
- Merge one part into another.
- Pack the data base of a part.
- Dump the part onto the local file IPARTD.
- List the parts stored on the local file IPARTD.
- Check the part for problems or renew the part.

The menu for this section is:

```
PART MANAGEMENT
 1.GLOBAL FILE SAVE
 2.GLOBAL FILE RESTORE
 3.LIST ON-LINE PART FILE
 4.RENAME CURRENT PART
 5.DELETE A PART
 6.CHANGE PART STATUS
 7.MERGE INTO CURRENT PART
 8.PACK PART
 9.INDEPENDENT SAVE
10.INDEPENDENT RESTORE
11.PART INTEGRITY
```

The following sections describe the choices in this menu.

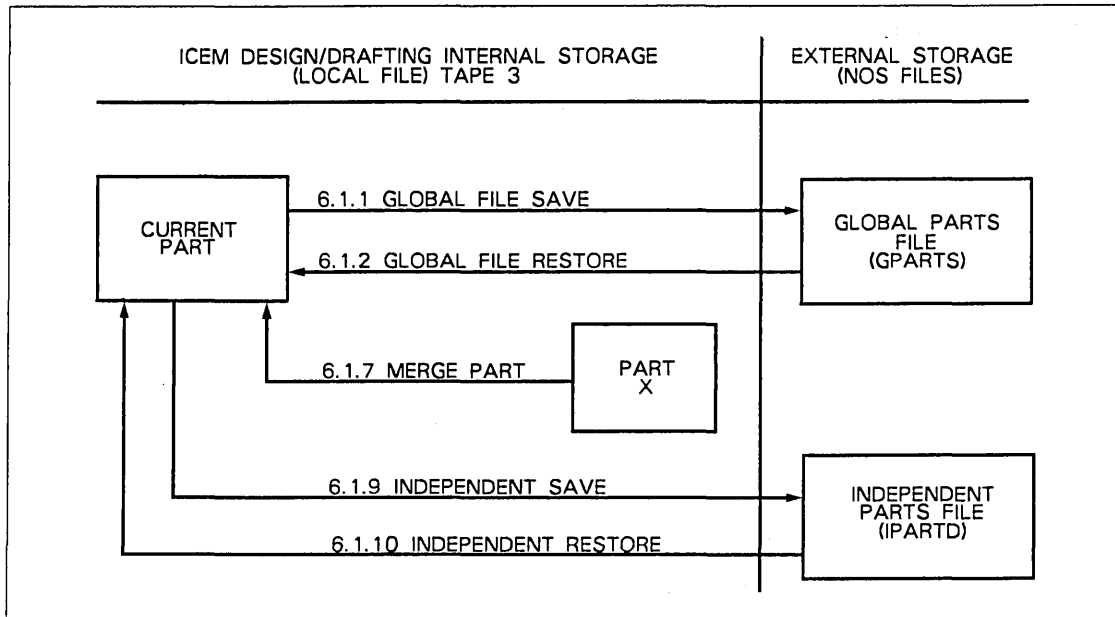

Figure 2-1. Part Management

6.1.1 Global File Save

With this choice, you can store your part on a local, external file named GPARTS. You can make this local file permanent (if it is not already permanent on mass storage) or copy it to a magnetic tape file. If the GPARTS file is already permanent, you must attach it in write mode for this operation.

The menu for this section is:

- GLOBAL FILE SAVE
- 1.SINGLE
- 2.ALL
- 3.LIST
- 4.EDIT
- 5.CHANGE FILE NAME
- 6.PART OVERWRITE MODE

The following sections describe these menu choices.

6.1.1.2 All

With this choice, all parts are saved on the external global parts file in the manner you specify with 6.1.1.6 PART OVERWRITE MODE. This mode determines how the system processes a part if a part with the same name already exists on the global parts file. When you enter ICEM DDN, the default part overwrite mode is 1.PROMPT IF PART ALREADY EXISTS. Refer to 6.1.1.6 PART OVERWRITE MODE for information about the alternate modes.

You receive the following message when you select 6.1.1.2 ALL:

```
PART OVERWRITE MODE IS current active mode      (if other than default)
SAVE ALL PARTS?
```

Enter:

Y To proceed with the part save operation.

N To return to the Global File Save menu without performing the operation.

As each part is processed, a prompt or status message is displayed, depending on the part overwrite mode.

When 1.PROMPT IF PART ALREADY EXISTS is currently active, all unique parts are automatically written to the global parts file. The status message displayed includes the sequence number of the part as it exists on TAPE3. You receive the following message:

```
PART n SAVED.
```

where n is the sequence number of the part.

If the part you are saving has the same name as a part already existing on the global parts file, you receive the following message:

```
(70-character name)
SHEET (4-digit number)
ALREADY EXISTS ON GLOBAL FILE.
OVERWRITE?
```

Enter:

Y To overwrite the existing part with the new part. The following message is displayed, after the part has been saved:

```
PART n SAVED.
```

Processing continues with the next part.

N To avoid overwriting the existing part. The following message is displayed:

```
PART n ALREADY EXISTS.
```

Processing continues with the next part.

Enter CTRL-V in response to the OVERWRITE? prompt to reset 6.1.1.6 PART OVERWRITE MODE and continue saving parts according to the new setting.

6.1.1.3 List

When 2.OVERWRITE ALL EXISTING PARTS is in effect, all parts are saved regardless of whether or not they already exist on the global parts file. You receive the following message:

PART n SAVED.

n is the sequence number of the part on TAPE3.

When 3.DO NOT OVERWRITE EXISTING PARTS is in effect, any part that already exists on the global parts file is not overwritten. All other parts are written to the global parts file. For each part on TAPE3, one of the following messages is displayed:

PART n SAVED.

OR

PART n ALREADY EXISTS.

n is the sequence number of the part on TAPE3.

When the Global File Save operation is complete, you receive the following message before returning to the Part Management menu:

PART SAVE COMPLETE.

6.1.1.3 List

With this choice, you can list the names and sheet numbers of all parts on the global part file.

After the screen is full, you can either display additional pages by entering a carriage return or terminate the listing by entering] and returning to 6.1 PART MANAGEMENT. The part names are sorted in alphabetic order, from left to right. The sort is in display coded order with a space sorted last in comparison to numbers or letters.

6.1.1.4 Edit

With this choice, you can delete a part or repack the file. You can delete more than one part so that file packing is performed quickly. The system displays:

```
EDIT MODE
1.PACK FILE
2.DELETE
```

Enter:

- 1 To pack the file and drop parts that have been deleted from the global parts file.
- 2 To delete parts from the file.

```
ENTER PART NAME          Enter the part name (70 characters
                           maximum) and the sheet number (4
                           digits maximum) of the part you want to
                           delete.

SHEET NUMBER =
```

After you select the part to be deleted, the global parts file is searched. If there is an exact match of the 70-character part name and sheet number, the system displays:

```
ENTERED NAME MATCHES PART NAMED-
```

If the entered part name is a subset of a global part name and sheet number match, the system displays:

```
ENTERED NAME IS A SUBSET MATCH OF-
```

Both messages are followed by:

```
(70-character name)
SHEET (2-digit number)
DELETE FROM GLOBAL?
```

Enter:

Y To delete the part from the global parts file and return to the ENTER PART NAME prompt. Then enter] to return to 6.1 PART MANAGEMENT.

N To return to the ENTER PART NAME prompt.

If the entered name and sheet number is a subset of more than one part with exact sheet number matches, the system displays:

```
ENTERED SUBSET MATCHES MANY NAMES.
```

You return to the ENTER PART NAME prompt.

If no part matches the entered name and sheet number, the system displays:

```
NO MATCH FOUND.
```

If the part is successfully deleted, the system responds with:

```
GLOBAL PART DELETED.
```

6.1.1.5 Change File Name

With this choice, you can change the local file name so that a file other than GPARTS can be used to restore and retrieve global parts.

OLD NAME = gparts

Enter a new file name, 2 to 7 characters long. (gparts represents the current global parts file name.)

ENTER NEW NAME

6.1.1.6 Part Overwrite Mode

With this choice, you determine the action to be taken by the system if a part with the same name already exists on the global parts file while saving all parts. Note that setting the modal causes no action itself, but it influences future actions.

This mode is in effect only when you are saving all parts (6.1.1.2 ALL).

PART OVERWRITE MODE

- 1.PROMPT IF PART ALREADY EXISTS
- 2.OVERWRITE ALL EXISTING PARTS
- 3.DO NOT OVERWRITE EXISTING PARTS

Enter:

- 1 To receive a message from the system if, in the course of saving all parts (6.1.1.2), the part already exists on the global parts file. This is the default setting. When you set the mode, you receive the following message:

PART OVERWRITE MODE IS PROMPT.

You return to the Global File Save menu.

- 2 To overwrite a part already existing on the global parts file if it has the same name as a part on TAPE3, while saving all parts (6.1.1.2). You receive the following message:

PART OVERWRITE MODE IS OVERWRITE.

You return to the Global File Save menu.

- 3 To prohibit the system from overwriting a part that already exists on the global parts file if it has the same name as a part on TAPE3, while saving all parts (6.1.1.2). You receive the following message:

PART OVERWRITE MODE IS NO OVERWRITE.

You return to the Global File Save menu.

6.1.2 Global File Restore

With this choice, you can retrieve a part from the local global parts file and place it in the data base file currently in use. After executing this operation, the part looks as it did when you last stored it on a random access file. The part to be restored must be on the local global parts file before starting the session with ICEM DDN.

The menu for this section is:

```
GLOBAL FILE RESTORE
1.SINGLE
2.ALL
3.LIST
4.EDIT
5.CHANGE FILE NAME
6.PART OVERWRITE MODE
```

The following sections describe these menu choices.

6.1.2.1 Single

With this choice, you can specify individual names and sheet numbers of parts to be restored.

ENTER PART NAME	Enter the part name (70 characters
SHEET NUMBER =	maximum) and the sheet number (4 digits
	maximum) of the part to be restored.

After you enter the part name and sheet number, the system searches for a global part which has the entered name or an identifiable subset of the name, and the exact sheet number. If the name and sheet number entered is the full name and exact sheet number of an existing part, the system displays:

```
ENTERED NAME MATCHES PART NAMED-
```

If the entered name is a subset of only one part and the sheet number is an exact match, the system displays:

```
ENTERED SUBSET MATCHES PART NAME-
```

In both cases, the system displays:

```
(70-character name)
SHEET (4-digit number)
RESTORE?
```

Enter:

Y To restore the part.

N To reject the part name.

If the entered name is a subset of more than one part, the system displays:

```
ENTERED SUBSET MATCHES MANY NAMES
```

You return to the ENTER PART NAME prompt.

If the entered name is not a match of any part name, the system displays:

```
NO MATCH FOUND
```

6.1.2.1 Single

After you select the part to be restored, the global parts file is searched. If the part exists on the global file, the system displays:

(70-character name)
SHEET (4-digit number)
ALREADY EXISTS ON TAPE3.
OVERWRITE?

Enter:

- Y To delete the part in the data base and, in its place, copy the part from the storage file.
- N To avoid deleting the part in the data base and omit copying the part from the storage file.

If there is no local file or if the local global parts file contains no parts, the system displays:

NO PARTS ON gparts

When the global file restore operation is complete, the system displays:

PART RESTORED.

6.1.2.2 All

With this choice, all parts are restored from the external global parts file to TAPE3 in the manner you specify with 6.1.2.6 PART OVERWRITE MODE. This mode determines how the system processes a part if a part with the same name already exists on TAPE3. When you enter ICEM DDN, the default part overwrite mode is 1.PROMPT IF PART ALREADY EXISTS. Refer to 6.1.2.6 PART OVERWRITE MODE for information about the alternate modes.

You receive the following message when you select 6.1.2.2 ALL:

```
PART OVERWRITE MODE IS current active mode      (if other than default)
RESTORE ALL PARTS?
```

Enter:

Y To proceed with the part restore operation.

N To return to the Global File Restore menu without performing the operation.

As each part is processed, a prompt or status message is displayed, depending on the part overwrite mode.

When 1.PROMPT IF PART ALREADY EXISTS is currently active, all unique parts are automatically written to TAPE3. The status message displayed includes the sequence number of the part as it exists on TAPE3. You receive the following message:

```
PART n RESTORED.
```

n is the sequence number of the part.

If the part you are restoring has the same name as a part already existing on TAPE3, you receive the following message:

```
(70-character name)
SHEET (4-digit number)
ALREADY EXISTS ON TAPE3.
OVERWRITE?
```

Enter:

Y To overwrite the existing part with the new part. The following message is displayed:

```
PART n RESTORED.
```

Processing continues with the next part.

N To avoid overwriting the existing part. The following message is displayed:

```
PART n ALREADY EXISTS.
```

Processing continues with the next part.

Enter CTRL-V in response to the OVERWRITE? prompt to reset 6.1.2.6 PART OVERWRITE MODE and continue restoring parts according to the new setting.

6.1.2.3 List

When 2.OVERWRITE ALL EXISTING PARTS is in effect, all parts are restored regardless of whether or not they already exist on TAPE3 or the global parts file. You receive the following message:

PART n RESTORED.

n is the sequence number of the part on TAPE3.

When 3.DO NOT OVERWRITE EXISTING PARTS is in effect, any part that already exists on TAPE3 is not overwritten. All other parts are written to TAPE3. For each part on TAPE3, one of the following messages is displayed:

PART n RESTORED.

or

PART n ALREADY EXISTS.

n is the sequence number of the part on TAPE3.

When the Global File Restore operation is complete, you receive the following message before returning to the Part Management menu:

PART RESTORE COMPLETE.

NOTE

Do not select this operation without performing a global file save pack (refer to 1.PACK FILE from 6.1.1.4 EDIT).

6.1.2.3 List

With this choice, you can list the names and sheet numbers of all parts on the global part file.

After the screen is full, you can either display additional pages by entering a carriage return or terminate the listing by entering] and returning to 6.1 PART MANAGEMENT. The part names are sorted in alphabetic order, from left to right. The sort is in display coded order with a space sorted last in comparison to numbers or letters.

6.1.2.4 Edit

With this choice, you can delete a part or repack the file. You can delete more than one part so that file packing is performed quickly. The system displays:

```
EDIT MODE
1.PACK FILE
2.DELETE
```

Enter:

- 1 To pack the file and drop parts that have been deleted from the global parts file.
- 2 To delete parts from the file.

```
ENTER PART NAME          Enter the part name (70 characters
                           maximum) and the sheet number (4
                           digits maximum) of the part to be
                           deleted.

SHEET NUMBER =
```

After you select the part to be deleted, the global part file is searched. If there is an exact match of the 70-character part name and sheet number, the system displays:

```
ENTERED NAME MATCHES PART NAMED-
```

If the entered part name is a subset of a global part name and sheet number match, the system displays:

```
ENTER NAME IS A SUBSET MATCH OF-
```

Both messages are followed by:

```
(70-character name)
SHEET (4-digit number)
DELETE FROM GLOBAL?
```

Enter:

Y To delete the part from the global parts file and return to the ENTER PART NAME prompt. Enter] to return to 6.1 PART MANAGEMENT.

N To return to the ENTER PART NAME prompt.

If the entered name and sheet number is a subset of more than one part with exact sheet number matches, the system displays:

```
ENTERED SUBSET MATCHES MANY NAMES.
```

You return to the ENTER PART NAME prompt.

If no part matches the entered name and sheet number, the system displays:

```
NO MATCH FOUND.
```

When the part is successfully deleted, the system displays:

```
GLOBAL PART DELETED.
```

6.1.2.5 Change File Name

With this choice, you can change the local file name so that a file other than GPARTS can be used to store and retrieve global parts.

OLD NAME = gparts

Enter a new file name, 2 to 7 characters long.

ENTER NEW NAME

6.1.2.6 Part Overwrite Mode

With this choice, you determine the action to be taken by the system if a part with the same name already exists on TAPE3, while restoring all parts. Note that setting the modal causes no action itself, but it influences future actions.

This mode is in effect only when you are restoring all parts (6.1.2.2 ALL).

PART OVERWRITE MODE

- 1.PROMPT IF PART ALREADY EXISTS
- 2.OVERWRITE ALL EXISTING PARTS
- 3.DO NOT OVERWRITE EXISTING PARTS

Enter:

- 1 To receive a message from the system if, in the course of restoring all parts (6.1.2.2), the part already exists on TAPE3. This is the default setting. When you set the mode, you receive the following message:

PART OVERWRITE MODE IS PROMPT.

You return to the Global File Restore menu.

- 2 To overwrite a part already existing on TAPE3 if it has the same name as a part on the global parts file, while restoring all parts (6.1.2.2). You receive the following message:

PART OVERWRITE MODE IS OVERWRITE.

You return to the Global File Restore menu.

- 3 To prohibit the system from overwriting a part that already exists on TAPE3 if it has the same name as a part on the global parts file, while restoring all parts (6.1.2.2). You receive the following message:

PART OVERWRITE MODE IS NO OVERWRITE.

You return to the Global File Restore menu.

6.1.3 List On-line Part File

With this choice, you can display a list of the parts currently in the data base. The display includes the part name and sheet number, the version (date and time of day) of the latest filing of the part on mass storage, the number of physical record units (PRUs) required for storage, the location of the part on mass storage, and the release or revision number. Figure 2-2 shows a sample parts list.

PART LIST						
9:45 7/12/82						
DATE	TIME	SIZE	LOC	RL/RU	SHEET	NAME
9/ 1/81	9:51	230	0	1.35	1	DRAWING FLOW
9/ 8/81	9:10	66	230	1.30	1	FORMAT
1/12/81	20:47	126	296	1.10	1	WINGPYLON
7/12/82	9:38	70	422	1.40	1	TEST FOR SYSTEM MODALS
7/12/82	9:40	70	492	1.40	1	1-800-1234-56789 MAIN CRANKSHAFT BEARING
7/12/82	9:41	70	562	1.40	1	THIS IS AN EXAMPLE OF THE USE OF A FULL SEVENTY CHARACTER PART NAME.

Figure 2-2. Parts List

NOTE

Whenever a part list is executed, the system checks the beginning and ending points of the disk location. If a part overlap is located, the system displays this message:

BAD PART INDEX

In addition, the part header is checked for correctness. If a header is bad, an asterisk (*) is displayed before the part name in the part list.

Hardware and software problems can cause parts to become bad or damaged. If one or more parts on a TAPE3 part file become bad or damaged, save good parts on the local GPARTS external file, using 6.1.1 GLOBAL FILE SAVE. Then discard the old TAPE3 part file, and restore the good parts to a new TAPE3 part file.

6.1.4 Rename Current Part

With this choice, you can create a new part name and sheet number for the part on which you are currently working.

ENTER NEW PART NAME

Enter the part name (70 characters maximum) and the sheet number (4 digits maximum) of the part to be renamed.

SHEET NUMBER =

If a part by this name already exists, the system displays:

PART NAME ALREADY EXISTS,
CONTINUE?

Enter:

Y To continue by overwriting the old part name.

N To enter another name.

NOTE

The new part name and sheet number exist only in the local working part space until a file command is given (refer to 4 FILE/EXIT in the ICEM Design/Drafting Introduction and System Controls manual). When the new part name and sheet number are filed, the system deletes an existing part that has the entered name and sheet number, so use caution during this operation.

6.1.6 Change Part Status

With this choice, you can change the status of a part from in-process to released. A part whose status is released cannot be changed or filed, nor can the status of a part be changed from released to in-process. The system requests verification that the status is to be changed.

DO YOU WANT TO RELEASE PART?

Enter:

Y To change the part status to release.

N To avoid changing the part status.

After the status is successfully changed, the system displays:

RELEASED

Refer to 1.13 DISPLAY TITLE BLOCK in the ICEM Design/Drafting Introduction and System Controls manual.

6.1.7 Merge into Current Part

With this choice, you can merge a drawing of one part into the current part. The part to be merged must be on local file TAPE3. Merging a part does not remove it from the local file TAPE3.

ENTER NAME OF PART TO BE MERGED	Enter the part name (70 characters maximum) and the sheet number (4 digits maximum) of the part to be merged.
SHEET NUMBER =	

After you enter the part name and sheet number, the system searches the local part file for a part which has the entered name, or an identifiable subset of the name, and the exact sheet number. If the name and sheet number entered is the full name and exact sheet number of an existing part, the system displays:

ENTERED NAME MATCHES PART NAMED-

Also, if the entered name is not a subset of any other name, the system displays the ORIGIN MODE prompt.

If the entered name is a subset of only one part and the sheet number is an exact match, the system displays:

ENTERED NAME IS A SUBSET MATCH OF --

In both cases, the system displays:

(70-character name)	Enter:
SHEET (4-digit number)	Y To merge the part.
CONTINUE WITH MERGE?	N To return to the ENTER NAME prompt.

If the entered name is a subset of more than one part, the system displays:

ENTERED SUBSET MATCHES MANY NAMES

You return to the ENTER NAME prompt.

If the entered name is not a match of any part name, the system displays:

NO MATCH FOUND

After completion of the merge operation, the system displays the following, if any names were deleted.

```

nnnnn ENTITY NAME CONFLICTS          Enter:
FOUND
LIST DELETED NAMES?                  Y To display the list.
DELETE                                N To avoid displaying the list.

```

PART MERGE ENTITY NAME DELETION TABLE		
NAME	SEGS	TYPE
SPL005	041	3-D SPLINE
P42	047	POINT
L123	062	LINE
SURF1	065	RULED/DEVELOPABLE SURFACE
SURF2	006	TABULATED CYLINDER

Figure 2-3. Entity Name Deletion Table

When the listing is complete, the system displays:

```

LISTING COMPLETE, ACKNOWLEDGE          Enter [ or ] to repaint the merged part.

```

6.1.8 Pack Part

With this choice, you can rearrange the data in the TAB2 and TAB3 tables to match the order of the TAB1 pages. This rearrangement reduces the number of extra disk accesses needed during repaint operations, entity selection, and entity manipulation.

If the data base pack operation is successfully completed, the system displays:

```

PACK COMPLETE

```

6.1.9 Independent Save

With this choice, you can dump the currently displayed part onto the local file IPARTD in a format that is independent of the system data base structure. This allows you to dump parts for reloading on a new system version that uses a different data base structure. Upon completion of the operation, the parts stored on the IPARTD file are listed on the screen and you return to 6.1 PART MANAGEMENT.

6.1.10 Independent Restore

With this choice, you can list the parts stored on the local file IPARTD on the screen.

ENTER PART NAME

Enter the part name (70 characters maximum) and the sheet number (4 digits maximum) of the part to be restored.

SHEET NUMBER =

If the IPARTD file is empty or was not created by 6.1.9 INDEPENDENT SAVE, the system displays:

FILE IS NOT RELEASE INDEPENDENT

You can enter a name or unique subset and sheet number of a part on the IPARTD file. If the name and sheet number entered is the full name and exact sheet number of a part on the IPARTD file, the system displays:

ENTERED NAME MATCHES PART NAMED-

Also, if the entered name is not a subset of any other name, the part is chosen and the system displays the units and standard message.

If the entered name is a subset of only one part name and the sheet number is an exact match, the system displays:

ENTERED SUBSET MATCHES PART NAME-

In both cases, the system displays:

(70-character name)
SHEET (4-digit number)
RESTORE?

Enter:

Y To accept the part name and continue.

N To return to the ENTER PART NAME prompt.

If the entered name is a subset of more than one part, the system displays:

ENTERED SUBSET MATCHES MANY NAMES

If the entered name is not a match of any part name, the system displays:

NO MATCH FOUND

After you select the IPARTD part name, the system displays:

THIS PART IS IN ENGLISH UNITS
AND IS DRAWN TO ANSI STANDARD
CONTINUE?

Enter:

Y To restore the part from the IPARTD file into the current part. The current part name and sheet number are retained. The part must be filed to be permanently saved. The current part must be empty prior to restoring from IPARTD. Upon successful completion of the restore operation, the part is repainted and you return to 6.1 PART MANAGEMENT.

N To return to the ENTER PART NAME prompt.

6.1.11 Part Integrity

With this choice, you can check the current part for data base problems, or renew the current part and thus eliminate problems and resequence the part.

The menu for this section is:

PART INTEGRITY
1.CHECK CURRENT PART
2.RENEW CURRENT PART

The following sections describe the choices in this menu.

6.1.11.1 Check Current Part

With this choice, you can check the current part for these problems:

- Damaged or corrupt COMMON values.
- Damaged entity information such as type, form, view of definition, attributes, name conflicts, TAB2 and TAB3 data.
- Damaged view information such as view number and view matrix determinant.
- Degenerate or damaged entities (lines of zero length, arcs with equal start and end angles, two-dimensional splines of zero or negative length).
- References to invalid pointers and sequence numbers.

Problems encountered during the check operation are described in a report that can be displayed after completing the check.

The report information can be used in conjunction with 5.1 CANON and 6.7.1 INSPECT COMMON VALUES for more detailed information. Menu 6.1.11.2 RENEW CURRENT PART can be used to eliminate the problems.

The system displays the following progress report for every 250 entities checked:

nnn ENTITIES CHECKED

If no problems are encountered during the check operation, the system displays:

NO PROBLEMS FOUND

You return to 6.1 PART MANAGEMENT.

If problems are encountered during the check operation, the system displays:

nn PROBLEMS DISCOVERED
DISPLAY PROBLEM REPORT?

Enter:

Y To display a report describing problems that were encountered during the check operation (figure 2-4).

N To avoid displaying the report.

You return to 6.1 PART MANAGEMENT.

PART INTEGRITY REPORT			
SEQUENCE NUMBER	PAGE/PTR NUMBER	ENTITY TYPE	PROBLEM REPORT
-	1025	-	CURRENT LEVEL RANGE BAD
130	1205	-	ENTITY TYPE NUMBER CORRUPT
-	9	-	TAB4 VIEW MATRIX DETERMNT. BAD
79	1097	N/C CONTOURING TOOLPATH	TAB4 PTR IN TAB2 DATA CORRUPT
83	1089	COPIOUS DATA	ENTITY TAB2 DATA CORRUPT
116	1137	GENERAL NOTE	ENTITY VIEW OF DEF PTR CORRUPT

Figure 2-4. Check and Renew Current Part Problem Report

6.1.11.2 Renew Current Part

With this choice, you can renew the current part. This consists of checking entities for data base problems (described in 6.1.11.1 CHECK CURRENT PART), eliminating problem entities and views, and recreating the entities that have no problems. This process resequences the part. It is similar to merging the part into a blank part, but this operation retains modal values in COMMON and informs you of any problems discovered.

If the current part has severe COMMON problems, the system displays:

UNABLE TO RENEW PART

You return to 6.1.11 PART INTEGRITY.

The system displays the following progress report for every 250 entities renewed:

nnn ENTITIES RENEWED

If no problems are encountered during the renew operation, the system displays:

NO PROBLEMS FOUND

You return to 6.1 PART MANAGEMENT.

If problems are encountered during the renew operation, the system displays:

nn PROBLEMS DISCOVERED
AND ELIMINATED
DISPLAY PROBLEM REPORT?

Enter:

Y To display a report describing problems that were eliminated during the renew operation (figure 2-4).

N To avoid displaying the report.

You return to 6.1 PART MANAGEMENT.

6.2 Pattern Management

With this choice, you can use patterns in the construction of parts. These are the pattern operations:

- Set pattern modals.
- Create patterns that are stored on the primary library.
- Retrieve patterns from the primary or secondary library.
- Delete one or all patterns from the primary library.
- List all patterns on the primary or secondary library.
- Copy one or all patterns from the primary library to the secondary, or from the secondary library to the primary.
- Change the primary library.
- Change the secondary library.

The maximum number of patterns on either the primary or secondary library is 2048. The maximum number of entities in a pattern is 2048.

The primary pattern library file is the local file PATTERN, which is automatically created if it is not attached before entering ICEM DDN. Refer to figure 2-5.

The menu for this section is:

```

PRIMARY LIBRARY = name
PATTERN MANAGEMENT
1.PATTERN MODALS
2.CREATE
3.RETRIEVE
4.DELETE
5.LIST
6.COPY
7.CHANGE PRIMARY LIBRARY
8.CHANGE SECONDARY LIBRARY

```

The following sections describe the choices in this menu.

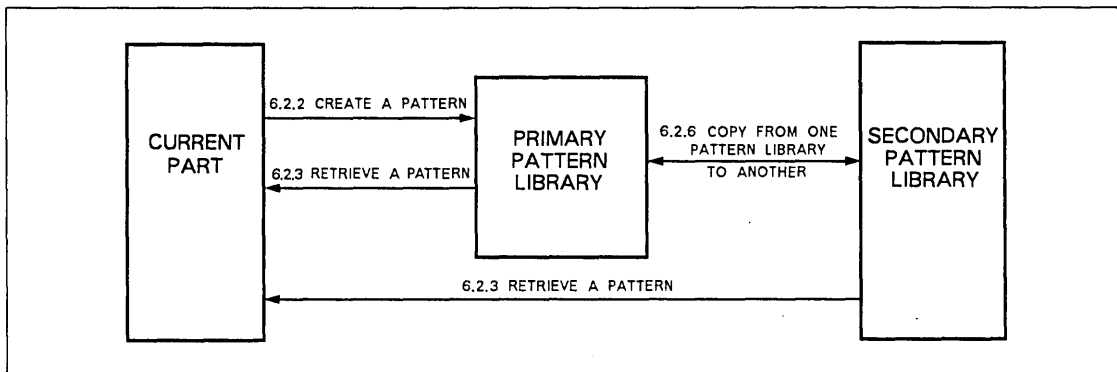

Figure 2-5. Pattern Management

6.2.1 Pattern Modals

Pattern modals allow you to specify the operation of several pattern functions:

- PATTERN MODALS
- 1.RETRIEVE MODALS
- 2.RESTORE RETRIEVE MODALS
- 3.COPY OVERWRITE MODE

The descriptions of these menu choices follow.

6.2.1.1 Retrieve Modals

With this choice, you can set the values of the retrieve modals. The menu for this section is:

- RETRIEVE MODALS
- 1.ORIGIN METHOD
- 2.SCALE FACTOR
- 3.ROTATION ANGLE
- 4.ROTATION AXIS
- 5.ORIENTATION
- 6.
- 7.ENTITY GROUPING
- 8.LEVEL
- 9.PEN
- 10.COLOR
- 11.ENTITY NAME
- 12.SET WHEN USED

6.2.1.1.1 Origin Method

With this modal, you can choose the method for defining the origin.

ORIGIN METHOD
1.SCREEN POSITION
2.ENTER COORDINATES
3.EXISTING POINT
4.DELTA FROM CURVE END
5.NORMAL TO CURVE

Enter:

- 1 To use the graphics cursor to indicate the origin position. The following message is displayed:

ORIGIN METHOD IS SCREEN POSITION

With this method, the following message is displayed when you retrieve a pattern:

INDICATE ORIGIN POSITION

- 2 To enter the coordinates of the origin. The following message is displayed:

ORIGIN METHOD IS ENTER COORDINATES

With this method, the following message is displayed when you retrieve a pattern:

ORIGIN COORDINATES
1.XT =
2.YT =
3.ZT =

If 6.2.1.1.5 ORIENTATION is set to 2.MODEL SPACE, the model coordinates (x,y,z) replace the transform coordinates (xt,yt,zt).

- 3 To select an existing point as the origin. This is the default setting. The following message is displayed:

ORIGIN METHOD IS EXISTING POINT

With this method, the following message is displayed when you retrieve a pattern:

INDICATE ORIGIN POINT

- 4 To enter delta coordinates from a curve end. The following message is displayed:

ORIGIN METHOD IS DELTA FROM CURVE END

With this method, the following message is displayed when you retrieve a pattern:

ORIGIN IS DELTA FROM CURVE END
INDICATE CURVE

DELTA
1.XT =
2.YT =
3.ZT =

If 6.2.1.1.5 ORIENTATION is set to 2.MODEL SPACE, the model coordinates (x,y,z) replace the transform coordinates (xt,yt,zt).

- 5 To select a point normal to a curve. The following message is displayed:

ORIGIN METHOD IS NORMAL TO CURVE

With this method, the following message is displayed when you retrieve a pattern:

ORIGIN IS NORMAL TO CURVE
INDICATE 2-D CURVE

INDICATE POSITION

Origin method 5.NORMAL TO CURVE does not rotate the pattern by the value in the Rotation Angle modal. This value is not replaced by the normal rotation value.

6.2.1.1.2 Scale Factor

With this modal, you can set the scale factor. The system reproduces the pattern's entities at a size directly proportional to this scale factor.

SCALE FACTOR = n.nnnn

Enter the scale factor. The default value is 1.0.

6.2.1.1.3 Rotation Angle

With this modal, you can set the rotation angle. The system rotates the pattern's entities this distance about the axis.

ROTATION ANGLE = n.nnnn

Enter the rotation angle. A positive entry causes counterclockwise rotation; a negative entry causes clockwise rotation. The default value is 0.0.

6.2.1.1.4 Rotation Axis

With this modal, you can choose the axis about which to rotate the pattern's entities. This axis is defined by 6.2.1.1.5 ORIENTATION.

ROTATION AXIS
1.X/XT-AXIS
2.Y/YT-AXIS
3.Z/ZT-AXIS

Enter:

- 1 To rotate the pattern entities about the x-axis. The following message is displayed:

ROTATION AXIS IS THE X/XT-AXIS

- 2 To rotate the pattern entities about the y-axis. The following message is displayed:

ROTATION AXIS IS THE Y/YT-AXIS

- 3 To rotate the pattern entities about the z-axis. This is the default setting. The following message is displayed:

ROTATION AXIS IS THE Z/ZT-AXIS

6.2.1.1.5 Orientation

With this modal, you can choose the coordinate system about which to orient the pattern's entities. All other retrieve modals that reference points, axes, or planes refer to this orientation for defining these points, axes, or planes.

ORIENTATION
1.WORK SPACE
2.MODEL SPACE

Enter:

- 1 To set the orientation as the current workspace. This is the default value. The pattern is retrieved with the entities oriented about the current workspace. The following message is displayed:

ORIENTATION IS WORK SPACE

- 2 To set the orientation as model space. The pattern is retrieved with the entities oriented about model space. The following message is displayed:

ORIENTATION IS MODEL SPACE

6.2.1.1.6 Reserved for Future Use

6.2.1.1.7 Entity Grouping

With this modal, you may choose whether or not to define the pattern's entities as part of a group. This is only effective if there are no more than 240 entities within a pattern.

ENTITY GROUPING

1.ON

2.OFF

Enter:

- 1 To define the pattern's entities as part of a group whenever there are no more than 240 entities. Only the entities allowed are grouped. The following message is displayed:

ENTITY GROUPING IS ON

If the pattern you retrieved has more than 240 entities, the following message is displayed during retrieval:

PATTERN NOT GROUPED - TOO MANY ENTITIES

- 2 To define the pattern's entities individually. This is the default setting. The following message is displayed:

ENTITY GROUPING IS OFF

6.2.1.1.8 Level

With this modal, you can set the level on which the pattern's entities are defined.

LEVEL

1. USE ORIGINAL LEVELS
2. OFFSET FROM ORIGINAL LEVELS
3. USE CURRENT LEVEL
4. SPECIFY LEVEL

Enter:

- 1 To define all pattern entities on their original levels. This is the default setting. The following message is displayed:

LEVEL IS ORIGINAL

- 2 To define all pattern entities on a level that is a specified offset from the original levels. All entities whose new offset level is greater than 1023 are defined on level 1023. All entities whose new offset level is less than 0 are defined on level 0.

LEVEL OFFSET = nn

Enter the offset value. This value must be within the range of -1023 to 1023.

The following message is displayed:

LEVEL IS OFFSET BY nn

- 3 To define all pattern entities on the current level. The following message is displayed:

LEVEL IS CURRENT

- 4 To define all pattern entities on a specified level.

LEVEL = nn

Enter the pattern retrieval level. Allowable levels are 0 through 1023.

The following message is displayed:

LEVEL IS SPECIFIED ON nn

6.2.1.1.9 Pen

With this modal, you can set the pen method for defining the pattern's entities.

PEN

1. USE ORIGINAL PEN
2. USE CURRENT PEN
3. SPECIFY PEN

Enter:

- 1 To define all pattern entities with their original pens. This is the default setting. The following message is displayed:

PEN IS ORIGINAL

- 2 To define all pattern entities with their pens set to the current part's pen. The following message is displayed:

PEN IS CURRENT

- 3 To define all pattern entities with the same specified pen.

PEN = nn

Enter the pattern retrieval pen number.
Allowable pen numbers are 0 through
15.

The following message is displayed:

PEN IS SPECIFIED WITH nn

6.2.1.1.10 Color

With this modal, you can set the color for displaying the entities if the current color display mode is 1.9.1.4 ASSIGNED ENTITY COLOR and if you are using a color terminal.

- COLOR NUMBER
- 1.USE ORIGINAL ENTITY COLOR
 - 2.USE CURRENT COLOR
 - 3.SPECIFY COLOR

Enter:

- 1 To define all pattern entities with their original display color. This is the default value. The following message is displayed:

COLOR IS ORIGINAL

- 2 To define all pattern entities with their display color set to the current part's display color. The following message is displayed:

COLOR IS CURRENT

- 3 To define all pattern entities with the same display color.

COLOR = nn

Enter the pattern display color.
Allowable colors are 0 through 15.

The following message is displayed:

COLOR IS SPECIFIED WITH nn

To view the colors before changing the level number color, either go to 1.9.2 COLOR ENVIRONMENT to display the color table, or set the automatic display, 1.9.1.8 COLOR SPECTRUM DISPLAY, to on.

6.2.1.1.11 Entity Names

With this modal, you can choose whether or not you want the entity names to be retained with the entities.

ENTITY NAMES
1.DROP ENTITY NAMES
2.RETAIN ENTITY NAMES

Enter:

- 1 To drop entity names when you retrieve the pattern. This is the default value. The following message is displayed:

DROP ENTITY NAMES

- 2 To retain entity names when you retrieve the pattern. The following message is displayed:

RETAIN ENTITY NAMES

If you set the modal to retain entity names and there is a conflict with existing entity names in the part, the conflicting names are dropped during retrieval and the following message is displayed:

nn CONFLICTING ENTITY NAMES DROPPED

6.2.1.1.12 Set When Used

With this modal, you can choose whether or not to display the Modify Modals menu automatically during the retrieve process.

SET WHEN USED
1.ON
2.OFF

Enter:

- 1 To display the Modify Modals menu during retrieve. This is the default value. The following message is displayed:

SET WHEN USED IS ON

- 2 To omit the display of the Modify Modals menu during the retrieve process. By turning this modal off, you are prompted only for the pattern name and its origin. All options use the previously set modal values. The following message is displayed:

SET WHEN USED IS OFF

6.2.1.2 Restore Retrieve Modals

With this modal, you can set all pattern retrieve modals to their default values, as specified below. All previously set values are then replaced. The following values are displayed:

ORIGIN METHOD	EXISTING POINT
SCALE FACTOR	1.0
ROTATION ANGLE	0.0
ROTATION AXIS	Z/ZT-AXIS
ORIENTATION	WORK SPACE
ENTITY GROUPING	OFF
LEVEL	ORIGINAL
PEN	ORIGINAL
COLOR	ORIGINAL
ENTITY NAME	DROPPED
SET WHEN USED	ON

6.2.1.3 Copy Overwrite Mode

With this choice, you can specify the overwrite mode when all patterns are copied from one pattern library to another. Setting the modal causes no action itself, but it influences future actions.

```
COPY OVERWRITE MODE
1.PROMPT IF PATTERN ALREADY EXISTS
2.OVERWRITE ALL EXISTING PATTERNS
3.DO NOT OVERWRITE EXISTING PATTERNS
```

Enter:

- 1 To receive a message from the system if the pattern already exists on the pattern library. When you set the mode, you receive the following message:

```
COPY OVERWRITE MODE IS PROMPT.
```

Then, if a pattern with the same name is found on both pattern libraries, you receive the following message:

```
(64-character name)
ALREADY EXISTS. OVERWRITE?
```

Enter:

Y To overwrite the existing pattern with the new pattern. Processing continues with the next pattern.

N To avoid overwriting the existing pattern. You proceed to the next pattern. You can enter CTRL-V to reset 6.2.1.3 COPY OVERWRITE MODE and continue saving patterns according to the new setting.

- 2 To overwrite all patterns with the same name on both pattern libraries in subsequent copy operations. You receive the following message:

```
COPY OVERWRITE MODE IS OVERWRITE.
```

6.2.2 Create

After selecting entities, you are prompted for the pattern's origin. Later, when the pattern is retrieved and reproduced in the current part (refer to 6.2.3 RETRIEVE), the pattern's origin is placed at the position indicated for the retrieval origin. Select the manner in which the pattern's origin is to be indicated.

ORIGIN METHOD
1.SCREEN POSITION
2. ENTER COORDINATES
3.EXISTING POINT
4.LOWER LEFT

Enter:

- 1 To indicate the origin by screen position.

INDICATE ORIGIN POSITION

Use the graphics cursor to indicate the origin position.

- 2 To enter the coordinates of the origin. The following is displayed if the workspace is view 1:

ORIGIN COORDINATES
1.X = 0.0000
2.Y = 0.0000
3.Z = 0.0000

Enter the coordinates of the origin.

You receive the following prompt if the workspace is not view 1:

ORIGIN COORDINATES
1.XT = 0.0000
2.YT = 0.0000
3.ZT = 0.0000

Enter the coordinates of the origin.

- 3 To select an existing point as the origin.

INDICATE ORIGIN POINT

Use the graphics cursor to select an existing point as the origin.

- 4 To use the lower leftmost point of the pattern as the origin.

When the pattern is created on the primary library, you receive the following message:

PATTERN CREATED

You then return to the ENTER PATTERN NAME prompt.

6.2.3 Retrieve

With this choice, you can retrieve a pattern to use in the current part. The effect of this operation is the same as creating each of the pattern's entities individually. The pattern's origin is placed at the position you indicate. This position can be oriented in the workspace or model space. The pattern can be rotated about the x-, y-, or z-axis, and a scale can be set at which the pattern is reproduced. The entities created can be defined as a group (if they pass the requirements for groups), or as individual entities. There are several methods for setting the level, pen number, and display color of these entities. The entities may also retain their names.

RETRIEVE
ENTER PATTERN NAME

Enter the name of the pattern to be retrieved from either the primary or secondary library.

After you enter the pattern name, the libraries are searched, beginning with the primary library and proceeding to the secondary library. If the name you entered exactly matches a pattern name, the system either continues on to the Modify Modals menu or prompts you for a new pattern origin (depending on modal 6.2.1.1.12 SET WHEN USED) after displaying one of the following messages:

PATTERN FOUND ON PRIMARY LIBRARY
name

or

PATTERN FOUND ON SECONDARY LIBRARY
name

If the name you entered is a subset of only one pattern name, the system either continues on to the Modify Modals menu or prompts you for a new pattern origin (depending on modal 6.2.1.1.12 SET WHEN USED) after displaying one of the following messages:

NAME IS A SUBSET OF PATTERN
name
FOUND ON PRIMARY LIBRARY
name

or

NAME IS A SUBSET OF PATTERN
name
FOUND ON SECONDARY LIBRARY
name

If the name you entered is a subset of more than one pattern or if the name you entered does not match any pattern, the system returns to the ENTER PATTERN NAME prompt after it displays one of the following messages:

NAME IS A SUBSET OF MANY PATTERNS

or

NAME DID NOT MATCH ANY PATTERNS

If 6.2.1.1.12 SET WHEN USED is turned off, the system uses the origin method you set to determine the origin selection method. If the Set When Used modal is turned on, the following menu is displayed and you can modify the retrieve modals:

MODIFY MODALS		Enter the number of the modal you want to modify. You are then prompted for the new value for that particular modal. These prompts are the same as the actual modal prompts. When finished, you return to this menu and can continue with another modification by entering another number.
1.ORIGIN METHOD	EXISTING POINT	
2.SCALE FACTOR	1.0	
3.ROTATION ANGLE	0.0	
4.ROTATION AXIS	Z/ZT-AXIS	
5.ORIENTATION	WORK SPACE	
6.		
7.ENTITY GROUPING	OFF	
8.LEVEL	ORIGINAL	or
9.PEN	ORIGINAL	Enter:
10.COLOR	ORIGINAL	
11.ENTITY NAME	DROPPED] To go to the selected retrieval origin position. Any changed values are now the current primary values.
		[To return to the ENTER PATTERN NAME prompt.

Origin Method

Depending on the setting of the Origin Method modal, you are prompted for the origin position in one of five ways. Entering the Other Options key (V or CTRL-V) allows you to access the Modify Modals menu before specifying the origin. The five Origin Method prompts are:

- 1.SCREEN SELECT
- 2.ENTER COORDINATES
- 3.EXISTING POINT
- 4.DELTA FROM CURVE END
- 5.NORMAL TO CURVE

Enter:

- 1 To indicate the origin by screen position.

INDICATE ORIGIN POSITION

Use the graphics cursor to indicate the origin position.

- 2 To enter the coordinates of the origin. If 6.2.1.1.5 ORIENTATION is set to 2.MODEL SPACE, the model coordinates (x,y,z) replace the transform coordinates (xt,yt,zt) in the following prompt:

ORIGIN COORDINATES

Enter the coordinates of the origin.

1.XT =

2.YT =

3.ZT =

- 3 To select an existing point as the origin.

INDICATE ORIGIN POINT

Use the graphics cursor to select an existing point as the origin.

- 4 To enter delta coordinates from a curve end. If 6.2.1.1.5 ORIENTATION is set to 2.MODEL SPACE, the model coordinates (x,y,z) replace the transform coordinates (xt,yt,zt) in the following prompt:

ORIGIN IS DELTA FROM CURVE END

INDICATE CURVE

Use the graphics cursor to select a curve from which a delta distance for the pattern is specified. The screen position should be nearest to the required end.

DELTA

1.XT =

2.YT =

3.ZT =

Enter the delta from the curve end.
Enter [to reselect the curve.

5 To select a point normal to a curve.

ORIGIN IS NORMAL TO CURVE
INDICATE 2-D CURVE

Select a curve to which the pattern is to be normal.

INDICATE POSITION

Use the graphics cursor to select a position near the curve you selected. This determines the position on the curve that will be the origin of the pattern being retrieved. The position you indicate determines the side of the normal desired. For example, if your indication is above a horizontal line, the rotation angle is 0°; if below the line, the rotation angle is 180°.

Enter:

[To reselect the curve.

] To return to the ENTER PATTERN NAME prompt.

If 1.2.1 CONTINUE OPERATION is on, the prompt for the pattern origin repeats until you enter [or]. [returns you to the Modify Modals menu if 6.2.1.1.12 SET WHEN USED is turned on. If it is turned off, you return to the ENTER PATTERN NAME prompt.] sends you to the ENTER PATTERN NAME prompt.

If 1.2.1 CONTINUE OPERATION is off, you return to 6.2 PATTERN MANAGEMENT.

The following situations show messages that may be displayed during retrieval.

If the pattern you want to retrieve has more than 240 entities and 6.2.1.1.7 GROUP ENTITIES modal is on, the following message is displayed:

PATTERN NOT GROUPED - TOO MANY ENTITIES

If the pattern you want to retrieve has entities that cannot be grouped and 6.2.1.1.7 GROUP ENTITIES modal is on, the system includes all entities that can be grouped. Then it displays the following message:

SOME ENTITIES COULD NOT BE GROUPED

If the pattern you want to retrieve has named entities and the modal 6.2.1.1.11 ENTITY NAMES is set to retain the names, when there is a conflict with existing entity names, the entity names from the pattern are dropped during retrieval. The following message is displayed:

nn CONFLICTING ENTITY NAMES DROPPED

If a new view is created during retrieval, you receive the following message:

NEW VIEW NUMBER nn CREATED

If more than one view is created, the message says:

NEW VIEWS NO. nn-mm CREATED

If the number of new views needed exceeds the maximum allowed in the part, the pattern is not retrieved and you receive the following message:

MAXIMUM NUMBER OF VIEWS EXCEEDED
PATTERN COULD NOT BE RETRIEVED

NOTE

Drafting dimensions within patterns are not retrieved if you specified rotation of the pattern. Also, if a retrieved pattern has drafting entities created according to a drafting standard different from the one applicable to the current part, the entities are not retrieved. Drafting entities from an ANSI 73 pattern, however, can be retrieved for use in an ANSI 82 part. Likewise, drafting entities from an ANSI 82 pattern can be retrieved for use in an ANSI 73 part.

6.2.4 Delete

With this choice, you can delete a single pattern or all patterns on the primary library.

If the primary library is not attached in write mode, the system displays the following message before returning to 6.2 PATTERN MANAGEMENT:

```
THIS PRIMARY LIBRARY DOES NOT HAVE
WRITE PERMISSION
```

If the primary library has no patterns, the system displays the following message before returning to 6.2 PATTERN MANAGEMENT:

```
PRIMARY LIBRARY EMPTY
```

If the primary library contains patterns and is in write mode, the following menu is displayed:

```
DELETE
1.SINGLE
2.ALL
```

Enter:

- 1 To delete a single pattern on the primary library.
- 2 To delete all patterns on the primary library.

If you choose 1.SINGLE, the system prompts for the pattern name to be deleted from the primary library:

```
DELETE
ENTER PATTERN NAME
```

Enter the name of the pattern you want to delete from the primary library.

After you enter the pattern name, the primary library is searched. If the name you entered exactly matches a pattern, or is a subset of only one pattern, the system displays:

```
DELETE PATTERN
name?
```

Enter:

- Y To delete the pattern from the primary library.
- N To avoid deleting the pattern from the primary library. The system then returns to the ENTER PATTERN NAME prompt.

If you enter Y in response to this prompt, the system deletes the pattern and displays the following confirmation message before returning to the ENTER PATTERN NAME prompt:

```
PATTERN DELETED
```

If the name you entered is a subset of more than one pattern, or if the name you entered does not match any pattern, the system displays one of the following messages before returning to the ENTER PATTERN NAME prompt:

NAME IS A SUBSET OF MANY PATTERNS

or

NAME DID NOT MATCH ANY PATTERN

If you choose 2.ALL from the Delete menu, the system deletes all existing patterns stored on the primary library.

DELETE ALL PATTERNS?

Enter:

Y To delete all patterns on the primary library.

N To avoid deleting the patterns. The system returns to the Delete menu.

If you enter Y in response to this prompt, the system displays the following confirmation message before returning to the main PATTERN menu:

ALL PATTERNS DELETED

6.2.5 List

With this choice, you can list the patterns on the primary library or on the secondary library.

LIST

1.PRIMARY LIBRARY

2.SECONDARY LIBRARY

The following sections describe the choices in this menu.

6.2.5.1 Primary Library

With this choice, you can display a list of all patterns on the primary library. The display includes the pattern name, date and time created, number of entities in the pattern, number of sectors required for storage, and units and drafting standard with which the pattern was created. The units system used is identified by MET for metric, ENG for English, and FT/IN for feet and inches. The drafting standard is identified by A 73 for ANSI 73, A 82 for ANSI 82, A MXD for ANSI mixed, DIN for German, NFC for French, BIS for British, SMS for Swedish, and JIN for Japanese. Figure 2-6 shows an example of the primary pattern library list.

PRIMARY LIBRARY LIST							
LIBRARY NAME = PATTERN		8/30/85 9:34		RELEASE/REVISION 1.60			
NUMBER OF PATTERNS = 12							
PATTERN NAME	DATE CREATED	TIME CREATED	ENTITY COUNT	SIZE	UNIT	DRAFT STD	
BOLT	8/30/85	8:22	18	3	ENG	A 73	
ASSEMBLY 3481	8/30/85	8:26	378	24	ENG	A 73	
DIMENSION A136/52	8/30/85	8:35	333	40	ENG	A 73	
WASHER - X25	8/30/85	8:36	6	2	ENG	A 73	
NUT/BOLT/WASHER COMBINATION A364	8/30/85	8:38	66	5	ENG	A 73	
DOOR FRAME	8/30/85	8:40	23	5	ENG	A 73	
LARGE PATTERN WITH A NAME THAT IS ALMOST 64 CHARACTERS LONG (63)	8/30/85	8:49	1391	203	MET	A 82	
SHEET METAL - SURFACE 12	8/30/85	8:55	56	44	ENG	A 82	
X12345	8/30/85	8:56	9	2	ENG	A 82	
HEX NUT A364	8/30/85	9:22	13	4	ENG	A 73	
BOLT A364	8/30/85	9:23	20	5	ENG	A 73	
WASHER (ROUND) - A364	8/30/85	9:25	22	5	ENG	A 73	

Figure 2-6. Primary Pattern Library List

If the list of patterns extends beyond a full screen, the system displays:

CONTINUE?

Enter:

Y To display a list of additional patterns.

N To return to 6.2.5 LIST.

6.2.5.2 Secondary Library

With this choice, you can list the contents of the secondary library. Refer to 6.2.5.1 PRIMARY LIBRARY for a description of the information in the list. Figure 2-7 provides an example list.

S E C O N D A R Y L I B R A R Y L I S T						
LIBRARY NAME = BACKUP		8/30/85 9:35		RELEASE/REVISION 1.60		
NUMBER OF PATTERNS = 12						
PATTERN NAME	DATE CREATED	TIME CREATED	ENTITY CGUNT	SIZE	UNIT	DRAFT STD
BOLT	8/30/85	8:22	18	3	ENG	A 73
ASSEMBLY 3481	8/30/85	8:26	378	24	ENG	A 73
DIMENSION A136/52	8/30/85	8:35	333	40	ENG	A 73
WASHER - X25	8/30/85	8:36	6	2	ENG	A 73
NUT/BOLT/WASHER COMBINATION A364	8/30/85	8:38	66	5	ENG	A 73
DOOR FRAME	8/30/85	8:40	23	5	ENG	A 73
LARGE PATTERN WITH A NAME THAT IS ALMOST 64 CHARACTERS LONG (63)	8/30/85	8:49	1391	203	MET	A 82
SHEET METAL - SURFACE 12	8/30/85	8:55	56	44	ENG	A 82
X12345	8/30/85	8:56	9	2	ENG	A 82
HEX NUT A364	8/30/85	9:22	13	4	ENG	A 73
BOLT A364	8/30/85	9:23	20	5	ENG	A 73
WASHER (ROUND) - A364	8/30/85	9:25	22	5	ENG	A 73

Figure 2-7. Secondary Pattern Library List

If the list of patterns extends beyond a full screen, the system displays:

CONTINUE?

Enter:

Y To display a list of additional patterns.

N To return to 6.2.5 LIST.

6.2.6 Copy

With this choice, you can copy a single pattern or all patterns from the primary library to the secondary library. You can also copy a single pattern or all patterns from the secondary library to the primary library.

When you copy all patterns from one library to another, a pattern name being copied may conflict with an existing pattern name on the library to which you want to copy it. 6.2.1.3 COPY OVERWRITE MODE allows you to specify whether the system should prompt you (name ALREADY EXISTS. OVERWRITE?) for each conflict, or automatically overwrite/not overwrite the existing pattern with the copied pattern.

If the secondary library has not been specified, the following message is displayed before returning to 6.2 PATTERN MANAGEMENT:

NO SECONDARY LIBRARY SPECIFIED

Otherwise, you receive the following menu:

```
COPY
1.PRIMARY TO SECONDARY - SINGLE
2.                        - ALL
3.SECONDARY TO PRIMARY - SINGLE
4.                        - ALL
```

Enter:

- 1 To copy a single pattern from the primary library to the secondary library.

```
COPY                                Enter the name of the pattern you want
ENTER PATTERN NAME                  to copy from the primary library to the
                                     secondary library.
```

After you enter the pattern name, the system searches the primary library. If the name you entered is a subset of more than one pattern, or if the name you entered does not match any pattern, the system displays one of the following messages before returning to the ENTER PATTERN NAME prompt:

NAME IS A SUBSET OF MANY PATTERNS

or

NAME DID NOT MATCH ANY PATTERN

If the name you entered is a subset of only one pattern, the system displays the following message before checking to see whether the name conflicts with a pattern name on the secondary library:

```
ENTERED NAME IS A SUBSET OF PATTERN
name
```

If the name you entered exactly matches a pattern, the system then checks to see whether this name conflicts with a pattern name on the secondary library.

If the name you entered does not conflict with a pattern name on the secondary library, the system copies the pattern from the primary library to the secondary library and displays the following confirmation message before returning to the Copy menu:

```
PATTERN COPIED TO SECONDARY LIBRARY
secondary library name
```

When the name you entered does conflict with a pattern name on the secondary library, you can overwrite the existing pattern on the secondary library with the pattern being copied from the primary library.

```
name
ALREADY EXISTS.  OVERWRITE?
```

Enter:

Y To overwrite the existing pattern on the secondary library with the pattern from the primary library.

N To avoid overwriting the existing pattern. The system then returns to the ENTER PATTERN NAME prompt.

If you enter Y in response to this prompt, the system displays the following confirmation message before returning to the ENTER PATTERN NAME prompt:

```
PATTERN COPIED TO SECONDARY LIBRARY
secondary library name
```

- 2 To copy all patterns on the primary library to the secondary library.

If there is room on the secondary library for all patterns on the primary library, the following message is displayed:

```
THERE ARE nnnn PATTERNS TO COPY
```

The system displays the following progress reports for each 25 patterns copied:

```
nn PATTERNS COPIED
:
ALL PATTERNS COPIED
```

If there is not enough room on the secondary library for all patterns on the primary library, the following message is displayed before you return to 6.2.6 COPY:

```
nnnn PATTERNS ON PRIMARY LIBRARY
ONLY ROOM FOR nnnn ON SECONDARY LIBRARY
NO PATTERNS COPIED
```

If the secondary library already has one or more pattern names conflicting with a pattern name on the primary library, you can overwrite the existing pattern on the secondary library with the pattern being copied from the primary library. (See 6.2.1.3 COPY OVERWRITE MODE to suppress the following prompt and automatically overwrite/not overwrite the pattern.)

```
name
ALREADY EXISTS.  OVERWRITE?
```

Enter:

Y To overwrite the existing pattern on the secondary library with the pattern from the primary library. The system displays the confirmation message PATTERN OVERWRITTEN, and continues to copy patterns from the primary library to the secondary library.

N To avoid overwriting the existing pattern. The system continues to copy patterns from the primary library to the secondary library.

3 To copy a single pattern from the secondary library to the primary library.

COPY ENTER PATTERN NAME	Enter the name of the pattern you want to copy from the secondary library to the primary library.
----------------------------	---

After you enter the pattern name, the secondary library is searched. If the name you entered is a subset of more than one pattern, or if the name you entered does not match any pattern, the system displays one of the following messages before returning to the ENTER PATTERN NAME prompt:

NAME IS A SUBSET OF MANY PATTERNS

or

NAME DID NOT MATCH ANY PATTERN

If the name you entered is a subset of only one pattern, the system displays the following message before checking to see whether the name conflicts with a pattern name on the primary library:

ENTERED NAME IS A SUBSET OF PATTERN
name

If the name you entered exactly matches a pattern, the system checks to see whether this name conflicts with a pattern name on the primary library.

If the name you entered does not conflict with a pattern name on the primary library, the system copies the pattern from the secondary library to the primary library and displays the following confirmation message before returning to the Copy menu:

PATTERN COPIED TO PRIMARY LIBRARY
primary library name

When the pattern name does conflict with a pattern name on the primary library, you can overwrite the existing pattern on the primary library with the pattern being copied from the secondary library.

name
ALREADY EXISTS. OVERWRITE?

Enter:

Y To overwrite the existing pattern on the primary library with the pattern from the secondary library.

N To avoid overwriting the existing pattern. The system then returns to the ENTER PATTERN NAME prompt.

If you enter Y in response to this prompt, the system displays the following confirmation message before returning to the ENTER PATTERN NAME prompt:

PATTERN COPIED TO PRIMARY LIBRARY
primary library name

- 4 To copy all patterns from the secondary library to the primary library.

If there is room on the primary library for all patterns on the secondary library, the following message is displayed:

THERE ARE nnnn PATTERNS TO COPY

The system displays the following progress reports for each 25 patterns copied:

nn PATTERNS COPIED
:
ALL PATTERNS COPIED

If there is not enough room on the primary library for all patterns on the secondary library, the following message is displayed before returning to 6.2.6 COPY:

nnnn PATTERNS ON SECONDARY LIBRARY
ONLY ROOM FOR nnnn ON PRIMARY LIBRARY
NO PATTERNS COPIED

If the secondary library contains one or more pattern names that conflict with a pattern name on the primary library, you can overwrite each existing pattern on the primary library with the pattern from the secondary library. (See 6.2.1.3 COPY OVERWRITE MODE to suppress the following prompt and automatically overwrite/not overwrite the pattern.)

name
ALREADY EXISTS. OVERWRITE?

Enter:

Y To overwrite the existing pattern on the primary library with the pattern from the secondary library. The system displays the confirmation message PATTERN OVERWRITTEN, and it continues to copy patterns from the secondary library to the primary library.

N To avoid overwriting the existing pattern. The system continues to copy patterns from the secondary library to the primary library.

If you chose 1 or 2 from the copy menu and the primary library has no patterns, the system displays the following message before returning to that menu:

PRIMARY LIBRARY EMPTY

If the secondary library is not attached in write mode, the following message is displayed before returning to 6.2.6 COPY:

THIS SECONDARY LIBRARY DOES NOT HAVE
WRITE PERMISSION

If you chose 3 or 4 from the Copy menu and the secondary library has no patterns, the system displays the following message before returning to that menu:

SECONDARY LIBRARY EMPTY

If the primary library is not attached in write mode, the following message is displayed before you return to 6.2.6 COPY:

```
THIS PRIMARY LIBRARY DOES NOT HAVE
WRITE PERMISSION
```

6.2.7 Change Primary Library

With this choice, you can change the primary library. Initially the primary library is PATTERN. The operations of create and delete affect only the primary library. The following prompt is displayed:

```
CHANGE PRIMARY LIBRARY
CURRENT PRIMARY LIBRARY IS name
ENTER LIBRARY NAME
```

Enter the new primary library name. This library must be attached in write mode for library update, create, delete, and copy to function.

If the name of the library you enter has not already been updated to the current release/revision, the system checks to see whether the library is attached in write mode. If it is not, the following message is displayed before returning to the ENTER LIBRARY NAME prompt:

```
PRIMARY LIBRARY CANNOT BE UPDATED
BECAUSE IT DOES NOT HAVE WRITE
PERMISSION.
```

If you are permitted to alter the primary library, the system displays the following prompt:

```
PRIMARY LIBRARY name MUST BE
UPDATED TO THIS RELEASE/REVISION
BEFORE IT CAN BE USED.
DO YOU WANT TO UPDATE THIS LIBRARY?
```

Enter:

Y To update the library and then return to the Pattern Management menu.

N To avoid updating the library. You return to the ENTER LIBRARY NAME prompt.

6.2.8 Change Secondary Library

With this choice, you can change the secondary library. The following prompt is displayed:

CHANGE SECONDARY LIBRARY	Enter the new secondary library name. This
CURRENT SECONDARY LIBRARY IS name	library must be attached in write mode for
ENTER LIBRARY NAME	library updating or copying functions.

You receive the following message before returning to 6.2 PATTERN MANAGEMENT:

SECONDARY LIBRARY = name

If the name of the library you enter has not already been updated to the current release/revision, the system checks to see whether the library is attached in write mode. If it is not, the following message is displayed before returning to the ENTER LIBRARY NAME prompt:

SECONDARY LIBRARY CANNOT BE UPDATED
BECAUSE IT DOES NOT HAVE WRITE
PERMISSION

If you are permitted to alter the secondary library, the system displays the following prompt:

SECONDARY LIBRARY name MUST BE
UPDATED TO THIS RELEASE/REVISION
BEFORE IT CAN BE USED.
DO YOU WANT TO UPDATE THIS LIBRARY?

Enter:

Y To update the library and then return to
the Pattern Management menu.

N To avoid updating the library. You
return to the ENTER LIBRARY NAME
prompt.

Update of Pattern Libraries within ICEM DDN

Within ICEM DDN you can reference a pattern library that has not already been updated to the current release/revision. The system checks to see whether the library is attached in write mode. If it is not, the following prompt is displayed before you return to the Pattern Management menu:

LIBRARY name CANNOT BE UPDATED BECAUSE
IT DOES NOT HAVE WRITE PERMISSION

LIBRARY name MUST BE UPDATED TO THIS
RELEASE/REVISION BEFORE IT CAN BE
USED.

If you are permitted to alter the library, the system displays the following prompt:

LIBRARY name MUST BE UPDATED TO THIS
RELEASE/REVISION BEFORE IT CAN BE
USED.
DO YOU WANT TO UPDATE THIS LIBRARY?

Enter:

Y To update the library.

N To avoid updating the library. You
return to the Pattern Management
menu.

If you entered Y to update the library, the system displays the following progress reports for each 10 updated patterns:

THERE ARE nnnn PATTERNS TO UPDATE
nn PATTERNS UPDATED
:
ALL PATTERNS UPDATED

You then return to the Pattern Management menu.

NOTE:

1. SELECT A TEMP. FILE NAME AS THE NEW LIBRARY NAME.
2. WHEN DONE ("ALL PATTERNS UPDATED") GO BACK TO EDL AND DEFINE A NEW FILE OF GLOBAL PATTERN TYPE WITH A NAME DIFFERENT THAN IN 1.
3. GO TO NOF LEVEL AND COPY FILE IN 1. TO FILE IN 2. THEN PURGE FILE 1.

OR

AFTER "ALL PATTERNS UPDATED" GO BACK TO EDL AND USE THE ACQUIRE FILES FUNCTION TO ACCOMPLISH THE SAME GOAL AS 2. & 3.

6.3 Template Management

With this choice, you can have access to the template management function. A template is a set of geometric entities gathered together and treated as one entity. Templates can be named and saved in the UTF. Templates differ from patterns, groups, and other sets of geometric entities in several ways. Templates consist of masters and instances. A master template is the shape to which all the instances conform. Refer to figure 2-8.

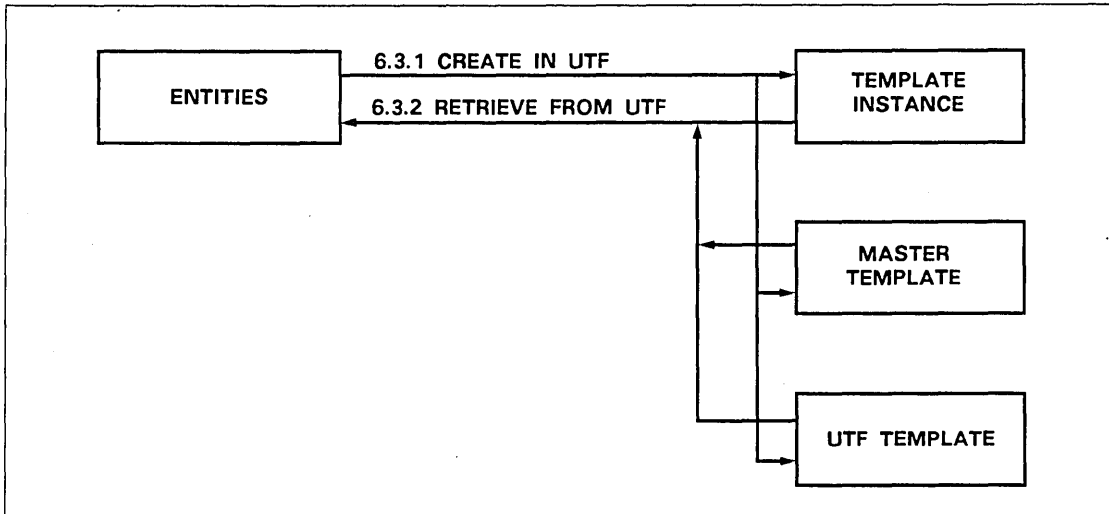

Figure 2-8. Template Management

You can create a template in one view and produce an instance in another view that looks exactly the same as the original template. This is analogous to a physical template which traces the same design, regardless of where it is placed. An example of this is a circle template placed on any side of a box: at each location, it traces a circle.

The following operations can be performed using template management:

- Create a template in the UTF
- Retrieve a template from the UTF
- Unlink a master template
- Redefine a master template
- Delete a master template
- Delete a template from the UTF
- Create an instance of a template
- Unlink an instance of a template
- List on-line templates

After you create a template instance, to further manipulate the instance (translate, rotate, mirror, scale, duplication, adjustment, or other manipulation), use 5.10 NESTING to manipulate without creating a template.

You can delete an instance using either 3.3 FROM ALL (refer to the ICEM Design/Drafting Introduction and System Controls manual) or 5.10 NESTING.

The menu for this section is:

- TEMPLATE MANAGEMENT
- 1.CREATE IN UTF
- 2.RETRIEVE FROM UTF
- 3.UNLINK A MASTER
- 4.REDEFINE A MASTER
- 5.DELETE A MASTER
- 6.DELETE FROM UTF
- 7.CREATE AN INSTANCE
- 8.UNLINK AN INSTANCE
- 9.LIST ON-LINE TEMPLATES

The following sections describe the choices in this menu.

6.3.1 Create in UTF

With this choice, you can create a template that can be stored in the UTF as a UTF template, as a master template in the current part, or as a template instance in the current part.

ENTER TEMPLATE NAME Enter a template name of up to 6 characters.

If the template exists in the UTF, the system displays:

(template name) Enter] to acknowledge the message.
EXISTS -- ACKNOWLEDGE

SHOULD IT BE REPLACED? Enter:

Y To continue creation of the template.

N To return to 6.3 TEMPLATE
MANAGEMENT.

If the template does not exist or if you chose to replace it in the UTF, the system displays:

INDICATE 2-D CURVE Use the graphics cursor to screen select the entities to be included in the template. Valid entity types are points, lines, arcs, and point-sets. Points are not displayed in template instances. Select the outer boundary of the template (by chain) before entities are created in the interior.

If you want to use another method of selection, enter E or CTRL-E to receive the Entity Selection menu. For more information, see the ICEM Design/Drafting Introduction and System Controls manual.

After you create the template, a template instance is displayed in the position of the original entities that defined this template. Those entities have been deleted and the template has replaced them. The system returns to 6.3 TEMPLATE MANAGEMENT.

NOTE

If the template is to be used in nesting (refer to 5.10 NESTING) or other applications that lead to machining of the geometry, you can control the accuracy with which curves are approximated in the display or template instances. The N/C finishing tolerances are used to determine the refinement required (they can be accessed as described in 17.1.8 TOLERANCES of the ICEM Numerical Control manual).

6.3.2 Retrieve from UTF

With this choice, you can retrieve a template from the UTF and the template is then stored as a master template in the current part, and as a template instance in the current part.

ENTER TEMPLATE NAME Enter a template name of up to 6 characters.

If the template exists in the current part, the system displays:

TEMPLATE ALREADY IN PART-- Any action is considered an
ACKNOWLEDGE acknowledgment, and the system returns to
6.3 TEMPLATE MANAGEMENT.

If the template does not exist in the current part and in the UTF, the system displays:

TEMPLATE DOES NOT EXIST-- Any action is considered an
ACKNOWLEDGE acknowledgment, and the system returns to
6.3 TEMPLATE MANAGEMENT.

If the template exists in the UTF, the system displays:

LOCATION MODE Select the location mode of the template.
1.LOWER LEFT
2.UPPER LEFT
3.CENTER
4.UPPER RIGHT
5.LOWER RIGHT

ORIGIN MODE Select the origin mode of the template.
1.SCREEN POSITION
2.KEY IN
3.EXISTING POINT

After you select the origin, the system displays:

1.SCALE = 1.0000 Enter the scale and rotation angle.
2.ANGLE OF ROTATION = 0.0000

The scale being requested is with respect to the original template as filed in the UTF. The rotation angle is the angle through which the template is to be rotated upon retrieval. If an angle other than 0° is entered, the template is rotated about its lower left corner by the number of degrees requested, and then translated to the origin defined by the origin and location mode. The template instance is displayed in the position and orientation that you requested. The system returns to 6.3 TEMPLATE MANAGEMENT.

6.3.3 Unlink a Master

With this choice, you can unlink a master template for modification. The unlinking process consists of the following four steps:

1. Make all the instances of the template dormant so that they are no longer displayed.
2. Delete the basic entity information used in the display of each of the instances.
3. Mark the master template as unlinked so that it cannot be used for the creation of any subsequent instances.
4. Redisplay the entities that were used to create the original master template.

Redisplaying the original entities allows these entities to be modified so that the master template can be relinked eventually and all the instances associated with the master then reflect modifications made to the defining entities.

ENTER TEMPLATE NAME

Enter a template name of up to 6 characters.

If the template name does not exist, the system displays:

TEMPLATE DOES NOT EXIST--
ACKNOWLEDGE

Any action is considered an acknowledgment, and the system returns to 6.3 TEMPLATE MANAGEMENT.

If the template does exist, after a repaint operation, the instances disappear and the entities used to define the original template are displayed in view 1 with their lower left corner at the origin.

6.3.6 Delete from UTF

With this choice, you can delete a template from the UTF.

ENTER TEMPLATE NAME

Enter a template name of up to 6 characters.

After you enter the name, the system attempts to delete a template of the same name from the UTF (no error indications are given if the template does not exist). After communicating with the UTF, the system displays:

template name HAS BEEN DELETED
FROM THE UTF--ACKNOWLEDGE

Any action is considered an acknowledgment, and the system returns to 6.3 TEMPLATE MANAGEMENT.

6.3.7 Create an Instance

With this choice, you can create an instance of a template that exists in the current part. When you select this operation, the system displays:

```
SELECTION MODE
1.TEMPLATE NAME
2.SCREEN SELECT
```

Enter:

- 1 To select a template by name.

```
ENTER TEMPLATE NAME
```

Enter a template name of up to 6 characters.

If the master template does not exist in the current part, the system displays:

```
TEMPLATE DOES NOT EXIST--
ACKNOWLEDGE
```

Any action is considered an acknowledgment, and the system returns to 6.3 TEMPLATE MANAGEMENT.

- 2 To select a template by screen position.

```
INDICATE TEMPLATE
```

Use the graphics cursor to indicate the desired template. If the template does not exist, the system returns to 6.3 TEMPLATE MANAGEMENT.

If the master template exists in the current part, the system displays:

```
LOCATION MODE
1.LOWER LEFT
2.UPPER LEFT
3.CENTER
4.UPPER RIGHT
5.LOWER RIGHT
```

Select the location mode of the template.

```
ORIGIN MODE
1.SCREEN POSITION
2.KEY IN
3.EXISTING POINT
```

Select the origin mode of the template.

After you select the origin, the system displays:

```
1.SCALE = 1.0000
2.ANGLE OF ROTATION = 0.0000
```

Enter the scale and rotation angle.

The scale requested is with respect to the original template as filed in the UTF. The rotation angle is the angle through which the template is to be rotated upon retrieval. If an angle other than 0° is entered, the template is rotated about its lower left corner by the number of degrees requested, and then translated to the origin defined by the origin and location mode. The template instance is displayed in the position and orientation that you requested. The system returns to the Location Mode menu in anticipation of the same template being required later.

6.3.8 Unlink an Instance

With this choice, you can unlink an instance of a template into standard geometric entities such as points, lines, arcs, and point sets. These entities can then be modified or used in further construction. You have the choice of unlinking the instance either to the point set curves used for displaying it, or to copies of the original entities used to create the master template. In the latter case, the entity points, levels, and attributes are also retrieved from the base entities used for the master template.

INDICATE TEMPLATE

Select the instance to be unlinked. Entering [or] returns the system to 6.3 TEMPLATE MANAGEMENT.

After you select an active instance, the system displays:

- 1.POINT-SET CURVES
- 2.BASE ENTITIES & ATTRIBUTES

Select the mode required.

Enter:

- 1 To indicate that the template instance is broken up into the point sets used to display the active instance. If the master template contains points that are not displayed in instances, these points are not retrieved by unlinking in this manner. Attributes of the base entities do not apply to the point sets generated.
- 2 To indicate that copies of the base entities used to define the master template are made and then translated, scaled, and rotated to the position of the instance being unlinked. These copies retain the fonts, levels, and attributes of the base entities of the master template.

The new entities are displayed and the system returns to 6.3 TEMPLATE MANAGEMENT.

6.3.9 List On-line Templates

With this choice, you can list all the templates defined in the current part. The list contains the template name, the type of template (master or instance), its sequence number, its pointer, the minimum x and minimum y for all instances, the status of each (either active, unlinked, or dormant), and the view of definition. Figure 2-9 illustrates the list on-line templates function.

Name	Type	Sequence		X Min	Y Min	Status	View of Definition
		Number	PTR				
RING	INSTANCE	61	4429	210.53	54.42	DORMANT	1
RING	INSTANCE	60	4413	210.53	173.63	DORMANT	1
RING	INSTANCE	59	4407	122.89	66.13	DORMANT	1
RING	INSTANCE	58	4401	104.80	158.37	DORMANT	1
RING	MASTER	57	4395			UNLINKED	1
PIN	INSTANCE	52	4371	124.31	164.05	ACTIVE	1
PIN	INSTANCE	51	4365	106.57	91.32	ACTIVE	1
PIN	MASTER	50	4301			ACTIVE	1

Figure 2-9. Listing of On-line Templates

6.4 Reserved for Future Use

6.5 User Tech File Management

With this choice, you can perform various file management operations in the UTF (figure 2-10). These operations are the following:

- List the names and types of items currently in the UTF.
- Delete an item from the UTF.
- Copy items to a local, external file GUTF.
- Retrieve items stored on a local, external file GUTF.
- Initialize the UTF.

The menu for this section is:

```

USER TECH FILE MANAGEMENT
1.LIST
2.DELETE
3.SAVE ON GLOBAL UTF
4.RESTORE FROM GLOBAL UTF
5.INITIALIZE
  
```

The following sections describe the choices in this menu.

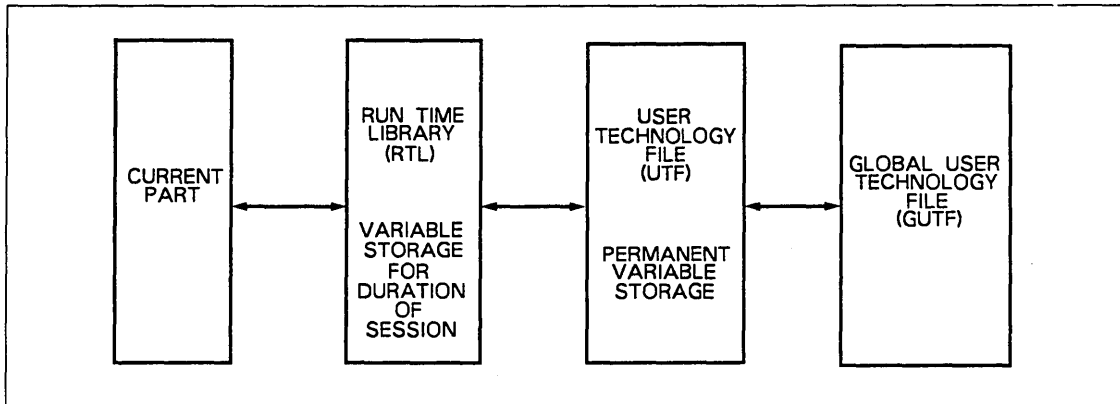

Figure 2-10. UTF Management

6.5.1 List

With this choice, you can display a list of item names currently in the UTF. Figure 2-11 shows an example of a UTF list.

NAME	TYPE
Q	10 MACRO SEQUENCE
STFF	10 MACRO SEQUENCE
MAC1	10 MACRO SEQUENCE
CHAR	2 CHARACTER SET
XORG	3 VARIABLE LIST
YORG	3 VARIABLE LIST
ONLE	6 LEVEL TABLE
DKAL	6 LEVEL TABLE
DKAC	2 CHARACTER SET
BB	10 MACRO SEQUENCE
HAU2	10 MACRO SEQUENCE
AA	10 MACRO SEQUENCE
CH4	4 GRAPL SOURCE
CH4	7 GRAPL OBJECT
HAU2	4 GRAPL SOURCE
HAU2	7 GRAPL OBJECT

Figure 2-11. UTF List

6.5.2 Delete

With this choice, you can delete a single item from the UTF.

ENTER ITEM NAME

Enter the name of the item to be deleted.

TYPE =

Enter the item type. The item type code is described in 6.5.3 SAVE ON GLOBAL UTF.

If the item does not exist in the UTF, the system displays:

ITEM NOT FOUND. CONTINUE?

Enter:

Y To return to the ENTER ITEM NAME prompt.

N To return to 6.5 USER TECH FILE MANAGEMENT.

6.5.3 Save on Global UTF

With this choice, you can copy items from the internal UTF to the local file GUTF.

SAVE ON GLOBAL UTF
 1.SAVE ALL
 2.SAVE BY NAME

Enter:

- 1 To copy all the files from the internal UTF to the external GUTF.
- 2 To enter the names of individual files to be copied to the GUTF.

ENTER ITEM NAME

Enter the name of the item to be saved.

INDICATE TYPE

Enter the number indicating the entity type to be saved.

1.TOOL CYCLE
 2.CHARACTER SET
 3.VARIABLE LIST
 4.GRAPL PROGRAM
 5.GRAPH TEMPLATE
 6.LEVEL TABLE
 7.GRAPL OBJECT
 8.
 9.USER TEXT
 10.MACRO SEQUENCE
 11.PEN NUMBER TABLE
 12.TEMPLATE
 13.PP LIBRARY WORDS
 14.PP LIBRARY CODES

If the item to be saved does not exist in the UTF, the system displays:

ITEM NOT FOUND. CONTINUE?

Enter:

- Y To return to the ENTER ITEM NAME prompt.
- N To return to 6.5 USER TECH FILE MANAGEMENT.

6.5.4 Restore from Global UTF

With this choice, you can retrieve UTF items from the local file GUTF and copy them to the internal UTF.

```
USER TECH FILE RESTORE FROM GUTF RESTORE MODE
1.RESTORE ALL
2.RESTORE BY NAME
3.LIST
```

Enter:

- 1 To copy all the items from the GUTF to the UTF.

The system copies all items from the external GUTF to the internal UTF. If the item to be restored exists in the internal UTF, the system displays:

```
xxxxxx/nn EXISTS, REPLACE
```

xxxxxx is the name of the UTF item and nn is the type code for the item (refer to 6.5.3 SAVE ON GLOBAL UTF for a description of item types and codes).

Enter:

Y To delete the version of the item in the UTF and copy the item from the GUTF to the UTF.

N To avoid copying this item to the UTF.

- 2 To enter the names of individual items to be copied from the GUTF to the UTF. Refer to 6.5.3 SAVE ON GLOBAL UTF.
- 3 To list the names of the items on the GUTF.

NOTE

TAPE1 files created prior to the version 1.4 release of CD/2000 by 6.5.3 SAVE ON GLOBAL UTF must be restored by a version previous to 1.4.

6.5.5 Initialize

With this choice, you can delete all existing items in the UTF and initialize the file for the creation of a new UTF.

NOTE

This operation permanently deletes the entire contents of the UTF.

The system displays:

INITIALIZE?

Enter:

- Y To initialize the UTF, deleting the current contents.
- N To leave the current contents of the UTF intact.

6.6 Data Base Information

With this choice, you can obtain information about the contents of the data base. This operation displays information on:

- Entities in the current part.
- The current part space.
- The part file space.
- The pattern file space.
- The UTF space.
- The view transformation matrix.

The menu for this section is:

```

DATA BASE INFORMATION
1.ENTITY INFORMATION
2.CURRENT PART SPACE
3.PART FILE SPACE
4.PATTERN FILE SPACE
5.USER TECH SPACE
6.VIEW TRANSFORMATION MATRIX
  
```

The following sections describe the choices in this menu.

6.6.1 Entity Information

With this choice, you can display information about the entities in the current part, including the number and type of entities found within a specific level or view. The system prompts for the kind of entity information desired.

ENTITY INFORMATION

- 1.COUNT PER VIEW
- 2.COUNT PER LEVEL
- 3.TYPES IN VIEW AND LEVEL RANGE
- 4.DATA IN VIEW AND LEVEL RANGE

Enter:

- 1 To display a table of the number of entities defined in each view.
- 2 To display a table of the number of entities defined on each level.
- 3 To display a table of the number of entity types in a specified view and level range.
- 4 To display a table of the entity data in a specified view and level range.

If you select 1.COUNT PER VIEW, the system displays a table of the number of entities defined in each view. Figure 2-12 shows an example of this table.

COUNT OF ENTITIES DEFINED IN EACH VIEW	
VIEW	ENTITIES
1	18
2	3
5	1
6	2
9	1
10	1
11	1
12	1

Figure 2-12. Count of Entities Defined in Each View

If there is more table information to display, the system displays:

CONTINUE?

Enter:

- Y To continue displaying the table.
- N To return to 6.6.1 ENTITY INFORMATION.

If you select 2.COUNT PER LEVEL, the system displays a table of the number of entities defined on each level. Figure 2-13 shows an example of this table.

COUNT OF ENTITIES DEFINED ON EACH LEVEL	
VIEW	ENTITIES
0	2
1	11
2	2
3	1
5	1
100	6
500	3
1023	2

Figure 2-13. Count of Entities Defined on Each Level

If there is more table information to display, the system displays:

CONTINUE?

Enter:

Y To continue displaying the table.

N To return to 6.6.1 ENTITY INFORMATION.

If you select 3.TYPES IN VIEW AND LEVEL RANGE, the system displays:

1.FROM VIEW = 1
2.TO VIEW = nnn

Enter the desired view range values.

Enter:

] To accept the default view range values (1 and the last view defined).

[To return to 6.6.1 ENTITY INFORMATION.

If you enter view range values outside the range of views currently defined, the system displays:

ONLY VIEWS 1 to nnn
HAVE BEEN DEFINED

The system returns to the view range prompt.

6.6.1 Entity Information

If you enter a FROM VIEW value that is greater than the TO VIEW value, the system displays:

```
'FROM VIEW' CANNOT BE  
GREATER THAN 'TO VIEW'
```

The system returns to the view range prompt.

After you enter the view range, the system displays:

```
1.FROM LEVEL = 0  
2.TO LEVEL   = 1023
```

Enter the desired level range values.

Enter:

] To accept the default level range values
(0 to 1023).

[To return to the view range prompt.

If you enter a level number outside the range of 0 to 1023, the system displays:

```
LEVEL NUMBER MUST BE  
WITHIN RANGE 0 TO 1023
```

The system returns to the level range prompt.

If you enter a FROM LEVEL value that is greater than the TO LEVEL value, the system displays:

```
'FROM LEVEL' CANNOT BE  
GREATER THAN 'TO LEVEL'
```

The system returns to the level range prompt.

After you enter the view and level range, the system displays a table of the number of entity types in the specified view and level range. Figure 2-14 shows an example of this table.

COUNT OF ENTITY TYPES IN VIEWS 1 TO 12 ON LEVELS 0 TO 1023	
ENTITY TYPE	COUNT
1	11
2	5
3	6
4	1
5	1
16	2
34	1
37	1

Figure 2-14. Count of Entity Types in View and Level Range

If there is more table information to display, the system displays:

CONTINUE?

Enter:

Y To continue displaying the table.

N To return to 6.6.1 ENTITY
INFORMATION.

If you select 4.DATA IN VIEW AND LEVEL RANGE, the system displays:

1.FROM VIEW = 1
2.TO VIEW = nnn

Enter the desired view range.

Enter:

] To accept the default view range values
(1 and the last view defined).

[To return to 6.6.1 ENTITY
INFORMATION.

If you enter view range values outside the range of views currently defined, the system displays:

ONLY VIEWS 1 TO nnn
HAVE BEEN DEFINED

The system returns to the view range prompt.

If you enter a FROM VIEW value that is greater than the TO VIEW value, the system displays:

'FROM VIEW' CANNOT BE
GREATER THAN 'TO VIEW'

The system returns to the view range prompt.

After you enter the view range, the system displays:

1.FROM LEVEL = 0
2.TO LEVEL = 1023

Enter the desired level range values.

Enter:

] To accept the default level range values
(0 to 1023).

[To return to the view range prompt.

If you enter a level number outside the range of 0 to 1023, the system displays:

LEVEL NUMBER MUST BE
WITHIN RANGE 0 TO 1023

The system returns to the level range prompt.

If you enter a FROM LEVEL value that is greater than the TO LEVEL value, the system displays:

```
'FROM LEVEL' CANNOT BE
GREATER THAN 'TO LEVEL'
```

The system returns to the level range prompt.

After you enter the view and level range, the system displays a table containing the following entity information in a specified view and level range: the number of different entity types, defined entities, blanked entities, entities that are not deletable, dormant entities, grouped entities, entities on the screen, and entities with attributes. Figure 2-15 shows an example of this table.

1.ENT TYPES	= 8
2.DEFINED	= 29
3.BLANKED	= 0
4.NOT DELETE	= 0
5.DORMANT	= 2
6.GROUPED	= 0
7.ON SCREEN	= 29
8.ATTRIBUTES	= 0

Figure 2-15. Entity Data in View and Level Range

Enter [or] to return to 6.6.1 ENTITY INFORMATION.

6.6.2 Current Part Space

With this choice, you can display the number of entities, integer words, real words, and views for the current part space (figure 2-16). There are no system prompts or actions for this operation.

1.NO. ENTS	= 335
2.NO. MORE	= 10545
3.INTS USED	= 2177
4.REALS USED	= 7304
5.VIEWS USED	= 4

Figure 2-16. Current Part Space Display

6.6.3 Part File Space

With this choice, you can display the number of part files and the number of disk sectors used for parts files (figure 2-17). There are no system prompts or actions for this operation.

1.NO. PARTS	= 8
2.SECS USED	= 658

Figure 2-17. Part File Space Display

6.6.4 Pattern File Space

With this choice, you can display the number of patterns filed and the number of disk sectors used for the primary pattern library (figure 2-18). There are no system prompts or actions for this operation.

1.NO. PATTERNS = 15 2.SECS USED = 99

Figure 2-18. Pattern File Space Display

6.6.5 User Tech Space

With this choice, you can display the number of files in the UTF and the number of disk sectors used for UTF (figure 2-19). There are no system prompts or actions for this operation.

1.UTF FILES = 16 2.SECS USED = 16

Figure 2-19. UTF Space Display

6.6.6 View Transformation Matrix

With this choice, you can display the contents of the view transformation matrix for a specified view defined in the current part.

VIEW NUMBER = nnn

Enter a defined view number.

Enter:

] To accept the default value (current view).

[To return to 6.6.1 ENTITY INFORMATION.

If the view number does not exist, the system displays:

```
ONLY VIEWS 1 TO nnn
HAVE BEEN DEFINED
```

The system returns to the view number prompt.

After you enter the view number, the system displays the view transformation matrix. Figure 2-20 is an example of this display.

```
1.VALUE 1 = 1.0000
2.VALUE 2 = 0.0000
3.VALUE 3 = 0.0000
4.VALUE 4 = 0.0000
5.VALUE 5 = 1.0000
6.VALUE 6 = 0.0000
7.VALUE 7 = 0.0000
8.VALUE 8 = 0.0000
9.VALUE 9 = 1.0000
```

Figure 2-20. View Transformation Matrix Display

Enter [to return to the view number prompt.

If you enter] after the matrix is displayed, the system displays the view translation vectors. Figure 2-21 is an example of this display.

```
1.TRNS VEC X = 0.0000
2.TRNS VEC Y = 0.0000
3.TRNS VEC Z = 0.0000
```

Figure 2-21. View Translation Vector Display

Enter [to return to the view number prompt or enter] to return to 6.6.1 ENTITY INFORMATION.

6.7 Dump Current Part

With this choice, you can inspect common values and entities in the current part.

The menu for this section is:

```
DUMP CURRENT PART
1.INSPECT COMMON VALUES
```

The following section describes the choice in this menu.

6.7.1 Inspect Common Values

With this choice, you can display and modify the contents of the arrays used by the system and stored in COMMON. Refer to the ICEMDDN-170 System Programmer's Reference Manual.

ALLOW COMMON TO BE MODIFIED?

Enter:

Y To modify the contents of the array words displayed.

N To avoid modification of the array words.

DUMP

1. INTEGER

2. REAL

Select the type of array whose contents are to be displayed.

Enter:

1 To display the contents of an integer array.

2 To display the contents of a real array.

If you select 1.INTEGER, the system displays:

INTEGER ARRAYS

1. TAB1

2. TAB2

3. TAB5

4. DBUF

5. EC

6. GCA

7. IMODE

8. GC

9. GOSW

10. GI

11. MADD

12. MMP

13. PAGE

14. PRTNA

15. IVIEW

16. TEMI

17. STAB1

18. MVIEW

19. VSW

20. ISMOD

Select the integer array whose contents are to be displayed.

1. xxxx FROM =

2. xxxx TO =

xxxx is the name of the requested array. Enter the starting and ending word numbers. The system displays the contents of all words at and between these two addresses (figure 2-22). If you enter] without specifying the starting and ending numbers, the system displays the first 10 words, and subsequently, the next 10 words.

```

INTEGER ARRAYS
 1. TAB1
 2. TAB2
 3. TAB5
 4. DBUF
 5. EC
 6. GCA
 7. IMODE
 8. GC
 9. GOSW
10. GI
11. MADD
12. MMP
13. PAGE
14. PRTNA
15. IVIEW
16. TEMI
17. STAB1
18. MVIEW
19. VSW
20. ISMOD 1
 1. TAB1 FROM = 1      ]
 2. TAB1 TO   = 1024
 1. TAB1(1)   = 117    ]
 2. TAB1(2)   = 5
 3. TAB1(3)   = 4
 4. TAB1(4)   = 0
 5. TAB1(5)   = 274877907216
 6. TAB1(6)   = 4406636445696
 7. TAB1(7)   = 0
 8. TAB1(8)   = 70506187333632
 9. TAB1(9)   = 274877972752
 0. TAB1(10)  = 4406636445696
 1. TAB1(11)  = 0
 2. TAB1(12)  = 140874935705600
 3. TAB1(13)  = 131329
 4. TAB1(14)  = 4406636445696
 5. TAB1(15)  = 68732024851
 6. TAB1(16)  = 211243684077568
 7. TAB1(17)  = 196865
 8. TAB1(18)  = 4406636445696
 9. TAB1(19)  = 68731803667
 0. TAB1(20)  = 211449842520064

```

Figure 2-22. Common Values (Integer Array)

6.7.1 Inspect Common Values

If you select 2.REAL, the system displays:

REAL ARRAYS

- 1. TAB3
- 2. TAB4
- 3. DEPTH
- 4. ECURV
- 5. ESURF
- 6. GR
- 7. MATH
- 8. RMODE
- 9. ZOOM
- 10. TEMR
- 11. STAB2
- 12. RVIEW
- 13. RSMOD

- 1. xxxx FROM =
- 2. xxxx TO =

Select the real array whose contents are to be displayed.

xxxx is the name of the requested array. Enter the starting and ending word numbers. The system displays the contents of all words at and between these two addresses. If you enter] without specifying the starting and ending numbers, the system displays the first 10 words, and subsequently, the next 10 words (figure 2-23).

```
REAL ARRAYS
1.TAB3
2.TAB4
3.DEPTH
4.ECURV
5.ESURF
6.GR
7.MATH
8.RMODE
9.ZOOM
10.TEMR
11.STAB2
12.RVIEW
13.RSMOD 1
1.TAB3 FROM = 1      ]
2.TAB3 TO   = 1024
1.TAB3(1)   = 189.0000 ]
2.TAB3(2)   = 13.6339
3.TAB3(3)   = 10.4625
4.TAB3(4)   = 0.0000
5.TAB3(5)   = 13.6339
6.TAB3(6)   = 10.2768
7.TAB3(7)   = 0.0000
8.TAB3(8)   = 13.6339
9.TAB3(9)   = 10.1482
0.TAB3(10)  = 0.0000
1.TAB3(11)  = 13.6339
2.TAB3(12)  = 10.0054
3.TAB3(13)  = 0.0000
4.TAB3(14)  = 13.6339
5.TAB3(15)  = 9.8768
6.TAB3(16)  = 0.0000
7.TAB3(17)  = 13.6339
8.TAB3(18)  = 9.7339
9.TAB3(19)  = 0.0000
0.TAB3(20)  = 13.6339
```

Figure 2-23. Common Values (Real Array)

Menu 7: Input/Output/Regeneration

3

Using Menu 7	3-1
7.1 Reserved for Future Use	3-2
7.2 Plot	3-2
Paper Size Specification	3-3
Position of Plot	3-4
Single View Plotting	3-5
Multiple View Plotting	3-6
Plotter Optimization	3-7
7.3 Display Last Seq. No. Used	3-8
7.4 Display Entity Seq. No.	3-8
7.5 Identify Entity #N	3-8
7.6 Identify Entities N1 to N2	3-8
7.7 Regen Entity #N	3-9
7.8 Regen from N1 to N2	3-9
7.9 Regen All	3-9
7.10 Bulk Data Input	3-10
Start Input	3-16
7.11 Reserved for Future Use	3-18
7.12 Mesh Generator Interface	3-19
Curves	3-19
Surfaces	3-20
7.13 Tablet Management	3-21
7.13.1 Tablet Modals	3-22
7.13.1.1 Square Overwrite Mode	3-23
7.13.1.2 Page Display Status	3-23
7.13.1.3 Page Display Area	3-24
7.13.1.4 String Display Format	3-24
7.13.1.5 Tablet File Status	3-25
7.13.2 Create Page	3-26
7.13.3 Modify Page	3-27
Edit/Save Page	3-28
Define Square	3-28
Assign MSTRING Name to Square	3-30
List Square	3-34
Move Square	3-35
Copy Square	3-36
Delete Square	3-37
Display Page	3-38
Save Page and Continue	3-38
Save Page and Exit	3-38
7.13.4 Rename Page	3-39
7.13.5 Delete Page	3-41

7.13.6 Display Page	3-42
7.13.7 List Pages in Edit File	3-43
7.13.8 Change Edit File	3-44
7.13.9 Pack Edit File	3-44
7.13.10 Copy Pages from Another File	3-45
Tablet String Programming Format	3-46
Commands	3-46
Variable Menu/Text Entry	3-48
Repeated Menu Sequences	3-49
Tablet String Variables	3-49
Embedded Control Characters	3-50
Lowercase Text Entry	3-50
Embedded Text Entry	3-51
Summary of Control Characters	3-51

Using Menu 7

Input/Output/Regeneration provides regeneration and display of entities, input and output of bulk data, the use of plot functions, mesh generator interface, and tablet management.

The menu for this chapter is:

- INPUT/OUTPUT/REGENERATION
- 1.
- 2.PLOT
- 3.DISPLAY LAST SEQ. NO. USED
- 4.DISPLAY ENTITY SEQ. NO.
- 5.IDENTIFY ENTITY #N
- 6.IDENTIFY ENTITIES N1 TO N2
- 7.REGEN ENTITY #N
- 8.REGEN FROM N1 TO N2
- 9.REGEN ALL
- 10.BULK DATA INPUT
- 11.
- 12.MESH GENERATOR INTERFACE
- 13.TABLET MANAGEMENT

The Input/Output/Regeneration menu offers these functions:

Menu Title	Function Description
7.1 Reserved For Future Use	
7.2 PLOT	Produces a file that can be sent to a plotter.
7.3 DISPLAY LAST SEQ. NO. USED	Displays the sequence number of the last entity created.
7.4 DISPLAY ENTITY SEQ. NO.	Displays the sequence number of an entity on the display screen above the entity.
7.5 IDENTIFY ENTITY #N	Identifies an entity by sequence number.
7.6 IDENTIFY ENTITIES N1 TO N2	Identifies entities within a range of sequence numbers.
7.7 REGEN ENTITY #N	Regenerates an entity to its original relationship to other entities at the time of its construction.
7.8 REGEN FROM N1 TO N2	Regenerates entities within a range of sequence numbers.
7.9 REGEN ALL	Regenerates all the entities in a part.
7.10 BULK DATA INPUT	Reads point, line, arc, point set, or note data from an external file into the system.

Menu Title	Function Description
7.11 Reserved For Future Use	
7.12 MESH GENERATOR INTERFACE	Creates a line data file in a format readable by a mesh generator.
7.13 TABLET MANAGEMENT	Permits you to define an area or page of the tablet for a specialized function.

The remainder of this chapter describes the choices in menu 7.

7.1 Reserved for Future Use

7.2 Plot

With this choice, you can produce a plot file that you can send to a plotter to produce a hardcopy drawing. The plot file is a local system file named TAPE9. After ending an ICEM DDN session, you can either make the TAPE9 plot file permanent or store it on tape. The ICEM DDN plot file can be attached and used as direct input to the UNIPLOT subroutine PLOT (refer to appendix D) when you are at a terminal with a plotter.

You must tell the system how to record the data onto the ICEM DDN plot file. You can start a new series of plots, append to a previous single plot, or add a new plot to an existing series of plots.

PLOT FILE ACCESS METHOD
1. INITIALIZE PLOT FILE
2. APPEND TO PREVIOUS PLOT
3. CREATE NEW PLOT

Enter:

- 1 To start a new series of plots by initializing the plot file. Any existing information currently on the ICEM DDN plot file is overwritten.
- 2 To append the new plot information to the end of the previous plot. This allows you to combine multiple plots to produce one drawing.
- 3 To create a new plot in a series of plots. You may create multiple plots on the same ICEM DDN plot file without exiting from ICEM DDN. Each plot is a separate drawing.

Paper Size Specification

You must tell the system the paper size for which you want to format the plot. Depending on the characteristics of your part, one of three menus is displayed.

For ANSI (1973 or 1982) drafting standard parts in English units, the following menu is displayed:

U.S. PAPER SIZES (ENGLISH UNITS)	Enter 1-5 to select one of the standard papers of predefined size.
1.A SIZE (11.0 X 8.5)	
2.B SIZE (17.0 X 11.0)	
3.C SIZE (22.0 X 17.0)	Enter 6 to specify a nonstandard U.S. paper size in English units.
4.D SIZE (34.0 X 22.0)	
5.E SIZE (44.0 X 34.0)	
6. ENTER SIZE IN INCHES	

For ANSI (1973 or 1982) drafting standard parts in metric units, the following menu is displayed:

U.S. PAPER SIZES (METRIC UNITS)	Enter 1-5 to select one of the standard papers of predefined size.
1.A SIZE (280 X 216)	
2.B SIZE (432 X 280)	
3.C SIZE (559 X 432)	Enter 6 to specify a nonstandard U.S. paper size in metric units.
4.D SIZE (864 X 559)	
5.E SIZE (1118 X 864)	
6. ENTER SIZE IN MILLIMETERS	

For non-ANSI drafting standard parts in metric units, the following menu is displayed:

INTERNATIONAL PAPER SIZES (METRIC UNITS)	Enter 1-5 to select one of the standard papers of predefined size.
1.A0 SIZE (1189 X 841)	
2.A1 SIZE (841 X 594)	
3.A2 SIZE (594 X 420)	Enter 6 to specify a nonstandard international paper size in metric units.
4.A3 SIZE (420 X 297)	
5.A4 SIZE (297 X 210)	
6. ENTER SIZE IN MILLIMETERS	

If you are specifying a nonstandard English unit paper size, the following prompt requests this information:

NONSTANDARD PAPER SIZE (ENGLISH UNITS)	Enter the width (X) and length (Y) of the paper being used. The default values correspond with the previous paper size used.
1. MAXIMUM WIDTH (X) = n.nnnn	
2. MAXIMUM LENGTH (Y) = n.nnnn	

If you are specifying a nonstandard metric unit paper size, the following prompt requests this information:

NONSTANDARD PAPER SIZE (METRIC UNITS)	Enter the width (X) and length (Y) of the paper being used. The default values correspond with the previous paper size used.
1. MAXIMUM WIDTH (X) = n.nnnn	
2. MAXIMUM LENGTH (Y) = n.nnnn	

Position of Plot

If you are creating a new plot on the ICEM DDN plot file, the system prompts you for your choice of format for the sheet of paper. If you are appending to the previous plot, the same paper characteristics are used. Continue with the next section, Single View Plotting or Multiple View Plotting, depending on the screen display.

PLOTTER ORIGIN

1. LOWER LEFT CORNER
2. LOWER RIGHT CORNER

Enter:

- 1 To select the lower left corner of the plotter as the plot origin.
- 2 To select the lower right corner of the plotter as the plot origin.

OFFSET DISTANCES

1. X-DIRECTION OFFSET = n.nnnn
2. Y-DIRECTION OFFSET = n.nnnn

Enter the distances (positive values) to offset the plotting paper. If you did not change the paper size from the previous plotting session (for the same part), the offset distances are retained. Otherwise, they are reset to 0.0. The x-direction offset affects the left and right sides of the page; the y-direction offset affects the top and bottom. (Refer to figure 3-1.)

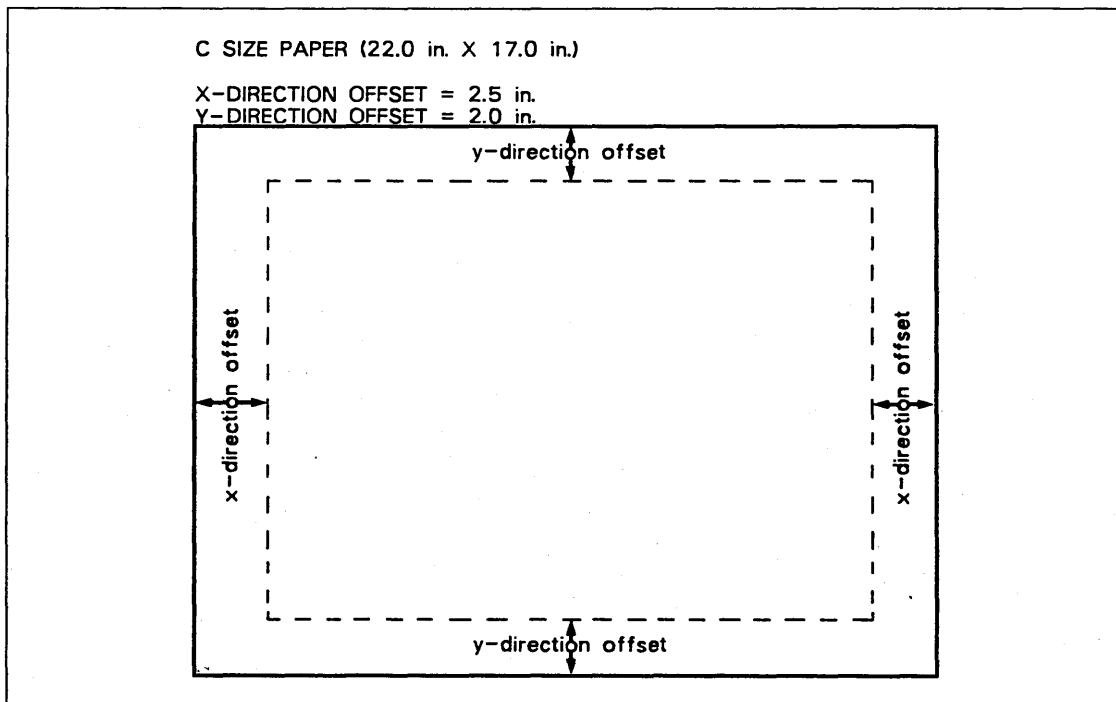

Figure 3-1. Plot Paper Offset Distances

Single View Plotting

If a single view is currently being displayed, you must indicate what portion of the current part you want to plot:

SINGLE VIEW PLOT EXTENT

- 1.PLOT ALL DISPLAYED
- 2.PLOT ENTIRE PART

Enter:

- 1 To plot only the portion of the part displayed on the screen.
- 2 To plot the entire part, both on and off the screen.

In either case, the system then needs to know how to position the part within the plot. The plot origin is the location on the portion of the part being plotted that corresponds with the plotter origin.

If you selected 1.LOWER LEFT CORNER from the Plotter Origin menu, the following menu is displayed to select the desired origin method:

PLOT ORIGIN

- 1.SCREEN POSITION
2. ENTER TRANSFORM COORDINATES
- 3.EXISTING POINT
- 4.LOWER LEFT CORNER

If you selected 2.LOWER RIGHT CORNER from the Plotter Origin menu, the following menu is displayed to select the desired origin method:

PLOT ORIGIN

- 1.SCREEN POSITION
2. ENTER TRANSFORM COORDINATES
- 3.EXISTING POINT
- 4.LOWER RIGHT CORNER

Enter:

- 1 To indicate a location on the screen as the origin. The system displays:

INDICATE PLOT ORIGIN

Select the origin, using the graphics cursor.

- 2 To specify the part origin as transform coordinate values. The system displays:

PLOT ORIGIN COORDINATES

- 1.XT = n.nnnn
- 2.YT = n.nnnn

Enter the location of the origin in x-transform or y-transform coordinates.

- 3 To use an existing point as the origin. The system displays:

INDICATE PLOT ORIGIN POINT

Select an existing point as the origin, using the graphics cursor.

- 4 To use the lower left or right corner of the portion of the part being plotted. The corner used depends on the Plotter Origin you selected earlier.

Once the origin has been established, you must decide on a scale factor for the plot. The system displays the following prompt:

SCALE FOR PLOTTING = n.nnnn Enter the scale factor for the plot. The default scale completely fills the paper with the portion of the part being plotted.

If you do not accept the default scale and enter another value, the system calculates the size of the plot drawing based on the new scale you enter.

The following message is displayed to verify the size of your plot:

NEW PLOT DISPLAY SIZE IS Enter:
(n.nnnn,n.nnnn) CONTINUE?

Y To perform the plot sequence using the new scale.

N To reject the new scale and return to the SCALE FOR PLOTTING prompt. The system uses the previous default scale within the prompt.

Based on the information you provided, the system now generates the plotter output file.

NOTE

Since the system must cycle through all the entities to be plotted, there is a momentary delay (similar to a repaint) while the plotter output file is being generated.

When the current plot data is stored on the ICEM DDN plot file, the system rewinds the local plot file and returns you to menu 7 INPUT/OUTPUT/REGENERATION.

Multiple View Plotting

The system uses the lower left or lower right corner as the plot origin of the part, depending on the plotter origin (lower left or lower right corner).

If multiple views are currently being displayed, you receive the following prompt:

MULTIPLE VIEW PLOT EXTENT Tell the system what portion of the current display you want to plot. Based on the plotter origin you selected earlier, the system assigns the plot origin to the lower left or lower right of the plot extent.

1.PLOT A SPECIFIED VIEW

2.PLOT ALL VIEWS

Enter:

1 To select one view to be plotted.

VIEW NUMBER =

Enter the view number. Refer to 8.1.2 VIEW SELECTION MODE for a description of the view number selection procedure.

2 To plot all the displayed views.

In either case, the system requests the scale factor to be used on the plot:

SCALE FOR PLOTTING = n.nnnn

Enter the scale factor for the plot. The default scale completely fills the paper with the portion of the part being plotted.

If you do not accept the default scale and you enter another value, the system calculates the size of the plot drawing based on the new scale. You receive the following message to verify the size of the plot:

NEW PLOT DISPLAY SIZE IS
(n.nnnn,n.nnnn) CONTINUE?

Enter:

Y To perform the plot sequence using the new scale.

N To reject the new scale and return to the SCALE FOR PLOTTING prompt. The system uses the previous default scale within the prompt.

Based on the information you provided, the system now generates the plotter output file.

NOTE

Since the system must cycle through all the entities to be plotted, there is a momentary delay (similar to a repaint) while the plotter output file is being generated.

When the current plot data is stored on the ICEM DDN plot file, the system rewinds the local ICEM DDN plot file and returns you to menu 7 INPUT/OUTPUT/REGENERATION.

Plotter Optimization

The plot file TAPE9 (as produced by the system through the plot submenu) contains vector data consisting of x, y, and pen number values. The organization of the plot vectors depends on the order of entity creation in the part drawing. This order may not be suitable for many of the different types of plotter hardware available.

You can use the utility program OPTIM to improve the results obtained when using TAPE9 plots with specific types of plotting hardware. OPTIM groups the vectors by pen number and sorts them into ascending order of x and y. The benefit of this utility program depends on the plotter being used: greatest improvement is obtained by optimizing large multicolor plots for use by a pen plotter. Optimization is useless when the plot is to be rasterized for an electrostatic plotter.

The OPTIM program is part of the system utility tape. The program reads the plot data from TAPE9 and writes the optimized plot back to TAPE9. Diagnostic messages and errors encountered by OPTIM are written to local file TAPE11. A TAPE11 file produced by a satisfactory OPTIM run contains the message:

PLOT FILE PROCESSING SUCCESSFUL

NOTE

Because OPTIM both reads and writes a single plot record to TAPE9, use a procedure file to copy each plot record from the permanent plot file to a local, temporary TAPE9. After OPTIM is run, TAPE9 can be plotted directly or copied to another permanent file before another plot record is processed. Copying each plot record ensures that the plot data is not damaged if OPTIM encounters an error.

7.3 Display Last Seq. No. Used

With this choice, you can display the sequence number of the last entity created. Numbers are assigned in sequential order (one to each entity) as each entity is created. (All dormant entities also have sequence numbers, although you may not know that a dormant entity has been created.)

LAST SEQUENCE NUMBER = nn The last sequence number assigned is displayed. Enter] to return to 7 INPUT/OUTPUT/REGENERATION.

7.4 Display Entity Seq. No.

With this choice, you can display the sequence number of a selected entity above the entity.

INDICATE ENTITY Use the graphics cursor to select an entity.

The sequence number of the entity is displayed above the entity. You return to the INDICATE ENTITY prompt if 1.2 CONSTRUCTION MODAL is on or to 7 INPUT/OUTPUT/REGENERATION if 1.2 CONSTRUCTION MODAL is off. (Refer to the ICEM Design/Drafting Introduction and System Controls manual.)

7.5 Identify Entity #N

With this choice, you can identify an entity whose sequence number is entered.

FIRST SEQUENCE NO. = nn Enter the sequence number of the entity to be identified.

The sequence number of the entity is displayed above the entity.

7.6 Identify Entities N1 to N2

With this choice, you can identify a set of entities whose sequence numbers fall within a specified range.

1.FIRST SEQUENCE NO. = nn Enter a low and a high sequence number.
2.SECOND SEQUENCE NO. = nn The entities whose sequence numbers fall within this range are identified.

The sequence numbers of the entities are displayed above the entities.

7.7 Regen Entity #N

With this choice, you can regenerate an entity so that it has the original relationship to any entities used in its definition. For example, a second point is defined at a distance and angle from a first point, and the first point is moved. Regenerating the second point causes that point to be returned to its original distance and angle from the first point. If no entities were used in the definition of the entity selected for regeneration or if none of the entities used in the definition of the entity selected have been modified, this operation has no effect.

FIRST SEQUENCE NO. = nn Enter the sequence number of the entity to be regenerated.

The sequence number of the entity is displayed above the entity, and the entity is regenerated.

7.8 Regen from N1 to N2

With this choice, you can regenerate a set of entities whose sequence numbers fall within a specified range.

1. FIRST SEQUENCE NO. = nn Enter a low and a high sequence number.
2. SECOND SEQUENCE NO. = nn The entities whose sequence numbers fall within this range are regenerated.

The sequence numbers of the entities are displayed above the entities, and the entities are regenerated.

7.9 Regen All

With this choice, you can regenerate all the entities in the part. There are no system prompts or actions for this operation.

7.10 Bulk Data Input

With this choice, you can read point, line, arc, point set, and note data from an external file. The data is presented to the system on coordinate and text lines. The coordinate lines are processed according to a user-specified, FORTRAN-like format. Control of the input flow is directed by control commands. The bulk data is contained in one named text record and resides on a file called BULKIN. Figure 3-2 is an example of a bulk data file. Figure 3-3 is the resulting display.

```

BULKIN
REMARK/ *****
REMARK/ *                               *
REMARK/ *           BULK DATA INPUT SAMPLE           *
REMARK/ *                               *
REMARK/ *****
REMARK/ SET THE CHARACTER SIZE TO 0.125 INCHES OR 3.175 MILLIMETERS
REMARK/ SET THE DEPTH TO 0.0
REMARK/ TURN THE DISPLAY OFF
REMARK/ SET THE FONT TO SOLID
REMARK/ SET THE FORMAT TO 'F10.2'
REMARK/ SET THE LEVEL TO 0
REMARK/ SET THE PEN NUMBER TO 0
REMARK/ TURN THE CHARACTER SLANT OFF
RESET/
DISPLAY/ON/ TURN THE DISPLAY ON FOR SUBSEQUENT TITLES
CIRCLE0001=CIRCLE,1/DEFINE A CIRCLE WITH THE NAME 'CIRCLE0001'
    4.5      7.0
    2.5      5.0
    4.5      3.0
    90.0     270.0
FORMAT/3X,2F11.5,X,F15.3   RESET THE FORMAT
PEN/1                       SET THE PEN NUMBER TO 1 FOR SUBSEQUENT ENTITIES
LEVEL/1                     SET THE LEVEL TO 1 FOR SUBSEQUENT ENTITIES
CIRCLE0002=CIRCLE,2/  DEFINE A CIRCLE WITH THE NAME 'CIRCLE0002'
    4.5      6.5
    3.0      5.0
    4.5      3.5
REMARK/ DEFINE A CIRCLE WITHOUT A NAME
    4.5      5.75
    3.75     5.0
    4.5      4.25
PEN/2                       SET THE PEN NUMBER TO 2 FOR SUBSEQUENT ENTITIES
LEVEL/2                     SET THE LEVEL TO 2 FOR SUBSEQUENT ENTITIES
LINE,1/ DEFINE TWO LINES WITHOUT NAMES
    4.5      6.5      0.0
    5.83333  5.0      0.0
    5.83333  4.25     0.0
    5.83333  5.75
LINE000001=LINE/ DEFINE A LINE WITH THE NAME 'LINE000001'
    4.5      5.75
    5.83333  5.75
PEN/2                       SET THE PEN NUMBER TO 2 FOR SUBSEQUENT ENTITIES
LEVEL/3                     SET THE LEVEL TO 3 FOR SUBSEQUENT ENTITIES
POLYGON0001=POLYGON/ DEFINE A POLYGON WITH THE NAME 'POLYGON0001'
    4.5      7.0
    6.5      7.0
    6.5      5.25
    4.5      5.25
    4.5      4.75
    6.5      4.75
    6.5      3.0
    4.5      3.0
LINE000002=LINE,2/ DEFINE A LINE WITH THE NAME 'LINE000002'
    4.5      4.25
    5.83333  4.25
    5.83333  3.5
    4.5      3.5
REMARK/ BREAK HERE TO CROSSHATCH AND MIRROR THE
REMARK/ FIGURE AND SET CENTER TEXT JUSTIFICATION
BREAK/
FORMAT/3X,2F11.5,X,F15.3   RESET THE FORMAT
CSIZE/0.25                SET THE CHARACTER SIZE FOR SUBSEQUENT NOTES
DISPLAY/ON/ TURN THE DISPLAY ON FOR SUBSEQUENT ENTITIES
NOTE000001=NOTE/ DEFINE A NOTE WITH THE NAME 'NOTE000001'
    7.0      2.0
CONTROL DATA CORPORATIONS,D.O
-EDI/TOP-
?
```

Figure 3-2. Bulk Data File

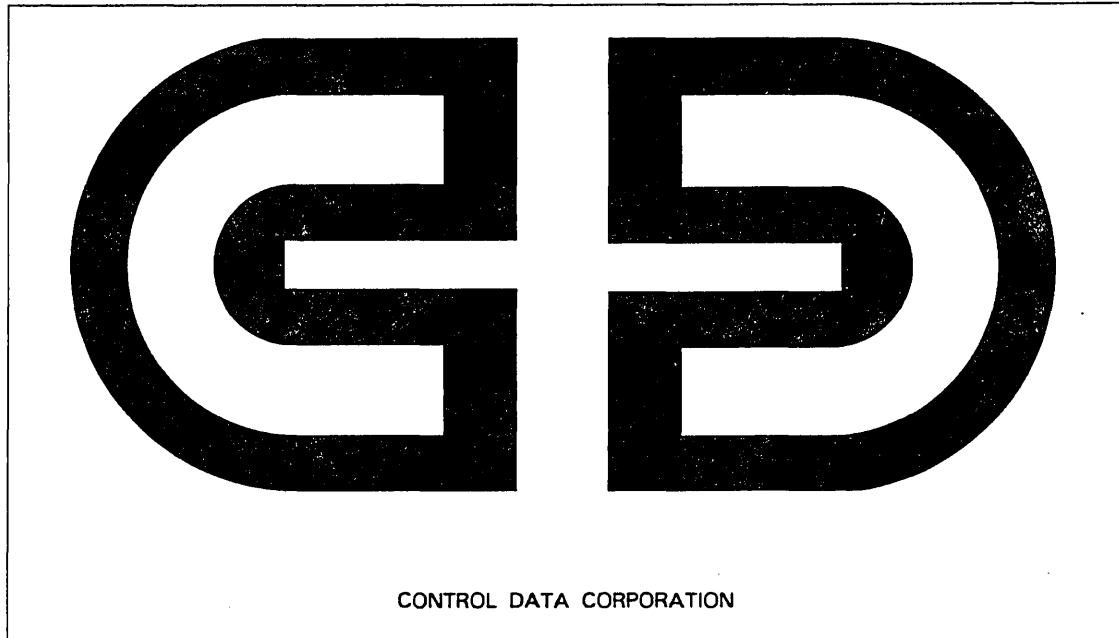

Figure 3-3. Bulk Data Display

The format of the control command is:

```
major word,(entity definition type)/  minor word
                                     value
```

The items in parentheses are optional for some control commands. Major words start in the first column, unless a name is to be associated with an entity. Major words and their associated minor words or values are as follows.

Command	Description
BREAK/	Suspends record processing temporarily and returns the system to 7 INPUT/OUTPUT/REGENERATION. If input is continued, processing continues with the line immediately following the BREAK/ command, the format is reset to the default 3F10.2, and the display is turned off. A BREAK command can follow any text line or any coordinate line after entity definition is complete. It cannot follow the CIRCLE, LINE, NOTE, POINT, or POLYGON commands. A coordinate or text line cannot follow this command.
CIRCLE/	Indicates that the next 4 times n (4n) coordinate lines define a circle in which n is the number of circles to be defined. The first three lines specify the coordinates of three points on the circle, and the fourth line specifies the starting and ending angles of the circle. If the three coordinates specified are colinear, two lines are created and a message is displayed. The first line uses the first and second coordinate lines in its definition. The second line uses the second and third coordinate lines in its definition. A CIRCLE command can follow any text line or any coordinate line after entity definition is complete. It cannot follow the CIRCLE, LINE, NOTE, POINT, or POLYGON commands. A coordinate line must follow this command.
CIRCLE,1/	Refer to the CIRCLE/ command description.

Command	Description
CIRCLE,2/	Indicates that the next 3 times n (3n) coordinate lines define a circle in which n is the number of circles to be defined. Every three lines specify the coordinates of three points on the circle. If the three coordinates specified are colinear, two lines are created, and a message is displayed. The first line uses the first and second coordinate lines in its definition. The second line uses the second and third coordinate lines in its definition. The starting and ending angles are computed so that the circle begins and ends with the first and third coordinates, respectively. A CIRCLE command can follow any text line or any coordinate line after entity definition is complete. It cannot follow the CIRCLE, LINE, NOTE, POINT, or POLYGON commands. A coordinate line must follow this command.
CSIZE/n.nnn	Indicates that subsequent notes have a character size of n.nnn, in which n.nnn is a number with a maximum of 20 digits, including the sign and decimal point. This number must lie completely within the 20-character field immediately following /. A CSIZE command can follow any text line or any coordinate line after entity definition is complete. It cannot follow the CIRCLE, LINE, NOTE, POINT, or POLYGON commands. A coordinate or text line cannot follow this command.
DEPTH/n.nnn	Indicates that subsequent entities are created at a depth of n.nnn, in which n.nnn is a number with a maximum of 20 digits, including the sign and decimal point. This number must lie completely within the 20-character field immediately following /. A DEPTH command can follow any text line or any coordinate line after entity definition is complete. It cannot follow the CIRCLE, LINE, NOTE, POINT, or POLYGON commands. A coordinate or text line cannot follow this command.
DISPLAY/(OFF) (ON)	Turns the display of subsequent entities off or on. If this command is not present, OFF is assumed. A DISPLAY command can follow any text line or any coordinate line after entity definition is complete. It cannot follow the CIRCLE, LINE, NOTE, POINT, or POLYGON commands. A coordinate or text line cannot follow this command.
FONT/xxxxxxx	Indicates that subsequent entities are created with font xxxxxxx, in which xxxxxxx can be either SOLID, DASHED, PHANTOM, or CLINE. The font type must immediately follow /. A FONT command can follow any text line or any coordinate line after entity definition is complete. It cannot follow the CIRCLE, LINE, NOTE, POINT, or POLYGON commands. A coordinate or text line cannot follow this command.

Command	Description
FORMAT/xxx	<p>Defines the format to be followed by subsequent coordinate lines. xxx is the character string defining the format and has the form:</p> $n1X,m1Fw1.d1\dots,nrX,mrFwr.dr$ $1 \leq r \leq 3$ $m1+m2+m3=3$ $3 \leq n1+n2+n3+w1+w2=w3 \leq 80$ $3 \leq w \leq 20$ $0 \leq d \leq 17$ <p>If no FORMAT command is present, 3F10.2 is assumed. A FORMAT command can follow any text line or any coordinate line after entity definition is complete. It cannot follow the CIRCLE, LINE, NOTE, POINT, or POLYGON commands. A coordinate or text line cannot follow this command.</p>
LEVEL/nnnn	<p>Indicates that subsequent entities are created on level nnnn, in which nnnn is a positive integer and $0 \leq nnnn \leq 1023$. This number must lie completely within the 20-character field immediately following /. A LEVEL command can follow any text line or any coordinate line after entity definition is complete. It cannot follow the CIRCLE, LINE, NOTE, POINT, or POLYGON commands. A coordinate or text line cannot follow this command.</p>
LINE/	<p>Indicates that the next 2 times n (2n) coordinate lines define line end points, in which n is the number of lines to be created. A LINE command can follow any text line or any coordinate line after entity definition is complete. It cannot follow the CIRCLE, LINE, NOTE, POINT, or POLYGON commands. A coordinate line must follow this command.</p>
LINE,1/	<p>Refer to the LINE/ command description.</p>
LINE,2/	<p>Indicates that the next n+1 coordinate lines define line end points, in which n is the number of lines to be created. A LINE command can follow any text line or any coordinate line after entity definition is complete. It cannot follow the CIRCLE, LINE, NOTE, POINT, or POLYGON commands. A coordinate line must follow this command.</p>

Command	Description
NOTE/	Indicates that the next n pairs of coordinate and text lines define notes, in which n is the number of notes to be defined. The coordinate lines define the origins of the notes. The text lines contain the text in delimiters, followed by a comma and a text angle. The first nonblank character encountered is used as the delimiter. The entire text string, including the delimiter characters, cannot exceed 70 characters. All characters in the text string must be uppercase display code characters. The text angle is specified in degrees and cannot exceed 9 characters, including the sign and decimal point. A NOTE command can follow any text line or any coordinate line after entity definition is complete. It cannot follow the CIRCLE, LINE, NOTE, POINT, or POLYGON commands. A coordinate line must follow this command.
PEN/ n	Indicates that subsequent entities are created with pen n , in which n is a positive integer and $0 \leq n \leq 3$. This number must lie completely within the 20-character field immediately following /. A PEN command can follow any text line or any coordinate line after entity definition is complete. It cannot follow the CIRCLE, LINE, NOTE, POINT, or POLYGON commands. A coordinate or text line cannot follow this command.
POINT/	Indicates that the next n coordinate lines define point coordinates, in which n is the number of points to be created. A POINT command can follow any text line or any coordinate line after entity definition is complete. It cannot follow the CIRCLE, LINE, NOTE, POINT, or POLYGON commands. A coordinate line must follow this command.
POLYGON/	Indicates that the next n coordinate lines define the vertices of a point set, where $2 \leq n \leq 85$. A new POLYGON command is required for each new point set. A POLYGON command can follow any text line or any coordinate line after entity definition is complete. It cannot follow the CIRCLE, LINE, NOTE, POINT, or POLYGON commands. A coordinate line must follow this command.
REMARK/	Indicates a nonexecutable command used to place comments throughout the bulk data file. A REMARK command can follow any control command, text line, or coordinate line after entity definition is complete. A text line cannot follow this command.

Command	Description
RESET/	<p>Resets some system modals and values. This command is the same as:</p> <p>CSIZE/0.125 (inches) CSIZE/3.175 (millimeters) DEPTH/0.0 DISPLAY/OFF FONT/SOLID FORMAT/3F10.2 LEVEL/0 PEN/0 SLANT/OFF</p> <p>A RESET command can follow any text line or any coordinate line after entity definition is complete. It cannot follow the CIRCLE, LINE, NOTE, POINT, or POLYGON commands. A coordinate or text line cannot follow this command.</p>
SLANT/(OFF) (ON)	<p>Indicates that subsequent notes have the character slant OFF or ON. If this command is not present, OFF is assumed. A SLANT command can follow any text line or any coordinate line after entity definition is complete. It cannot follow the CIRCLE, LINE, NOTE, POINT, or POLYGON commands. A coordinate or text line cannot follow this command.</p>
ZSURF/n.nnn	<p>Refer to the DEPTH/n.nnn description.</p>

Command lines, coordinate lines, and text lines can have a maximum of 80 characters per line. Comments on the BREAK, CIRCLE, LINE, NOTE, POINT, POLYGON, REMARK, and RESET command lines can begin immediately after /. Comments on the DISPLAY, FONT, and SLANT command lines can begin immediately after the last alphanumeric character processed. Comments on the CSIZE, DEPTH, FORMAT, LEVEL, PEN, and ZSURF command lines must begin in column 31. Comments are not allowed on coordinate lines or text lines.

If an x or y coordinate is missing on a coordinate line, 0.0 is assumed. If the z-coordinate is missing, the current depth is assumed. A coordinate line can only follow the CIRCLE, LINE, NOTE, POINT, POLYGON, and REMARK commands, and text lines. Text lines can appear only after coordinate lines. If no text angle is specified on this line, 0.0 is assumed.

Entity names can appear only on the CIRCLE, LINE, NOTE, POINT, and POLYGON command lines. Each name can have a maximum of 10 characters, must start in column 1, and be immediately followed by an equal sign. The control command must appear immediately after the equal sign.

BULK DATA INPUT MODE
 1.START INPUT
 2.CONTINUE INPUT

Enter:

- 1 To begin processing a new record within the file. Continue to Start Input.
- 2 To continue processing a record starting with the line immediately following the last BREAK command.

Enter [or] to return to 7
 INPUT/OUTPUT/REGENERATION.

Start Input

You begin processing by entering a name.

ENTER SIX CHARACTER RECORD
 NAME

Enter the new record name to be processed.

Enter:

- [To return to the BULK DATA INPUT MODE prompt.
-] To return to 7
 INPUT/OUTPUT/REGENERATION.

If the entered record name cannot be found, the system displays:

RECORD NOT FOUND

You return to 7 INPUT/OUTPUT/REGENERATION.

After successful processing of the record, the system displays:

nnn LINES READ

You return to 7 INPUT/OUTPUT/REGENERATION.

If processing is interrupted due to error, inconsistency, or a BREAK command, the system displays the following messages:

Message	Description
BREAK ENCOUNTERED AT LINE nnn	Processing was terminated because a BREAK command was encountered.
CIRCLE POINTS ARE COLINEAR, TWO LINES DEFINED AT LINE nnn	The last three coordinate lines processed defined colinear points. Two contiguous lines were defined using these coordinates as endpoints. Processing is continued after the lines are defined.

Message	Description
COMMAND EXPECTED AT LINE nnn	A coordinate or text line was encountered where it should not have been. Processing is terminated.
COMMAND NOT ALLOWED AT LINE nnn	A coordinate or text line was expected. Processing is terminated.
ERROR	An error occurred in the processing of a numerical value. Processing is terminated.
ERROR IN CHARACTER SIZE AT LINE nnn	A 0 or negative character size has been encountered. Processing is terminated.
ERROR IN DISPLAY COMMAND AT LINE nnn	The keywords OFF or ON were not encountered immediately following / on the DISPLAY command line. Processing is terminated.
ERROR IN FONT COMMAND AT LINE nnn	The keywords SOLID, DASHED, CLINE, or PHANTOM were not encountered immediately following / on the FONT command line. Processing is terminated.
ERROR IN FORMAT COMMAND AT LINE nnn	A syntax error was encountered in the processing of the FORMAT statement. Processing is terminated.
ERROR IN LEVEL COMMAND AT LINE nnn	The level number encountered was less than 0 or greater than 1023. Processing is terminated.
ERROR IN NAME AT LINE nnn	The name encountered was greater than 10 characters in length or zero length. Processing is terminated.
ERROR IN PEN COMMAND AT LINE nnn	The pen number encountered was less than 0 or greater than 3. Processing is terminated.
ERROR IN SLANT COMMAND AT LINE nnn	The keywords OFF or ON were not encountered immediately following / on the SLANT command line. Processing is terminated.
ERROR IN TEXT AT LINE nnn	No nonblank characters were encountered on the text line, or only one delimiter was encountered, or no text exists between the delimiters. Processing is terminated.
NO BREAK ENCOUNTERED AT LINE nnn	An attempt to continue processing failed because the last command processed was not a BREAK command.

Message	Description
ONLY ONE COORDINATE FOR POLYGON AT LINE nnn	A point set must consist of at least two coordinate values. Processing is terminated.
TOO MANY CHARACTERS AT LINE nnn	A line with more than 80 characters was encountered. Processing is terminated.
TOO MANY COORDINATE LINES AT LINE nnn	More than 85 coordinate lines were encountered for the POLYGON definition. Processing is terminated.

7.11 Reserved For Future Use

7.12 Mesh Generator Interface

With this choice, you can create a LINE data file in a format that can be interpreted by a mesh generator. This LINE file contains all necessary information (block, line, and point information) for passing on the geometric models constructed with the system.

BLOCK NAME	Enter a block name (up to 30 characters); the system writes a block definition card. Enter] without a block name to continue processing with the next prompt (no block definition card is written). Enter [to return to the first prompt.
ENTITY TYPE 1.CURVES 2.SURFACES	Enter: 1 To transfer curves. Continue to Curves. 2 To transfer surfaces. Continue to Surfaces.

Curves

With this choice, you can transfer curves.

NUMBER OF POINTS =	Enter the number of points to be used in defining the curve. For lines, only two points are passed on.
INDICATE CURVE	Use the graphics cursor to screen select the curves to pass on to a mesh generator. The following curves can be selected: <ul style="list-style-type: none"> • Lines and point-sets • Arcs and circles • Conics • Two-dimensional splines • Three-dimensional splines • Composite curves • Machining curves

If you want to use another method of selection, enter E or CTRL-E to receive the Entity Selection menu. Refer to the ICEM Design/Drafting Introduction and System Controls manual for more information.

```

ENTITY SELECTION
1.SCREEN SELECT
2.CHAIN
3.REGION
:
```

Surfaces

With this choice, you can transfer surfaces.

INDICATE SURFACE

Use the graphics cursor to select the surface to be passed on.

1. NUMBER OF U-PATHS =

Enter the number of u paths (horizontal paths along the definition curve) to be used in defining the surface.

2. NUMBER OF V-PATHS =

Enter the number of v paths (vertical paths along the definition curve) to be used in defining the surface.

3. POINTS ON U-PATH =

Enter the number of points, to be connected by lines, along the u path.

4. POINTS ON V-PATH =

Enter the number of points, to be connected by lines, along the v path.

The system marks each of the entities selected with an attention indicator (a small oval). If you reject a selection, the system returns to the previous prompt. When you accept the selections by entering], the system writes the LINE data file.

The LINE file is written on a local file named MESHFIL. You must make it permanent before it becomes accessible from a mesh generator. No rewinding is done either before or after the creation of the LINE file. The LINE file format is as follows.

DEFBLK,block name,FORMAT=(3F10.4)

LINE

X11 Y11 Z11

X12 Y12 Z12

LINE

X13 Y13 Z13

X14 Y14 Z14

 : : :

6/7/8/9 (end of file card)

Refer to the appropriate mesh generator reference manual for more information.

The following are possible error messages:

NO LEGAL ENTITIES FOUND

No allowed entities that can be selected are displayed.

NUMBER TOO LARGE FOR CONVERSION

A real coordinate value could not be converted to the FORTRAN format 3F10.4.

7.13 Tablet Management

With this choice, you can create your own user tablet pages. The pages you create can be used in addition to the system-defined tablet pages, such as BFL, BFU, AD, DBM, and so on. Each page is broken down into squares with which you may associate a string of menu commands and text. These command strings can be direct or external named strings stored on an external file with the default name MSTRING. A blank tablet overlay divided into the smallest definable squares is displayed in Appendix B of the ICEM Design/Drafting Introduction and System Controls manual. You can create a page by beginning from a blank or by starting with a copy of an existing standard or user page. You can also modify, rename, delete, display, list, and copy user pages. The user pages are stored on an external edit file with the default name TFILE.

The menu for this section is:

```

EDIT FILE = editfil
TABLET MANAGEMENT
  1.TABLET MODALS
  2.CREATE PAGE
  3.MODIFY PAGE
  4.RENAME PAGE
  5.DELETE PAGE
  6.DISPLAY PAGE
  7.LIST PAGES IN EDIT FILE
  8.CHANGE EDIT FILE
  9.PACK EDIT FILE
 10.COPY PAGES FROM ANOTHER FILE

```

The line above the menu header displays the current tablet edit file name (editfil).

You may choose 2.CREATE PAGE, 3.MODIFY PAGE, 4.RENAME PAGE, 5.DELETE PAGE, and 10.COPY PAGES FROM ANOTHER FILE only if your tablet edit file has write permission.

If you do not have a tablet edit file assigned, the system asks whether you want to retrieve an existing permanent tablet file.

```

NO TABLET EDIT FILE IS ASSIGNED
GET EXISTING TABLET FILE?

```

Enter:

Y To retrieve a permanent tablet file.

N To avoid retrieving a permanent tablet file. You proceed to the prompts for creating a permanent tablet file.

If you enter Y, the following prompt is displayed:

```

ENTER NAME OF FILE TO RETRIEVE

```

Enter the name of the tablet file you want to retrieve.

or

Enter] to return to the Table Management menu.

If the file is successfully retrieved, you receive the following message:

```

editfil RETRIEVED AND IS READY FOR USE

```

7.13.1 Tablet Modals

If the file cannot be retrieved, you receive a diagnostic message and return to the ENTER NAME OF FILE TO RETRIEVE prompt.

If you enter N to GET EXISTING TABLET FILE?, you receive the following prompt:

CREATE PERMANENT TABLET FILE?

Enter:

Y To create a permanent tablet file.

N To avoid creating a permanent tablet file. You return to the Tablet Management menu.

If you answer Y, you receive the following prompt:

ENTER NAME FOR NEW TABLET FILE

Enter a name consisting of 1 to 7 characters.

or

Enter] to return to the Tablet Management menu.

If the file is successfully created, you receive the following message:

PERMANENT TABLET FILE editfil CREATED

If the file cannot be created, you receive a diagnostic message and return to the ENTER NAME FOR NEW TABLET FILE prompt.

7.13.1 Tablet Modals

The tablet modals control the modes of operation for functions within tablet management. The menu for this section is:

TABLET MODALS	
1.SQUARE OVERWRITE MODE	PROMPT
2.PAGE DISPLAY STATUS	DISPLAY
3.PAGE DISPLAY AREA	UPPER
4.STRING DISPLAY FORMAT	UNPACKED
5.TABLET FILE STATUS	EQUATED

Current settings for the modals are displayed to the right of the menu choice. (The settings displayed above are the default settings.)

The following section describes these menu choices.

7.13.1.1 Square Overwrite Mode

With this choice, you can specify the overwrite mode for the Edit/Save Page functions DEFINE SQUARE, ASSIGN MSTRING NAME TO SQUARE, MOVE SQUARE, and COPY SQUARE. The menu for this section is:

```
SQUARE OVERWRITE MODE
1.PROMPT TO OVERWRITE
2.AUTOMATICALLY OVERWRITE
3.DO NOT OVERWRITE
```

Enter:

- 1 To have the system ask whether you want to overwrite a square that is already defined. This is the default mode. The message SQUARE (nr,nc) ALREADY DEFINED OVERWRITE? is displayed during square definition selections. When you make this menu choice, the confirmation message SQUARE OVERWRITE MODE = PROMPT is displayed.
- 2 To have the system automatically overwrite squares that are already assigned to an internal or MSTRING. The message SQUARE (nr,nc) OVERWRITTEN is displayed. When you make this choice, the confirmation message SQUARE OVERWRITE MODE = OVERWRITE is displayed.
- 3 To avoid overwriting any squares that are already defined. You return to the INDICATE SQUARE prompt. When you make this choice, the confirmation message SQUARE OVERWRITE MODE = NO OVERWRITE is displayed.

7.13.1.2 Page Display Status

With this choice, you can specify whether to display the tablet page grid when you create or modify your user tablet pages. If the grid is displayed, it corresponds directly to the tablet squares on your tablet overlay. You can indicate a square by selecting the area defining it directly from the screen. Furthermore, as you define squares, the string representing the square is displayed in the chosen location.

```
PAGE DISPLAY STATUS
1.DISPLAY
2.DO NOT DISPLAY
```

Enter:

- 1 To display the tablet page grid when you create or modify tablet pages. This is the default value. You receive the confirmation message PAGE DISPLAY STATUS = DISPLAY and return to the Tablet Management menu.
- 2 To avoid displaying the tablet page grid when creating or modifying tablet pages. You receive the confirmation message PAGE DISPLAY STATUS = NO DISPLAY and return to the Tablet Management menu.

7.13.1.3 Page Display Area

With this choice, you can specify where to display the tablet page grid on your screen. This mode controls the page display area for 7.13.6 DISPLAY PAGE and for 8.DISPLAY PAGE from the Edit/Save Page menu.

PAGE DISPLAY AREA
1.UPPER SCREEN
2.LOWER SCREEN

Enter:

- 1 To display the tablet page grid on the upper portion of your screen. This is the default page display area. The displayed page grid corresponds directly to the upper page overlay area on your tablet. You receive the message PAGE DISPLAY AREA = UPPER SCREEN and return to the Tablet Management menu.
- 2 To display the tablet page grid on the lower portion of your screen. The displayed page corresponds directly to the upper page overlay area on your tablet. You receive the message PAGE DISPLAY AREA = LOWER SCREEN and return to the Tablet Management menu.

7.13.1.4 String Display Format

With this choice, you can specify the format for displaying direct command strings. This mode controls the string format for menu 7.13.6 DISPLAY PAGE and for 3.LIST SQUARE and 8.DISPLAY PAGE from the Edit/Save Page menu. The following menu is displayed:

STRING DISPLAY FORMAT
1.UNPACKED CHARACTERS
2.PACKED CHARACTERS

Enter:

- 1 To display strings in their unpacked format. This is the default format. Two-digit numbers representing menu selections 10-19 and menu choice separator periods are displayed. For example, the string F.16.13.12 is in unpacked format. When you make this selection, you receive the message STRING DISPLAY FORMAT = UNPACKED.
- 2 To display strings in their packed format. Two-digit numbers representing menu selections 10-19 are represented by the special single-character equivalents 0, !, ", #, \$, %, &, ', (, and). Periods separating menu choices are not displayed. The string, F&#", is the packed representation of the string, F.16.13.12. When you make this selection, you receive the message STRING DISPLAY FORMAT = PACKED.

After your selection, you return to 7.13 TABLET MANAGEMENT.

7.13.1.5 Tablet File Status

With this choice, you can specify whether the tablet command and tablet edit files are the same or separate files. Active page squares are executed from the tablet command file. Files you create and modify are saved in the tablet edit file. When you enter ICEM DDN and specify a new part, the two files are the same.

The setting you select from the following menu affects 1.16.3 CHANGE COMMAND FILE and 7.13.8 CHANGE EDIT FILE.

```
TABLET FILE STATUS
1.EQUATE EDIT AND COMMAND FILES
2.DO NOT EQUATE EDIT AND COMMAND FILES
```

Enter:

- 1 To specify the tablet command and edit files as the same file. This is the default setting. When you select 1.16.3 CHANGE COMMAND FILE and enter a new file name, the edit file is also changed to the new name. You then receive the message TABLET FILE STATUS = EQUATED.
- 2 To specify the tablet command and edit files as separate files. When you select 7.13.8 CHANGE EDIT FILE and enter a new file name, the tablet command file name does not change. You receive the message TABLET FILE STATUS = NOT EQUATED.

After your selection, you return to 7.13 TABLET MANAGEMENT.

7.13.2 Create Page

With this choice, you can create a new user page and assign strings to the squares on it.

ENTER NAME FOR NEW USER PAGE

Enter the name for the new user page you want to create (1 to 7 characters). You cannot use standard page names for new user pages. Enter LIST to list pages in the tablet edit file.

If the page name you entered is already in your tablet edit file (editfil), you have the option to replace the existing user page with this new one.

pagname IS ALREADY IN editfil
OVERWRITE?

Enter:

Y To overwrite an existing user page with your created page.

N To return to the prompt ENTER NAME FOR NEW USER PAGE to use another name.

You can create a new user page by starting from any one of three options. The name of the edit page previously entered is displayed above the Create Page menu.

EDIT PAGE = editpag
CREATE PAGE

- 1.USE BLANK PAGE
- 2.USE COPY OF STANDARD PAGE
- 3.USE COPY OF USER PAGE

Enter:

1 To create a user page by starting with a blank tablet page (has no functions associated with any squares).

2 To create a user page by starting from a copy of a standard page. The page created can be saved as a user page that represents a modified version of a standard page.

3 To create a user page by starting from a copy of an existing user page. The page created can be saved as a modified version of the existing user page.

If you select 2.USE COPY OF STANDARD PAGE, the following menu is displayed:

STANDARD PAGES

- 1.BFU
- 2.BFL
- 3.DBM
- 4.DC
- 5.DFT
- 6.AD
- 7.NC

Enter the number associated with the standard page from which you want to create a new user page. (The drafting page calls up the drafting overlay that corresponds to the selected drafting standard.)

If you select 3.USE COPY OF USER PAGE, the following prompt is displayed:

ENTER NAME OF USER PAGE TO COPY

Enter the name of the existing user page from which you want to create a new user page. Enter LIST to display a list of user pages.

If the page name you entered is not in your tablet edit file (editfil), the following message is displayed:

```
pagname IS NOT IN editfil
```

The system returns to the ENTER NAME OF USER PAGE TO COPY prompt to enter another user page name.

Proceed to the Edit/Save Page menu.

7.13.3 Modify Page

With this selection, you can modify an existing user page. You cannot modify standard pages.

ENTER NAME OF USER PAGE TO MODIFY

Enter the name of the existing user page you want to modify. Enter LIST to display a list of your user pages.

If the page name you entered is not in your tablet edit file, the following message is displayed:

```
pagname IS NOT IN editfil
```

The system returns to the ENTER NAME OF USER PAGE TO MODIFY prompt.

Proceed to the Edit/Save Page menu.

Edit/Save Page

If you previously selected 7.13.2 CREATE PAGE or 7.13.3 MODIFY PAGE and successfully identified a tablet page, the system displays:

```
EDIT PAGE = editpag
EDIT/SAVE PAGE
1.DEFINE SQUARE
2.ASSIGN MSTRING NAME TO SQUARE
3.LIST SQUARE
4.MOVE SQUARE
5.COPY SQUARE
6.DELETE SQUARE
7.DISPLAY PAGE
8.SAVE PAGE AND CONTINUE
9.SAVE PAGE AND EXIT
```

The current edit page name (editpag) is displayed above the menu header. If 7.13.1.2 PAGE DISPLAY STATUS is set to 1.DISPLAY, the tablet page grid representing the tablet page entered is displayed.

If you want to change a modal value, enter V or CTRL-V to go to the Tablet Modals menu. You return to the Edit/Save Page menu following], [, or selection of a modal value.

If you enter] or [after obtaining a page to modify or create, the system asks whether you want to save that page.

SAVE pagname IN editfil?

Enter:

Y To save the page on your edit file. You return to the same prompts that occur under 9.SAVE PAGE AND EXIT. Refer to this section of the manual.

N To discard all work and return to 7.13 TABLET MANAGEMENT. You receive the message, pagname NOT SAVED.

Each of these menu choices is explained on the following pages.

Define Square

With this choice, you can define a square with a command string. When you save the page you are creating or modifying, the defined strings are saved on the tablet file you attached.

ENTER COMMAND STRING

From the *keyboard*, enter 127 or fewer characters of the commands to be associated with squares you will indicate later.

Enter a return to complete the command string entry. More information about command string formatting follows.

The command string length is limited to 127 characters, including characters entered to replace variables, but not including periods or tab characters that separate menu choices. Any additional command you enter is associated with the tablet square being programmed. If you enter between 75 and 126 characters, you are given the option of continuing the string on the following line. This option is provided for terminals on which you can enter only 80 characters on a single line.

CONTINUE STRING

From the *keyboard*, enter a return if the string is complete, or more commands followed by a return. Entry of more than 127 characters is ignored.

You can assign only 8 characters to a single square. If the command string you enter contains more than 8 characters, more than one square is required to contain the string. The following message appears:

(nr) ROW X (nc) COLUMN AREA REQUIRED

This prompt indicates that the defined squares are adjacent and form an area that is nr rows deep by nc columns wide.

You are now asked to indicate the square you want to define with the command string. If a tablet is attached to your terminal, the system displays:

INDICATE SQUARE TO DEFINE

Use the graphics cursor to indicate the square that represents the upper left corner of the required area.

or

Enter:

] To complete square identification and return to the ENTER COMMAND STRING prompt.

[To ignore the entered string and return to the ENTER COMMAND STRING prompt.

If 7.13.1.2 PAGE DISPLAY STATUS is set to 2.DO NOT DISPLAY, you must enter the row and column numbers of the square.

ENTER SQUARE TO DEFINE

1.ROW NUMBER =

2.COL NUMBER =

Enter the row and column numbers of the square you want to define. Columns are numbered 1 to 20, from left to right; rows are numbered 1 to 10, from top to bottom of the tablet page.

If the square you selected is already defined and 7.13.1.1.2 AUTOMATICALLY OVERWRITE was not previously selected, the following prompt is displayed:

SQUARE (nr,nc) IS ALREADY DEFINED.
OVERWRITE?

In this prompt, nr represents the square row number and nc represents the square column number.

Enter:

Y To overwrite the square with the new definition. You receive the confirmation message SQUARE (nr,nc) OVERWRITTEN.

N To avoid overwriting the square. You maintain the current square definition.

You return to the INDICATE SQUARE TO DEFINE prompt to assign a command string to another square. You can continue indicating squares that you want to define with the previously entered command string.

Assign MSTRING Name to Square

With this choice, you can assign a string residing on an external file, called an MSTRING file, to the tablet squares you indicate. When you indicate a square of a user tablet page to which an MSTRING name is assigned, the system finds the named string of commands on a local file for which the default name is MSTRING and processes them. You can change the name of the MSTRING file with 1.16.4 CHANGE MSTRING FILE. Refer to the ICEM Design/Drafting Introduction and System Controls manual for more information.

If the system finds an error in the string format while executing a tablet square, it beeps and displays the following message:

```
MSTRING msname CONTAINS A SYNTAX ERROR
```

The system stops processing and waits for your input.

An MSTRING file is a user-generated, formatted external text file. It is created and edited outside of ICEM DDN by any editor in ASCII mode. The file contains named records of command strings. Each named record represents a complete MSTRING or named command string. You must format the MSTRING file as follows:

- The first line of a record contains the MSTRING name.
- The rest of the lines consist of comments and string commands.
- Comment lines contain an asterisk (*) in the first column.
- The number of lines of menu commands or comments that make up a named record is not limited.
- Each line must be less than or equal to 127 characters.
- Commands can continue on the next line as long as no delimited text crosses the lines.
- Each named record or MSTRING is separated by an end of record (EOR) mark.
- Repeat sequences (preceded by a lowercase r) repeat to the end of the line. Entering [stops processing of the current repeat sequence and continues with the next line. If no repeat sequence is in progress, entering [stops the MSTRING program from being processed.

MSTRING record names can be assigned to squares of a user tablet page even if an MSTRING does not yet exist or is not local. However, the file must be local if you want to execute an MSTRING from an active tablet page. Figure 3-4 shows an example of an MSTRING file format.

ENTER MSTRING NAME

Enter the name of the string in one of your MSTRING files to be associated with selected squares. Enter 1 to 7 characters.

or

Enter CTRL-V to go to the Tablet Modals menu to change a modal. You return to the ENTER MSTRING NAME prompt.

```

DUMMY
* THIS MSTRING FILE IS ASSOCIATED WITH THE TABLET FILE 'FLOW'
* AND CONTAINS THE STRINGS FOR THE NAMED SQUARES IN THE TABLET
* PAGE 'FLOWCH'
*
* 'FLOWCH' IS A TABLET PAGE WITH FUNCTIONS FOR CONSTRUCTING
* FLOW CHARTS. IT CALLS GPL PROGRAMS FROM LIBRARY GPLFLO
*
* THIS FILE WAS LAST UPDATED ON 7/30/85
*
(EOR)
CIRCLE
*
* CIRCLE EXECUTES GPL PROGRAM 'CIR' AND DRAWS A CIRCLE
*
f.5.13.3.3.tCIRt
(EOR)
DIAMOND
*
* DIAMOND EXECUTES GPL PROGRAM 'DIAM' AND DRAWS A DIAMOND
*
f.5.13.3.3.tDIAMt
(EOR)
CPEN
*
* CPEN REPEATEDLY CHANGES PEN NUMBER (BY REGION IN) TO #2
*
f.1.7.3.p.Y.N.t2]t
(EOR)
TEXT
* TEXT CONTINUOUSLY WRITES THE TEXT 'CONTROL RETURN' TO THE SCREEN
f.16.10.p.tCONTROL RETURN]t
(EOR)
CLEV
* CLEV CHANGES THE LEVEL OF INDICATED ENTITIES
f.1.7.1.p.N.ts]t.Y
(EOR)
SETUP
*
* SETUP MAKES MODAL SETTINGS FOR FLOW CHARTER
*
f.1.11.4.2.]
f.1.11.5.3
f.16.1.1.1.t.2]t.]
f.16.1.7.t.20]t.]
f.1.5.2
(EOF)

```

Figure 3-4. MSTRING File Format

You are next asked to identify the squares to be associated with the MSTRING name you entered. For either square assignment method, you can indicate a square in one of the following two ways, depending on your terminal interface.

If a tablet is attached to your terminal, the system displays:

INDICATE SQUARE FOR MSTRING

Use the graphics cursor to indicate the tablet square.

or

Enter] or [to return to the Edit/Save Page menu.

Enter CTRL-V to go to the Tablet Modals menu to change a modal. Then you return to the INDICATE SQUARE FOR MSTRING prompt.

If 7.13.1.2 PAGE DISPLAY STATUS is set to 2.DO NOT DISPLAY, you must enter the row and column numbers of the square.

ENTER SQUARE FOR MSTRING

1.ROW NUMBER =
2.COL NUMBER =

Enter the row and column numbers associated with the square you want to assign. Columns are numbered 1 to 20, from left to right; rows are numbered 1 to 10, from top to bottom of the tablet page.

or

Enter CTRL-V to go to the Tablet Modals menu to change a modal. You then return to the ENTER MSTRING NAME prompt.

If the square you selected is already defined, and you did not previously select 7.13.1.1.2 AUTOMATICALLY OVERWRITE, the following prompt is displayed:

SQUARE (nr,nc) IS ALREADY DEFINED.
OVERWRITE?

In this prompt, nr represents the square row number and nc represents the square column number.

Enter:

Y To overwrite the square with the new menu definition. You receive the message SQUARE (nr,nc) OVERWRITTEN.

N To avoid overwriting the square. You maintain the current menu definition.

If you previously selected 7.13.1.2.1 DISPLAY, the MSTRING name and a small box are displayed in the lower right corner. (On color terminals, MSTRING names are displayed in yellow.) You then return to the ENTER MSTRING NAME prompt.

List Square

With this selection, you can display the direct string or MSTRING associated with a particular square.

INDICATE SQUARE TO LIST

Indicate the square for which you want to display the associated direct string or MSTRING name.

or

Enter] or [to return to the Edit/Save Page menu.

Enter CTRL-V to go to the Tablet Modals menu to change a modal. You then return to the INDICATE SQUARE TO LIST prompt.

If 7.13.1.2 PAGE DISPLAY STATUS is set to 2.DO NOT DISPLAY, you must enter the row and column numbers of the square.

ENTER SQUARE TO LIST

1.ROW NUMBER =
2.COL NUMBER =

Enter the row and column numbers of the square for which you want to display the text string or MSTRING.

Entering], [, or CTRL-V gives the same results as above.

The row and column numbers of the square are displayed in parentheses on the first line, and the defined text string or assigned MSTRING name is displayed on the second line. For example:

```
SQUARE (5,20)  
f.12.7.2.1
```

The direct string f.12.7.2.1 is associated with the square in row 5, column 20.

If an MSTRING is assigned to the square indicated, the following message is displayed:

```
SQUARE (5,20)  
ASSIGNED MSTRING NAME = msname
```

The MSTRING msname is assigned to the indicated square.

If the indicated square is undefined, the following message is displayed:

```
SQUARE (5,20)  
-- UNDEFINED --
```

After indicating a square, you return to the INDICATE SQUARE TO LIST prompt.

Move Square

With this selection, you can move the definition of one square to another.

INDICATE SQUARE TO MOVE

Indicate the square definition you want to move.

or

Enter:

] or [to return to the Edit/Save Page.

Enter CTRL-V to redisplay the page grid.
You return to the INDICATE SQUARE TO MOVE prompt.

If 7.13.1.2 PAGE DISPLAY STATUS is set to 2.DO NOT DISPLAY, you must enter the row and column numbers of the square.

ENTER SQUARE TO MOVE

1.ROW NUMBER =

2.COL NUMBER =

Enter the row and column numbers of the square you want to move.

Entering], [, or CTRL-V gives the same results as above.

INDICATE NEW LOCATION

Indicate the square that will assume the definition of the square previously identified.

or

Enter:

] To terminate the move function and return to the Edit/Save Page.

[To return to the INDICATE SQUARE TO MOVE prompt.

Enter CTRL-V to go to the Tablet Modals menu to change a modal. You then return to the INDICATE NEW LOCATION prompt.

If 7.13.1.2 PAGE DISPLAY STATUS is set to 2.DO NOT DISPLAY, you must enter the row and column numbers of the square.

ENTER NEW LOCATION

1.ROW NUMBER =

2.COL NUMBER =

Enter the row and column numbers of the square to take on the definition you are moving.

If the page grid is displayed, the original square is marked with an X, indicating that it was deleted. The original square location is erased on terminals with local display files. The string is then displayed in the new location.

If the selected square is already defined and you did not specify 7.13.1.1.2 AUTOMATICALLY OVERWRITE, the following prompt is displayed:

```
SQUARE (nr,nc) IS ALREADY DEFINED.  
OVERWRITE?
```

In this prompt, nr represents the square row number and nc represents the square column number.

Enter:

Y To overwrite the square with the new menu definition. You receive the message SQUARE (nr,nc) OVERWRITTEN WITH (kr,kc).

N To avoid overwriting the square. You maintain the original menu definition.

You then return to the INDICATE SQUARE TO MOVE prompt. You can continue indicating squares whose functions you want to move.

Copy Square

With this selection, you can copy the definition of one square to another.

INDICATE ORIGINAL SQUARE

Indicate the square you want to copy.

or

Enter] or [to return to the Edit/Save Page menu.

Enter CTRL-V to display the Tablet Modals menu to change a modal. You return to the INDICATE COPY SQUARE prompt.

If 7.13.1.2 PAGE DISPLAY STATUS is set to 2.DO NOT DISPLAY, you must enter the row and column numbers of the square.

ENTER ORIGINAL SQUARE

1.ROW NUMBER =

2.COL NUMBER =

Enter the row and column numbers of the square you want to copy.

Entering], [, or CTRL-V gives the same results as above.

INDICATE COPY SQUARE

Indicate the square you want to copy from the original square you identified.

or

Enter:

] To terminate the copy function and return to the Edit/Save Page menu.

[To return to the INDICATE ORIGINAL SQUARE prompt.

Enter CTRL-V to go to the Tablet Modals menu to change a modal. You then return to the INDICATE COPY SQUARE prompt.

If 7.13.1.2 PAGE DISPLAY STATUS is set to 2.DO NOT DISPLAY, you must enter the row and column numbers of the square.

ENTER COPY SQUARE
1.ROW NUMBER =
2.COL NUMBER =

Enter the row and column numbers of the square where you want the copy.

If the selected square already has an assignment, the following prompt is displayed:

SQUARE (nr,nc) IS ALREADY DEFINED.
OVERWRITE?

In this prompt, nr represents the square row number and nc represents the square column number.

Enter:

Y To overwrite the square with the new menu definition. You receive the message SQUARE (nr,nc) OVERWRITTEN WITH (kr,kc).

N To avoid overwriting the square. You maintain the original menu definition.

You then return to the INDICATE COPY SQUARE prompt. Continue indicating squares that are to copy the function of the original square.

Delete Square

With this selection, you can delete the definition associated with one or more squares.

INDICATE SQUARE TO DELETE

Indicate the square whose associated definition you want to delete. You receive the message SQUARE (nr,nc) DELETED. If 7.13.1.2 PAGE DISPLAY STATUS is set to 1.DISPLAY, an X is displayed over the deleted square on the page grid. Deleted squares are erased on terminals with local display files.

or

Enter] or [to terminate deletion and return to the Edit/Save Page menu.

Enter CTRL-V to redisplay the tablet page grid. You return to the INDICATE SQUARE TO DELETE prompt.

If 7.13.1.2 PAGE DISPLAY STATUS is set to 2.DO NOT DISPLAY, you must enter the row and column numbers of the square.

ENTER SQUARE TO DELETE
1.ROW NUMBER =
2.COL NUMBER =

Enter the row and column numbers of the square you want to delete.

You can continue deleting as many squares as you want. Enter] when you are finished, and you then return to the Edit/Save Page.

Display Page

With this choice, you can display the direct strings and MSTRING names associated with each square. This function is identical to 7.13.6 DISPLAY PAGE, except you need not enter the page name. The page displayed is the page currently being edited. The page is displayed in the area specified by modal 7.13.1.3 PAGE DISPLAY AREA. (Refer to 7.13.6 DISPLAY PAGE for more information.)

After the tablet page grid and strings are displayed, you return to the Edit/Save Page menu.

Save Page and Continue

With this choice, you can save the page on which you are currently working and then continue working. The page is saved in your tablet edit file. By periodically saving the page, you can return to the last version saved if you make an error while editing. (Use 7.13.3 MODIFY PAGE to retrieve the last version saved.)

You receive the following message:

```
editpag SAVED IN editfil
```

You then return to the Edit/Save Page menu.

Save Page and Exit

With this choice, you can save the page on which you are currently working and then exit from the Edit/Save Page menu. You receive the following confirmation message:

```
editpag SAVED IN editfil
```

You then return to 7.13 TABLET MANAGEMENT.

7.13.4 Rename Page

With this selection, you can rename a user page in your edit file.

ENTER USER PAGE TO RENAME

Enter the name of the existing tablet user page that you want to rename.

or

Enter LIST to display a list of user pages in your edit file.

Enter] or [to terminate the rename function and return to 7.13 TABLET MANAGEMENT.

If the page name entered is not in your edit file, you receive the message

userpag IS NOT IN editfil

and you return to the ENTER USER PAGE TO RENAME prompt.

When you successfully enter a user page name, the system asks for the new name:

ENTER NEW NAME FOR USER PAGE

Enter the new name to identify the existing user page (one to seven characters). You cannot use standard page names for new user pages.

or

Enter:

] To return directly to 7.13 TABLET MANAGEMENT without renaming the page.

[To return to the ENTER USER PAGE TO RENAME prompt.

You receive the following message to confirm that the old page name was changed to the new page name.

oldpage RENAMED newpage

You then return to 7.13 TABLET MANAGEMENT.

7.13.4 Rename Page

If the new name you entered already exists, you can overwrite the existing page with the renamed page.

pagname IS ALREADY IN editfil
OVERWRITE?

Enter:

Y To overwrite the existing page with the renamed page. You return to 7.13
TABLET MANAGEMENT.

N To avoid overwriting the existing page.
You return to the ENTER NEW NAME
FOR USER PAGE prompt.

You cannot rename standard pages. However, you can create a user page that is a copy of a standard page and give it another name.

7.13.5 Delete Page

With this selection, you can delete user pages residing on your tablet edit file.

ENTER NAME OF USER PAGE TO DELETE

Enter the user page name that you want to delete from your tablet edit file. Enter LIST to display a list of user pages in your tablet edit file.

or

Enter] or [to terminate the delete function and return to 7.13 TABLET MANAGEMENT.

If the tablet page you entered is not in your tablet edit file, the following prompt is displayed:

pagname IS NOT IN editfil.

You return to the ENTER NAME OF USER PAGE TO DELETE prompt.

You can delete only one user page at one time. If the user page entered is found, a confirmation prompt is displayed.

DELETE pagname?

Enter:

Y To delete the user page named from your tablet edit file.

N To avoid deleting the user page from your tablet edit file.

If you enter Y in response to this prompt, the following confirmation message is displayed:

pagname DELETED FROM editfil.

You cannot delete active tablet pages. If you attempt to delete an active tablet page, the following message is displayed:

pagname IS CURRENTLY ACTIVE.
YOU CANNOT DELETE ACTIVE PAGES.

You return to the ENTER USER PAGE NAME TO DELETE prompt and can enter another user page name that you want to delete.

7.13.6 Display Page

With this choice, you can display the string assignments for each square of a tablet page. Direct strings spanning more than one square are centered to fill the assigned squares. If the complete string cannot be displayed in the square, a greater than symbol (>) is displayed as the last character in the string. MSTRING names are identified by a small box in the lower right corner of the square. On color terminals, MSTRING names are displayed in yellow and direct strings in white. The name of the edit file and page, as well as the time and date, are displayed in a small box adjacent to the page grid. Refer to figure 3-5 for examples of how strings are displayed on the tablet page. The page is displayed in the screen area specified with modal 7.13.13 PAGE DISPLAY AREA.

ENTER NAME OF PAGE TO DISPLAY

Enter the name of the standard or user page you want to display.

or

Enter LIST to display a list of user pages in your tablet edit file.

Enter] or [to return to 7.13 TABLET MANAGEMENT.

If the tablet page you entered is not in your tablet edit file, the following prompt is displayed:

pagname IS NOT IN editfil.

You return to the ENTER NAME OF PAGE TO DISPLAY prompt.

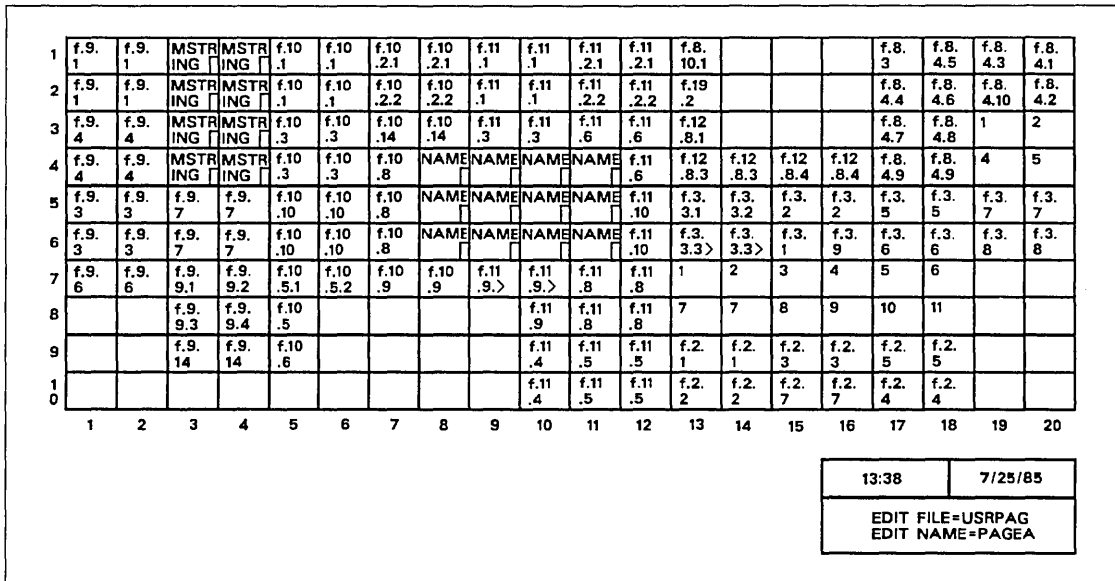

Figure 3-5. Tablet Page with Defined Squares

7.13.7 List Pages in Edit File

This section displays a list of pages stored in your tablet edit file. (Refer to figure 3-6.)

The list displays the following information:

- Tablet edit file name
- Date and time of list
- User page names in the file (listed alphabetically)
- Sheet number
- Number of screens (sheets) in page list

TABLET PAGE LIST		
EDIT FILE=TLIST	7:44	10/23/85
ARCHIVE	CONST	DATA
DESIGN	DESIGNA	DESIGNB
DRAFT	DRAFTA	DRAFTB
JOB100	JOB101	JOB102
JOB103	JOB104	JOB105
JOB106	LOWER	MISC
MOLDPG	NCPAGE	PROTOPG
SPECIAL	TESTPG	TEXT
UDFT	UPPER	WORKPG
		SHEET 1 OF 1

Figure 3-6. User Tablet Page List

If more pages exist than can be displayed on a single screen, the following message is displayed:

CONTINUE?

Enter:

Y To display the next sheet of user pages on your edit file.

N To return to 7.13 TABLET MANAGEMENT.

7.13.8 Change Edit File

With this choice, you can change your tablet edit file. Pages in this new tablet file can be edited by selections from the Edit/Save Page menu.

```
EDIT FILE = editfil  
ENTER NEW EDIT FILE NAME
```

Enter the name of the edit file you want to use. The name above is the name of your current tablet edit file.

Enter] to accept the current edit file.

The confirmation message, EDIT FILE CHANGED TO editfil, is displayed.

If the tablet edit file you entered is not found, the following message is displayed:

```
editfil WAS NOT FOUND  
CREATE PERMANENT FILE editfil?
```

Enter:

Y To create a permanent tablet edit file named editfil.

N To avoid creating a permanent tablet edit file named editfil.

If you create a local tablet edit file, make sure you make this file permanent when you quit your ICEM DDN work session so the work is saved.

NOTE

When you enter ICEM DDN, your tablet edit file and tablet command file are the same file. You can make these files independent with 7.13.1.5.2 DO NOT EQUATE EDIT AND COMMAND FILES. Then, when you change the tablet command file, the tablet edit file does not change, and when you change the tablet edit file, the tablet command file does not change.

7.13.9 Pack Edit File

With this choice, you can eliminate gaps in your tablet edit file created by deleting pages. This function reduces the size of your tablet edit file if you deleted any pages since creating the file.

The following message is displayed:

```
editfil IS BEING PACKED
```

Packing may take more than a minute for large files. After packing, the following confirmation message is displayed:

```
editfil IS NOW PACKED
```

You return to the Tablet Management menu.

7.13.10 Copy Pages from Another File

With this choice, you can copy pages from another tablet file.

ENTER NAME OF FILE TO COPY FROM

Enter the name of the tablet file from which you want to copy a page. If the tablet file name you entered is not available, you receive the message

readfil WAS NOT FOUND

and the prompt is repeated.

If the tablet file from which you want to copy pages does not have copy privileges, the following message is displayed:

readfil DOES NOT HAVE COPY PERMISSION

If you successfully identified a tablet file from which to copy, you are asked for the name of the page you want to copy.

COPYING FROM FILE = readfil
ENTER NAME OF USER PAGE TO COPY

The file name following the = sign (readfil) refers to the file from which pages can be copied.

Enter the name of the user page that you want to copy from readfil.

or

Enter LIST to display a list of pages in readfil. If the user page name entered is not found in readfil, you receive the message:

pagname IS NOT IN readfil

and you return to the ENTER NAME OF USER PAGE TO COPY prompt.

Enter:

] To return to 7.13 TABLET MANAGEMENT.

[To return to the ENTER NAME OF FILE TO COPY FROM prompt.

When you obtain the page to be copied, the system prompts you to enter a name under which to save the copied page in your tablet edit file.

NAME OF COPY PAGE = readpag
ENTER NAME FOR SAVED PAGE

Enter the name under which you want to save the copied page in your edit file.

or

Enter] to accept the name of the page as stored in the copy file. (This is the name following the text, NAME OF COPY PAGE = readpag.)

If the page name you entered (savname) is already in your edit file, you can overwrite the existing page with the copied page.

savname IS ALREADY IN editfil
OVERWRITE?

Enter:

Y To overwrite the existing page on your edit file with the copied page. You receive the message

userpag OVERWRITTEN WITH COPIED PAGE.

N To avoid overwriting the existing page on your edit file. You return to the ENTER NAME FOR SAVED PAGE prompt, at which you may enter a different name for the copied page.

If you have successfully saved a copied user page on your edit file, you receive the message

pagname SAVED IN editfil.

You return to the ENTER NAME OF USER PAGE TO COPY prompt to enter another page that you want to copy.

Tablet String Programming Format

The following paragraphs apply to both text direct and MSTRING file programming.

Commands

A tablet string consists of a series of formatted commands. Acceptable commands include the following:

<u>Command Type</u>	<u>Description</u>
Menu	Responses to questions and menu prompts. Menu commands are required for each menu request within a tablet program.
Text	Data entry and character string responses to prompts such as ENTER NAME. Text commands are optional for each text request.

Unacceptable commands include the following:

Command Type	Description
--------------	-------------

Graphic	Graphics cursor selections such as those in response to such prompts as INDICATE ENTITY.
---------	--

Menu commands are required for each menu input within a tablet program. Text commands can be programmed into the tablet or entered during tablet program execution. Graphic commands can be entered only during tablet program execution.

The menu command format uses the following separators and control characters.

- Periods and tab characters are valid separators for consecutive menu selections. Menu choices not separated by a period or tab character are limited to a single character. For choices 10 through 19, 10 is entered as 0, and 11 through 19 are entered using the following keys:

11 !

12 "

13 #

14 \$

15 %

16 &

17 '

18 (

19)

- Valid control characters are:

CTRL-F or f (Main menu)

CTRL-A or a (Arcs)

CTRL-L or l (Lines)

CTRL-P or p (Points)

CTRL-D or d (Delete last entity)

CTRL-V or v (Other options)

CTRL-U or u (NC editor menu)

All menu strings begin with a CTRL-F or f, followed by the menu choices and separators. For example, if a tablet area is to be programmed to draw a line between two points, the following menu strings would be entered:

l.3 or f.10.3

The text command format uses a separator, as described below.

A t character at the beginning and end of a text or data string separates menu selections from text/data. If two text strings are entered, one immediately after the other, two t characters are required between the text strings.

For example, if a tablet area is to be programmed to define a true position tolerance symbol, the following text string would be entered:

```
f.16.16.1.N.1.tDATUMt.]t]t.]t]t.]
```

The following are descriptions of the symbols in the preceding string:

Symbol	Description
f.16.16	Selects straightness as the geometric characteristic.
N	Indicates that no connection is desired.
tDATUMt	Enters first and only datum.
]	Requests no datum modifier.
t]t	Requests no more data.
]	Requests no tolerance modifier.
t]t	Indicates that operation is complete for tolerance text.
]	Requests no posttolerance modifier.

Coordinates establishing the symbol position are entered by tablet or keyboard.

Y and N responses are menu entries and do not require delimiters.

Variable Menu/Text Entry

Variable menu/text entry allows the use of variable control characters in a string. These variables are undefined until execution of the program. At execution time, prompts are issued for the necessary text or menu input that defines the variable entries.

Acceptable variable control characters are:

- s To substitute input from the keyboard or the tablet (constant). During the first cycle of the repeated portion of a tablet string, you must provide tablet or keyboard input each time s follows r in the string. Then for all subsequent repeats, the input is substituted automatically.
- e To substitute input from the keyboard or the tablet (variable). During all cycles of the repeated portion of a tablet string, you must provide tablet or keyboard input each time e follows r in the string.

The s and e characters have identical functions except when used within the repeated portion of a string.

These variables are substituted for menu/text entries in the string to be defined during execution. Program execution continues following selection of menu/text and entry of a carriage return.

For example, the previous true position symbol string might change to:

```
f.16.16.1.N.s.tst.].t]t.].t]t.]
```

With this string, the geometric characteristic and the datum are left as variables to be defined at execution.

Repeated Menu Sequences

A menu/text entry sequence can be repeated to the end of a current menu string using a repeat control character.

The repeated menu sequence control character (r):

- Allows only one occurrence per string.
- Can be used anywhere in the string.
- Should be positioned at the beginning of the sequence to be repeated.

To terminate a repeated menu sequence, enter [during an input request.

For example, the previous true position symbol string might change to:

```
f.16.16.1.r.1.N.s.tst.].t]t.].t]t.]
```

The repeat character r occurs before the origin mode menu entry. Each time a tolerance symbol is produced, the system returns to the ORIGIN MODE prompt. In this case, the system requests the geometric symbol and datum for the first time only.

NOTE

It is possible to construct a repeated menu sequence that does not require input. A maximum of 10 such repeats is allowed to prevent infinite repetitions.

Tablet String Variables

Menu and text variables can also consist of a menu or text string. Using this capability, a particular tablet square might be programmed to automatically enter a text string that represents a frequently used pattern name or label. Text strings must be delimited by t characters.

For example, suppose a cap screw is a frequently used component created as a pattern named CAP SCREW. Rather than entering the name CAP SCREW every time in response to the prompt KEY IN PATTERN NAME, a tablet with the label CAP SCREW could be programmed using the following tablet string variable:

```
tCAP SCREWt
```

Each time the pattern menu is selected, the prompt KEY IN PATTERN NAME can be answered by selecting the tablet area labeled CAP SCREW.

Embedded Control Characters

The variable control characters e and s can be embedded in a string to allow entry of variable additions to a defined menu/text string.

For example, consider the previous example of the cap screw. Suppose that two different diameter cap screws of varying lengths are used and these combinations are stored as patterns according to the following example:

CAP SCREW DIA X LENGTH

You must supply the diameter and length variables in response to the ENTER PATTERN NAME prompt.

Three tablet squares, one labeled CAP SCREW, one labeled 1/4 inch, and one labeled 1/2 inch could be programmed in the tablet by using the following strings.

Square Label	Assigned String
CAP SCREW	tCSsXst
1/4 inch	t1/4t
1/2 inch	t1/2t

In response to the prompt KEY IN PATTERN NAME, the tablet square labeled CAP SCREW is selected. Then the square with the appropriate diameter label is selected. Finally, the length is entered using the keyboard.

The embedded variable control characters form an effective means of concatenating slightly varying groups of text for use as labels, notes, and pattern names.

NOTE

The embedded s character can be used an infinite number of times anywhere within a pair of t delimiters.

Lowercase Text Entry

Because the system cannot distinguish between the lowercase letters s and t and the control characters s and t, another delimiter is defined to allow lowercase text entry. This delimiter is the tilde character (~) and it deactivates and activates lowercase control characters.

You must use tilde characters in pairs before and after a text string. The text occurring between the tilde characters appears exactly as you enter it, as shown in the following example:

t~This string of lowercase and UPPERCASE will be displayed exactly as it is~t

Embedded Text Entry

The embedded text delimiter (`()`), when used in a text string, displays the text enclosed between lowercase `t` characters in the dialog area of the screen. This is useful for providing prompts within a tablet string.

For example, in the following string, the text "Define Point for Origin" will appear in the screen dialog area.

```
f.9|t~Define Point for Origin~|t.1
```

Summary of Control Characters

Table 3-1 summarizes the control characters according to their function in tablet programming.

Table 3-1. Tablet Programming Control Characters

Character	Description
f	Return to the main menu.
p	Go to 9 POINT.
l	Go to 10 LINE.
a	Go to 11 ARC/CIRCLE/FILLET.
d	Delete the last entity.
v	Display other options.
t	Text delimiter.
s	Substitute constant input from the tablet or keyboard.
e	Substitute variable input from the tablet or keyboard.
r	Repeated menu sequence.
	Embedded text delimiter.
~	Lowercase text delimiter.

NOTE

The tablet programmer is responsible for proper operation of the tablet. Each sequence should be thoroughly tested before being used in production.

Menu 8: Display Control

4

Using Menu 8	4-1
Suggestions for Using This Menu	4-3
Isometric Drafting	4-5
Controlling Drafting Entity Placement in Three-Dimensional Space	4-5
Joint Use of Depth Control and Implicit Points	4-5
Changing Workspace	4-6
Defining New Workspace	4-6
Selective View Blanking	4-6
8.1 Modals	4-6
8.1.1 Depth Entry Mode	4-7
8.1.2 View Selection Mode	4-9
8.1.3 Zoom Origin Mode	4-11
8.1.4 Rescale Entry Mode	4-13
8.1.5 View Border Display	4-14
8.1.6 View Name Display	4-15
8.1.7 Model Axes Display	4-16
8.1.8 Display View Modals	4-17
8.1.9 Work Space Selection Mode	4-18
8.1.10 View Association Mode	4-20
8.1.11 Work Name Display	4-21
8.1.12 Work Axes Display	4-22
8.1.13 View Placement Method	4-22
8.2 Change Depth	4-23
8.3 Display a Single View	4-23
Phase 1 (View Selection)	4-23
Phase 2 (View Display Specification)	4-24
8.4 Display Multiple Views	4-25
8.4.1 Previous Layout	4-25
8.4.2 Enter View Layout Name	4-26
8.4.3 Previous Multi View	4-26
8.4.4 Two Views - Top and Bottom	4-26
Zoom Extent Specification	4-27
8.4.5 Two Views - Left and Right	4-28
8.4.6 Four Quadrants	4-28
8.4.7 Views 6 and 1 (Top/Front)	4-28
8.4.8 Views 1 and 3 (Front/Right)	4-29
8.4.9 Views 6, 1, 3, 8 (Top/Front/Right/Isol)	4-29
8.4.10 Views One Through Eight	4-29
8.4.11 Define Current Display as a Layout	4-30
8.5 Change Work View	4-30

8.6 Zoom	4-31
8.6.1 Return to Base Scale	4-34
8.6.2 New Center	4-34
8.6.3 New Lower Left Corner	4-35
8.6.4 New Center, Enter Scale	4-35
8.6.5 New Corner, Enter Scale	4-35
8.6.6 Double Scale	4-36
8.6.7 Half Scale	4-36
8.6.8 Enter Scale	4-36
8.6.9 Diagonal Screen Positions	4-36
8.6.10 Enter Max-Mins	4-37
8.6.11 Auto Max-Mins	4-37
8.6.12 Redefine Base Scale	4-37
8.6.13 Name a Zoom Scale	4-38
8.6.14 Retrieve Named Scale	4-38
8.6.15 Change Page	4-39
8.6.16 Zoom from Hardcopy	4-40
8.6.17 Change Zoom Mode	4-41
8.7 View Layout Construction	4-42
8.7.1 Modals	4-44
8.7.2 Move Window	4-45
8.7.3 Stretch Window	4-46
Display Generation	4-50
8.7.4 Add View	4-50
8.7.5 Replace View	4-50
8.7.6 Unblank View	4-51
8.7.7 Blank View	4-51
8.7.8 Delete View	4-51
8.7.9 Modify Layout Name	4-51
8.7.10 Copy Under New Name	4-52
8.7.11 Place Format Around Layout	4-53
8.7.12 Align Layout Views	4-55
8.8 Display Name Management	4-59
8.8.1 Name a View	4-59
8.8.2 List Views	4-60
8.8.3 Delete a View	4-61
8.8.4 Rename Saved Zoom Scale	4-62
8.8.5 List Saved Zoom Scales	4-62
8.8.6 Delete Saved Zoom Scale	4-63
8.8.7 Rename a Layout	4-63
8.8.8 List Layouts	4-64
8.8.9 List Views in a Layout	4-64
8.8.10 Delete a View Layout	4-65
8.9 Define Auxiliary View	4-65
Zoom Scale Menu	4-67

8.10 Z-Clip	4-68
8.11 Change Work Space	4-69
8.12 Define Work Space	4-70
8.12.1 Rotations about Axes	4-71
8.12.2 Parallel to Plane	4-71
8.12.3 Enter Matrix	4-72
8.12.4 Through a Point and Perpto a Line	4-72
8.12.5 Through a Point and Along a Line	4-73
8.12.6 Through Three Points	4-73
8.12.7 Through Two Lines	4-73
8.12.8 New Origin	4-74
8.13 Align View/Work Spaces	4-77

Using Menu 8

Display Control allows you to operate the entity and part display controls for single and multiple views, display zoom and z-clip views, modify work views and workspaces, display a layout construction, define an auxiliary view, change a work plane depth, manage entity and part names, and to set display modals.

The menu for this chapter is:

- DISPLAY CONTROL
- 8.1 MODALS
- 8.2 CHANGE DEPTH
- 8.3 DISPLAY A SINGLE VIEW
- 8.4 DISPLAY MULTIPLE VIEWS
- 8.5 CHANGE WORK VIEW
- 8.6 ZOOM
- 8.7 VIEW LAYOUT CONSTRUCTION
- 8.8 DISPLAY NAME MANAGEMENT
- 8.9 DEFINE AUXILIARY VIEW
- 8.10 Z-CLIP
- 8.11 CHANGE WORK SPACE
- 8.12 DEFINE WORK SPACE
- 8.13 ALIGN VIEW/WORK SPACES

The Display Control menu offers these functions:

Menu Title	Function Description
8.1 MODALS	Defines display control modals such as border, model axes, view name, and work name display.
8.2 CHANGE DEPTH	Changes the current depth of the work plane.
8.3 DISPLAY A SINGLE VIEW	Changes the screen display to a single view.
8.4 DISPLAY MULTIPLE VIEWS	Changes the screen display to multiple views.
8.5 CHANGE WORK VIEW	Changes the work view to the current screen display.
8.6 ZOOM	Enlarges or reduces the scale of a specified region of the screen display.
8.7 VIEW LAYOUT CONSTRUCTION	Creates and modifies view layouts. View layouts are views displayed at specified scales in preassigned windows.
8.8 DISPLAY NAME MANAGEMENT	Renames, lists, and deletes view names, work plane names, saved zoom scales, and view layouts.
8.9 DEFINE AUXILIARY VIEW	Creates user-defined (nonstandard) views.

Menu Title	Function Description
8.10 Z-CLIP	Displays a view within a specified zt region.
8.11 CHANGE WORK SPACE	Changes the workspace by associating it with one or more views.
8.12 DEFINE WORKSPACE	Creates a new workspace that can be associated with one or more views.
8.13 ALIGN VIEW/WORKSPACES	Aligns workspace 1 with view 1, workspace 2 with view 2, and so forth.

Suggestions for Using this Menu

You can use this menu to control the way the design is represented on the display device. You can select a single view of the design or display multiple views simultaneously. You can look at the entire design or you can zoom into a specific region of the design.

You can also redefine the workspace. The workspace axes can be reorientated, a new origin can be redefined, and the workspace associated with a view can be changed.

There are two options in display control that can be entered at any time during the system execution. These are 8.2 CHANGE DEPTH and 8.6 ZOOM. These options are explained in the description of the D and Z control keys in the ICEM Design/Drafting Introduction and System Controls manual.

The following definitions give an overview of important terms and concepts used in the display control descriptions.

Term	Description
VIEW	A view is a specific way of looking at a design. Each view has a transform coordinate system associated with it. Mathematically, a view is defined as a three-dimensional rotation of and translation away from the model space view (view 1). Every entity is defined in the coordinate system of a specific transform space. Views can be named (up to 16 characters).
DEPTH	The depth is a preset value for zt that references the workspace associated with a view. Two-dimensional entities (arcs, conics, strings, and two-dimensional splines) are defined in the workspace on the ZT plane determined by the value of depth. Each workspace has its own depth value. Thus, changing views can change the depth, in addition to the workspace.
ZOOM	The zoom scale consists of the magnification and the lower left display origin of a view to be displayed. It is a specified display representation of a part of the design in a specific view.
WINDOW	The window is the rectangular region on the screen in which a view is displayed. If only one view is displayed, the window is the entire screen.
VIEW LAYOUT	A view layout is a configuration of views displayed at specified zoom scales in preassigned windows. Up to 32 views can be displayed in a layout simultaneously.
WORK VIEW	The work view is the displayed view in which screen position input is active. The workspace associated with the work view is the definition transform space used for data input and entity construction.

Term	Description
VIEW MODALS	View modals are characteristics that can be associated with views. For example, you can specify the model space axes, the window border, and the view name that are displayed with specific views or with all displayed views.
GLOBAL ZOOM SCALE	The global zoom scale is the magnification and the region of display of a view layout. Normally, a view layout is displayed without magnification. You can choose, however, to magnify specific regions of the layout for more detailed display.

Display control is designed to give you as much control as possible over the method of data entry. Thus, in selecting a view, you can:

- Enter the view number
- Enter the view name
- Screen select the view
- Select an entity defined in that view

To minimize the number of options, a number of data entry methods, such as view selection, have been placed under modal control. For example, when you choose a way of selecting a view, the system prompts for that view selection method only when a selection is required. To maintain compatibility with previous versions of the system, the default modes are the same as previously required data entry modes. For example, the default mode of view selection is by view number.

These data entry modes can be changed by two different methods: you can enter 8.1 MODALS to change the data entry mode, or you can change the data entry mode when data is requested by entering [in response to the data entry message. Either invokes the data entry mode menu and allows you to change it. To take full advantage of the display control module and the different data entry modes, you should become familiar with the 8.1 MODALS options.

Model space (view 1) is always the original view of the design. Model space values are represented by x, y, and z. Workspace is the coordinate system associated with the current work view and is represented by xt, yt, and zt. Definition space is the workspace in which an entity is defined. The definition space of points, lines, machining curves, surfaces, and toolpaths is always model space. The rule is that an entity not residing in a unique plane is defined in model space. Screen coordinates are the ruled distances along the axis of the display and are represented by x's and y's.

The view layout construction capability formats views on the display as desired. Display name management controls view names, saved zoom scales, and saved view layouts. Auxiliary view definition defines a new view by specifying the line of vision, or by applying rotations to the current work view. Finally, z-clip constrains the display of a view within a zt range.

Isometric Drafting

Isometric Drafting (menu 16:1.17) enables you to utilize the independent workspace feature existing in ICEM Design/Drafting. That is, you can create a drafting entity in a workspace that is not aligned with the current work view in order that the drafting entities created appear appropriately skewed.

For example, you can view a model in a three-dimensional or isometric view but have the front plane as your work plane. Drafting entities created then appear in that plane and are skewed. The work plane and view plane do not need to be aligned. Isometric drafting allows the work plane and view plane to be independent of each other.

To use isometric drafting effectively, you should be familiar with these five Design/Drafting features:

1. Depth control (D command key or 8.1.1 DEPTH ENTRY MODE)
2. Implicit points (1.11.5 IMPLICIT POINT MODALS)
3. Changing workspace (8.11 CHANGE WORK SPACE)
4. Defining a new workspace (8.12 DEFINE WORK SPACE)
5. Selective view blanking (1.10 BLANK/UNBLANK VIEW SELECT)

Controlling Drafting Entity Placement in Three-Dimensional Space

To control drafting entity placement while in isometric drafting, you can do two things. The simplest is to change the depth of the current workspace using the D or Depth command key. This moves you along the zt-axis of the workspace. The second method is to change the workspace itself. Use menu 8.11 CHANGE WORK SPACE to change from front to top, for example. This works for all views created. This operation automatically resets the depth to zero. You must then change the depth to the appropriate value.

Use menu 8.12 DEFINE NEW WORK SPACE when a new workspace is required. You may need to do this for models that have skewed or diagonal lines that do not fall on orthogonal planes. This operation also resets depth to zero.

Joint Use of Depth Control and Implicit Points

The default mode for 8.1.1 DEPTH ENTRY MODE requires that you enter a value for the new depth (1. ENTER DEPTH VALUE). In cases in which you do not know what new depth value to enter, use 2. INDICATE POINT or 3. DELTA FROM A CURVE END. Indicating a point changes the depth to the zt value of that point. This lets you change depth by screen selecting points.

1.11.5 IMPLICIT POINT MODALS can be used to further enhance this capability by automatically defining points at curve ends, middles of curves, and circle centers. Using depth control and implicit points together allows you to screen select curves and points to reset depth.

Changing Workspace

Most isometric drafting is done on the three model axes: front, right, and top. A combination of changing between these three axes and setting correct depth is the most common method for controlling the placement of drafting entities.

Defining New Workspace

You must define a new workspace if you have entities that do not exist on one of the standard eight workspaces automatically defined by the system. Use menu 8.12 DEFINE WORK SPACE.

Selective View Blanking

Selective View Blanking (1.10 BLANK/UNBLANK VIEW SELECT) is the fifth feature you will find helpful. After creating entities with isometric drafting modals on, you can use selective view blanking to manipulate the viewing of these or other entities. If you turn this modal on, you can blank or unblank entities according to their view. If the entities created were set to be displayed only in their view of definition, you can turn the modal off to unblank those entities while viewing them from some other view. If entities created were set to be displayed in all views, you can turn the modal off to blank selected entities while in any view.

The remainder of this chapter describes the choices in menu 8.

8.1 Modals

With this modal, you can define the modals associated with the prompts and menus in display control. Examples of modals associated with display are view border display and model axes display. Examples of modals are the view selection mode and the zoom origin mode.

All system modals have default conditions which remain in effect until you modify them. In addition to controlling the menu option modals described in this section, you can modify some modals during system operation.

The menu for this section is:

1. DEPTH ENTRY MODE
2. VIEW SELECTION MODE
3. ZOOM ORIGIN MODE
4. RESCALE ENTRY MODE
5. VIEW BORDER DISPLAY
6. VIEW NAME DISPLAY
7. MODEL AXES DISPLAY
8. DISPLAY VIEW MODALS
9. WORK SPACE SELECTION MODE
10. VIEW ASSOCIATION MODE
11. WORK NAME DISPLAY
12. WORK AXES DISPLAY
13. VIEW PLACEMENT METHOD

The following sections describe the choices in this menu.

8.1.1 Depth Entry Mode

With this modal, you can control the messages that are displayed when you enter 8.2 CHANGE DEPTH. This modal can be entered by entering the function D key. This modal can be modified in this section, or it can be modified when data is requested as described in 8.2 CHANGE DEPTH. The default depth entry mode is 1.ENTER DEPTH VALUE.

- 1.ENTER DEPTH VALUE
- 2.INDICATE POINT
- 3.DELTA FROM A CURVE END
- 4.USER CHOOSES DEPTH ENTRY MODE

Enter:

- 1 To display the depth prompt for 8.2 CHANGE DEPTH operations. Each workspace has its own preset depth. Changing the work view can change the depth.

DEPTH = Enter the new current depth.

- 2 To display the point prompt for subsequent depth entry operations. After you select the point, the system displays the depth of that part in the current work plane and allows further depth modification.

INDICATE POINT Use the graphics cursor to select a point for the new current depth.

For any point you indicate, the depth is changed to the zt component value of that point. After the point is selected, the system displays the data entry/modify list:

DEPTH = (zt depth of selected point)

This verifies the new depth. Entering] returns you to the last activity. You can adjust the depth at this time. For example, if you want to set the depth 0.25 in (or 0.25 mm) below the depth of the selected point, enter:

#-.25

The # is a special variable representing the preset value on the current line. Entering] returns you to the last activity.

Entering [returns you to 8.1.1 DEPTH ENTRY MODE.

- 3 To display the curve prompt for subsequent depth entry operations. After you select the curve near the desired end, you enter a delta zt value from the depth of the curve end. This is useful when defining the design at different depths which are relative distances from predefined design components.

INDICATE CURVE

Use the graphics cursor to select a curve at the new current depth.

Points can be selected for this function. After you select a curve near a desired end, the system displays:

- 1.DELTA ZT = 0.0
- 2.CURVE DEP = (depth of curve at selected end)

You can modify one of the preceding values, but not both.

If you modify the delta zt, the depth is set to the displayed curve depth added to the entered value for delta zt. System control is returned to the last activity.

If you modify the curve depth, the depth is set to this value and system control is returned to the last activity.

Entering [returns you to 8.1.1 DEPTH ENTRY MODE.

- 4 To display the depth entry prompt for subsequent depth entry operations. You can choose the depth entry mode each time the change depth function is used. This is useful when the desired depth is known and must be changed relative to existing geometry.

DEPTH ENTRY MODE

1. ENTER DEPTH VALUE
2. INDICATE POINT
3. DELTA FROM CURVE END

Select the depth entry mode at the time of execution.

After you select a depth entry mode, control returns to the next higher level of system control.

8.1.2 View Selection Mode

With this modal, you can select a view. Examples include:

- Display a single view (menu 8.3)
- Add a view to the display (menu 8.7.4)
- Stretch a view window (menu 8.7.3)
- Name a view (menu 8.8.1)

The prompts that appear depend on the setting of the view selection mode. This mode can be modified in this section and can also be modified during view selection. To modify the selection mode when data is requested, refer to 8.3 DISPLAY A SINGLE VIEW. The default view selection mode is 1. ENTER VIEW NUMBER. Select the view selection mode.

```
VIEW SELECTION MODE
1. ENTER VIEW NUMBER
2. ENTER VIEW NAME
3. SCREEN SELECT VIEW
4. VIEW OF SELECTED CURVE
5. USER CHOOSES VIEW SELECTION MODE
```

After you choose a view selection mode, the system returns to the next higher level of control, and you choose the view by this method.

Enter:

- 1 To display view number prompts for subsequent view selections. View numbers 1 through 8 are preassigned. Each newly defined view or workspace is given the next higher number, regardless of view deletions. Defined workspaces share in this numbering. A workspace can be treated as a view.

VIEW NUMBER = Enter the view number.

- 2 To display view name prompts for subsequent view selections. Refer to 8.8.1 NAME A VIEW for a description of the view name prompts. The first eight views are given predefined names. Workspaces can also be named and treated as views.

ENTER VIEW NAME Enter the view name (16 characters).

- 3 To display view select prompts for subsequent view selections. If, however, the system requires the selection of a view that is not in the display (as with adding a view to the view layout), the entire view selection menu appears instead.

INDICATE VIEW Use the graphics cursor to select the
new view.

- ~~4~~ To display the curve prompt for subsequent view selections. All lines and type 10 machining curves are defined in view 1 (model space). This is useful if you want to select cross-section views resulting from a plane slice (refer to 15.4 CROSS SECTION SLICE in the ICEM Advanced Design manual) operation or views created by defining two-dimensional planar curves (such as an arc through three points not in a plane of the current view).

INDICATE CURVE

Use the graphics cursor to select a curve that defines the new view.

- 5 To display the view selection mode prompts for subsequent view selections. This view selection mode gives you total control of the method of view selection while displaying this additional menu.

CHOOSE VIEW SELECTION MODE

Select the view at the time of execution.

1. ENTER VIEW NUMBER
2. ENTER VIEW NAME
3. SCREEN SELECT VIEW
4. VIEW OF SELECTED CURVE

8.1.3 Zoom Origin Mode

With this modal, you can control the display of messages when the system requires a lower left corner or center specification during zooming (refer to 8.6 ZOOM). This modal can be modified directly or when data is requested during zoom corner or center entry. To modify the zoom origin mode when data is requested, refer to 8.6.2 NEW CENTER. The default zoom origin mode is 1.INDICATE POSITION.

ZOOM ORIGIN MODE
 1.SCREEN POSITION
 2. ENTER COORDINATES
 3.EXISTING POINT
 4.DELTA FROM CURVE END
 5.MOVE VIEW BY A DELTA
 6.USER CHOOSES ZOOM ORIGIN MODE

Enter:

- 1 To display screen select prompts for the new center or the lower left corner for subsequent zoom origin specifications. This zooming mode is easy to use, but constrains the specification of origin within the current display.

INDICATE NEW SCREEN CENTER

Use the graphics cursor to select the new center or lower left corner.

or

INDICATE NEW SCREEN
 LOWER LEFT CORNER

- 2 To display key in prompts for the new center or the lower left corner for subsequent zoom origin specifications. This is useful if you know the transform coordinates of the view to be displayed.

1.XT CENTER =
 2.YT CENTER =

Enter the transform coordinates of the new center or lower left corner.

1.XT CORNER =
 2.YT CORNER =

- 3 To display existing point prompts for subsequent zoom origin specifications. This is useful when you want the display to be centered upon, or based upon, a reference point in the system data base.

INDICATE POINT

Use the graphics cursor to select an existing point for the new zoom origin.

- 4 To display curve prompts for subsequent zoom origin specifications. This option offers flexibility in origin specification. For example, you can specify that the lower left of the display is to be 1 inch below and 2 inches to the left of the design.

INDICATE CURVE

Use the graphics cursor to select an existing curve for the new zoom origin.

8.1.3 Zoom Origin Mode

- 5 To display the delta coordinate prompt for subsequent zoom origin specifications. With this choice, you can change the view by moving it by a delta in the display.

1.DELTA XT = 0.0
2.DELTA YT = 0.0

Enter the delta coordinates of the new zoom origin.

- 6 To display the Zoom Origin menu for subsequent zoom origin specifications. The zoom origin mode gives you total control of the origin specification method while displaying this additional menu.

CHOOSE ZOOM ORIGIN MODE
1.INDICATE POSITION
2. ENTER COORDINATES
3.EXISTING POINT
4.DELTA FROM CURVE END
5.MOVE VIEW BY A DELTA

Select the new origin at the time of execution.

8.1.4 Rescale Entry Mode

With this modal, you can control what message is displayed when you specify a zoom scale. The system prompts you to enter a zoom scale when zooming (refer to 8.6.8 ENTER SCALE) and when changing views [refer to 8.3 DISPLAY A SINGLE VIEW, phase 2 (View Display Specification), choice number 3. ENTER SCALE]. The default rescale entry mode is 1.SCALE AND RATIO.

```

RESCALE ENTRY MODE
1.SCALE AND RATIO
2.SCALE
3.RATIO

```

Enter:

- 1 To display the scale and ratio prompts for subsequent zoom scale specification. You can modify one, but not both, of these values in specifying the zoom scale.

```

1.SCALE = (current zoom scale)      Enter the new scale or ratio.
2.RATIO = 1.0

```

- 2 To display the scale prompt for subsequent zoom scale specification.

```

SCALE =                               Enter the new scaling factor.

```

- 3 To display the ratio prompt for subsequent zoom scale specification. The new scale is the current scale times the ratio entered.

```

RATIO = 1.0                            Enter the new ratio.

```

8.1.5 View Border Display

With this modal, you can control the display of the rectangular borders around view windows. View borders can be used to differentiate views during 8.7 VIEW LAYOUT CONSTRUCTION and during multiple view display. Whenever a view is selected, attention is brought to the border of that view.

VIEW BORDER DISPLAY MODE

- 1.DO NOT EVER DISPLAY
- 2.DISPLAY IN SOME VIEWS
- 3.DISPLAY IN ALL VIEWS

Enter:

- 1 To inhibit the display of view borders in any view window.
- 2 To display view borders only in specified view windows. The system remembers which views have been selected for border display and continues to display the borders for these views.

VIEW NUMBER =

Enter a view number. Refer to 8.1.2 VIEW SELECTION MODE for a description of the view selection procedure. Enter] to return to 8.1 MODALS.

After you have selected the view, the system displays:

TURN VIEW BORDER DISPLAY ON?

Enter Y to change the status of the border display and return to 8.1.5 VIEW BORDER DISPLAY.

or

TURN VIEW BORDER DISPLAY OFF?

- 3 To display view borders in all view windows. After the borders are displayed, the system returns you to 8.1 MODALS.

8.1.6 View Name Display

With this modal, you can control the display of the view name in the upper left corner of the view window.

VIEW NAME DISPLAY MODE
1.DO NOT EVER DISPLAY
2.DISPLAY IN SOME VIEWS
3.DISPLAY IN ALL VIEWS

Enter:

- 1 To inhibit the display of view names in any view window. You return to 8.1 MODALS.
- 2 To display view names only in specified view windows. The system remembers which views have been selected for name display and displays the names for these views.

VIEW NUMBER =

Enter a view number. Refer to 8.1.2 VIEW SELECTION MODE for a description of the view selection procedure. Enter] to return to 8.1 MODALS.

After you have selected the view, the system displays:

TURN VIEW NAME DISPLAY ON?

Enter Y to change the status of the name display and return to 8.1 MODALS.

or

TURN VIEW NAME DISPLAY OFF?

- 3 To display view names in all view windows. After view names are displayed, you return to 8.1 MODALS.

8.1.7 Model Axes Display

With this modal, you can control the display of the model space coordinate axis in the lower left corner of the view window.

MODEL AXES DISPLAY MODE
1.DO NOT EVER DISPLAY
2.DISPLAY IN SOME VIEWS
3.DISPLAY IN ALL VIEWS

Enter:

- 1 To inhibit the display of a model axis in any view window. You return to 8.1 MODALS.
- 2 To display a model axis only in specified view windows. The system remembers which views have been selected for axis display and displays the axes for these views.

VIEW NUMBER =

Enter a view number. Refer to 8.1.2 VIEW SELECTION MODE for a description of the view selection procedure. Enter] to return to 8.1 MODALS.

After you have selected the view, the system displays:

TURN MODEL AXES DISPLAY ON?

Enter Y to change the status of model axis display and return to 8.1.7 MODEL AXES DISPLAY.

or

TURN MODEL AXES DISPLAY OFF?

- 3 To display model axes in all view windows. After the model axes are displayed, you return to 8.1 MODALS.

8.1.8 Display View Modals

With this modal, you can display the current settings of the view modals.

For example:

```
DV VIEW MODALS
 1.ZOOM SCALE: 1.0000
 2.WORK VIEW NUMBER: 2
 3.WORK VIEW NAME: BOTTOM
 4.NUMBER OF DEFINED VIEWS: 8
 5.DEPTH ENTRY: ENTER VALUE
 6.VIEW SELECTION: VIEW NUMBER
 7.ZOOM ORIGIN: INDICATE POSITION
 8.RESCALE ENTRY: SCALE AND RATIO
 9.VIEW BORDER DISPLAY: NO DISPLAY
10.VIEW NAME DISPLAY: ALL VIEWS
11.MODEL AXES DISPLAY: NO DISPLAY
12.VIEW CENTERING: RECAL. MAX-MINS
13.CURRENT ZOOM: SINGLE VIEW
14.WORK SPACE NUMBER: 8
15.WORK SPACE NAME: ISO 1
16.WORK SPACE SELECTION: SPACE NUMBER
17.VIEW ASSOCIATION: ALL VIEWS
18.WORK NAME DISPLAY: SOME VIEWS
19.WORK AXES DISPLAY: NO DISPLAY
```

Enter] to return to 8.1 MODALS.

8.1.9 Work Space Selection Mode

With this modal, you can preselect one of the modes of workspace selection. Every prompt for workspace selection follows what you preselect.

```
WORK SPACE SELECTION MODE
1. ENTER SPACE NUMBER
2. ENTER SPACE NAME
3. SCREEN SELECT SPACE
4. SPACE OF SELECTED CURVE
5. WORK VIEW SPACE
6. SPACE OF VIEW
7. USER CHOOSES SPACE SELECTION MODE
```

This modal is unlike 8.1.2 VIEW SELECTION MODE in that entering [to any of the selection prompts does not dynamically bring up this menu and allow the choice to be set. This modal can only be set from this point. The default mode is 1. ENTER SPACE NUMBER.

When the system requires the selection of a workspace, it displays:

```
SELECT WORK SPACE
```

and prompts according to the space selection mode.

Enter:

- 1 To request a workspace or view by number.

```
SPACE NUMBER =                Enter the workspace number.
```

If no view or workspace with the entered number is defined, the system displays:

```
WORK SPACE (number) NOT DEFINED
```

You return to the space number prompt.

- 2 To request a workspace or view name.

```
ENTER SPACE NAME                Enter the workspace name.
```

If no view or workspace with the entered name is defined, the system displays:

```
WORK SPACE (name) NOT DEFINED
```

You return to the ENTER SPACE NAME prompt.

- 3 To request a workspace or view by view window. The workspace is that of the indicated view window.

```
INDICATE VIEW                    Select a view window.
```

- 4 To request a workspace or view by entity. The workspace is that of the indicated entity.

INDICATE CURVE

Select an entity.

After an entity is selected, the system displays:

CURVE SPACE = (workspace number)

Enter a new workspace number. Enter]
to return to 8.1.9 WORK SPACE
SELECTION MODE.

Selectable entities for this operation include point, line, arc, conic, two-dimensional spline, vector, point set, string, linear dimension, circular dimension, general label, diameter dimension, angular dimension, general note, centerline, section lining, and true position symbol. A point, line, machining curve, toolpaths, and surfaces are treated as if they were defined in model space.

- 5 To operate with the workspace associated with the current work view. When the system makes this automatic selection, it displays:

WORK VIEW SPACE (number and name) SELECTED

- 6 To select a workspace or view using 8.1.2 VIEW SELECTION MODE. The workspace is set to the actual view space.

- 7 To select the workspace or view at the time of execution. The system displays:

CHOOSE SPACE SELECTION MODE

Select a space selection mode.

- 1. ENTER SPACE NUMBER
- 2. ENTER SPACE NAME
- 3. SCREEN SELECT SPACE
- 4. SPACE OF SELECTED CURVE
- 5. WORK VIEW SPACE
- 6. SPACE OF VIEW

8.1.10 View Association Mode

With this modal, you can preselect one of the modes of view association. Every prompt for view association follows what you preselect.

```
VIEW ASSOCIATION MODE
1.ALL VIEWS
2.SINGLE SELECT VIEW
3.WORK VIEW
4.USER CHOOSES VIEW ASSOCIATION MODE
```

This modal is unlike 8.1.2 VIEW SELECTION MODE in that entering [to any of the selection prompts does not dynamically bring up this menu and allow the choice to be set. This modal can only be set from this point. The default mode is 1.ALL VIEWS.

When the system requires the selection of views for association, it displays:

```
SELECT ASSOCIATED VIEWS
```

and prompts according to the view association mode.

Enter:

- 1 To associate all current and future views with this workspace. When the system makes this automatic selection, it displays:

```
ASSOCIATED WITH ALL CURRENT AND FUTURE VIEWS
```

When this choice is changed to some other setting or when views are aligned with workspaces (refer to 8.13 ALIGN VIEW/WORKSPACES), any subsequently defined view is not associated with the current workspace, but is aligned with itself.

- 2 To associate the view selected using 8.1.2 VIEW SELECTION MODE. View selection continues until you enter].
- 3 To associate the current work view with the workspace. When the system makes this automatic selection, it displays:

```
ASSOCIATED WITH WORK VIEW
```

- 4 To select the view association mode. The system displays:

```
CHOOSE VIEW ASSOCIATION MODE          Select the view association mode.
1.ALL VIEWS
2.SINGLE SELECT VIEW
3.WORK VIEW
```

8.1.11 Work Name Display

With this modal, you can control the display of the workspace name in the upper right corner of a view window. The default mode is 1.DO NOT EVER DISPLAY.

```
WORK NAME DISPLAY
1.DO NOT EVER DISPLAY
2.DISPLAY IN SOME VIEWS
3.DISPLAY IN ALL VIEWS
```

Enter:

- 1 To inhibit the display of work names in any view window. You return to 8.1 MODALS.
- 2 To display work names only in specified view windows. The system remembers which views have been selected for name display and displays names for these views.

```
VIEW NUMBER =          Select a view by name, number, or
                        screen selection. Enter ] to return to the
                        next higher level of system control.

ENTER VIEW NAME

INDICATE VIEW

INDICATE CURVE
```

After you have selected the view, the system displays:

```
TURN WORK NAME DISPLAY ON?      Enter Y to change the status of the
                                work name display mode. You return to
                                the view select prompt.
                                or
TURN WORK NAME DISPLAY OFF?
```

- 3 To display work names in all view windows. After work names are displayed, you return to 8.1 MODALS.

8.1.12 Work Axes Display

With this modal, you can control the display of the workspace axes in the lower right corner of a view window. The default mode is 1.DO NOT EVER DISPLAY.

WORK AXES DISPLAY
1.DO NOT EVER DISPLAY
2.DISPLAY IN SOME VIEWS
3.DISPLAY IN ALL VIEWS

Enter:

- 1 To inhibit the display of a work axis in any view window. You return to 8.1 MODALS.
- 2 To display a work axis only in specified view windows. The system remembers which views have been selected for axis display and displays axes for these views.

VIEW NUMBER =

Select a view by name, number, or screen selection. Enter] to return to the next higher level of system control.

ENTER VIEW NAME

INDICATE VIEW

INDICATE CURVE

After you have selected the view, the system displays:

TURN WORK AXES DISPLAY ON?

Enter Y to change the status of the work axes display mode. You return to the view select prompt.

or

TURN WORK AXES DISPLAY OFF?

- 3 To display the work axes in all view windows. After work axes are displayed, you return to 8.1 MODALS.

8.1.13 View Placement Method

With this modal, you may choose the projection method by which multiple views are displayed on the screen.

VIEW PLACEMENT METHOD
1.ISO A - THIRD ANGLE PROJECTION
2.ISO E - FIRST ANGLE PROJECTION

Select the desired projection method. This modal is set to ISO A - THIRD ANGLE PROJECTION for all drafting standards except DIN (German drafting standards).

8.2 Change Depth

With this choice, you can change the current depth (zt) of the work plane. You can enter this function by menus, tablet, or function D key. Unless otherwise specified, this is the zt component value given to the screen positions that are entered. The zt value for entered data is preset to the last depth specified.

The depth is an XT-YT plane in the workspace which is associated with the workspace. If you change the work view or display a different view, the depth value is set to the current depth of that workspace. All views have the preassigned depth of 0.

DEPTH = Enter the new current depth of the work plane. Refer to 8.1.1 DEPTH ENTRY MODE for a description of the depth selection procedure.

After you modify this view, the system returns you to your last activity.

8.3 Display a Single View

With this choice, you can change the display configuration to a single view. You have control of the method of view selection as well as the scale with which a view is to be displayed.

Phase 1 (View Selection)

Enter the view number to specify the method of view selection.

VIEW NUMBER = Enter the view number. Refer to 8.1.2 VIEW SELECTION MODE for a description of the view number selection procedure.

After you select a legal view, continue to Phase 2 (View Display Specification).

Because a view and a work plane are interchangeable, the numbering and naming of views also applies to work planes. The number or name of a work plane can be entered in response to the view number/name prompt, even if that plane has never been viewed.

Phase 2 (View Display Specification)

After you select the view, the system displays:

- ZOOM EXTENT FOR VIEW DISPLAY
- 1. LAST SCALE USED
- 2. BASE SCALE
- 3. SAVED SCALE
- 4. ENTER SCALE
- 5. AUTOMATICALLY MAXIMIZED

Enter:

- 1 To use the last scale. The system displays the selected view at the scale last displayed and you return to 8 DISPLAY CONTROL. The last scale used can be the scale of a view previously displayed in a view layout. With this function, compensation is made for the shrinkage necessary to display a view in a layout window. Thus, the design appears in the full display much as it did in a view layout window.
- 2 To use the base scale. The system displays the selected view at its last specified base scale and you return to 8 DISPLAY CONTROL. The base scale can be modified when the view is displayed (refer to 8.6.12 REDEFINE BASE SCALE)
- 3 To use a previously saved scale.

ENTER ZOOM SCALE NAME

Enter the name of a saved zoom scale for the selected view. The system uses the saved scale specified for display of the view and returns you to 8 DISPLAY CONTROL.

- 4 To enter a scale.

- 1. SCALE = (current zoom scale)
- 2. RATIO = 1.0

Enter one, but not both, of these values. If the scale is modified, this is the zoom scale of the new view. If the ratio is modified, the zoom scale is the displayed scale times the ratio entered. Entering a ratio can be used to establish a new scale relative to the current scale. For example, if 4.0 is entered, the new scale is four times the current scale.

The system displays the view at the specified scale and returns you to 8 DISPLAY CONTROL.

- 5 To automatically maximize the scale. The system displays the entire view on the screen. All entities that are current candidates for display are checked for minimum and maximum viewspace x_t and y_t range to maximize the display size. After this maximum view is displayed, you return to 8 DISPLAY CONTROL.

8.4 Display Multiple Views

With this choice, you can change the display configuration to multiple views. You can explicitly specify the views to be displayed, or display a view layout that has previously been defined. The ability to display and zoom multiple views (refer to 8.6 ZOOM) includes powerful three-dimensional design tools.

When you display multiple views, the work view remains unchanged from the previous display if it is in the new display. If the previous work view is not in the new display, the new work view is the upper left view.

The menu for this section is:

```

MULTIPLE VIEW DISPLAY FORM
1.PREVIOUS LAYOUT
2.ENTER VIEW LAYOUT NAME
3.PREVIOUS MULTI VIEW
4.TWO VIEWS - TOP AND BOTTOM
5.TWO VIEWS - LEFT AND RIGHT
6.FOUR QUADRANTS
7.VIEWS 6 AND 1 (TOP/FRONT)
8.VIEWS 1 AND 3 (FRONT/RIGHT)
9.VIEWS 6, 1, 3, 8 (TOP/FRONT/RIGHT/ISO1)
10.VIEWS ONE THROUGH EIGHT
11.DEFINE CURRENT DISPLAY AS A LAYOUT

```

The following sections describe the choices in this menu.

8.4.1 Previous Layout

With this choice, you can redisplay the view layout most recently displayed. A simple multiple view configuration is not defined as a layout unless you specify it to be a layout. View layouts are defined using 8.4.11 DEFINE CURRENT DISPLAY AS A LAYOUT and 8.7 VIEW LAYOUT CONSTRUCTION. View layouts can be modified using 8.7 VIEW LAYOUT CONSTRUCTION.

If you have not defined any layouts for the current part, the system displays:

```
NO LAYOUTS HAVE BEEN DEFINED
```

and you return to 8.4 DISPLAY MULTIPLE VIEWS.

If the previously displayed layout has been deleted (refer to 8.8.10 DELETE A VIEW LAYOUT), the system displays:

```
THIS LAYOUT WAS DELETED
```

If there has been no deletion, the system redisplay this layout and returns you to 8.4 DISPLAY MULTIPLE VIEWS.

8.4.2 Enter View Layout Name

With this choice, you can specify the view layout to be displayed. View layouts are defined using 8.4.11 DEFINE CURRENT DISPLAY AS A LAYOUT and 8.7 VIEW LAYOUT CONSTRUCTION. View layouts are selected by names which can be up to 32 characters long.

When at least one layout has been defined, the system displays:

```
ENTER VIEW LAYOUT NAME          Enter the name of an existing view layout.
                                (To list view layouts, refer to 8.8.8 LIST
                                LAYOUTS.)
```

If no layout was found with the name entered, the system displays:

```
NO SUCH VIEW LAYOUT HAS BEEN DEFINED
```

If the view layout exists, the system redisplay this layout and returns you to 8.4 DISPLAY MULTIPLE VIEWS.

8.4.3 Previous Multi View

With this choice, you can redisplay the multiple view configuration that was most recently displayed. This operation applies only to the system-defined configurations defined by menus 8.4.4 TWO VIEWS - TOP AND BOTTOM through 8.4.10 VIEWS ONE THROUGH EIGHT; it does not apply to other user-defined configurations. If you have never entered multiple views, the system displays:

```
MULTIPLE VIEWS HAVE NEVER BEEN DISPLAYED BEFORE
```

After redisplaying the multiple view, the system returns you to 8.4 DISPLAY MULTIPLE VIEWS.

8.4.4 Two Views – Top and Bottom

With this choice, you can select one view to occupy the top half and another view to occupy the bottom half of the screen.

```
SELECT TOP VIEW                  Enter the view number. Refer to 8.1.2
                                VIEW SELECTION MODE for a description
VIEW NUMBER =                    of the view number selection procedure.
```

After the top view has been selected, the system displays:

```
SELECT BOTTOM VIEW               Enter the view number. Refer to 8.1.2
                                VIEW SELECTION MODE for a description
VIEW NUMBER =                    of the view number selection procedure.
```

Zoom Extent Specification

After you have specified the views to be displayed, the system displays:

- MULTI VIEW ZOOM
- 1.LAST SCALE USED
 - 2.BASE SCALE
 - 3.SAVED SCALE
 - 4.ENTER SCALE
 - 5.AUTOMATICALLY MAXIMIZED

You specify the zoom scale desired for the views to be displayed. All views are displayed at the same scale. If the entire design can fit in the view window, that view is centered in the window. If only part of the design can fit in the window, the system attempts to include the upper view space area of the current work view in the new window. Views orthogonal to each other are aligned. For example, if the current work view is view 1 and you choose to display views 1 through 4, views 2 and 3 are aligned with view 1 in the new display.

Enter:

- 1 To use the last scale. The system displays the selected views at the scale of the view last displayed and you return to 8.4 DISPLAY MULTIPLE VIEWS.
- 2 To use the base scale. The system displays the selected views at the base scale of the view last displayed and you return to 8.4 DISPLAY MULTIPLE VIEWS.
- 3 To use a previously saved scale.

ENTER ZOOM SCALE NAME

Enter the name of a saved zoom scale for the current work view. The system uses the named scale to display the selected views and you return to 8.4 DISPLAY MULTIPLE VIEWS.

- 4 To enter a scale.

- 1.SCALE = (current zoom scale)
- 2.RATIO = 1.0

Enter one, but not both, of these values. If the scale is modified, this is the zoom scale of the new view. If the ratio is modified, the zoom scale is the current scale of the work view times the ratio entered. Entering a ratio can be used to establish a new scale relative to the current scale. For example, if 4.0 is entered, the new scale is 4 times the current scale.

The system displays the selected views at the specified scale and you return to the next higher level of system control.

- 5 To automatically maximize the scale. The system displays the views at the largest scale possible while maintaining the entire design completely within each view window. After these views are displayed, you return to 8.4 DISPLAY MULTIPLE VIEWS.

8.4.5 Two Views – Left and Right

With this choice, you can specify which views will occupy the left and right sides of a two-sided display.

SELECT LEFT VIEW

Enter the view number. Refer to 8.1.2
VIEW SELECTION MODE for a description
of the view number selection procedure.

VIEW NUMBER =

After the left view has been selected, the system displays:

SELECT RIGHT VIEW

Enter the view number. Refer to 8.1.2
VIEW SELECTION MODE for a description
of the view number selection procedure.

VIEW NUMBER =

Entering [returns you to the SELECT LEFT VIEW prompt.

After the right view has been selected, the system displays the zoom scale menu described at the end of 8.4.4 TWO VIEWS - TOP AND BOTTOM. The views are then displayed and you return to 8.4 DISPLAY MULTIPLE VIEWS.

8.4.6 Four Quadrants

With this choice, you can display four specified views in four quadrants of the display. The views are referenced to the display's center (upper left, upper right, and so on).

SELECT UPPER LEFT VIEW

Enter the view number. Refer to 8.1.2
VIEW SELECTION MODE for a description
of the view number selection procedure.

VIEW NUMBER =

This is repeated for the other three views with the messages:

SELECT LOWER LEFT VIEW

SELECT UPPER RIGHT VIEW

SELECT LOWER RIGHT VIEW

and with the same options given for the first view selection.

After the lower right view has been selected, the system displays the zoom scale menu described at the end of 8.4.4 TWO VIEWS - TOP AND BOTTOM. The views are then displayed and you return to 8.4 DISPLAY MULTIPLE VIEWS.

8.4.7 Views 6 and 1 (Top/Front)

With this choice, you can display view 6 in the top and view 1 in the bottom of the display. Since no view selection is required, the system displays the zoom scale menu described at the end of 8.4.4 TWO VIEWS - TOP AND BOTTOM. The views are then displayed and you return to 8.4 DISPLAY MULTIPLE VIEWS.

8.4.8 Views 1 and 3 (Front/Right)

With this choice, you can display view 1 on the left side and view 3 on the right side of the display. Since no view selection is required, the system displays the zoom scale menu described at the end of 8.4.4 TWO VIEWS - TOP AND BOTTOM. The views are then displayed and you return to 8.4 DISPLAY MULTIPLE VIEWS.

8.4.9 Views 6, 1, 3, 8 (Top/Front/Right/Isol)

With this choice, you can display the top, front, right, and isometric views in the four quadrants of the display. View 6 is in the upper left quadrant, view 1 is in the lower left, view 8 in the upper right, and view 3 in the lower right. Since no view selection is required, the system displays the zoom scale menu described at the end of 8.4.4 TWO VIEWS - TOP AND BOTTOM. The views are then displayed and you return to 8.4 DISPLAY MULTIPLE VIEWS.

8.4.10 Views One through Eight

With this choice, you can display the first eight predefined views in preassigned areas of the display. Since no view selection is required, the system displays the zoom scale menu described at the end of 8.4.4 TWO VIEWS - TOP AND BOTTOM. The views are then displayed and you return to 8.4 DISPLAY MULTIPLE VIEWS. Refer figure 4-1 for standard view examples.

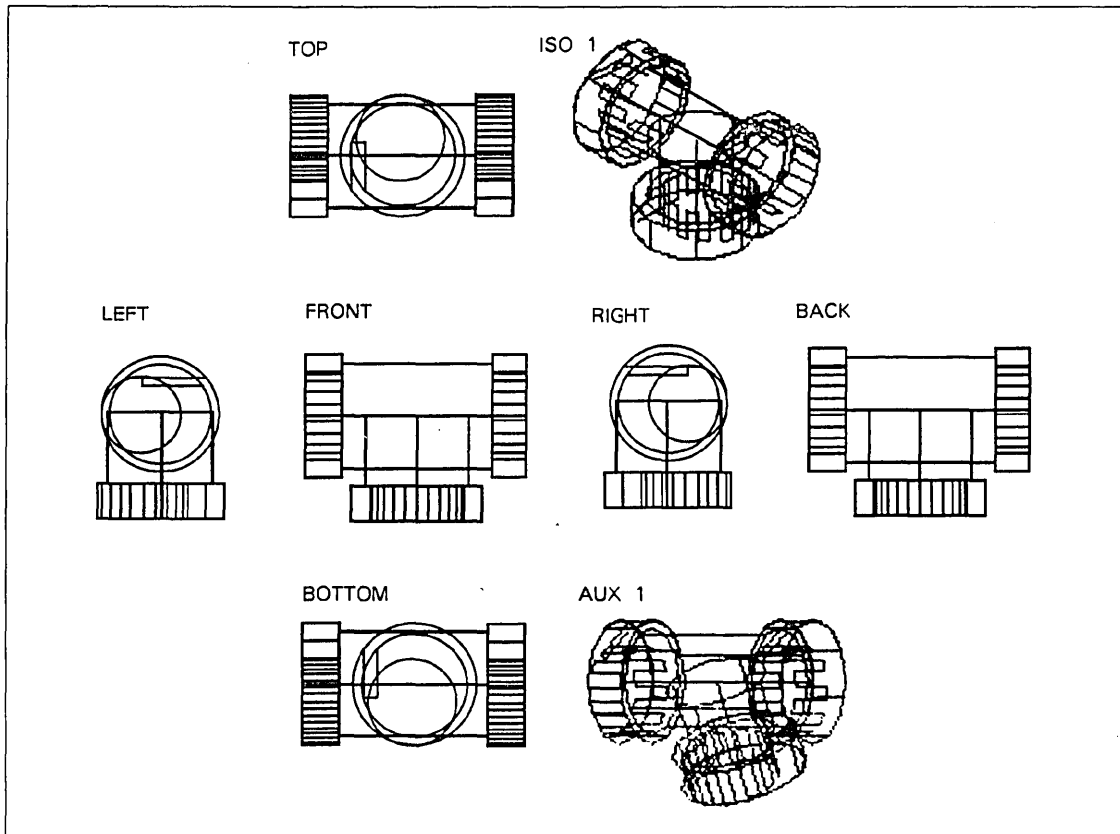

Figure 4-1. Eight Standard Views with Names

8.4.11 Define Current Display as a Layout

With this choice, you can name the currently displayed configuration of views as a view layout. You can later return to this display through 8.4.1 PREVIOUS LAYOUT and 8.4.2 ENTER VIEW LAYOUT NAME.

ENTER VIEW LAYOUT NAME Enter a view layout name (up to 32 characters long).

After this operation, the system returns you to 8.4 DISPLAY MULTIPLE VIEWS.

The current display configuration is saved under the layout name entered and you return to 8.4 DISPLAY MULTIPLE VIEWS. If a view layout with this name already exists, the system displays:

A LAYOUT ALREADY HAS THIS NAME

The system then returns you to 8.4 DISPLAY MULTIPLE VIEWS.

8.5 Change Work View

With this choice, you can change the view in which screen position input is active. Changing the work view can also change the workspace used for input of transform coordinates. The workspace associated with the new work view comes into use. The depth value of the new workspace determines the plane on which two-dimensional entities are to be constructed. The work view must be in the current display.

If there is currently only one view in the display, the system displays:

THIS VIEW IS ALREADY THE Indicate the curve whose plane will be the
WORK VIEW INDICATE CURVE new work view.

The system then returns you to 8.4 DISPLAY MULTIPLE VIEWS.

If you change the work view (either explicitly or by changing views) and the new work view associated with a workspace forces the work plane to be perpendicular to the screen, the system displays:

YOUR WORK PLANE IS PERPENDICULAR TO THE SCREEN, ACKNOWLEDGE

Refer to 8.11 CHANGE WORK SPACE.

If there are multiple views in the current display, the system brings attention to the current work view and asks for the new work view.

WORK VIEW IS (current number) SELECT ANOTHER

Enter the new work view number.

VIEW NUMBER = Enter the view number. Refer to 8.1.2
VIEW SELECTION MODE for a description
of the view number selection procedure.

After you select a view number, the system displays the specified view and returns you to 8.4 DISPLAY MULTIPLE VIEWS.

8.6 Zoom

With this choice, you can specify the region and scale for the display of a design. You can zoom into any desired detail or view the entire layout. Many options are available for specifying which area of a design is to be displayed. To facilitate automatic zooming, you can name any zoom scale and return to it by name. You can enter this choice by the menus, by tablet, or with the function Z key. The zoom menu can be entered at any time from any other menu. At the completion of zoom operations, you return to the last menu.

The same zoom menu can be used for single or multiple view display. To give you full control over the display, a zoom modal can be set when working in multiple views (refer to 8.6.17 CHANGE ZOOM MODE). The heading at the top of the zoom menu indicates the current zoom mode. When you display a single view, the heading is always ZOOM SINGLE VIEW. When multiple views are displayed, one of the following headings is present:

ZOOM WORK VIEW

ZOOM ALL VIEWS

ZOOM SELECTED VIEWS

ZOOM ENTIRE LAYOUT

A multiview display before zooming is shown in figure 4-2.

When multiple views are displayed and the zoom mode is set to WORK VIEW, the zoom operation is performed only on the current work view (refer to figure 4-3).

When the zoom mode is set to ALL VIEWS, the zoom operation affects all the views currently displayed (refer to figure 4-4).

When the zoom mode is set to ENTIRE LAYOUT, the windows are scaled according to your command (refer to figure 4-5).

Although the zoom menu is the same for all zoom modes, all options are not available for all zoom modes. If a zooming operation is selected that is invalid for the current zoom mode, the CHANGE ZOOM MODE prompt appears. When displaying multiple views, the default zoom mode is ALL VIEWS.

Each view and layout has a base scale associated with it. The base scale of a view or layout is initially the scale, position, and other characteristics defined when the view or layout was created. The base scale can be changed directly (refer to 8.6.12 REDEFINE BASE SCALE) or indirectly by adding a view to a layout which redefines the base scale to include the new view in the display. The zoom menu is designed so that temporary changes can be made to the display while still allowing you to return to the previous display with its base scale.

NOTE

Changes made in the zoom menu are temporary, unless you request that the base scale be redefined.

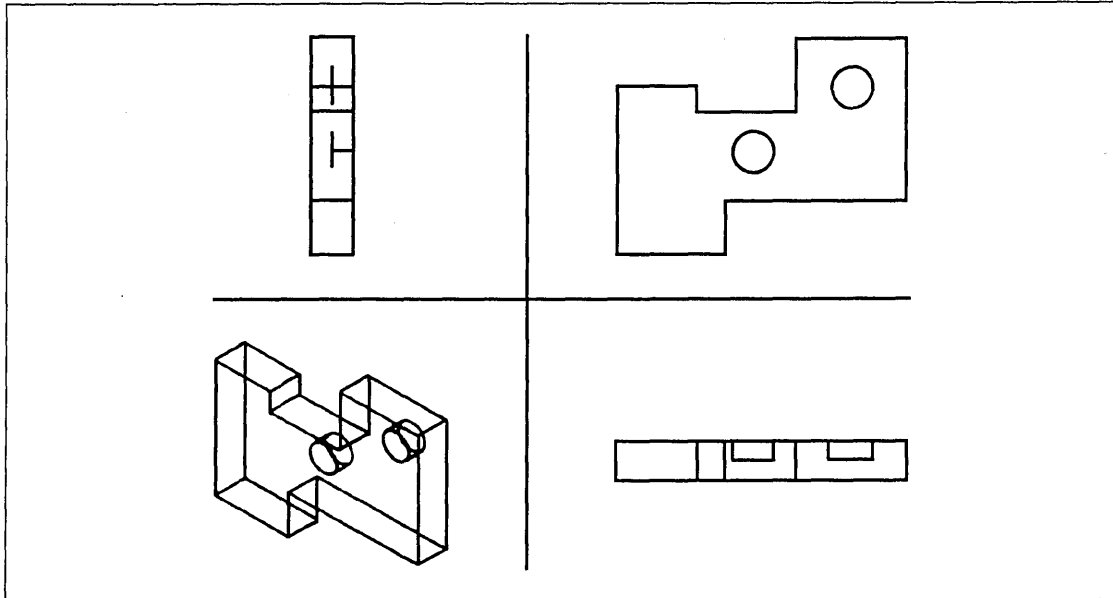

Figure 4-2. Before Zooming

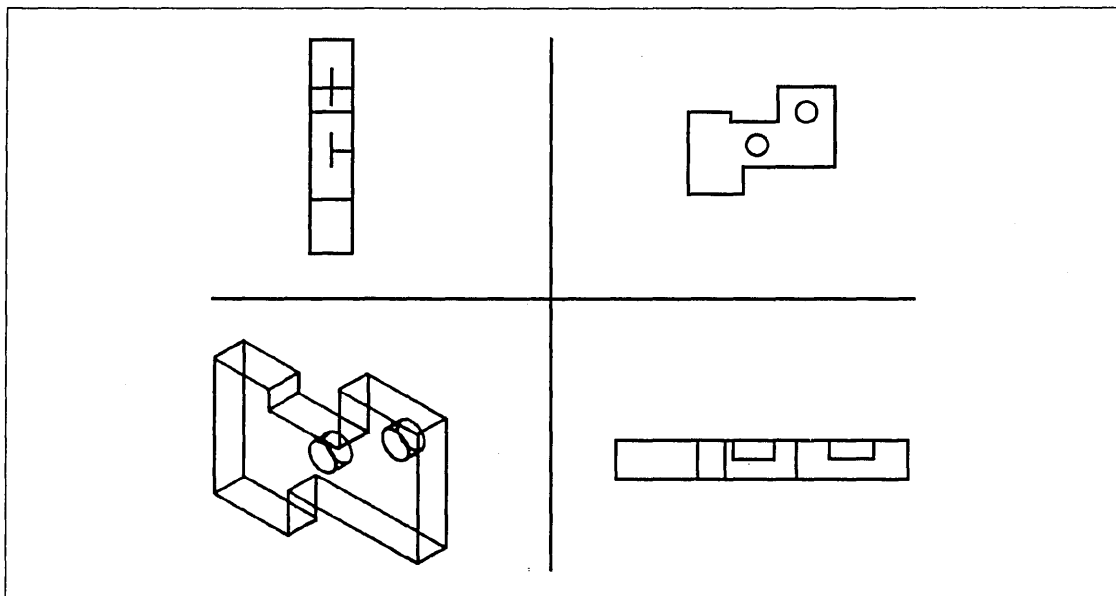

Figure 4-3. Zoom Work View (1/2 Scale)

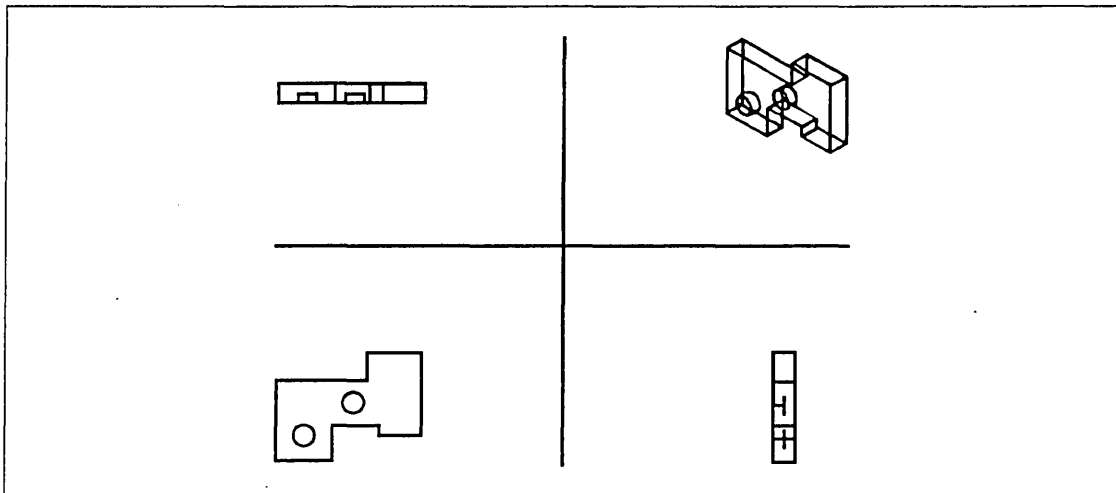

Figure 4-4. Zoom All Views (1/2 Scale)

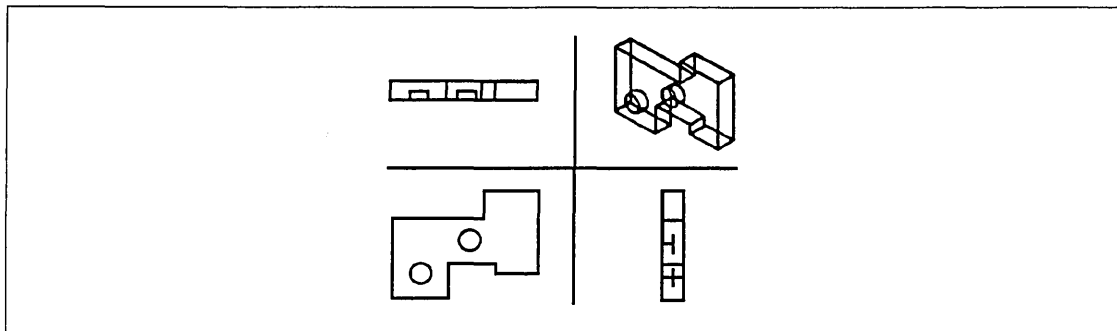

Figure 4-5. Zoom Entire Layout (1/2 Scale)

The menu for this section is:

- ZOOM SINGLE VIEW
- 1.RETURN TO BASE SCALE
- 2.NEW CENTER
- 3.NEW LOWER LEFT CORNER
- 4.NEW CENTER, ENTER SCALE
- 5.NEW CORNER, ENTER SCALE
- 6.DOUBLE SCALE
- 7.HALF SCALE
- 8.ENTER SCALE
- 9.DIAGONAL SCREEN POSITIONS
- 10.ENTER MAX-MINS
- 11.AUTOMATIC MAX-MINS
- 12.REDEFINE BASE SCALE
- 13.NAME A ZOOM SCALE
- 14.RETRIEVE NAMED SCALE
- 15.CHANGE PAGE
- 16.ZOOM FROM HARDCOPY
- 17.CHANGE ZOOM MODE

The following sections describe the choices in this menu.

8.6.1 Return to Base Scale

With this choice, you can redisplay the current view at its base scale. The base scale of a view is a reference scale that is stored with the view. When a new part is created, the base scale is predefined with a magnification of 1 and with the origin in the lower left corner. You can set the base scale by choosing 8.6.12 REDEFINE BASE SCALE. If the zoom mode (refer to 8.6.17 CHANGE ZOOM MODE) is set to ENTIRE LAYOUT, the base scale refers to the base scale of the entire layout. When 8.6.1 RETURN TO BASE SCALE is chosen, the view is displayed and you return to your last activity.

8.6.2 New Center

With this choice, you can reposition the drawing by specifying what workspace xt, yt position will be in the center of the display. This is useful for specifying a new focal area of attention without changing the magnification.

INDICATE NEW SCREEN CENTER

Use the graphics cursor to select a new center. Refer to 8.1.3 ZOOM ORIGIN MODE for a description of the zoom origin mode prompts.

After a screen position is specified, the view is redisplayed with this xt, yt location as the center of the display. Control returns to the last activity. Entering [returns you to 8.1.3 ZOOM ORIGIN MODE. Entering] returns you to your last activity.

8.6.3 New Lower Left Corner

With this choice, you can reposition the drawing by specifying what workspace *xt*, *yt* position will be in the lower left corner of the display.

INDICATE NEW SCREEN CENTER

Use the graphics cursor to select a new center. Refer to 8.1.3 ZOOM ORIGIN MODE for a description of the zoom origin mode prompts.

After a screen position is specified, the view is redisplayed with this *xt*, *yt* location as the lower left corner of the display. Control returns to the last activity. Entering [returns you to 8.1.3 ZOOM ORIGIN MODE. Entering] returns you to your last activity.

8.6.4 New Center, Enter Scale

With this choice, you can reposition the drawing by specifying *xt*, *yt* as the center and entering a change in the scale.

INDICATE NEW SCREEN CENTER

Use the graphics cursor to select a new center. Refer to 8.1.3 ZOOM ORIGIN MODE for a description of the zoom origin mode prompts.

After you have specified the desired *xt*, *yt* center of the display, the system displays:

1.SCALE = (current zoom scale)
2.RATIO = 1.0

Enter one, but not both, of these values. Refer to 8.1.4 RESCALE ENTRY MODE for a description of the prompts for the zoom scale entry mode.

After you modify one of these values, the view is redisplayed with the specified *xt*, *yt* in the center and at the scale specified, and you return to your last activity.

8.6.5 New Corner, Enter Scale

With this choice, you can reposition the drawing by specifying *xt*, *yt* as the lower left corner and entering a change in the scale.

INDICATE NEW SCREEN CORNER

Use the graphics cursor to select a new corner. Refer to 8.1.3 ZOOM ORIGIN MODE for a description of the zoom origin mode prompts.

After you have specified the desired *xt*, *yt* lower left corner of the display, the system displays:

1.SCALE = (current zoom scale)
2.RATIO = 1.0

Enter one, but not both, of these values. Refer to 8.1.4 RESCALE ENTRY MODE for a description of the prompts for the zoom scale entry mode.

After you modify one of these values, the view is redisplayed with the specified *xt*, *yt* in the lower left corner and at the scale specified, and you return to your last activity.

8.6.6 Double Scale

With this choice, you can redisplay the view at twice the current scale, centered about the current screen center. After this operation, you return to your last activity.

8.6.7 Half Scale

With this choice, you can redisplay the view at half the current scale, centered about the current screen center. After this operation, you return to your last activity.

8.6.8 Enter Scale

With this choice, you can redisplay a view at any desired scale without changing the position of the display center.

1. SCALE = (current zoom scale)
2. RATIO = 1.0

Enter one, but not both, of these values. Refer to 8.1.4 RESCALE ENTRY MODE for a description of the prompts for the zoom scale entry mode.

After you modify one of these values, the view is redisplayed, centered about the current screen center at the scale specified. After this operation, you return to your last activity.

8.6.9 Diagonal Screen Positions

With this choice, you can display a portion of a drawing that lies within a rectangle defined by two diagonal screen positions. This is useful when you want to display only a certain portion of the drawing, but you do not know what scale would be appropriate.

INDICATE ONE ZOOM CORNER

Use the graphics cursor to mark one corner of the rectangular area to be displayed.

INDICATE OPPOSITE ZOOM CORNER

Use the graphics cursor to mark the (diagonally) opposite corner of the rectangle.

After the rectangle has been defined, the part is redisplayed as the region bounded by the rectangle defined by the two positions. If necessary, the maximum/minimum range of the display in xt or yt can be expanded to allow display of the range specified for the other coordinate. After this operation, you return to your last activity.

8.6.10 Enter Max-Mins

With this choice, you can define the coordinates of the location which will be the lower left corner (xt min, yt min) and the upper right corner (xt max, yt max) on the screen after redisplaying.

- | | |
|--|---|
| 1.XT MINIMUM = (current minimum
XT value) | Enter the minimum and maximum xt and
yt values to define the portion of the
drawing to fill the screen. |
| 2.YT MINIMUM = (current minimum
YT value) | |
| 3.XT MAXIMUM = (current maximum
XT value) | |
| 4.YT MAXIMUM = (current maximum
YT value) | |

If necessary, the maximum/minimum range of the display in either xt or yt can be expanded to allow display of the range specified for the other coordinate.

After entering these values, enter] to redisplay the drawing with the values entered. After this operation, you return to your last activity.

8.6.11 Auto Max-Mins

With this choice, you can direct the system to display the drawing at the optimum viewing scale. All entities that can be currently displayed are checked for maximum and minimum xt, yt range to display the entire part at maximum scale. When you select this option, there is a slight delay while the system calculates the range and scale factors for the new display. This option does not change the base scale of the view.

The view is redisplayed to fill the entire window, and the system returns you to your last activity.

8.6.12 Redefine Base Scale

With this choice, you can establish the current scale as the base scale for the view currently being displayed. Thereafter, to return to the base scale, use 8.6.1 RETURN TO BASE SCALE. You modify the base scale to save a particular view representation before zooming into a detailed section of the view. (Menu 8.6.1 RETURN TO BASE SCALE includes a description of base scale.)

SAVE AS BASE SCALE?	Enter Y to change the base scale of the view to that of the current display.
---------------------	---

If multiple views are displayed and the zoom mode is ENTIRE LAYOUT, the base scale of the layout is changed. After this operation, you return to your last activity.

8.6.13 Name a Zoom Scale

With this choice, you can name the current zoom scale for this view. Using 8.6.14 RETRIEVE NAMED SCALE, you can later return to this zoom scale by name. You can save as many zoom scales as desired. These zoom scales can be renamed (refer to 8.8.4 RENAME SAVED ZOOM SCALE), listed (refer to 8.8.5 LIST SAVED ZOOM SCALES), and deleted (refer to 8.8.6 DELETE SAVED ZOOM SCALE). This is useful when you want to name detailed sections of a view that can be chosen again, even though it is not in the current view's display area.

ENTER NAME FOR THIS ZOOM SCALE Enter the name (up to 16 characters long)
that refers to the zoom scale of this view.

If the selected zoom scale name already exists, the system displays:

NAME ALREADY EXISTS.	Enter:
REPLACE IT?	
	Y To replace the previous scale associated with the current scale.
	N To request a different name.

The system saves the zoom scale with this name and returns you to 8.6 ZOOM.

8.6.14 Retrieve Named Scale

With this choice, you can retrieve a zoom scale that was saved with 8.6.13 NAME A ZOOM SCALE.

ENTER SAVED ZOOM SCALE NAME Enter the name of an existing zoom scale to
be used with the current view.

If the name is not found, the system displays:

NAME NOT FOUND	Enter either] or [.
----------------	----------------------

If the name is found, the system redisplay the view at the zoom scale saved under that name, and returns you to your last activity.

8.6.15 Change Page

With this choice, you can control the display as if the design were a sequence of different pages. A page is the amount of design that can be displayed at the current scale. For example, consider the case in which you zoomed in on the left side of a horizontal shaft. If you page to the right, the center of the shaft is then displayed.

The change page function is useful when you want to move gradually around the view at a magnified scale. The system displays the following prompts:

```
PAGE CHANGE DIRECTION
1.LEFT
2.RIGHT
3.UP
4.DOWN
5.ENTER DIRECTION
6.CHANGE DEFAULT SCREEN OVERLAP
```

Enter:

- 1 To display the page of view to the left.
- 2 To display the page of view to the right.
- 3 To display the area above the current view.
- 4 To display the area below the current view.
- 5 To enter the delta direction. The system displays:

```
1.NUMBER OF DX PAGES =          Enter the delta pages in dx and dy as
2.NUMBER OF DY PAGES =          integer values.
```

Negative dx values shift left and negative dy values shift down. A delta of two dx pages is the same as changing page direction to the right twice. The system overlaps the pages by the current overlap values.

After the page delta has been entered and followed with], the system displays the new page, and returns you to 8.6.15 CHANGE PAGE.

- 6 To change the default screen overlap. The system displays these prompts.

```
1.XS OVERLAP = (last value used)      Enter the overlap distance.
2.YS OVERLAP = (last value used)
```

These overlap values are based on the percentage of the current screen replaced. For example, setting the overlap value to 1.0 gives a 100 percent different area displayed (no overlap); setting the overlap value to 0.5 retains one-half of the current area displayed (50 percent overlap).

After you modify these values, the system returns you to 8.6.15 CHANGE PAGE.

8.6.16 Zoom from Hardcopy

With this choice, you can repaint the display, filling as much of the screen as possible with the rectangular area indicated on a hardcopy print of the original scale. You can display different areas of the part without returning to the original scale.

To use this option, you must first print a hardcopy of the part at the original scale (refer to 8.1.1 DEPTH ENTRY MODE) and place the hardcopy on the tablet.

INDICATE DISPLAY BOUNDARY 1

Use the pen to select the location of the lower left display boundary indicator on the hardcopy which is on the tablet. The lower left indicator, together with the upper right indicator, define the maximum image area of the display.

INDICATE DISPLAY BOUNDARY 2

Use the pen to select the upper right display boundary indicator.

INDICATE SCREEN POSITION 1

Use the pen to select one corner of an imaginary rectangle.

INDICATE SCREEN POSITION 2

Use the pen to select the corner that is diagonal to the first corner.

The system repaints the display, filling the screen with the indicated rectangular area. This operation changes the scale factor to that of the resulting display. To display another area on the hardcopy print, you can return to this function menu without first returning the part to its original scale.

8.6.17 Change Zoom Mode

With this choice, you can change the zoom mode when multiple views are displayed.

CHANGE ZOOM MODE

1. ENTIRE LAYOUT
2. WORK VIEW
3. ALL VIEWS
4. SELECTED VIEWS

Enter:

- 1 To zoom the entire layout. Future zooming operations, including 8.6.12 REDEFINE BASE SCALE, affects the layout windows rather than the views. Refer to figure 4-4 for an example of a zoom operation with the zoom mode set to ENTIRE LAYOUT.
- 2 To zoom only the work view. Future zooming operations affect only the current work view. Refer to figure 4-2 for an example of a zoom operation with the zoom mode set to WORK VIEW.
- 3 To zoom all displayed views. Future zooming operations affect all displayed views. Refer to figure 4-3 for an example of a zoom operation with the zoom mode set to ALL VIEWS.
- 4 To zoom only selected views.
Select the views to be scaled, or the views not to be scaled.

VIEW SELECTION MODE

1. SELECT VIEWS NOT TO BE SCALED
2. SELECT VIEWS TO BE SCALED

Enter 1 or 2 to choose a view select option.

VIEW NUMBER =

Enter the view number. Refer to 8.1.2 VIEW SELECTION MODE for a description of the view number selection procedure.

After this operation, you return to your last activity.

8.7 View Layout Construction

With this choice, you can create and modify view layouts. A view layout is a configuration of views displayed at specified scales in preassigned rectangular windows. You can create as many view layouts as desired. A layout can be created to generate a plotter output of a three-dimensional design with multiple views. It is also useful in visualizing a three-dimensional design. You can zoom into different components of the layout using 8.6 ZOOM.

Several methods for constructing and modifying layout windows are available. The most useful functions are adding and stretching windows.

When no layouts have been defined, the system displays:

ENTER VIEW LAYOUT NAME Enter a view layout name (up to 32 characters long).

A view layout consisting of the views in the current display is defined, and you continue to layout construction.

When at least one layout has already been defined, the system displays:

CONTINUE WITH Enter:
(previous view layout used)
LAYOUT? Y To continue to layout construction.
 N To enter a different view layout.

If you enter N, the system displays:

ENTER VIEW LAYOUT NAME Enter the name of either an existing or a new layout.

If you enter the name of an existing layout, this layout is redisplayed and you continue to layout construction. If no layout with this name exists, the system displays:

DOES NOT EXIST. DO YOU WANT Enter:
TO CREATE A NEW LAYOUT? Y To display a view layout consisting of the views in the current display.
 N To return to the ENTER VIEW LAYOUT NAME prompt.

After the desired view layout has been retrieved or a new layout has been created, the system displays 8.7 VIEW LAYOUT CONSTRUCTION. This menu is redisplayed after each selected option is completed.

The menu for this section is:

```
VIEW LAYOUT CONSTRUCTION
1.MODALS
2.MOVE WINDOW
3.STRETCH WINDOW
4.ADD VIEW
5.REPLACE VIEW
6.UNBLANK VIEW
7.BLANK VIEW
8.DELETE VIEW
9.MODIFY LAYOUT NAME
10.COPY UNDER NEW NAME
11.PLACE FORMAT AROUND LAYOUT
12.ALIGN LAYOUT VIEWS
```

Enter] to terminate view layout construction and return to 8 DISPLAY CONTROL.

The following sections describe the choices in this menu.

8.7.1 Modals

With this modal, you can control some of the characteristics of the view layout construction module. The system displays these prompts:

- 1.LAYOUT UNITS OF MEASUREMENT
- 2.ENTITY DISPLAY DURING CONSTRUCTION
- 3.SCALE OF ALIGNED VIEWS

Enter:

- 1 To select layout units of measurement. This modal controls the type of units you enter when positioning view windows in a view layout. (Paper size is not yet implemented.)

- 1.SCREEN UNITS
- 2.PAPER SIZE
- 3.RASTERS
- 4.USER CHOOSES LAYOUT
UNITS MODE

Enter:

- 1 To set the modal to screen units.
- 2 To set the modal to paper size.
- 3 To set the modal to rasters.
- 4 To set the modal to user selection.

The default selection is 1.SCREEN UNITS.

- 2 To select the entity display mode. This modal determines whether or not the system displays entities within windows modified during view layout construction. Because you can modify the position of windows several times while creating a layout, the option to inhibit entity display can speed up this process, particularly if many views are displayed.

- 1.DISPLAY ENTITIES AFTER
VIEW CHANGE
- 2.DO NOT DISPLAY DURING
CONSTRUCTION

Enter:

- 1 To display entities.
- 2 To inhibit entity display during construction. The default selection is 1.DISPLAY ENTITIES AFTER VIEW CHANGE.

- 3 To select the method for setting the scale of aligned views. This modal determines whether the aligned view's scale matches that of the reference view or remains unchanged.

- SCALE OF ALIGNED VIEWS
- 1.SET TO REFERENCE VIEW SCALE
- 2.SCALE REMAINS UNCHANGED

Enter:

- 1 To set the aligned view's scale to that of the reference view. This is the default setting.
- 2 To allow alignment of views of differing scale. This choice does not change the scale of the aligned view.

8.7.2 Move Window

With this choice, you can move the window of a view in the display. The window cannot be moved outside the display range, unless you rescale the entire layout. The system displays this prompt:

```
CHOOSE MOVEMENT MODE
1.SPECIFY NEW CENTER
2.SPECIFY NEW CORNER
3.MOVE A DELTA
```

Enter:

- 1 To specify a new center for the view window.

```
VIEW NUMBER =
```

Enter the view number. Refer to 8.1.2 VIEW SELECTION MODE for a description of the view number selection procedure. Only displayed views can be selected. After a view has been selected, the system brings attention to the current view border.

```
INDICATE NEW VIEW CENTER
```

Use the graphics cursor to mark the new center location of the view.

- 2 To specify a new lower left corner for the view window.

```
VIEW NUMBER =
```

Enter the view number. Refer to 8.1.2 VIEW SELECTION MODE for a description of the view number selection procedure. Only displayed views can be selected. After a view has been selected, the system brings attention to the current view border.

```
INDICATE NEW VIEW CORNER
```

Use the graphics cursor to mark the new lower left corner of the view.

- 3 To specify the number of rasters by which the view window is to be moved.

```
VIEW NUMBER =
```

Enter the view number. Refer to 8.1.2 VIEW SELECTION MODE for a description of the view number selection procedure. Only displayed views can be selected. After a view has been selected, the system brings attention to the current view border.

```
1.SCREEN DX = 0
2.SCREEN DY = 0
```

Enter the number of rasters by which the view window is to be moved.

8.7.3 Stretch Window

After you enter the view number and indicate the movement mode, the system displays:

CHOOSE DEFAULT LAYOUT
UNITS MODE
1.SCREEN INCHES
2.PAPER SIZE
3.RASTERS
4.DISPLAY LAYOUT

Enter:

- 1 To change the default layout units to screen inches.
- 2 To change the default layout units to paper size.
- 3 To change the default layout units to rasters.
- 4 To change the default layout units to display layout.

8.7.3 Stretch Window

With this choice, you can stretch the window of a view in the display.

CHOOSE STRETCH MODE
1.ONE SIDE
2.ONE CORNER
3.OPPOSITE SIDES
4.THREE SIDES
5.ALL SIDES

Enter:

- 1 To stretch one side.

VIEW NUMBER =

Enter the view number. Refer to 8.1.2 VIEW SELECTION MODE for a description of the view number selection procedure. Only displayed views can be selected. After a view has been selected, the system brings attention to the current view border.

If INDICATE VIEW was not the view selection mode (refer to 8.1.2 VIEW SELECTION MODE), the system displays:

INDICATE REFERENCE POSITION

Use the graphics cursor to select the reference position.

The reference position (or the position at which the view was selected if the view selection modal was INDICATE VIEW) specifies which side or sides are to be stretched.

INDICATE NEW VIEW SIDE

Use the graphics cursor to indicate where the new side of the view window is to be positioned.

After this operation, you continue to Display Generation.

2 To stretch one corner.**VIEW NUMBER =**

Enter the view number. Refer to 8.1.2 VIEW SELECTION MODE for a description of the view number selection procedure. Only displayed views can be selected. After a view has been selected, the system brings attention to the current view border.

If INDICATE VIEW was not the view selection mode (refer to 8.1.2 VIEW SELECTION MODE), the system displays:

INDICATE REFERENCE POSITION

Use the graphics cursor to select the reference position.

The reference position (or the position at which the view was selected if the view selection modal was INDICATE VIEW) specifies which side or sides are to be stretched.

INDICATE VIEW CORNER

Use the graphics cursor to indicate the corner to be positioned.

INDICATE NEW VIEW CORNER

Use the graphics cursor to indicate where the new corner of the view window is to be positioned.

After this operation, you continue to Display Generation.

3 To stretch opposite sides (vertical or horizontal).

VIEW NUMBER = Enter the view number. Refer to 8.1.2 VIEW SELECTION MODE for a description of the view number selection procedure. Only displayed views can be selected. After a view has been selected, the system brings attention to the current view border.

If INDICATE VIEW was not the view selection mode (refer to 8.1.2 VIEW SELECTION MODE), the system displays:

INDICATE REFERENCE POSITION Use the graphics cursor to select the reference position.

The reference position (or the position at which the view was selected if the view selection modal was INDICATE VIEW) specifies which side or sides are to be stretched.

INDICATE NEW VIEW SIDE Use the graphics cursor to indicate where one of the new sides of the view window is to be positioned.

INDICATE NEW OPPOSITE SIDE Use the graphics cursor to indicate where the opposite side of the view window is positioned.

After this operation, you continue to Display Generation.

- 4 To stretch three sides. The reference position specifies which side should not be moved.

VIEW NUMBER = Enter the view number. Refer to 8.1.2 VIEW SELECTION MODE for a description of the view number selection procedure. Only displayed views can be selected. After a view has been selected, the system brings attention to the current view border.

If INDICATE VIEW was not the view selection mode (refer to 8.1.2 VIEW SELECTION MODE), the system displays:

INDICATE REFERENCE POSITION Use the graphics cursor to select the reference position.

The reference position (or the position at which the view was selected if the view selection modal was INDICATE VIEW) specifies which side or sides are to be stretched.

INDICATE NEW VIEW CORNER Use the graphics cursor to indicate where the new side of the view windows is to be positioned.

INDICATE OTHER CORNER Use the other corner position that is not adjacent to the stationary side.

After this operation, you continue to Display Generation.

- 5 To stretch all sides. (No view reference position is required.)

VIEW NUMBER = Enter the view number. Refer to 8.1.2 VIEW SELECTION MODE for a description of the view number selection procedure. Only displayed views can be selected. After a view has been selected, the system brings attention to the current view border.

INDICATE NEW VIEW CORNER Use the graphics cursor to indicate any new corner position for the selected view.

INDICATE NEW OPPOSITE CORNER Use the graphics cursor to indicate the (diagonally) opposite corner.

After this operation, you continue to Display Generation.

Display Generation

After you specify the stretched positions for the selected window, the system displays:

DISPLAY ADJUSTMENT MODE

- 1.MAINTAIN CURRENT DISPLAY POSITION
- 2.MOVE DIRECTION OF PRIMARY STRETCH
- 3.RESIZE INTO NEW WINDOW

Enter:

- 1 To maintain the current display position for the selected view after subsequent repaints.
- 2 To move the drawing in the direction of the primary stretch.
- 3 To rescale the drawing to fit the new window size.

8.7.4 Add View

With this choice, you can add a view to the view layout. The view to be added cannot be in the current display. The maximum number of views allowed in a layout is 32.

VIEW NUMBER =

Enter the view number. Refer to 8.1.2 VIEW SELECTION MODE for a description of the view number selection procedure.

If the view selection modal is set to INDICATE VIEW upon entry to this menu, the entire view selection mode menu is displayed to allow you to choose an alternate way of specifying the view.

The system then displays:

INDICATE NEW VIEW CORNER

Use the graphics cursor to indicate where the new corner of the view window is to be positioned.

INDICATE NEW OPPOSITE CORNER

Use the graphics cursor to indicate the opposite corner.

The system displays the design in this view at the scale of the current work view, and returns you to 8.7 VIEW LAYOUT CONSTRUCTION.

8.7.5 Replace View

With this choice, you can move a view from one window to the window of a different view.

VIEW NUMBER =

Enter the view number. Refer to 8.1.2 VIEW SELECTION MODE for a description of the view number selection procedure.

Displayed views or views not currently displayed can be selected. If a currently displayed view is selected, the system brings attention to the view border and this view is deleted from its current position.

The system then displays the new view and returns you to 8.7 VIEW LAYOUT CONSTRUCTION.

8.7.6 Unblank View

With this choice, you can unblank a view window. Only blanked views can be selected.

VIEW NUMBER = Enter the view number. Refer to 8.1.2 VIEW SELECTION MODE for a description of the view number selection procedure.

After a view has been selected, the system brings attention to the current view border. The design is unblanked in the specified view, and the system returns you to 8.7 VIEW LAYOUT CONSTRUCTION.

8.7.7 Blank View

With this choice, you can blank a view window. The design is blanked in the specified view (the specified view is deleted from the display after repaint). Only displayed views can be selected.

VIEW NUMBER = Enter the view number. Refer to 8.1.2 VIEW SELECTION MODE for a description of the view number selection procedure.

After a view has been selected, the system brings attention to the current view border, and returns you to 8.7 VIEW LAYOUT CONSTRUCTION.

8.7.8 Delete View

With this choice, you can remove a view window from the view layout. The specified view is not in the display after a repaint is performed. Only displayed views can be selected.

VIEW NUMBER = Enter the view number. Refer to 8.1.2 VIEW SELECTION MODE for a description of the view number selection procedure.

After a view has been selected, the system brings attention to the current view border, and returns you to 8.7 VIEW LAYOUT CONSTRUCTION.

8.7.9 Modify Layout Name

With this choice, you can change the name of the current view layout. The system displays:

CURRENT LAYOUT NAME IS: Enter] or [to acknowledge the layout name prompt.
(layout name)

ENTER DIFFERENT NAME FOR LAYOUT Enter a new name (up to six characters long) for the current layout view.

After a new name has been selected, the system returns you to 8.7 VIEW LAYOUT CONSTRUCTION.

8.7.10 Copy Under New Name

With this choice, you can copy a view layout and give the copy a new name. Subsequent modifications to the view layout are made to the new copy while the original copy remains unchanged. This is useful when you want to modify a view layout, but retain the current layout status. The system displays:

CURRENT LAYOUT NAME IS:
(layout name)

Enter] or [to acknowledge the layout name prompt.

ENTER NAME OF COPIED LAYOUT

Enter a name (up to six characters long) for the copied layout view.

After a name has been selected, the system returns you to 8.7 VIEW LAYOUT CONSTRUCTION.

8.7.11 Place Format Around Layout

With this choice, you can place a drawing format around a multiple view layout. The drawing format (or drawing border) should be stored as a part on the current work file (TAPE3). The format should be created in view 1 with a scale factor of 1.0. A view called the format view is defined to support the format. Only one format view is allowed in a part.

If a format view already exists in a current part, the system displays:

FORMAT VIEW ALREADY EXISTS,
CONTINUE?

Enter:

Y To replace the existing format with a
new format.

N To return to 8.7 VIEW LAYOUT
CONSTRUCTION.

If there is no previously defined format view or you wish to replace it, the system displays:

ENTER NAME OF FORMAT
SHEET NUMBER

Enter the part name (70 characters
maximum) and the sheet number (4 digits
maximum) of the format.

The system then searches the local part file for a part that has the entered name and sheet number. If the entered name and sheet number are the full name and exact sheet number of an existing part, the system displays:

ENTERED NAME MATCHES PART NAMED-

If the entered name is a subset of only one part and the sheet number is an exact match, the system displays:

ENTERED SUBSET MATCHES PART NAME-

In both cases, the 70-character matched part name and sheet number are displayed:

(70-character name)
SHEET (4-digit number)

Enter:

Y To continue adding a format.

N To return to the KEY-IN NAME OF
FORMAT prompt.

If the entered name is a subset of more than one part, the system displays:

ENTERED SUBSET MATCHES MANY NAMES

You return to the KEY-IN NAME OF FORMAT prompt. If the entered name is not a match of any part name, the system displays:

NO MATCH FOUND

The system now creates a new window around the current layout and displays the format centered within this window. A format view is defined to support the format. The system displays:

FORMAT VIEW IS nn (the number of format view)

The number of the format view can be displayed at any time by entering 1.13 DISPLAY TITLE BLOCK or 8.8.2 LIST VIEWS. The default name of the format view is FORMAT.

NOTE

You can add notes and geometry to the drawing format by changing the work view to the format view or by displaying the format view as a single view. Any text or geometry created in the format view is not displayed and is not selectable in other views.

Window position and size can be adjusted in the same manner as other windows of the view layout.

8.7.12 Align Layout Views

View alignment is an enhancement to view layout construction. It is based on the drafting principle of folding out the three-dimensional projection of an object to create a flat set of views describing the object. Adjacent views are located so that a line between the identical point in each view is perpendicular to the fold line of the two planes.

With this choice, you can move a view into drafting alignment with another view. The view can be scaled the same as the reference view and then moved into alignment parallel to the imaginary fold line.

You specify a reference view and then the view to be aligned. If the view cannot be aligned, it is left unchanged and you receive a message stating the reason. You can then choose another view for alignment. The system displays the following prompts:

SELECT REFERENCE VIEW
VIEW NUMBER =

Enter the view number to which you want to align. This view is used to determine the scale and location of the views to be aligned.

Enter [to choose a new method from the Choose Default View Select Mode menu.

Enter] to terminate view alignment and return to 8.7 VIEW LAYOUT CONSTRUCTION.

VIEWS TO ALIGN
1.SINGLE
2.ALL

Enter:

- 1 To select a single view for alignment.
- 2 To select all layout views for alignment to the reference view.
- [To return to selection of the reference view.
-] To return to 8.7 VIEW LAYOUT CONSTRUCTION.

If you choose 1.SINGLE from the Views to Align menu, you select a single view for alignment with the following prompt:

SELECT VIEW TO BE ALIGNED
VIEW NUMBER =

Enter the view you want to move into alignment with the selected reference view.

Enter [to choose a new method from the Choose Default View Select Mode menu.

Enter] to terminate view alignment and return to 8.7 VIEW LAYOUT CONSTRUCTION.

If you choose 2.ALL, the system attempts to align all views.

If you have set the Scale Of Allowed Views modal to 2.SCALE REMAINS UNCHANGED, you select an alignment point with the following prompt:

SELECT ALIGNMENT POINT
INDICATE POINT

Indicate the point you want to align. You can select this point in any view.

[To return to the Views to Align menu.

] To return to 8.7 VIEW LAYOUT CONSTRUCTION.

The system determines whether the views can be aligned. If so, the view you selected is moved into alignment with the reference view. The system returns to the SELECT VIEW TO BE ALIGNED prompt if you are in single view selection mode or to 8.7 VIEW LAYOUT CONSTRUCTION if you selected all views for alignment.

Figure 4-6 shows alignment of the auxiliary view to the front view of the three-dimensional block. In this example, the Scale Of Aligned Views modal is set to the default value of 1.SET TO REFERENCE VIEW SCALE.

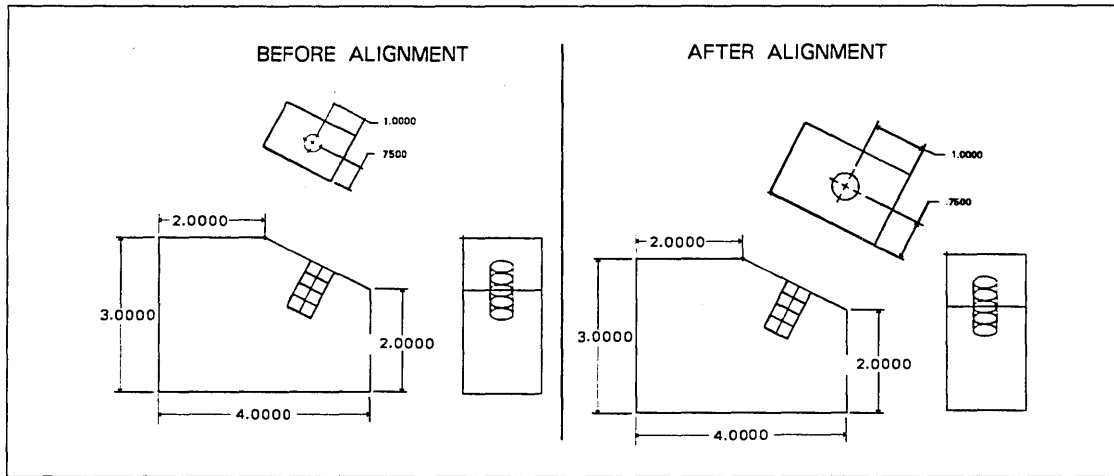

Figure 4-6. Aligning Views Using Reference View Scale

Figure 4-7 shows the same block with the auxiliary view aligned to the front view when the Scale Of Aligned Views modal is 2.SCALE REMAINS UNCHANGED. The alignment point selected is the leftmost corner of the auxiliary face.

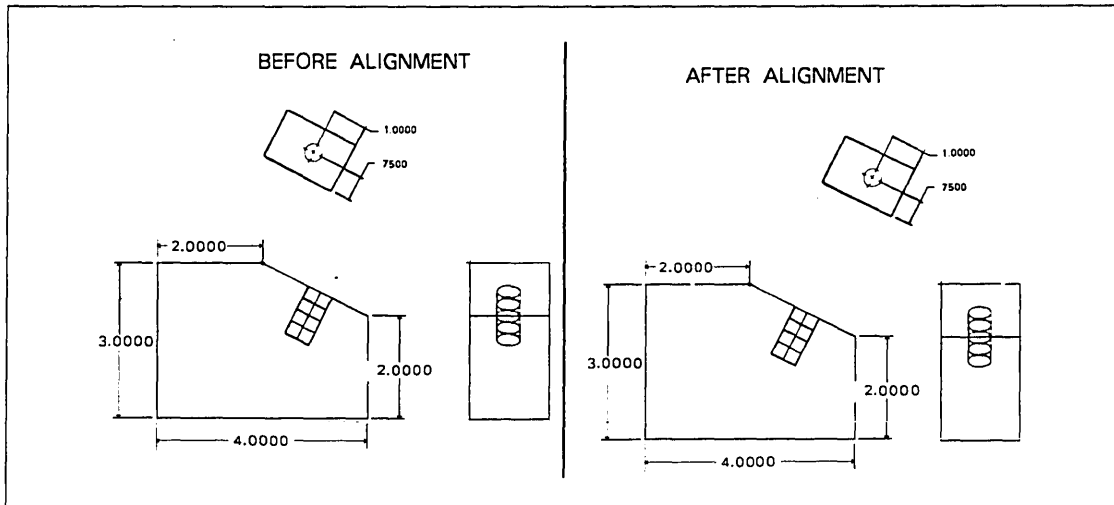

Figure 4-7. Aligning Views with Scale Unchanged

If a single view cannot be aligned, the system states the most likely cause and returns to the SELECT VIEW TO BE ALIGNED prompt. You receive one of the following messages to explain the problem:

Message	Explanation
CANNOT ALIGN A VIEW TO ITSELF	You cannot choose the same view for alignment as you chose for the reference view.
CANNOT ALIGN PARALLEL VIEWS	View alignment does not apply to parallel views. It is not possible to align the front to the back view or the right to the left side view. You can align the top, right, and left views to the front view and then align the back to the top view to obtain the desired drafting layout.
CANNOT ALIGN VIEW DUE TO VIEW ROTATION	The view you chose for alignment must have the correct rotation relative to the reference view. Figure 4-8 shows a drawing for which it is not possible to align the auxiliary to the front view because of the rotation of the auxiliary view.
NO ALIGNMENT - VIEWS NOT FOLDED 90 DEG.	Drafting conventions state that neighboring views must be folded 90° apart from each other. You receive this message if the fold angle from the reference view to the view to be aligned is not 90°. Alignment is not performed. Figure 4-9 shows this case. Alignment of the auxiliary and front views is not allowed.

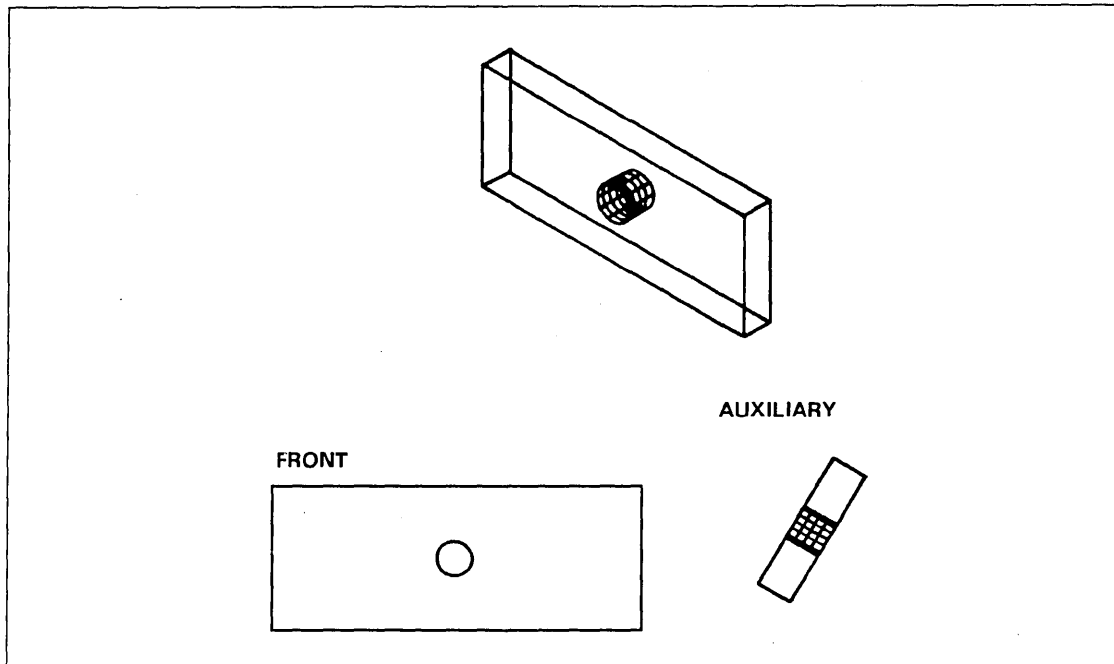

Figure 4-8. Front and Auxiliary Views--Cannot Be Aligned Because of Rotation

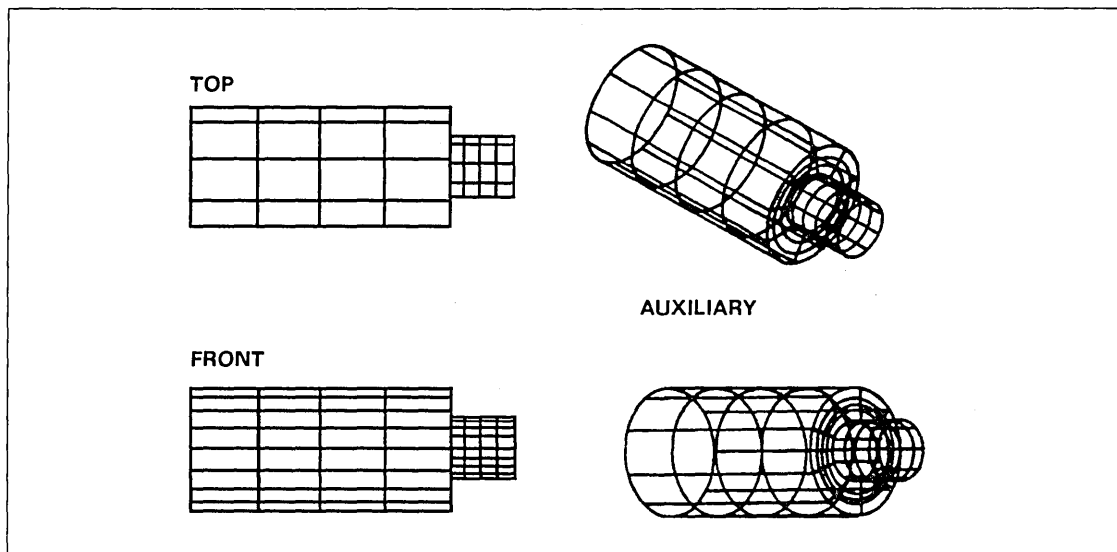

Figure 4-9. Front and Auxiliary Views--Cannot Be Aligned Because of Fold Angle

If some views cannot be aligned when you select all views, the system aligns as many views as possible. The views that cannot be aligned are marked on their view borders and the following message is given:

MARKED VIEWS COULD NOT BE ALIGNED

The reasons are the same as those explained previously for single views that cannot be aligned.

8.8 Display Name Management

With this choice, you can perform management functions for view names and work plane names, saved zoom scales, and view layouts. This includes the ability to rename, list, and delete these features. In conjunction with this management, the list function is useful for verifying the viewing information associated with the current part. You can choose to remove excess viewing data by using the delete options described in this section.

The menu for this section is:

- VIEW NAME CONTROL
- 1.NAME A VIEW
- 2.LIST VIEWS
- 3.DELETE A VIEW
- 4.RENAME SAVED ZOOM SCALE
- 5.LIST SAVED ZOOM SCALES
- 6.DELETE SAVED ZOOM SCALE
- 7.RENAME A LAYOUT
- 8.LIST LAYOUTS
- 9.LIST VIEWS IN A LAYOUT
- 10.DELETE A VIEW LAYOUT

The following sections describe the choices in this menu.

8.8.1 Name a View

With this choice, you can name a view or workspace or modify an existing view or workspace name. Because the terms view and workspace are interchangeable, the numbering and naming of views also applies to workspaces. The number and name of a workspace can be entered in response to the view number/name prompt, even if that space has never been viewed.

VIEW NUMBER = Enter the view number. Refer to 8.1.2 VIEW SELECTION MODE for a description of the view number selection procedure.

If the selected view is already named, the system displays:

CURRENT NAME IS: Enter] or [to acknowledge the current name prompt.
(current view name)

ENTER NEW VIEW NAME Enter the new view name.

If the new view name has already been defined for another view, the system displays:

VIEW (view number) Enter] or [to acknowledge the view
HAS THIS NAME ALREADY prompt.

If the view name entered has not already been defined in another view, the name is accepted and the system returns control to 8.8 DISPLAY NAME MANAGEMENT and prompts you to select another view.

8.8.2 List Views

With this choice, you can list all the views that are defined in this part. The first eight views are given predefined names. Figure 4-10 is a sample listing of this choice. The system uses dashes when a view is not named.

<u>View No.</u>	<u>Name</u>	<u>Depth</u>	<u>Zoom</u>	<u>Entities</u>
1	FRONT	15.5000	9.0619	187
2	BOTTOM	0.0000	2.0000	21
3	RIGHT	-10.0000	2.0000	53
4	AUX 1	0.0000	1.0000	0
5	BACK	0.0000	1.0000	0
6	TOP	0.0000	1.0000	0
7	LEFT	0.0000	1.0000	0
8	ISO1	0.0000	1.0000	0
9	---	5.0000	4.0000	11

Figure 4-10. Listing of 8.8.2 LIST VIEWS

If the view listing is more than one page, the system displays:

CONTINUE?

Enter:

Y To display the next page of information.

N To return to 8.8 DISPLAY NAME
MANAGEMENT.

When the listing is complete, the system returns you to 8.8 DISPLAY NAME
MANAGEMENT.

8.8.3 Delete a View

With this choice, you can remove a view or work plane from the system. Once it has been deleted, a view can no longer be used or referred to as a work plane.

VIEW NUMBER = Enter the view name.

If the view is not found, the system displays:

DOES NOT EXIST-LAST VIEW IS nn Enter Y to continue.

If one of the first eight views is chosen, the system displays:

VIEWS 1-8 MAY NOT BE DELETED Enter Y to continue.

The system then prompts for another view to be deleted.

If the selected view currently has entities defined in its coordinate system, the view cannot be deleted. The system displays:

(number of entities) - Enter Y to continue.
ENT DEFINED FOR THIS VIEW

The system prompts for another view to be deleted.

If the selected view is currently displayed, the system displays:

THIS VIEW IS CURRENTLY BEING Enter Y to continue.
DISPLAYED AND MAY NOT BE
DELETED

The system prompts for another view to be deleted.

If the selected view is currently being used as a workspace, the system displays:

VIEW IS CURRENTLY USED AS A WORK SPACE AND
MAY NOT BE DELETED, ACKNOWLEDGE .

Enter Y or N to continue. You must reassociate any view that is using this selected view as a workspace with some other workspace before you can delete it. Set 8.1.10 VIEW ASSOCIATION MODE to ALL VIEWS and change the workspace.

If the chosen view is eligible for deletion, the system displays:

DELETE VIEW (view number)? Enter:

 Y To delete the selection.

 N To return to the view selection prompt.

After the view is deleted, the system displays:

VIEW (view number) DELETED

The system returns you to 8.8 DISPLAY NAME MANAGEMENT.

8.8.6 Delete Saved Zoom Scale

With this choice, you can remove a saved zoom scale from the system. The system displays:

ENTER SAVED ZOOM SCALE NAME Enter the name of the saved zoom scale to
be deleted, or enter [to return to 8.8
DISPLAY NAME MANAGEMENT.

If the saved zoom scale is not found, the system displays:

NOT FOUND Enter Y or N to continue.

The system prompts for another saved zoom scale name.

If the saved zoom scale is found, the system displays:

DELETE (saved zoom scale name)? Enter:

Y To delete the saved zoom scale.
N To retain the saved zoom scale.

The system prompts for another zoom scale.

8.8.7 Rename a Layout

With this choice, you can modify the name of an existing view layout.

ENTER LAYOUT NAME Enter the name of the layout to be
modified.

If the view layout is not found, the system displays:

NOT FOUND Enter Y or N to continue.

If the view layout is found, the system displays:

ENTER NEW LAYOUT NAME Enter a new layout name.

After a new layout name is entered, the system prompts for the next view layout name.

8.8.8 List Layouts

With this choice, you can list all the layouts that are defined in the current part. Figure 4-12 shows a sample of this listing.

<u>Layout Name</u>	<u>No. Views</u>	<u>Work View</u>	<u>View Name</u>
STD 4-VIEW	4	1	FRONT
DRAFTING PLOT	3	1	FRONT

Figure 4-12. Listing of 8.8.8 LIST LAYOUTS

If the layout listing is more than one page, the system displays:

CONTINUE?

Enter:

Y To display the next page of information.

N To return to 8.8 DISPLAY NAME MANAGEMENT.

When the listing is complete, the system returns you to 8.8 DISPLAY NAME MANAGEMENT.

8.8.9 List Views in a Layout

With this choice, you can list the views defined in a view layout.

ENTER LAYOUT NAME

Enter the name of the layout to be listed.

The system lists the views in the layout. Figure 4-13 shows an example of this listing.

<u>View No.</u>	<u>View Name</u>	<u>XT-Min</u>	<u>YT-Min</u>
1	FRONT	1.0000	-1.8595
2	BOTTOM	0.4948	-1.8595
3	RIGHT	0.4948	-7.0890
4	AUX 1	0.4951	-3.9502

Figure 4-13. Listing of 8.8.9 LIST VIEWS IN A LAYOUT

When the listing is complete, the system returns you to 8.8 DISPLAY NAME MANAGEMENT.

Zoom Scale Menu

After the desired rotations have been entered, the system displays:

```
ZOOM SCALE FOR NEW VIEW
1.LAST SCALE USED
2.BASE SCALE
3.SAVED SCALE
4.ENTER SCALE
5.AUTOMATICALLY MAXIMIZED
```

Enter:

- 1 To use the last scale. The system displays the selected view at the scale last displayed.
- 2 To use the base scale. The system displays the selected view at its last specified base scale.
- 3 To use a previously saved scale.

```
ENTER ZOOM SCALE NAME
```

Enter the name of a saved zoom scale for the selected view. The system uses the saved scale specified for display of the view.

- 4 To enter a scale.

```
1.SCALE = (current zoom scale)
2.RATIO = 1.0
```

Enter one, but not both, of these values. If the scale is modified, this is the zoom scale of the new view. If the ratio is modified, the zoom scale is the displayed scale times the ratio entered.

The system displays the view at the specified scale and returns you to the next higher level of system control.

- 5 To automatically maximize the scale.

After the zoom scale has been specified by one of the previous methods, the screen is erased and the new view is displayed along with the question:

```
CONTINUE DEFINITION OF VIEW
(previously largest
view number plus 1)
```

Enter:

Y To return to 8.9 DEFINE
AUXILIARY VIEW.

N To return to 8 DISPLAY CONTROL.

8.10 Z-Clip

With this choice, you can view a construction constrained within a zt region. All data above and below the region is clipped off (not displayed). This function is useful when different entities have been created at different depths, and you want to view certain entities without seeing them in front of or behind other entities.

ZT CLIP MODE
 1.ZT CLIP ON
 2.ZT CLIP OFF

Enter:

- 1 To indicate that entities to be displayed are clipped above and below the zt range specified for the views specified.
- 2 To indicate that entities to be displayed are not clipped for the views specified.

VIEW NUMBER =

Enter the view number. Refer to 8.1.2 VIEW SELECTION MODE for a description of the view number selection procedure.

If you select 1.ZT CLIP ON, the system displays:

1.ZT MINIMUM = -10000.0
 2.ZT MAXIMUM = 10000.0

Enter the zt range to be displayed.

Enter:

- [To reselect a view or zt clip.
] To accept the default values.

For 1.ZT CLIP ON, the system requests a new view for 1.ZT CLIP ON if 1.2.1 CONTINUE OPERATION MODE is on, or returns to 8 DISPLAY CONTROL if 1.2.1 CONTINUE OPERATION MODE is off. You must do a repaint to display the results of ZT CLIP.

For 2.ZT CLIP OFF, the system requests a new view for 2.ZT CLIP OFF if 1.2.1 CONTINUE OPERATION MODE (refer to the ICEM Design/Drafting Introduction and System Controls manual) is on, or returns to 8 DISPLAY CONTROL if 1.2.1 CONTINUE OPERATION MODE is off. You must do a repaint to display the results of ZT CLIP.

Only those entities or parts of entities within the zt range are displayed.

NOTE

New entities added to the display are not clipped until the view has been regenerated for a repaint.

8.11 Change Work Space

With this choice, you can change the workspace that is associated with one or more views. This is done by indicating a workspace (refer to 8.1.9 WORK SPACE SELECTION MODE) and associating it with views (refer to 8.1.10 VIEW ASSOCIATION MODE). If the new workspace is associated with the current work view, that space is then used as the definition transform space.

The change in workspace also changes the work plane, that is, the current depth, and the transform origin location. The values for the new depth and origin are the values from the workspace.

After the new workspace is selected, the system confirms the choice and displays:

```
WORK SPACE (number and name) SELECTED
DEPTH = nnn.nnnn
```

If you wish to modify the depth, use 8.2 CHANGE DEPTH.

After this information is displayed, the system associates the workspace with one or more views, according to the setting of 8.1.10 VIEW ASSOCIATION MODE. This operation may require additional input. Once the views have been associated, the work name and axes displays are updated, if they are displayed (refer to 8.1 MODALS).

The selected workspace should not be associated with the work view if the work plane would become perpendicular to the screen (some screen position inputs would produce a transform coordinate of infinity). If this occurs, the system displays:

```
WORK PLANE IS PERPENDICULAR TO THE SCREEN, ACKNOWLEDGE
```

Enter] to acknowledge the warning. You may still wish to use a perpendicular work plane, and you can choose to work this way. Any screen position input requests relating to the workspace made by the system are aborted as if you had entered [, and the system displays:

```
FUNCTION IS INVALID WHILE THE WORK PLANE IS PERPENDICULAR TO THE SCREEN. CHANGE -
WORK SPACE OR VIEW, ACKNOWLEDGE
```

Enter] to acknowledge the warning.

8.12 Define Work Space

With this choice, you can define a new workspace in much the same way that auxiliary views are defined (refer to 8.9 DEFINE AUXILIARY VIEW). After the workspace is defined, you can associate it with a view or views. A newly created workspace has its own origin and depth values. The new origin is model space origin (unless otherwise indicated) but you can change it. The depth is always set to 0. The workspace is assigned a view number by which you can refer to it. This number is assigned using the same numbering scheme that assigns view numbers. The maximum number of views you can define in a part is 420.

The menu for this section is:

```
DEFINE WORK SPACE
1.ROTATIONS ABOUT AXES
2.PARALLEL TO PLANE
3. ENTER MATRIX
4.THROUGH A POINT AND PERPTO A LINE
5.THROUGH A POINT AND ALONG A LINE
6.THROUGH THREE POINTS
7.THROUGH TWO LINES
8.NEW ORIGIN
```

The following sections describe the choices in this menu.

8.12.1 Rotations about Axes

With this choice, you can define a new workspace by rotating an existing workspace about its axes and/or arbitrary lines. The origin of the new workspace is set to the origin of the workspace being rotated. Successive rotations around different axes or lines can be performed to produce a cumulative rotation. Before performing the rotations, you must first select a workspace to be rotated. This selection is done using 8.1.9 WORK SPACE SELECTION MODE. Additional input may or may not be required to select the workspace.

ROTATION MODE	Select a rotation mode.
1.XT AXIS, CLOCKWISE	
2.XT AXIS, COUNTERCLOCKWISE	
3.YT AXIS, CLOCKWISE	
4.YT AXIS, COUNTERCLOCKWISE	
5.ZT AXIS, CLOCKWISE	
6.ZT AXIS, COUNTERCLOCKWISE	
7.ROTATE ABOUT ANY LINE	

The system then asks for the angle of rotation:

ROTATION = nn.nnnn	Select an angle of rotation where nn.nnn is the previously entered value.
--------------------	---

If you select from menu choices 1 through 6, the rotation is performed around one of the workspace axes. If you select 7, you are asked to select a line and indicate an endpoint. The endpoint indicated determines the direction for rotation. A positive rotation value produces a counterclockwise rotation when viewing along the line axis from the indicated endpoint.

The rotation mode menu is redisplayed, allowing further rotations. Enter] to end the operation. The system prompts you to modify the origin, as described in 8.12.8 NEW ORIGIN.

8.12.2 Parallel to Plane

With this choice, you can define a workspace using a plane entity. A workspace is created so that the XT-YT plane of the workspace is parallel to the selected plane.

INDICATE PLANE	Select the desired plane.
INDICATE X EDGE	Indicate the edge of the plane entity to be parallel to the xt-axis of the workspace.
INDICATE Y EDGE	Indicate the edge of the plane entity to be parallel to the yt-axis of the workspace.

The system prompts you to modify the origin, as described in 8.12.8 NEW ORIGIN.

8.12.3 Enter Matrix

With this choice, you can define the workspace using a matrix.

1.VALUE #1 =	Enter values for the elements of the three rows of the rotation matrix for the transformation of coordinates from model space to workspace.
2.VALUE #2 =	
3.VALUE #3 =	
4.VALUE #4 =	
5.VALUE #5 =	
6.VALUE #6 =	
7.VALUE #7 =	
8.VALUE #8 =	
9.VALUE #9 =	

After this set of values has been modified, the new matrix created must be such that its transpose is equal to its multiplicative inverse. Enter] to continue to enter the translation vector.

1.DX =	Enter the components of the translation vector for the transformation of coordinates from model space to work space.
2.DY =	
3.DZ =	

You can modify the translation vector which is added to model space coordinates after the vectors have been postmultiplied by the rotation matrix. This vector defines the origin of the workspace. The system prompts you to associate the workspace with views, as described in 8.1.10 VIEW ASSOCIATION MODE.

8.12.4 Through a Point and Perpto a Line

With this choice, you can define a workspace with a point and a line which will be parallel to the new workspace zt-axis. The line should be selected near one of its endpoints as the endpoint chosen determines the positive direction of the zt-axis. The vector traced from the projection of the selected point onto the line to the point determines the positive yt-axis direction. The system prompts you to modify the origin as described in 8.12.8 NEW ORIGIN.

INDICATE POINT	Select a point to indicate the positive yt-axis.
----------------	--

INDICATE LINE	Select a line near an endpoint to indicate the positive zt-axis.
---------------	--

If the point is located on the line, the system displays:

POINT CANNOT LIE ON THE LINE

The system prompts you to reselect the entities.

8.12.5 Through a Point and Along a Line

With this choice, you can define a workspace with a point and a line which will be parallel to the new workspace xt-axis. The line should be selected near one of its endpoints as the endpoint chosen determines the positive direction of the xt-axis. The vector traced from the projection of the selected point onto the line to the point determines the positive yt-axis direction. The system prompts you to modify the origin as described in 8.12.8 NEW ORIGIN.

INDICATE POINT

Select a point to indicate the positive yt-axis.

INDICATE LINE

Select a line near an endpoint to indicate the positive xt-axis.

If the point is located on the line, the system displays:

POINT CANNOT LIE ON THE LINE

The system prompts you to reselect the entities.

8.12.6 Through Three Points

With this choice, you can define a workspace with three points. The order in which the points are chosen determines the orientation of the axes. The first two points define the xt-axis direction. The first point defines the negative end of the xt-axis and the second point defines the positive end. The vector traced from the projection of the third point onto the next xt-axis defines the positive yt direction.

INDICATE -XT POINT

Select the negative point of the xt-axis.

INDICATE +XT POINT

Select the positive point of the xt-axis.

INDICATE +YT POINT

Select the third point to set the yt-axis.

The system prompts you to modify the origin as described in 8.12.8 NEW ORIGIN.

8.12.7 Through Two Lines

With this choice, you can define a workspace with the endpoints of two lines. The first line defines the xt-axis and the endpoint chosen defines the positive direction. A vector traced from the projection of the chosen endpoint of the second line onto the first line to that endpoint defines the positive direction of the yt-axis.

INDICATE +XT LINE

Select the xt line at its positive end.

INDICATE +YT LINE

Select the yt line at its positive end.

If the two lines are not coplanar, the system displays:

THESE LINES DO NOT DEFINE A PLANE

and the system returns to the INDICATE +XT LINE prompt.

The system prompts you to modify the origin as described in 8.12.8 NEW ORIGIN.

8.12.8 New Origin

With this choice, you can define a new workspace by changing the origin of an existing workspace. The new workspace will have the same axes orientation, but will be centered at a different position. Selection of the existing workspace is done using 8.1.9 WORKSPACE SELECTION MODE.

```
ORIGIN ENTRY
1.SCREEN SELECT
2.KEY-IN
3.INDICATE POINT
4.DELTA
5.SET TO MODEL ORIGIN
6.SET TO OTHER WORK ORIGIN
```

Enter:

- 1 To screen select a position to be used as the origin.

```
INDICATE POSITION                               Select a new origin using the graphics
                                                cursor.
```

The indicated position is projected onto the current work plane to derive the xt and yt values of the origin. The zt value is the depth of the work plane, that is, the current depth.

- 2 To enter the coordinates of the new origin either in model space or in transform space (according to the setting of 1.15.2 DEFINITION SPACE MODAL):

```
DEFINITION SPACE                               Select transform or model coordinates.
1.TRANSFORM COORDINATES                       The transform space referred to here
2.MODEL COORDINATES                           depends on the operation being
                                                performed. If you chose 8.12.8 NEW
                                                ORIGIN, the space is the existing one
                                                you previously selected. If you chose
                                                8.12 DEFINE WORKSPACE menu choice
                                                1 to 7, transform refers to the space you
                                                have just created.
```

```
1.XT =                                         Enter the coordinates.
2.YT =
3.ZT =
```

```
1.X =
2.Y =
3.Z =
```

- 3 To screen select a point to serve as the origin.

```
INDICATE POINT OR IMPLICIT                     Select a new origin using the graphics
POINT                                          cursor.
```

- 4 To enter a displacement from the current origin. The displacement can be entered in either model space or transform space (according to the setting of 1.15.2 DEFINITION SPACE MODAL):

DEFINITION SPACE
 1.TRANSFORM COORDINATES
 2.MODEL COORDINATES

Select transform or model coordinates. The transform space referred to here depends on the operation being performed. If you chose 8.12.8 NEW ORIGIN, the space is the existing one you previously selected. If you chose 8.12 DEFINE WORKSPACE menu choices 1 to 7, transform refers to the space you have just created.

1.DELTA XT =
 2.DELTA YT =
 3.DELTA ZT =

Enter the coordinates.

1.DELTA X =
 2.DELTA Y =
 3.DELTA Z =

- 5 To set the origin of the workspace to the model space origin $x=y=z=0$.
- 6 To indicate which other workspace's origin will be used as the new origin. You select the space using the settings of 8.1.9 WORKSPACE SELECTION MODE, and it may or may not require additional input.

After defining the orientation of the new workspace, you can modify the origin of it (except if the workspace was created by entering the matrix or by defining a new origin):

MODIFY THE ORIGIN

Enter:

Y To modify the origin.

N To continue to the ASSOCIATE WITH VIEWS? prompt.

If you enter Y, the system presents the origin entry mode menu previously described under 8.12.8 NEW ORIGIN to allow the modification.

After the workspace definition is complete, the system checks to see if the same space has been previously defined. If it has, the system does not create a new one, but instead displays:

WORK SPACE ALREADY EXISTS AS (no.) (name)

If the space is a new one, the system assigns a number to it:

NEW WORK SPACE CREATED - NO. (number)

The system next asks if the workspace should be associated with views:

ASSOCIATE WITH VIEWS?

Enter:

Y To associate with views.

N To return to 8.12 DEFINE
WORKSPACE.

If you enter Y, you can associate the workspace using the setting of 8.1.10 VIEW ASSOCIATION MODE. The work name and axes displays are updated, if they are currently displayed.

The selected workspace should not be associated with the work view if the work plane would become perpendicular to the screen (some screen position inputs would produce a transform coordinate of infinity). The system displays:

WORK PLANE IS PERPENDICULAR TO THE SCREEN, ACKNOWLEDGE

Enter] to acknowledge the warning. You may still wish to use a perpendicular work plane, and you can choose to work this way. Any screen position input requests relating to the workspace made by the system are aborted as if you had entered [, and the system displays:

FUNCTION IS INVALID WHILE THE WORK PLANE IS PERPENDICULAR TO THE SCREEN. CHANGE -
WORK SPACE OR VIEW, ACKNOWLEDGE

8.13 Align View/Work Spaces

With this choice, you can change the workspace associated with every indicated view so that each is aligned with itself. That is, the workspace in view 1 becomes view 1, the workspace in view 2 becomes view 2, and so forth. Realignment causes the work plane depth to be set to 0. You indicate which views will be realigned using 8.1.10 VIEW ASSOCIATION MODE which may or may not require additional input. When you select this choice, the system displays:

ALL VIEWS ALIGNED

The following operations cannot be used unless the workspace is the view itself:

- 5.10 NESTING
- 7.2 PLOT
- 12.11 HIDDEN LINE REMOVAL
- 16 ANSI DRAFTING, except for 16.15 PROJECTED ENTITIES and 16.3 SECTION LINING
- 18 ANALYSIS

If you try to enter one of these functions while the view and workspace are not aligned, the system displays:

FUNCTION IS INVALID WHILE WORK PLANE IS NOT
ALIGNED WITH THE SCREEN. DO YOU WISH ALIGNMENT BE DONE?

Enter N to cancel the request for the function. Enter Y to align the work view only and enter the function.

Appendixes

Glossary	A-1
Uniplot Interface Utility Package	B-1
Files Used in ICEM DDN	C-1
ICEM DDN to ICEM TEKROUTE Interface	D-1
IGES-ICEM DDN (IGES V2.0, Translators V1.0)	E-1

Glossary

A

A

Active Tablet Page

A tablet page currently active on the upper or lower region of the fixed tablet overlay.

AD

The advanced design tablet overlay.

Alignment Point

A point displayed in alignment in views with differing scales. This point appears to have been unfolded about the fold line.

Alphanumeric

The letters of the alphabet (A through Z) and the digits (0 through 9).

ANSI

American National Standards Institute. English (U.S. Customary) dimensions are specified in feet and/or inches. Metric dimensions are specified in millimeters.

APT

The Automated Programmed Tooling system, which is a language used in defining part geometry and numerically controlled toolpaths.

Attention Indicator

A small oval that the system displays on an entity to indicate that the entity has been selected.

Attribute Text

User-assigned alphanumeric text associated with an entity. Attribute text is used to identify and describe an entity.

Auxiliary View

A view that can be user-defined. The standard views (top, bottom, right, left, front, back, isometric, and auxiliary) are defined by the system.

B

BFL

Basic function lower area of the main tablet overlay.

BFU

Basic function upper area of the main tablet overlay.

Blanking

A process applied to entities in the current part where the entities remain in the part, but are not displayed on the screen. Contrast with Deleting.

BULKIN

A file containing bulk data on a text record.

C

CANON

An ICEM DDN procedure for data base inspection.

CCLW

Counterclockwise.

CCW

Counterclockwise.

Chain Select

The process of selecting a series of contiguous curves.

Character Cell Background

A rectangular matrix in which a textual character is defined.

Character String

One or more contiguous text characters enclosed in single quotes.

CLW

Clockwise.

Contiguous Curves

Adjacent curves that share a common endpoint or that have endpoints within a short distance of each other.

Coordinate Axes

The lines that form a right-handed, three-dimensional frame of reference. The model axes (x, y, and z) and the transform axes (xt, yt, and zt) are referenced from a shared origin point in which $x=0$, $y=0$, and $z=0$.

Coordinate Space

A space created by the position (rotation and translation) of the coordinate axes. There are two types of coordinate space: model and transform.

Coordinates

The position of a point in relation to the x-, y-, and z- or xt-, yt-, and zt-axes.

Curve

A line, arc, conic, or two-dimensional spline. In some cases, it also includes points, three-dimensional splines, strings, composite curves, machining curves, and Bezier curves.

CW

Clockwise.

D

Data Base

An integrated set of files, tables, arrays, and other data structures.

Data Capture

The system capability to save as a variable either a default parameter value or a previously entered parameter value displayed on the screen.

Data Verification

The process of displaying the data associated with any entity.

DBM

The data base management tablet overlay.

DDIG

IPARTD-to-IGES translator.

Default Value

A value used by the system if] is entered in response to a data entry prompt. It is also the initial value assigned to a modal until it is changed.

Deleting

The removal of entities from the data base. Contrast with Blanking.

Depth

The current value of the workplane along the z- or zt-axis of the workspace.

Direct String

A string of menu commands and text less than or equal to 80 characters that is associated with a tablet page overlay square.

DIRJ

Disk-to-RJE utility.

DITA

Disk-to-Tape utility.

Dormant Entity

An entity created by the system for the purpose of defining another entity. Dormant entities cannot be displayed or manipulated. All dormant entities have sequence numbers.

E

Entity

The representation of a geometric construction in the ICEM DDN data base. Examples are points, lines, arcs, and spheres.

Entity Type Numbers

System-assigned code numbers used to identify specific entity types such as line, group, and copious data.

EOR

End of record.

F

Fold Line

An imaginary line of intersection between the view planes.

Font

The method used to represent a line or curve in a display. Examples of fonts are solid, dashed, phantom, and centerline.

G

GPARTS

The system default name of the global parts file.

GPL

A graphics programming language. See the ICEM Design/Drafting GPL manual.

Graphics Cursor

The cursor symbol used to locate or define entities by screen position. The graphics cursor can be crosshairs or some other cursor symbol.

GRAPL

A graphics programming language. See the ICEM Design/Drafting GRAPL Programming Language manual.

Grid

ICEM DDN-generated points used for screen position input.

GUTF

Global user technology file.

I

ICEM DDN

Control Data's integrated computer-aided engineering and manufacturing software application for design, drafting, and numerical control.

ICEMDDN

The name of the direct access file that contains ICEM DDN.

IGDD

IGES-to-IPARTD translator.

IGES

Initial Graphics Exchange Specification.

IGPROC

IGES translation utility procedure.

Implicit Point

A point automatically generated by the system at curve endpoints, midpoints, intersections, and circle centers.

INTE

INTERGRAPH transformation matrix compression utility.

IPARTD

Independent part file.

L

Level Management

A method of assigning entities to different levels for management purposes.

Level Number

A number assigned to a collection of entities.

Level Table

A table of levels and corresponding descriptive information about them.

LFN

Local file name.

LINE

A data file that can be interpreted by a mesh generator.

Local File

Any file that is currently associated with a job.

M

Max/Min

The coordinates of a position that are the upper right corner (xt max, yt max) and the lower left corner (xt min, yt min) on the screen after redisplay.

Menu

A list of options used to perform operations in ICEM DDN.

MESHFIL

The local file on which a mesh generator file is written.

Message

Text written by the system to display information, errors, or warnings. See also Prompt.

Modal

A user-assigned status or value that controls the operation of ICEM DDN. Examples are modals for setting system decimal places and for activating the grid.

Model Coordinate Space

The space created by the position of the x-, y-, and z-axes. This space is displayed as the front view, view 1. See Transform Coordinate Space.

MSTRING

A user-generated string of menu commands and text that resides on an MSTRING file.

MSTRING File

A user-generated, formatted text file external to ICEM DDN that contains named records of command strings.

N

N/C

Numerical control.

NC

The numerical control tablet overlay.

Normal

Perpendicular.

NOS

Network Operating System.

O

Operating System

The set of system programs that controls the execution of user programs and commands.

Operation Complete --]

A keyboard/tablet operation that completes the current operation.

Operation Reject -- [

A keyboard/tablet operation that rejects the previous operation. The system returns to the preceding prompt.

OPTIM

A program that reads plot data from TAPE9 and writes the optimized plot back to TAPE9.

P

Parameter

A variable whose values determine the operation or characteristics of a system.

Part Name

A series of alphanumeric characters that identify a part or drawing used in conjunction with a sheet number.

PATTERN

Default primary pattern library.

Pattern

A named set of entities that can be selected and saved in a pattern library. They can be retrieved and copied into a part at a specified point.

Pen Table

A table of pen numbers assigned to all entities in a part according to the level on which the entity resides or to its entity type.

Permanent File

A file saved by the system between terminal sessions.

Point

A geometric construction located by x-, y-, and z-coordinates.

Primary Library

The pattern library with which the user is currently working. This is the only library in which work can be created and deleted.

Prompt

A screen display requiring user action. See also Message.

PRU

Physical record unit.

R

RBF

Remote batch facility.

Region Select

A process of selecting all the entities within or outside a specified region.

Rescale

To change the scale factor and redraw a part using the new scale so all entities in the part are displayed.

RJDI

RJE-to-Disk utility.

RJE

Remote job entry.

Rotate

To revolve a construction about an axis.

RTL

Run-Time Library.

Run-Time Library (RTL)

The storage area for all variables defined by data capture, variable calculation, and program execution.

S

Scalar

A quantity that has magnitude only. Contrast with Vector.

Scale Factor

Ratio of the current display with respect to the data base.

SC1, SC2

The ICEM Schematics tablet overlays.

Secondary Library

A pattern library used as a resource library. Users can retrieve, copy, and list the patterns on the secondary library.

Sequence Number

A unique sequential number associated with each entity.

SF

The special functions tablet overlay.

Sheet Number

A subdivision of a part name. Sheets can be numbered from 0 to 9,999 with a part name.

Single Select

A process of selecting individual entities one at a time.

Standard Page

A preprogrammed tablet page that is always available for use.

Standard Page Overlay

The rectangular, colored plastic sheet with the symbols and text used to select pre-programmed menu choices from the tablet.

Standard Views

The system-generated coordinate systems from which the user can view a display of the part surfaces from these view points: front, back, top, bottom, right, left, isometric, and auxiliary.

System

The ICEM DDN software system.

T

Tablet Command File

The file from which user pages can be activated.

Tablet Edit File

A formatted file external to ICEM DDN containing records that represent tablet page information (page names and command strings).

Tablet Page

The record representing the set of direct strings or MSTRING assignments that define the functions associated with the squares of a tablet overlay page.

TADI

Tape-to-Disk utility.

TAPE3

A local file on which parts are filed and from which parts are retrieved.

Template

A named set of geometric entities that have two forms, masters and instances. A master is the shape to which the instances conform.

Temporary File

A nonpermanent file associated with a job only during job processing.

Text

Alphanumeric characters and symbols used in notes, labels, and dimensions.

TFILE

A local file containing user tablet pages.

Trace File

A file in which the step-by-step input by a user during a work session is recorded.

Transform Coordinate Space

The space created by the position of the xt-, yt-, and zt-axes. This space is displayed in any view other than view 1. See Model Coordinate Space.

Transformation of Coordinates

The mapping of the xt-, yt-, and zt-coordinates into the x-, y-, and z-coordinates.

U

Unblank

A procedure for making visible entities that have been blanked by the user.

UNILOT

A plotter program that converts data base information into x- and y-coordinates.

User Page

Tablet pages programmed by the user and stored on a tablet file.

User Page Overlay

A user-generated graphics representation of the functions programmed on a user page.

User Technology File (UTF)

The storage area for various products of 5 SPECIAL FUNCTIONS including defined character sets, source and object forms of GRAPL programs, level tables, and user text statements.

V

Variable Calculation

An operation in 5.2 GRAPL that calculates the value of an arithmetic expression and assigns that value to a user-specified variable.

Vector

A quantity that has magnitude and direction. It is commonly represented by a line segment with directionality. The line's length represents the magnitude and its orientation in space represents the direction. Contrast with Scalar.

View

A display of coordinate space.

View Alignment

The process of moving views so that they are placed as if they had been folded apart from a three-dimensional box surrounding them.

W

Work Plane

A specific plane in workspace on which two-dimensional entities are constructed.

Work View

The view in which screen input is accepted.

Workspace

The space in which entity construction and specification occurs.

Z

Z-Clip

The specification of parameters for the display of a drawing. Elements outside of the z-clip window are not displayed. No change occurs to those elements not displayed.

Zoom

To enlarge or decrease the size of the display proportionately.

UNIPLLOT Interface Utility Package

B

The UNIPLLOT interface of the ICEM DDN utility package converts drawing data into a file that UNIPOST can communicate as plotter information. The following steps outline the conversion procedure:

1. Once you are logged in to ICEM DDN, use menu 7.2 PLOT to create your drawings on the TAPE9 file. TAPE9 must be a local file, and you may wish to make a copy of it.
2. If you are using a pen plotter, you may use the OPTIM utility to minimize pen movement. This is an optional feature that uses these control statements:

```
GET,OPTIM/UN=usernum1
```

OPTIM

Optimizes the plotting file.

usernum1

User number under which the UNIPLLOT interface is installed.

OPTIM allows you to select either the x-axis or y-axis as the primary plot sort axis. This enables you to sort the plot file in one of two orders: y within x within pen color or x within y within pen. Your choice determines which axis the pen plot moves most frequently. Indicate your plot sort axis selection by means of the appropriate parameter setting (refer to the ICEM Design/Drafting Introduction and System Controls reference manual).

NOTE

- This option is not applicable to electrostatic plotters.
 - Because OPTIM both reads and writes a single plot record TAPE9, use a procedure file to copy each plot record from the permanent plot file to a local, temporary TAPE9. After OPTIM is run, TAPE9 can be plotted directly or copied to another permanent file before another plot record is processed. Copying each plot record ensures that the plot data is not damaged if OPTIM encounters an error.
 - Refer to 7.2 PLOT in this manual for more information on the OPTIM utility program.
-

3. Use the following sequence of control statements to convert the TAPE9 file to a form that UNIPOST can use.

GET,DDNUTIL/UN=usernum1

usernum1

User number under which the UNIPLLOT interface is installed.

GET,UNIPROC/UN=usernum2

usernum2

User number under which UNIPLLOT and UNIPOST are installed (APPLIB).

BEGIN,UNIPLLOT,UNIPROC,B=DDNUTIL,
D=device code

device code

Plotter device codes as listed in the UNIPLLOT Version 3 User's Guide/Reference Manual.

The preceding command not only runs DDNUTIL but also runs UNIPOST automatically. DDNUTIL reads the TAPE9 data and then writes an NPFILE (neutral profile file). UNIPOST reads the NPFILE and writes a PLOTf plot file specific to the plotter device code. (See figure B-1.)

4. You can now create the plot by copying the PLOTF file to your plotter device.

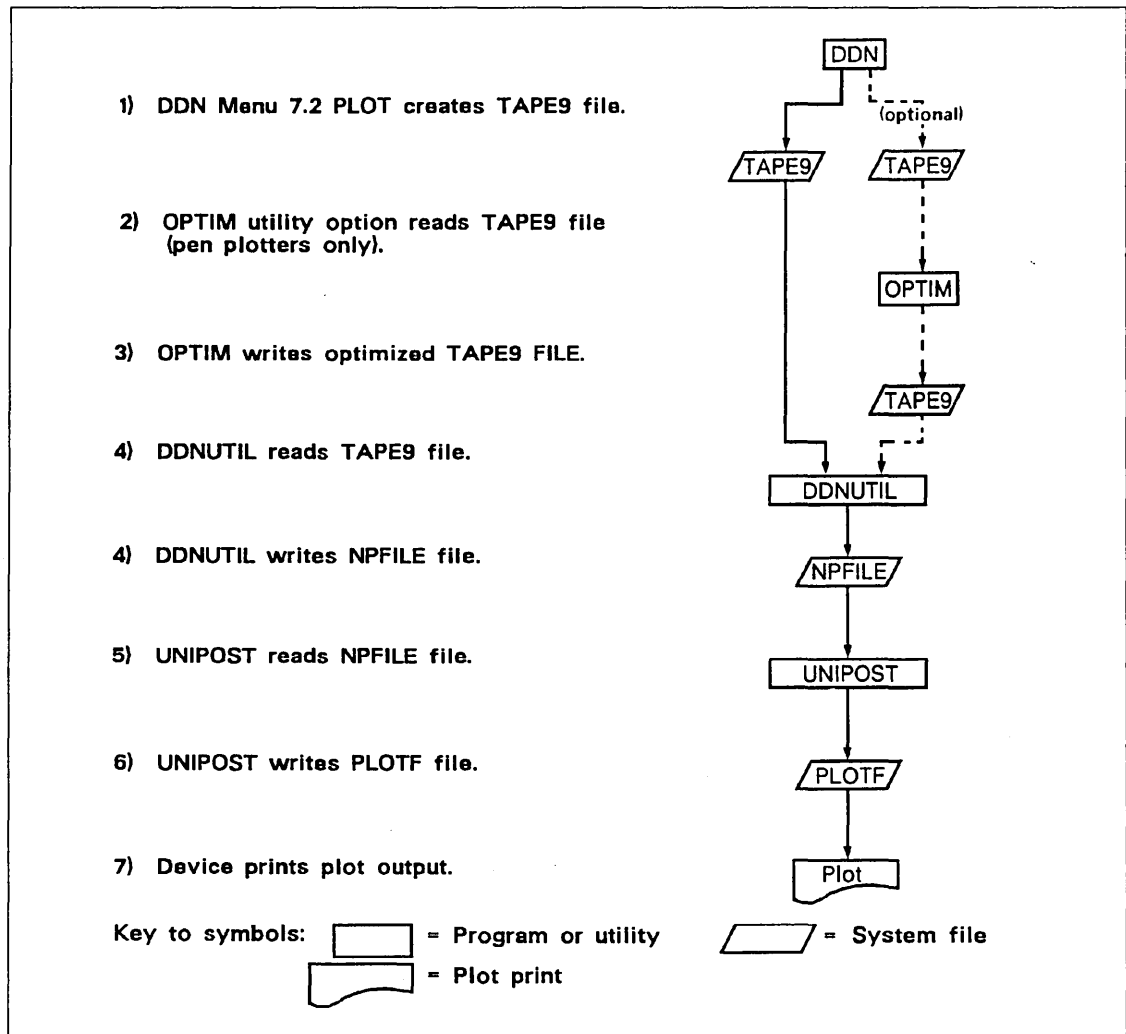

Figure B-1. Steps in Creating a Plot Using UNIPOST with the UNIPLOT Interface

Files Used in ICEM DDN

C

About 40 different local files are used in ICEM DDN. To avoid unwanted mixing of data, you should not use the local file names shown in table C-1.

Table C-1. ICEM DDN Local Files

File Name	In/Out	Menu Number	Use
AD20SCR	I/O	6.2.8	Delete global pattern
BULKIN	I	7.10	Bulk data input
CLFIN	I	7.1	Input CLFILE for interpretation
CLTAPE	O	7.1	Output CLFILE
CT	O	*	Overlay trace
DISPSC		7.1	Internal display scratch file
EDLLOG	O	-	EDL output file
EDITMD	I/O	17.11	View matrices for N/C editor
GPLLIB	I	5.13.3	GPL program library
GPARTS	O	6.1.1	Save part on global file
GPARTS	I	6.1.2	Retrieve part from global file
GRAIOF	I	5.2.2	Primary edit file for GRAPL source
GRAIOF	I	5.2.7	Input GRAPL to UTF
GRAIOF	O	5.2.8	Output GRAPL from UTF
GUTF	I	5.2.4	Global UTF for GRAPL object
GUTF	O	5.2.9	Global UTF for GRAPL object
GUTF	O	6.5.3	Global UTF for UTF SAVE
GUTF	I	6.5.4	Global UTF for UTF RESTORE
IPARTD	O	6.1.9	Independent part save
IPARTD	I	6.1.10	Independent part retrieve
IT	O	*	Input trace
LIST	O	5.6.4	Attributes of entities
LOCFIL		7.1	Local file
MESHFIL	O	7.12	Mesh generator
MCOUTI	I/O	17	Intermediate integer output for N/C macros
MCOUTR	I/O	17	Intermediate real output for N/C macros
MSTRING	I	7	Tablet menu strings (user generated)
MSDIR	I/O	7	MSTRING file directory (for system use only)
MT	O	*	Menu trace
OT	O	*	Output trace
PRINTR	O	5.2.3	AUTO GRAPL output file
PRINTR	O	7.1	CLPRNT output for line printer
PATTERN	I/O	6.2	Default primary pattern library
SCRATC		7.1	Internal scratch file
SCRATCH		6.1.1	Scratch file
SCRFIL		6.2	Scratch files used in patterns
SCRFIL2			
SCRFIL3			
SCRFIL4			

* Refer to the ICEM Design/Drafting Introduction and System Controls manual.

(Continued)

Table C-1. ICEM DDN Local Files (Continued)

File Name	In/Out	Menu Number	Use
TAPE3	I/O	*	Data base
TAP31	I/O	*	Data base scratch page storage
TAP32	I/O	*	Data base area
TAP33	I/O	*	Data base area
TAPE4	O	18.1.6	Spline analysis output for line printer
TAPE9	O	7.2	Plot file
TFILE	I/O	7.13	Tablet pages
XXXGPG	I/O	17	GPG insert statement file

* Refer to the ICEM Design/Drafting Introduction and System Controls manual.

Table C-2 shows the default file content limits.

Table C-2. Default File Content Limits

File Name	Contents Limited	Maximum Count*
GPARTS	Parts	100
PATTERN	Patterns	2048
TAPE3	Patterns	212
GUTF	UTFs	191

* In some cases, especially local parts, these limits may be exceeded.

ICEM DDN to ICEM TEKROUTE Interface

D

The ICEM DDN to ICEM TEKROUTE interface utility enables you to create mechanical drawings of the ICEM TEKROUTE circuit board and also to create the geometry section of the input file needed to run ICEM TEKROUTE. The ICEM DDN to ICEM TEKROUTE Version 1.1 interface translates an Initial Graphics Exchange Specification (IGES) file into a TEKROUTE readable input file. The IGES file is a standardized format file translated from the ICEM DDN Independent Part Definition (IPARTD) file.

Creating the Board Profile

To create the board profile, you must first use 5.5.1 CHANGE CURRENT LEVEL/PEN NUMBERS to change the level number to 1. Then proceed to create the profile lines using these guidelines:

- Use English measurements.
- Do not use splines or bezier curves.
- If you are creating the board profile in three-dimensional space, draw only the top face of the board on level 1.

Creating the Reference Point

The default reference points are the smallest x- and y-coordinates entered during the profile definition. You can enter a new reference point while translating from IGES to TEKROUTE. The system displays this prompt during translation:

```
THE REFERENCE POINT (0,0) IS PRESENTLY LOCATED AT THE SMALLEST X AND  
Y COORDINATES OF THE BOARD PROFILE. IF YOU WISH TO CHANGE THIS,  
PLEASE ENTER NEW COORDINATES (RELATIVE TO (0,0)). OTHERWISE JUST  
PRESS THE RETURN KEY.
```

```
ENTER X (IN MILS)  
?
```

After you enter a value or press the return key, the system displays this prompt:

```
ENTER Y (IN MILS)  
?
```

Creating Tooling Holes

You may create tooling holes in the board profile by drawing single 360-degree arcs. These guidelines should be kept in mind when creating tooling holes:

- Use 5.5.1 CHANGE CURRENT LEVEL/PEN NUMBERS to change to level 2 before creating tooling holes.
- Use 5.5.1 CHANGE CURRENT LEVEL/PEN NUMBERS to change to level 3 before attaching a signal name to a hole. Use 16.10 NOTE to write the signal name. The text string starting point must be inside the arc. If you wish to label an unconnected hole, enter the name TOOLHOLE. If you do not assign a name, the system assigns the default signal name TOOLHOLE and assumes that the hole is unconnected.
- Hole pads must also be drawn to create plated holes. The pads must be equal to or greater than the diameter of the tool holes.

Creating the Input File

After creating the drawing with ICEM DDN, you must create an IGES file by one of these methods:

- If you are running ICEM DDN on ICEM Engineering Data Library (EDL), exit from ICEM DDN and use EDL to convert the TAPE3 drawing file to an IGES file. See the EDL Version 1 Reference Manual for more information.
- If you are not running ICEM DDN on EDL, use 6.1.9 INDEPENDENT SAVE to create an IPARTD file. When exiting from ICEM DDN, create an IGES file, using the procedures described in appendix D of this manual.

Running TEKROUTE

After you have created and defined the IGES file, you begin running TEKROUTE. The system prompts you for information on the appropriate baud rate, terminal type, and schematics file name. The system next prompts:

```
ENTER IGES BOARD GEOMETRY FILE NAME  
OTHERWISE JUST PRESS THE RETURN KEY.  
?
```

Enter the file name of your IGES geometry input file. You are now ready to continue running TEKROUTE. See the ICEM TEKROUTE Reference Manual for more details.

IGES-ICEM DDN (IGES V2.0, Translators V1.0)

E

This section of the manual has been revised and is now found in the IGES Translators Reference Manual, publication number 60463050.

Index

Index

A

Active tablet page A-1
 AD A-1
 AD20SCR C-1
 Alignment point A-1
 Alphanumeric A-1
 ANSI A-1
 APPLIB B-2
 APT A-1
 Arc
 Polar from an arc 1-54
 Attention indicator A-1
 Attribute
 Names 1-34
 Values 1-35
 Attribute data format 1-49
 Attribute management 1-30
 Conditional search 1-44
 Copy 1-42
 Create 1-31
 Delete 1-35,43
 Display 1-43
 Identify 1-43
 Insert new attributes 1-34
 List on file 1-46
 Modify 1-32
 Replace 1-35
 Report generation 1-47
 Search 1-44
 Subattributes 1-31
 Attribute text A-1
 Auto GRAPL 1-13
 Auxiliary view A-1

B

BFL A-1
 BFU A-1
 Blanking A-1
 Bulk data input 3-10
 Continue input 3-16
 Control commands 3-11
 Error messages 3-16
 Start input 3-16
 BULKIN 3-10; A-2; C-1

C

CANON 1-3; A-2
 CCLW A-2
 CCW A-2
 Chain select A-2

Change current level/pen numbers 1-25
 Change depth 4-23
 Change part status 2-18
 Character cell background A-2
 Character string A-2
 Check current part 2-24
 CLFIN C-1
 CLTAPE C-1
 CLW A-2
 COMMON 2-80
 Contiguous curves A-2
 Coordinate axes A-2
 Coordinate space A-2
 Coordinates A-2
 Copy attributes 1-42
 Copy view
 New name 4-52
 Create/assign level table 1-28
 Create/modify pen table 1-29
 Creating tablet pages 3-21
 Creating the board profile D-1
 Creating the input file D-2
 Creating the reference point D-1
 Creating tooling holes D-2
 CT C-1
 Curve A-2
 CW A-2

D

Data base 2-71; A-3
 COMMON 2-80
 Current part space 2-76
 Dump current part 2-79
 Entity information 2-72
 Management 2-1
 Pack part operation 2-21
 Part file space 2-76
 Pattern file space 2-77
 UTF space 2-77
 Data base management
 Menu 2-1
 Data capture A-3
 Data verification A-3
 DBM A-3
 DDIG A-3
 DDNUTIL B-2,3
 Default value A-3
 Define
 Auxiliary view 4-65
 Current display as layout 4-30
 Levels 1-26
 Symbol 1-22
 Workspace 4-70

Delete

- Layout 4-65
- Level number 1-27
- Part 2-17
- Symbol 1-23
- UTF file 2-68
- View 4-52,61
- Deleting A-3
- Depth A-3
- Depth, change 4-23
- Depth entry mode 4-7
- Direct string A-3
- DIRJ A-3
- Display
 - Attributes 1-43
 - Entities N1 to N2 3-8
 - Entity #N 3-8
 - Entity seq. no. 3-8
 - Four quadrants 4-28
 - Four views
 - Top/front/right/isol 4-29
 - Last seq. no. used 3-8
 - Modals 4-6
 - Multiple views 4-25
 - Previous layout 4-25
 - Previous multiview 4-26
 - Single view 4-23
 - Symbol 1-24
 - TAB1 1-4
 - TAB2 1-7
 - TAB3 1-7
 - Two views
 - Front/right 4-29
 - Left and right 4-28
 - Top and bottom 4-26
 - Top/front 4-28
 - View layout name 4-26
 - Views one through eight 4-29
 - Zt region 4-68
- Display control
 - Depth 4-3
 - Global zoom scale 4-4
 - Isometric drafting 4-5
 - Menu 4-1
 - Modals 4-6
 - View 4-3
 - View layout 4-3
 - View modals 4-4
 - Window 4-3
 - Work view 4-3
 - Zoom 4-3
- Display/depth control 4-7
- Display last sequence number used 3-8
- Display modals
 - Menu 4-9
 - Model axes 4-16
 - Rescale 4-13
 - View association 4-20
 - View border 4-14
 - View modal status 4-17
 - View name 4-15

- View placement method 4-22
- View selection 4-9
- Work axes display 4-22
- Work name display 4-21
- Workspace selection 4-18
- Zoom origin 4-11
- Display name management
 - Menu 4-59
- Display view modals
 - Menu 4-17
- DISPSC C-1
- DITA A-3
- Dormant entity A-3
- Dump current part 2-79

E

- Edit/save page
 - Assign MSTRING name to square 3-30
 - Copy square 3-36
 - Define square 3-28
 - Delete square 3-37
 - Display page 3-38
 - List square 3-34
 - Move square 3-35
 - Save page and continue 3-38
 - Save page and exit 3-38
- EDITMD C-1
- EDLLOG C-1
- Entity A-3
 - Count per level 2-73
 - Count per view 2-72
 - Data in view and level range 2-75
 - Information 2-72
 - Master list 1-4
 - Type numbers 1-6; A-3
 - Types in view and level range 2-73
- Entity names
 - Attach name to entity 1-67
 - Detach name from entity 1-67
 - List names 1-66
 - Search for name 1-68
- EOR A-4
- Execute pen table 1-29

F

- File space
 - Part 2-76
 - Pattern 2-77
 - User technology file (UTF) 1-14; 2-67
- Files used in ICEM DDN C-1
- Fold line A-4
- Font A-4

G

Girth point 1-53
 Global attribute modification 1-36
 Global file restore 2-9
 All 2-11
 Change file name 2-14
 Edit 2-13
 List 2-12
 Pack file 2-13
 Part overwrite mode 2-14
 Single 2-9
 Global file save 2-3
 All 2-5
 Change file name 2-8
 Edit 2-7
 List 2-6
 Pack file 2-7
 Part overwrite mode 2-8
 Single 2-4
 Global UTF
 Restore 2-70
 Save 2-69
 GPARTS A-4; C-1
 GPL 1-69; A-4
 Change library name 1-70
 Continue program 1-69
 List names 1-69
 Recover last file 1-69
 Run program 1-69
 GPLLIB C-1
 GRAIOF 1-17; C-1
 Graphics cursor A-4
 Graphics programming language (see also
 GPL) 1-69
 GRAPL A-4
 Auto GRAPL 1-13
 Continue program 1-14
 Delete from UTF 1-14
 Input/Edit 1-11
 Input to GUTF 1-16
 Input to UTF 1-15
 Menu 1-10
 Output from UTF 1-15
 Program 1-10
 Run program 1-14
 Text editing commands 1-11
 Variable calculation 1-10
 Grid 1-19; A-4
 GUTF A-4; C-1

H

Hardcopy, zoom 4-40

I

ICEM DDN A-4
 ICEM TEKROUTE Interface D-1
 ICEMDDN A-4
 Identify, entities N1 to N2 3-8
 Identify, entity #N 3-8
 IGDD A-4
 IGES A-4
 IGES-ICEM DDN E-1
 IGPROC A-5
 Implicit point A-5
 Independent restore 2-22
 Independent save 2-21
 Initialize
 UTF 2-71
 Input/Output/Regeneration
 Menu 3-1
 Inspect common values 2-80
 Instance, template
 Base entities and attributes 2-65
 Create 2-64
 Point-set curve 2-65
 Unlink 2-65
 INTE A-5
 Integer array 2-80
 Integer array/common values 2-81
 IPARTD A-5; C-1
 Isometric drafting 4-5
 IT C-1

L

Layout
 Delete 4-65
 List 4-64
 List views 4-64
 Rename 4-63
 Level management A-5
 Menu 1-25
 Level number A-5
 Level table A-5
 Create/assign 1-28
 Name 1-26
 LFN A-5
 Library, pattern 2-26
 Line
 At angle with a curve 1-53
 LINE A-5
 List
 Level names 1-27
 On-line part file 2-15
 On-line templates 2-66
 Pattern 2-45
 Primary pattern library 2-46
 Secondary pattern library 2-47
 Symbols 1-24
 Templates 2-66

UTF 2-68
 Views 4-60
 LIST C-1
 List on file 1-46
 Local file A-5
 LOCFIL C-1

M

Major word 3-11
 Management
 Attribute 1-30
 Part 2-2
 Pattern 2-26
 Master template
 Delete 2-62
 Redefine 2-61
 Unlink 2-60
 Max/min A-5
 MCOUTI C-1
 MCOUTR C-1
 Menu A-5
 Data base management 2-1
 Define workspace 4-70
 Display control 4-1
 Display modals 4-6
 Display name management 4-59
 Display view modals 4-17
 GRAPL 1-10
 Input/Output/Regeneration 3-1
 Level management 1-25
 Model axes display mode 4-16
 Part management 2-2
 Pattern management 2-26
 Rescale entry mode 4-13
 Special functions 1-1
 Template management 2-57
 View border display mode 4-14
 View layout construction 4-43
 View name display mode 4-15
 View selection mode 4-9
 Work space selection mode 4-18
 Zoom origin mode 4-11
 Zoom scale 4-67
 Zoom single view 4-34
 Mesh generator interface 3-19
 Curves 3-19
 Surfaces 3-20
 MESHFIL 3-20; A-5; C-1
 Message A-5
 Minor word 3-11
 Misc. Construction 1-53
 Modal A-6
 Model axes display mode
 Menu 4-16
 Model coordinate space A-6
 Modification commands 1-33
 Modification line 1-33
 MSDIR C-1

MSTRING A-6; C-1
 MSTRING file A-6
 MT C-1

N

N/C A-6
 Name a view 4-59
 NC A-6
 Nesting
 Absolute 1-57
 Adjustment placement 1-65
 Boundary plate 1-55
 Create/modify mode 1-55
 Delete part 1-63
 Kerf distance 1-54
 Original placement 1-56
 Regional translate-rotate 1-62
 Relative to plate 1-60
 Relative to single check curve 1-61
 Relative to two check curves 1-61
 Normal A-6
 NOS A-6
 NPFILE B-2,3

O

Operating system A-6
 Operation complete (I) A-6
 Operation reject (I) A-6
 OPTIM 3-7; A-6; B-1,3
 OT C-1

P

Pack part 2-21
 Parameter A-6
 Part integrity 2-23
 Part management
 Change part status 2-18
 Check current part 2-24
 Delete 2-17
 Edit 2-7
 Global file restore 2-9
 Global file save 2-3
 List on-line part file 2-15
 Menu 2-2
 Merge, entity name deletion 2-21
 Merge into current part 2-19
 Merge, origin mode 2-20
 Pack 2-21
 Part integrity 2-23
 Rename current part 2-16
 Renew current part 2-25
 Part name A-7
 Pattern A-7

PATTERN A-7; C-1
 Pattern management
 Change primary library 2-53
 Change secondary library 2-54
 Copy 2-48
 Create 2-37
 Delete 2-44
 List 2-45
 Menu 2-26
 Pattern modals 2-27
 Copy overwrite mode 2-36
 Restore retrieve modals 2-36
 Retrieve 2-39
 Pen number
 Entity type 1-29
 Level number 1-29
 Pen number table
 Create/modify 1-29
 Execute 1-29
 Name 1-29
 Pen table A-7
 Permanent file A-7
 Pipework interference 1-68
 Plot 3-2
 Plot file
 Access method 3-2
 Multiple view plotting 3-6
 Paper size specification 3-3
 Plotter optimization 3-7
 Position of plot 3-4
 Single view plotting 3-5
 PLOT file B-2,3
 Plotting
 Multiple view 3-6
 Optimization 3-7
 Paper size (English) 3-3
 Paper size (Metric) 3-3
 Position 3-4
 Single view 3-5
 Point A-7
 PP library codes 2-69
 PP library words 2-69
 Previous layout function 4-25
 Previous multiview function 4-26
 Primary library A-7
 PRINTR C-1
 Prompt A-7
 PRU A-7

R

RBF A-7
 Real array 2-82
 Real array/common values 2-83
 Redefine
 Base scale 4-37

Regenerate
 All 3-9
 Entities N1 to N2 3-9
 Entity #N 3-9
 Region select A-7
 Renew current part 2-25
 Report generation
 Attributes 1-47
 Formatting 1-49
 Retrieving entities 1-47
 Report ordering
 Subattribute name 1-48
 Subattribute value 1-48
 Rescale A-7
 Rescale entry mode
 Menu 4-13
 Restore
 Global UTF 2-70
 Parts 2-22
 UTF files 2-70
 Retrieve modals
 Color 2-34
 Entity grouping 2-31
 Entity names 2-35
 Level 2-32
 Orientation 2-30
 Origin method 2-28
 Pen 2-33
 Rotation angle 2-29
 Rotation axis 2-30
 Scale factor 2-29
 Set when used 2-35
 Retrieve pattern 2-39
 Origin method 2-40
 RJDI A-7
 RJE A-7
 Rotate A-7
 RTL A-8
 Run GRAPL program 1-14
 Run-time library (RTL) A-8
 Running TEKROUTE D-2

S

Save
 Global UTF 2-69
 Parts 2-21
 Scalar A-8
 Scale factor A-8
 SCRATC C-1
 SCRATCH C-1
 Screen position 1-54
 SCRFIL C-1
 SCRFIL2 C-1
 SCRFIL3 C-1
 SCRFIL4 C-1
 SC1, SC2 A-8
 Secondary library A-8
 Sequence number A-8

SF A-8
 Sheet number A-8
 Single select A-8
 Special functions
 Menu 1-1
 Standard page A-8
 Overlay A-8
 Standard views A-8
 Subattribute
 Maximum 1-45
 Minimum 1-45
 Names 1-36
 Types 1-31
 Values 1-35,36
 Symbol
 Define or replace 1-22
 Delete 1-23
 Display 1-24
 List 1-24
 Terminate 1-21
 User-defined 1-19
 System A-8

T

Tablet
 Command file A-9
 Edit file A-9
 Pages 3-21
 Programming strings 3-46
 Tablet management 3-21
 Change edit file 3-44
 Copy pages from another file 3-45
 Create page 3-26
 Delete page 3-41
 Display page 3-42
 Edit/save page 3-28
 List pages in edit file 3-43
 Modify page 3-27
 Pack edit file 3-44
 Rename page 3-39
 Tablet modals 3-22
 Tablet modals
 Page display area 3-24
 Page display status 3-23
 Square overwrite mode 3-23
 String display format 3-24
 Tablet file status 3-25
 Tablet page 3-20; A-9
 Tablet string programming
 Commands 3-46
 Control characters 3-51
 Embedded control characters 3-50
 Embedded text entry 3-51
 Lowercase text entry 3-50
 Repeated menu sequences 3-49
 String variables 3-49
 Variable menu/text entry 3-48
 TAB1 1-3

TAB2 1-3
 Modify 1-8
 TAB3 1-3
 Modify 1-8
 TADI A-9
 TAPE11 3-7
 TAPE3 A-9; C-2
 TAPE4 C-2
 TAPE9 3-7; B-1,2,3; C-2
 TAP31 C-2
 TAP32 C-2
 TAP33 C-2
 TEKROUTE
 Running D-2
 TEKROUTE interface D-1
 Template A-9
 Template management 2-56
 Create in UTF 2-58
 Delete from UTF 2-63
 List 2-66
 Menu 2-57
 Retrieve from UTF 2-59
 Temporary file A-9
 Terminate
 Symbol 1-21
 Text A-9
 Text editing commands 1-52
 GRAPL 1-11
 Text entry 1-52
 TFILE A-9; C-2
 Trace file A-9
 Transform coordinate space A-9
 Transformation of coordinates A-9

U

Unblank A-9
 UNIPLLOT A-9; B-2,3
 UNIPOST B-2,3
 Updating pattern libraries 2-55
 User-defined symbols 1-19
 User-defined tablet page 3-21
 User page A-9
 Overlay A-10
 User technology file (UTF) 2-67; A-10
 Delete file 2-68
 File space 2-77
 Initialize 2-71
 List 2-68
 Management 2-67
 Restore files 2-70
 Save files 2-69
 User text entry 1-52
 UTF list 2-68
 Utility package (UNIPLLOT interface)
 B-1,3

V

Variable calculation 1-10; A-10
 Variables
 List RTL variables 1-18
 List UTF variables 1-18
 Management 1-17
 Move from RTL to UTF 1-18
 Move from UTF to RTL 1-17
 Vector A-10
 Verify screen position 1-54
 View A-10
 View alignment A-10
 View association mode
 Menu 4-20
 View border display mode
 Menu 4-14
 View layout
 Add view 4-50
 Align views 4-55
 Blank view 4-51
 Copy under new name 4-52
 Delete view 4-51
 Modals 4-44
 Modify name 4-51
 Move window 4-45
 Place format around 4-53
 Replace view 4-50
 Stretch window 4-46
 Unblank view 4-51
 View layout construction 4-42
 Menu 4-43
 View name display mode
 Menu 4-15
 View placement method
 First angle projection 4-22
 Third angle projection 4-22
 View selection mode
 Menu 4-9
 View transformation matrix 2-78
 View window
 Move 4-45
 Stretch 4-46

W

Work axes display modal 4-22
 Work name display
 Menu 4-21
 Work plane A-10
 Work view A-10
 Change 4-30

Workspace A-10
 Align view/workspaces 4-77
 Change 4-69
 Define 4-70
 Enter matrix 4-72
 New origin 4-74
 Parallel to plane 4-71
 Rotations about axes 4-71
 Selection mode 4-18
 Through a point and along a line
 4-73
 Through a point and perpto a line
 4-72
 Through three points 4-73
 Through two lines 4-73

X

XXXGPG C-2

Z

Z-Clip 4-68; A-10
 Zoom 4-31; A-10
 Change mode 4-41
 Menu 4-34
 Name scale 4-38
 Single view
 Auto max/mins 4-37
 Change page 4-39
 Diagonal screen positions 4-36
 Double scale 4-36
 Enter max/mins 4-37
 Enter scale 4-36
 From hard copy 4-40
 Half scale 4-36
 New center 4-34
 New center, enter scale 4-35
 New corner, enter scale 4-35
 New lower left corner 4-35
 Redefine base scale 4-37
 Return to base scale 4-34
 Zoom origin mode
 Menu 4-11
 Zoom scale
 Delete 4-63
 List 4-62
 Menu 4-67
 Rename 4-62
 Retrieve named scale 4-38
 Zoom scale name 4-38

Please fold on dotted line;
seal edges with tape only.

FOLD

FOLD

FOLD



NO POSTAGE
NECESSARY
IF MAILED
IN THE
UNITED STATES



BUSINESS REPLY MAIL

First-Class Mail Permit No. 8241 Minneapolis, MN

POSTAGE WILL BE PAID BY ADDRESSEE

CONTROL DATA

Publications & Graphics Division

ARH219

4201 N. Lexington Avenue

Arden Hills, MN 55126-6198



We value your comments on this manual. While writing it, we made some assumptions about who would use it and how it would be used. Your comments will help us improve this manual. Please take a few minutes to reply.

Who are you?

- Manager
- Systems analyst or programmer
- Applications programmer
- Operator
- Other _____

How do you use this manual?

- As an overview
- To learn the product or system
- For comprehensive reference
- For quick look-up

What programming languages do you use? _____

How do you like this manual? Check those questions that apply.

- | Yes | Somewhat | No | |
|--------------------------|--------------------------|--------------------------|--|
| <input type="checkbox"/> | <input type="checkbox"/> | <input type="checkbox"/> | Is the manual easy to read (print size, page layout, and so on)? |
| <input type="checkbox"/> | <input type="checkbox"/> | <input type="checkbox"/> | Is it easy to understand? |
| <input type="checkbox"/> | <input type="checkbox"/> | <input type="checkbox"/> | Is the order of topics logical? |
| <input type="checkbox"/> | <input type="checkbox"/> | <input type="checkbox"/> | Are there enough examples? |
| <input type="checkbox"/> | <input type="checkbox"/> | <input type="checkbox"/> | Are the examples helpful? |
| | | <input type="checkbox"/> | Too simple? <input type="checkbox"/> Too complex? |
| <input type="checkbox"/> | <input type="checkbox"/> | <input type="checkbox"/> | Is the technical information accurate? |
| <input type="checkbox"/> | <input type="checkbox"/> | <input type="checkbox"/> | Can you easily find what you want? |
| <input type="checkbox"/> | <input type="checkbox"/> | <input type="checkbox"/> | Do the illustrations help you? |
| <input type="checkbox"/> | <input type="checkbox"/> | <input type="checkbox"/> | Does the manual tell you what you need to know about the topic? |

Comments? If applicable, note page and paragraph. Use other side if needed.

Would you like a reply? Yes No

From:

Name _____

Company _____

Address _____

Date _____

Phone _____

Please send program listing and output if applicable to your comment.