



AT&T

AT&T UNIX™ PC

DOS Coprocessor

ALLOY DOS - 73™

User's Guide

**FEDERAL COMMUNICATIONS COMMISSION
RADIO INTERFERENCE STATEMENT**

WARNING: This equipment has been certified to comply with the limits for a Class B computing device, pursuant to Subpart J of Part 15 of FCC Rules. Only peripherals (computer input/output devices) certified to comply with the Class B limits may be attached to this equipment. Operation with non-certified peripherals is likely to result in interference to radio and TV reception.

INSTRUCTIONS TO USER: This equipment generates and uses radio frequency energy and if not installed properly, that is, in strict accordance with the manufacturer's instructions, may cause interference to radio and TV reception. It has been tested and found to comply with the limits for a Class B computing device in accordance with the specifications in Subpart J of Part 15 of FCC Rules, which are designed to provide reasonable protection against such interference in a residential installation. However, there is no guarantee that interference will not occur in a particular installation. If this equipment does cause interference to radio or television reception, which can be determined by turning the equipment on and off, the user is encouraged to try to correct the interference by one or more of the following measures:

- o Reorient the receiving antenna.
- o Relocate the equipment with respect to the receiver.
- o Relocate the equipment away from the receiver.
- o Plug the receiver into a different outlet so that equipment and receiver are on different branch circuits.

If necessary, the user should consult the dealer or an experienced radio/television technician for additional suggestions.

The Federal Communications Commission has prepared a booklet entitled "How to Identify and Resolve Radio-TV Interference Problems." This booklet is available from the U.S. Government Printing Office, Washington, D.C. 20402, Stock No. 004-000-00345-4.

NOTE: Use of a shielded interface cable is required to comply with FCC Class B subpart J of Part 15 rules.

AT&T SERVICE INFORMATION

All of the documentation for this AT&T Product has been carefully written to cover most all of the questions that may arise during normal use.

For assistance in areas not covered in the documentation, and requests for media replacement under the limited warranty, a toll free hotline is available during normal business hours. The hotline will assist with usage and problem diagnosis for a period of 90 days after the date of purchase, delivery, or AT&T provided installation, whichever is latest **provided that a completed Registration Card is returned within 5 days** of that date. PLEASE remember to return the registration card as it will enable the mailing of updates when necessary.

For assistance call AT&T at: **800-922-0354**. Outside the Continental USA call: **201-668-6025**.

Or write:

**AT&T Customer Systems Support
Department 7
P.O. Box 8355
Iselin, New Jersey 08830**

Frequently a problem can be diagnosed more accurately if AT&T technical personnel can remotely access the computer on which the software is executing. Please connect your AT&T UNIX™ PC to a telephone line as outlined in the Telephone Manager documentation.

When you call or write, be sure to provide the 16 character serial number of the AT&T Product. The serial number can be found on the disk label. Also mention:

- the date of purchase, delivery or date of AT&T installation
- your name and telephone number
- computer location
- your company name
- how purchased (either directly from AT&T or through an authorized AT&T dealer)

Additional assistance programs are available from AT&T. These include hotline service and updates beyond the initial 90 day period as well as a variety of on-site options. Contact your AT&T Account Manager, or call 800-922-0354 for further information.

Please record your DOS-73 serial number and file this card in a safe location.

DOS-73 Serial Number 405049750-0025671



AT&T

AT&T UNIX™ PC

DOS Coprocessor

ALLOY DOS - 73™

User's Guide

**(c) 1985 AT&T
ALL RIGHTS RESERVED
Printed in USA**

NOTICE

The information in this document is subject to change without notice. AT&T assumes no responsibility for any errors that may appear in this document.

DOS-73 is a Trademark of ALLOY COMPUTER PRODUCTS, INC.

UCP-11 is a Trademark of ALLOY COMPUTER PRODUCTS, INC.

Hercules is a Trademark of Hercules Corp.

IBM is a Trademark of International Business Machines

IBM PC is Trademarks of International Business Machines

PC-DOS is Trademarks of International Business Machines

LOTUS, 1-2-3 and Symphony are Trademarks of LOTUS Development Corporation

MS-DOS is a Trademark of MicroSoft Corporation

Smartmodem is a Trademark of Hayes Microcomputer Products, Inc.

DOS-73

TABLE OF CONTENTS

SECTION 1 -- INTRODUCING DOS-73

Introducing DOS-73	1-1
System Features	1-2
DOS-73 Help Feature	1-3
Guide To The Manual	1-4
Documentation Conventions	1-7

SECTION 2 -- DOS-73 INSTALLATION

Overview	2-1
Before Installing Your DOS-73 System	2-2
Inventory Checklist	2-2
Handling the DOS-73 Hardware	2-3
Necessary Tools	2-3
DOS-73 Hardware Installation	2-4
DOS-73 Software Installation	2-6
8087 Upgrade	2-10
DOS-73 Software Removal	2-11
Removing DOS-73 Virtual Disks	2-11
DOS-73 Hardware Removal	2-12

SECTION 3 -- DOS-73 UTILITIES

Overview	3-1
Formatting DOS Diskettes	3-3
Adding DOS Applications to the Menu	3-4
Remove DOS Applications from Menu	3-8
Configuring A DOS-73 Session	3-10
DOS-73 Volume Management	3-14
Remcving a Virtual Disk	3-16

TABLE OF CONTENTS

SECTION 4 -- DOS-73 OPERATION

Overview	4-1
Using The DOS-73 System	4-2
Running A DOS-73 Session	4-3
Running Specific DOS Applications	4-4
Error Messages	4-5
Exiting DOS-73	4-6
Re-Loading DOS	4-6
Suspending a DOS-73 Session	4-7

SECTION 5 -- DOS-73 KEYBOARD / VIDEO

Overview	5-1
The Keyboard	5-2
Keyboard Overlays	5-2
On-Line Keyboard Layout	5-3
Alternate CTRL Key	5-5
The DOS-73 Screen Keys	5-6
DOS-73 Screen Presentation	5-8
ANSI.SYS	5-8
DOS-73 Screen Graphics	5-8
Remote Terminal Support	5-9

SECTION 6 -- DOS-73 EXTERNAL DEVICES

Overview	6-1
Printing With DOS-73	6-2
Printer Support	6-2
AT&T Printers	6-2
PM (Printer Management)	6-3
Initializing the COM2: Serial Port	6-4
DOS-73 Modem Communication	6-5
Internal UNIX PC Modem	6-5
External COM2: Modem	6-5
Mouse	6-6

TABLE OF CONTENTS

SECTION 7 -- DOS-73 FILES & DISK VOLUMES

Overview	7-1
Virtual Disks	7-2
DOS Volumes	7-2
Floppy Disks	7-3
The UNIX Volume	7-4
Special Considerations	7-4
Filenames	7-5
DOS Subdirectories	7-6
The DIR Command	7-7
The Type Command	7-8
File Re-Direction	7-8

--- APPENDICES ---

APPENDIX A	-- APPLICATIONS COMPATIBILITY and INSTALLING LOTUS 1-2-3
APPENDIX B	-- DOS UTILITIES
APPENDIX C	-- DIAGNOSTICS
APPENDIX D	-- DOS-73 SYSTEM FILES
APPENDIX E	-- MEMORY MAP
APPENDIX F	-- COM2: PINOUTS

--- GLOSSARY ---

--- INDEX ---

SECTION 1

INTRODUCING DOS-73

The DOS-73™ System gives you the best of both computer worlds -- UNIX and DOS. With DOS-73 you can run most of the programs on your AT&T UNIX PC that can be run on the AT&T 6300 and other IBM PC compatibles.

There are thousands of programs available in the DOS format. These include Spreadsheets, Data Based Management Systems, Word Processors, Mathematical Problem Solvers, and many more. Most of them are available now for use on the AT&T UNIX PC.

If you are familiar with DOS, you can start to use the DOS-73 System as soon as it is installed. Within a few minutes after you unpack the DOS-73 System you can be running your favorite DOS program on your UNIX PC.

SYSTEM FEATURES

The **DOS-73 HARDWARE** is a UNIX PC coprocessor card equipped with an 8 Mhz, 8086 CPU, which can be augmented by an optional 8087 Numeric Data Processor. The DOS-73 Hardware has 512 KBytes of main memory - to handle even the largest and most sophisticated DOS applications.

In addition to supporting the UNIX PC peripherals, the DOS-73 Hardware supports its own independent I/O in the form of an RS-232C asynchronous serial port configured as COM2:. This port can be used for a local serial printer, an external modem, or any other serial device.

The **DOS-73 SOFTWARE** implements MS-DOS 3.1 as a task on the UNIX PC, using the DOS-73 hardware to emulate an IBM PC with Hercules graphics. A DOS-73 Session can run on the UNIX PC monitor and keyboard or as a remote task with an auxiliary terminal.

With the DOS-73 Software you can create up to 256 Virtual Disks. DOS-73 Virtual disks are UNIX files that are created with the DOS-73 Volume Management utility. Up to 12 Virtual disks (per user) can be assigned to DOS Volumes (C: - N:). DOS volumes are logical disk drives. These volumes are treated the same as volumes on an IBM PC.

DOS-73 uses the UNIX PC floppy disk drive to access DOS compatible diskettes. While running DOS-73 the floppy drive is referred to as the A: and/or B: drive.

To allow data interchange between the DOS file system and the UNIX file system, DOS-73 allows you to assign one volume as a UNIX disk.

DOS-73 Uses the UNIX PC internal modem to provide Hayes compatible 300/1200 baud modem support for DOS programs.

DOS-73 HELP FEATURE

DOS-73 ON-LINE HELP

The DOS-73 System provides a full function and cross-referenced on-line HELP facility. HELP screens can be accessed from both the "DOS-73" and "DOS-73 Utilities" windows, as well as from within a DOS-73 Session.

From either the DOS73 or the DOS73 Utilities window, select an item and press the <HELP> key, or point to the '?' icon, and press the <B1> button (the left button of the UNIX PC mouse).

From within a DOS Session, HELP is accessed by pressing the <HELP> key.

Once the DOS-73 HELP has been selected, a Table of Contents can be called by pressing screen key (F1). From the Table of Contents you can select HELP for any of the topics listed. When invoked, the HELP Table of Contents will display the following screen:

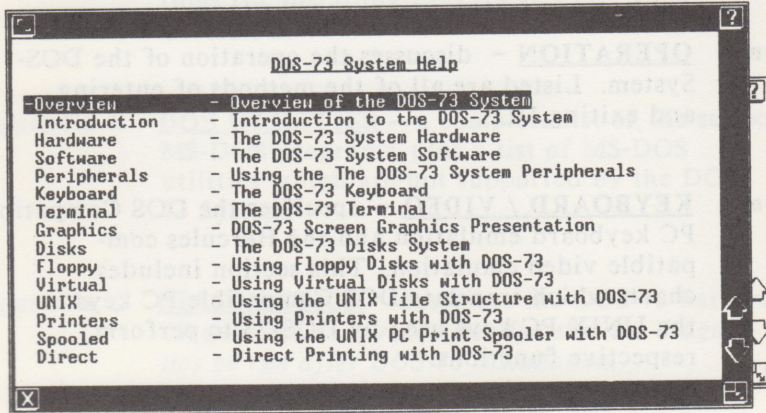

Select help display and touch ENTER

GUIDE TO THE MANUAL

The *DOS-73 User's Guide* is intended to provide you with all of the information necessary to install and use your DOS-73 System. The *DOS-73 User's Guide* consists of seven sections, six appendices, a Glossary of Terms and an Index. The following is a brief description of each section:

Section 1 INTRODUCING DOS-73 - (this section) provides an overview of the DOS-73 product.

Section 2 INSTALLATION - contains instructions on the hardware installation and removal, including the optional 8087 coprocessor. Software installation and removal are also included.

Section 3 UTILITIES - details the DOS-73 utilities which are used to create a DOS environment. Information on creating DOS VOLUMES and formatting DOS Compatible PC diskettes is also contained here.

Section 4 OPERATION - discusses the operation of the DOS-73 System. Listed are all of the methods of entering and exiting DOS.

Section 5 KEYBOARD / VIDEO - specifies the DOS Compatible PC keyboard emulation and the Hercules compatible video emulation. This section includes charts which translate DOS Compatible PC keys to the UNIX PC keys used by DOS-73 to perform respective functions.

GUIDE TO THE MANUAL

Section 6 **EXTERNAL DEVICES** - describes the methods of accessing DOS-73 external devices, such as printers, modems and the mouse. This section also contains information on the DOS-73 Printer Management (PM) utility. The PM utility both selects the default printer and initializes the local COM2: port for baud rate, parity, # of data bits and # of stop bits.

Section 7 **DISKS AND FILES** - contains information on the DOS-73 disk drives and files. This section includes specific information on the use of DOS Compatible PC diskettes, DOS Volumes, Virtual disks and information on accessing the UNIX file system from within DOS.

Appendix A **APPLICATIONS COMPATIBILITY** - addresses software compatibility issues, including setup instructions for some popular applications. This Appendix includes step-by-step instructions for installing LOTUS 1-2-3 on your UNIX PC.

Appendix B **DOS UTILITIES** - a complete list of the supported MS-DOS programs, plus a list of MS-DOS utilities which are not supported by the DOS-73 System.

Appendix C **DIAGNOSTICS** - describes the DOS-73 hardware diagnostics. *It is recommended that the diagnostics be run after DOS-73 installation.*

GUIDE TO THE MANUAL

Appendix D **DOS-73 SYSTEM FILES** - A complete list of DOS-73 system files and utilities.

Appendix E **MEMORY MAP** - displays a graphic representation of the DOS-73 memory.

Appendix F **COM2: PINOUTS** - specifies the pinout signals provided by the DOS-73 COM2: compatible serial port.

DOCUMENTATION CONVENTIONS

The following conventions have been applied throughout this user's guide:

- <Return> This signifies the Return key.
- <Enter> This signifies the Enter key.
- (F1) - (F8) These represent the screen keys across the top of the keyboard.
- <F1> - <F10> These represent the IBM PC compatible function keys on the left side of the keyboard.
- <B1> This represents the left button of the mouse.
- <B2> This represents the middle button of the mouse.
- <B3> This represents the right button of the mouse.

SECTION 2

DOS-73 INSTALLATION

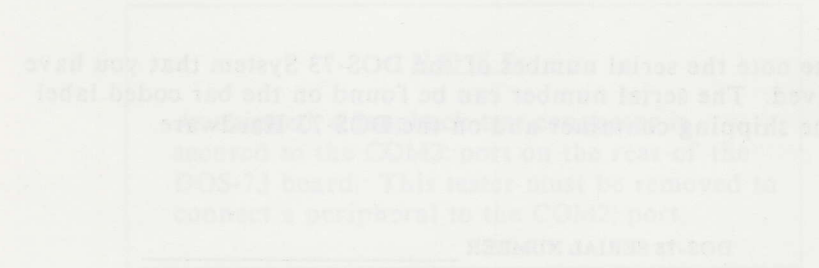

This section includes an inventory checklist that should be used to insure that you have received a complete DOS-73 System.

This section also provides instructions for installation and removal of the DOS-73 Hardware and Software. Instructions for installing an optional AT&T 8087 Coprocessor upgrade are also included.

BEFORE INSTALLING YOUR DOS-73

INVENTORY CHECKLIST

Before proceeding with the DOS-73 installation, make sure that you have received the following items:

- DOS-73 HARDWARE (Printed Circuit Board)
- DOS-73 SOFTWARE (4 Diskettes)
- DOS-73 USER'S GUIDE (This Manual)
- MS-DOS 3.1 USER'S REFERENCE
- DOS-73 Keyboard Overlays (2)
- COM2: Loopback tester
(connected to the rear of the DOS-73 board)

Please note the serial number of the DOS-73 System that you have received. The serial number can be found on the bar coded label on the shipping container and on the DOS-73 Hardware.

DOS-73 SERIAL NUMBER _____

BEFORE INSTALLING YOUR DOS-73

HANDLING THE DOS-73 HARDWARE

Care must be exercised in handling the DOS-73 board - shock or static electricity can damage electrical components.

A good handling technique is to grasp the DOS-73 board by the edges.

NECESSARY TOOLS

The only tool needed to install the DOS-73 Hardware is a phillips head screwdriver.

NOTE:

As shipped, a loopback test connector is secured to the COM2: port on the rear of the DOS-73 board. This tester must be removed to connect a peripheral to the COM2: port.

HARDWARE INSTALLATION

DOS-73 HARDWARE INSTALLATION

1. Shut down the UNIX PC, using the "Shutdown" command. When prompted, turn off the power.
2. Remove the two screws from any of the expansion slot covers, being careful not to strip the screws; they will be used to install the DOS-73 hardware.

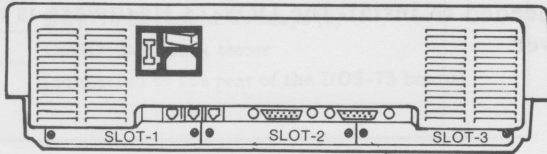

Figure 1.

3. Grasp the DOS-73 board by the edges with the components facing your palm (as shown in Figure 2).

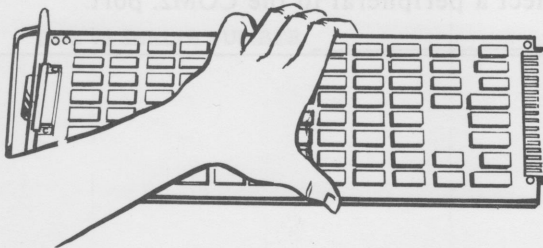

Figure 2.

HARDWARE INSTALLATION

4. Insert the board into the expansion slot (it can only go one way), fitting the edges into the grooves in the side tracks. If it binds, there may be a bent pin in the UNIX PC slot, or you are inserting it incorrectly. When properly seated, the metal plate on the rear of the DOS-73 board should make contact with the UNIX PC base.

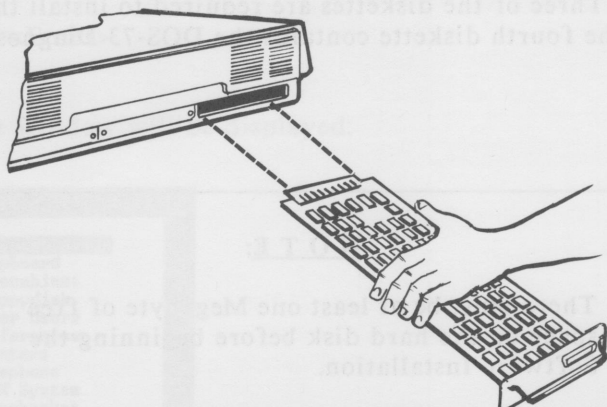

Figure 3.

5. Fasten the plate securely to the base of the UNIX PC with the two phillips head screws, being careful not to strip the screws. This must be done to prevent unseating the board when the COM2: port connector is installed or removed.

The DOS-73 Hardware installation is now complete.

SOFTWARE INSTALLATION

DOS-73 SOFTWARE INSTALLATION

The following information describes the process of installing the DOS-73 Software. The software installation is a one time process. You will not have to repeat the installation, unless you change your system.

The DOS-73 Software distribution package consists of four diskettes. Three of the diskettes are required to install the DOS-73 system. The fourth diskette contains the DOS-73 Diagnostics.

NOTE:

There must be at least one Megabyte of free space on the hard disk before beginning the Software Installation.

The DOS-73 Software will operate only with UNIX PC version 3.0 or greater.

SOFTWARE INSTALLATION

To install the DOS-73 Software:

1. Turn the computer on and after the please login: prompt, type: install

(If you have assigned a password for install, input the password.)

2. Press <Enter>.

The Office Window will be displayed:

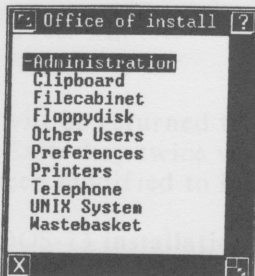

3. Press <Enter> to display the Administration menu.
4. Select Software Setup.



SOFTWARE INSTALLATION

5. Press <Enter>.

The Software window will be displayed.

6. Select the 'Install Software from Floppy' option.

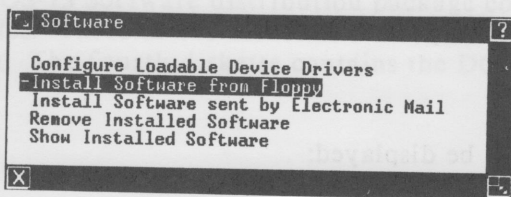

7. Press <Enter>.

The Confirm window is then displayed:

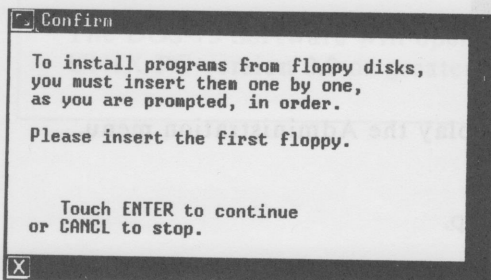

8. Insert the Diskette labeled "DOS-73 System Diskette - Disk 1 of 3" into the floppy disk drive and close the drive door.
9. Press <Enter>.

SOFTWARE INSTALLATION

Software installation will now begin. As needed, the DOS-73 installation program will prompt you to insert the second and third diskettes. When the installation process is completed, the following message will be displayed:

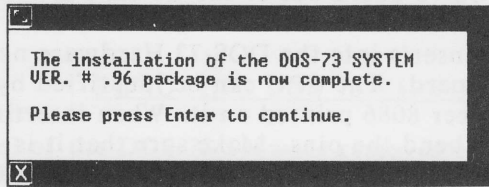

10. Press <Enter>

You will be returned to the Software installation window. Hitting the <Exit> key twice will return you to the Office window, which has been modified to include the 'DOS-73 System'.

The DOS-73 installation utility has created a 250 kilobyte virtual disk which contains all of the MS-DOS and DOS-73 utilities.

11. Refer to Section 3 for instructions on creating additional Virtual disks, assigning the Virtual disks to DOS Volumes, and adding DOS Application Programs to a Menu.

Before using your DOS-73 System, it is recommended that you run the DOS-73 diagnostics. Please refer to Appendix C for information on the diagnostics procedure.

This completes the DOS-73 System installation.

8087 UPGRADE INSTALLATION

1. In order to install an Upgrade 8087 Math Coprocessor, you must remove the DOS-73 Hardware from the UNIX PC. To do this, first Shutdown the UNIX PC. Next, remove the screws that fasten the metal plate on the rear of the DOS-73 board to the base of the UNIX PC, being careful not to strip them.
2. Carefully slide the DOS-73 board out of the UNIX PC.
3. The 8087 Coprocessor inserts into the DOS-73 Hardware next to the Main CPU on the board. The CPU can be identified by its large size and the number 8086 printed on it. When inserting the 8087, be careful not to bend the pins. Make sure that it is pressed firmly into place. The following illustration should be used to orientate pin one of the 8087 coprocessor:

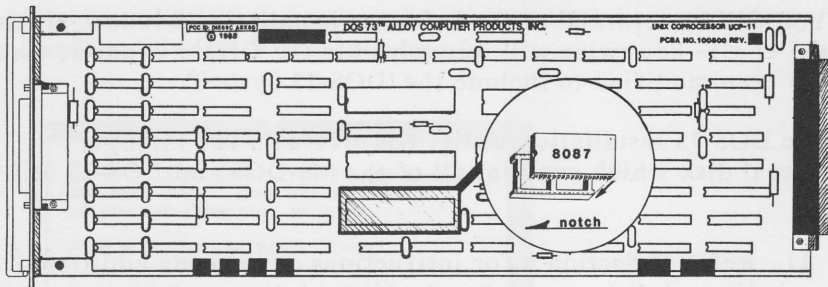

5. Re-install the DOS-73 Hardware into the UNIX PC by sliding the board carefully back into the UNIX PC base.
6. Re-attach the plate on the hardware to the UNIX PC base using the screws previously removed. Be careful not to strip or crossthread the screws.

REMOVING THE DOS-73 SYSTEM

DOS-73 SOFTWARE REMOVAL

To remove the DOS-73 System Software, go to the Office window. Select Administration, then Software Setup, and then select Remove Installed Software. Choose the DOS-73 System entry and press <Enter>. This will remove the DOS-73 System from the Office window.

REMOVING DOS-73 VIRTUAL DISKS

Removal of the DOS-73 Software removes only the first Virtual disk (dvd000). If you wish to remove the remaining Virtual disks, either remove them with the DOS-73 Volume Management utility or enter UNIX and use the "remove" command.

Deleting DOS-73 Virtual Disks will free a large amount of space on the hard disk. The amount of space freed can be found by entering UNIX and using the following commands:

```
cd /usr/bin/DOS
ls -l dvd*
```

When deleting Virtual disks, you should be certain that data on the Virtual disk(s) to be deleted is first backed up. When logged into the /usr/bin/DOS directory, enter the following command:

```
rm dvdnnn
```

where nnn is the number of the virtual disk to be removed.

Removal of a virtual disk is immediate and irreversible!

REMOVING THE DOS-73 SYSTEM

DOS-73 HARDWARE REMOVAL

Should you want to remove the DOS-73 Hardware, first run the Shutdown procedure, and then just reverse the installation procedure.

Remove the screws as before. Grasp the rear plate and gently pull the DOS-73 Hardware out of the slot.

Replace the metal slot cover which you removed during the installation process.

SECTION 3

DOS-73 UTILITIES

This section describes the operation of the DOS-73 System Utilities. The DOS-73 utilities provide the following functions:

With the **Volume Management** utility you can create or delete DOS Virtual disks.

With the **Session Configuration** utility each user may assign up to 12 of the Virtual disks to DOS Volume names C: through N:.

The **Add DOS Application to Menu** utility is used to create entries in the DOS Applications window.

The **Remove DOS Application from Menu** utility removes entries from the DOS Applications window.

The **Format DOS Diskette** utility is used to format a DOS compatible diskette. With a DOS diskette you can move data between your UNIX PC and an IBM or compatible PC.

DOS-73 UTILITIES

The DOS-73 System Utilities are accessed through the DOS-73 window by selecting the System Utilities option. When this option is selected you will see the DOS-73 Utilities window:

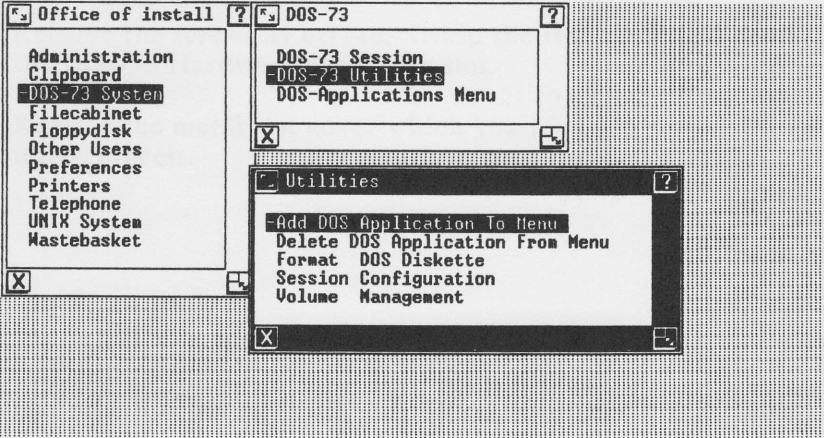

A complete on-line Help facility is provided for all of the DOS-73 utilities. To access this information, select an option in any of the utility windows and hit the <HELP> key, or point to the '?' icon, and press the <B1> button.

FORMAT DOS DISKETTE

FORMATTING DOS DISKETTES

DOS-73 provides a utility to format DOS compatible diskettes on your UNIX PC. Also, the DOS-73 System reads and writes diskettes that were formatted on a DOS Compatible PC.

The Format DOS Diskette option invokes the DOS floppy disk formatting utility. This utility must be used to format DOS compatible diskettes on the UNIX PC. The DOS-73 System will not execute the FORMAT.COM utility normally associated with a DOS Compatible PC.

Diskettes that are formatted using this utility can be read from and written to on any other personal computer that supports the DOS Compatible floppy diskette format.

When this utility is selected from the DOS-73 Utilities window, you are prompted to insert a diskette and to press the <Enter> key to begin formatting. The format process takes a few minutes, during which the following message is displayed:

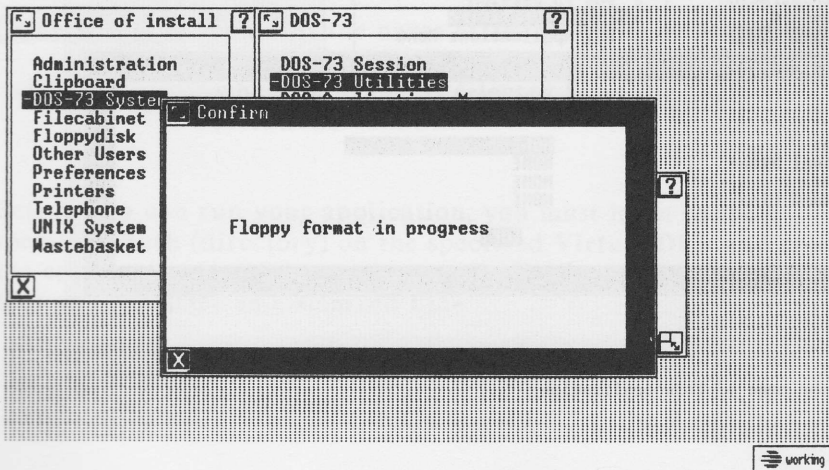

DOS APPLICATIONS MENU

Adding DOS Applications to the Menu

The Install DOS Software utility allows you to place software application programs that have already been installed on the hard disk into a selection menu. This is an optional tool designed for user convenience. It is not necessary to access applications through this method. Applications can be accessed from the DOS prompt.

Once programs have been placed into the applications menu with this utility, you can access them through the DOS Applications Menu option from the DOS-73 menu. The DOS Applications Menu option loads DOS and automatically executes the selected application. If you want to automatically return to the DOS Applications Menu window after exiting from the application program, create a .BAT file with your application name as the first command line and 'EXITDOS' as the last command.

When the Add DOS Application Menu option is selected, the following window is displayed:

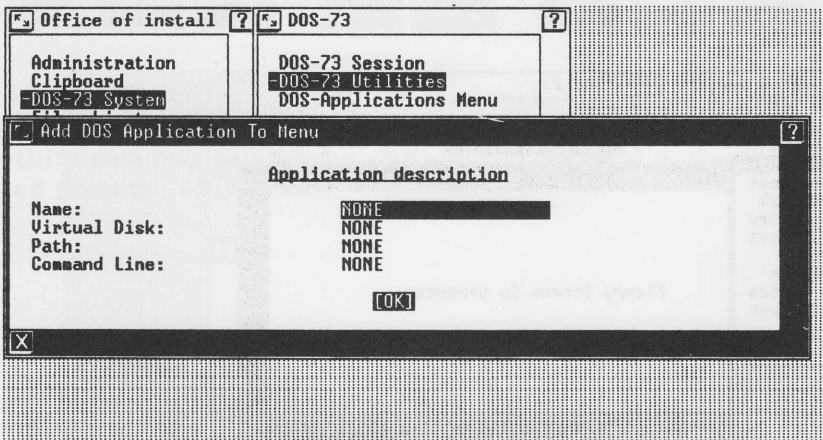

Enter the name of this application

DOS APPLICATIONS MENU

The following is a description of the information which is required to install a DOS Application:

Name is a reference name which is used as the menu display item when you select the DOS Applications option from the DOS-73 window.

Virtual Disk is the the Virtual disk name (dvd000 - dvd255) that contains the program or .BAT file specified in the Command Line.

Virtual disks are created with the Volume Management utility. Information on Virtual disks is supplied later in this section. Also refer to Section 7 of this User's Guide for more information on Virtual disks.

Path is the directory that contains the program or .BAT file specified in the Command Line. NONE or \ both refer to the root directory. Note that MS-DOS uses '\' while UNIX uses '/' for path names.

Command Line contains the name of the program or .BAT file, plus any arguments which are to be executed when the **Name** is selected from the DOS Applications window.

Before you can run your application, you must login to the specified **Path** (directory) on the specified **Virtual Disk** and copy the application program, or create a .BAT file with the same name that you specified in **Command Line**.

DOS APPLICATIONS MENU

As an example, suppose that you wanted to have LOTUS 1-2-3 as a DOS Application. For this example, let's assume that you have created a sub-directory with the name \LOTUS on dvd001, which is automatically assigned as drive D:, unless it has been re-assigned with the DOS-73 Session Configuration utility. Next, you installed the LOTUS 1-2-3 software into the D:\LOTUS sub-directory. If you are unfamiliar with the process of installing LOTUS 1-2-3 for Hercules Graphics, please refer to Appendix A of this User's Guide.

In this example, your responses to the "Add DOS Application to Menu" questions would be as follows:

Name: LOTUS Path: \\
Virtual Disk: dvd001 Command Line: LOTUS

After adding the DOS Application entry to the menu, you would want to create LOTUS.BAT on the root directory of the D: drive. The following commands will create a batch file which would automatically execute LOTUS 1-2-3 and then return you to the PC-DOS Applications menu when you quit the program:

```
COPY CON: D:\LOTUS.BAT
CD \LOTUS                    [Change into the LOTUS directory]
LOTUS                        [Execute the LOTUS 1-2-3 program]
EXITDOS                     [Exit to the PC-DOS Application window
                              after you exit from the 1-2-3 program]

<Ctrl>Z <RETURN>
```

The information contained within the brackets is for descriptive purposes only. Do not type them into the LOTUS.BAT file.

POSSIBLE ERROR MESSAGES

Can not create home data base

The user home data base, dos-73app, cannot be created. Possible reasons are improper permissions set on the user home directory (this file belongs to another user), or the system disk space is exhausted.

Can not open home data base

The user home data base cannot be opened. Possible reasons are improper permissions set on the user home directory, or the user data base file itself.

<name> is already used as an application name

The name requested to describe the new application is already used. The user must choose different names for each application.

You must supply an application name

- The application was either blank or NONE
- The user must specify a valid name

You must supply a disk name

- The disk was either blank or NONE
- The user must specify a valid disk name

You must supply a command line

- The command line was either blank or NONE
- The user must specify a valid command line name

The Name, Virtual Disk, and Path of an application must be one word - no tabs or spaces.

The Name, Virtual disk, or Path requested has a blank or a tab. These characters are illegal.

REMOVE DOS APPLICATION FROM MENU

REMOVE DOS APPLICATIONS SOFTWARE

Using the Remove DOS Application from Menu utility, you can remove previously installed software applications from the DOS Applications selection menu.

This utility does not physically remove the software programs and their associated files from the hard disk, but merely removes the entry from the selection menu. The programs can still be accessed from the DOS prompt.

To remove a DOS Application select the Remove DOS Application from Menu option from the DOS-73 Utility window. When selected, the following screen is displayed:

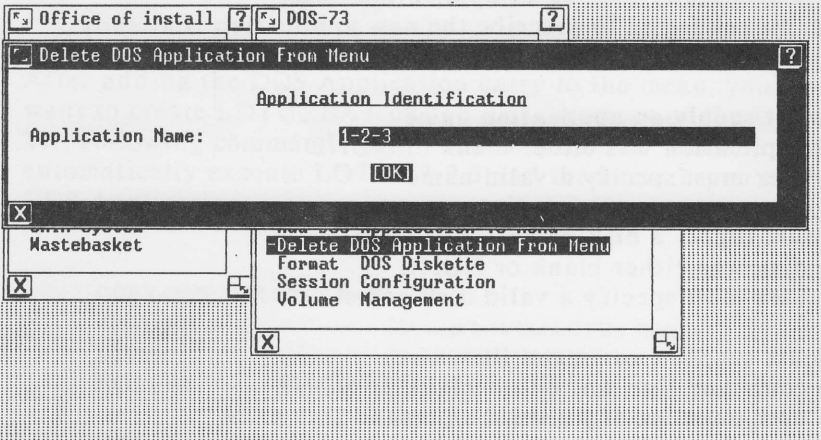

Enter the name of the application to be deleted

To remove a DOS Application, you can enter the application Name and press <Enter>. If you are unsure of the application name you can hit the <Opts> key or press <B2> and select the Name from a list of applications, then press the <Enter> key twice or <B1> key twice.

REMOVE DOS APPLICATION FROM MENU

POSSIBLE ERROR MESSAGES

Can't open user data base

The user home data base cannot be opened. Possible reasons are improper permissions set on the user home directory, or the user data base file itself (the files may belong to another user).

<name> is not an existing name of an application

The specified name of the application to remove does not exist.

No Installed Applications

No applications have been installed.

Malloc Failed

This error will occur when the system memory resources have been exhausted. Close some currently un-used windows and try the remove command again.

SESSION CONFIGURATION

CONFIGURING A DOS-73 SESSION

DOS-73 Session Configuration is an optional utility which allows each user to configure his or her own personal DOS session environment. Using this utility, each user can assign different Virtual disks to DOS Volumes, thereby creating a unique environment for each user.

If DOS-73 does not find a Session Configuration in your home directory, it automatically assigns up to twelve Virtual disks (in ascending order from dvd000 - dvd255) to DOS Volumes C: through N:. Note that you must run the Session Configuration utility if you want a UNIX Volume.

When selected from the DOS-73 Utilities window, the Session Configuration utility displays the following window:

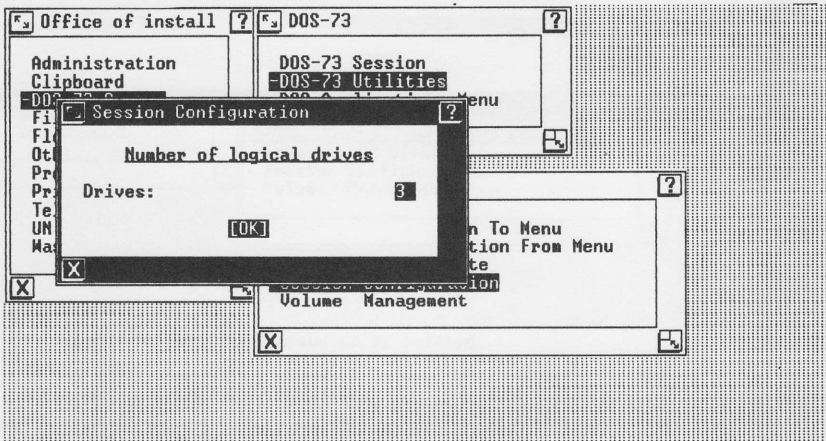

Enter the total number of drives wanted on the system

Input up to 12 DOS Volumes (assigned as C: - N:), then press the <Enter> key.

SESSION CONFIGURATION

NOTE:

Volumes A: and B: refer to the UNIX PC floppy disk drive and cannot be changed. DOS-73 treats these volumes as DOS Compatible floppy disk drives.

Next you will be prompted to assign the Virtual Disks (which were created with the Volume Management utility) to DOS Volumes:

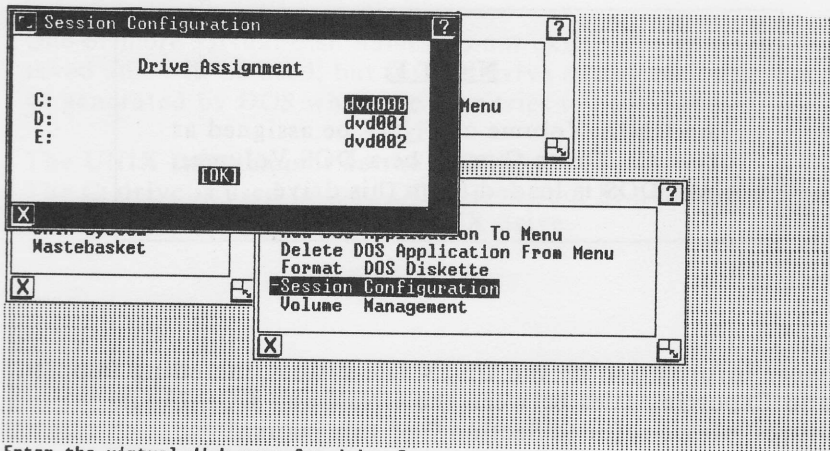

For information on Virtual Disks, please refer to the Volume Management utility (this section), and Section 7 of this User's Guide.

SESSION CONFIGURATION

The first time you run the Session Configuration utility, the default Drive Assignments display contains all of the virtual disks, in ascending order, up to the number of specified volumes.

When running the Session Configuration to add or change volumes for an existing configuration file, the previously assigned virtual disks are displayed as the default volumes.

You may assign any single Virtual disk to any DOS Volume (C:, D:, E:, etc.). Make sure that the selected DOS Volumes are contiguous. Assigning UNIX as a DOS Volume means that that volume will be used to access the UNIX file system.

NOTE:

The UNIX Volume can NOT be assigned as drive C:. Drive C: must be a DOS Volume, since DOS is loaded from this drive.

For more information on the UNIX file system, including Importing and Exporting files between the UNIX and DOS-73 file structures, please refer to Section 7 of this manual.

SESSION CONFIGURATION

POSSIBLE ERROR MESSAGES

Invalid number of drives

The number of drives requested is illegal. The range is 1-12.

Multiple UNIX disk configurations

The user has requested more than one drive to be the UNIX drive. A user may have only one.

<name> is an illegal name for a virtual disk

The name given for the virtual disk is not in the form dvdnnn, where nnn is a number in the range 000 - 255.

The following drives are inaccessible. You must create them before you attempt to use them.

One or more virtual disk names do not exist. The configuration is saved and will be used, but invalid drive specification errors will be generated by DOS when the user tries to access them.

The UNIX Drive cannot be the C drive

The C: drive is used to load DOS. It cannot be assigned as the UNIX Volume. Reassign the UNIX drive.

VOLUME MANAGEMENT

DOS-73 VOLUME MANAGEMENT

The Volume Management utility is used to create DOS-73 Virtual disks. Virtual disks are UNIX files which are automatically assigned as DOS Volumes C: through N:. They can be re-assigned with the DOS-73 Session Configuration utility. When DOS-73 creates a new Virtual disk, it pre-allocates all of the specified space. This disk space is immediately taken from the available UNIX hard disk space.

The Volume Management utility allows you to create up to 256 unique DOS Virtual Disks (dvd000 - dvd255), which are located in the usr/bin/DOS73 UNIX directory. Virtual disks range in size from 100 Kilobytes to 32000 Kilobytes.

During the DOS-73 installation, a DOS Virtual disk (dvd000) is automatically created and assigned as drive C:. This disk contains the MS-DOS 3.1 and DOS-73 utilities, including AUTOEXEC.BAT.

Selecting the Volume Management utility displays the following screen:

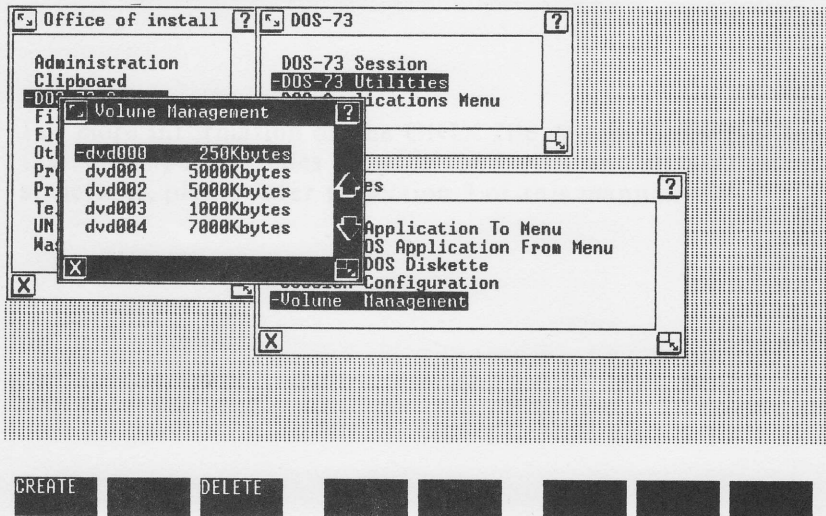

VOLUME MANAGEMENT

To create a Virtual disk, press the CREATE key [screen key (F1)]. The following screen will be displayed:

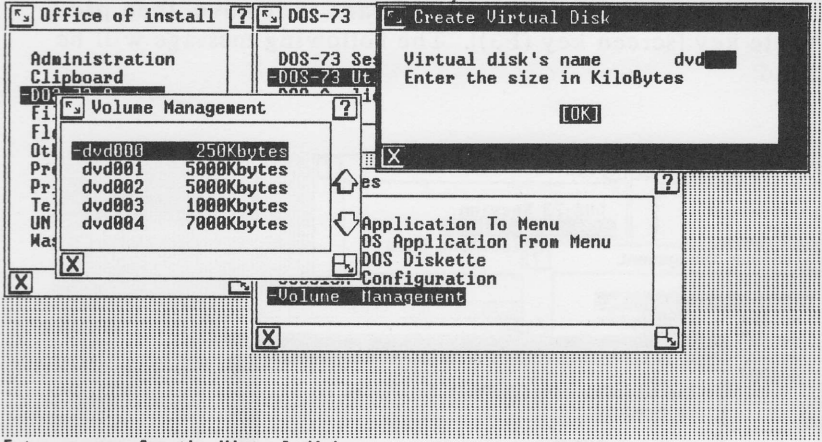

Enter a name for the Virtual disk

Input a virtual disk name (dvd000 - dvd255), press the <Return> key, input the disk size (100 Kilobytes - 32000 Kilobytes) and press the <Enter> key. This creates a virtual disk. Note that 1024 Kilobytes is equivalent to one megabyte.

The Volume Management utility automatically copies the file COMMAND.COM to each drive that it creates. This file is required to allow you to load DOS from the volume assigned as the C: drive.

For users without a special Session Configuration the newly created Volume will be automatically assigned to a DOS Volume. As an example, if you create dvd001, it will be assigned as the DOS D: Volume; dvd002 would be E:, etc.

If you have a special Session Configuration then you must run the Session Configuration utility to add the newly created Virtual disk to your list of DOS Volumes.

VOLUME MANAGEMENT

REMOVING A VIRTUAL DISK

In order to remove an already created virtual disk, execute the Volume Management utility. When the list of virtual disks is displayed, highlight the one that you want to remove, then press the Delete key [screen key (F3)]. The following message will be displayed:

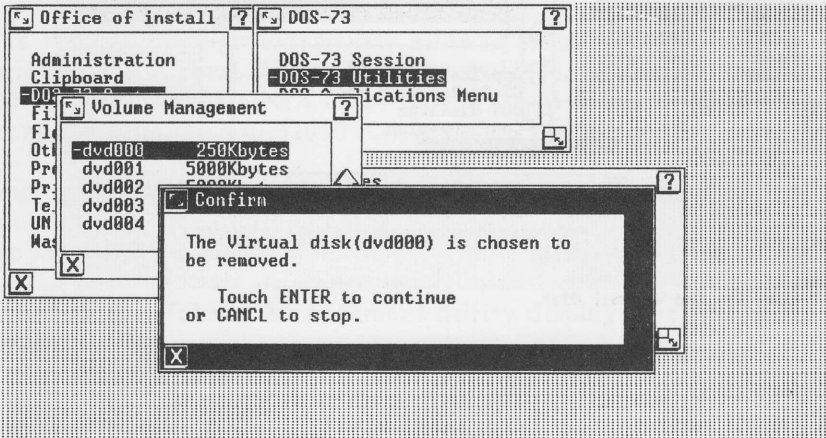

WARNING:

Removing a Virtual Disk will cause the files and data on that disk to be permanently lost. Any valuable data should be backed up prior to Virtual disk removal!

SECTION 4

DOS-73 OPERATION

This section contains information on the operation of the DOS-73 System. Instructions are included for:

Loading a DOS-73 Session

Running specific DOS Applications

Exiting a DOS-73 Session

NOTE:

DOS reads the DATE and TIME from the UNIX PC system clock at DOS load time.

DOS-73 SYSTEM OPERATION

USING THE DOS-73 SYSTEM

The DOS-73 System is accessed through the Office window by selecting the DOS-73 System option. When selected, the DOS-73 System option displays the following window:

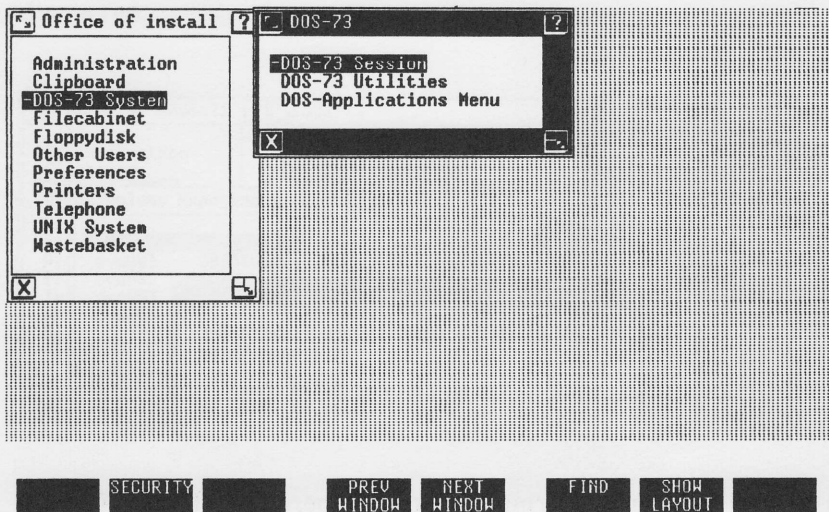

From the DOS-73 window you can initiate a DOS-73 Session, call up the DOS Applications menu, or select the System Utilities.

Selecting either the DOS-73 Session or the DOS Applications menu will load DOS and begin auto-processing, as described later in this section. In each case, DOS-73 searches your UNIX home directory for the Session Configuration parameters which assign available virtual disks to specific DOS Volumes. If no special configuration has been created, DOS-73 will automatically assign Virtual disks starting with dvd000 in ascending order to DOS Volumes C: through N:. Note that you must run the Session Configuration utility if you wish to declare a UNIX Volume.

DOS-73 SESSION

RUNNING A DOS-73 SESSION

Selecting the DOS-73 Session option from the DOS-73 window causes DOS to be loaded, C:\CONFIG.SYS to be loaded, and finally, causes C:\AUTOEXEC.BAT to be automatically executed. As shipped, DOS-73 contains a C:\AUTOEXEC.BAT file, but does not have the optional C:\CONFIG.SYS file.

The following screen displays the default DOS-73 Session sign-on screen:

```

                                DOS-73
                        AT&T UNIX PC DOS Coprocessor

RTX-73 Version 0.96
Copyright (C) 1985 by Alloy Computer Products, Inc.

Microsoft MS-DOS version 3.10
With PC-DOS emulation
Copyright 1981,82,83 Microsoft Corp.

C>path c:\
C>prompt $p$g
C:\>pm unix:s
UNIX default printer set as PRN: mode = spooled
C:\>
C:\>
```

ALT	INS	DEL	WIDE FONT	THIN FONT	SCROLL LOCK	PC KEYS	TOGGLE BORDER
-----	-----	-----	--------------	--------------	----------------	------------	------------------

Note that the default sign-on screen contains some commands which were automatically executed at DOS load time. These commands are contained in the file C:\AUTOEXEC.BAT.

The command "PROMPT \$P \$G", sets the DOS prompt to display the currently logged drive and path. The command PATH C:\ tells DOS to search the root directory of the C: drive for programs which cannot be found in your current directory. Finally, PM UNIX:S causes DOS-73 to select the UNIX default printer in spooled mode as its default printer.

At this point you are at the DOS prompt and may execute commands as you would on a DOS Compatible PC. For more information on DOS, please refer to the MS-DOS 3.1 User's Reference.

PC-DOS APPLICATIONS

RUNNING SPECIFIC DOS APPLICATIONS

Selecting the DOS Applications option presents you with a menu of DOS application programs which were input with the Install DOS Software utility. Below is a sample DOS Applications screen:

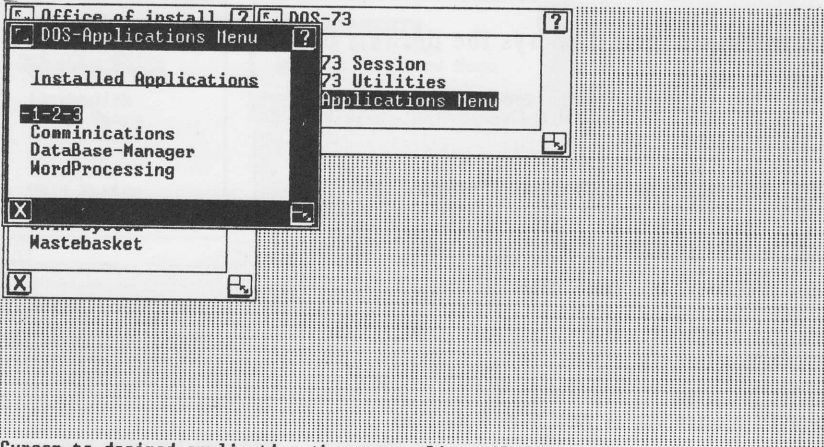

Cursor to desired application then press B1 or <ENTER>

Select an application name and press the <Enter> key. DOS-73 automatically loads DOS and executes the application.

For more information on installing DOS Applications, please refer to Section 3 of this User's Guide.

PC-DOS APPLICATIONS

ERROR MESSAGES

No installed applications

There are no installed applications for this user.

Malloc Failed

This error only appears when the system's memory resources have been exhausted.

Virtual disk not specified in configuration

The virtual disk on which the application resides is not defined in the user configuration. This is needed to determine which drive the application is on.

EXITING DOS-73

1. Press the <Exit> key. This will exit the DOS Session and return you to the DOS-73 window.
2. Toggle on the borders by pressing screen key (F8), and then select the exit icon using the mouse and pressing mouse key <B1>. This will exit the DOS-73 Session and return you to the DOS-73 window.
3. An EXITDOS program is included with the DOS-73 software. This program, when executed from the DOS prompt or in a .BAT file, will exit to the DOS-73 window.

RE-LOADING DOS

DOS can be reloaded by holding down the <Shift> key and pressing the <Restrt> key at any time during a DOS-73 Session. This function is similar to the DOS Compatible PC keyboard reset <Ctrl><ALT>.

NOTE:

Re-loading DOS will cause data in open files to be lost, producing disk corruption errors which are reported when running CHKDSK.
Be sure to close any open files before re-loading DOS.

SUSPENDING A DOS-73 SESSION

SUSPENDING A DOS-73 SESSION

You can suspend (or temporarily leave) a DOS-73 Session in order to perform a UNIX task. This is done by pressing the <Suspd> key or pointing to the 'W' icon and pressing the <B1> button. This causes a window of available tasks to be displayed. You may select any of the listed tasks while your DOS session continues to run. To resume the DOS-73 session, press the <Suspd> key or select the 'W' icon again, select the DOS-73 System option and hit the <Enter> key.

NOTE:

Programs continue to run as background tasks during a "suspension" until operator input is required.

SECTION 5

DOS-73 KEYBOARD / VIDEO

This section includes information on the DOS-73 Keyboard and Video features. The DOS-73 System utilizes many of the advanced features of the UNIX PC to emulate the keyboard and graphics of a DOS Compatible PC with a Hercules graphics board.

With this sophisticated emulation, DOS-73 provides the tools necessary to run popular applications such as LOTUS 1-2-3 and SuperCalc-3, with full graphics support.

This section also contains information on the DOS-73 Remote terminal support.

DOS-73 KEYBOARD

THE KEYBOARD

One of the biggest differences between using an actual IBM PC and using the UNIX PC with the DOS-73 System is the keyboard layout. Most of the IBM PC keys are available on the UNIX PC keyboard, they are just arranged in a different manner; and in some cases they are labelled differently.

To ease the process of identifying these special keys, the DOS-73 system includes the following aids:

- o 2 KEYBOARD OVERLAYS
- o An On-Line PC KEYS screen
- o An IBM PC keyboard to UNIX PC keyboard conversion chart, which is included in this section of the User's Guide.

KEYBOARD OVERLAYS

The DOS-73 System includes two keyboard overlays. One overlay sits on the right side of the UNIX PC keyboard, the other on the left side. The overlays are designed to provide an easy-to-use identification of the DOS-73 equivalents of special DOS Compatible PC keys.

In addition to the DOS Compatible PC keys, the left hand overlay has function key assignments used by some spreadsheets, including LOTUS 1-2-3. These functions (printed in blue), are located immediately beneath the corresponding key.

Note that the keys which are shaded with a blue background denote "Shifted" keys. To access these functions, hold down the <Shift> key and hit the corresponding function key.

ON-LINE KEYBOARD LAYOUT

The DOS-73 System includes an on-line keyboard screen which is displayed by pressing the screen key labeled PC KEYS (F7). When selected from the UNIX PC, PC KEYS will display the following screen:

Please note that the CTL H, CTL I, and CTL J keys do not function the same as on the IBM PC.
For more information refer to section 5 of the DOS-73 users guide.

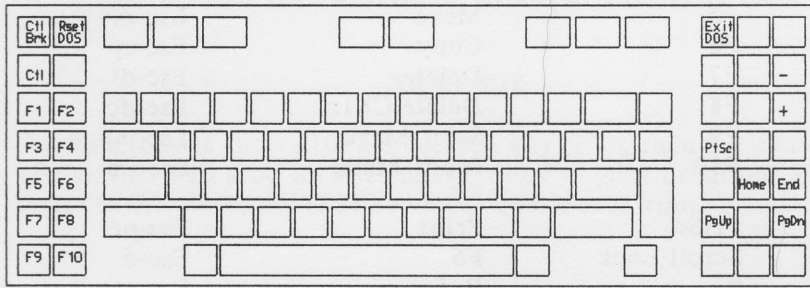

Hit any key to exit PC KEYS

Remote terminals do not support graphics. As such, the PC keys program cannot display the keyboard layout. Instead, DOS-73 opens a HELP window and displays a DOS Compatible PC to UNIX PC conversion chart on remote terminals. To exit from the remote terminal HELP screen, press the <Return> key.

DOS-73 KEYBOARD

The following is a list of the UNIX PC keys or Remote terminal Escape sequences that correspond in functionality to DOS Compatible PC special keys.

<u>IBM PC</u>	<u>UNIX PC</u>	<u>REMOTE</u>
F1	Undo	Esc-ud
F2	Redo	Esc-ro
F3	Find	Esc-fi
F4	Rplac	Esc-rp
F5	Move	Esc-mv
F6	Copy	Esc-cp
F7	Delete	Esc-dl
F8	Delete Char	Esc-dc
F9	Selct/Mark	Esc-mk
F10	Input/Mode	Esc-im
PrtSc	Print	Esc-pr
Scroll Lock	F6	Esc-6
*	Ref	Esc-re
+	Cancl	Esc-cn
-	Opts	Esc-ot
Ctrl Break	Clear Line	Esc-ci
Alt	F1	Esc-1
Ins	F2	Esc-2
Del	F3	Esc-3
Reboot(Ctrl/Alt/Del)	Shift Rstrt	Esc-ST
PgUp	Prev	Esc-pv
PgDn	Next	Esc-nx

N O T E:

When entering an Escape sequence to select a special key from a remote terminal, the keys following the Esc must be pressed within one second. Additionally the '-' dash character displayed above is for ease of reading, it is not to be typed on the terminal.

DOS-73 KEYBOARD

Ctrl F1-F10

Depress/release the <Create> key, then hit <F1>-<F10>; this will send a Control function key to your program. For a series of control keys, the <Create> key must be pressed each time.

Ctrl Alt

Depress/release the <Create> key; then press the Alt key [screen key (F1)]; this will send a Control Alt key to your program.

Alt F1-F10

Depress/release the <Alt> key [screen key (F1)], then hit <F1>-<F10>; this will send an Alt function key to your program. For a series of Alt keys, the (F1) key must be hit each time.

ALTERNATE CTRL KEY

In addition to using the <Create> key to modify the function keys <F1> - <F10>, the <Create> key can be used to provide any <Ctrl> modified key. The following keys actually transmit the following control-character sequences:

The <Enter> key transmits <Ctrl><J>;
the <Back Space> key transmits <CTRL><H>;
the <Tab> key transmits <Ctrl><I>.

In order to send a Control J, H, or I to an application program, you must use the <Create> key. First press/release the <Create> key, then press the key which is to be control-modified (J,H,I). Note that you must press/release the <Create> key once for each key it is to control-modify.

Except for the above cases (J,H,I), you should use the UNIX PC <Ctrl> key to control-modify keys. The UNIX PC <Ctrl> key allows you to keep the <Ctrl> pressed down and modify several keys simultaneously.

THE DOS-73 SCREEN KEYS

ALT (F1)

The UNIX PC does not provide an <ALT> key, so DOS-73 uses screen key (F1) to provide this function. To input an ALT modified key, Depress/Release the <ALT> key (F1), and then press any key; that key will then be ALT modified. The ALT does not modify multiple keystrokes. *It must be pressed down and released once for each key it is to affect.*

INS(F2), DEL(F3), & Scroll Lock(F8)

DOS-73 uses the UNIX PC programmable function keys to provide INS (F2), DEL (F3), and Scroll Lock (F8) functions. These keys behave identically to the associated DOS Compatible PC keys.

PC Keys

An on-line keyboard layout, accessed by pressing screen key (F7), illustrates the re-mapped DOS Compatible PC function keys and special keys.

Toggle Borders

The Toggle Borders screen key (F8) puts the UNIX PC window borders and icons around the DOS-73 screen. This allows the DOS-73 screen to be sized and moved.

Note that the DOS-73 screen loses both the top two lines and bottom two lines, plus the last four characters per line, when the borders are toggled on. When the borders are toggled off, the DOS-73 window re-sizes itself to a 25 line by 80 character screen.

The left-most and bottom-most area of the screen is always displayed when sizing the DOS-73 window.

Wide Font & Thin Font

When in the character display mode, the (F4) and (F5) screen keys provide for the selection of "Wide Font" and "Thin Font" respectively. For programs which make extensive use of highlighting, such as WordStar, the screen presentation is more readable in the Thin Font mode.

At DOS load time, DOS-73 automatically selects the Wide Font.

Graph-Up & Graph-Dn

When your application program displays graphics, the DOS-73 System automatically assigns screen keys (F4) and (F5) for Graph-Up and Graph-Down functions.

The standard DOS Compatible PC with Hercules graphics has a screen resolution of 720 x 348 pixels. Since the bottom of the UNIX PC screen is used to display the screen keys (F1)-(F8), the DOS-73 work area can only display 720 x 275 pixels at one time.

To allow you to view an entire graph, when in the graphics mode the DOS-73 System uses the Graph-Up (F4) and Graph-Dn (F5) screen keys. The (F4) and (F5) keys can be pressed a total of 4 times in either direction for a total displacement of 73 pixels.

Executing UNIX commands from within DOS

DOS-73 provides a method of allowing you to execute UNIX commands from within a DOS session. To issue a UNIX command, press the <Open> key. This will open a new window and allow you to execute UNIX commands until a <Ctrl> D is pressed, at which point you are returned to the DOS screen which was active before opening the UNIX commands window. Note the UNIX command function of DOS-73 is not supported on remote terminals.

DOS-73 SCREEN PRESENTATION

DOS-73 provides a full 80 character by 25 line display with all of the characters which are available on a DOS Compatible PC with a Hercules graphics card. The only restrictions to the video display are the method of providing video intensities and the lack of a BLINK attribute.

The UNIX PC does not support BLINKing characters. For applications which make use of the BLINK attribute, DOS-73 provides highlighting. Depending on your application, DOS-73 substitutes either a BOLD or REVERSE video attribute for BLINK characters.

To provide a BOLD attribute the UNIX PC allows the DOS-73 System to select a wider character font. This method of providing a high intensity however does not allow separate control of the foreground / background intensity which is available with the Hercules video display.

ANSI.SYS

DOS-73 provides ANSI compatible video with the ANSI.SYS device driver. To load the ANSI.SYS driver, enter the following commands from the DOS prompt:

```
COPY CON C:\CONFIG.SYS+CON C:\CONFIG.SYS
DEVICE=ANSI.SYS
<Ctrl>Z <Return>
```

After ANSI.SYS has been added to CONFIG.SYS, DOS-73 will automatically load the ANSI support driver at DOS load time.

DOS-73 SCREEN GRAPHICS

In graphics mode, the DOS-73 terminal display emulates that of a Hercules card on an IBM PC. Software programs should be configured for a Hercules graphics card. Note that only the first page of Hercules graphics memory is supported; therefore, split screen graphics/text is not supported.

DOS-73 REMOTE TERMINAL SUPPORT

DOS-73 supports the AT&T 513 and 510 terminals for remote access. Operation of the DOS-73 system is the same on a remote terminal as it is on the UNIX PC, with the following exceptions:

1. Graphics are not supported on remote terminals.
2. When using the AT&T 510 as a remote terminal, Escape sequences replace the function keys provided by the UNIX PC and the 513 terminal. The conversion chart located on page 5-4 provides a list of the escape sequences which correspond to DOS-73 function keys.
3. Remote terminals can only display 24 lines of information at one time while running DOS-73. To allow you to view 25 lines of information, DOS-73 uses screen keys (F4) and (F5) to select between a 1-24 or 2-25 line display mode. Screen key (F4) displays lines 1-24 and screen key (F5) displays lines 2-25. These keys may be used at any time during a remote DOS-73 Session.
4. <Ctrl> Q and <Ctrl> S are used to provide data handshaking between the UNIX PC and a remote terminal. As such, these keys are treated specially. To send a <Ctrl> Q or <Ctrl> S to an application from a remote terminal you must first press/release the <Create> key then press either 'Q' or 'S' respectively.

SECTION 6

DOS-73 EXTERNAL DEVICES

This section describes how the DOS-73 System uses printers, modems, and the UNIX PC mouse. Instructions are included for selecting a DOS-73 default printer and initializing the COM2: serial port with the PM (Printer Management) utility.

Information on the DOS-73 support of the UNIX PC modem and running a modem off of the COM2: serial port is also included in this section.

NOTE:

For the DOS-73 COM2: hardware pinouts, please refer to Appendix F of this User's Guide.

PRINTING WITH DOS-73

PRINTER SUPPORT

DOS-73 provides access to either the UNIX default printer or a printer attached to the DOS-73 COM2: serial port. Output directed to the UNIX printer may be either printed directly or printed via the UNIX print spooler. Output directed to the DOS-73 COM2: port is always printed directly.

At DOS load time, the DOS-73 printer is the "default" UNIX printer in a spooled mode. To change the default printer selection, edit the file C:\AUTOEXEC.BAT, and execute the PM (Printer Management) utility as described later in this section.

For application programs which require that you specify the DOS device for printer output, the following chart describes the functions provided by each of the output devices:

<u>DOS Device</u>	<u>Selected printer</u>
LPT1: and LPT2:	Output to the current default UNIX printer
COM2:	Output is sent to the DOS-73 RS-232C port.
COM1:	COM1: is not available as a printer. DOS-73 reserves COM1: for the UNIX Modem.

AT&T PRINTERS

The following chart specifies the printer types which should be used to configure your DOS programs to operate with an AT&T printer:

<u>Name</u>	<u>Interface</u>	<u>Type</u>
AT&T 470 and 471	Parallel	C.ITOH 8510
AT&T 455 and 457	Serial	QUME Sprint 11

PRINTER MANAGEMENT

PM (PRINTER MANAGEMENT)

The DOS-73 PM (Printer Management) utility allows you to select the current default UNIX printer in a spooled or direct output mode. The PM utility is also used to select and initialize the DOS-73 COM2: port.

The following is the command format for the PM utility:

PM dev:[D/S],[baud,parity,data,stop]

where:	dev	printer device	(UNIX or COM2:)
	D	direct mode	(UNIX only)
	S	spooled mode	(UNIX only)
	baud	baud rate	(COM2: only)
	parity	parity	(COM2: only)
	data	number of data bits	(COM2: only)
	stop	number of stop bits	(COM2: only)

The following examples illustrate the methods of selecting a DOS-73 default printer:

<u>Command</u>	<u>Selects...</u>
PM UNIX:S	the default UNIX printer in the spooled mode
PM UNIX:D	the default UNIX printer in the direct mode.
PM COM2:	Select the DOS-73 COM2: port (direct mode only).

Refer to the UNIX PC Owner's Manual for information on changing the default UNIX printer.

NOTE:

When printing in the spooled mode, DOS-73 will automatically close the spool file approximately 8 seconds after the application stops outputting to the printer.

INITIALIZING THE COM2: SERIAL PORT

At DOS-73 System load time the COM2: (local serial) port defaults to the following values:

9600 BAUD
NO PARITY
8 DATA BITS
1 STOP BIT

You can change these values at any time with the PM utility. The following is a list of the available COM2: initialization parameters:

BAUD RATES: 110, 150, 300, 600,
 1200, 2400, 4800, 9600

PARITY: N = NONE E = EVEN O = ODD

DATA BITS: 8 or 7

STOP BITS: 1 or 2

The following examples illustrate the use of the PM utility to initialize the DOS-73 COM2: serial port:

<u>Command</u>	<u>Selects...</u>
PM COM2:1200,E,8,1	COM2:, 1200 baud, even parity, 8 data bits and 1 stop bit.
PM COM2:9600,N,7,2	COM2:, 9600 baud, no parity, 7 data bits and 2 stop bits.

INTERNAL UNIX PC MODEM

Under DOS-73 System control, the UNIX PC's built-in 300/1200 baud modem appears to be a Hayes Smartmodem assigned to the COM1: port. The UNIX PC internal modem will function only in originate mode with the DOS-73 System.

To use the UNIX PC modem from within DOS, one of the phone lines must be configured as DATA. When applications access the modem, DOS-73 will first check if line 2 is configured as a DATA line. If not, it then checks to see if line 1 is configured for DATA. If neither line is configured for DATA, then DOS-73 will display an error message. If you do not have one of the UNIX PC phone lines setup for DATA, hold down a <Shift> key, then press screen key (F2). Pressing screen key (F3) will now change one of the phone lines from VOICE to DATA.

NOTE:

The DOS-73 implementation of the UNIX PC modem does not provide flow control. Be certain to configure communications packages to support XON / XOFF handshaking.

Because of the many levels of software information exchange which occur during access of the UNIX PC internal modem, access time will be significantly slower than when accessing the modem under UNIX. Additionally, UNIX takes control of the internal modem during the dial routine and cannot be interrupted by DOS-73 until the dial routine is completed.

EXTERNAL COM2: MODEM

An external modem connected to the DOS-73 COM2: port, behaves exactly as if it were installed on a DOS Compatible PC.

DOS-73 MOUSE SUPPORT

MOUSE

Under control of DOS-73, the UNIX PC mouse appears to be a DOS compatible Microsoft mouse. In order to use the mouse for an application program, you must first execute the mouse command program on drive C:. To do this, type the following command from the DOS prompt:

C:MOUSE

The left and middle buttons (<B1> and <B2>) of the UNIX PC mouse are used to simulate the two buttons on the Microsoft mouse. The third button (<B3>) on the UNIX PC mouse is un-used.

The Microsoft mouse supports 16 function calls (0 - 15). DOS-73 supports the following functions:

- 0 Mouse Installed Flag and Reset
- 3 Get Mouse Position and Button Status
- 5 Get Button Press Information
- 6 Get Button Release Information
- 11 Read Mouse Motion Counters
- 12 Set User-Defined Subroutine Input Mask
- 15 Set Mickey/Pixel Ratio

DOS-73 does not support the following Microsoft mouse function calls:

- 1 Show Cursor
- 2 Hide Cursor
- 4 Set Mouse Cursor Position
- 7 Set Minimum and Maximum Horizontal Position
- 8 Set Minimum and Maximum Vertical Position
- 9 Set Graphics Cursor Block
- 10 Set Text Cursor
- 13 Light Pen Emulation Mode On
- 14 Light Pen Emulation Mode Off

SECTION 7

DOS-73 FILES & DISK VOLUMES

The DOS-73 System provides a link between the UNIX PC disks and DOS Volumes. With the UNIX PC floppy disk drive, DOS-73 can format, read, and write DOS Compatible diskettes. With the UNIX PC hard disk, DOS-73 creates both DOS volumes and a UNIX Volume.

This section contains technical information on the DOS-73 disks including:

- Virtual Disks
- DOS Volumes
- The Floppy Disk
- The UNIX Volume

DOS-73 DISK DRIVES

VIRTUAL DISKS

Virtual disks are UNIX files that are made to resemble DOS disk volumes. The majority of all disk storage for the DOS-73 System is done on Virtual disks.

The DOS-73 Volume Management utility allows you to create up to 256 unique Virtual Disks ranging in capacity from 100 Kilobytes to 32000 Kilobytes.

Using the Session Configuration utility, each user can assign up to 12 Virtual disks to DOS Volumes (C: through N:). If you have not created a special Session Configuration, DOS-73 will automatically assign Virtual disks to DOS Volumes. The DOS volumes will be labelled in ascending order Dvd000, Dvd001,...Dvd012, and will be assigned as follows: Dvd000 = C:, Dvd001 = D:, etc...

DOS VOLUMES

The DOS-73 System loads DOS from the Virtual disk assigned as volume C:. This may be any Virtual disk since the Volume Management utility automatically copies COMMAND.COM (the DOS command processor) to each virtual disk. This file is necessary to load DOS. If COMMAND.COM is erased from the C: volume, DOS-73 will not be able to load DOS. Note that dvd000 is automatically assigned as drive C: during DOS-73 installation. However, drive C; can be reassigned using the Session Configuration utility.

NOTE:

If you assign the C: volume to a Virtual disk other than dvd000, you should first copy all of the MS-DOS and DOS-73 utility programs from dvd000 to another disk.

FLOPPY DISKS

The DOS-73 System uses the UNIX PC floppy disk drive to read and write DOS Compatible PC floppies. The UNIX PC floppy disk drive is treated as Drive A: and/or Drive B:, while the DOS-73 Session is active. Mounting and dismounting the floppy disk drive is unnecessary due to the fact that the DOS-73 System automatically takes care of floppy operations. If DOS-73 attempts to access a floppy which has been mounted under UNIX, the following error message will be displayed:

```
Not ready error reading drive A
Abort, Retry, Ignore?
```

NOTE:

A DOS-73 user can only access DOS compatible diskettes. UNIX users may still access UNIX floppies while the DOS-73 Session is running.

THE UNIX VOLUME

The DOS-73 UNIX volume is designed to provide a method of *Exporting* DOS files to the UNIX file system, and *Importing* UNIX files to the DOS file system. Every attempt has been made to provide a workable interface between the UNIX and DOS file systems. However, before using the DOS-73 UNIX Volume, please read the special provisions which are documented below.

NOTE:

The DOS-73 Session Configuration utility is used to create a DOS-73 UNIX volume. Specifying UNIX in the Drive Assignment window of the Session Configuration utility creates a UNIX volume. Note that the volume label of the UNIX Volume is "UNIX".

SPECIAL CONSIDERATIONS

DOS terminates a line with a Carriage Return and Line feed (CR,LF), while UNIX terminates a line with only a Line feed (LF). This may cause some incompatibility when transferring data between the two file structures.

A maximum of 3 files may be open at one time in the UNIX Volume. When a fourth file is opened, DOS-73 automatically closes the first file that was opened.

FILENAMES

DOS has a more restrictive file naming convention than UNIX. Where possible, DOS-73 permits UNIX conventions. Any exceptions are noted. The DOS file naming conventions are listed below. It is recommended that you use the DOS filenaming conventions when naming files on the UNIX volume.

FILENAMES must contain only uppercase letters, a maximum of 8 characters with a maximum of one period (.) and no more than 3 characters following the period.

The total LENGTH of a filename, including its directory path, may not exceed 64 characters in the DOS operating environment. This restriction applies to the UNIX volume.

When specifying PATHNAMES on the UNIX Volume use the DOS backslash (\) as the pathname separator, not the UNIX slash (/).

When specifying FILES and PATHNAMES on the UNIX volume, the case is significant. As a result, files and subdirectories created with uppercase letters can only be accessed using uppercase letters.

All EXTERNAL DOS commands convert filenames to uppercase. An example of this case conversion is the external command EDLIN. When creating the file "data.doc":

EDLIN data.doc

EDLIN automatically converts the filename to uppercase, making "data.doc" into "DATA.DOC". You would then have to access this file using upper case characters.

With the exception of the DIR command, INTERNAL DOS commands and user applications can create both upper and lowercase filenames. However, once created, the respective cases must be observed during future access. Refer to the MS-DOS User's Reference Section 2 for definitions of INTERNAL and EXTENAL commands.

DOS SUBDIRECTORIES

The commands MD (Make Directory), CD (Change Directory) and RD (Remove Directory) all differentiate between upper and lower case pathnames.

As an example, if you execute the following command to make a directory:

MD DATA

the only method of changing into this directory would be to execute the following command:

CD DATA

If you try to change into this directory using lower case characters, you will receive the following error message:

Invalid directory

NOTE:

Some commands, such as the DOS COPY command, cannot access sub-directories with lowercase characters. It is recommended that only uppercase characters be used when creating a directory on the UNIX Volume

THE DIR COMMAND

When doing a DIRectory of the UNIX volume, screen output will be slow compared to a DIRectory of a DOS volume. Actual data transfer is not, however, any slower on the UNIX volume than on a DOS volume.

NOTE:

The DIRectory command is not case sensitive, and therefore the commands

`"DIR D*.*"`

and

`"dir d*.*"`

would display the same files.

THE TYPE COMMAND

When TYPEing a file on the UNIX volume, you must use the case in which the file was created. For example, to type a file with the name "sample.dat", you would have to enter:

```
type sample.dat
```

The command:

```
type SAMPLE.DAT
```

would result in the DOS error message:

```
File not found
```

FILE RE-DIRECTION

The DOS "file output redirection" facility is not supported on the UNIX Volume. As an example, the command:

```
type filename >newfile
```

will not redirect the screen output from 'filename' to the file 'NEWFILE'.

DOS PIPING

The DOS piping facility which allows you to execute commands such as:

```
dir *.*|sort
```

is not support on the UNIX Volume.

APPENDIX A

APPLICATION COMPATIBILITY

This appendix lists DOS-73's compatibility with several popular applications. In some cases the applications run in a slightly restricted fashion, such as requiring a key disk in the A: floppy disk drive. Also included in this section are instructions for loading and configuring LOTUS 1-2-3 on your UNIX PC.

PROTECTED SOFTWARE

Many software packages incorporate a copy protection scheme. Most protection schemes rely on a key diskette which must be mounted in the A: drive prior to loading the software. Some programs provide a method of installing the software on a hard disk.

Every effort has been made to enable these protected software packages to run on the DOS-73 System. However, some of these programs rely on specific hardware and cycle timing which is not available on the UNIX PC. As a result, some of these protected programs will not run on the DOS-73 System.

The copy protection scheme implemented on the following programs make them unuseable on the DOS-73 System:

- Symphony Version 1.1 (1.0 works)
- Microsoft Word
- Microsoft Chart
- dbase III
- Framework

APPLICATION SETUP

Please note the information on the following applications programs when installing software on your UNIX PC:

dBase II

You must declare 'DEVICE=ANSI.SYS' in C:CONFIG.SYS to allow proper scrolling. See Section 5 for instructions on adding ANSI.SYS to the C:CONFIG.SYS file.

PFS

PFS:Graph does not function under the DOS-73 System. This is due to the fact that it uses the second-page video, which DOS-73 does not support.

The remainder of the PFS software version B series runs properly on the DOS-73 system with the following exception. The PFS software packages use a protection scheme which allows the software to be copied to a hard disk. This feature will not work with the DOS-73 system. All of the PFS files may be copied to the hard disk, however, the key diskette must be inserted in the UNIX PC floppy disk drive. Also, the PFS Backup utility will not function properly with DOS-73. This is because of the copy protection scheme.

WordStar 2000

Version 1.00 does not work with DOS-73 because of its copy protection scheme. Version 1.01 does work. If you already have version 1.00, a version 1.01 upgrade is available from MicroPro International. When installing Wordstar 2000, be sure to configure the software for a non-color, non-special graphics system.

WordStar Version 3.XX

When printing WordStar files in the spooled mode, some printers will automatically input extra form-feeds. For this reason, it is recommended that you use the direct mode for printing with WordStar version 3.xx.

INSTALLING LOTUS 1-2-3

The following step-by-step instructions show you how to install LOTUS 1-2-3 on the UNIX PC. The DOS Virtual disk (dvd) on which you are installing LOTUS must have a minimum capacity of approximately 2 megabytes of available space. If you do not have a DOS Virtual disk (dvd) with the minimum capacity already created, you must use the Volume Management utility to create one.

1. From the Office window, select the DOS-73 System option.
2. At the DOS-73 menu, select DOS-73 Session.
3. From the initial C> prompt, change to the DOS volume on which you want to install your LOTUS 1-2-3 program (for the sake of example, we assume that this will be drive D).

C>D:

4. On the D: drive, create a sub-directory for the LOTUS files. To do this, use the DOS command 'Make Directory' (MD):

D>MD LOTUS

5. Change into the LOTUS sub-directory, using the DOS command 'Change Directory' (CD):

D>CD LOTUS

6. Insert a LOTUS diskette into the A: (floppy) drive (the order in which LOTUS diskettes are copied is irrelevant).
7. From the DOS D prompt, execute the DOS COPY command:

D>COPY A:*.*

8. After the first diskette has been copied, remove it and insert the next diskette. Press <F3> (the <FIND> key on the UNIX PC), and the previous COPY command will re-appear at the D prompt. Press a <Return> to execute the command.

INSTALLING LOTUS 1-2-3

9. Repeat step #8 until all five diskettes have been copied.
10. To install the driver set (and to rename the driver files) which applies to the Hercules graphics card, run the Hercules.Bat file. To do this, enter:

D>HERCULES

11. When this batch file prompts you to type any key to continue, do so. This file will rename all of the applicable driver files.
12. The next time that the batch file prompts you to type any key to continue, abort the batch file by pressing:

<Ctrl><C>

The computer will respond:

Terminate batch job (Y/N):

13. Type 'Y' to abort.

This completes the LOTUS 1-2-3 installation on the UNIX PC.

NOTE:

In order to run LOTUS 1-2-3, the system diskette must be in the A: (floppy) drive.

APPENDIX B

DOS UTILITIES

The DOS 3.1 files are automatically copied to the Virtual Disk (dvd000) which is created during the DOS-73 System installation. The following is a complete list of the DOS 3.1 files which are shipped with the DOS-73 System:

DOS 3.1 FILES

ASSIGN.COM x	ATTRIB.EXE x	EXITDOS.COM
DEBUG.COM x	CHKDSK.COM x	
EDLIN.COM x	EXE2BIN.EXE x	
FIND.EXE x	JOIN.EXE x	
LINK.EXE x	MORE.COM x	
PRINT.COM x	SHARE.EXE x	
SORT.EXE x	SUBST.EXE x	
FC.EXE x	COMMAND.COM x	
PN.EXE	MOUSE.COM	AUSI.SYS

Some of the standard DOS utilities do not work properly with DOS-73, as such they are not included with your DOS-73 System. Equivalent functions are provided by either the UNIX User Agent or DOS-73 utilities. The following is a complete list of these utilities:

FORMAT.COM	DISKCOPY.COM
BACKUP.COM	RESTORE.COM
SYS.COM	RECOVER.COM

For more information on the DOS 3.1 utilities please refer to the MS-DOS User's Reference.

APPENDIX C

DOS-73 DIAGNOSTICS

To run the Diagnostics, insert the DOS-73 Diagnostics Diskette into the floppy disk drive and invoke the UNIX Shutdown command. When prompted, press the <Return> key to load the diagnostics.

Testing the COM2: port

A COM2: LOOPBACK connector has been included with your DOS-73 package. It connects the following RS-232 pins together:

<u>Pin #</u>	<u>Function</u>
2 - 3	Transmit-Receive
4 - 5	RTS-CTS
6 - 8 - 20	DSR-RLSD-DTR

This connector must be inserted in the DOS-73 COM2: port before testing begins. If this connector is not inserted in the COM2: port a Failed message will appear after the 'Testing COM2:' message.

Number of Test Passes

The only user selectable option for the DOS-73 diagnostics is the number of test passes. Each pass tests all of the components of the DOS-73 Hardware. The Diagnostics can be aborted at any point by hitting the <Break> key.

DOS-73 DIAGNOSTICS

The following screen is displayed when the DOS-73 Diagnostics are loaded:

DOS-73 Diagnostics

Rev. x.xx

Enter the number of passes (0= Test until Break is hit) <0> 1

Insert the COM2: LOOPBACK connector to the rear of the DOS-73 board.

Hit return key to continue...

Testing MEMORY	(Passed)
Testing Video NMI	(Passed)
Testing I/O NMI	(Passed)
Testing Video Remap	(Passed)
Testing COM2:	(Passed)
Testing Re-fresh/Timer	(Passed)
Testing Interrupt Controller	(Passed)
Testing address trap	(Passed)
Testing 8087	(Absent)

Pass #1 (Successful)

Press return key to continue...

DOS-73 DIAGNOSTICS

IN CASE OF TROUBLE

If any errors are detected, the DOS-73 Diagnostics will report a 'Failed' message after the appropriate test and an 'Unsuccessful' message after the PASS # count.

At this point you should do the following:

1. Power off the UNIX PC, using the "Shutdown" command.
2. Remove the DOS-73 Board.
3. Press down on all of the socketed I.C. chips to assure that they are properly seated.
4. Replace the DOS-73 board.
5. Power up the UNIX PC.
6. Insert the DOS-73 Diagnostics diskette and repeat the test.

If problems persist, select another slot in the UNIX PC and repeat the test. If you are still unable to successfully test the DOS-73 system, it must be returned for repair.

APPENDIX D

DOS-73 SYSTEM FILES

The DOS-73 System Software is comprised of four diskettes. One diskette is a bootable diagnostics diskette. The other three diskettes contain all of the DOS 3.1 files as well as the DOS-73 files.

The following utilities have been included in the DOS-73 System:

PM.EXE

This is the DOS-73 Printer Management utility. It allows you to select any of three supported printers. It also enables you to select Spooled or Direct printing when selecting a UNIX printer, and to set baud rates, parity, data and stop bits when printing from the DOS-73 COM2: port. For more information, please refer to Section 6 of this User's Guide.

EXITDOS.EXE

The EXITDOS utility is designed for use in .BAT files as a way of exiting a PC-DOS Application program and returning to the PC-DOS Applications menu.

When executed during a DOS-73 Session, this command functions identically to the UNIX PC <Exit> key.

DOS-73 SYSTEM FILES

DOS-73 SYSTEM FILES

The DOS-73 System Files are the files that are necessary for the operation of the DOS-73 System. These include utilities and support files. They are placed into the UNIX file structure during installation, and during execution of the Session Configuration and Volume Management utilities. On the following page is a chart that shows where in the UNIX file system all of the DOS-73 System files are placed.

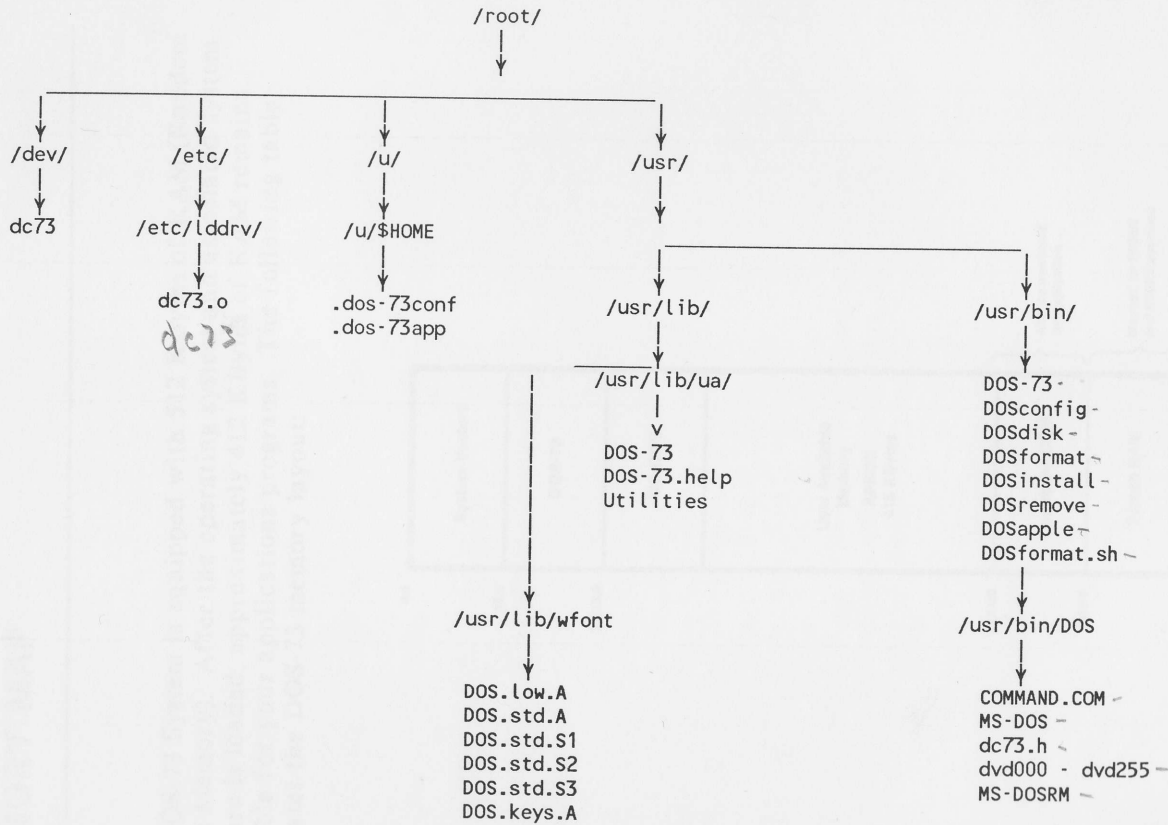

APPENDIX E

MEMORY MAP

The DOS-73 System is equipped with 512 KBytes of RAM (Random Access Memory). After the operating system and associated system software is loaded, approximately 412 KBytes of RAM remains available for your applications programs. The following table illustrates the DOS-73 memory layout:

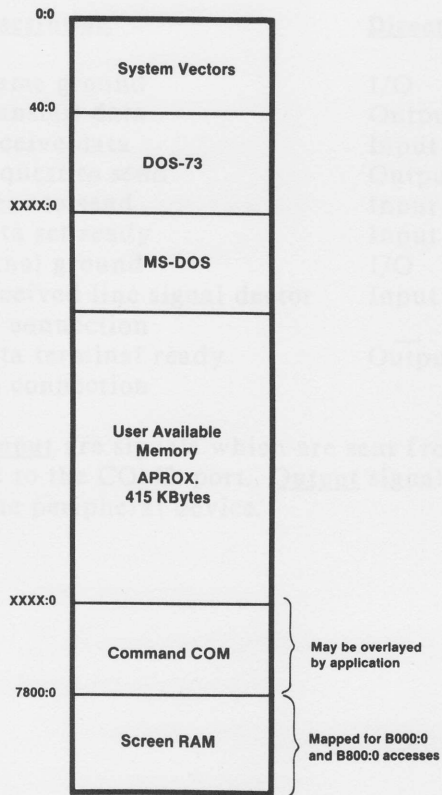

APPENDIX F

COM2: PINOUTS

A COM2: serial port is included on the DOS-73 board. The cables required to connect COM2: to peripheral devices are identical to those provided for an IBM PC or the AT&T 6300 and the associated peripherals.

The following is a definition of the COM2: hardware pinouts:

<u>Pin</u>	<u>Description</u>	<u>Direction</u> *
1	Frame ground	I/O
2	Transmit data	Output
3	Receive data	Input
4	Request to send	Output
5	Clear to send	Input
6	Data set ready	Input
7	Signal ground	I/O
8	Received line signal detector	Input
9 - 19	No connection	
20	Data terminal ready	Output
21 - 25	No connection	

- * Pins marked as **Input** are signals which are sent from the peripheral device to the COM2: port. **Output** signals are sent from COM2: to the peripheral device.

DOS-73

GLOSSARY

AUTOEXEC.BAT This is a self executing Batch file that can be used at DOS load time to automatically log a user into a certain drive and directory. It can contain any commands that a user wants as part of his DOS startup.

.BAT This is a DOS filename extension used when creating BATCH files. Batch files contain a series of commands. For more information on batch files, please refer to the MS-DOS User's Reference.

CONFIG.SYS This is a DOS file that contains the names of device drivers and other system parameters which get read by DOS at load time. For more information on CONFIG.SYS, please refer to the MS-DOS User's Reference.

DOS DOS is an acronym for Disk Operating System. The DOS-73 System is based on MS-DOS Version 3.1.

dvdnnn (DOS Virtual Disk) DOS Virtual Disks (dvd) are UNIX files that are created by the DOS-73 Volume Management utility, and then assigned to DOS Volumes (C:, D:, E: etc.).

GLOSSARY

EXITDOS This is a DOS-73 utility designed for use in PC-DOS Application batch files, and for use from the DOS command line. When executed, the EXITDOS utility will exit DOS and return you to the DOS-73 window.

Export To move files from the DOS file structure to the UNIX file system.

Import To move files from the UNIX file structure to the DOS file system.

Printer Management This is a DOS-73 utility designed for managing system printers. It enables a user to select any of three supported printers. Additionally, this utility initializes the COM2: serial port. For more information on the PM utility, please refer to Section 6 of this manual.

SESSION CONFIGURATION This utility allows you to optionally reassign Virtual disks (special UNIX files) to DOS Volumes (C:, D:, E:, etc.). For more information on the Session configuration utility, please refer to Section 3 of this manual.

VOLUME MANAGEMENT This is the DOS-73 utility that is used to create virtual disks. Virtual disks are UNIX files ranging in size from 100K to 30,000K.

GLOSSARY

Virtual Disk See dvd.

Volume A DOS volume is a logical disk drive. DOS-73 allows a maximum of 12 volumes on the hard disk (C: - N:), plus the floppy drive which is recognized as both A: and B:.

DOS-73

INDEX

A

AUTOEXEC.BAT 4-3

B

Batch or .BAT 3-4, 3-5, 3-6, 4-3

C

Configuration 3-1, 3-10, 3-12
COM2: 1-2, 1-6, 6-2, 6-3, 6-4, 6-5, Appendix G
CONFIG.SYS 4-3, 5-8

D

Diagnostics Appendix D

E

Emulation 1-4, 5-1, 5-8
Exporting 7-4
EXITDOS 3-4, 3-6, Appendix E

INDEX

F

Format

DOS Diskette 3-1, 3-3

H

HELP

1-3, 3-2

I

Installation

Hardware 2-4

Software 2-6

Install DOS Software 3-1, 3-4

Inventory 2-2

Importing 7-4

K

Keyboard

5-2,5-3,5-4,5-5,5-6,5-7

M

Modem 6-5

Mouse 6-6

R

- Removal
 - Hardware 2-12
 - Software 2-11
- Remove DOS Software 3-8
- RS-232 1-2, 6-2

S

- Screen Presentation 5-8
- Screen Graphics 5-8
- Screen Keys 5-6
- Session Configuration 3-1, 3-10
- Software
 - Installation 2-6
 - Removal 2-11

U

- Upgrade
 - 8087 Installation 2-10

INDEX

V

- Virtual Disk 3-5, 3-6, 3-10, 3-11, 3-12, 3-14, 3-15, 3-16, 7-2
- Volume 2-9, 3-1, 3-10, 3-11, 3-12, 3-14
- Volume Management 3-1, 3-14

LIMITED USE SOFTWARE LICENSE AGREEMENT

This card contains the AT&T Information Systems, Inc. ("AT&T-IS") LIMITED USE SOFTWARE LICENSE AGREEMENT. Once you have read this license agreement and agree to its terms, you may open the sealed envelope containing the program media. By opening the seal, you show your acceptance of the terms of this LIMITED USE SOFTWARE LICENSE AGREEMENT. The Agreement is in effect from then until you return to AT&T-IS all the SOFTWARE.

In the event that you disagree with any of the terms of this Agreement, return your sales receipt and the SOFTWARE with the seal unbroken to the location where you obtained the SOFTWARE and your money will be refunded.

If you have executed a separate Software Agreement with AT&T-IS, such Software Agreement will govern.

LIMITED USE SOFTWARE LICENSE AGREEMENT

AT&T Information Systems, Inc. ("AT&T-IS") and you agree that the terms and conditions hereof will apply to the SOFTWARE supplied herewith and derivatives obtained therefrom, including any archive copy. The term SOFTWARE includes software programs and related documentation.

1. TITLE AND LICENSE GRANT

Notice is hereby given that the SOFTWARE contains copyrighted and/or proprietary information protected by the laws of the United States. All SOFTWARE will remain the sole property of AT&T-IS. AT&T-IS hereby grants you a personal, non-transferable and non-exclusive right to use, in the United States, all SOFTWARE, in whatever form recorded, which is furnished to you under or in contemplation of this Agreement. This grant is limited to use on the single host processor that you identify on the enclosed Software Registration Card. Use of this SOFTWARE by you on any processor other than the one identified by you or removal of the SOFTWARE from the United States shall automatically terminate this license.

You agree to use your best efforts to see that your employees or any other user of the SOFTWARE licensed hereunder comply with the terms and conditions of this Agreement and refrain from taking any steps, such as reverse assembly or reverse compilation, to derive a source code equivalent of the software.

2. SOFTWARE USE

- A. You agree to obtain prior AT&T-IS approval for multi-processor usage.
- B. You are permitted to make a single archive copy, provided the SOFTWARE
 - 1. shall not be otherwise reproduced, copied or, except for the documentation, disclosed to others in whole or in part, and that the archive copy shall contain the same copyright notice and proprietary marking as appears on the original SOFTWARE, including diskette markings;
 - 2. shall, together with any archive copy thereof, be either returned to AT&T-IS or destroyed when no longer used with the host processor for which it was initially furnished, or when the license to use is terminated; and
 - 3. shall not be removed from the United States.

3. LIMITED WARRANTY

- A. AT&T-IS warrants that the SOFTWARE will be in good working order and will replace, without charge, any SOFTWARE which is not in good working order if returned to the location where you obtained it within (90) days of delivery to you. At its option, AT&T-IS may refund the purchase price of the SOFTWARE.
- B. AT&T-IS does *not* warrant that the functions of the SOFTWARE will meet your requirements or that SOFTWARE operation will be error-free or uninterrupted.
- C. AT&T-IS has used reasonable efforts to minimize defects or errors in the SOFTWARE. HOWEVER, YOU ASSUME THE RISK OF ANY AND ALL DAMAGE OR LOSS FROM USE, OR INABILITY TO USE, THE SOFTWARE.

- D. Unless a separate agreement for software maintenance is entered into between you and AT&T-IS, AT&T-IS bears no responsibility for supplying assistance for fixing or for communicating known errors to you pertaining to the SOFTWARE supplied hereunder.
- E. YOU UNDERSTAND THAT, EXCEPT FOR THE 90 DAY LIMITED WARRANTY FOR INOPERATIVE SOFTWARE, AT&T-IS, ITS AFFILIATES, CONTRACTORS, SUPPLIERS AND AGENTS MAKE NO WARRANTIES, EXPRESS OR IMPLIED, AND SPECIFICALLY DISCLAIM ANY WARRANTY OF MERCHANTABILITY OR FITNESS FOR A PARTICULAR PURPOSE.

Some states do not allow the exclusion of implied warranties or limitations on how long an implied warranty lasts, so the above limitations may not apply to you. This warranty gives you specific legal rights and you may also have other rights which vary from state to state.

4. EXCLUSIVE REMEDIES AND LIMITATION LIABILITIES

- A. YOU AGREE THAT YOUR SOLE REMEDY AGAINST AT&T-IS, ITS AFFILIATES, CONTRACTORS, SUPPLIERS, AND AGENTS FOR LOSS OR DAMAGE CAUSED BY ANY DEFECT OR FAILURE IN THE SOFTWARE REGARDLESS OF THE FORM OF ACTION, WHETHER IN CONTRACT, TORT INCLUDING NEGLIGENCE, STRICT LIABILITY OR OTHERWISE, SHALL BE THE REPLACEMENT OF AT&T-IS FURNISHED SOFTWARE, PROVIDED SUCH SOFTWARE IS RETURNED TO AT&T-IS WITH A COPY OF YOUR SALES RECEIPT. THIS SHALL BE EXCLUSIVE OF ALL OTHER REMEDIES AGAINST AT&T-IS, ITS AFFILIATES, CONTRACTORS, SUPPLIERS AND AGENTS, EXCEPT FOR YOUR RIGHT TO CLAIM DAMAGES FOR BODILY INJURY TO ANY PERSON.
- B. Notwithstanding any other provisions of this Agreement, neither AT&T-IS nor its affiliates, contractors, suppliers and agents shall be liable for any indirect, incidental, or consequential damages (including lost profits) sustained or incurred in connection with the use, operation, or inability to use the SOFTWARE or for damages due to causes beyond the reasonable control of AT&T-IS, its affiliates, contractors, suppliers and agents attributable to any service, products or action of any other person.
- C. This Agreement shall be construed in accordance with and governed by the laws of the State of New Jersey.

YOU ACKNOWLEDGE THAT YOU HAVE READ THIS AGREEMENT AND UNDERSTAND IT, AND THAT BY OPENING THE SEAL CONTAINING THE PROGRAM MEDIA YOU AGREE TO BE BOUND BY ITS TERMS AND CONDITIONS. YOU FURTHER AGREE THAT THIS AGREEMENT IS THE COMPLETE AND EXCLUSIVE STATEMENT OF THE RIGHTS AND LIABILITIES OF THE PARTIES. THIS AGREEMENT SUPERSEDES ALL PRIOR AGREEMENTS, PROPOSALS OR UNDERSTANDINGS, ORAL OR WRITTEN, AND ANY OTHER COMMUNICATIONS BETWEEN US RELATING TO THE SUBJECT MATTER OF THIS AGREEMENT.



NO POSTAGE
NECESSARY
IF MAILED
IN THE
UNITED STATES

BUSINESS REPLY MAIL

FIRST CLASS PERMIT NO. 785 MORRISTOWN, NJ

POSTAGE WILL BE PAID BY ADDRESSEE

**AT&T Information Systems
Product Management Group
Room 10A47
1776 On The Green
Morristown, NJ 07960**

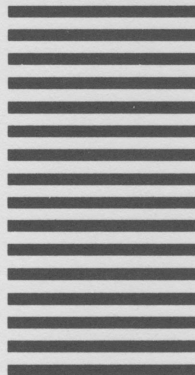

Do Not Tear—Fold Here and Tape

999-801-0281S