

# EDN<sup>®</sup>

Sensitive oscilloscope measurements	pg 45
Fiber-optic sensors	pg 59
Electro/International Show: Sessions and Products	pg 107
Designers' guide to servo simulation—Part 2	pg 123

ELECTRONIC TECHNOLOGY FOR ENGINEERS AND ENGINEERING MANAGERS

IEC 555-2  
Mains distortion  
Harmonic current

CAPACITOR INPUT FILTER

3 $\phi$  INPUT

PASSIVE PFC

CHOKe INPUT

Power factor corrected (full cycle rectifier conduction)

3000 W

Special Report:  
**Switching supplies use chips  
 and chokes to correct power factor**



# Uncanny capacitance.

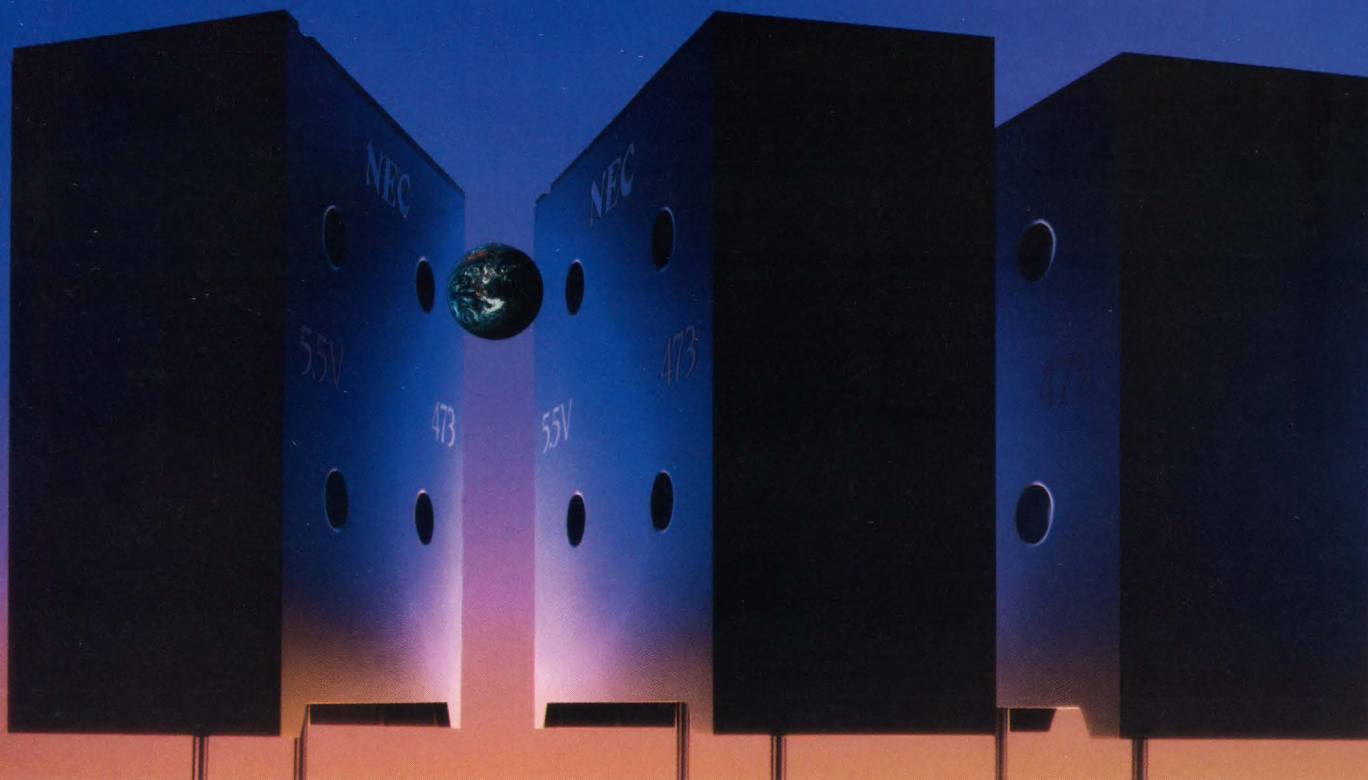

## NEC Supercaps offer out-of-this-world performance.

Creating high capacitance in small cases has been an NEC specialty for decades. The three new Supercaps in our FM series are an extraordinary example.

To equal the 0.169F capacitance that NEC has packed into these electric double-layer capacitors, Mother Nature would require 238 spheres the size of planet earth.

Fast charging, semipermanent life and excellent safety factors make NEC Supercaps an ideal

replacement for backup batteries.

Supercaps come in eight series, covering a wide range of backup needs from CMOS RAMs and microcomputers to large-current



applications. For more information, contact NEC today.

Series	Application	Capacitance (F)	Feature
FYD	RAM/microcomputer backup	0.022 - 2.2	Space saving
FYH		0.022 - 1.0	Low profile
FYL		0.01 - 0.047	Extra low profile
FM		0.022 - 0.1	Auto insertion/soldering
FR		0.022 - 1.0	Wide operating temperature (-40°C to +85°C)
FS	Medium backup current	0.022 - 1.0	
FA	Large backup current	0.047 - 1.0	5.5V
FE		0.022 - 0.47	11.0V
		0.047 - 1.5	Low ESR

CIRCLE NO. 3

### For fast answers, call us at:

USA Tel:1-800-632-3531. Fax:1-800-729-9288. Germany Tel:0211-650302. Telex:8589960. The Netherlands Tel:040-445-845. Telex:51923.  
 Sweden Tel:08-753-6020. Telex:13839. France Tel:1-3067-5800. Telex:699499. Spain Tel:1-419-4150. Telex:41316. Italy Tel:02-6709108. Telex:315355.  
 UK Tel:0908-691133. Telex:826791. Ireland Tel:01-6794200. Fax:01-6794081. Hong Kong Tel:755-9008. Telex:54561. Taiwan Tel:02-719-2377. Telex:22372.  
 Korea Tel:02-551-0450. Fax:02-551-0451. Singapore Tel:253-8311. Fax:250-3583. Australia Tel:03-267-6355. Telex:38343.



# ALL ABOARD!

The Engine with Everything You Need  
To Get There On Time

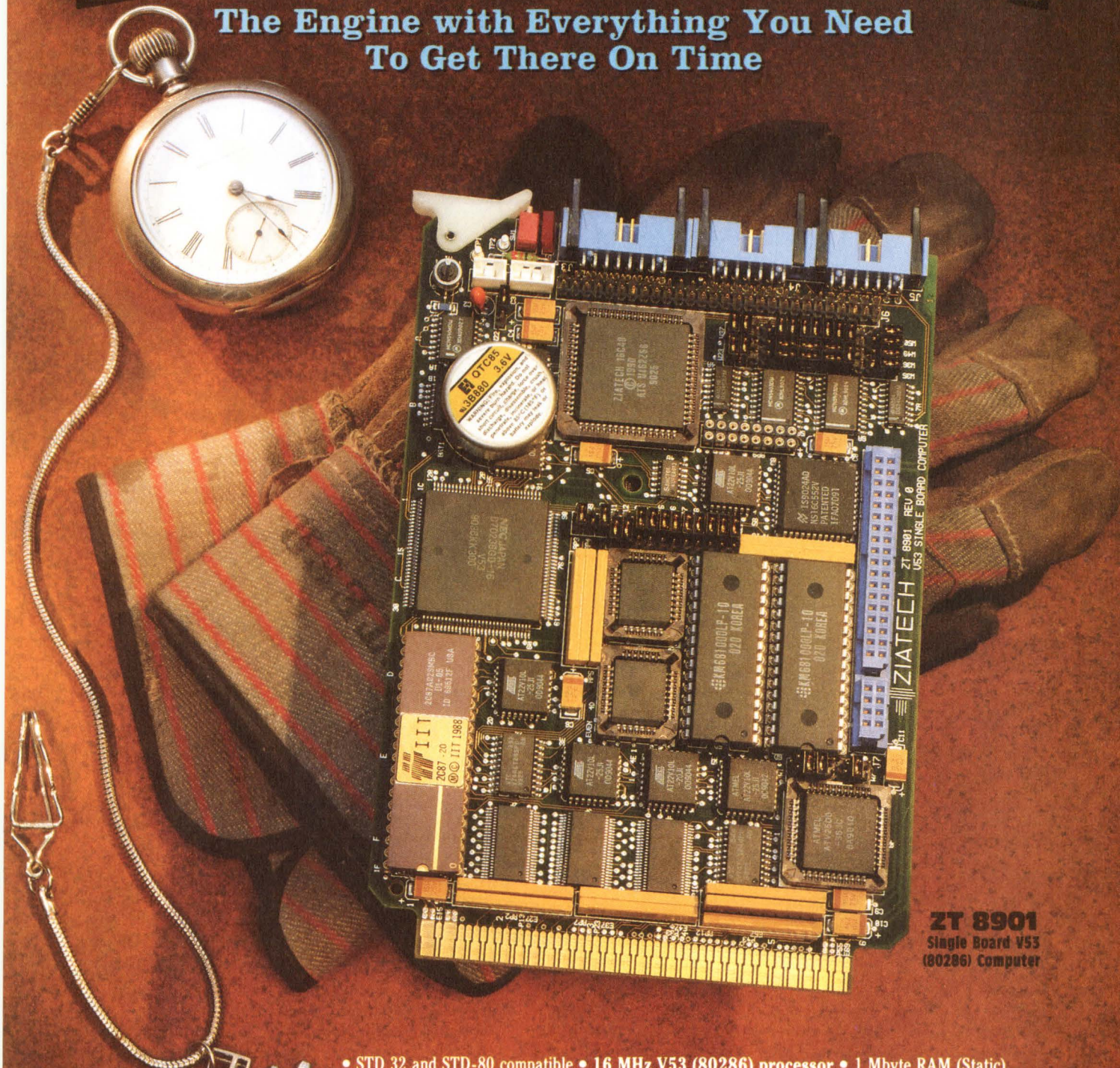

**ZT 8901**  
Single Board V53  
(80286) Computer

Call For Free  
On-site  
Demonstration  
Or Technical Data

805-541-0488

FAX: 805-541-5088

- STD 32 and STD-80 compatible
- 16 MHz V53 (80286) processor
- 1 Mbyte RAM (Static), 1 Mbyte ROM
- Numeric data processor socket
- Flash EPROM Support
- Three serial ports (RS-232/485)
- One interrupt controller (8259)
- Three 16-bit counter/timers (8254)
- STD 32 Multiple Bus-master Operation
- Three DMA channels (8237)
- 8-bit or 16-bit SBX with DMA
- Real-time clock
- 48 parallel I/O lines (Opto 22-compatible)
- AC/DC power fail detection
- DOS, VRTX, STD ROM and STD LADDER software support
- Watchdog timer
- 20-year MTBF (175K hours)
- -40° to +85° C Option
- Dynamic 8- and 16-bit bus sizing
- Low power CMOS with sleep mode
- Two-year warranty, and more.

STD 32™

Circle No. 1

**ZIATECH**  
CORPORATION



**NEW**

# PC Data Acquisition

## Quality • Innovation • Performance

- RTSI bus for multiboard synchronization
- Software-configurable analog input and gain
- 200 ksamples/sec
- 12-bit resolution
- True self-calibration

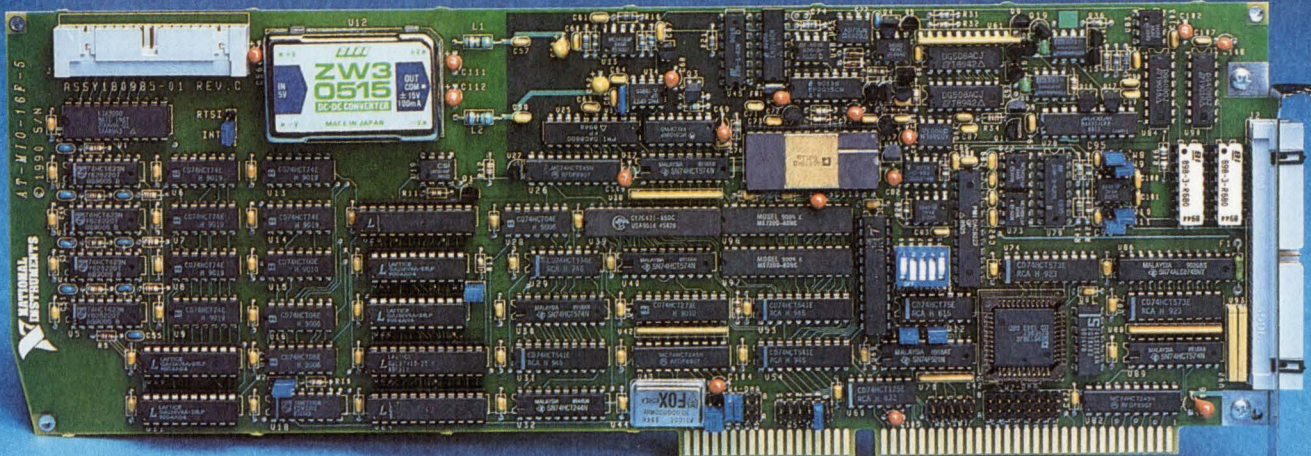

- Dither generator increases effective resolution beyond 12 bits
- Separate analog and digital sections for optimum noise control
- Custom instrument amplifier guarantees 12-bit accuracy at all gains and sampling rates

### The National Instruments AT-MIO-16F-5 Sets the New Standard

It takes a serious commitment to quality to deliver data acquisition boards that reliably meet the most demanding specifications. Our new AT-MIO-16F-5 creates a new standard in excellence with several firsts, including a proprietary ultra high-performance instrumentation amplifier, a dither generator for extended resolution, and self-calibration that eliminates the need for external signals required by other "self-calibrating" boards. The quality, innovation, and

performance of our AT-MIO-16F-5 sets the new standard in PC data acquisition. As the table below shows, the rest of our extensive PC product line surpasses industry standards. Each board undergoes a 48-hour burn-in, and passes a thorough system test to guarantee linearity, fast analog input settling, high common-mode rejection, and low noise. At National Instruments, we're serious about data acquisition.

Data Acquisition Board	Computer Bus	Analog Input					Analog Output				Software					
		Channels*	Max Sampling Rate (samples/sec)	Resolution (bits)	Ranges (V)	Gains	Channels	Resolution (bits)	Digital I/O Channels	Counter/Timers	LabWindows	DOS LabDriver	PC LabDriver	Measure	VisionScope	Third Party
AT-MIO-16F-5	AT	16 SE 8 DI	200,000	12	±5, 0 to 10	0.5, 1, 2, 5, 10, 20, 50, 100	2	12	8	3	✓	✓				
AT-MIO-16H-9	AT	16 SE	100,000	12	±10, ±5, 0 to 10	1, 2, 4, 8	2	12	8	3	✓	✓		✓	✓	✓
AT-MIO-16H-15	AT	8 DI									✓	✓		✓	✓	✓
AT-MIO-16H-25	AT	8 DI									✓	✓		✓	✓	✓
AT-MIO-16L-9	AT	16 SE	100,000	12	±10, ±5, 0 to 10	1, 10, 100, 500	2	12	8	3	✓	✓		✓	✓	✓
AT-MIO-16L-15	AT	8 DI									✓	✓		✓	✓	✓
AT-MIO-16L-25	AT	8 DI									✓	✓		✓	✓	✓
Lab-PC	XT	8 SE	62,500	12	±5, 0 to 10	1, 2, 5, 10, 20, 50, 100	2	12	24	3	✓	✓	✓	✓	✓	✓
PC-LPM-16	XT	16 SE	50,000	12	±5, 0 to 10 ±2.5, 0 to 5	1	-	-	16†	3	✓	✓	✓			
AT-DIO-32F	AT	-	-	-	-	-	-	-	32	-	✓	✓	✓			✓
PC-DIO-96	XT	-	-	-	-	-	-	-	96	-	✓	✓	✓			✓
PC-DIO-24	XT	-	-	-	-	-	-	-	24	-	✓	✓	✓			✓
PC-TIO-10	XT	-	-	-	-	-	-	-	16	10	✓	✓	✓			
EISA-A2000	EISA	4 SE SS	1,000,000	12	±5	1	-	-	-	-	✓	✓				✓



\* SE - Single-Ended, DI - Differential, SS - Simultaneous Sampling

† 8 Channels In, 8 Channels Out



**Call for FREE Catalog**  
 (512) 794-0100 or (800) 433-3488 (U.S. and Canada)

Nihon National Instruments K.K. (Japan) 03 3788 1921 • National Instruments France 1 4865 3370  
 National Instruments Italy 02 4830 1892 • National Instruments Switzerland 056 45 58 80  
 National Instruments United Kingdom 0635 523 545 • National Instruments Germany 089 436 1447

Circle No. 2

See us at Electro Booth 2034.



**BELL**  
2000 pts 50 kHz  
Sample Rate

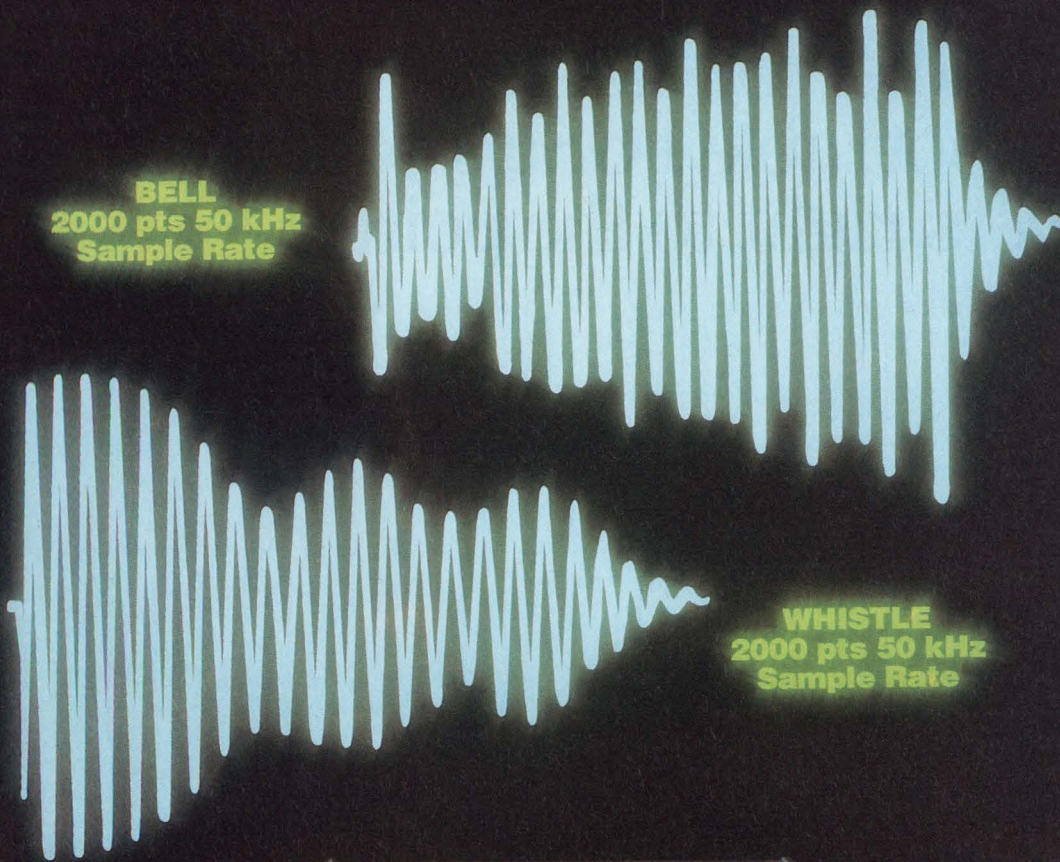

**WHISTLE**  
2000 pts 50 kHz  
Sample Rate



## Our new function generator has all the bells and whistles.

In fact, it has any kind of waveform you can imagine. Because the Model 95 combines a high performance function generator with a powerful arbitrary generator.

As a function generator, Model 95 produces remarkably pure square waves, triangles and sines, from 1 mHz to 20 MHz with synthesized accuracy up to 0.001%. It has

the power to output 15 Vp-p into 50 $\Omega$ , and includes sweep, pulse and modulation modes plus four user-selectable output impedances. There's even an internal trigger generator for trigger, gate and burst.

If you'd rather be arbitrary, Model 95 gives you up to 128k of waveform memory to work with, and a sample rate of 20 MHz. Four different editing

modes help you produce even the most complicated wave shapes quickly and accurately, while analog and digital filters allow you to create the purest output possible.

For information about all the other bells and whistles you'll find on the Model 95, call Wavetek San Diego, Toll Free at **1-800-874-4835** today.



# Now, find errors fast, with a portable 1 GSa/s scope that gets right to the point.

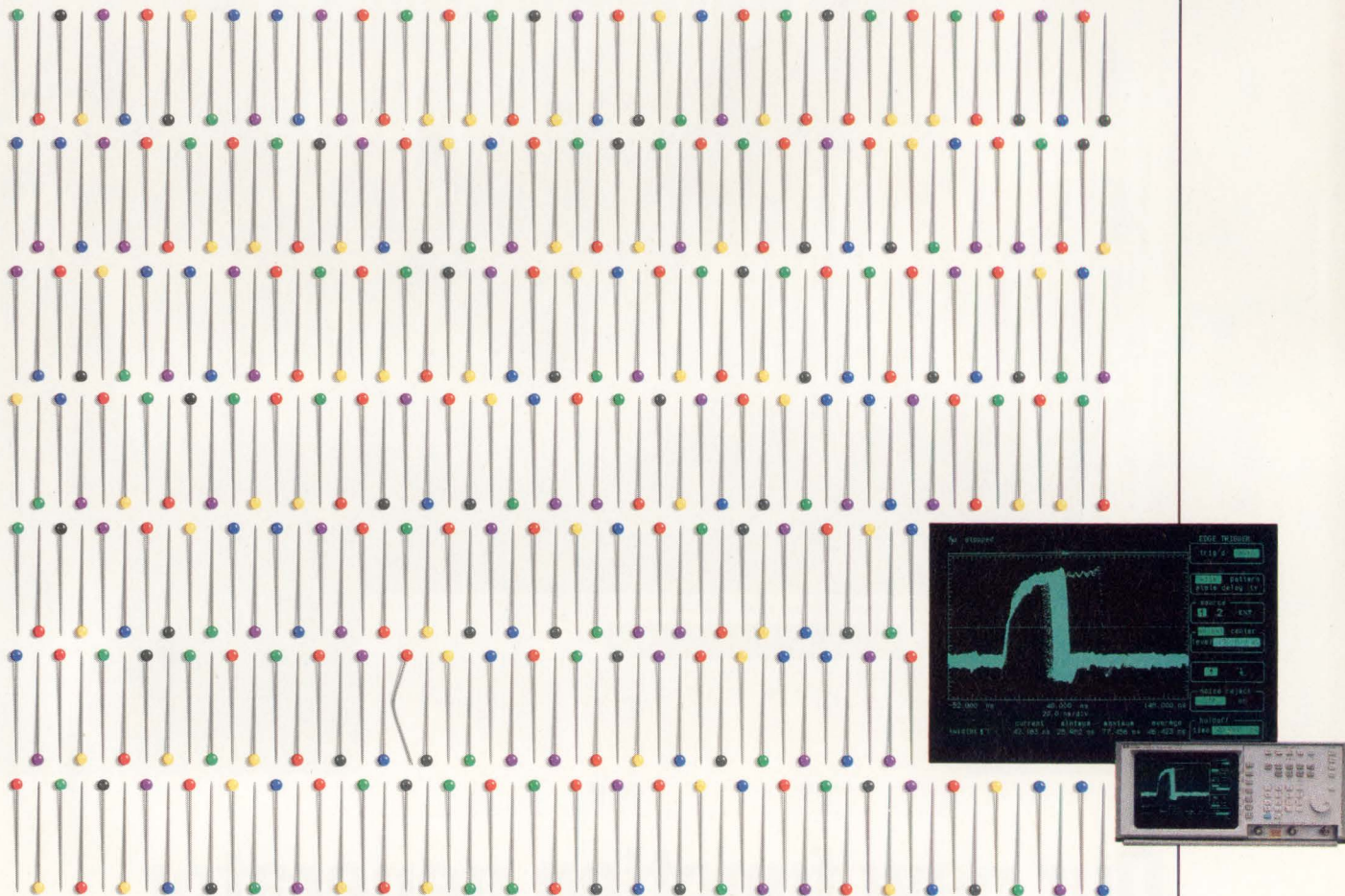

## At \$10,950\*, you won't find a better value in a digitizing scope.

When you need to troubleshoot and debug digital designs fast, you can't afford to miss a thing. And now, you don't have to. The HP 54510A looks at a billion samples a second with a time-qualified pattern triggering and an infinite persistence display to pinpoint rare events and elusive glitches the instant they happen.

You don't have to stick around to watch, either. The HP 54510A has 8k of memory per channel to capture and store single events. So, you can go back and get all the details you need—with razor-sharp, 8-bit resolution—and track the problem to its source. And to point you to the right solution, the HP 54510A gives you 17 pulse-parameter measurements, with better horizontal and vertical accuracy than the Tek DSA 602, at one-third of the cost.

So, if you're looking for a solution to high-speed troubleshooting, call **1-800-752-0900\*\***. Ask for **Ext. 1902**, and we'll send you an application note on the HP 54510A that shows you how to find faults fast.

\*U.S. price only.

\*\*In Canada call 1-800-387-3867, Dept. 423.

There is a better way.





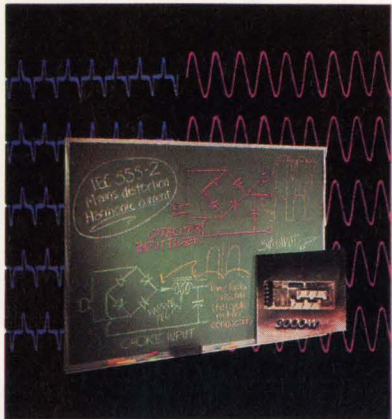

**On the cover:** If you think your off-line switching power supply draws only sinusoidal current, you may be underestimating the incoming ac line current by as much as 40%. Supplies corrected for the input current's power factor—the result of the nonsinusoidal current waveshape—are better equipped to meet the needs of many ac-powered products. See our Special Report on pg 90. (Photo courtesy Kepco Inc)

## SPECIAL REPORT

### Power-factor-corrected switching power supplies 90

Goaded by the IEC and encouraged by IC vendors, firms that make switching power supplies are starting to correct a long-standing problem: their products' propensity to draw nonsinusoidal line currents.—*Dan Strassberg, Associate Editor*

## DESIGN FEATURES

### Electro/International 107

This show will provide you with information on new electronic products, technologies, and professional career issues.—*John Gallant, Associate Editor*

### Electro/International Products 111

### Designers' guide to servo simulation using PSpice—Part 2 123



Part 2 of this 2-part series describes how to use the mechanical models presented in part 1 to create more complex mechanical subsystems, such as rotational loads and gear trains. Combining these models with standard electrical circuit models lets you analyze the dc, ac, and transient response of an entire servo-control system.—*Dr Vincent G Bello, Norden Systems*

### Designers' guide to subranging ADCs—Part 1 139

Subranging A/D converters offer performance levels difficult to obtain with successive-approximation or flash converters. They can deliver higher conversion speed and resolution and suit such applications as digital signal processing. Part 1 of this 3-part series explores the architecture and operation of these devices.

—*Ray K Ushani, Datel Inc*

*Continued on page 7*



# THE SPARC OF A NEW GENERATION.



SPARCstation 2



## A new generation of performance.

The new SPARCstation™ 2 from Sun Microsystems delivers almost twice the CPU performance of previous generations – the highest performance in its class.



Integer Unit



Floating Point Unit



Cache Controller and Memory Management Unit



Cache Storage Units

The complete SPARC chipset, designed by our ROSS Technology subsidiary, is now available for high-volume applications.

The reason for this blazing speed: The highest-performance CMOS SPARC™ available. The CY7C601, 32-bit SPARC microprocessor and CY7C157 16K x 16 Cache Storage Units from Cypress Semiconductor. Cypress 0.8 micron CMOS gives the CY7C601 SPARC RISC microprocessor 40 MHz clock rates and a sustained throughput of 29 MIPS.

## Next generation compatibility.

Because they're SPARC chips, they're completely compatible with over 2100 SPARCware™ products. They offer true scalability into a wide spectrum of applications. And a growth path for future high-performance products.

Get this level of performance, potential, and compatibility for your next-generation products.

The Cypress SPARC.

For the whole story on RISC, call the Cypress Hotline at 1-800-952-6300.\* Ask for dept. C4M.

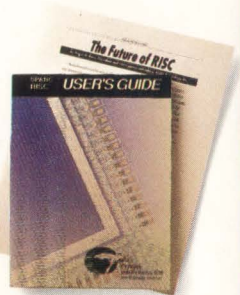

CYPRESS SEMICONDUCTOR

\*1(800)387-7599 in Canada. (32)2 672-2220 in Europe. ©1990 Cypress Semiconductor, 3901 North First Street, San Jose, CA 95134. Phone: (408) 943-2600. Telex: 821032 CYPRESS SNJ UD. TWX: 910-997-0753. SPARC is a registered trademark of SPARC International, Inc. SPARCstation and SPARCware are trademarks of SPARC International, Inc., licensed exclusively to Sun Microsystems, Inc. Products bearing the SPARC trademark are based on an architecture developed by Sun Microsystems, Inc.



**VP/Publisher**  
Peter D Coley

**Associate Publisher**  
Mark Holdreith

**VP/Editor/Editorial Director**  
Jonathan Titus

**Managing Editor**  
Joan Morrow Lynch

**Assistant Managing Editor**  
Christine McElvenny

**Special Projects**  
Gary Legg

**Home Office Editorial Staff**  
275 Washington St, Newton, MA 02158  
(617) 964-3030

Tom Ormond, *Senior Editor*  
Charles Small, *Senior Editor*  
Jay Fraser, *Associate Editor*  
John A Gallant, *Associate Editor*  
Michael C Markowitz, *Associate Editor*  
Dave Pryce, *Associate Editor*  
Carl Quesnel, *Associate Editor*  
Susan Rose, *Associate Editor*  
Julie Anne Schofield, *Associate Editor*  
Dan Strassberg, *Associate Editor*  
Chris Terry, *Associate Editor*  
Helen McElwee, *Senior Copy Editor*  
James P Leonard, *Copy Editor*  
Gabiella A Fodor, *Production Editor*  
Brian J Tobey, *Production Editor*

**Editorial Field Offices**

Steven H Leibson, *Senior Regional Editor*  
Boulder, CO: (303) 494-2233

Doug Conner, *Regional Editor*  
Atascadero, CA: (805) 461-9669

J D Mosley, *Regional Editor*  
Arlington, TX: (817) 465-4961

Richard A Quinnell, *Regional Editor*  
Aptos, CA: (408) 685-8028

Anne Watson Swager, *Regional Editor*  
Wynnewood, PA: (215) 645-0544

Maury Wright, *Regional Editor*  
San Diego, CA: (619) 748-6785

Brian Kerridge, *European Editor*  
(508) 28435  
22 Mill Rd, Loddon  
Norwich, NR14 6DR, UK

**Contributing Editors**  
Robert Pease, Don Powers,  
David Shear, Bill Travis

**Editorial Coordinator**  
Kathy Leonard

**Editorial Services**  
Helen Benedict

**Art Staff**  
Ken Racicot, *Senior Art Director*  
Chinsoo Chung, *Associate Art Director*  
Cathy Madigan, *Staff Artist*

**Production/Manufacturing Staff**  
Andrew A Jantz, *Production Supervisor*  
Sandy Wucinich, *Production Manager*  
Melissa Carman, *Production Assistant*  
Diane Malone, *Composition*

**Director of Art Department**  
Robert L Fernandez  
Norman Graf, *Associate*

**VP/Production/Manufacturing**  
Wayne Hulitzky

**Director of Production/Manufacturing**  
John R Sanders

**Business Director**  
Deborah Virtue

**Marketing Communications**  
Anne Foley, *Promotion Manager*  
Pam Winch, *Promotion Assistant*

## TECHNOLOGY UPDATES

**Sensitive scope measurements: Scopes pluck waveforms from the signal swamps** 45

Scopes do far more than display a signal level vs time. Now they can dig through noise and sift out interference to make sensitive measurements accurately.—*Charles H Small, Senior Editor*



**Fiber-optic presence sensors: Devices survive harsh environments** 59

Because fiber-optic sensors are mainly passive devices, they are more reliable than traditional mechanical or electronic sensing devices—especially in the hostile world of industrial electronics.—*Tom Ormond, Senior Editor*

**Synthesis tools speed PLD design efforts** 73

PLD design tools have moved beyond the compiler approach to offer design synthesis. You provide a high-level design description, and the tool does the rest.—*Richard A Quinnell, Regional Editor*

## PRODUCT UPDATES

**RISC workstation family** 85

**Low-cost ac instruments** 89

## NEW PRODUCTS

Components & Power Supplies . . . . .	164
CAE & Software Development Tools . . . . .	168
Integrated Circuits . . . . .	172
Test & Measurement Instruments . . . . .	176
Computers & Peripherals . . . . .	182

## DEPARTMENTS

News Breaks . . . . .	17
Signals & Noise . . . . .	26
Ask EDN . . . . .	33
Editorial . . . . .	41
Design Ideas . . . . .	157
Business/Corporate Staff . . . . .	196
Professional Issues . . . . .	198
Career Opportunities . . . . .	214
EDN's International Advertisers Index . . . . .	221

Cahners Publishing Company, A Division of Reed Publishing USA  Specialized Business Magazines for Building & Construction  Research  Technology  Electronics  Computing  Printing  Publishing  Health Care  Foodservice  Packaging  Environmental Engineering  Manufacturing  Entertainment  Home Furnishings  and Interior Design. Specialized Consumer Magazines for Child Care  Boating  and Wedding Planning.



# Because Speed We'll Stop



**MACH**

Fastest High Density  
CMOS PLDs  
At 15ns



**PALCE16V8H-10**

Fast Universal  
CMOS PLD Family  
At 10ns



**PAL16L8-5**

Fast Bipolar  
PLD Family  
At 5ns



# Is Everything, At Nothing.

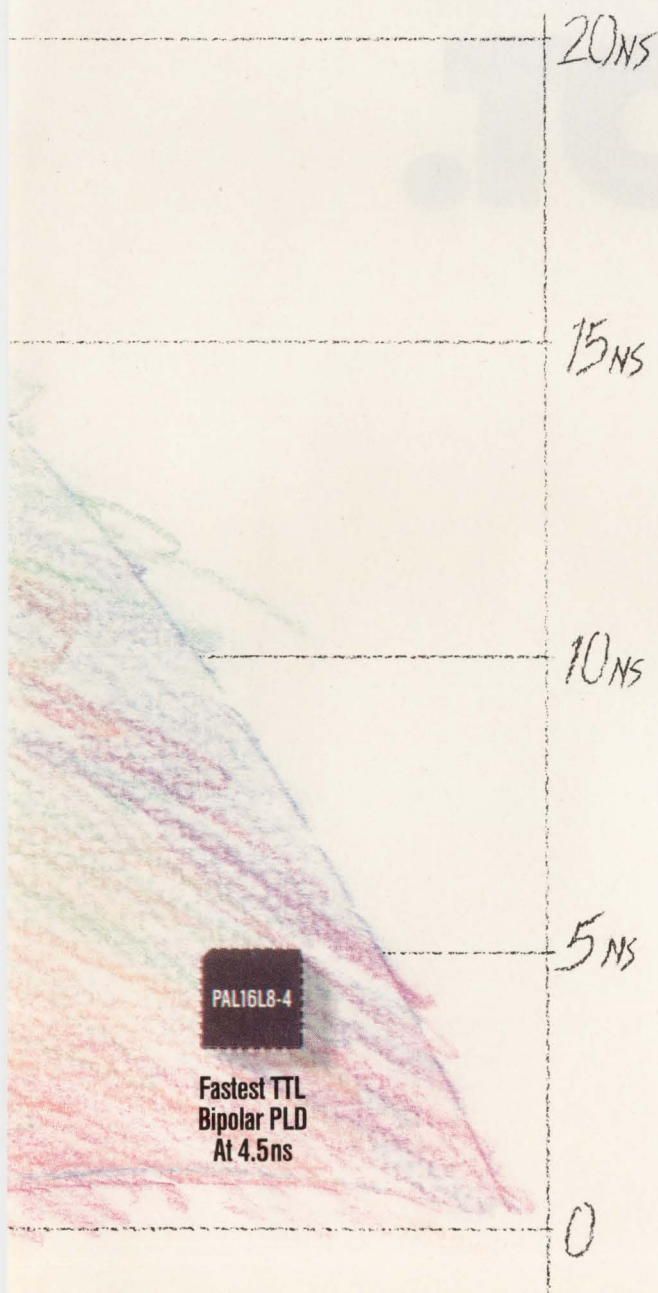

## Whatever kind of PLD you need, the fastest comes from AMD.

We'd love it if all our work amounted to "zero." As in zero delay. And we're not far off.

Not surprising—because AMD invented the PAL® device. That's why we know programmables better. And offer you the most choices of the best devices.

Say you want speed, but can't sacrifice density. Don't. Use our new MACH™ products (Macro Array CMOS High-density) that give you up to 3600 gates and 15ns performance. They're two to three times faster than the competition and cost 40% less.

For more speed, along with low power consumption, try our new 10- and 15-nanosecond CMOS PLDs. Use our 16V8-10s and 20V8-10s anywhere you'd use a GAL® device. Or choose the ever-popular AMD-invented 22V10, at 15ns.

Faster still are our seventh generation bipolar PAL devices. Complete families of 16L8-5s, 20L8-5s, and the 22V10-10s. And for real speed freaks, we're now shipping a 4.5ns bipolar PAL device—the world's fastest TTL programmable logic.

Along with all this speed, we're providing equally fast delivery. In quantity. In fact, we deliver more programmable logic devices than all our competitors combined.

For details, call AMD now at **1-800-222-9323**. And let nothing stand between you and your need for speed.



## Advanced Micro Devices

901 Thompson Place, P.O. Box 3453, Sunnyvale, CA 94088 © 1991 Advanced Micro Devices, Inc.  
MACH is a trademark and PAL is a registered trademark of Advanced Micro Devices.  
GAL is a registered trademark of Lattice Semiconductor.



# LITTLE FOOT.



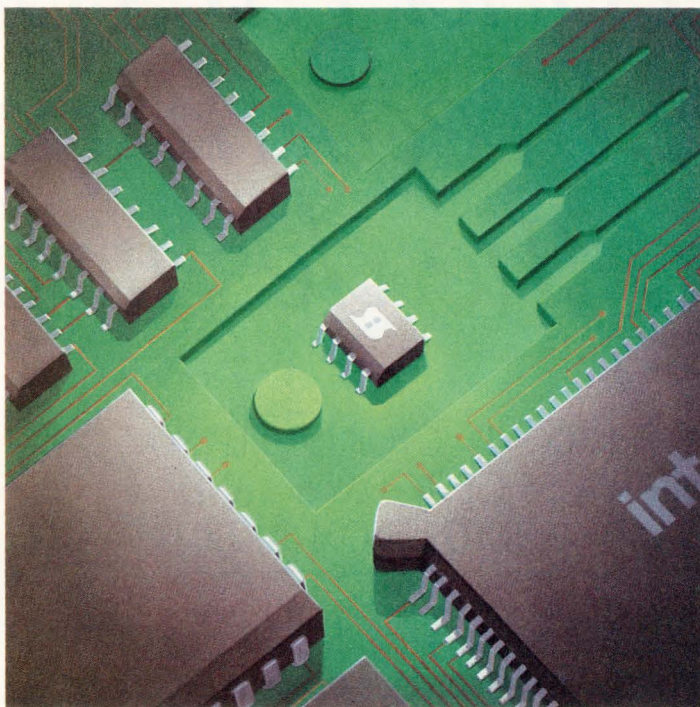

A giant step in a little footprint. At Siliconix, we're doing more than just shrinking devices to increase utilization of limited board space. Now we're employing digital packaging technology to carry our power products. Making assembly easier than ever. And in some cases creating entirely new application possibilities.

Our latest offerings, the "LITTLE FOOT" 8-pin additions to our Si9000 SOIC family, have the highest power density and the lowest package height available. To achieve this, we design two MOSFETs into less space than a single transistor 4-pin DIP, TO-220, or DPAK. Not only saving valuable board space but also improving reliability by reducing part count.

These devices generate less heat to make your design more efficient. The secret? Our SiMOS 2.5 (2.5 million cells/sq.in.) technology combined with a copper leadframe that conducts heat directly from the backside of the die to optimize thermal performance. The result—a smaller, cooler running device with the industry's lowest  $R_{DS(ON)}$ .

The Si9000 family consists of 22 devices with more on the way. Our latest additions are the Si9952DY, an n- and p-channel device with high current handling capability and ideally suited for motor control applications. The Si9953DY, a dual p-channel device that is perfect for load switching. And the dual n-channel Si9955DY that's designed for higher voltage applications.

And that's not all! Our standard SOIC packaging allows you to use automated assembly techniques to ensure device compatibility. And this combined with lower part count results in reduced assembly costs. And speaking of lower costs—single MOSFET versions, the Si94XX series, are coming soon.

Step up to more compact and powerful designs! Call our toll-free hot line now. **1-800-554-5565, Ext. 957**. Ask for our "LITTLE FOOT" Design Kit. And remember, at Siliconix we're committed to achieving a seamless interface between the power and digital worlds.

## Siliconix

2201 Laurelwood Road, Santa Clara, CA 95056



# "The world runs on infor silicon breakthroughs to right to the desktop."

HOW NATIONAL SEMICONDUCTOR IS HELPING YOU MEET THE CHALLENGES OF TODAY'S — AND TOMORROW'S — DATACOM AND TELECOM SYSTEMS.

*John Jorgensen*, National's Director, Advanced Communications Business Group, talks about applying advanced VLSI technology to next-generation communications systems.

## Setting the stage for connectivity.

"National has a definitive strategy for providing voice- and data-communications solutions in silicon.

"We have solutions for Ethernet, FDDI, and integrated-digital networks. And we're working on next-generation solutions for ultra-high-speed network applications.

"The key to building devices this sophisticated is our experience with advanced analog+ digital

integration. We have all the enabling technologies. BiCMOS, CMOS, and ECL processes. Powerful design tools. Experienced analog + digital designers.

"It isn't easy. But we're doing it."

## Linking LANs with FDDI.

"Our FDDI chipset provides the backbone that links Ethernet LANs at the workgroup level with integrated-digital networks, such as ISDN and SONET— and it provides the high-speed datapipe that links workstations directly.

"We're the first manufacturer to introduce a fully-integrated FDDI solution. It offers more network management features and consumes less power than any other solution.

"Our latest device, called the BSI, provides the system interface between our core FDDI chips and the host-system bus, such as VME,

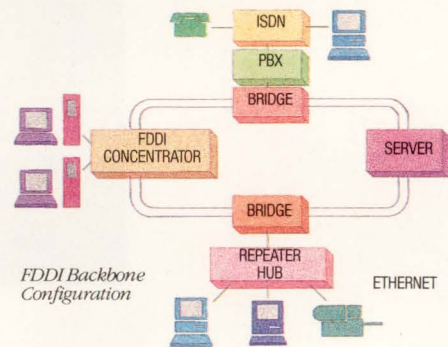

AT, Microchannel, or EISA. It gives you the maximum available system bandwidth, with burst-mode transfers of 800Mbits/second through a 32-bit-wide data interface — without the need for an external processor.

"So now you can develop products for highly-integrated FDDI networks, such as bridges, routers, and concentrators, or you can develop adapter cards for high-performance workstations and PCs — all from one supplier. National!"

## Linking the workgroup with Ethernet.

"Our SONIC — Systems Oriented Network Interface Controller — integrates, for the first time, a digital controller with a 10Mbit/second analog encoder/decoder.





*mation, and we're making  
bring that information*

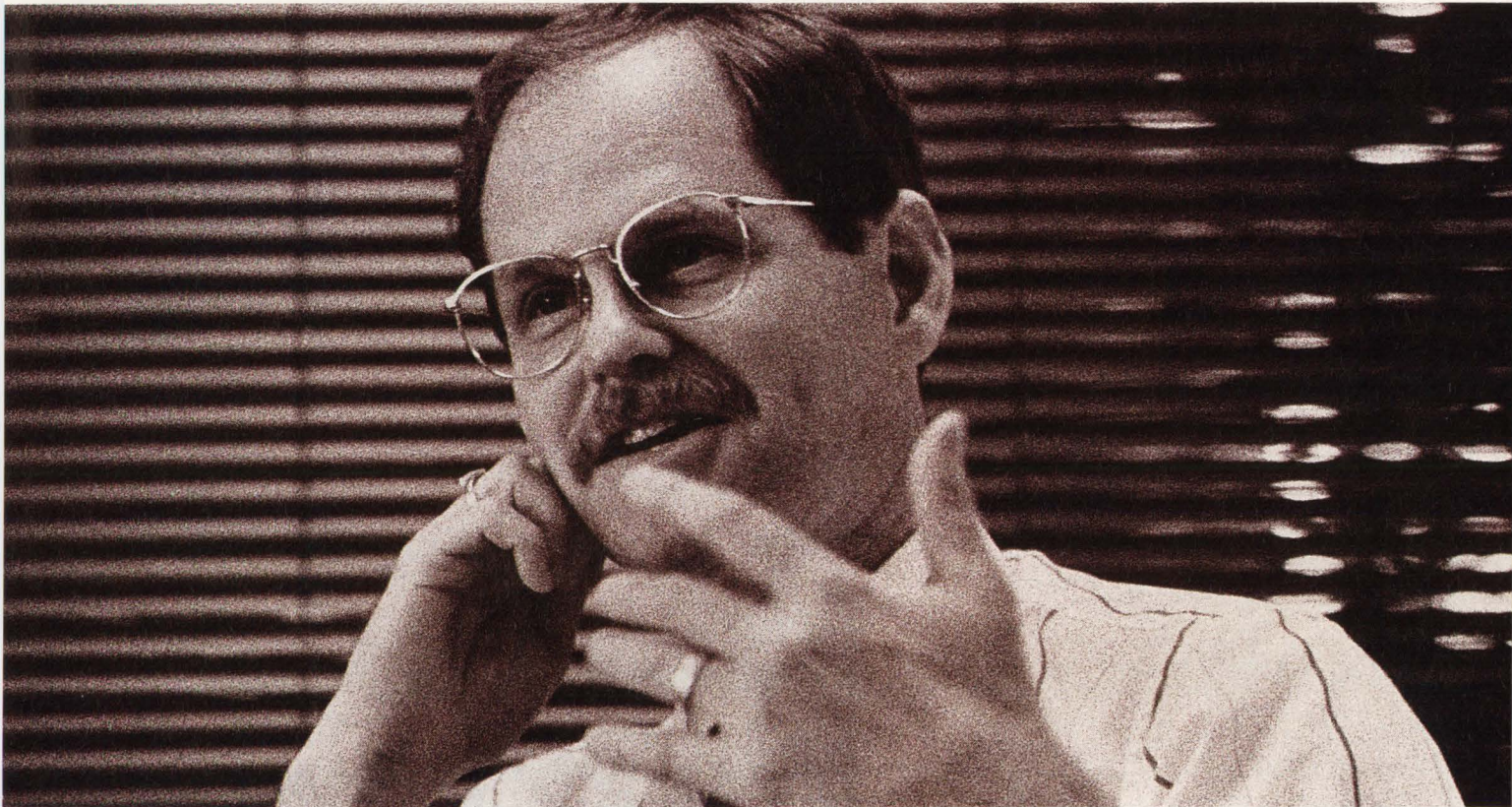

"It supports all IEEE 802.3 functionality in a single chip that goes right on the motherboard in 16- and 32-bit systems, providing full network management functions in hardware.

"And with a transfer rate of 50 Mbytes/second, it's 20 times faster than most other solutions, and cuts bus occupancy by up to 80%.

"The workgroup is linking itself with Ethernet. And we're making it happen faster, smaller, and more cost effectively. That's the standard, and we're setting it."

### Linking voice and data with ISDN.

"Our U interface breaks the ISDN logjam. It allows the simultaneous transmission of voice and high-speed data over the existing twisted-pair telephone network, providing the missing link between the subscriber and the central office.

"It may be the most technically complex mixed analog+ digital device ever designed. The receiving front-end is analog, but the back-end signal processing is all VLSI digital. And this had never been done before. Until we did it."

### Putting it all to work for you.

"The communications revolution is accelerating. As a datacom or telecom systems designer, I'd feel the need for advanced solutions to tomorrow's problems *today*. That's why I'd call National. Because we have those solutions. Today."

1-800-NAT-SEMI, Ext. 115



BSI, BMAC, CDD, CRD, PLAYER and SONIC are trademarks of National Semiconductor Corporation.

VME is a trademark of Motorola, Inc. AT and Microchannel are trademarks of International Business Machines, Inc.

© 1991 National Semiconductor Corporation



# PICTURE A SMALLER, PICTURE IT WITH HIGHER

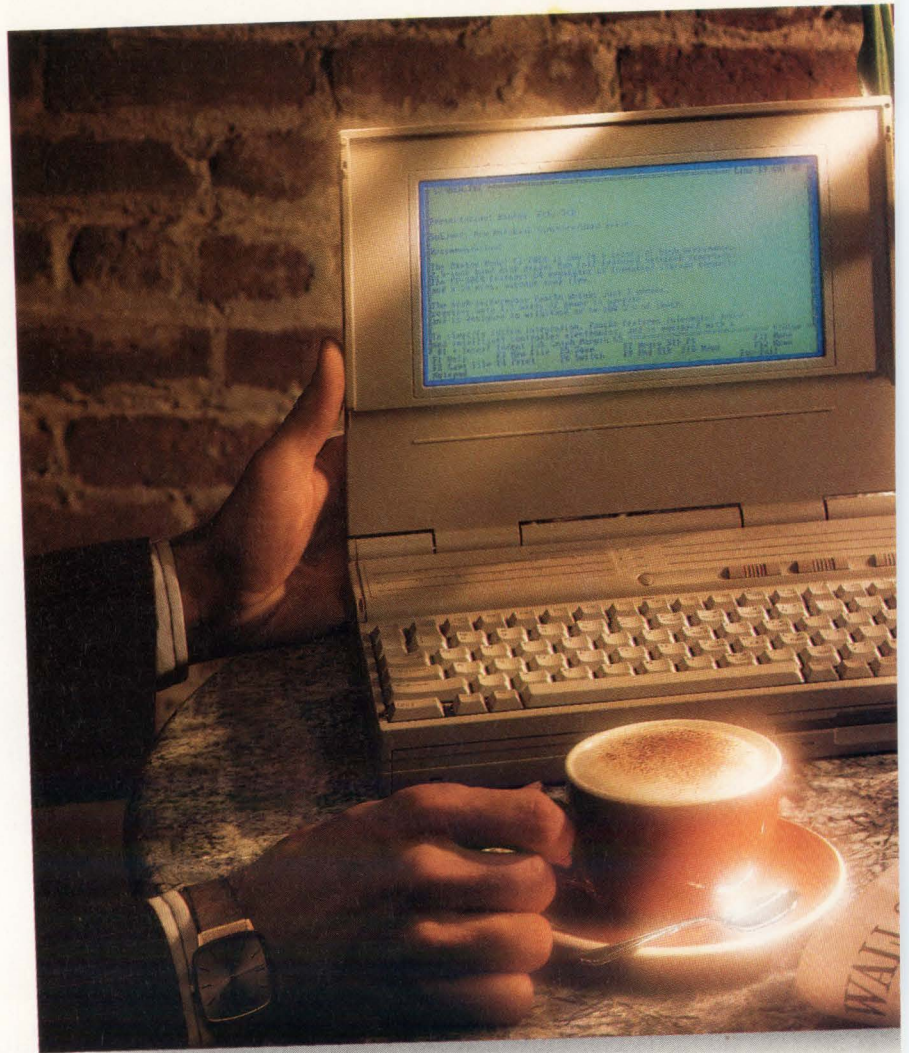

## NOW, PICTURE IT IN YOUR

You've just pictured the Pancho Series from Conner. A new wave of 2.5-inch hard disk drives designed specifically for today's smaller, high performance 386- and 386SX-based notebook computers.

Advanced systems that need to run storage-intensive spread sheets, data base and graphics-oriented programs without sacrificing light weight or battery life.

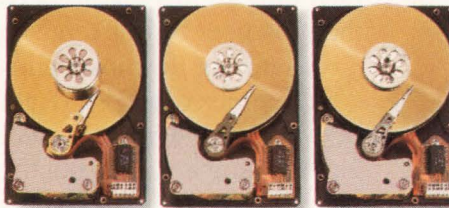

The Pancho Series: 32MB, 42MB and 64MB of formatted storage.

Which is why our new Pancho Series is perfect. Delivering up to 64 Mbytes of capacity, the highest available in a standard 2.5-inch form factor. Yet it draws only 1.3 watts of power.

What's more, it's faster than ever, with an access time of 19 msec.

In addition, it weighs a mere 7 ounces. And can withstand up to 100 Gs of shock. A rugged feature no mobile



# FASTER DISK DRIVE. CAPACITY THAN BEFORE.



## NOTEBOOK COMPUTER.

system should be without.

Most importantly, it's available now. Because at Conner we continually create high performance drives that are a generation ahead — for all major segments of the marketplace. From high-end workstations and file servers to desktop, laptop and notebook PCs.

It's all a part of our innovative sell-design-build business philosophy. Even before we design or build a product, our engineers work closely with major systems manufac-

urers. To identify their specific needs sooner. Then fill them faster. As a result, we consistently design the exact disk drives our customers need.

So call Conner today for a new generation of 2.5-inch disk drives that are picture-perfect for your notebook.

**CONNER**  
*Delivering A Generation Ahead*

London: (44) 249-444-049 • Munich: (49) 89-129-8061 • Paris: (33) 1-47-47-4108 • Aosta: (39) 125-800260 • U.S.— Boston: (508) 660-1088 • Dallas: (214) 680-2913 • Irvine: (714) 727-2462 • Minneapolis: (612) 449-5186 • San Jose: (408) 456-4500.



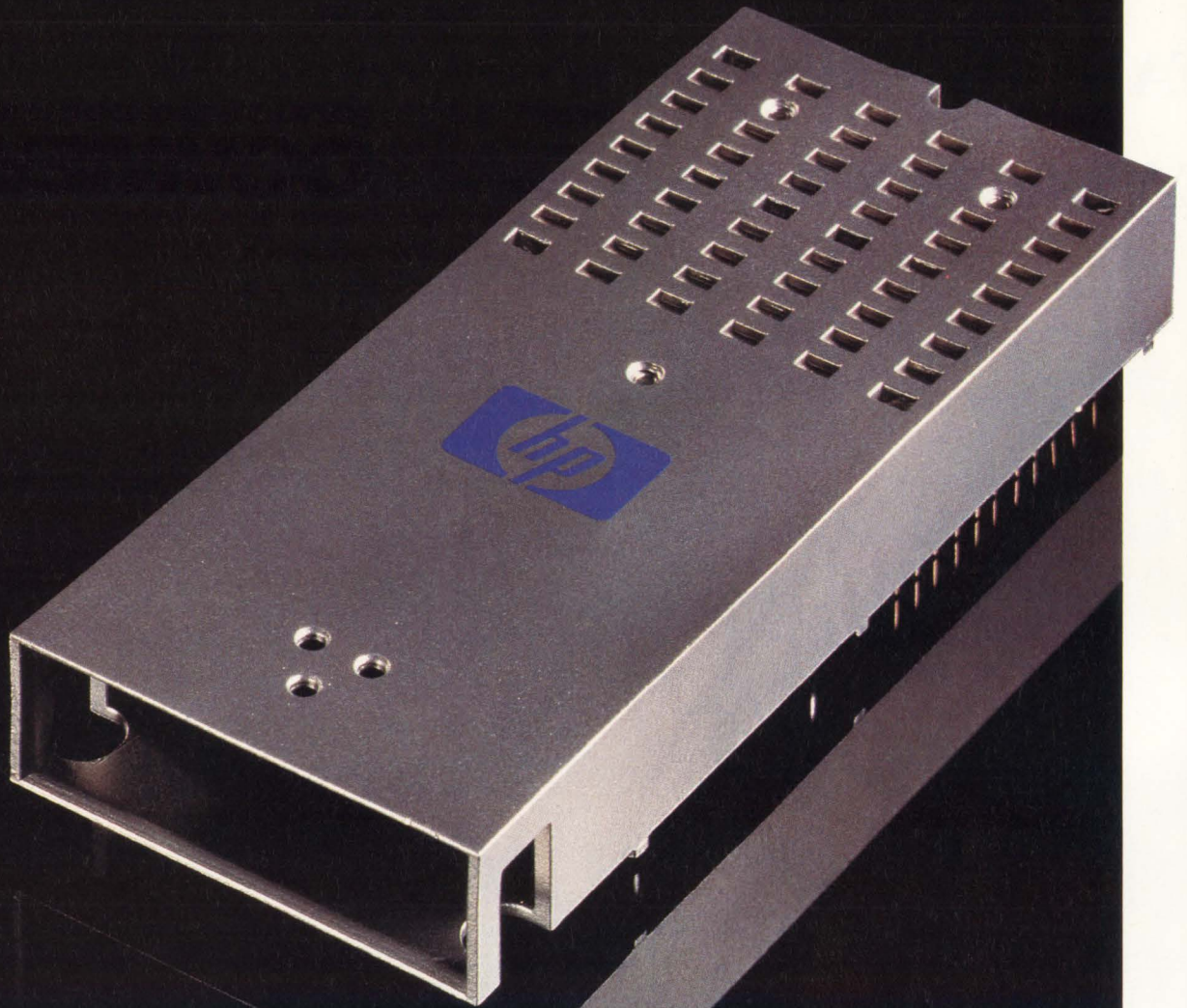

## Finally, FDDI worthy of the name.

It's one thing to set the standard for an entire industry, as HP helped to do with FDDI. But it's quite another to follow it up with products that set the standard for performance and quality. Of course, that's just the HP way.

Case in point, our new integrated FDDI transceiver with integral MIC receptacle makes the most of its HP heritage. Engineered to meet and beat FDDI standards, this single-piece solution provides consistent performance over a wide range of operating temperatures and voltages. The bottom line is a 14.5dB power budget that exceeds the 11dB

FDDI PMD standard, resulting in a comfortable 3.5dB design margin.

Attributes that stem directly from HP's role as a vertically integrated supplier. Which means we have direct control over all the active elements of our FDDI designs, ensuring you a consistently high quality product—and a constant high volume supply.

What's more, our new FDDI transceiver is just one part of a growing family of 1300nm products. Like our individual transmitter/receiver pair—for FDDI and general-purpose applications—that offer data

speeds up to 200MBd. With more new and innovative products on the way.

So, if you're in the process of building a name in fiber optic networks, remember this—there's only one supplier of FDDI products worthy of the HP name. For more information, call HP today at **1-800-752-0900, ext. 1960**. We'll make it worthy of your time.

There is a better way.



**HEWLETT  
PACKARD**



# NEWS BREAKS

---

EDITED BY SUSAN ROSE

## **VMEBUS BOARD HAS KEYBOARD, DISPLAY, AND MOUSE**

The GESVIG-4WVME interface card from Gespac Inc provides a user interface for your VMEbus system. The \$1695 board incorporates a display controller that employs the Hitachi ACRTC video-controller chip, a keyboard interface that accepts IBM PC-style keyboards, and a serial interface port for a mouse. The board's video output can display 720 × 540 pixels using 256 colors. The board makes the video signals available on a front-panel DB-9 connector in the pin configuration used by IBM PC systems. Therefore, you can use any common PC CRT monitors. You can also buy a companion software package for the board: The \$250 G-Windows Desktop Manager lets you implement a windowed user interface for Microware's (Albany, NY) OS-9 operating system. Gespac Inc, Mesa, AZ, (602) 962-5559, FAX (602) 962-5750, contact Don Bizios.—Steven H Leibson

## **SCOPES HIT STREET AT PRICES LOWER THAN PREDICTED**

When Hewlett-Packard first announced its 2-channel 54600A and 4-channel 54601A 100-MHz digital scopes with "analog feel," the company expected them to cost \$3000 and \$3500, respectively (EDN, March 1, 1991, pg 76). Now that HP has actually started shipping the scopes, it has changed the prices to \$2395 and \$2895. Moreover, on orders of four units or more, a 10% discount applies. Hewlett-Packard, Colorado Springs, CO, (800) 752-0900.—Dan Strassberg

## **SPICE-MODEL LIBRARIES ADD SIMULATION ABILITIES**

Analog Devices Inc and Burr-Brown Corp are the latest linear-IC companies to offer free disks of Spice models for their amplifiers. The disk from Analog Devices includes 176 models, some of which correspond to different performance grades of each of the company's amplifiers. This list includes all of the op amps from the company's newly acquired Precision Monolithics Div (formerly PMI). The library also includes current- and voltage-noise models for 26 of the devices, letting your Spice simulation predict system noise performance. The company's modeling technique lets the models use as many poles and zeros as needed to simulate each amplifier's frequency response accurately.

The 75 models in Burr-Brown's library include nearly all of the company's op amps, difference amplifiers, and instrumentation amplifiers. Three types of models are available: a standard macromodel, an enhanced macromodel, and a simplified circuit model. The company derived its macromodels using PSpice's (Microsim Corp, Irvine, CA) Parts and Enhanced Parts simulation software. The circuit model is a simplified transistor-level model that produces more accurate simulations but lengthens simulation time. The transistor-level models are available for some high-speed op amps; current-feedback op amps have simplified circuit models only. Analog Devices Inc, Norwood, MA, (617) 329-4700, FAX (617) 326-8703. Burr-Brown Corp, Tucson, AZ, (800) 548-6132, FAX (602) 889-1510.—Anne Watson Swager

## **QUARTZ-CRYSTAL OSCILLATOR MEETS MIL-883C**

The QC6111 from Salford Electrical Industries Ltd is a quartz-crystal oscillator in an industry-standard 40-lead ceramic chip carrier. You can choose frequencies of 375 kHz to 30 MHz and frequency stability depending on the operating temperature



# NEWS BREAKS

---

range. For  $-40$  to  $+85^{\circ}\text{C}$ , the stability selection is either  $\pm 35$  or  $\pm 60$  ppm. For extended temperature operation from  $-55$  to  $+125^{\circ}\text{C}$ , the choice is  $\pm 60$  or  $\pm 100$  ppm. The module operates from a 5V supply, consumes 90 mW of power, and drives two standard TTL gates. The oscillator is designed in accordance with MIL-883C. Prices are £25 to £30 (1000), depending upon specification. Salford Electrical Industries Ltd, Heywood, UK, (706) 67501, FAX (706) 64394.—Brian Kerridge

## **EMULATOR CONNECTS TO SIMULATORS**

Using the RPM Emulation System (starting at \$70,000 for a 10,000-gate, 272-I/O configuration), you can prototype and emulate an ASIC in a system before you have working silicon. The Rapid Vector Evaluator (starting at \$35,000) lets you drive the emulator from your simulator. The evaluator includes a cascadable 416-bit-wide port to Sun workstations and driver software that enables you to transfer test vectors and capture responses from the emulator. Simulation can then proceed as fast as your simulator can process vectors. You can also use the evaluator as a functional tester and for collecting vectors from operating hardware for driving your simulations. Quickturn Systems Inc, Mountain View, CA, (415) 967-3300, FAX (415) 967-3199.—Michael C Markowitz

## **GRAPHICS CHIPS ENHANCE DISPLAYS**

Three graphics chips from Chips and Technologies enhance VGA, flat-panel, and 8514/A display systems.

The 82C453 ultra VGA controller has  $1024 \times 768$ -pixel resolution with 256 simultaneous colors. It interfaces to video RAMs for image storage, thus speeding the image transfer rate. The controller also uses a single-cycle read-modify-write operation to enhance windowing operations. It comes in a 160-pin plastic flat pack and costs \$30 (1000). The 82C457 flat-panel controller supports a variety of color-panel technologies, including gas-plasma panels and supertwist-pneumatic, active-matrix thin-film transistor, and metal-insulator-metal color LCDs. It will also simultaneously drive a CRT with the flat panel. The controller uses techniques such as dithering to increase the number of colors beyond those provided by the panel alone, producing several thousand colors on a panel normally limited to a palette of 512. The \$86.90 (1000) device comes with a flat-panel color palette/DAC and a clock synthesizer.

The 82C480 has a resolution of  $1280 \times 1024$  pixels with 256 simultaneous colors. It conforms to the 8514/A graphics standard and supports as much as 4M bytes of video RAM. The company provides software-driver support for Windows 3.0 and AutoCAD 11.0, and BIOS and complete register specifications for applications software developers. The part costs \$75 (1000). Chips and Technologies, San Jose, CA, (408) 434-0600, FAX (408) 434-0147.—Richard A Quinnell

## **PERFORM REAL-TIME DATA ACQUISITION IN WINDOWS 3.0**

Driverlinx from Scientific Software Tools gives you more than 70 command services for creating foreground and background I/O and measurement tasks. This tool provides language- and hardware-independent dynamic link libraries that port your data-acquisition applications to Windows 3.0. Applications communicate with the software by passing a "service request" that contains the specifications for a data-acquisition task. The software acknowledges the service request and notifies the application upon completion of each stage of the task. The package lets you operate





## The Standard for Circuit Simulation Switch-Mode Power Supply Design

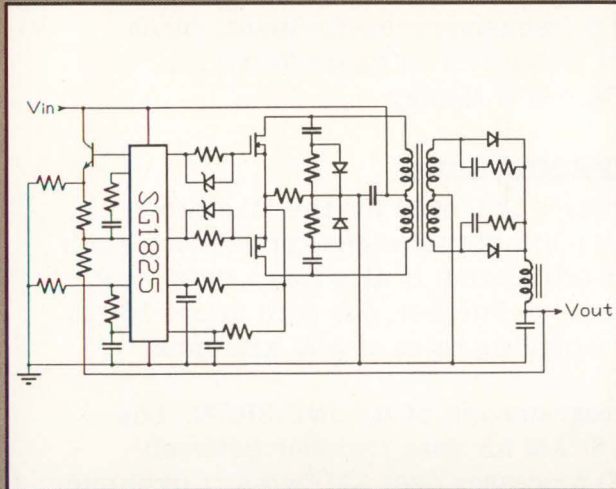

Current mode power supply schematic.

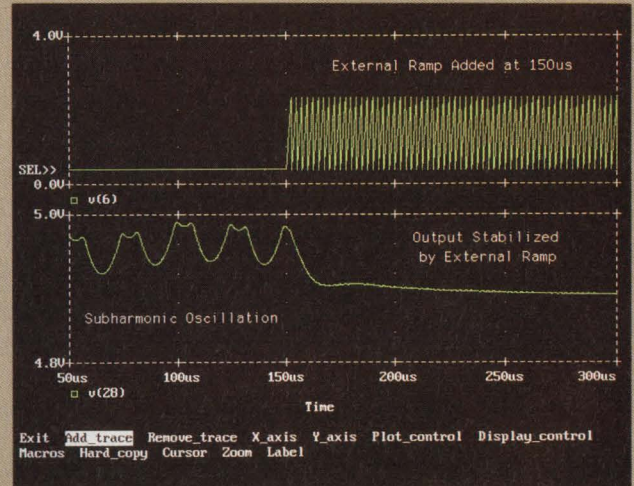

Power supply simulated using mixed analog/digital simulation. Plot shows subharmonic oscillation being suppressed by external ramp.

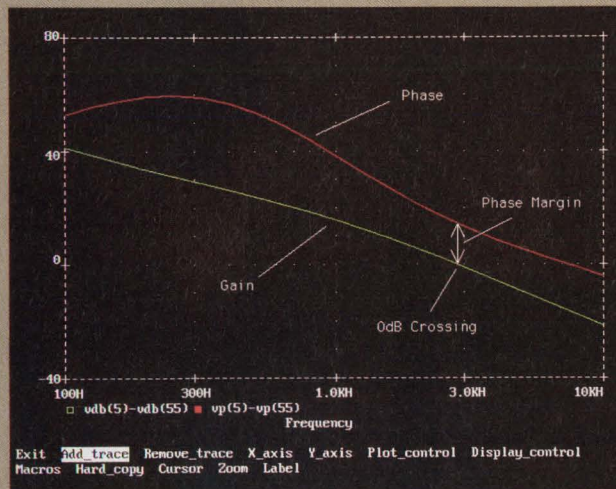

Simulation using the Vorperian switch model to examine the stability of a power supply.

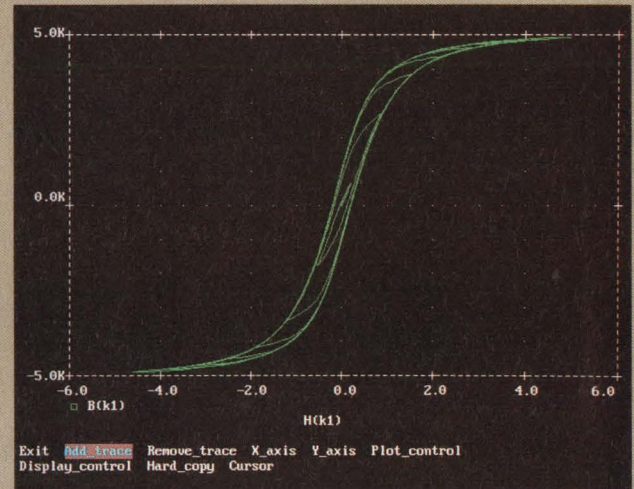

Hysteresis curve of transformer.

A cycle by cycle simulation of switch-mode power supplies is recognized as a difficult simulation task for SPICE-based simulators, which must cope with timings that can span 4 orders of magnitude. This problem invariably results in very long simulation times, but is improved considerably by MicroSim's approach of building the controller macromodel chips so that a significant section is simulated in the digital domain. PSpice's behavioral modeling and mixed analog/digital simulation capability makes this possible.

PSpice is available on the IBM-PC (running DOS or OS/2); Macintosh II; Sun 3, Sun 4, and SPARCstation; DECstation 2100, 3100, and 5000; and the VAX/VMS families. In addition to the PWM macromodels, the PSpice library contains over 3,500 analog and 1,500 digital parts which can be used in a variety of applications. Our technical staff has over 150 years of combined experience in CAD/CAE, and our software is supported by the engineers who wrote it.

For further information about the PSpice family of products, call us at (714) 770-3022, or toll free at (800) 245-3022. Find out for yourself why PSpice has become the standard for circuit simulation.

20 Fairbanks • Irvine, CA 92718 USA • FAX (714) 455-0554



# NEWS BREAKS

---

Keithley/Metrabyte, Advantech, Computer Boards, and Soltec data-acquisition boards within the real, standard, and enhanced modes of Windows 3.0. Adding multitasking and multiuser capabilities, the software can manage as many as six data-acquisition boards and 10 concurrent tasks. Multiple copies of one application or multiple applications can access this program without interfering with ongoing tasks. The \$400 package conducts analog I/O, digital I/O, time and frequency measurement, event counting, pulse output, and period measurement. Scientific Software Tools Inc, Malvern, PA, (215) 889-1354, FAX (215) 889-1334.—J D Mosley

## **DSP CARD FOR MACINTOSH USES DUAL PROCESSORS**

Spectral Innovations' MacDSPII is a dual-processor DSP card for the Macintosh Nubus. The card uses two AT&T DSP32C floating-point digital signal processors, each with 1M byte of static RAM (SRAM), for number crunching. It also has a 68000  $\mu$ P to run Apple's Real-Time Operating System Executive. Further, the card offers 16-bit, dual-channel A/D and D/A converters that have sampling rates of 250 kHz max.

The DSPs run concurrently, each executing programs out of its own SRAM. The two processors share an additional 8M bytes of SRAM for data transfer between processors at a rate of 50M bytes/sec. The 68000 processor uses 2M bytes of dynamic RAM (DRAM), which is also part of the Nubus address space. Each DSP can access the DRAM and data converters via a parallel DMA port. Support for the \$7995 card includes a C language compiler, assembler, and simulator, and a library of signal-processing and graphics subroutines. Spectral Innovations, Santa Clara, CA, (408) 727-1314, FAX (408) 727-1423.—Richard A Quinnell

## **SERIAL DATA-COMMUNICATIONS ICs GAIN SPEED**

Zilog's 20-MHz version of the Z85230 enhanced serial communications controller (ESCC) and 16-MHz version of the Z16C35 integrated serial communications controller (ISCC) are general-purpose, multiprotocol, serial-controller ICs. They are 20 and 50% faster, respectively, than previous versions. The ESCC handles serial data rates to 5M bps, and the ISCC handles 4M bps when its on-chip DMA controllers manage the data transfers. The ESCC and ISCC cost \$17.50 and \$22.50 (1000), respectively. Zilog, Campbell, CA, (408) 370-8000, FAX (408) 370-8056.—Steven H Leibson

## **HIGH-DENSITY PLD HAS WIDE INPUT STRUCTURE**

The PML2552 CMOS PLD from Signetics has the equivalent of 2500 gates and an unusual interconnect structure. You can connect the output lines from any of the device's 96 gates and 20 buried JK flip-flops to the input lines of any other gate and flip-flop, including folding the signal back on itself. To accommodate this plethora of signals, each product-term gate has 258 input lines. You can implement any combinatorial logic function with as few as two gate delays. Gate delays are 12 nsec, and the flip-flop toggle rate is 50 MHz.

The PLD also has both a low-power mode and a test mode. When you activate its low-power mode, the device freezes in its current state and drops power consumption from 525 to 52 mW. When in test mode, the device links its internal registers into a serial test loop, letting you monitor the registers' status using scan test techniques. The PLD comes in either a 68-pin J-leaded, windowed, ceramic quad flat pack for \$60 or a 1-time programmable plastic leaded chip carrier for \$20. Signetics, Sunnyvale, CA, (408) 991-3266, FAX (408) 991-2268, contact Khanh Le.—Richard A Quinnell



# REDUNDANCY REDUNDANCY REDUNDANCY

## Dale's Three Sourcing Locations Protect RNC "S" Level Deliveries. Stock to Six Weeks on Most Values.

RNC redundancy — from Dale®. Now more than ever, it means guaranteed delivery for "S" level orders from three qualified locations. One call lets you lock-in requirements for:

- 10 ohms to 7.5 megohms.
- Special testing at all locations.

Call today. Get instant access to our extensive RNC "S" level capacities, plus reliable, precisely-timed delivery. Discover how our decision to maintain a multi-source supply system for many components — particularly MIL-R-55182 — protects you with redundancy insurance over an increased value range. Contact your Dale Representative or Distributor, or phone our RNC sourcing headquarters.

MIL-R-55182 Range "S" Level	
Style	Value Range
RNC50	10 - 796K $\Omega$
RNC55	10 - 2.0M $\Omega$
RNC60	10 - 2.49M $\Omega$
*RNC65	10 - 4.99M $\Omega$
*RNC70	10 - 7.5M $\Omega$

\* Available in RNR and RNN as described in Table I of MIL-R-55182 for values above 1M $\Omega$  for RNC65 size and above 70K $\Omega$  for RNC70 size.

Norfolk Division, 2300 Riverside Blvd.  
Norfolk, NE 68701-2242 • Phone (402) 371-0080 • FAX (402) 644-4206





# THE WORLD'S LARGEST SELECTION OF **POWER SPLITTERS/ COMBINERS**

**2 KHz to 8 GHz** from **\$10<sup>45</sup>**

With over 300 models, from 2-way to 48-way, 0°, 90° and 180°, a variety of pin and connector packages, 50 and 75 ohm, covering 2KHz to 8000MHz, Mini-Circuits offers the world's largest selection of off-the-shelf power splitter/combiners. So why compromise your systems design when you can select the power splitter/combiner that closely matches your specific package and frequency band requirements at lowest cost and with immediate delivery.

And we will handle your "special" needs, such as wider bandwidth, higher isolation, intermixed connectors, etc. courteously with rapid turnaround time.

Of course, all units come with our one-year guarantee.

For detailed specs and performance data, refer to the *MicroWaves Product Directory*, *EEM* or *Mini-Circuits RF/IF Signal Processing Handbook*, Vol. II. Or contact us for our free 68-page *RF/IF Signal Processing Guide*.

finding new ways ...  
setting higher standards

## Mini-Circuits

A Division of Scientific Components Corporation  
P.O. Box 350166, Brooklyn, New York 11235-0003 (718) 934-4500  
Fax (718) 332-4661 Domestic and International Telexes: 6852844 or 620156  
WE ACCEPT AMERICAN EXPRESS

CIRCLE NO. 137

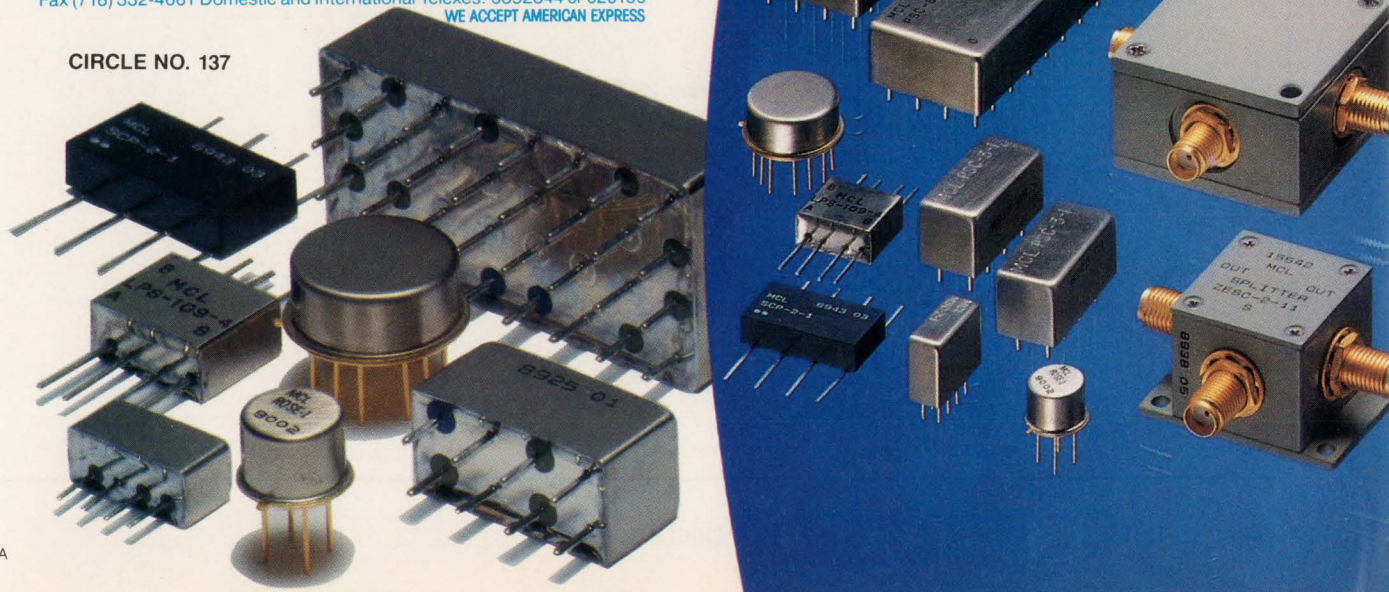



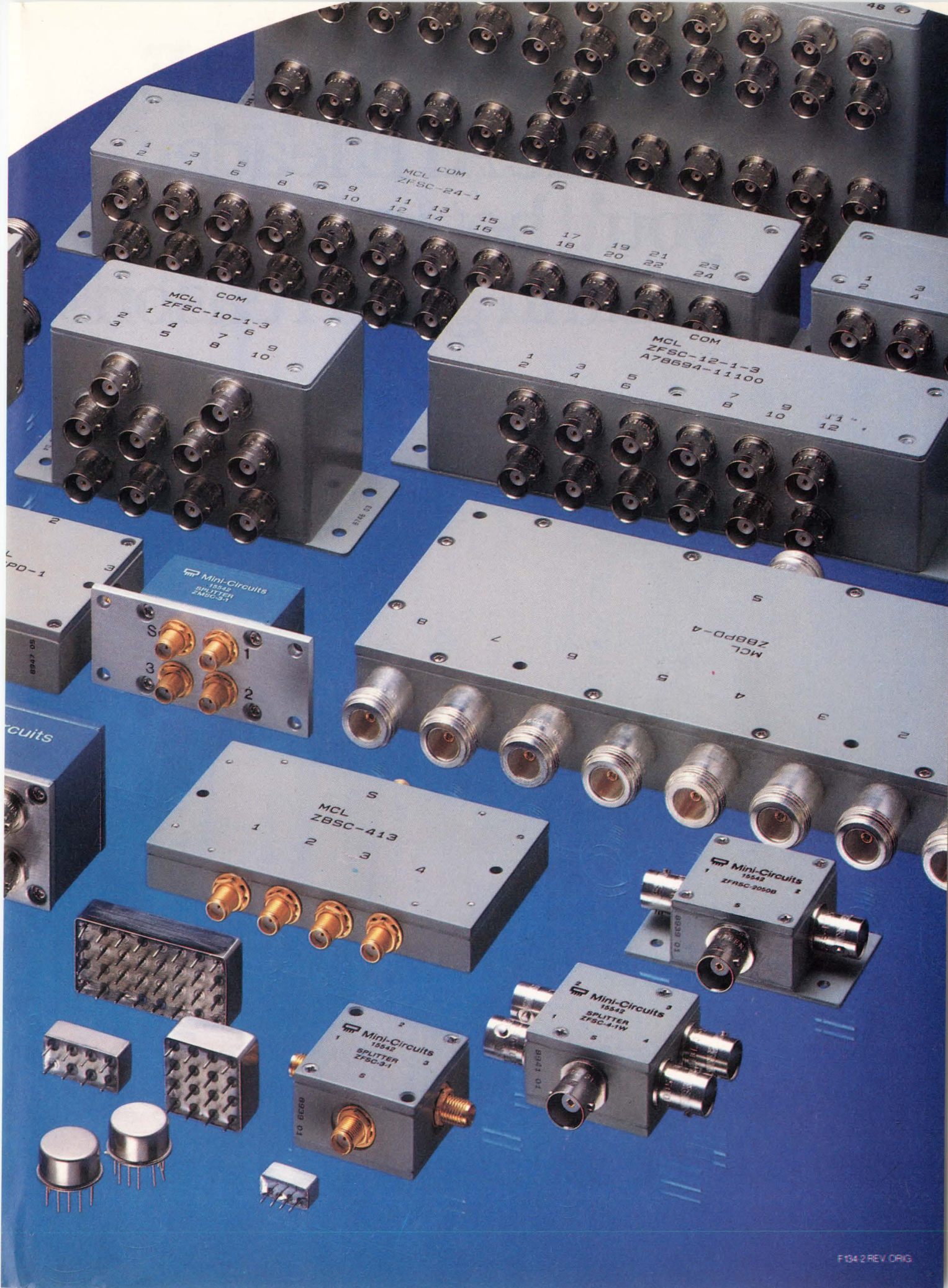



**Before you buy CAE  
from the ATE leader,  
you'd better have  
some damn good reasons.**



# Some damn good reasons.

“On our foundry’s recommendation, we selected AIDA ATPG for automatic vector generation. AIDA ATPG has consistently produced 95%+ fault coverage across a variety of DFT methods – full and partial scan, JTAG and boundary scan. Test pattern generation used to take us 3-6 weeks, but now we can do it in hours or overnight. And since our foundry supports the toolset, we can send our vectors directly into manufacturing.”

*Raju Joshi,*  
*Project Manager*  
**Sun Microsystems, Inc.**

“LASAR’s modeling and timing capabilities are outstanding for both design and test. We’re in a position to know because, in addition to the product design work we do for complex avionic systems, we use LASAR to design and program our own ELATS test systems. The level of accuracy we can achieve with LASAR ensures a high-quality product, whether it’s an avionic subassembly, an automatic tester, or a test program set.”

*Rick Mattice,*  
*Project Manager*  
**Litton Systems Canada Ltd.**

“Using LASAR and Frenchip, our own synthesis tool, we’ve developed a rigorous top-down methodology for large ASIC design. We start by simulating the design at the behavioral level with LASAR. We use our synthesis software to generate the gate-level description. We always use LASAR to verify the operation of the ASIC in the board environment. We depend on its accuracy for both functional verification of our designs and for worst-case timing analysis.”

*Francois Grillot,*  
*Director, R&D and Custom Products*  
**Dassault Electronique**

“Vanguard Schematic Design and PCB Layout give us a fully-featured well-integrated system for a very reasonable cost. The other schematic design system we had was slow and cumbersome, but with Vanguard, it’s easy to create components or make design changes – you just punch a couple of keys and you’re done. And Vanguard macros are one of the best features of the software. When I need to make a bunch of changes, it’s just hit a macro, and let it go.”

*Roger Stoops,*  
*PCB Designer II*  
**Spectra-Physics Laserplane, Inc.**

“As a manufacturer of fault-tolerant computers, Stratus puts a high priority on quality. It’s this simple: LASAR finds board-level timing problems that other tools cannot find. And with Teradyne’s hardware modeler, LASAR lets us see how an ASIC will behave with other complex ICs. That means when we go to silicon, we’re confident that our designs will work in the system. We’ve designed 6 ASICs using LASAR, and we’ve achieved good first-pass silicon each time.”

*Sandy Hirschhorn,*  
*Director, Design Automation and Diagnostics*  
**Stratus Computer**

“The MultiSim Interactive Designer is excellent – it’s the first CAE tool that works well with a top down design approach. It’s set up so you can build and simulate block by block, and its speed makes it easy to find your mistakes, make changes, and try again without a lot of time spent recompiling.”

*Steve DeLong,*  
*Technical Team Leader*  
*Jim Walsh,*  
*Technical Staff Member*  
**Rockwell International Corporation**



Design engineers are using Teradyne’s CAE tools for lots of good reasons. Interactive design analysis. Accurate design verification. Tight integration between design and test. With Teradyne CAE, you get greater speed, accuracy, and reliability than with other CAE systems. That adds up to higher product quality and faster time-to-market. And in today’s competitive environment, those are the best damn reasons of all.

To learn more, call Daryl Layzer today at 1-800-225-2699, ext. 3808, or FAX (408) 748-7761.

© 1991, Teradyne, Inc. AIDA, MultiSim, and Vanguard are trademarks of Teradyne, Inc. Frenchip is a product of Dassault Electronique.

## TERADYNE



## Sprague-Goodman

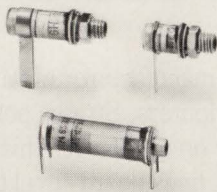

### Glass and Quartz Pistoncaps®

- Designed to meet MIL-C-14409D
  - QPL models
  - Extremely stable over temperature, frequency, voltage, etc.
  - Cap ranges: 0.5-3.0 pF to 1.0-120 pF
  - Zero backlash multiturn adjust mechanism
  - Operating temp: -55° to +125°C (models to + 200°C)
  - Q to 1500 at 20 MHz
  - Wide variety of configurations for PC and panel mounting
  - Voltage ratings from 500 to 5000 V
- Phone, fax or write today for Engineering Bulletin SG-205A.



134 Fulton Ave., Garden City Park, NY 11040  
Phone: 516-746-1385 • Fax: 516-746-1396

CIRCLE NO. 6

## Sprague-Goodman



### Sapphire Pistoncaps®

- Q to 4000 at 250 MHz
- 6 mounting styles suitable for all RF structures
- Designed to meet MIL-C-14409D
- Operating temp: -55° to +125°C
- Cap ranges: 0.3-1.2 pF to 0.8-8.0 pF
- Subminiature size
- Multiturn resolution
- Extremely stable over temperature, frequency, voltage, etc.

Phone, fax or write today for Engineering Bulletin SG-207A.



134 Fulton Ave., Garden City Park, NY 11040  
Phone: 516-746-1385 • Fax: 516-746-1396

CIRCLE NO. 7

# SIGNALS & NOISE

## More serious threat to US than Japanese competition

In Jon Titus's editorial (EDN, January 3, 1991, pg 35), he identifies a much more serious threat to US industry than Japanese competition. As long as I can remember, telephone operators (and many secretaries) seemed to be much more interested in getting rid of the caller than helping the caller reach the right person.

Answering machines have compounded the problem. Only the rare corporate species of "self-starters" muster the energy to even look for messages, never mind answer them. (After all, a body at rest wants to stay there.)

Once I had to clarify a spec within a half hour—the typical turnaround time for the copy desk—and spent the time listening to messages and menus from the company's voice-mail system. Finally, on my third try for Jim Neverin, assistant marketing manager, I did leave a message: "Jim, since no real people seem to work for your company, I'm placing my order with XYZ Corp."

The next time I needed Jim, his secretary answered and put me right through. Of course, that was sheer coincidence.

*Max Schindler*  
Boonton, NJ

## Accommodating the little guy

Scott B Rosenthal of Microsol Corp recently wrote concerning his problems in getting small quantities of parts. At our consulting and contract-engineering company, we face similar problems. We don't manufacture anything, but we often need small numbers of parts to build prototypes. I concur that in recent years it has become increasingly difficult to obtain small quantities.

I sometimes request samples. But I don't like doing this, because it leaves us entirely at the mercy of manufacturer's reps who don't al-

ways appreciate the time constraints we are under.

To the Hamilton Avnets and others who don't really want to be distributors except to the big guys, I have this to say: Not all little companies stay little, and some remember who served them and who didn't.

*Stephen D Anderson, President*  
AnSCO  
Minneapolis, MN

## Correction for $\mu$ P Directory

EDN's 17th Annual Microprocessor Directory (November 22, 1990, pg 115) lists the SGS Thomson ST9  $\mu$ P chip as a derivative of the Zilog Z8. SGS Thomson reminds us that, although the company is licensed by Zilog to produce the Z8  $\mu$ P, members of the ST9  $\mu$ P family use a separate and distinct computer architecture, as well as an instruction set that's incompatible with the Z8. Thus, the ST9 is not a derivative or an enhancement of the basic Z8  $\mu$ P.

## IT'S EASY TO HAVE YOUR SAY

EDN's Signals & Noise column provides a forum for readers to express their opinions on issues raised in the magazine's articles or on any topic that affects the engineering industry. You can use one of several easy ways to reach us. First, there's always the mail. Send your letters to Signals & Noise Editor, EDN Magazine, 275 Washington St, Newton, MA 02158. Or, send us a message via MCI mail at EDNBOS. Finally, EDN's bulletin-board system is ready for use—and it's free (except for the phone call). You can reach us at (617) 558-4241 and leave a letter in the EDITORS Special Interest Group. You'll need a 2400-bps or less modem and a communications program that is set for eight data bits, no parity, and one stop bit, or 1200/2400, 8N1 in shorthand.

EDN

EDN April 11, 1991



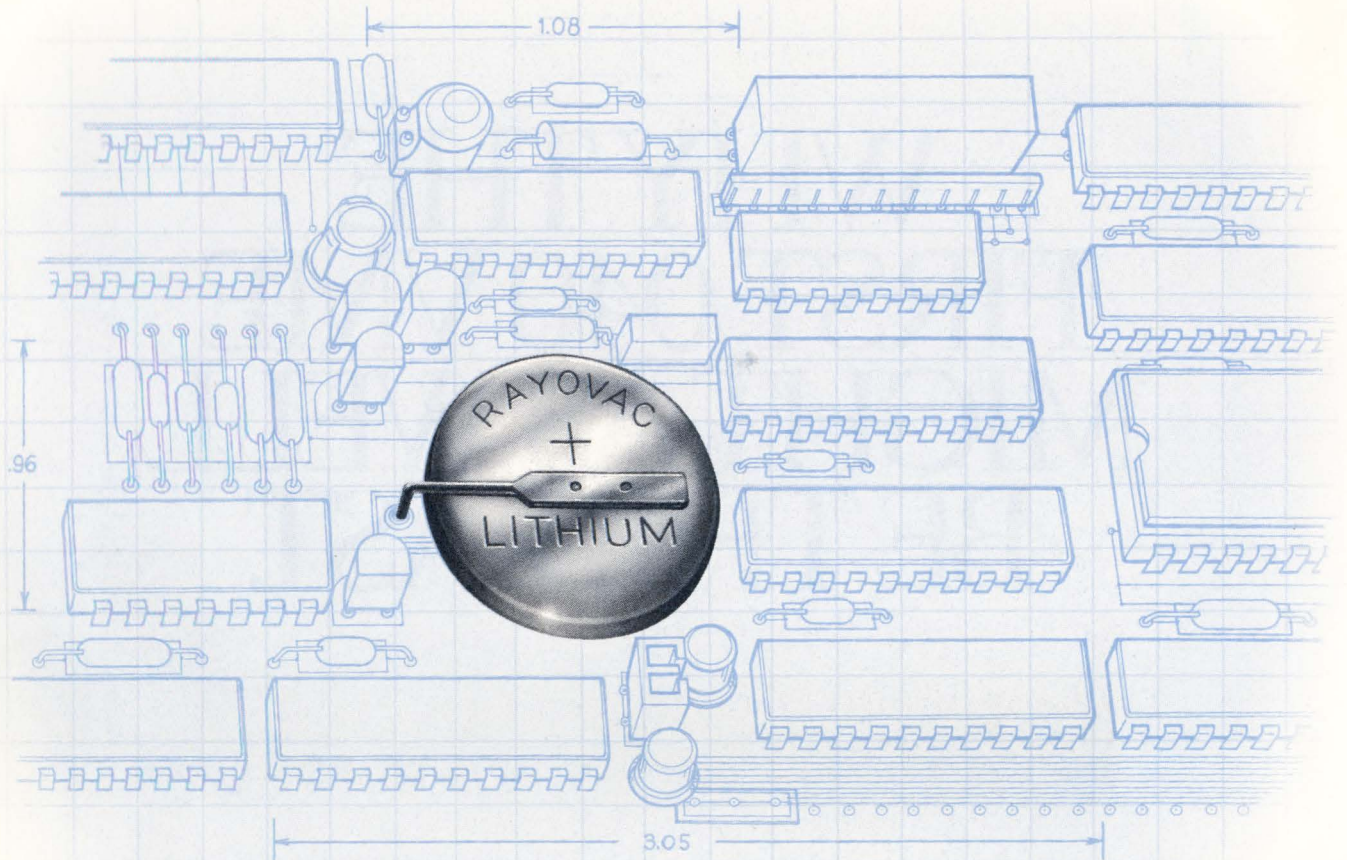

# HOW MORE COMPANIES ARE ADDING LIFE TO THEIR DESIGNS.

Rayovac Lifex™ Coin Cells and Lifex FB™ Batteries have the highest reliability ratings in the industry. That's why major electronics manufacturers worldwide already specify Lifex in their product designs.

Rayovac reliability is especially valuable for critical memory applications, such as encryption codes, cash values, or control parameters.

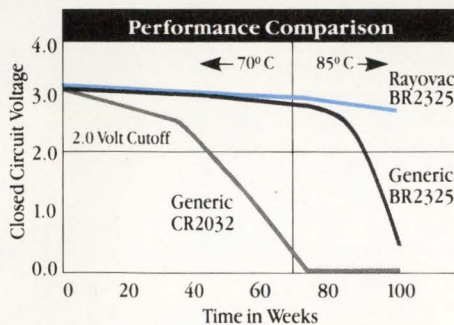

*In high-temperature sustained storage, Lifex continues strong long after others fade away.*

The Lifex FB offers extended temperature tolerance—operating comfortably in

a range of  $-40^{\circ}\text{C}$  to  $+100^{\circ}\text{C}$ . And our products are made in the U.S.A., with on-time delivery available around the world.

So add longer life to your design. Specify a Rayovac Lifex Coin Cell or Lifex FB Battery in your design. Call Rayovac's Technical Sales & Marketing Department for complete information and battery specifications at 608-275-4694.





# WHY THE FIRST 040 VME MIGHT AS WELL BE THE LAST.

*Memory modules available in 4 and 16 MB DRAM or SRAM.*

*DRAM memory module supports burst fill mode for 50 Mbyte/sec memory bandwidth.*

*On board DMA-based architecture provides maximum performance and parallel real-time operation.*

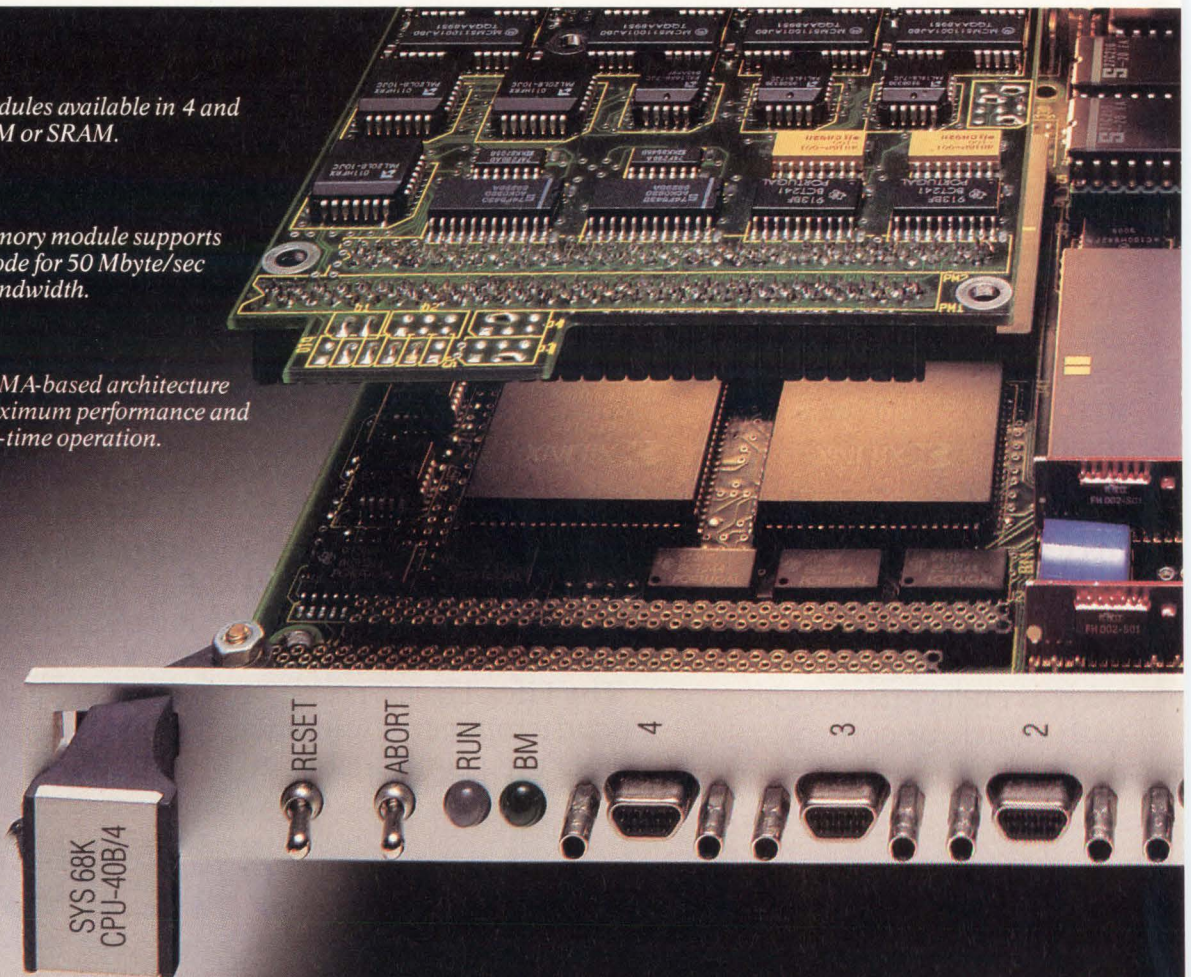





Second, setting else can

sustained at 25 MHz\*. And DMA transfers at a screaming 50 Mbytes per second sustained (3 microseconds on the VMEbus).

So it might just be the last 040 board you'll ever need.

That's because we've fully optimized the on-board architecture. Thanks to our 281-pin gate array, DMA operations can be handled between on-board RAM, the VMEbus and on-board I/O devices. Or through our FLXi interface to other I/O drivers.

All of which means the CPU is free over 75% of the time to run your application.

First, we're delivering 040 VME single board computers today. In quantity. So you can get started while the rest of the world waits for a delivery date from other suppliers.

our new CPU-40 board is performance standards nobody touch. Like 30,000 dhrystones

Developing new applications is also a snap. Choose from the broadest range of third-party software in the business, including VMEPROM™, pSOS+™, VRTX32™, OS-9™, VxWorks™, UNIFLEX™, MTOS™ and UNIX® 5.4.

Of course, we provide comprehensive support with the industry's best-rated documentation\*, complete systems integration support and technical assistance.

**CPU-40 PERFORMANCE CHARACTERISTICS**

Data from	CPU	CPU	CPU	CPU	VMEbus	SCSI*	Floppy Disk*	Ethernet*	Shared RAM*	VMEbus*
Transfer to	Shared RAM	EPROM	Serial I/O Timers	SCSI, Ethernet Controller, Floppy Disk	Shared RAM	Shared RAM	Buffer RAM	Dual-port RAM	VMEbus	VMEbus
Transfer Speed	53.7 MB/sec	16 MB/sec	2 MB/sec	2 MB/sec	5 MB/sec	4 MB/sec	500 KBit/sec	10 MBit/sec	15 MB/sec	15 MB/sec
Local 68040 CPU Operation	100%	100%	100%	100%	70%	80%	100%	100%	75%	100%

\*DMA x FPS

So be the first in your company to turn 040. Call 1-800-BEST-VME, ext. 40, for more information or fax a request to (408) 374-1146 for an immediate response. It'll be to your lasting advantage.



VME at its best.

FORCE Computers, Inc. 3165 Winchester Blvd. Campbell, CA 95008-6557  
 \*Actual dhrystone results may vary depending on compiler used. \*\*Computer Design News, March 12, 1990. All brands or products are trademarks of their respective holders. © 1991 FORCE Computers, Inc.

CIRCLE NO. 134

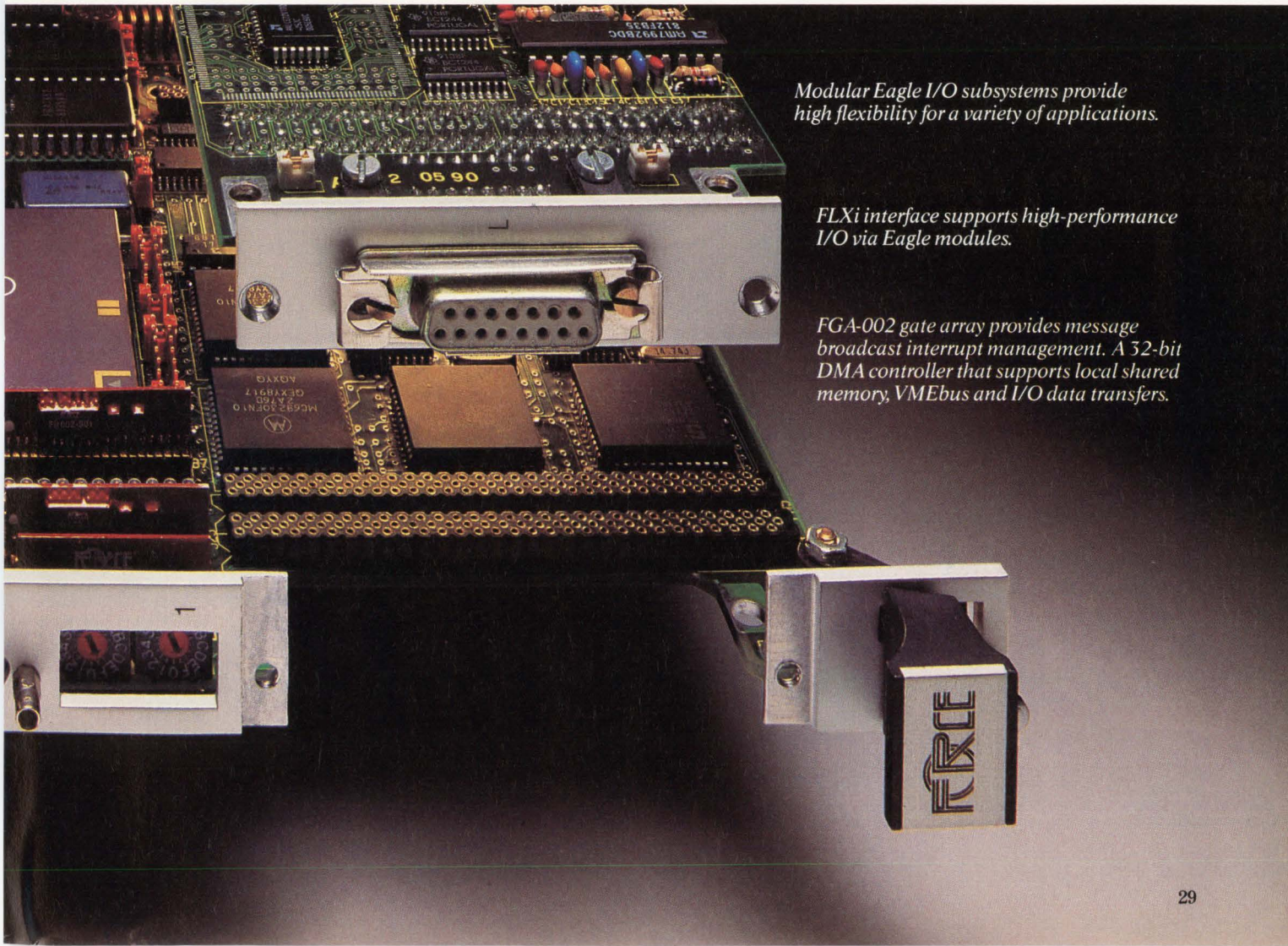

Modular Eagle I/O subsystems provide high flexibility for a variety of applications.

FLXi interface supports high-performance I/O via Eagle modules.

FGA-002 gate array provides message broadcast interrupt management. A 32-bit DMA controller that supports local shared memory, VMEbus and I/O data transfers.



# FILTERS





# dc to 3GHz from \$11.45

## lowpass, highpass, bandpass, narrowband IF

- less than 1dB insertion loss • greater than 40dB stopband rejection
- 5-section, 30dB/octave rolloff • VSWR less than 1.7 (typ) • meets MIL-STD-202 tests
- rugged hermetically-sealed pin models • BNC, Type N; SMA available
- surface-mount • over 100 off-the-shelf models • immediate delivery



### low pass dc to 1200MHz

MODEL NO.	PASSBAND, MHz (loss <1dB)		STOP BAND, MHz (loss >20dB) (loss >40dB)			VSWR		PRICE \$ Qty. (1-9)
	Min.	Nom.	Max.	Max.	Min.	pass-band typ.	stop-band typ.	
PLP-10.7	DC-11	14	19	24	200	1.7	18	11.45
PLP-21.4	DC-22	24.5	32	41	200	1.7	18	11.45
PLP-30	DC-32	35	47	61	200	1.7	18	11.45
PLP-50	DC-48	55	70	90	200	1.7	18	11.45
PLP-70	DC-60	67	90	117	300	1.7	18	11.45
PLP-100	DC-98	108	146	189	400	1.7	18	11.45
PLP-150	DC-140	155	210	300	600	1.7	18	11.45
PLP-200	DC-190	210	290	390	800	1.7	18	11.45
PLP-250	DC-225	250	320	400	1200	1.7	18	11.45
PLP-300	DC-270	297	410	550	1200	1.7	18	11.45
PLP-450	DC-400	440	580	750	1800	1.7	18	11.45
PLP-550	DC-520	570	750	920	2000	1.7	18	11.45
PLP-600	DC-580	640	840	1120	2000	1.7	18	11.45
PLP-750	DC-700	770	1000	1300	2000	1.7	18	11.45
PLP-800	DC-720	800	1080	1400	2000	1.7	18	11.45
PLP-850	DC-780	850	1100	1400	2000	1.7	18	11.45
PLP-1000	DC-900	990	1340	1750	2000	1.7	18	11.45
PLP-1500	DC-1000	1200	1620	2100	2500	1.7	18	11.45

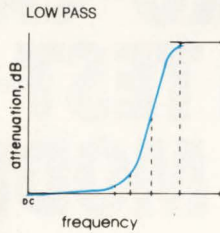

### high pass dc to 2500MHz

MODEL NO.	PASSBAND, MHz (loss <1dB)		STOP BAND, MHz (loss >20dB) (loss >40dB)			VSWR		PRICE \$ Qty. (1-9)
	Min.	Min.	Min.	Min.	Min.	pass-band typ.	stop-band typ.	
PHP-50	41	200	37	26	20	1.5	17	14.95
PHP-100	90	400	82	55	40	1.5	17	14.95
PHP-150	133	600	120	95	70	1.8	17	14.95
PHP-175	160	800	140	105	70	1.5	17	14.95
PHP-200	185	800	164	116	90	1.6	17	14.95
PHP-250	225	1200	205	150	100	1.3	17	14.95
PHP-300	290	1200	245	190	145	1.7	17	14.95
PHP-400	395	1600	360	290	210	1.7	17	14.95
PHP-500	500	1600	454	365	280	1.9	17	14.95
PHP-600	600	1600	545	440	350	2.0	17	14.95
PHP-700	700	1800	640	520	400	1.6	17	14.95
PHP-800	780	2000	710	570	445	2.1	17	14.95
PHP-900	910	2100	820	660	520	1.8	17	14.95
PHP-1000	1000	2200	900	720	550	1.9	17	14.95

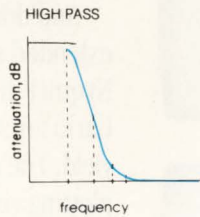

### bandpass 20 to 70MHz

MODEL NO.	CENTER FREQ. MHz F0	PASS BAND, MHz (loss <1dB)		STOP BAND, MHz (loss > 10 dB) (loss > 20 dB)				VSWR 1.3:1 typ. total band MHz	PRICE \$ Qty. (1-9)
		Max. F1	Min. F2	Min. F3	Max. F4	Min. F5	Max. F6		
PIF-21.4	21.4	18	25	4.9	85	1.3	150	DC-220	14.95
PIF-30	30	25	35	7	120	1.9	210	DC-330	14.95
PIF-40	42	35	49	10	168	2.6	300	DC-400	14.95
PIF-50	50	41	58	11.5	200	3.1	350	DC-440	14.95
PIF-60	60	50	70	14	240	3.8	400	DC-500	14.95
PIF-70	70	58	82	16	280	4.4	490	DC-550	14.95

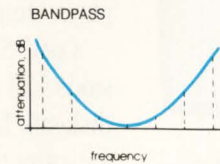

### narrowband IF

MODEL NO.	CENTER FREQ. MHz F0	PASS BAND, MHz I.L. 1.5dB max. F1-F2	STOP BAND, MHz I.L. > 20dB		STOP BAND, MHz I.L. > 35dB		PASS-BAND VSWR Max.	PRICE \$ Qty. (1-9)
			F5	F6	F7	F8-F9		
PBP-10.7	10.7	9.5-11.5	7.5	15	0.6	50-1000	1.7	18.95
PBP-21.4	21.4	19.2-23.6	15.5	29	3.0	80-1000	1.7	18.95
PBP-30	30.0	27.0-33.0	22	40	3.2	99-1000	1.7	18.95
PBP-60	60.0	55.0-67.0	44	79	4.6	190-1000	1.7	18.95
PBP-70	70.0	63.0-77.0	51	94	6	193-1000	1.7	18.95

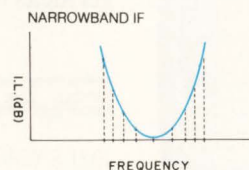

CIRCLE NO. 138

**Mini-Circuits**

P.O. BOX 350166, Brooklyn, New York 11235-0003 (718) 934-4500 FAX (718) 332-4661 TELEX 6852844 or 620156 WE ACCEPT AMERICAN EXPRESS

F132-2 REV. ORIG.



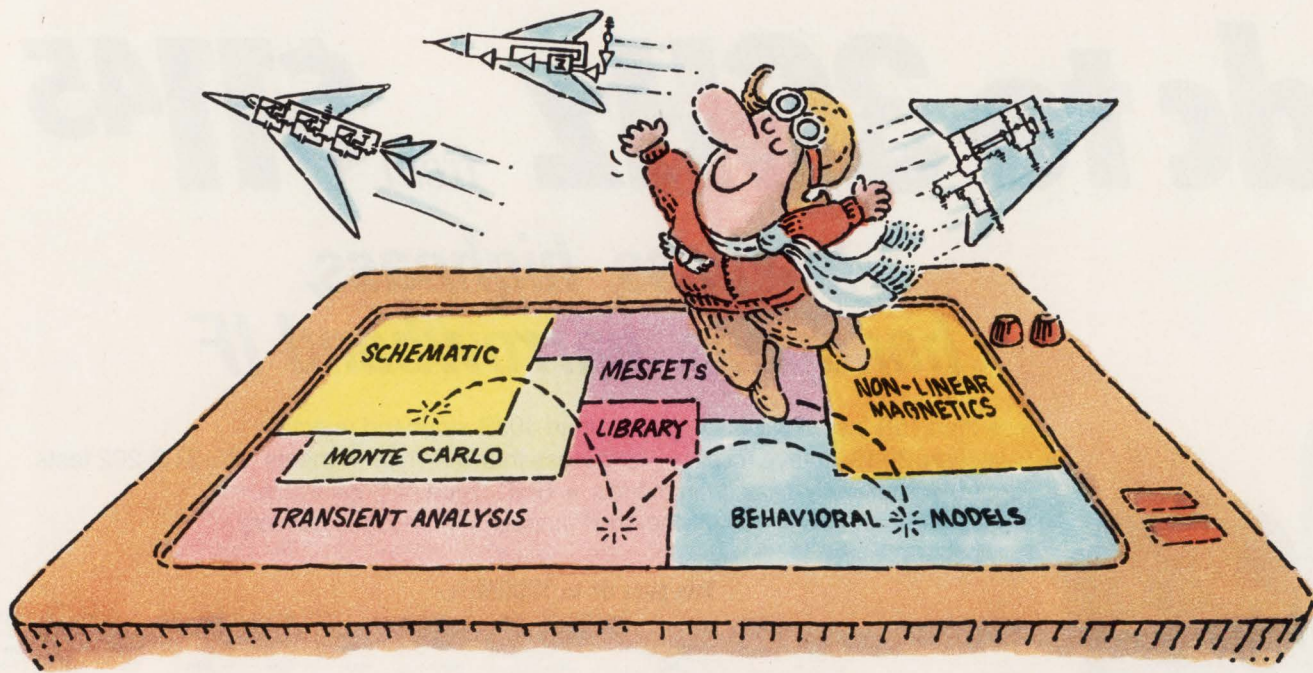

# THE NEW MICRO-CAP III.™ SO YOU CAN TEST-FLY EVEN MORE MODELS.

It wasn't easy. But we did it. Made the long-time best-selling IBM® PC-based interactive CAE tool even better.

Take modeling power. We've significantly expanded math expression capabilities to permit comprehensive analog behavioral modeling. And, beyond Gummel Poon BJT and Level 3 MOS, you're now ready for nonlinear magnetics modeling. Even MESFET modeling.

Analysis and simulation is faster, too. Because the program's now in "C" and assembly language. That also means more capacity — for simulating even larger circuits.

As always, count on fast circuit creation, thanks to window-based operation and a schematic editor. Rapid, right-from-schematics analysis — AC, DC, fourier and transient — via SPICE-like routines. The ability to combine digital/analog circuit simulations using integrated switch

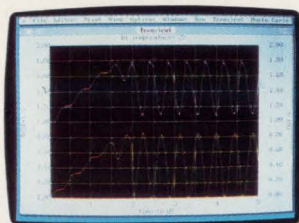

*Transient analysis*

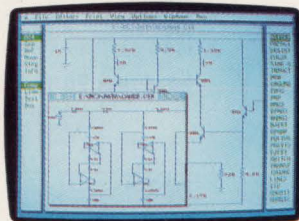

*Schematic editor*

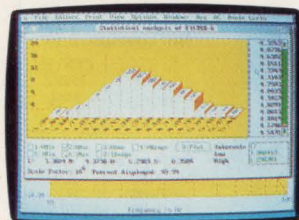

*Monte Carlo analysis*

models and parameterized macros. And stepped component values that streamline multiple-plot generation.

And don't forget MICRO-CAP III's extended routine list — from impedance, Nyquist diagrams and BH plots to Monte Carlo for statistical analysis of production yield. The algebraic formula parsers for plotting virtually any function. The support for Hercules, CGA, MCGA, EGA and VGA displays. Output for plotters and laser printers.

Cost? Still only \$1495. Evaluation versions still only \$150. Brochure and demo disk still free for the asking. Call or write for yours today. And see how easily you can get ideas up and flying.

**spectrum**

1021 S. Wolfe Road  
Sunnyvale, CA 94086  
(408) 738-4387



# ASK EDN

EDITED BY JULIE ANNE SCHOFIELD

Have you been stumped by a design problem so long that you don't know who to turn to? Are you having trouble locating parts? Finding companies? Can't interpret a spec sheet? Ask EDN.

This department will serve as a forum to solve nagging problems and answer difficult questions. EDN's editors will provide the solutions. If we can't solve a problem, we'll find an expert who can, or we'll print your letter and ask your peers for help. We can't answer every question, but we'll try to publish the ones that will help you most in your job.

Address your letters to Ask EDN, 275 Washington St, Newton, MA 02158. FAX (617) 558-4470; MCI: EDNBOS. Or, send us a letter on EDN's bulletin-board system. You can reach us at (617) 558-4241 and leave a letter in the /ask\_edn Special Interest Group.

## Gas-sensor circuit found

I'm looking for a circuit diagram of a gas and smoke alarm, gas monitor, gas sentinel, electronic gas detector, or gas analyzer that uses the Figaro (Wilmette, IL, (312) 256-3546) 813 or 822 gas sensor. Green, yellow, and red LEDs should indicate low, medium, and high gas concentrations, respectively. Such a system could also be a fire alarm because the sensor detects smoke also. Thank you for your help.

**Dilip S Poudwal**  
**Ocean Star CHS/G-5**  
**Bombay, India**

Linear Technology Corp's Application Note 11, "Designing Linear Circuits for 5V Operation," (September 1985) describes a circuit for a linearized methane transducer signal conditioner that uses the

Figaro 813 sensor. You can contact the company at 1630 McCarthy Blvd, Milpitas, CA 95035. (408) 432-1900. FAX (408) 434-0507.

## Alternate source located

We are using DM2502 successive approximation registers made by National Semiconductor. This device has been obsoleted by National Semiconductor. Please let us know of alternate sources or devices.

**V Ramasubramaniam**  
**R&D Manager**  
**Systronics**  
**Naroda, India**

According to Brent Rowe, marketing manager for digital memory products at National Semiconductor, Rochester Electronics Inc now manufactures DM2502s. You can contact the company at

Rochester Electronics Inc  
10 Malcolm Hoyt Dr  
Newburyport, MA 01950  
(508) 462-9332  
FAX (508) 462-9512.

## Readers and sources linked

In the January 21, 1991, issue of EDN, Mr Christer Berg requested a source for National Semiconductor's NS405-A12N microprocessor. We have a supply of 234 used NS405B12N microprocessors that may be of use to him.

The A12 uses a 5x7 type font, whereas the B12 uses a 7x9 type font, but both operate at a 12-MHz video rate. These parts were used for less than one year in a video board; we are unlikely to use the board design in the future. While awaiting our management's permission to release or sell these

parts, it would be useful to know if they are of any value to Mr Berg. Please pass our phone number along to Mr Berg or relay his number to us.

**Mark Foon**  
**Manager of Technical Services**  
**British Columbia Lottery Corp**  
**Kamloops, BC, Canada**

In the January 21, 1991, issue, someone was looking for National Semiconductor part number NS405-A12. We have some available. Have persons contact me.

**Roland Levin**  
**Videomedia**  
**Sunnyvale, CA**

We also are in need of National Semiconductor part NS405-A12; therefore, we would appreciate a source for these chips.

**Forest C Sprague**  
**Adaptrol Inc**  
**Pontiac, MI**

The appropriate parties have been put in contact with each other.

## Reader seeks piggyback plug

Can you find out who manufactures piggyback plugs? A piggyback plug is a service cord with an in-line series 3-prong plug.

**Larry Shields**  
**Custom Switches Inc**  
**Manvel, TX**

Belden Wire & Cable has a standard product #17666 that has a male and female connector on the same end of the cord. You can contact the company at

Belden Wire & Cable  
Box 1980  
Richmond, IN 47375  
(800) 235-3364;  
in IN, (317) 983-5200  
FAX (317) 983-5294.

EDN



# Get S

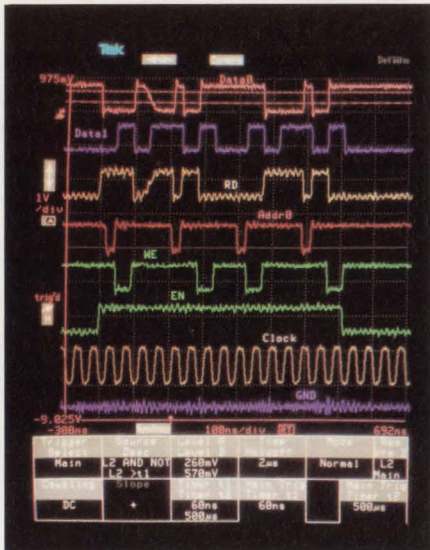

**Extended triggering.** Sophisticated triggering in the DSA600A reliably discriminates glitches, transition slew-rates, runt pulses and timing violations. Long memory and pre-trigger help reveal the cause.

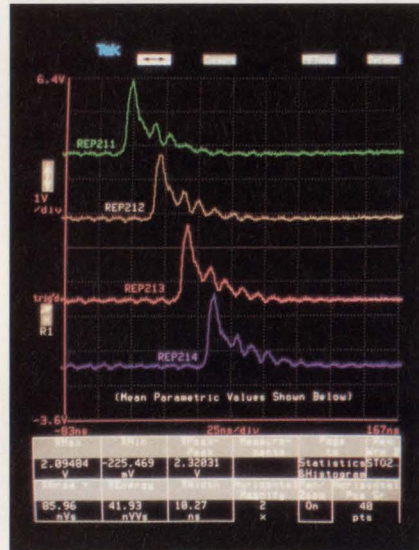

**Transient capture, analysis and storage.** Capture a series of transient events with automatic labeling and parametric analysis. Examine statistics of each measured parameter over the ensemble. Transport results using built-in (DOS-compatible) floppy disk.

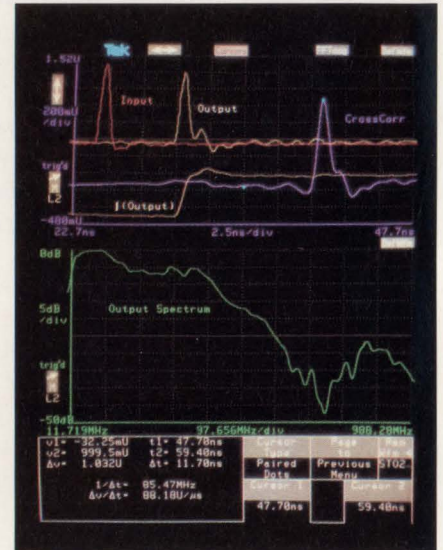

**Advanced signal processing.** Transform and combine acquired waveforms at visual real-time speeds to reveal key phenomena. FFT, correlation, convolution and calculus functions provide multiple views of critical events.

**When you need serious measurement, serious analysis, serious accuracy, nothing—but nothing—delivers it like Tek DSA 602A and 11403A oscilloscopes.**

When you expect your instruments to be as serious about the truth as you are, only the DSA602/11403A, with their superb new amplifiers and probes, their unrivaled accuracy, plug-in flexibility, and their powerful new set of waveform analysis and measurement functions, come through with results like you see above.

**Serious numbers? Try the new 2 GS/s, 1 GHz bandwidth Tek DSA 602A.** No other scope combines DSP hardware for live displays of FFTs, correlation or convolution, plus high signal fidelity and powerfully selective triggering modes. There's even a new disk drive in this latest DSA version to save setups and data.

**Pit the new 11403A Digitizing Oscilloscope, with 1 GHz bandwidth and 10-bit vertical resolution, against the toughest repetitive signals.** Get more than 30 pushbutton measurements, with statistical analysis and built-in pass/fail decisions from the most accurate scope of all. Put its new FFT features to work measuring total harmonic distortion, or use the statistical data base to characterize jitter.

**Configure and reconfigure your scope with new plug-ins like Tek's programmable 50 MHz current amplifier, four-channel 75Ω video amplifier and high-resolution video trigger.** Choose from our true differential amplifier and voltage comparator, our 50Ω and high-impedance amplifiers. Take advantage of their unequalled overdrive recovery and wide dynamic



# erious!

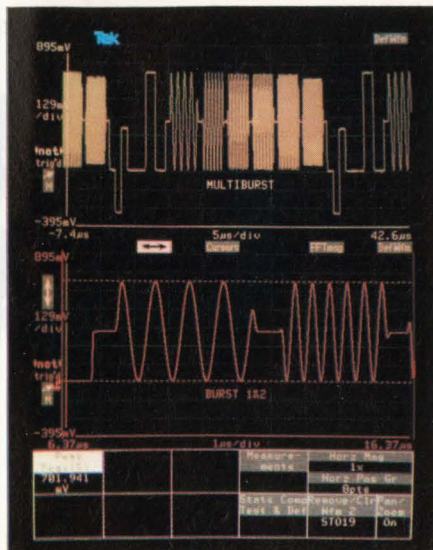

**Video and HDTV.** Analyze video waveforms, including HDTV. Line and field select on up to 1280 lines with the new 11T5H Video Trigger Unit. New 4-channel 11A34V 75Ω Video Amplifier provides excellent signal fidelity up to 300 MHz.

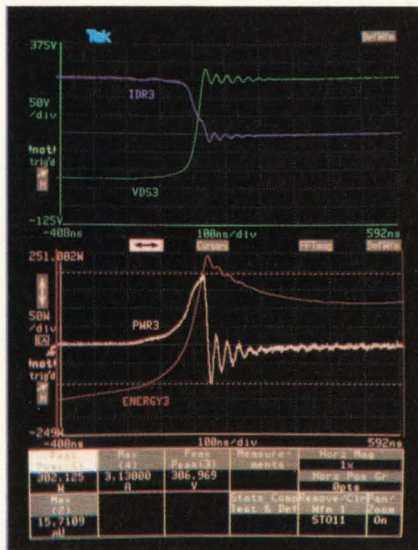

**Current and power.** Make accurate, high-bandwidth power measurements and energy calculations with our new 11A16 Programmable Current Amplifier. Current and voltage maintain their proper phase relationship to 50 MHz.

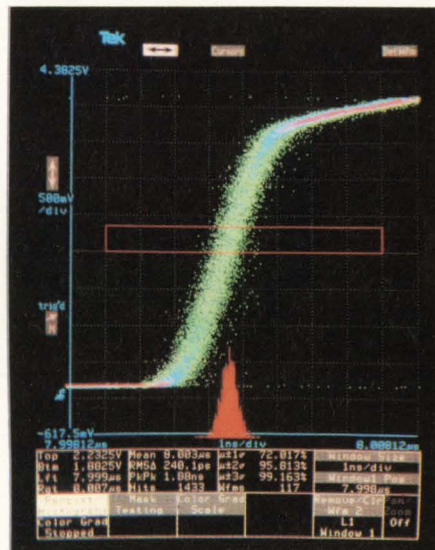

**Jitter and noise analysis.** Analyze jitter and noise with Tek's exclusive statistical data base. Color grading, statistic readout and histograms clearly show the distribution of the edge jitter.

range, while you mix and match to the capabilities, channels and bandwidths you need.

Finally, choose from our high-impedance, high-bandwidth probes for fast logic devices... high-voltage and current probes for power conversion analysis... optical-to-electrical converters for direct measurements on lightwaves... and more, from the best probing resource around.

Current measurements, spectrum analysis, transient capture, glitch detection, precise power measurements, jitter analysis, high-definition video design—when your work is this serious, you want serious solutions like the DSA602A/11403A. Contact your Tek sales engineer or return the card for more information.

# 1-800-426-2200

F A X 1 - 5 0 3 - 6 9 0 - 3 9 5 9



One company measures up.

**Tektronix**  
COMMITTED TO EXCELLENCE



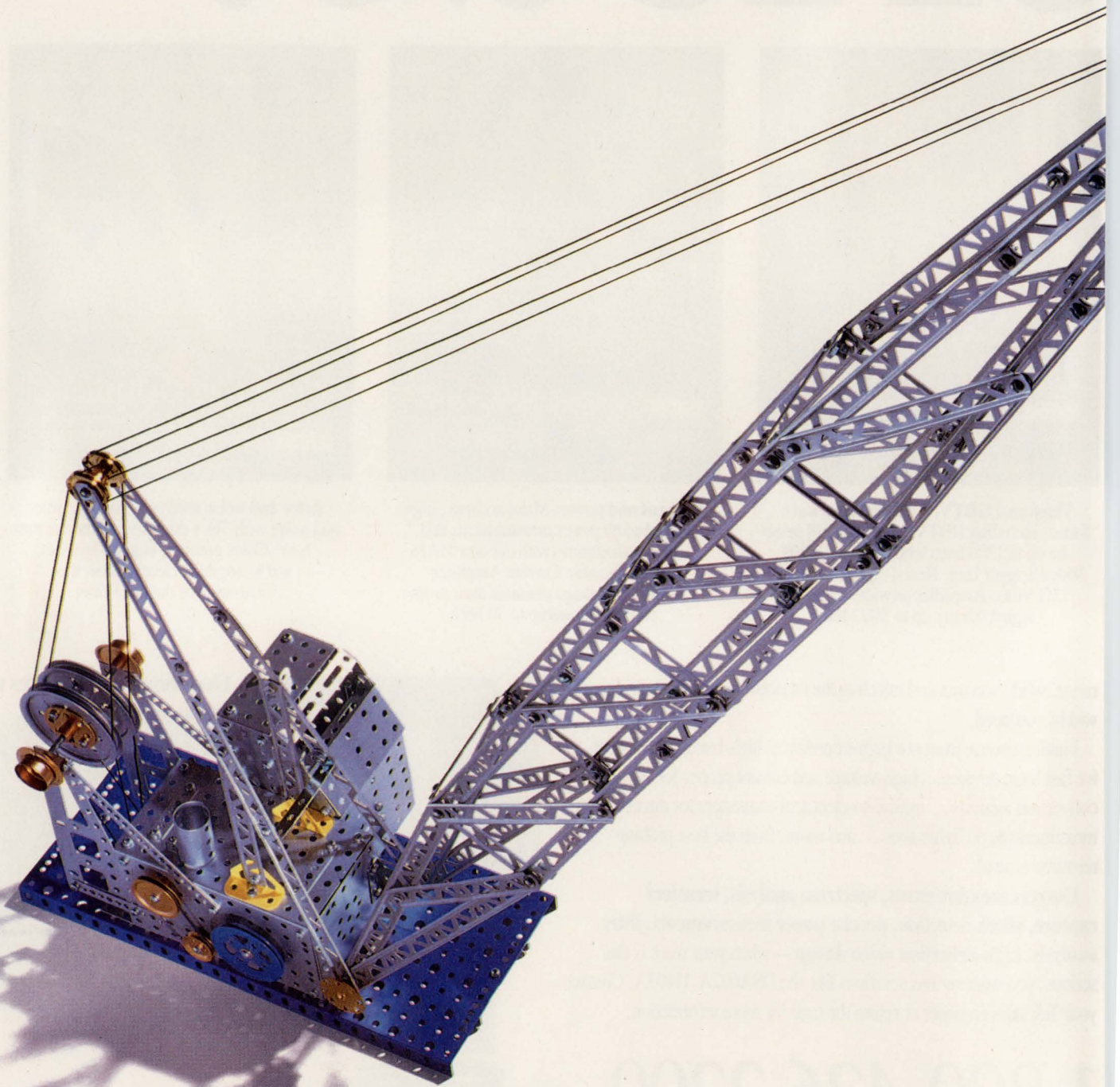



# Introducing The Erector Set for Embedded Control Applications



Remember the challenge of constructing "engineering marvels" with your Erector® set? That red metal box held a complete set of interlocking pieces — all that was needed to assemble just about anything. Your imagination was the only limitation.

That's the idea behind Ampro's new way for OEMs to build embedded control applications. Put your application together, simply and quickly, using Ampro Embedded System Modules.

Our CoreModule™ family packs ready-made full PC- or AT-compatible intelligence into 3.6" x 3.8" x 0.6". Just plug one into your circuit board — like plugging in a chip — to easily interface to your own logic. They operate over 0 to 70°C, and include a CMOS CPU, RAM, extended BIOS, Solid State Disk, serial and parallel I/O ports, keyboard and speaker interfaces, and a real-time clock.

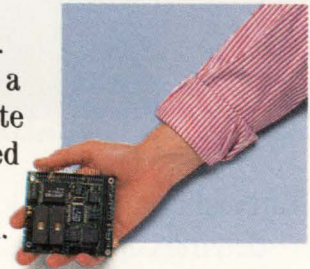

Stack a CoreModule unit together with one or more of our expansion MiniModule™ peripherals (no backplanes or card cages needed). MiniModule products, also 3.6" x 3.8", can be used to add display controllers, more Solid State Disk capacity, network controllers, modem and facsimile features, additional I/O, and much more.

You'll get your product to market faster, with less risk, and at lower cost, because the CoreModule family is based on the most economical industry standard architecture. Now you can focus on the more challenging part of your system — the application itself.

Ultrasound monitors, point-of-sale terminals, robotics, network controllers — no matter what kind of "engineering marvel" you're building, you should be using Ampro's "Erector set" for your embedded control application.

Call **1-800-966-5200**. Get the Information Kit on CoreModule and MiniModule products today.



Pioneering Solutions for Embedded Control

CoreModule, MiniModule and Ampro are trademarks of Ampro Computers, Inc. Erector is a registered trademark of Gabriel Industries, Inc. Other product and company names are trademarks and registered trademarks of their respective companies. © 1991 Ampro Computers, Inc.



# At $\pm 15V$ , our high-speed VIP™ op amps are the ultimate driving devices.

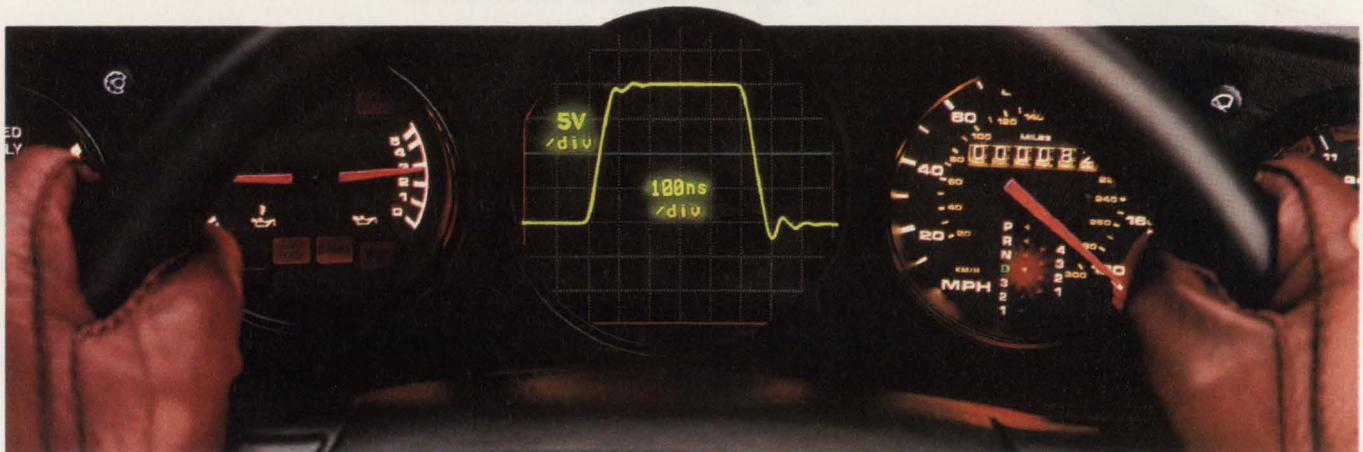

Driving a 1,000pF  $C_L$  and slewing at 250V/ $\mu$ s, the LM6313 delivers 250mA into the load and still remains stable.

## Turbocharging your load-driving capabilities.

Our new VIP op amps are built to drive... and at very high speeds. Which makes a great deal of high-performance sense when you consider they're designed with an innovative bipolar technology called "Vertically Integrated PNP" or VIP.

With a  $\pm 15V$  power supply, our VIP op amps offer a higher signal-to-noise ratio, a higher dynamic range, and higher drive capability (none of which you can get from other high-speed  $\pm 5V$  amps). In fact, they'll drive capacitive loads without oscillating. Which means they're easy-to-use and very stable. Even at the highest speeds.

## Packing precision and speed in the same op amp.

The LM6218, a dual op amp, is not only extremely precise, it's extremely fast. Which is why it provides a low offset voltage of 3mV (1mV max for the LM6218A), a bandwidth of 17MHz, and a slew rate of 140V/ $\mu$ s.

It also provides a settling time of 400ns to 0.01% for a 10V step and 7mA of power dissipation. All in a dual op amp. So now you get a high-performance solution that's ideal for high-speed industrial and military applications requiring 12-bit accuracy, such as image processing and high-speed data acquisition and instrumentation (883/SMD devices are available).

performance now achieved by our one-chip solution, the LM6313.

This monolithic device delivers 35MHz performance and a 250V/ $\mu$ s slew rate. Plus, it'll drive a 75 $\Omega$  cable to a  $\pm 11V$  output swing—with a peak output current of 300mA and 220mA continuous—making it ideal for ATE and pin-driver applications.

What's more, the LM6313 provides on-chip protection. Like overcurrent and thermal shutdown protection with early-warning error flags.

## Driving with a winner.

For your design package, call or write us today. And let our high-speed VIP op amps put your designs into overdrive.

1-800-NAT-SEMI, Ext. 123  
National Semiconductor Corp.  
P.O. Box 7643  
Mt. Prospect, IL 60056-7643

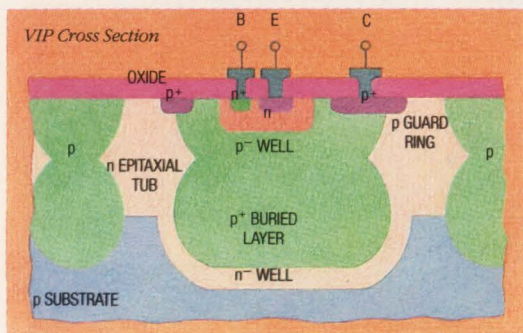

Delivering the world's first high-speed, high-power monolithic op amp.

Until recently, you needed multi-chip solutions to match the world-class



VIP is a trademark of National Semiconductor Corporation.  
© 1991 National Semiconductor Corporation



# EDITORIAL

## Teach children to think about math



I am amazed at the way we introduce our children to the wonders of higher mathematics. Instead of teaching them how to think about solving problems, we dull their interest with drill sheets of unchallenging problems. It seems that many teachers learned by-the-book methods and that is how they teach. Some of those techniques baffle me. My 13-year-old daughter had a difficult time with percentages in math class. The tough part for her was deciding which way to move a decimal point. I explained that a percentage is just a fraction that always has 100 in the denominator. Once you know that, you can keep track of what you're doing without guessing. Instead, her teacher moved decimal points *without discussing the techniques* involved in setting up the problems.

In my 16-year-old son's math class they studied logarithms. I was dismayed to see that they were writing down logs in an archaic way—3.6789-7, for example. Surely there are better ways to introduce children to the subject of logs. Unfortunately, the children cannot use calculators to find logs and antilogs. Neither can they use them to interpolate between log-table values. My son found it difficult to understand the interpolation method taught in school. I explained it to him by graphing a straight line between two points, which clarifies what interpolation is all about. He said they never showed him that in school.

I'm surprised by the prohibition of calculators. Some teachers and parents think that calculators encourage laziness and undermine basic math skills. Nothing could be further from the truth. Poor teaching techniques and long columns of dull exercises undermine anyone's interest in math. If school systems and teachers would concentrate on the basic skills of thinking about math, explaining how to approach problems, and applying these skills in different ways to solve realistic problems, the controversy about calculators would subside. Educators would find that many children really can enjoy math.

We should challenge youngsters with realistic problems that show them what percentages, logarithms, and interpolations are all about. It's surprising how a class' interest blossoms when you explain logs in terms of decibels and the Richter scale. We must also concentrate on explaining alternate methods of solving problems and explaining that there's no one right way, but many wrong ways, to arrive at answers—and how to know the difference. By using calculators, children can quickly try alternate routes to solving problems.

There may be some hope. I'm pleased to read that people taking the College Board math achievement test in June will be able to use calculators. That's the right approach—let the students concentrate on evaluating and setting up problems. The calculators can do the routine computations. I hope we'll see more and more calculators, computers, and other tools push their way into classrooms. I hear other parents say, "Calculators just let children get sloppy and avoid the hard math. They need more drill and work sheets on the basics." Maybe they're right. Perhaps modern tools have no place in school. But what if your daughter says she is having trouble in wood shop because it's difficult to drive a nail straight when banging it with a rock? Isn't it time for a hammer?



Jesse H. Neal  
Editorial Achievement Awards  
1987, 1981 (2), 1978 (2),  
1977, 1976, 1975  
American Society of  
Business Press Editors Award  
1988, 1983, 1981

  
Jon Titus  
Editor

Send me your comments via FAX at (617) 558-4470, or on the EDN Bulletin Board System at (617) 558-4241 300/1200/2400, 8, N, 1.



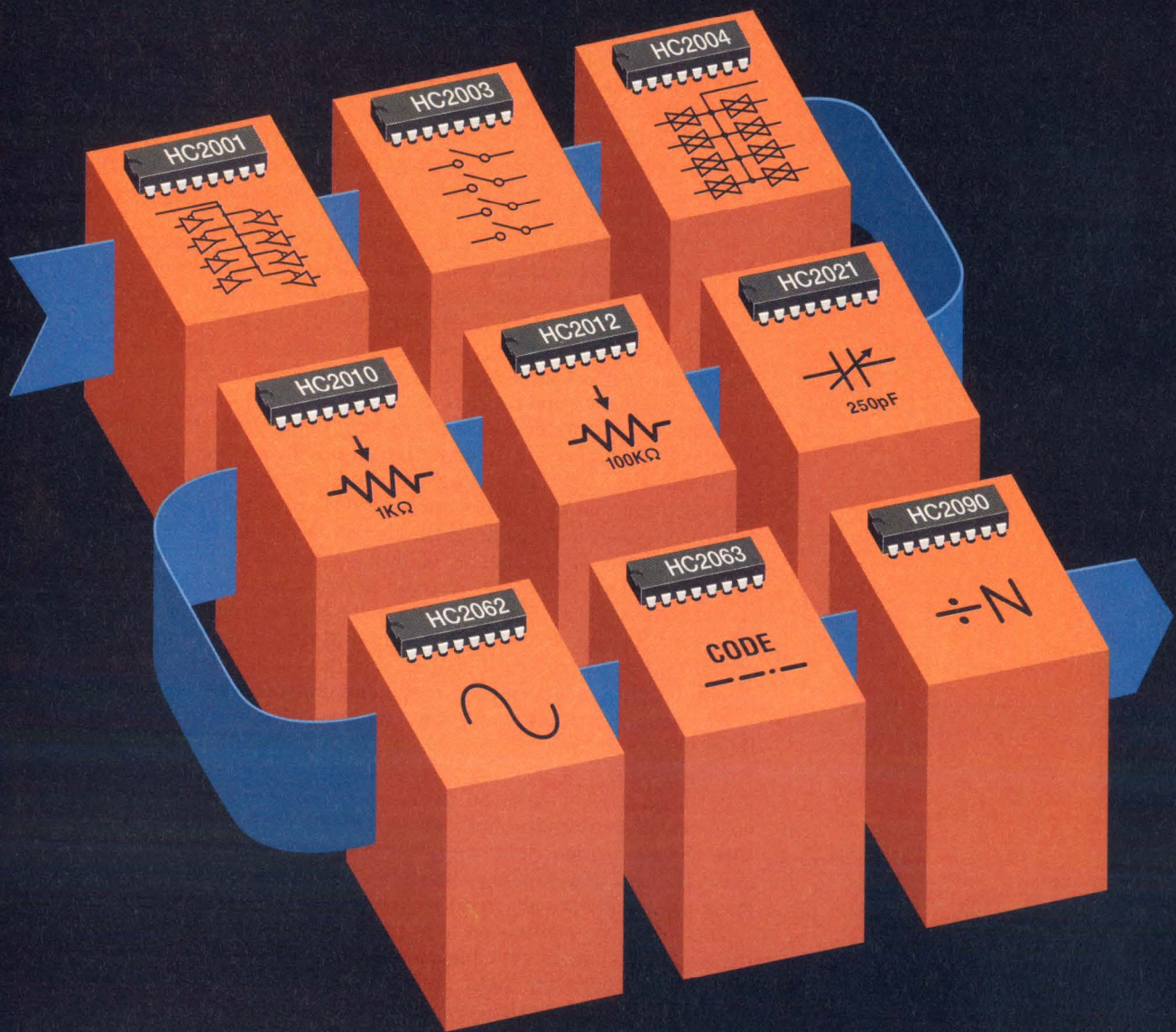

**NONVOLATILE  
SERIALLY PROGRAMMABLE  
DEVICES**





# IT'S A WHOLE NEW BALLGAME!

**Here are nine players that can  
work together in any order.  
Won't forget their plays. And  
can take new instructions  
anytime from homeplate.**

From the Semiconductor Products Center of Hughes Aircraft Company comes another major development in semiconductor integrated circuits.

Hughes' new NSP family of Nonvolatile Serially Programmable devices gives circuit designers new freedom and flexibility in their work....saving time, money and labor while improving overall system performance and reliability.

With these nine general purpose devices, PC boards or hybrids can be trimmed or configured electronically. Instead of using a slow, laborious, and often difficult mechanical trimming procedure, it's all done remotely through a personal computer or test station.

That's because these NSP components have a serial interface feature which permits accessing the nonvolatile memory of the circuit at the system level, also enabling many configurable circuits to be cascaded.

Nonvolatile data latches retain the last programmed state in each device when power is removed, then automatically restore the correct state when power is resumed. In addition, a standard serial interface provides both read and write access to the nonvolatile memory. All NSP devices feature low power consumption and redundant circuit techniques to assure reliable operation and long life.

For a complete information packet, contact Hughes Semiconductor Products Center, PO Box H, Newport Beach, CA 92658; or call (714) 759-2665 or FAX (714) 759-2913.

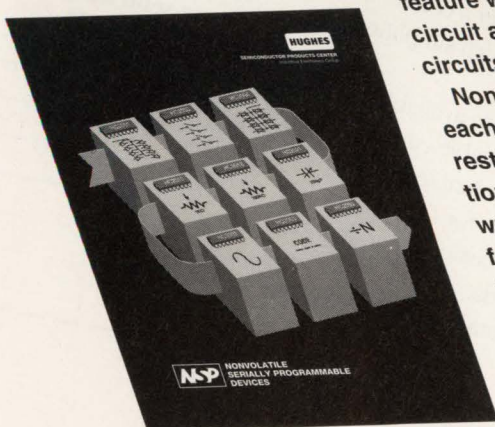



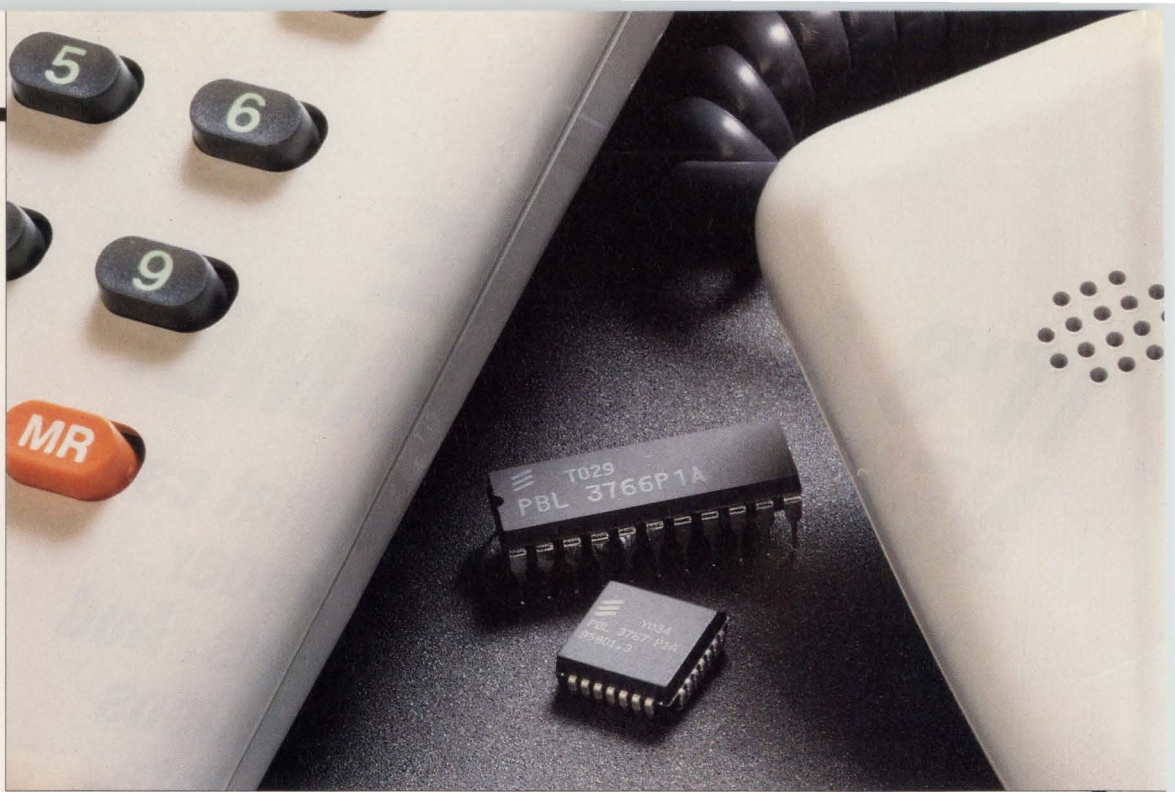

## New SLICs cut the cost of on-premises/PBX subscriber lines

Lower cost chips that need fewer external components are the latest Subscriber Line Interface Circuit offerings from Ericsson.

Designed for cost sensitive applications such as general purpose PBX/Key systems, they give you three other major advantages over alternative solutions: wide supply voltage operation from -24 V to -58 V dc, on-hook transmission and a very low on-hook power dissipation of just 35 mW with -48 V dc supply or 20 mW when running from a -24 V dc supply.

So you can reduce the cost of your power supply circuit too!

Each SLIC includes loop current and ring trip detection, together with a ring relay driver. And they work with either a conventional or programmable CODEC/filter, all of which simplifies design.

Equally important, the new circuits are available in two versions: the PBL 3766 with a programmable constant loop current, and the PBL 3767 with programmable resistive battery feed and loop current limitation for short lines.

Both come in a choice of 22-pin plastic DIP or 28-pin PLCC packages with compliant 'j' leads.

Simply call us for full technical data or clip the coupon.

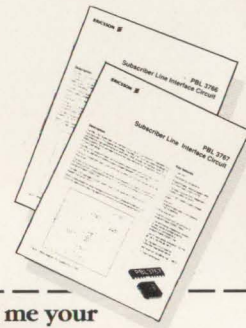

**Please send me your latest datasheets**

Name \_\_\_\_\_

Company \_\_\_\_\_

Job Title \_\_\_\_\_

Address \_\_\_\_\_

Telephone \_\_\_\_\_

Fax \_\_\_\_\_

**Ericsson Components Inc.**  
403 International Parkway, Richardson TX 75081  
Tel: 214 - 669 - 9900 Fax: 214 - 680 - 1059

**Distributors:** Alabama (205)880-8050. Arizona (602) 991-6300. California (408) 253-1960, (619) 292-1771, (714) 891-4621. Colorado (303) 758-4884. Connecticut (203) 243-9343. Florida (407) 352-3755. Georgia (404) 448-1215. Illinois (312) 968-0118. Indiana (317) 577-9950. Iowa (319) 354-8894. Massachusetts (508) 692-2500. New Jersey (201) 525-8000. New York (516) 929-5756, (716) 586-0777, (518) 383-2239. N Carolina (919) 847-8800. S. Carolina (803) 233-4637. Texas (214) 553-1200, (512) 834-8374, (713) 370-8177. Washington (206) 882-0962, (206) 254-4572. Wisconsin (414) 781-1730.

**ERICSSON** 

EDN April 11, 1991



## SENSITIVE SCOPE MEASUREMENTS

# Scopes pluck waveforms from the signal swamps

Oscilloscopes do far more than simply display a signal level versus time. Now they can dig through noise and sift out interference to make sensitive measurements accurately.

*Charles H Small,  
Senior Editor*

In the past, engineers performed many of their most sensitive measurements with instruments other than oscilloscopes. Sensitive measurements were the domain of band-limited, special-purpose instruments such as distortion meters, spectrum analyzers, phase meters, and network analyzers. But now you can make many of these sensitive measurements with your oscilloscope, backing up a digital oscilloscope with digital signal processing.

A word of caution: As Jim Williams, at Linear Technology, says, "High-performance circuits can work only if you negotiate compromises with nature. Ignorance of, or contempt for, physical law is a direct route to frustration." Physically, your probe and scope become part of your system under test when you hook the scope to your circuit.

### Scope and probe concerns

What do you need to know about your scope and probes? For starters, become very familiar with your particular scope's input impedance, rise times, ac coupling, probe compensation, noise performance, overdrive recovery, sweep nonlinearity, triggering, and channel-to-channel feedthrough.

Without knowing your scope's limitations, you can easily fall prey to the most common mistake in oscillography. You may unwittingly measure the performance of your scope instead of the performance of your circuit.

The GIGO (garbage-in/garbage-out) principle applies to oscillography with a vengeance. Informally surveying high-performance analog-IC makers and os-

cilloscope vendors reveals that most problems designers have with their high-performance circuits are actually probing problems. In short, to take advantage of modern scopes' processing power, you must first comprehend the mysteries of probing.

You have many different kinds of probes to choose from. Each type has

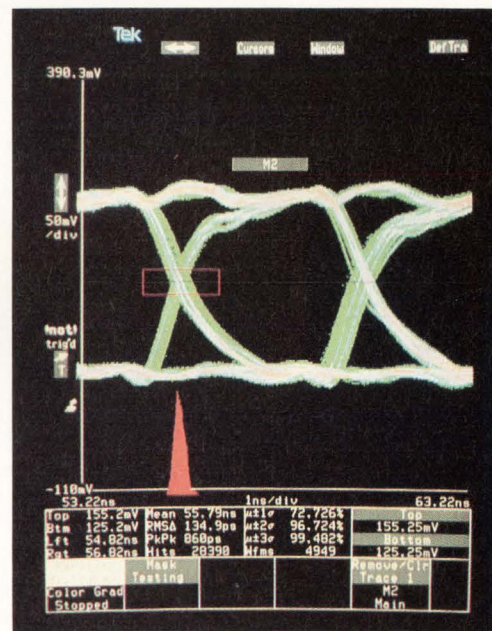

You can characterize complex signals using digital post processing such as that offered by Tektronix Tek CDA 803.

its own proper sphere of application. FET probes, for example, have high input resistance and low input capacitance. But they also have substantially more delay than passive probes. FET probes' common-mode-range limitations can lead to erroneous displays if you accidentally exceed them. Not all FET probes have extremely high input resis-



# Sophisticated instrumentation deserves sophisticated packaging

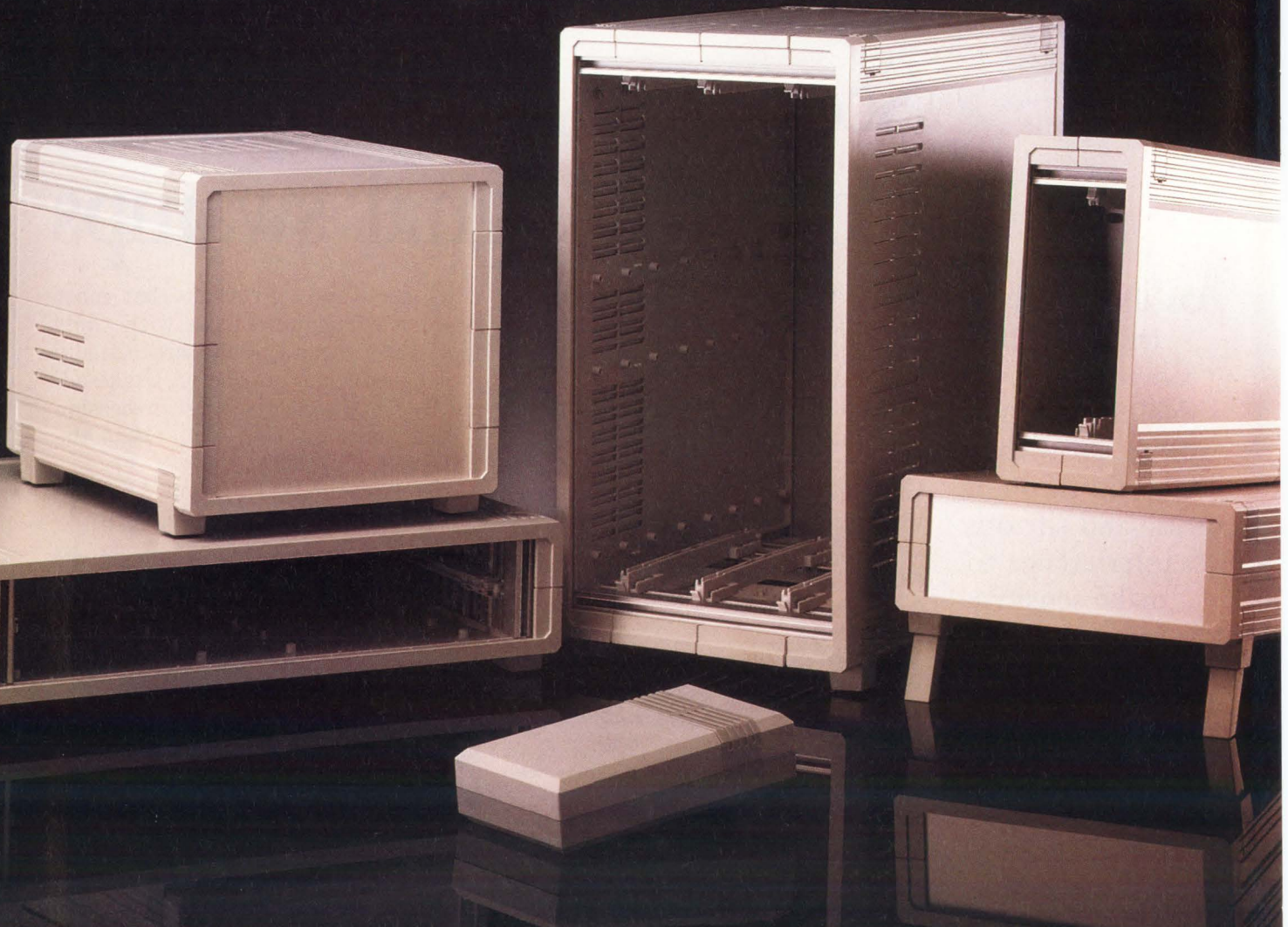

Give your product a competitive advantage. Package it in a Bopla enclosure.

Bopla enclosures complement your design. From a flawless molded finish to the concealed lid screws, every enclosure combines smart looks with innovative features. Modular construction enables expansion and interchangeability. Molded-in slots and standoffs make component installation easy.

Every family of Bopla enclosures comes in a broad range of sizes and options so that you can find one that matches your packaging needs perfectly. When you're ready to bring your product to market, there's no better way to improve its marketability than with a Bopla enclosure.

Call  
for  
the  
Bopla  
master  
catalog.



**(301) 696-9300**  
FAX: (301) 696-9494



7330 Executive Way  
Frederick, Maryland 21701



# TECHNOLOGY UPDATE

## Sensitive scope measurements

tance—some types are as low as 100 k $\Omega$ .

Current probes come in two types. The passive, transformer types are fast and have less delay than the Hall-effect versions. The Hall types, however, respond at dc and low frequencies; the transformer types typically roll off below a certain frequency limit, usually 100 Hz to 1 kHz. You can easily saturate both types of current probes, resulting in misleading displays.

Study each type of probe that you use. Different probes have different impedances and delay times. You must account for these impedances so you can hook the probes to your circuit without inducing spurious responses. Your probes' differing delays influence how you interpret your scope's displays.

A probe's resistive loading can cause amplitude distortion and alter the dc bias of your circuit. Capacitive loading can cause timing changes by introducing an RC time constant or by slew-rate limiting. Capacitive loading also causes nasty bandwidth-limiting effects. Under certain conditions, the probes parasitic effects can even cause an otherwise stable circuit to resonate.

Probing's greatest source of error is grounding. The parasitic inductance in a probe's ground connection can cause ripples and discontinuities in a displayed waveform. Probes' ground wires have about 25 nH/in. of inductance. In some cases the grounding at one channel will affect waveforms on another channel. In the worst case, connecting the probe's ground wire will shut your circuit down.

Common-mode noise wreaks havoc with sensitive measurements. Luckily, you have several ways to attack this noise. Which scheme you use to measure signals in the presence of high common-

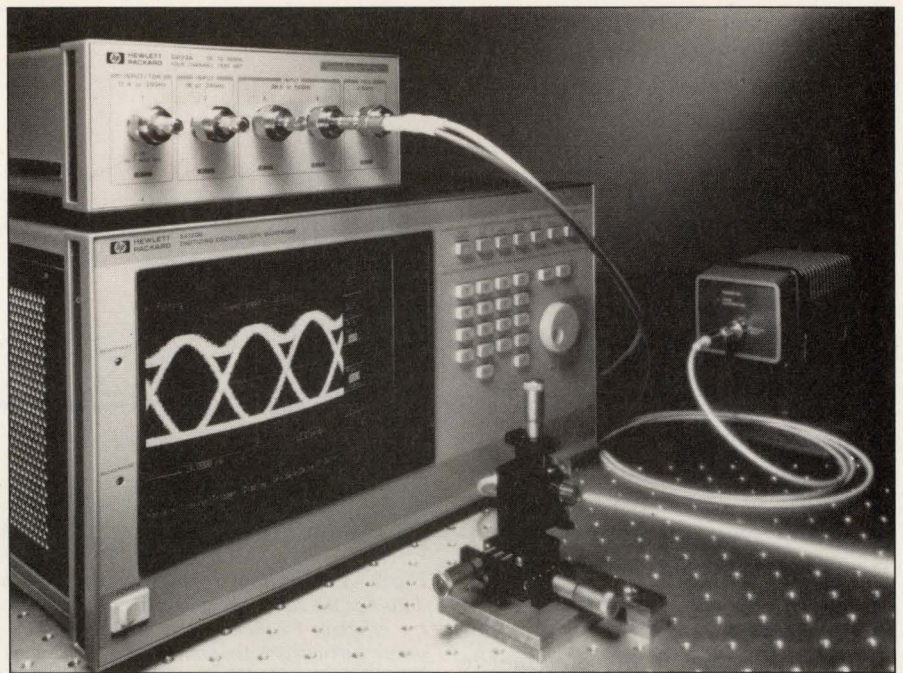

*The segmented memories in digital oscilloscopes, such as the Hewlett-Packard HP 54124A, can capture bursts of signals.*

mode interference depends on frequency. Use differential plug-ins for low-speed, differential probes at frequencies as high as 200 MHz, and the familiar A-B scope setting (with your A and B probes carefully zeroed out) for higher-frequency signals such as differential ECL signals. Digital scopes make probe zeroing a snap because they let you take care of differing probe delays by shifting memory points in software rather than trying to make up for phase differences in hardware.

### Now consider your oscilloscope

Proceeding down the signal chain from probe to scope, consider a scope with a differential-amplifier front end or plug-in. Most engineers think of differential amplifiers as measuring signals not referred to ground, such as across a current shunt. However, differential amplifiers provide two not-so-obvious advantages in noisy environments as well.

At low signal levels, the ground

potential at the signal source is often not exactly equal to the ground potential at your scope. Ground loops and high ground-return currents conspire to make your signal ground very noisy compared with low-level signals. Many ground-loop problems would disappear if scopes were double insulated. But industry standards require everything to be grounded—both systems under test and scopes.

To verify how noisy a ground can be, try putting a scope probe on your circuit's "ground" sometime. You will almost always see substantial noise and perhaps a small dc offset. The scope probe faithfully picks up and reproduces this noise. But a differential measurement cancels out the grounding differences, restoring true fidelity.

A second and related benefit of the differential amplifier is RF/EMI reduction. As is obvious, any electromagnetic flux cutting across a scope probe's cable induces a small voltage across the cable's shield.



# TECHNOLOGY UPDATE

## Sensitive scope measurements

Thus the scope sees the actual signal plus the noise voltage induced on its ground shield (Fig 1a). A differential amplifier cancels the spurious signal, passing only the differential signal (Fig 1b). This effect explains why telephone, audio, and data communications use balanced line transmission.

Assuming you are adept enough at oscillography to capture an accurate representation of a signal, digital postprocessing of that signal can transform your general-purpose oscilloscope into a band-limited, special-purpose, sensitive instrument. Whether you do your postprocessing with your scope's built-in routines (if any) or export the raw data files to a computer for analysis is mostly a matter of convenience and throughput. In both cases, the postprocessing principles are the same. For example, the Nicolet Series 400 oscilloscope has a built-in version of Basic that can call the scope's routines. You can use this interpreter to compose and execute a suite of signal-processing routines.

### Capture multiple records

In some cases, the throughput—from capture, to dumping the captured data into off-line memory, to re-arming the scope—is especially important. In pulsed-laser and

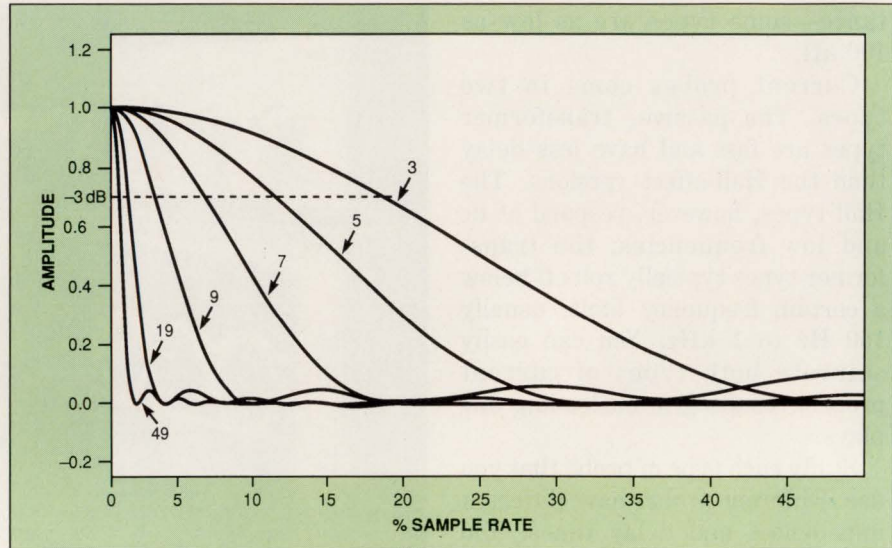

Fig 2—Performing a “sliding average,” or “smoothing function,” on a set of digitized data has the same effect as a lowpass filter: removing high-frequency noise. This graph shows the effective frequency response of various numbers of points in the sliding average. The graph normalizes frequency as a percentage of the digital scope's sample rate.

data-communication applications, for example, the device under test often produces a short burst of data followed by a relatively long interval of dead time. In most cases, you are interested in only the pulsed data, not the dead time between pulses. In these cases, the digital scope must have very fast throughput or a segmented memory.

With a segmented memory, such as that in the Hewlett-Packard HP 54510A, the digital scope can capture several high-speed bursts before exhausting its high-speed

memory. Thus you can capture several records without pausing to dump your captured data to off-line memory.

After capturing a record, or records, digital scopes can further manipulate the captured data with post-capture processing. Digital scopes, such as LeCroy's 9400 series, commonly perform postprocessing such as averaging, filtering, phase shifting, rise- and fall-time derivation, and FFTs (Fig 2).

A feature unique to digital scopes is their ability to digitally filter al-

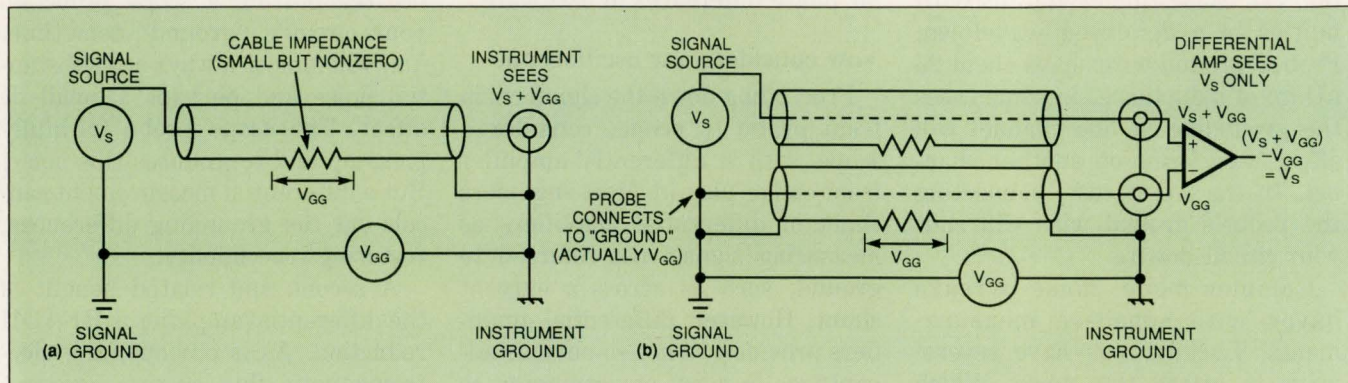

Fig 1—The impedance of a scope probe's ground lead (a) adds a minute, but not negligible, voltage ( $V_{GG}$ ) to the signal's voltage that a single-ended scope sees. In b, a scope having a differential probe or differential front-end cancels out the ground lead's spurious voltage.



# Imagine what you can do with the development time you save.

If your application is too demanding for a standard data acquisition package, you have just two choices. Spend valuable time writing low-level code. Or get a data acquisition system that provides its own microprocessor and control subsystem.

Microstar Laboratories' intelligent Data Acquisition Processors™ are complete control subsystems, not just hardware input/output units. The DAP 800™, DAP 1200™, and DAP 2400™ have on-board processors, buffer memory, and DAPL™—a complete real-time multitasking data acquisition and control operating system.

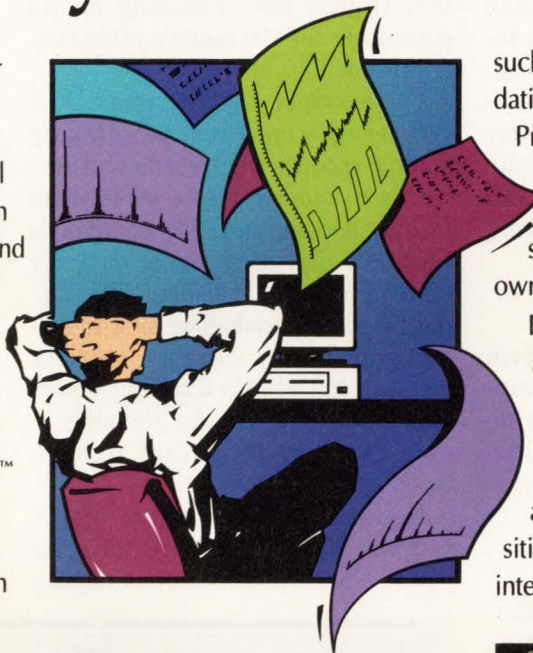

such tasks as writing to disk and updating the screen. The Data Acquisition Processors are compatible with C, Pascal, BASIC, FORTRAN, and other PC programming languages, so you can add code to meet your own specific needs.

By providing a second processor and separating the data acquisition operating system from the PC's operating system, the Data Acquisition Processor gives you a high performance data acquisition system for the price of a non-intelligent data acquisition board.

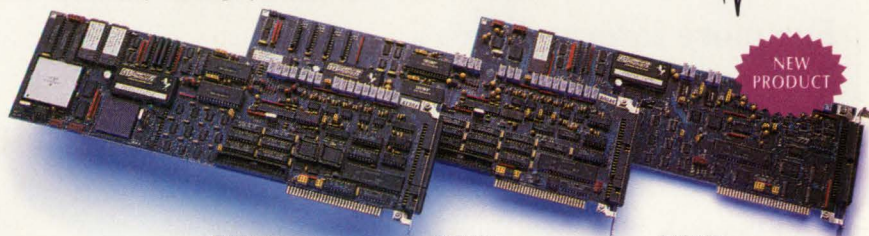

**DAP 2400:**  
The most powerful in the series, with digital signal processing.

**DAP 1200:**  
A general purpose workhorse for a variety of large applications.

**DAP 800:**  
A Data Acquisition Processor for the price of a non-intelligent board.

## Call Today for the Complete Story

For all the details about our intelligent data acquisition systems, call us today at (206) 881-4286.

Then imagine what you can do with the time you save.

### More than 100 Built-in Commands

DAPL provides more than 100 data acquisition processing commands—without programming. These include commands for averaging, scaling, peak detection, integration, thermocouple linearization, PID process control, event detection, digital filtering, and spectral analysis.

DAPL can be expanded without limit by downloading custom commands from the host PC.

### On-board RAM and Processing Power

Each Microstar Laboratories system includes on-board RAM for buffering data while the PC is performing



## MICROSTAR LABORATORIES™

2863 152nd Avenue NE  
Redmond, Washington 98052

Phone (206) 881-4286  
Fax (206) 881-5494

©1991 Microstar Laboratories, Inc. MICROSTAR LABORATORIES™, DAPL™, DAP™, DAP 800™, DAP 1200™, DAP 2400™, and Data Acquisition Processor™ are trademarks of MICROSTAR LABORATORIES, Inc.

**CALL TODAY FOR A FREE DEMO DISKETTE**



# TECHNOLOGY UPDATE

## Sensitive scope measurements

ready-acquired waveforms, including one-shot transients. By properly selecting the cutoff frequency, you can reduce noise without distorting the desired signal. Filtering also improves the resolution of the digitized signal in proportion to the reduction in bandwidth. Unlike working with an analog scope's inflexible, fixed front-end filtering, trying several different digital filters on a captured signal to determine which gives the best results is quite simple. In effect, you can adjust bandwidth after capturing the signal.

### Leave your eyeballs out of it

Digital scopes can also perform statistical analyses on sets of captured data. Such analyses provide more accurate and reproducible characterizations of random processes than eyeballed analyses of analog-scope displays.

For example, postprocessing allows you to measure jitter, a random process that often exhibits a normal distribution. Jitter has the same effect on a signal as does a lowpass filter, obscuring potentially valuable high-frequency information. With analog scopes, you can only look at jitter, not measure it. With a standard analog oscilloscope, you see jitter as an illuminated band, the brightest section corresponding to the location where the jittery edge occurs most often. A blot of lower intensities shows where the edge occurs less frequently.

With an analog oscilloscope, you typically would increase your CRT intensity until just before blooming occurs and record the limits of jitter as a peak-to-peak jitter measurement. This jitter measurement depends on how each engineer sets a scope's intensity. Consequently, such jitter measurements are not reproducible. And the intensity

may not be enough to illuminate the actual extremes of the jitter's range, yielding something less than the true peak-to-peak jitter.

Furthermore, you need to separate the scope's trigger jitter and time-base jitter from the signal's jitter. Digital postprocessing allows correcting for the scope's jitter contribution.

For example, the Tektronix DSA 600 series scopes remove jitter by sliding records backwards and forwards in time trying to make them fit over one another. The company's CSA 803 digitizing signal analyzer offers a false-color display. This display mode is analogous to a monochrome, Z-axis variable-intensity display, but shows different colors corresponding to the density of overlapped traces at each point in the display.

Now with certain digital scopes you can measure and characterize jitter. These digital scopes display

a histogram of the jitter's time distribution. From the histogram you can see if you have a normal distribution—which is ordinary noise—or if there are some peaks indicating other sources for the jitter. Using these scopes, you can get figures for your jitter and noise margins that you couldn't get before.

Digital scopes also excel over their analog siblings in triggering capability. Enhanced triggering makes capturing the one waveform you want out of a stream of similar waveforms easier. In addition to triggering on the occurrence of a signal, digital scopes can trigger on the non-occurrence of a signal, a "dropout." Modern scopes, such as the Philips/Fluke PM 3340 digital oscilloscope, now have "envelope" functions that allow you to see only out-of-bounds excursions.

Digital oscilloscopes offer an amazing array of sophisticated features, yet still rely on compara-

## For more information . . .

For more information on the oscilloscopes and probes discussed in this article, circle the appropriate numbers on the Information Retrieval Service card or use EDN's Express Request service. When you contact any of the following manufacturers directly, please let them know you saw their products in EDN.

**Hewlett-Packard Co**  
Literature Center  
19310 Pruneridge Rd  
Cupertino, CA 95014  
(800) 752-0900  
Circle No. 708

**Nicolet Instrument Corp**  
Box 4451  
Madison, WI 53711  
(608) 273-5008  
FAX (608) 273-5061  
TWX 910-286-2737  
Circle No. 711

**Tektronix Inc**  
Box 1700  
Beaverton, OR 97075  
(800) 835-9433, ext 170  
FAX (503) 641-7245  
TLX 151754  
TWX 910-467-8708  
Circle No. 714

**LeCroy Corp**  
700 Chestnut Ridge Rd  
Chestnut Ridge, NY 10977  
(914) 425-2000  
FAX (914) 425-8967  
TWX 710-577-2832  
Circle No. 709

**Philips International BV**  
T&M Dept, Bldg TQIII-4  
5600 MD Eindhoven  
The Netherlands  
TLX 35000 PHTC NL/NLFEVSI  
Circle No. 712

In Europe:  
2, rue du Pré-de-la-Fontaine  
Box 341  
1217 Meyrin 1  
Geneva, Switzerland  
(022) 719-21-11  
FAX (022) 782-39-15  
TLX 419058  
Circle No. 710

In the US:  
**John Fluke Mfg Co Inc**  
Box 9090  
Everett, WA 98206  
(206) 347-6100  
FAX (206) 356-5116  
TLX 185102  
TWX 910-445-2943  
Circle No. 713

### VOTE . . .

Please also use the Information Retrieval Service card to rate this article (circle one):

**High Interest 515**  
**Medium Interest 516**  
**Low Interest 517**



# Our Versatec plotters are years ahead of the competition.

They always have been.

And now our plotters offer another unmatched feature: the Xerox Total Satisfaction Guarantee. It guarantees your complete satisfaction for three years — three times longer than any other manufacturer. And only you decide when you're satisfied.

That's how confident we are about our entire line of plotters, including Turbo CADmate™, our affordable, high performance wide-format electrostatic plotter; the 8900 Series high performance electrostatic color plotter featuring unattended operation; and the 8836 II Laser, the industry's most popular wide-format plain paper plotter.

All Versatec plotters are covered by this exclusive guarantee. There are no catches. No fine print.

Here it is in plain English:

*"If you are not satisfied with your Xerox equipment, at your request, Xerox will replace it without charge to you with an identical model or a machine with comparable features and capabilities.*

*"This Xerox Total Satisfaction Guarantee applies to Xerox equipment acquired by you from Xerox and continuously maintained by Xerox or its authorized representatives under our Manufacturer's Warranty or a Service Contract."*

Now that's simply the best warranty you can get. No ifs, ands or buts about it. After all, you'd expect nothing less from Xerox Engineering Systems. The world's largest supplier of engineering copiers, Versatec printers and plotters.

So, for more information, call us at 800-538-6477.

In California, 800-341-6060. Or go ahead and buy your Versatec plotter today. You'll still have a few years to think it over.

## **Xerox Engineering Systems**

2710 Walsh Ave., Santa Clara, CA 95051  
Xerox is a trademark of Xerox Corporation. Versatec and Turbo CADmate are trademarks of Versatec, Inc.

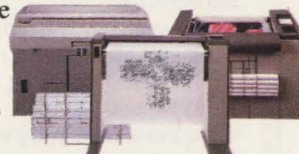

CIRCLE NO. 104

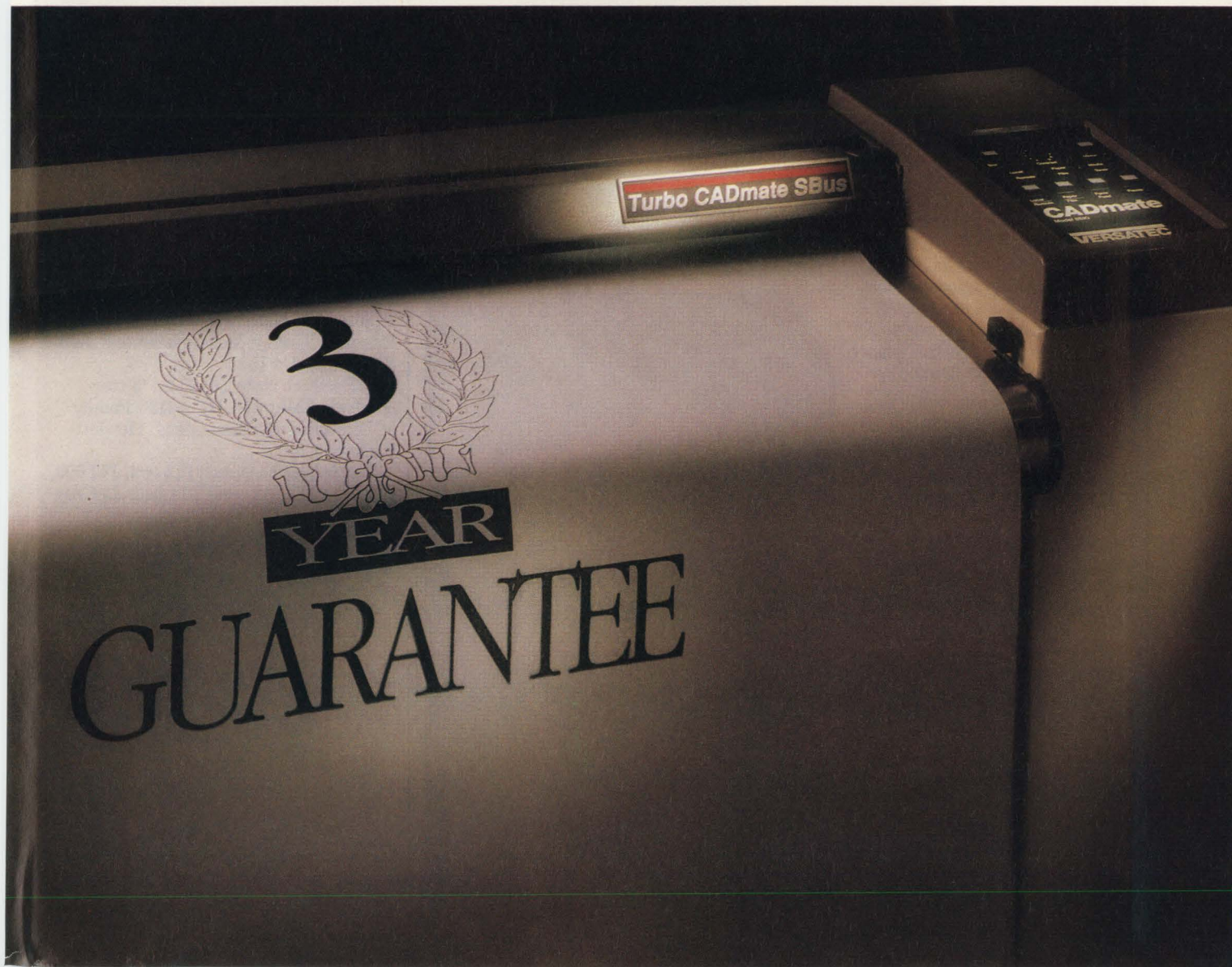



## OPTICALLY COUPLED ROTARY ENCODER SWITCHES FROM GRAYHILL

### OUTPERFORM AND OUTLAST ELECTROMECHANICALS BUT DON'T OUTCOST THEM!

#### Use affordable Grayhill Series 61 Switches to

- Move an icon on a display
- Select menu items, ranges, limits
- Set radio frequency, drill depth, RPM, etc.
- Activate data entry with integral pushbutton

Bulletin 508 describes 16 and 32 detent position Grayhill Series 61 switches with 2 Bit Quadrature Code Output and million-cycle reliability. Ask for your free copy.

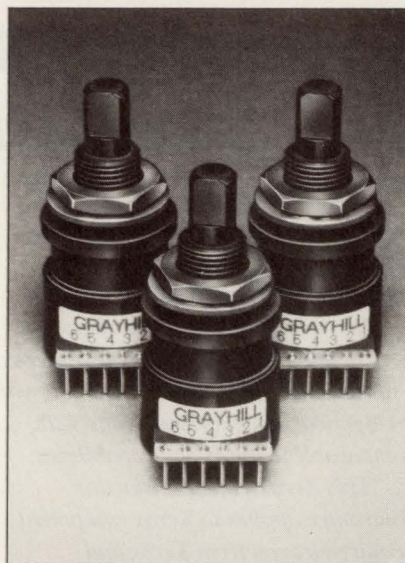

**Grayhill**  
INC.

561 Hillgrove Avenue, P.O. Box 10373  
LaGrange, Illinois 60525-0373 USA  
Phone: (708) 354-1040 FAX: (708) 354-2820  
TLX or TWX: 190254 GRAYHILL LAGE

CIRCLE NO. 8

Nobody does ferrites like DEXTER. We offer the industry's broadest selection of quality ferrites and associated hardware from world-class manufacturers. SIEMENS, MAGNETICS, FAIR-RITE, HITACHI, MMG/KRYSTINEL. From prototype quantities to production runs. From off-the-shelf to a wide range of value-added services — precision fabrication, E-core and pot-core gapping and testing, sorting and selecting by electrical specs.

Call Toll Free 1-800-345-4082 for Free Catalog and Nearest DEXTER Location

## FERRITE CORES:

THE DEXTER DIFFERENCE —  
One-Stop-Shopping for all your  
ferrite needs.



THE DEXTER CORPORATION  
ATLANTA • BOSTON • CHICAGO • DALLAS •  
LOS ANGELES • MINNEAPOLIS/ST. PAUL •  
NEW YORK • SAN FRANCISCO • TOLEDO/DETROIT •  
ENGLAND • WEST GERMANY

## OUR FIELD OF EXPERTISE

CIRCLE NO. 9

## UPDATE

### Sensitive scope measurements

tively primitive probes to acquire their information. However, you can learn how to utilize these features and compensate for probe shortfalls. Instrument and IC vendors have a wealth of free applications information to help you master oscillography. The references section following this article provides a list of some of the material available. **EDN**

### References

1. Rush, Ken, "Understand probe impedance to assess signal distortion," *EDN*, April 18, 1985, pp 247-252.
2. Hurlock, Les, "ABCs of Probes," Tektronix Inc, Jack Murdock Park, Box 3500, Vancouver, WA 98668, (800) 426-2200, ext 510. (Technical Notes and Technical Briefs, too numerous to list here, also available.)
3. Application Notes 10, 13, 40, and 43, Linear Technology Corp, 1630 McCarthy Blvd, Milpitas, CA 95035, (408) 432-1900.
4. IC Data Book, Appendix B, Burr-Brown, International Airport Industrial Park, Tucson, AZ 85734, (602) 746-1111.
5. Applications Guides "Understanding DSO Bandwidth," "DSO Analysis Power," "DSO Truth in Digitizing," and Application Note "How to Automate Complex Timing Measurements," John Fluke Mfg Co Inc.
6. Product Note 54120-2, "Jitter Analysis Using the HP 54120 Family of Digitizing Oscilloscopes," Hewlett-Packard Co.
7. Application Notes ITI 008, ITI 009, ITI 011, ITI 012, and ITI 013, LeCroy Corp.

Article Interest Quotient  
(Circle One)

High 515 Medium 516 Low 517



Fan and filters  
engineered to minimize  
dust, maximize air flow.

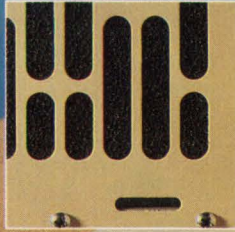

Sealed, military-type  
connectors for the  
power supply and  
video input.

Individually  
ruggedized printed  
circuit boards  
protect against  
damaging shock  
and vibration.

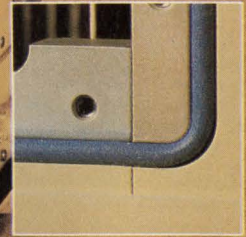
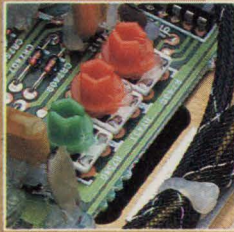

Silver impregnated  
shield gasket keeps  
moisture out and  
controls EMI.

# BUILT RUGGED FROM THE GROUND UP

## THE KMS IP-1617/U COLOR MONITOR

Now, a desert-ready rugged monitor so versatile, it can handle any C<sup>3</sup>I application. So tough, it can take it all: Shock. Vibration. Cold. Heat. Dust. Rain. And sand.

The IP-1617/U color monitor has been customized for rugged applications. Many systems are in use today with armed forces throughout the world on land, sea and in the air.

KMS products have incredibly low return-for-repair rates. And KMS support is legendary; we can handle your questions and unique engineering problems immediately.

- Advanced Flat Technology Monitor (FTM™)
- Superior Glare Resistant 14" Screen
- Full Analog Capability
- Infinite Array of Brilliant Colors
- VGA, EGA, CGA, MDA and HGC Compatible
- 640 dots x 480 Lines Resolution
- Compliant with MIL-STD-810 Environmental Tests and MIL-STD-461/462 EMI/RFI Requirements
- 90-135/200-265 VAC, 48-62 and 400 Hz, Switch Selectable
- Horizontal Scan Frequency 31.5 kHz

- 0.31 mm Dot Pitch
- Front Mounted Controls
- On/Off Circuit Breaker
- Portable or Rack-Mount
- TEMPEST Model Available

It's no wonder KMS has been the leader in rugged engineering of computer systems since 1987.

For more information on the complete line of KMS rugged computer products, call **1-800-521-1524**. In Europe, call ACAL/Technitron ISD 44 (0252) 851085.

GSA Schedule #GS00K89AGS6289

FTM is a trademark of Zenith Data Systems Corp.

**KMS Advanced Products**

700 KMS Place, Ann Arbor, MI 48106-1868 FAX: 313/769-8660

CIRCLE NO. 129



*Keeping reliability up  
as form factors go down.*



***THIS IS AMP TODAY.***

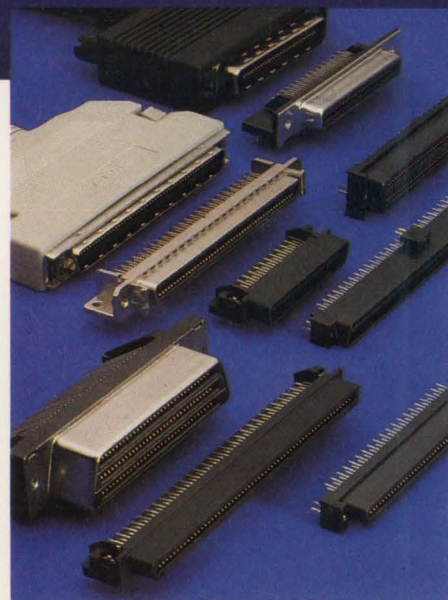

*.050 CL, leaf-contact design*



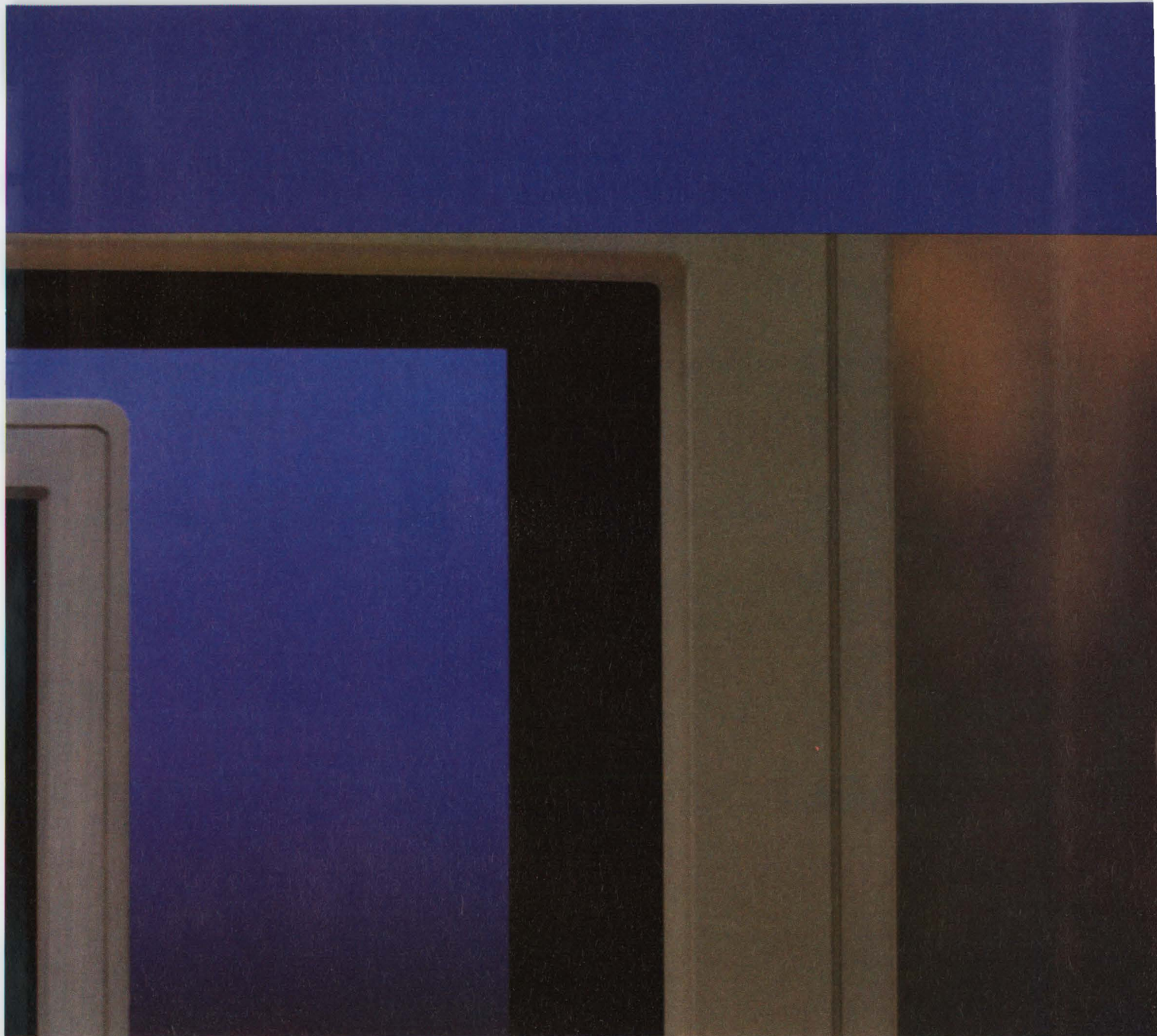

In today's tight-corner designs, reliability all too often depends on precise (and costly) manufacturing practices. Our CHAMP .050 connectors weigh in on your side with economic simplicity, and inherently tolerant contacts.

Overview: 0.050" centers, trapezoidal interface, dual-row leaf-contact design. Small, friendly, and forgiving.

Board-to-board: our proprietary compliant-receptacle, fixed-plug contact system tolerates wide mat-

ing depth variations that come with pcb warp—happy news for high-line-count designs—and offers superior performance in assembly, especially in blind-mate applications. Parallel, perpendicular, and in-line styles, 30-200 positions.

Shielded I/O: here, compliant plug and receptacle contacts take full advantage of the controlled header-to-plug interface to meet emerging global intermateability standards. Shielded receptacles and

plugs provide EMI protection. Mass IDC termination and fast braid crimp keep production rates up; AMP tooling covers your volume requirements. 14-100 positions.

The CHAMP .050 high-density line: think of it as a very big factor in small-form design. For details, call our Product Information Center toll-free at 1-800-522-6752 (fax 717-561-6110). In Canada call 416-475-6222. AMP Incorporated, Harrisburg, PA 17105-3608.

# AMP



SAMSUNG  
**NOW**

# THANKS TO OUR HIGH OF A NEW DAY IN USES

Until now, there's been no volume supplier of the leading-edge 256K CMOS EEPROM, so supplies have been short.

Samsung has changed all that. We're producing

#### SAMSUNG'S CMOS EEPROMs

Part Number	Organization	Type	Fastest Speed	Features
KM28C256	32Kx8	Parallel	150	Data polling, toggle bit, 64 page mode
KM28C64	8Kx8	Parallel	200	Data polling, 32 page mode
KM28C65	8Kx8	Parallel	200	Data polling, ready/busy
KM28C16	2Kx8	Parallel	150	Data polling, 32 page mode
KM28C17	2Kx8	Parallel	150	Data polling, ready/busy
KM93C06	16x16	Serial	—	—
KM93C07	16x16	Serial	—	Write protect, self-timed programming
KM93C46	64x16	Serial	—	Write protect, self-timed programming

Industrial grade versions of all products are available. All parts offered in both DIP and PLCC (SOIC for serial). 256K Industrial available Q4 1990, other parts all available now.

extremely high volumes, and as you can see, all kinds of new ways to use the part are turning up.

Large-memory cellular phones, and . . . well, we're sure you'll think of many other interesting things to do with them.

Also new from Samsung are parts proven for industrial temperature ranges, which means you can use them in robotics, automotive





# VOLUMES, IT'S THE DAWN FOR 256K EEPROMs.

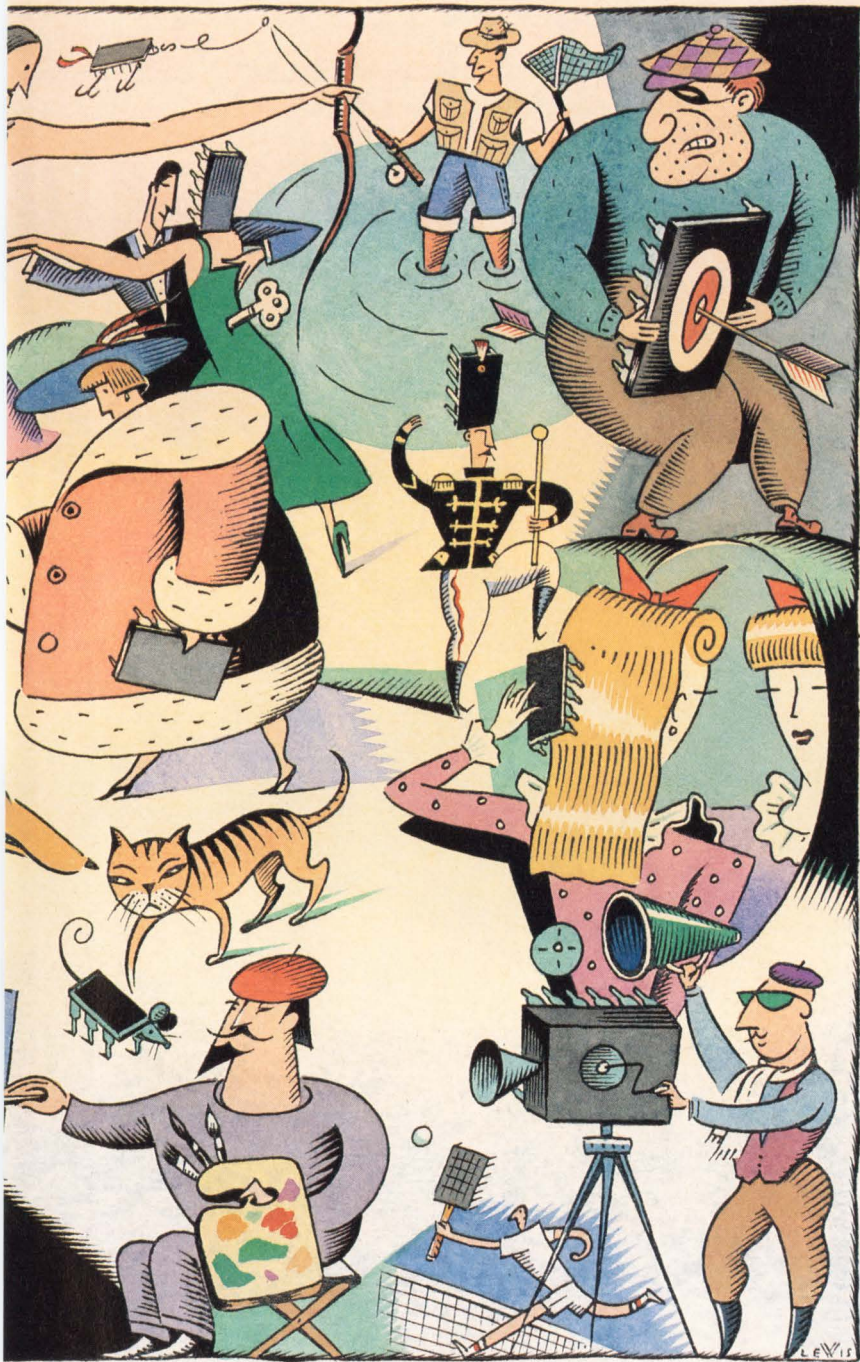

applications, industrial control and related areas.

Our 256K parts boast a fast, 5 millisecond/page write time. This gives you an effective byte write time (including erase cycle) of just 78 microseconds. And the entire chip can be rewritten in only 2.5 seconds.

What all these things represent is a broad-based commitment at Samsung to EEPROMs. We also offer CMOS 64K and 16K parts, a variety of serial EEPROMs, and forthcoming higher-density serial parts.

Surface mount packaging is available across the entire line.

Request a comprehensive Samsung EEPROM Quality Kit, including samples, by calling 1-800-669-5400 or 408-954-7229 now. Or write to EEPROM Marketing, Samsung Semiconductor, 3725 No. First St., San Jose, CA 95134.

And start planning your *own* new uses.



© Samsung Semiconductor, Inc., 1990.





# Fasten Your Seat Belt... Token Ring Accelerates to 16 Mbps.

## Two New SBE 16 Mbps Controllers Bring High-Speed Token Ring to VMEbus/Multibus Systems.

One advantage of Token Ring is that it provides an efficient, high-performance interconnect with IBM mainframes. In a multinodal LAN environment, Token Ring provides *four times the throughput of Ethernet.*

SBE delivers high-performance Token Ring with two new intelligent 16 Mbps communications controllers that interface VMEbus/Multibus Systems with Token Ring LANs.

SBE's Token Ring Controllers include these features:

- Software-selectable interface for 4 or 16 Mbps.
- High-speed, on-board 32-bit 68020/68030 25MHz processors.
- 1 MB or 4 MB of DRAM.
- Support for IEEE 802.5 standards.

Turn to SBE and discover the difference these new 16 Mbps VMEbus/Multibus Controllers can make in your LAN application.

*For fast action, call: 1-800-347-COMM.*

*SBE, Inc., 2400 Bisso Lane, Concord, CA 94520*

**SBE**  
Communications &  
Real-time Solutions



## FIBER-OPTIC PRESENCE SENSORS

# Devices survive harsh environments

Because fiber-optic sensors are mainly passive devices, they are more reliable than traditional mechanical or electronic sensing devices—especially in the hostile world of industrial electronics.

**Tom Ormond,**  
Senior Editor

**F**iber-optic presence and color sensors have sensor tips as narrow as a human hair and can withstand hostile environments including extreme shock and vibration, moisture, heat, and chemicals. They have no moving parts, which can wear out, and so are more reliable and more flexible than traditional copper-wire sensors. In addition, fiber-optic sensors can function in all standard photoelectric sensing configurations (see box, "A primer on fiber-optic sensing modes").

Optical fibers have bandwidths in the megahertz range. As a result, you can multiplex many sensing elements onto a single fiber to form a sensor network distributed in space. This capability lets you use a single fiber to simultaneously

measure several hundred points. To match the information-carrying capacity of a single fiber, a cable with copper wire would have to be more than 200 times as thick.

Signal attenuation over distance is much lower in an optical fiber than it is in a copper wire. Lower attenuation increases the distortion-free transmission distance for an optical-based sensing system. Optical fiber is a dielectric, so it is not susceptible to electromagnetic waves. Fibers do not transmit electrical signals, so you don't have to worry about sparking.

Glass fibers can handle temperature extremes ranging from subzero to several hundred degrees Celsius with no problem. Glass fibers also resist attack from corrosive or toxic atmospheres that

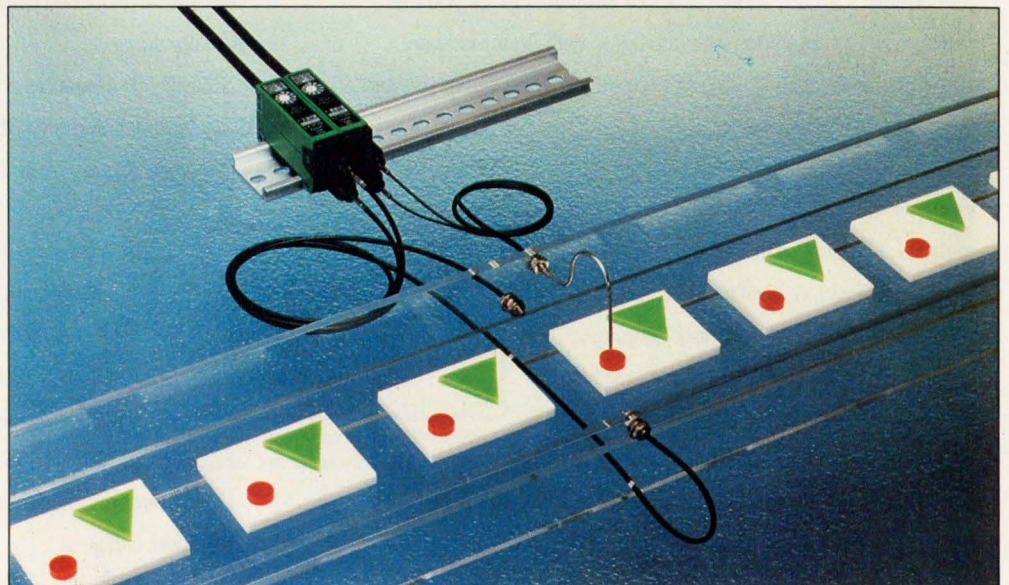

Featuring response times of 0.015 to 1 msec, Ramco Electric's FX sensors can operate in both the diffuse and opposed sensing modes. The sensors operate with a single supply voltage of 12 to 24V, mount on a 35-mm DIN rail, and have an npn transistor output.







# TECHNOLOGY UPDATE

## Fiber-optic presence sensors

would devastate metals. (Plastic fibers would have the same problems as metals in the aforementioned environments.) Fiber-optic sensors can interface with remotely located control electronics via a fiber-optic data link.

### The numbers tell the story

Table 1 lists parameters for a sampling of fiber-optic presence sensors. The slowest sensor response time is 10 msec. Aromat's MQ-F sensors can detect targets as small as 0.0020 in. All the units in the table function with plastic fiber, which is less expensive than glass fiber and easier to terminate. In fact, Aromat supplies a plastic-fiber cutter with each of its MQ-F sensors.

Fiber-optic sensors operate from a single supply voltage and produce dc outputs that can interface directly with logic circuitry, relays, or programmable controllers. The sensors from Aromat, Omron, and Opcon can function in light- or dark-detection modes, so they can serve as either presence or absence sensors. Omron offers separate presence and absence sensors; Aromat and Opcon sensors have an integral switch that lets users configure a single sensor for either presence or absence detection.

Industrial environments can be

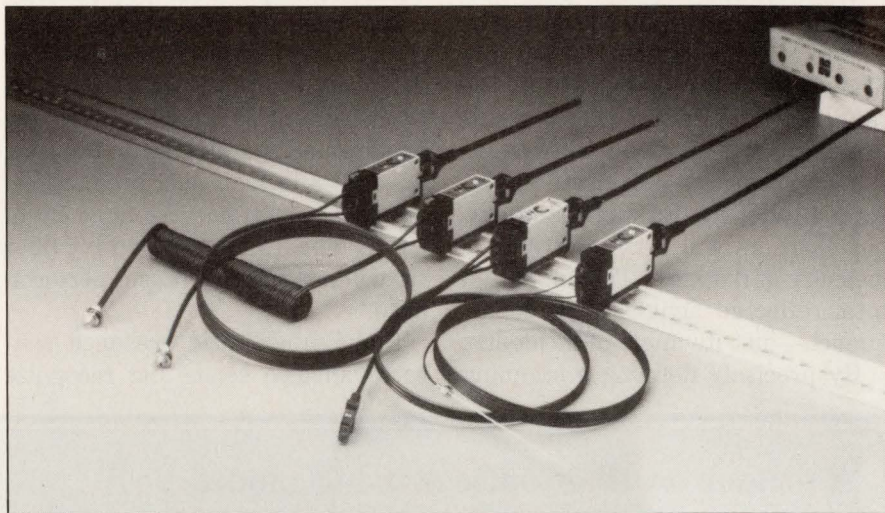

A speed of 1000 operations/sec suits Aromat's MQ-F sensors for high-speed, small-piece part-detection applications. The sensors can detect objects as small as 0.002-in. wide and can mount in a panel or on a DIN rail.

rough on optical sensors whose operation is based on light intensity. A change in target color or reflectivity, a dirty lens, or movement in the target background can degrade sensor performance. To circumvent such problems, Aromat employs triple-beam technology in its MQ-F fiber-optic sensors to accurately define a scanning-distance window.

The sensor employs three fibers. One fiber operates as a transmitter; the other two function as receivers. The transmit fiber sends the LED's beam to the prospective target. The two receiver fibers capture the light

reflecting back from the target to the sensor. The fibers guide the reflected light to two PIN photodiodes. These diodes generate a current that is a function of the received light. The MQ-F sensors use the diode output current ratio to determine the target's distance.

The receiver optical system comprises an aspherical lens and the two fibers. The system reacts to the angle of the incoming light rather than the intensity of the light. The angle at which the reflected light exits the receiver fibers varies as a function of target distance. Thus, the light will be hitting each of the

Table 1—Representative fiber-optic sensors

Manufacturer	Model	Detection modes	Detection range (cm)	Fiber type	Response time (msec)	Minimum target size	Operating range (°C)	Price
Aromat Corp	MQ-F	Diffuse, reflective	1.5 to 12.0	Plastic	0.5	0.002 in.	-40 to +70	\$75 (100)
Omron Electronics Inc	EE-SPZ	Retroreflective	0.8*	Plastic	10.0	0.59 x 0.59 in.	-10 to +55	\$46
Opcon Inc	Comet 100	Proximity	0.76	Plastic	2 to 8	0.020 in.	-40 to +70	\$80 to \$110
		Opposed	2.95					
Ramco Electric Co	FX	Diffuse	5	Plastic, glass	0.015	15µm	-40 to +70 (plastic)	\$30 to \$394
		Opposed	350				-20 to +300 (glass)	

\* Nominal value for a 60-cm length of fiber.



# TECHNOLOGY UPDATE

## Fiber-optic presence sensors

PIN diodes at a different spot, causing the diode output to vary. For example, for a distant target, the first diode will receive most of the reflected light; when the target is close, the second diode will receive the major portion of reflected light. As a result, the ratio of diode output currents will vary strictly as a measure of distance. The amount of total reflected light is of no consequence—just its angle of incidence.

By precisely defining a scanning

window, triple-beam technology takes away all target-color, reflectivity, and shape considerations. And because MQ-F sensors let you predetermine the sensing window, background movements and objects have no effect on measurement accuracy. In fact, because light intensity is immaterial, even a dirty fiber tip will not degrade sensor performance.

Some fiber-optic presence sensors can also sense and recognize

color. These devices suit such applications as label differentiation and sorting color-coded parts, bottles, cans, or foods and can be a cost-effective alternative to an off-line color lab. CRS 300/301 Series sensors (\$8000) from Micro Switch can be programmed to recognize as many as eight colors and use the 400- to 800-nm visible light spectrum to characterize colors.

CRS sensors use a halogen light source to illuminate the target. This

## A primer on fiber-optic sensing modes

Photoelectric sensors operate in one of three modes—opposed, retroreflective, or proximity. The proximity mode includes several submodes: diffuse, divergent-beam, convergent-beam, and background suppression.

Opposed-mode, or through-beam, sensors have the emitter and receiver opposite each other. The emitter aims its optical beam directly at the receiver. The sensor detects an object when the object interrupts the beam between the two components.

In retroreflective sensors, the emitter and receiver are adjacent to each other. The emitter sends out a light beam at a reflector, and the receiver detects the reflected light. Retroreflective sensors detect an object when the object interrupts the light beam.

A proximity sensor detects objects by sensing the amount of its own transmitted energy that reflects back from the surface of the target object. Both the emitter and receiver are on the same side of the target object and are usually located in a single housing. An object, when present, establishes the beam.

Diffuse-mode sensors are probably the most popular type of proximity sensor. In these sensors, the light from the emitter strikes the target surface at an arbitrary angle and diffuses off the surface at many angles. This operating mode is not very efficient because the receiver looks for only a small amount of the light reflecting back from the target. Also, diffuse-mode sensors (as well as all other types of proximity sensors) are heavily influenced by the reflectivity of the target's surface. A diffuse-mode proximity sensor will have a greater sensing range for a target with a bright white surface than it

will have for a target with a dull black surface.

Short-range unlensed divergent-beam proximity sensors suit applications in which you have to avoid the effects of signal loss from shiny objects. The lack of a lens shortens the usable sensing range, but these sensors are much less dependent than diffuse-mode sensors on the incident angle at which their light beam strikes the target that is within range. Target size also influences the performance of divergent-beam sensors—more energy will return from large targets. However, divergent-beam sensors respond better than diffuse-mode sensors to objects that are very close to the sensing tip.

Convergent-beam proximity sensors use a lens system that focuses the emitted light at an exact point in front of the sensor. These units focus the receiver element at the same point. This design establishes an intense, well-defined sensing area at a fixed distance from the sensor lens. The technique is quite efficient. Convergent-beam sensors can readily sense small targets. They can also sense materials that have reflectivity levels too low to be detected by diffuse-mode or divergent-beam sensors.

The background-suppression sensor rounds out the list of proximity sensor types. These devices simply ignore objects that lie beyond their sensing range. The background-suppression sensor compares the amount of reflected light that each of its two optoelements receives. These sensors recognize a target if the light level reaching the base receiver equals or exceeds the light level reaching the other receiver. The sensor does not develop an output when the light arriving at the second receiver exceeds the light level reaching the base receiver.





**WHEN PRESSURE SENSOR PERFORMANCE  
IS CRITICAL, WE DELIVER.**

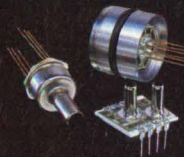

Helping your products to operate at their peak requires the best micromachined sensors available. But even the best sensors are useless unless they arrive on time. IC Sensors has been on the cutting edge of micromachining technology for over nine years. This allows us to provide OEM's with high quality sensors and service, on time. IC Sensors also has the most extensive product line, including HIT, TO-8, Surface Mount and ISO-Diaphragm sensors, used in such diverse industries as process control, medical and aerospace. So, when pressure sensor performance is critical, call the industry leader, IC Sensors. We deliver. 1701 McCarthy Blvd., Milpitas, CA 95035, (800) 767-1888. FAX (408) 434-7322. **IC SENSORS**



# TECHNOLOGY UPDATE

## Fiber-optic presence sensors

source light travels over the emitter portion of the fiber-optic cable and provides a uniform white light that permits accurate and repeatable color sensing. The light reflects off the target and travels back to the sensor through the receiver portion of the fiber-optic cable.

The light returning from the target then reflects off an internal diffraction grating. The grating breaks the light into a color spectrum, which shines onto an array of 128 photodiodes. These diodes sense the intensity of the light for the different colors in the spectrum. The array, in essence, converts the light-intensity pattern into a unique data set that represents a signature for the target color.

The microprocessor in the CRS sensor compares the incoming color signature data to signatures it has

stored in memory. When it detects a match, the processor turns on the appropriate output. The standard CRS unit has a 0.1- to 2-in. sensing distance range. It has eight digital outputs, one for each of its color channels. These outputs can be either current sinking or current sourcing and can drive as much as 600 mA. You can use onboard switches or menu-driven software to configure the outputs. The sensor can also transfer data over its RS-232C or RS-485 serial ports.

A 10.5 to 30V, 47W supply provides operating power for the CRS 300/301. Reverse-polarity protection is standard, and the operating range is 0 to 40°C. The sensor is housed in an aluminum enclosure that provides NEMA 1, 3, 4, 12, 13, IP65, and IP67 protection.

In addition to accurately monitor-

ing the performance of an industrial processing system, fiber-optic sensors can simplify the task of actually controlling the flow of a process. Photoelectric sensors with analog outputs are especially useful in process-control and similar applications in which monitoring an object's relative position or size is necessary to produce a continuously variable voltage output. You can also use analog-output sensors to monitor the optical reflectivity or optical clarity of materials.

Banner Engineering's Omni-Beam sensors (\$187 to \$300) are an example of analog-output fiber-optic sensors. By properly designing the sensing-end tip of the plastic or glass fiber, you can maximize the analog response. You can monitor the linear or angular displacement between two surfaces by operating



LET YOUR IMAGINATION GO WILD...



# TECHNOLOGY UPDATE

the sensors in the opposed mode. You can also use this mode to measure the width of an object as a percentage of the beam blocked by the object. Opposed-mode sensors can look through a transparent or translucent material to monitor optical clarity. You can monitor the reflective characteristics of a material by using the vendor's bifurcated fiber assemblies. Custom-designed fiber assemblies can yield distance measurements as precise as a thousandth of an inch.

The sensors provide a variable dc voltage output that is directly related (noninverting output) or inversely related (inverting output) to the strength of the light signal the sensor receives. When you properly adjust the sensor, the two analog outputs are mirror images of each other and the output-voltage

## For more information . . .

For more information on the fiber-optic sensors discussed in this article, circle the appropriate numbers on the Information Retrieval Service card or use EDN's Express Request service. When you contact any of the following manufacturers directly, please let them know you saw their products in EDN.

**Aromat Corp**  
629 Central Ave  
New Providence, NJ 07974  
(908) 464-3550  
FAX (908) 464-8513  
Circle No. 715

**Micro Switch**  
11 W Spring St  
Freeport, IL 61032  
(815) 235-6600  
Circle No. 717

**Opcon Inc**  
720 80th St SW  
Everett, WA 98203  
(206) 353-0900  
FAX (206) 347-0544  
Circle No. 719

**Banner Engineering Corp**  
9714 10th Ave N  
Minneapolis, MN 55441  
(612) 544-3164  
FAX (612) 544-3573  
Circle No. 716

**Omron Electronics Inc**  
1 E Commerce Dr  
Schaumburg, IL 60173  
(708) 843-7900  
FAX (708) 843-7787  
Circle No. 718

**Ramco Electric Co**  
Box 65310  
West Des Moines, IA 50265  
(515) 225-6933  
FAX (515) 225-0063  
Circle No. 720

## VOTE . . .

Please also use the Information Retrieval Service card to rate this article (circle one)

High Interest 506 Medium Interest 507 Low Interest 508

You've got the designs. And now the only thing standing between you and successfully bringing those designs to market are your suppliers.

Fortunately when it comes to capacitors, Nichicon has removed that hurdle.

With the widest selection of quality capacitor designs. With expanded production capabilities that assure quality performance and deliverability. With responsive customer service that's repeatedly proven Nichicon is ready to meet

## AND STILL GET TO MARKET ON TIME.

your needs with just-in-time delivery capabilities, dock-to-stock quality assurance programs and answers to your questions in a single call.

Call your local Nichicon representative or distributor today for your free copy of the latest Nichicon Product Catalog. We'll help you get your designs to market...on time and within budget.

**nichicon**<sup>®</sup>  
The capacitor choice.

708-843-7500 • FAX 708-843-2798





# HOW TO MAKE ANY DRIVE BE DIGITALLY PRECISE.



Pick a drive. AC, DC, servo or clutch. The M-Trim Universal Digital Speed Controller can replace its speed pot, giving you stand-alone accuracy within 0.01%. With zero error in the follower mode. Even more complex, multi-motor systems can be coordinated with the M-Trim.

Diagnostics are as easy as dialing a telephone. And M-Trim's RS-422 port and direct-access programming can link with your application's computers. Call 1 800 FIC-4411. Or write: Fenner, 8900 Zachary Lane North, P.O. Box 9000, Maple Grove, MN 55369. Fax: 612 424-8734.

## Fenner

©1989 Fenner Industrial Controls

CIRCLE NO. 23

## MORE IN THE SERIES OF DESIGN ADVANTAGES

# LOGIC

THE SHORTEST CONNECTION BETWEEN IDEA AND SILICON!

### Design Advantage #2

#### DESIGN VERIFICATION

Functional Design Verifier provides a waveform simulator that allows you to interactively confirm the behavior of the design *before* deciding on device or technology to be used.

### Design Advantage #9

#### VHDL SYNTHESIS

Our optional VHDL Synthesis tool not only allows you to combine your behavioral *and* hardware descriptions, but also gives you *automatic state assignment and state reduction!*

Contact ISDATA 1-800-777-1202 for complete details on these and other design advantages of LOG/iC.

Design tools that take your functional descriptions for optimal implementation into semicustom ASICs from PLDs to Gate Arrays.

**ISDATA**™  
INCORPORATED

800 AIRPORT RD.  
MONTEREY, CA  
93940  
408 373-7359

## UPDATE

### Fiber-optic presence sensors

waveforms intersect at 5V. Each sensor has multiturn null and span controls that set the minimum and maximum limits of the sensor's sourcing-voltage outputs. Proprietary circuitry lets you make null and span adjustments without encountering interaction problems. A 10-element moving-dot LED array provides a visual indication of the relative light-signal change and power-block voltage output to within the nearest volt.

Omni-Beam sensors consist of two basic building blocks: a sensor head and a power block. The sensor heads contain optical components, an analog amplifier, the null and span adjustment controls, and LED-indicator-array circuitry. The fiber-optic sensor heads are available in versions for both diffuse and opposed sensing applications. Sensor-head types include infrared- and visible-light glass-fiber models as well as a visible-light, plastic-fiber model. The power block contains power-supply and analog-voltage-output circuitry. These blocks are available in three models: OBPT3 for 15 to 30V dc, OPBA3 for 105 to 130V ac, and OPBB3 for 210 to 250V ac.

As factory and process-automation requirements become more demanding, the need for reliable sensors will increase. Fiber-optic sensors will be able to satisfy these sensing needs. They can handle a large amount of data, transmit data over longer distances than traditional copper-wire sensors, overcome EMI/RFI problems, and handle the harshest industrial environments. **EDN**

Article Interest Quotient  
(Circle One)

High 506 Medium 507 Low 508



# Sampling A/Ds

There's  
only one  
complete  
source.

No matter what your requirement, you will find the answer in DATEL's broad line of Sampling Analog-to-Digital Converters.

Fast becoming  
the industry standard

Characterized through Nyquist operation, these converters offer superior Signal-to-Noise ratios and harmonic distortion specifications.

Bottom line, compare these converters with any competitive units, and you'll see there is no reason to look anywhere else.

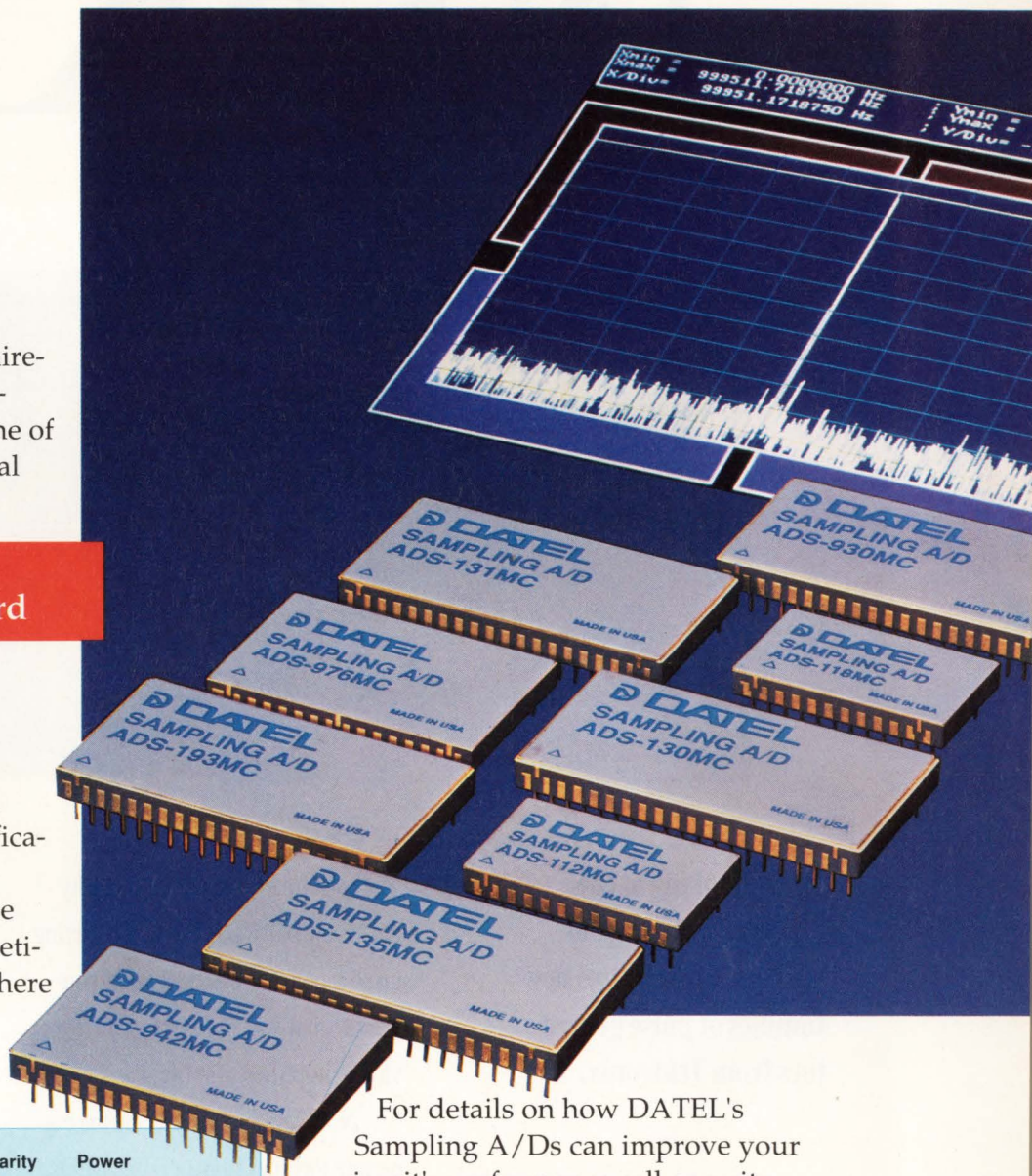

Model	Bits	Throughput (MHz)	Linearity (LSB)	Power (Watts)	Case
ADS-111	12	0.500	±1/2	1.3	24-PIN
ADS-193	12	1.0	±1/2	1.3	40-PIN
ADS-112	12	1.0	±1/2	1.3	24-PIN
ADS-117	12	2.0	±3/4	1.4	24-PIN
ADS-132	12	2.0	±1/2	2.9	32-PIN
ADS-118	12	5.0	±3/4	2.3	24-PIN
ADS-131	12	5.0	±3/4	3.8	40-PIN
ADS-130	12	10.0	±3/4	4.0	40-PIN
ADS-924	14	0.300	±1	1.3	24-PIN
ADS-928	14	0.500	±1/2	2.9	32-PIN
ADS-941	14	1.0	±3/4	3.1	32-PIN
ADS-942	14	2.0	±3/4	3.2	32-PIN
ADS-976	16	0.200	±2	0.9	32-PIN
ADS-930	16	0.500	±1 1/2	1.8	40-PIN

For details on how DATEL's Sampling A/Ds can improve your circuit's performance call or write DATEL, Inc., 11 Cabot Boulevard, Mansfield, MA 02048.

**Let DATEL convert you.**  
Call now 800-233-2765

**DATEL**

INNOVATION AND EXCELLENCE IN PRECISION DATA ACQUISITION  
DATEL, Inc., 11 Cabot Boulevard, Mansfield, MA 02048 (508) 339-3000



# Making

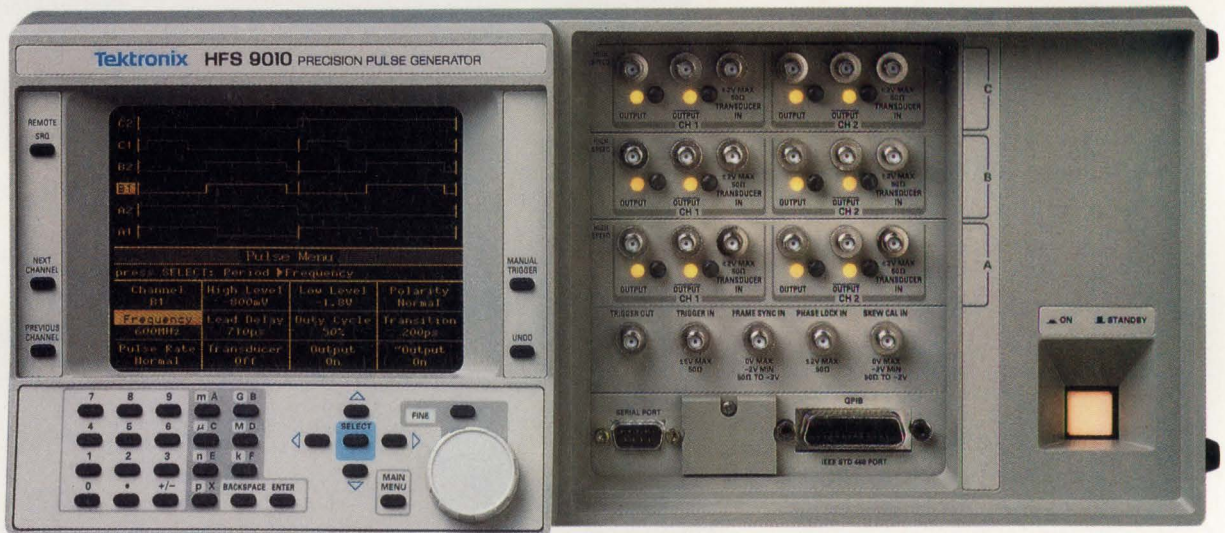

**You're looking at the biggest news in signal sources in years: two new families of pulse generators from Tektronix.**

You can already see one reason why Tek's new pulse generators are stirring up so much interest: their what-you-see-is-what-you-get user interface vastly simplifies your life.

Now you can stop piecing the big picture together from one-line LEDs, blinking error lights and trial-and-error iteration. Tek's new scope-like display lets you set up and modify a whole set of parameters at once, with a true representation of your pulses

and instant, visual feedback.

**You name your application and logic technology: Tek has a signal source to match.** For the first time, you can choose channel capacities from one to six channels, or rep rates from 50 MHz to a remarkable 600 MHz. Choose tools designed for logic, fast logic, or *mixed* technologies. Vary transition times from 200 ps to 10 ms. Test complex timing relationships with ease.

Add to all this our popular pulse generator plug-ins from Tek TM500/



# Waves.

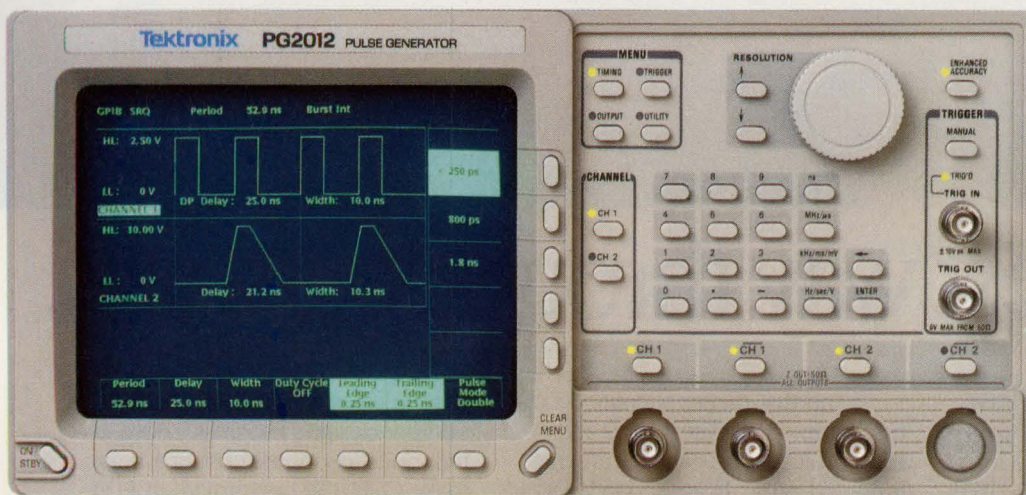

5000 modular instrumentation, and you can see why we're making waves!

Easier to use, more precise and more expandable, Tek's new pulse generators are doing for signal sources what DSOs have done for measurements.

Contact your Tek sales office for a demonstration, or call for more information.

1-800-426-2200

<p>6 PG2010</p> <p>7 PG2012</p> <p>2 PG2011</p> <p>1 PG5110</p>	<p>4 HFS 9010</p> <p>5 HFS 9030</p> <p>3 HFS 9020</p>	<p>FAST LOGIC (<math>&lt; 7</math>ns transitions) ECL, ECLinPS, Sony ECL, GaAs</p> <p>LOGIC (<math>\geq 7</math>ns transitions) TTL, CMOS</p>
MODULES & ASSEMBLIES	COMPONENTS	

One company measures up.

**Tektronix**  
COMMITTED TO EXCELLENCE





© 1986, Personal CAD Systems, Inc.

# The fastest way through customs.

## THE PLD DESIGN LANGUAGE WITH SOMETHING TO DECLARE.

You've probably heard about the advantages of programmable logic devices (PLD's) over conventional TTL. In design flexibility, for example. Or increased functional density. Perhaps you've learned the hard way: a competitor using PLD's has beaten you to market with a new product.

What you may *not* have heard, though, is that just switching to PLD's isn't enough. You've got to choose the right PLD design language, too.

### FREEDOM OF CHOICE.

CUPL™ is the one language you can apply to any PLD design. Whatever your PLD device. Whatever your programmer. Whatever your design workstation. And whatever form of design expression you choose. With CUPL, you can even write a logic specification for a PLD before you decide on the target device.

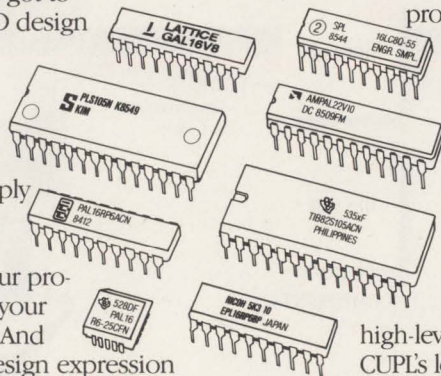

And that means simplified training. Common data structures and design rules. Consistent documentation and testing. Instant adaptability to new devices. The productivity gains with CUPL just keep mounting. In the design cycle. And in production.

### POWER TOOL.

CUPL is the most powerful high-level design language for PLD's. It incorporates features like macro substitution, free-form comments, indexed variables and parenthetical capability, to speed program development.

CUPL provides superior state machine capability, and supports all popular models of logic description, including truth tables and high-level equations.

CUPL's logic minimizers (3 are supplied), and deMorgan expansion capability are unequalled.

And CUPL's documentation out-

put file gives you invaluable feedback on your design's progress. These features, plus continual enhancements, make CUPL the benchmark in PLD design languages — flexible and powerful enough for the most sophisticated logic designer's needs.

Now available from Logical Devices, the new version CUPL 4.0 for MS-DOS, VAX-VMS, UNIX C, SUN, APOLLO, and, soon to be announced, for the Apple Mac II Systems.

**Also available from Logical Devices, a full line of PROM/PLD programmers.**

## CUPL™

### LOGICAL DEVICES, INC.

1201 NW 65th Place  
Fort Lauderdale, Florida 33309

Toll Free: 800-331-7766

In Florida: (305) 974-0967

Telex: 383142

Fax: (305) 974-8531

Booth #2352 at Electro '91



# Synthesis tools speed PLD design efforts

PLD design tools have moved beyond the compiler approach to offer design synthesis capability. You provide a high-level design description, and the tool does the rest.

*Richard A Quinnell,  
Regional Editor*

As time-to-market pressure increases, designers' need for productivity aids is growing. Logic synthesis tools for PLDs are meeting that need. First introduced three years ago, the tools are still evolving, increasing their efficiency and expanding beyond PLDs to encompass FPGAs (field-programmable gate arrays) and other gate arrays. These tools now allow you to describe your design using whatever form is most convenient for you. They then optimize your design and automatically offer you a selection of the best parts for implementing that design.

As logic synthesis tools have evolved, vendors have shown that they differ in what they mean by logic synthesis. The simplest definition, following the model developed by Gajski and Kuhn (Ref 1), is that logic synthesis translates a behavioral design description to a structural one. In the case of simple PLDs, the translation would convert Boolean equations to fusesmaps.

While some vendors still use that definition, most consider synthesis to include refining higher-level design descriptions and optimizing circuits. Some stretch the definition of logic synthesis to include automatic partitioning of a design into multiple devices.

PLD synthesis tools' ability to optimize logic carries many advantages. The foremost advantage for today's accelerated

engineering schedules is reduction of time to market. Once you've defined the function, the tools perform the tedious and error-prone optimization process orders of magnitude faster than humanly possible. Though the tools are by no means perfect, (see **box**, PLD synthesis: not a push-button solution) the time they save outweighs their limitations for most applications.

## Finding the best solution

PLD synthesis tools also help you reach a good design quickly by allowing you to avoid making early decisions about implementation details. Using these tools, you can quickly adapt your high-level design to a variety of parts and technologies, then you can evaluate the results. Thus, you choose the best part for your application after your design is complete, instead of having to guess what's best (perhaps wrongly) be-

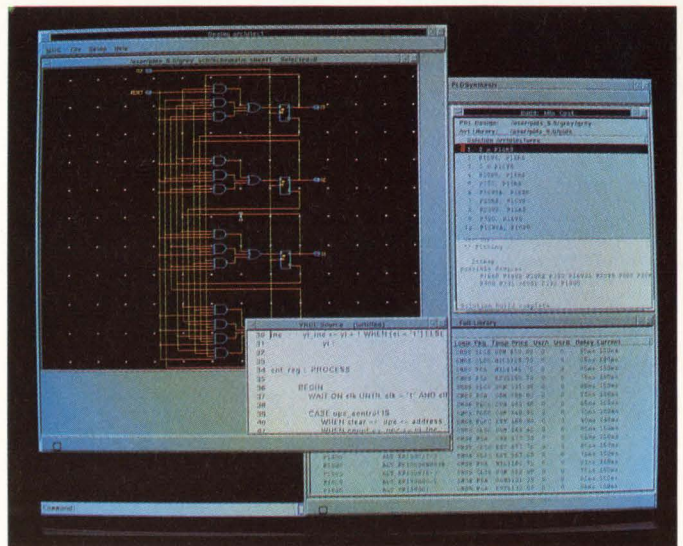

*Offering design entry techniques from VHDL to schematic, tools such as Mentor Graphic's PLDSynthesis allow you to focus on function, not implementation.*



# Count On IDT

## The R3001 RISController™: The Embedded Processing Solution

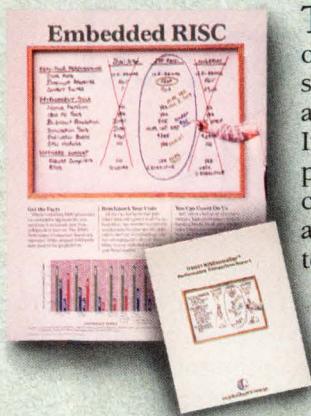

The R3001 is the first derivative of the R3000 processor designed specifically for embedded control applications. Compared to the Intel 960 and AMD 29K processors, the R3001 is the most cost-effective solution for these applications—we have the data to prove it! Call and ask for **KIT CODE 0091A** to get an **R3001 Performance Comparison Report**.

## BiCEMOS™ ECL SRAMs: Technology for the '90s

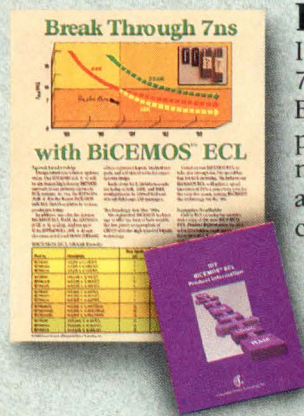

Design the fastest systems with IDT's BiCEMOS ECL family. At 7ns, the IDT10494 is the fastest BiCEMOS 64K ECL SRAM in production. 256K and synchronous self-timed SRAMs are also available in 10K/100K/101K configurations. Call and ask for **KIT CODE 0091B** to get a copy of the **BiCEMOS ECL Product Information** booklet.

## FCT-T Logic: Fastest Speed/ Lowest Ground Bounce



IDT's FCT-T Logic Family is the fastest logic family available and has the lowest ground bounce—up to 40% less than previous FCT devices! The FCT-T family provides direct TTL logic compatibility and is available in FCT, FCT-AT, and FCT-CT speeds. Call today for **KIT CODE 0091C** and get a copy of the **High-Speed CMOS Logic Design Guide**.

## The SyncFIFO™ Family: Double Your FIFO Performance



SyncFIFOs offer leading-edge performance that is 50% faster than other FIFOs. The synchronous architecture is easy to implement and reduces chip count 9-to-1. SyncFIFOs have 18-bit buses and are ideal for 32-bit systems. Ask for **KIT CODE 0091D** to get **AN-60: Designing with the IDT SyncFIFO™**.

## IDT Subsystem Modules: Building Blocks for the '90s

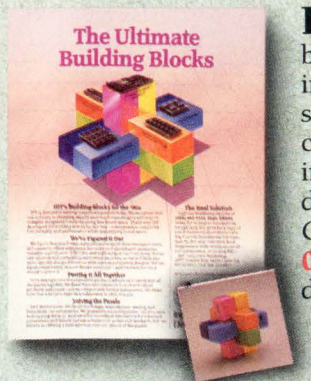

IDT offers a complete line of board-level subsystem products, including cache memory, shared-port memory, writable control store, RISC CPU, high integration modules, and custom designs for specific applications. Call today for **KIT CODE 0091E** and receive technical data and a **free IDT puzzle!**

## 12ns Cache Tag SRAMs: Wait No Longer



IDT's cache tag SRAMs have the features you want to design in: single-pin block reset, totem-pole match output, 4K and 8K depths, industry standard pinouts, and an on-board comparator to simplify design. Call and ask for **KIT CODE 0091F** to get **free samples** of the IDT6178 cache tag.

RISController, BiCEMOS, and SyncFIFO are trademarks of Integrated Device Technology, Inc. The IDT logo is a registered trademark of Integrated Device Technology, Inc.

Contact us today to receive data sheets and other design information on IDT's products.

**(800) 345-7015**  
**FAX: 408-492-8454**

3236 Scott Boulevard, P.O. Box 58015, Santa Clara, CA 95052-8015

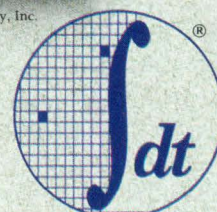

When cost-effective performance counts

Integrated  
Device Technology, Inc.



# TECHNOLOGY UPDATE

## PLD logic synthesis tools

fore beginning. A list of representative tools appears in **Table 1**.

Working with synthesis tools requires a design methodology that's different from methodologies used with earlier PLD tools. Early PLD tools operated like assembly-language compilers, taking your design description and converting it to a device-specific programming file. As with assembly language, you had to choose the target device before beginning design.

### Choose parts last, not first

Today's synthesis tools invert the process, leaving the choosing-parts phase until close to the end of the design effort. Now you begin by describing your design in whatever form is most convenient for you. With most tools, you can choose from Boolean equations, truth tables, schematics, state-machine algorithms, and hardware description

languages (HDLs) for the description. Tools based on Minc's technology also let you describe your design in terms of its waveforms.

Next, the tools allow you to verify that your design functions as you expected. The functional verification uses unit delays for timing, so you won't find any timing problems at this stage. You can, however, make sure that sequencing is correct.

Stand-alone synthesis tools, such as Data I/O's Abel, Isdata's Log/IC, and Minc's PLDesigner, verify only your PLD designs. When you use tools that have been integrated with a complete CAD package, however, you can extend verification to include simulated interaction with the rest of your circuit board. Cadence, Dazix/Intergraph, Mentor, and Valid have all incorporated one or more of the stand-alone tools into their systems.

Once you confirm that your design is functionally correct, the synthesis tools pick up steam. They can automatically perform a series of operations designed to reduce your design to its essentials. These operations include expanding negated compound equations into simple terms using DeMorgan's rules, eliminating redundant terms in each output signal, and combining terms common to a group of signals.

The circuit optimization techniques provided were once distinguishing features among the various synthesis tools. Revisions issued during the last six months have all but erased the distinctions. Two features that used to differentiate the tools, and that are included now in most of the revisions, are automatic output polarity selection and the use of "don't care" states in truth tables. These features allow the tools to reduce circuit com-

## PLD synthesis: not a push-button solution

Despite the improvements made in PLD synthesis tools during the last three years, you cannot simply set them to work and accept the results. The tools still require a designer's insight to yield the best circuit.

For example, the tools won't produce as compact and fast a design as a knowledgeable engineer can. Synthesis tool vendors consider a synthesized design that achieves 80 to 90% of human performance to be standard. Even then, the efficiency of the tools varies with the type of design.

Algorithms that optimize state-machine designs, for example, are well developed, nearly matching human skills. When dealing with complex designs, the tools may find solutions even the experts miss. Designs that are unstructured or are register-intensive, on the other hand, are hard for synthesis tools to fit into PLDs. Logic with multiple levels is equally difficult, and asynchronous designs (if anybody wants them) are even worse. Even when the tools optimize well, you still must direct the process to achieve a tradeoff between a com-

pact design and high-speed circuit operation.

The tools also force you to consider the PLDs separately from the rest of your design. With stand-alone tools, you have to import your partitioned PLD design to the CAD tool containing the rest of your schematics. Then you can test the PLDs as they interact with the other circuits. If the design is incorrect, you have to ping-pong between the two tools to solve the problem.

Even PLD tools integrated with a full CAD package segregate the PLD design portion. When using this integrated software, you have to collect the PLDs in their own block of schematic pages so that the PLD tool can find them.

An exception is Valid's System PLD. Valid's tool allows you to specify your programmable logic elements throughout the schematic at any level of the design description hierarchy. It will automatically collect and merge the PLD functions for optimization and partitioning, then back-annotate your schematic after you've selected the devices.



# TECHNOLOGY UPDATE

## PLD logic synthesis tools

plexity substantially by eliminating unnecessary constraints. Without these features, you would have to try different polarities and truth table values manually until you found which attributes yielded the smallest design.

### Partitioning methods vary

Still distinguishing the various tools are their methods for partitioning large designs into multiple devices. Some, like Minc's PLDesigner, offer automatic partitioning. All you have to do is specify constraints for the final design, such as number of devices used, device types that you allow, cost, or grouping of key signals. These tools try to fit your design into all combina-

tions of allowed parts, then they report your best options, letting you make the final choice.

Data I/O's Abel-4 and Isdata's Log/IC take a different approach—their tools are interactive. You decide where to place each signal, then the tools advise you as to which additional signals must or should be included in the same device. The interaction may inspire you to make design changes—such as burying a node—that can substantially improve device utilization.

The best approach for you depends on which has more value—your time or your silicon budget. In the hands of a knowledgeable designer, an interactive tool can yield

greater device utilization than an automatic one. The automatic tool, on the other hand, can work on solving your problem while you work on another project. It may even come up with designs you wouldn't think of because you're unfamiliar with some of the parts it can choose.

Synthesis tools that have optimizing and partitioning capabilities free you from having to understand the myriad architectures of simple PLDs. You're not off the hook altogether, however. You still need to understand the architectures of the more complex PLDs and of field-programmable gate arrays (FPGAs). The advent of these complex PLDs and FPGAs is stretching the capacity of automatic tools, and their par-

**Table 1—Representative PLD synthesis tools**

Company	Product	Additional design-entry methods			Partitioning	Library size (architectures/devices/device families)	Operating platforms	Base cost	Comments
		Waveform	EDIF	Hardware-description language					
Cadence Design Systems	Amadeus PLD			Verilog	Interactive	/4000/	SPARC, DEC, Apollo/HP	\$12,000	Board-level CAD using Data I/O's technology.
Data I/O	Abel-4		x	Abel-HDL	Interactive	250/6000/	PC, Sun-3, SPARC, Apollo/HP, Intergraph, DEC, Macintosh	\$1995	
	Abel-FPGA			Abel-HDL	Interactive	//Xilinx, Actel, Plus Logic, Altera, AMD	PC, Sun-3, SPARC, Intergraph	\$7995	Can include Abel-4.
Dazix/Intergraph	PLD Master with Abel			Abel-HDL	Interactive	275/3400/	Intergraph, Sun	\$8000	Board-level CAD using Data I/O's technology.
	PLD Master with Log/IC				Interactive		Sun	\$11,000	Board-level CAD using Isdata's technology.
	PLDesigner Plus	x		Proprietary	Automatic	180/3000/	Intergraph	\$14,000	Board-level CAD using Minc's technology.
	PGADesigner Plus	x		Proprietary	Automatic	//Actel, Altera, AMD, Xilinx	Intergraph	\$19,000	Board-level CAD using Minc's technology.
Isdata	Log/IC		x	VHDL	Interactive	380//	PC, Apollo/HP, DEC, Sun	\$1480 to \$6700	Offers graphical state-machine design (flowcharting).
Logical Devices	CUPL, with PLPartition			Cupl	Interactive	240/3000/	PC, DEC, Sun, Apollo/HP	\$695 to \$2295	
Mentor Graphics	PLDSynthesis			Proprietary	Automatic	140/3000/	Apollo/HP	\$14,900	Board-level CAD using Minc's technology.
Minc	PLDesigner	x	x	Proprietary	Automatic	/3200/	any DOS or Unix	\$1950	
	PGADesigner				Automatic	//Actel, AMD, Xilinx		\$2500	
Valid Logic Systems	System PLD	x	x	Proprietary	Automatic	/3000/	DECstation, Sun, RS/6000	\$13,500	Board-level CAD using Minc's technology.
	System PGA					//Actel, Xilinx			

**Note:** All tools offer schematic, Boolean, truth-table, and state-machine design entry.





## Pioneer Can Deliver .99 Power Factor. NOW!

While others talk, Pioneer's customers are enjoying the benefits of power supplies with built-in .99 active PFC today.

In over 2400 voltage-current configurations, from 250 to 2000 watts, single or multiple output.

Pioneer can give you 1000 watts of DC power from a standard 115-V 15-A wall outlet and comply with UL's 12 A limitation. That's 300 more watts of usable power for system peripherals and accessories.

Plus, insensitivity to input voltage and frequency variations over a range of 90-264 VAC, DC-120 Hz eliminates strapping or switching.

You'll also get the added benefits of improved holdup performance, reduced line harmonics, less stress on system wiring, and decreased UPS size.

Because load current drawn from the line is a sine wave rather than a spike, conducted EMI filtering is simplified. In fact, these units meet the requirements of IEC 555-2 which limits third and higher harmonics.

They also meet international safety standards, including UL1950, CSA 1402C and 220, IEC 380 and 435 and EN60950. All Pioneer standard and custom options are available.

Our 100% testing and 48-hour full-power burn-in ensures you of Hi-Rel, top quality supplies.

We've been building high-power switchers over 30 years and shipped over 350,000 worldwide.

So call us at 800-233-1745, or 800-848-1745 in CA. Or write to

1745 Berkeley St.,  
Santa Monica, CA  
90404.

Fax: 213-453-3929.

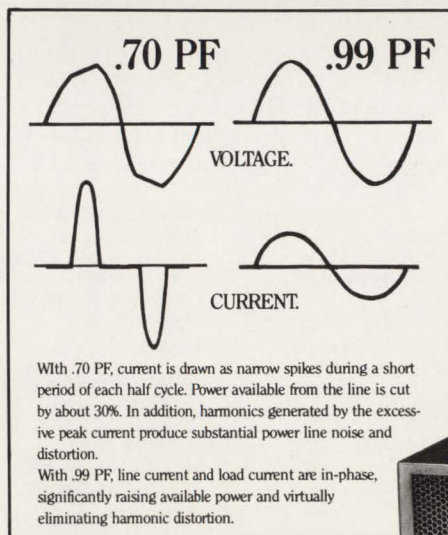

 **Pioneer  
Magnetics**



# TECHNOLOGY UPDATE

## PLD logic synthesis tools

tioning software has not yet caught up. When dealing with such complexity, you'll have to select the target device based on your own knowledge.

The tool vendors are responding to the demands these complex devices place on their software by creating a separate design path for them, as shown in Fig 1. This design path includes a detour to tools outside of their own tools. Acknowledging that device vendors have the greatest insight into device architectures, the PLD synthesis tool vendors are forging links to the device vendors' design tools instead of creating their own.

This may seem like a step backward in design methodology. Instead of having a single tool handle your design from description through implementation, as with PLDs, you have to send your design to a second, device-specific tool. And if you're going to design predominantly in FPGAs, the prospect of moving from one tool to another may tempt you to use just the device vendor's tool. However, if you use the PLD synthesis tool as a

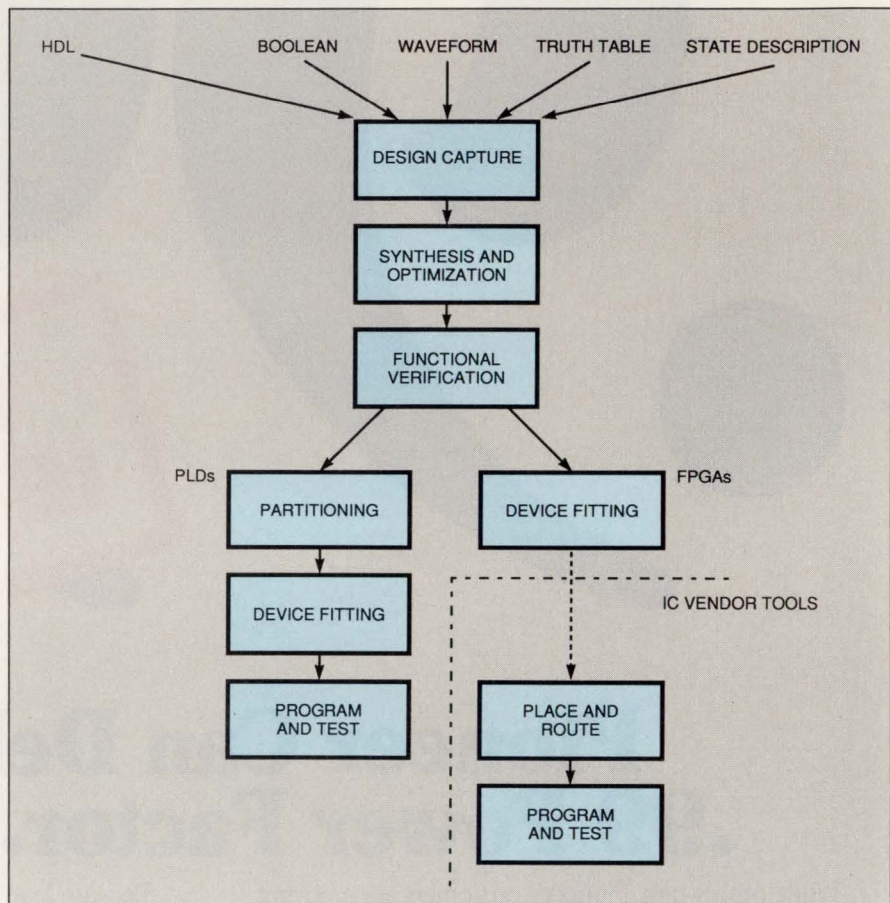

*Parts selection is the final design step when using today's PLD synthesis tools, as this work-flow diagram shows. Earlier PLD design tools required that you select the part before beginning design.*

## For more information . . .

For more information on the PLD synthesis products discussed in this article, circle the appropriate numbers on the Information Retrieval Service card or use EDN's Express Request service. When you contact any of the following manufacturers directly, please let them know you saw their products in EDN.

**Cadence Design Systems**  
555 River Oaks Pkwy  
San Jose, CA 95134  
(408) 943-1234  
FAX (408) 943-0513  
Circle No. 700

**Dazix**  
An Intergraph Co  
1 Madison Industrial Park  
Huntsville, AL 35894  
(205) 730-2000  
FAX (205) 730-8344  
Circle No. 702

**Logical Devices Inc**  
1201 NW 65th Pl  
Ft Lauderdale, FL 33309  
(305) 974-0975  
FAX (305) 974-8351  
Circle No. 704

**Minc Inc**  
6755 Earl Dr  
Colorado Springs, CO 80918  
(719) 590-1155  
FAX (719) 590-7330  
Circle No. 706

**Data I/O Corp**  
10525 Willows Rd NE  
Redmond, WA 98053  
(206) 881-6444  
FAX (206) 881-6856  
Circle No. 701

**Isdata Inc**  
800 Airport Rd  
Monterey, CA 93940  
(408) 373-7539  
FAX (408) 373-3622  
Circle No. 703

**Mentor Graphics Corp**  
8005 SW Boeckman Rd  
Wilsonville, CA 97070  
(800) 547-3000  
in CA, (503) 685-8000  
FAX (503) 685-8001  
Circle No. 705

**Valid Logic Systems**  
2820 Orchard Pkwy  
San Jose, CA 95134  
(408) 432-9400  
FAX (408) 432-9430  
Circle No. 707

## VOTE . . .

Please also use the Information Retrieval Service card to rate this article (circle one)

High Interest 509 Medium Interest 510 Low Interest 511



# DESIGN WITH ANALOG WORKBENCH II AND YOU WON'T HAVE TO MANUFACTURE EXCUSES.



2820 Orchard Parkway, San Jose, CA 95134 \*ASIC Technology & News: Focus Report, August, 1990.

© 1990 Valid Logic Systems, Inc.

**G**o ahead, explain it.

Tell them how small variations in component tolerances, process parameters and operating temperatures can cause an analog design to fail in manufacturing. Or worse yet, in the field. Even though it worked in the lab or in SPICE.

That's a problem Valid can help you avoid. As the leading supplier of analog EDA systems, we understand how downstream factors can sabotage your analog circuits.

That's why our Analog Workbench II provides the most complete selection of in-process analysis tools. So you can dramatically improve the quality, reliability and manufacturability of your analog ASICs or boards.

Choose from sophisticated tools like parametric, worst case and sensitivity analysis to identify critical design dependencies. Advanced statistical analysis to predict and optimize manufacturing yields. And Smoke Alarm™ stress analysis to ensure that com-

ponents stay within safe operating limits.

All analyses support DC as well as AC and transient measurements. And with Valid's unique Distributed Network Processing option, you can automatically partition compute-intensive runs across a network of workstations. Providing desktop performance of 100 MIPS or more, to give you more time to refine your design.

Analog Workbench II delivers all this capability in an integrated, easy-to-use environment that *ASIC Technology & News* calls "a designer's dream."\* With system-level function blocks for top-down design. The world's largest analog component libraries. And tight integration with IC or PCB physical design tools.

It's all part of Valid's Process Integration Architecture, the industry's most practical and comprehensive approach to concurrent engineering.

For more information, call 1-800-48-VALID today. We'll take the excuses out of your next analog design.

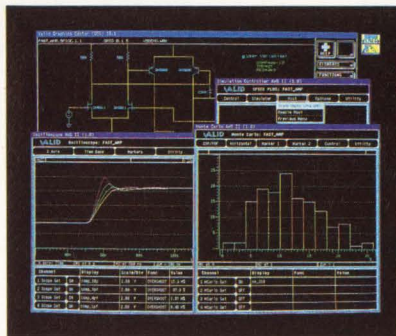

*Valid's in-process analysis lets you catch downstream errors before they occur.*



Tough Issues, Valid Answers.



# TECHNOLOGY UPDATE

## PLD logic synthesis tools

front end, you keep the advantage of being able to choose the target technology after you create the design, instead of before.

If you use a PLD synthesis tool for FPGA design, the tool will optimize your design for the target device, then produce an output file that the device vendor's tool accepts. The format of that output file varies with the synthesis tool vendor. Isdata and Minc provide vendor-specific formats, matching the native format of each device-vendor's tool to take maximum advantage of the part's architecture. Data I/O takes a more open-architecture approach; its output files are in PDS or Abel-PLA format, allowing a variety of FPGA and ASIC design tools to accept the same file.

Adapting to encompass FPGAs is only one way that PLD synthesis

tools are evolving. Another is their inclusion of industry standard interfaces. Electronic Data Interchange Format (EDIF) and VHSIC Hardware Description Language (VHDL) interfaces, for example, are under development at most of the PLD synthesis tool vendors. You will probably see these interfaces become widely available during the next six to nine months; some are ready now. Isdata, for example, has translators that accept VHDL and EDIF design descriptions for its Log/IC tool. In addition, Isdata, Logical Devices, and Mentor Graphics offer EDIF output files.

The continuing evolution of PLD synthesis tools isn't stopping with programmable devices. Vendors have already taken steps toward encompassing gate arrays. Data

I/O's output file format, along with the other vendors' EDIF output format, makes it possible for your design to migrate from PLD and FPGA to ASIC tools. Furthermore, Isdata offers a tool called Hint that flattens a PLD design so you can implement it in a gate array. And there is no telling how far along the path to ASICs the PLD vendors can take their tools, allowing you to design while having access to the entire range of user-defined logic.

**EDN**

## Reference

1. Markowitz, Michael C, "Logic synthesis prepares for VHDL," *EDN*, March 30, 1989, pg 51.

Article Interest Quotient  
(Circle One)

High 509 Medium 510 Low 511

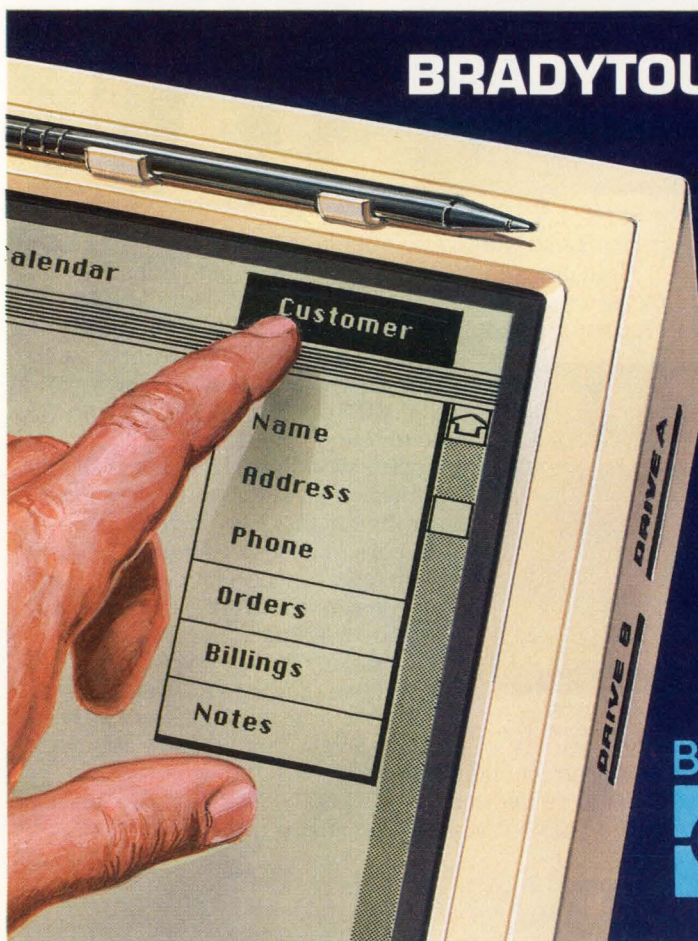

## BRADYTOUCH™ TRANSPARENT TOUCH SCREENS

Put technology at your fingertips with a BRADYTOUCH™ Transparent Touch Screen. Available in matrix or analog designs, BRADYTOUCH™ Screens are the ideal, affordable solution to your touch screen needs.

### Best Transparency in its Class

BRADYTOUCH™ Screens transmit light better than any other membrane screens. A unique "total surface" optical-adhesive design reduces transmission losses, resulting in improved clarity.

### Reliable

BRADYTOUCH™ Screens are made of durable, yet lightweight plastics. Abrasion-resistant, non-glare finishes are available for particularly demanding applications.

Let us help you with your touch screen needs. Call or write today.

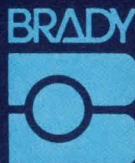

**W. H. BRADY CO.**  
**THIN FILM PRODUCTS**

8225 W. Parkland Ct. • P.O. Box 571  
Milwaukee, Wisconsin 53201  
Phone: 414-355-8300 • Fax: 414-354-0453

© Copyright 1990 W. H. Brady Co. All rights reserved.



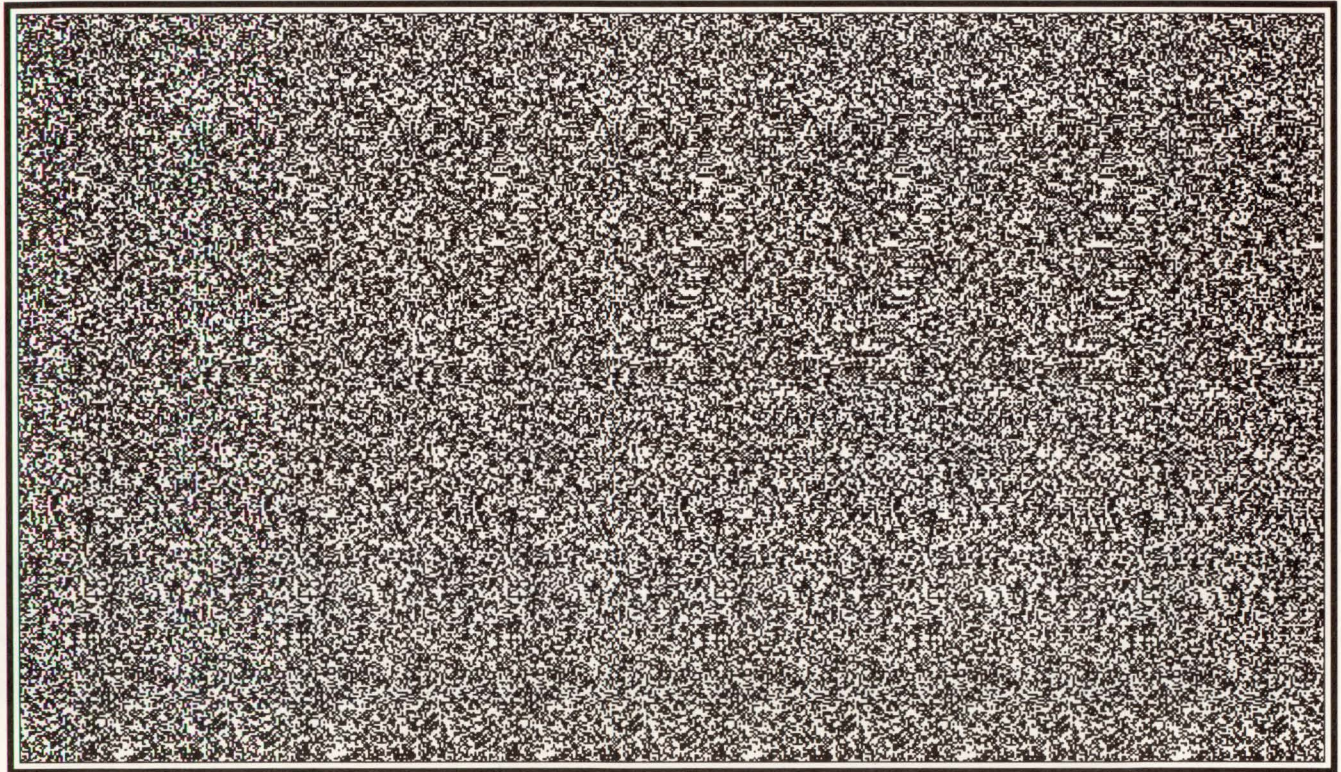

# Pentica Loves Puzzles!

*Somewhere in this random pattern of dots is a number. Take a few minutes to gaze at the image. It's not easy to see. Most people take quite a long time before the brain locks in on the pattern correctly.\**

*Standard emulators face the same problem when looking for bugs. In fact, using most in-circuit emulators can be like trying to see this number with one eye shut. That's why you need the powerful pattern recognition you get with the MIME 600 and MIME 700 from Pentica. Both give you source-level*

*debugging, powerful breakpoint mechanisms and real-time trace to track down errors. And that's like having the bugs jump right out at you.*

*To find out more about the MIME series emulators, send in the coupon today. We'll also give you more information about the Random Dot Stereogram you've been staring at. We'll include lots of help in learning to see the image. If you CAN see the number, please write it in the space provided. Ten correct responses will be chosen at random to receive a special prize.*

*Please note the two addresses listed below. In the U.S., responses should go to Pentica, Inc.; in Europe please send replies to Pentica, Ltd. Reader service numbers: #121 for U.S.; #122 for U.K.*

*\*To see the number, diverge your eyes, as if looking at a faraway object. The two dots will fuse, forming a third central dot. When the divergence is correct, slight, controlled variations in the placement of the random dots are perceived by the brain as depth cues. A shape will appear to float above a textured background. Some see the image in seconds. Others find it more difficult. If you can't see it, let someone else try. If they succeed, perhaps they can help you. Be sure to get the full explanation along with more examples by sending us the coupon.*

Name _____	The number is: _____
Company _____	_____
Address _____	<input type="checkbox"/> Send more information about the MIME family of in-circuit emulators.
_____	
City, State, Zip _____	
Phone _____	
We welcome your comments.	

## PENTICA IN-CIRCUIT EMULATORS

*We love to solve puzzles!*

**Pentica Systems, Ltd.**  
Oaklands Park  
Wokingham, Berkshire  
RG11 2FE, U.K.  
(0734) 792101  
Fax (0734) 774081

**Pentica Systems, Inc.**  
One Kendall Square  
Building 200  
Cambridge, MA 02139, USA  
(617) 577-1101  
Fax (617) 494-9162



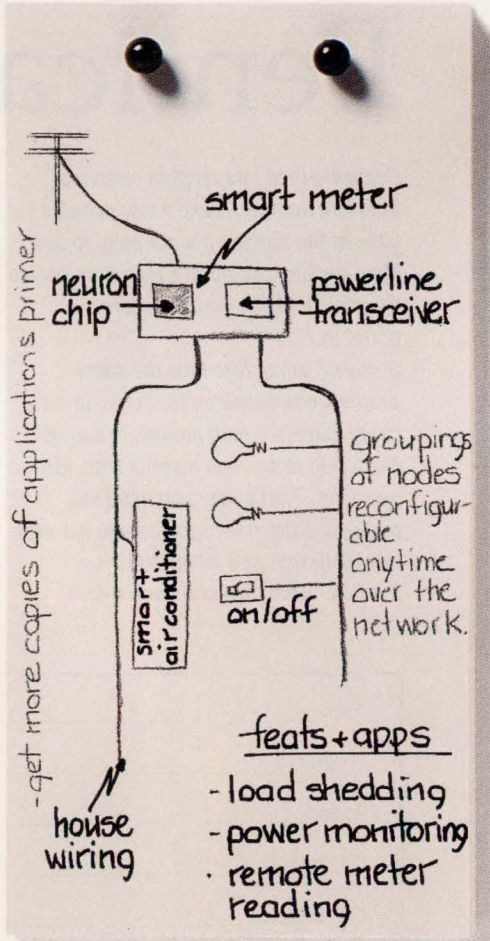
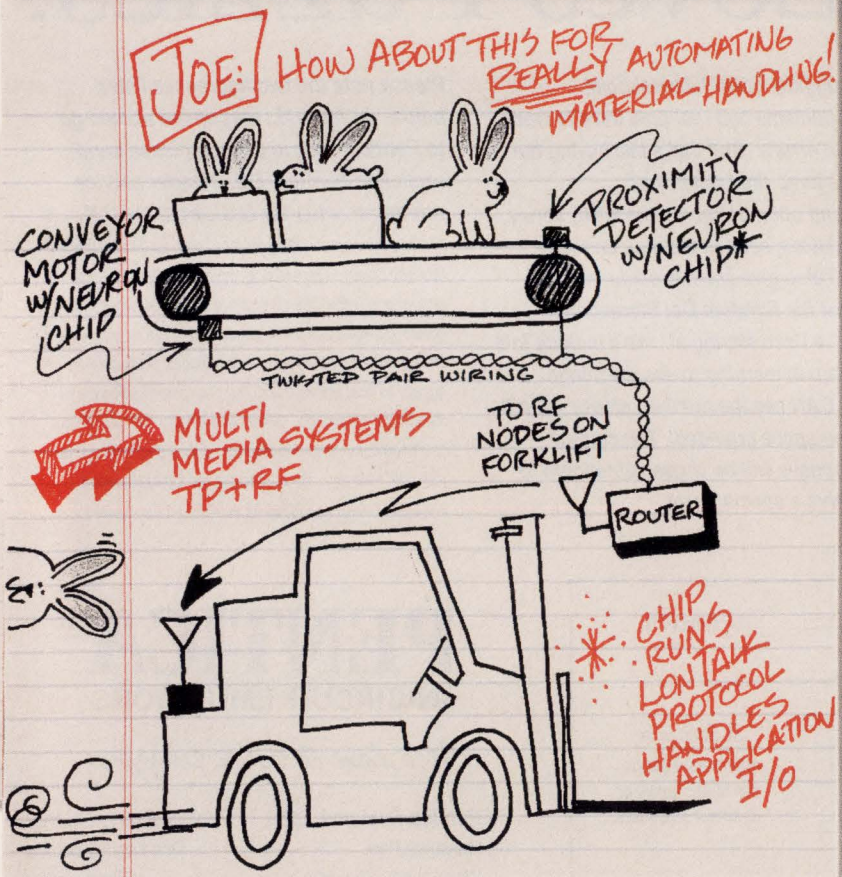
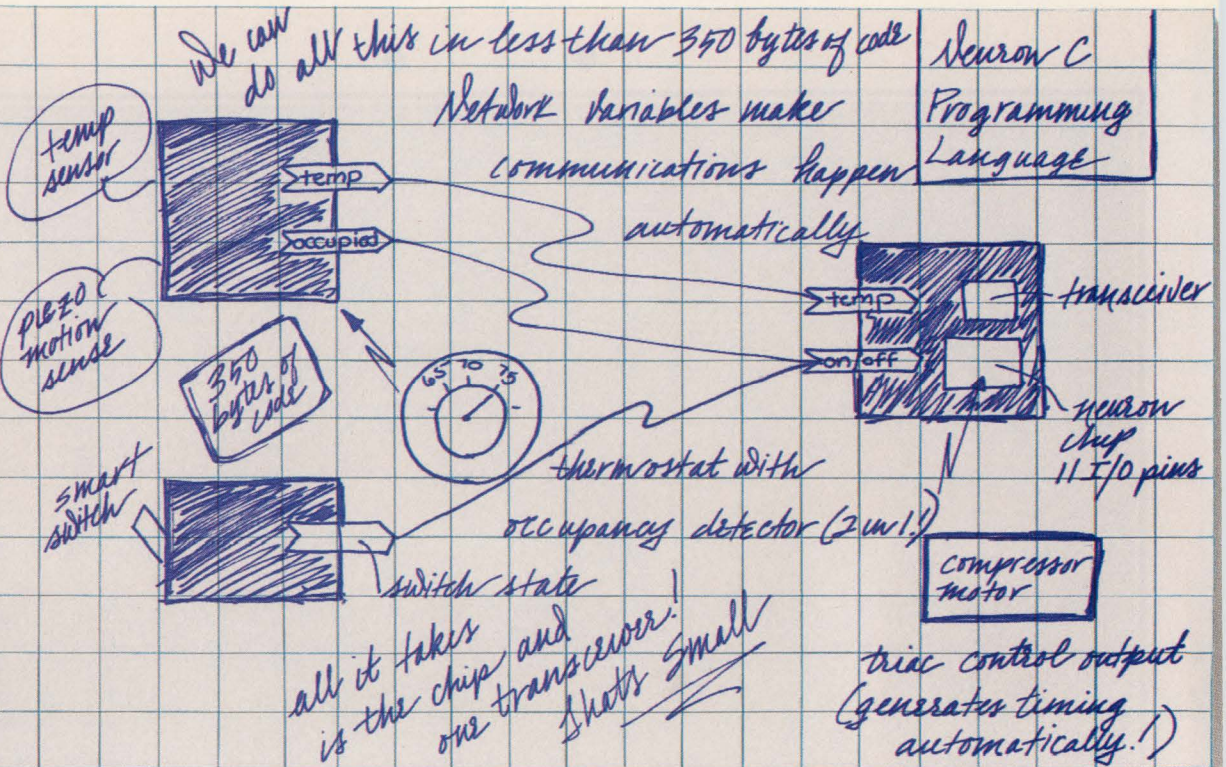

© 1991 Echelon Corporation. LONWORKS, LONBUILDER and LONTALK are trademarks, and ECHELON, LON, and NEURON are registered trademarks of Echelon Corporation. Other names may be trademarks of their respective companies. Some of the LONWORKS tools are subject to certain Terms and Conditions. For a complete explanation of these Terms and Conditions, please call 1-800-258-4100.



## ECHELON SEMINAR

- o WE CAN DO ALL THESE WITH 1 WIRING HARNESS
- o PRIORITY FEATURE OF LONTALK PROTOCOL GUARANTEES RESPONSE TIME FOR CRITICAL FUNCTIONS
- o NEW APPLICATIONS? RF TO AUTOMATIC TOLL SENSOR?

### o CHIPS

- 3 CPUS
- RAM, EPROM (ROM)
- COMM & I/O

### MULTIPLE SOURCES



MOTOROLA  
TOSHIBA

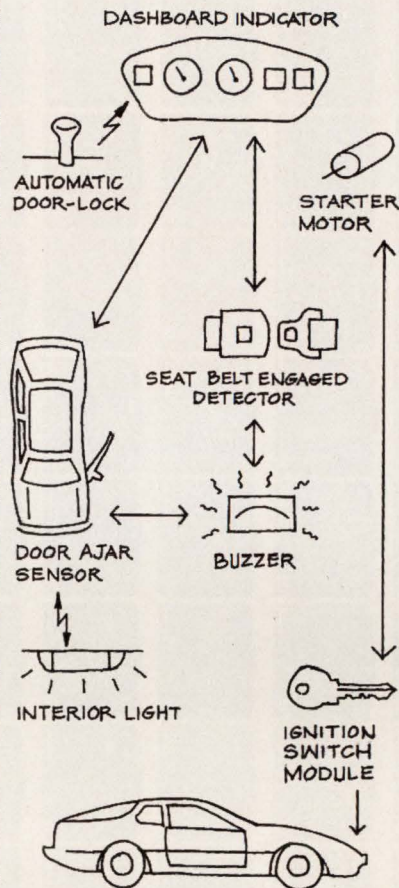

## LONWORKS SEMINARS

ALABAMA	Huntsville	Oct. 1
ARIZONA	Phoenix	June 25
CALIFORNIA	Irvine	May 2
	Los Angeles	Sept. 25
	Sacramento	Sept. 11
	Santa Clara	Sept. 12
	Woodland Hills	Sept. 10
COLORADO	Denver	June 26
CONNECTICUT	Stamford	June 18
FLORIDA	Ft. Lauderdale	April 9
	Orlando	April 10
GEORGIA	Atlanta	April 11
INDIANA	Indianapolis	June 5
ILLINOIS	Chicago	Sept. 20
MARYLAND	Baltimore	April 2
MASSACHUSETTS	Boston	April 3
	Boston	Sept. 19
MICHIGAN	Detroit	March 28
MISSOURI	Kansas City	March 26
	St. Louis	June 6
NEW HAMPSHIRE	Manchester	May 7
NEW JERSEY	Fairfield	June 12
NEW YORK	Albany	June 19
	Long Island	April 4
	Rochester	June 11
	Tarrytown	May 9
NORTH CAROLINA	Raleigh	Oct. 2
OHIO	Cleveland	March 27
	Dayton	June 4
OREGON	Portland	April 16
PENNSYLVANIA	Philadelphia	May 8
	Pittsburgh	June 20
TEXAS	Austin	Sept. 24
	Dallas/Ft. Worth	May 1
	Houston	April 30
VIRGINIA	Tysons Corner	June 13
WASHINGTON	Seattle	April 17
UTAH	Salt Lake City	June 27
CANADA	Montreal	April 24
	Ottawa	April 23
	Toronto	April 25
	Vancouver	April 18
EUROPE	Düsseldorf	May 17
	London	May 20
	Milan	May 28
	Munich	May 16
	Paris	May 30
	Stockholm	May 14
	Zurich	May 23
JAPAN	Osaka	(TBA)
	Tokyo	(TBA)

1-800-258-4LON  
For Reservations and Information

# We developed LONWORKS technology. What you do with it is your business.

Spend a day in a free LONWORKS™ seminar and we'll change the way you develop products forever.

You'll learn about the technology that uses the latest computer, semiconductor and networking advances to add control and communication capabilities to your products. Quickly and inexpensively.

You'll see the heart of LONWORKS, the NEURON® CHIP. Small enough to fit into any product, smart enough to control and respond to other devices, flexible enough to communicate over standard media, and inexpensive enough that everyone can afford it.

You'll discover how easy it is to program and link NEURON CHIPS into virtually invisible networks of intelligent devices.

How our LONTALK™ protocol communicates over powerlines, twisted pair, radio waves, and other common media.

How our LONBUILDER™ Developer's Workbench helps you design LONWORKS networks into your products. How to connect products into smart systems. And how to connect systems into interoperating LONWORKS environments as large as a building, a home or a factory. All in less time and for less money than it takes to develop your own protocols and tools.

So call 1-800-258-4LON for reservations. And learn about the new technology that will help you improve your products. And your business.





# 99.5% PCB Reliability Guaranteed!

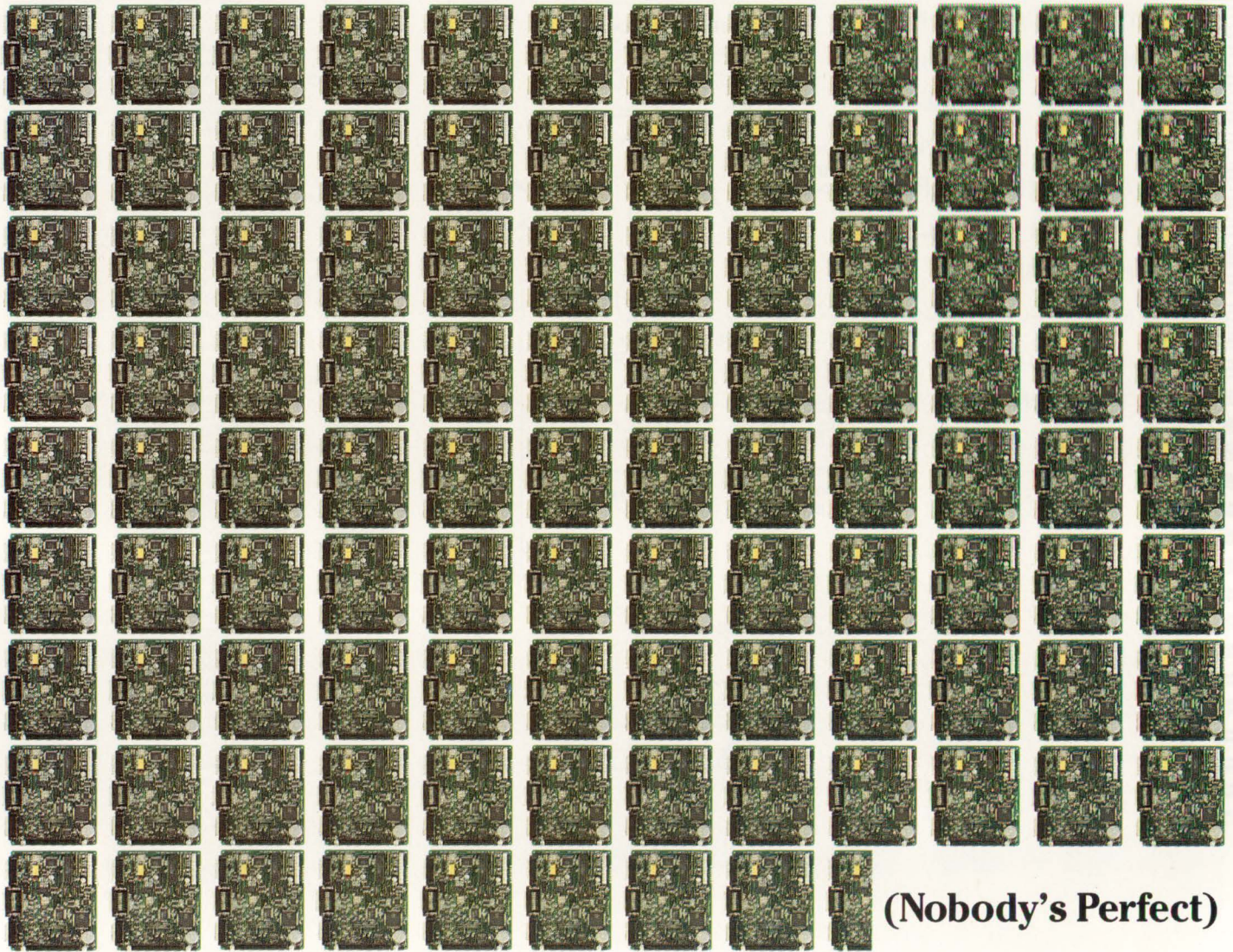

**(Nobody's Perfect)**

Kokusai has become a world leader in electronics by making bold claims ...and backing them up. How can we guarantee such a high percentage of first pass reliability?

First, our quality control procedures utilize the most advanced technology to weed out any less-than-perfect component *before fabrication begins*. Second, Kokusai's precision mounting and advanced robotics eliminate human error.

Finally, all PCBs go through a full series of *automatic inspections* to insure that they meet Kokusai's rigid standards. These exhaustive steps result in printed circuit boards with

the highest degree of reliability available today.

A superior product is only one of Kokusai's many advantages:

#### **Cost Effectiveness**

Based on your specifications, we'll produce finished boards with near-perfect reliability...on time, and at very competitive prices.

#### **Design Assistance**

We're specialists in hardware *and* software. This means we can utilize gate arrays and ASICs to satisfy any application you require, including reduced board size.

#### **Quick Response**

Our manufacturing facilities are self-contained. We have the ability to respond immediately to specification changes and other critical requirements, on-time and on-budget.

To learn more about Kokusai reliability, cost-effectiveness, design and response capabilities, ask for a *free* brochure.

*Special gift when you call or write to us on company letterhead – Kokusai Cubed Memo Pad.*



Kokusai Electric Company, Ltd.

3000 Marcus Ave., Lake Success, NY 11042 (516) 354-1177 Fax: (516) 354-1502

Offices: New York • California • England • Germany • Japan

CIRCLE NO. 123



## Without GaAs, RISC workstation family breaks 55-MIPS speed limit

Just as IBM made its re-entry into the workstation field with its RS6000 last summer, Hewlett-Packard/Apollo has declared that it shouldn't be counted out. The HP/Apollo 9000 Series 700 workstations run at 57 and 76 MIPS, or at 55.5 and 72.2 SPECmarks using a CMOS CPU. Spec integer performance ranges from 39 to 51 VAX MIPS, and floating-point performance is 70.2 to 91 VAX MIPS.

The Precision-RISC-based computers are available in three models. The base model 720 starts at \$11,990 and, like its two siblings, comes standard with 16M bytes of RAM.

The memory in the two lower-end machines is expandable to 64M bytes. Although the 720 base unit is diskless, you can add as much as 840M bytes of internal storage or as much as 10G bytes of external disk capacity via its standard SCSI-2 port. The 50-MHz Precision CPU uses a 256k-byte data cache and a 128k-byte instruction cache.

The mid-level machine, the \$19,990 Model 730, uses a test-selected 66-MHz CPU to improve its throughput. The workstation also adds a 200M-byte hard disk. Like its 50-MHz sibling, this workstation accepts as much as 10G bytes of disk capacity. The EISA (extended-industry-standard architecture) slot is optional in the low-end machine, but it comes standard in this machine.

The \$43,190 Model 750 rounds out the family. This desk-side workstation/server offers a 660M-byte hard disk. Although it too comes equipped with 16M bytes of RAM, you can furnish the system with as much as 192M bytes of 2-way interleaved RAM. To improve instruction-cache (I-cache) hit rates, this workstation doubles its I-cache to 256k bytes.

All of the workstations feature Ethernet, RS-232C, Centronics, and HP-HIL ports for network and peripheral-device connections. And where the 720 has an optional EISA

slot and the 730 has one EISA slot, the 750 has four EISA slots. All of the machines offer optional CD-ROM and 4-mm digital audio-tape capabilities. The CD-ROMs can provide operating-system, application, and documentation access.

Four levels of graphics performance are available on the Series 700. The starting gray-scale GRX is available on the basic 720 and 730 workstations. The CRX is the entry-level color system and is included with the 750. The GRX and CRX graphics subsystems provide 1.15M 2-D vectors/sec and 8044 X11 vectors/sec performance. The two high-end graphics systems use one to four i860 dedicated graphics processors to provide as much as 1.3M 3-D vectors/sec and 195,000 lighted and shaded polygons/sec.

For workstation users committed to some of their DOS applications, the 66-MHz CPU provides 20- to 25-MHz DOS emulation via a \$700 Insignia emulator license. The

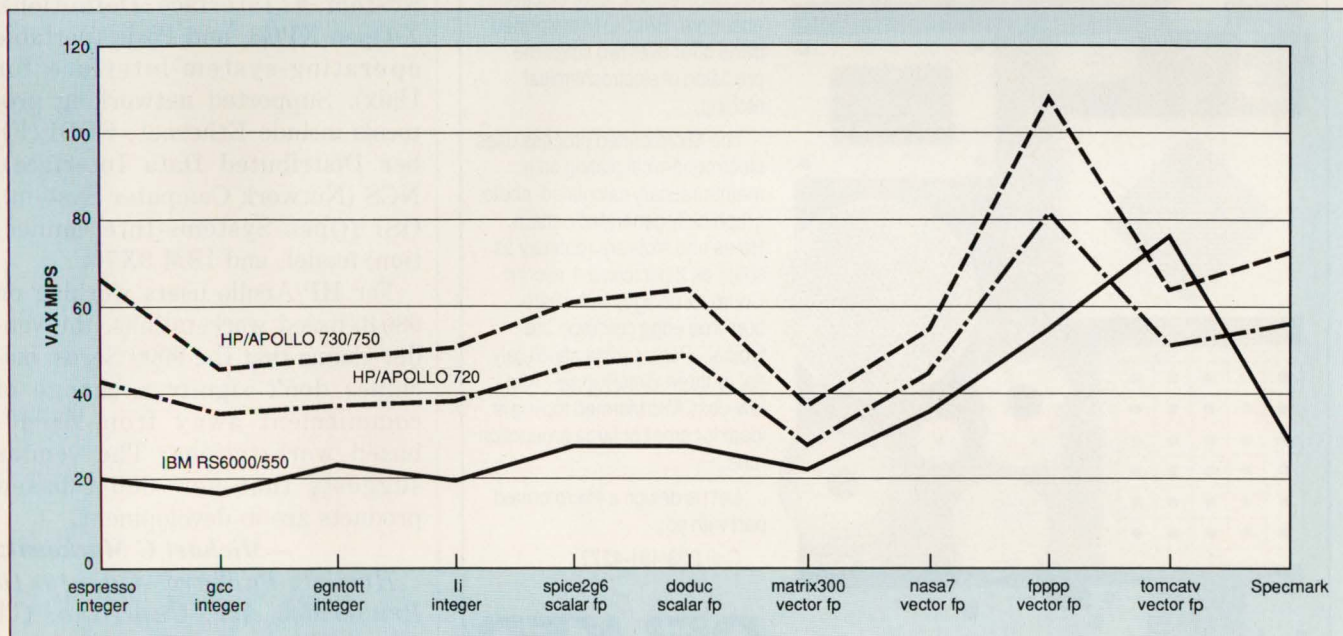

*Benchmark results give an indication of the type of performance you might expect from the HP Series 700 workstations.*



# Get Two BERT Sets for the Price of One...

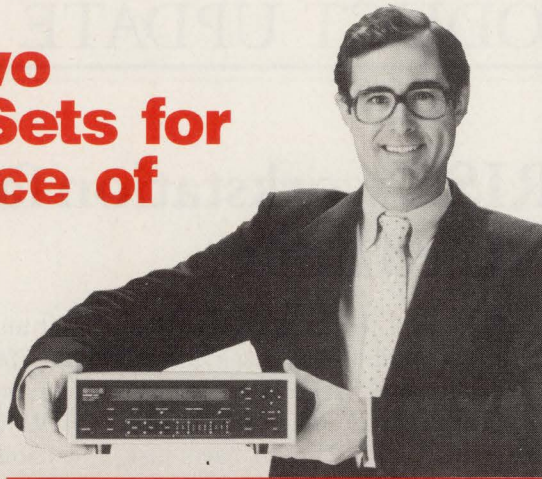

## Gemini 1022 Dual Terminal Emulator

TAS Gemini 1022 is the only instrument that provides end-to-end testing of high-speed intelligent modems, ISDN terminal adaptors, and DDS sets.

- Provides two complete data analyzers in one compact package
- Measures BER/CER/BLER and throughput at rates up to 72 kbps
- Built-in GPIB and RS-232 control interfaces for test automation
- Supports ASYNC, SYNC, and HDLC formats for thorough testing of modem command sets



Telecom Analysis Systems, Inc.

*Gemini 1022 —  
a Dual BERT and  
Much, Much More!*

34 Industrial Way East, Eatontown, NJ 07724-9917 • Phone (908) 544-8700 • FAX (908) 544-8347

CIRCLE NO. 18

## Twice as Precise as Electrochemical Etching

### BALCO Microformed™ Parts

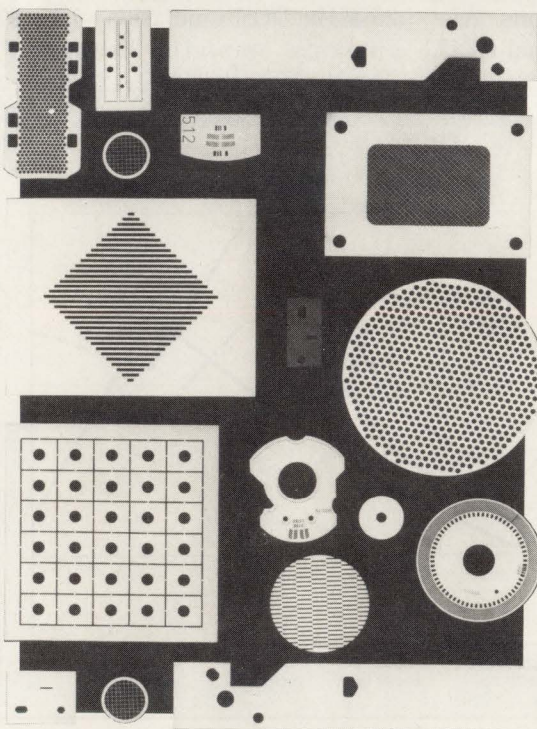

For encoder discs, masks, optical slits, aperture plates, ink-jet nozzles, reticles, laser electrodes and more, BALCO Microformed parts offer over two times the precision of electrochemical etching.

The Microformed process uses electrochemical plating on a mathematically calculated, photographically generated pattern. Holes and slots are routinely as small as 2 microns  $\pm$  1 micron. Complex designs with sharp, burr-free edge definition are typical. Parts can be absolutely flat or three-dimensional. And low-cost, Microformed tooling is ideal for small or large production runs.

Let us design a Microformed part with you.

Call 203/481-4277

**DELKER**  
CORPORATION

1"

P.O. Box 427 • Branford, CT 06405 • 203/481-4277 • FAX: 203/488-6902

CIRCLE NO. 19

## UPDATE

workstation uses HP/Apollo's 9000 Series 800-level binary code so you won't need to recompile Series 800 applications that don't use or need the graphics or floating-point capability of the Series 700.

Although the vendor claims that more than 2000 software applications run on Precision-based workstations, the 9000 Series workstations don't yet have a significant base of electronic-design-automation (EDA) applications. However, a few EDA vendors, among them Mentor Graphics, Cadence Design Systems, Racal-Redac, and Zuken say they will port their software. Racal's software will be released this summer. Mentor's port should be available before the end of the year, but Cadence didn't offer a release schedule. Other EDA vendors, such as Synopsys, Valid, Vantage, and Viewlogic, are waiting for user demand to grow before committing to a port.

The workstations use the HP Vue user interface, a refinement of the OSF/Motif GUI (graphical user interface). The 9000 Series machines run the OSF/1 version of Unix and are compatible with SVID (Unix System V Interface Definition), X/Open XPG3, and Posix (portable operating-system-interface for Unix). Supported networking protocols include Ethernet, FDDI (Fiber Distributed Data Interface), NCS (Network Computer System), OSI (Open-Systems-Interconnection) model, and IBM 3X70.

For HP/Apollo users working on 68040-based workstations, the vendor claims that the 9000 Series machines don't signify a change of commitment away from 68040-based workstations. The vendor suggests that new 68040-based products are in development.

—Michael C Markowitz

Hewlett-Packard Co, 19310  
Pruneridge Ave, Cupertino, CA  
95014. Phone (800) 752-0900.

Circle No. 731



# THE NETWORK SOLUTION.



Speed is of the essence when installing networks. The many practical ideas incorporated in Temprack are timesavers for your network project – both at the planning stage and during on-site assembly.

**1.)** Model: Temprack NS 19  
41 U\*, Width 800, Depth 800.  
with glass – door and raised top  
**Order No. 1.113.816.3**

**2.)** 19" distribution patch panel IBM for  
32 connectors with mounting-kit  
**Order No. 1.113.763.3**

**3.)** 19" fixed shelf, 2U\*  
perforated for air circulation  
**Order No. 1.113.737.3**

**4.)** Jumpering bracket for cable feed  
**Order No. 1.113.749.7/pair**

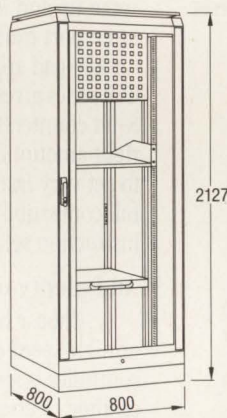

19" distribution patch panels also available for all other types of connector (IBM 8, 16, 32, 64 way, BNC, fiber optic connectors etc.).

Other types of racks:

- i.e. with swing frame
- i.e. for 650 mm wide equipment
- i.e. for 735 mm wide equipment
- i.e. for equipment 19" and 650/735 mm mixed also available as standard product.

Vast range of accessories available.



® **KNÜRR – MECHANIK FÜR DIE ELEKTRONIK AG**

Schatzbogen 29  
D-8000 München 82  
Telefon (089) 42004-0  
Telex 5 29608-10  
Telefax (089) 42004-118

	bfr	FF	£	nkr	sfr	US \$	DM
<b>1.)</b>	44 236,50	7609,00	763,00	9047,00	1917,00	1662,00	1915,00
<b>2.)</b>	2788,20	480,00	41,90	571,00	121,00	105,00	135,80
<b>3.)</b>	1663,20	285,00	14,70	338,00	72,00	62,00	72,00
<b>4.)</b>	351,10	60,00	5,70	72,00	15,00	13,00	15,20
	Knürr NV	Knürr s.a.r.l.	Knürr (UK) Ltd.	Knürr Norge A/S	Knürr AG	Knürr USA Inc.	Knürr AG
	Tel. 03-326.02.99	Tel. (1) 43 77 85 85	Tel. 04 80-49 61 25	Tel. 02-65.02.20	Tel. 01-82 50 707	Tel. (805) 526-7733	Tel. (0 89) 4 20 04-0
	Fax 03-325.55.43	Fax (1) 43 39 02 10	Fax 04 80-49 63 73	Fax 02-65.32.30	Fax 01-82 50 803	Fax (805) 584-8371	Fax (0 89) 4 20 04-118

(\* ) U = 1 3/4" = 44.45 mm

Delivery ex stock. Prices ex works, excluding packing, exclusive VAT.



Z I L O G



# The 8-bit CMOS Consumer/Control Processor with the most exciting feature set you've ever seen.

The low-cost Z8 CCP family of microcontrollers takes full advantage of Zilog's new Superintegration™ Z8® core. The result is unprecedented functionality at a price that makes sense for high volume consumer and automotive products as well as intelligent embedded peripherals.

## Features . . .

For starters, there's a voltage detection circuit that automatically triggers an on-board power-on reset

timer for no-fuss power up. And it continues to provide brown-out protection . . . in case Vcc falls below the 2.5-5.5 volt operating range. Not only that, there's an on-board watchdog timer that secures your application even further.

. . . and more features.

You also get a stop mode that typically consumes less than 2 microamps. What's more, stop-mode wake-up and interrupts can be triggered from multi-input port transitions, making the Z8 CCP MCU ideal for key-pad applications. And that's not all. The Z8 CCP series gives you on-board analog comparators, two 8-bit counter/timers, with 6-bit pre-scaler, and the right amount of I/O. And you know you're going to get very fast code development, because you've got full compatibility with the widely used 8-bit Z8 instruction set.

## And plenty of important choices.

Choose between low EMI wide voltage range or high-speed control devices. The Z8 CCP microcontroller is also available in your choice of RC, ceramic or crystal oscillator circuits. And in 18-, 28-- and 40/44-pin versions, in a variety of packages, with 2K or 4K ROM Code sizes. All off the shelf and backed by Zilog's proven quality and reliability.

To find out more about the Z8 CCP MCU or any of Zilog's rapidly growing family of Superintegration products, contact your local Zilog sales office or your authorized distributor today. Zilog, Inc., 210 Hacienda Ave., Campbell, CA 95008, (408) 370-8000.

**Expanding the Z8 Family**

*From the very beginning, the Z8 MCU has been an industry standard for simplicity and elegance in 8-bit microcomputers. This sophisticated microcontroller family has continued to grow, until today, there is a Z8 MCU for every phase of your system development, from prototyping to full production.*

*Zilog has always been keenly aware of the specific needs of a wide variety of markets, as some recent additions to the Z8 family illustrate. The requirements of consumer and automotive products for inexpensive MCUs that are both EMI quiet and provide operation over a wide voltage range at low power levels, for example, have led to the development of certain versions of the Z8 CCP family.*

*Here are a couple of other notable examples:*

- Z8 DTC—The high performance, single chip television controller for the high volume consumer TV market.
- Z86C08—The first 8-bit, 18-pin Z8 microcontroller for consumer and automotive products.

**ASK ABOUT EMI QUIET VERSIONS**

Right product. Right price. Right away.



**ZILOG SALES OFFICES:** CA (408) 370-8120, (714) 838-7800, (818) 707-2160, CO (303) 494-2905, FL (813) 585-2533, GA (404) 923-8500, IL (312) 517-8080, NH (603) 888-8590, MN (612) 831-7611, NJ (201) 382-5700, OH (216) 447-1480, PA (215) 653-0230, TX (214) 987-9987, CANADA Toronto (416) 673-0634, ENGLAND Maidenhead (44) (628) 39200, W. GERMANY Munich (49) (89) 672045, JAPAN Tokyo (81) (3) 587-0528, HONG KONG Kowloon (852) (3) 723-8979, KOREA (82) (2) 552-5401, TAIWAN (886) (2) 741-3125, SINGAPORE 65-235 7155, DISTRIBUTORS: U.S. Anthem Electronics, Hall-Mark Electronics, JAN Devices, Inc., Schweber Electronics, Vargas Electronics, Western Microtechnology, CANADA Future Electronics, SEMAD, LATIN AMERICA Argentina—Yel-(1) 46-2211, Brazil—Digibyte (011) 581-1945.



# PRODUCT UPDATE

## Low-cost ac instruments offer high accuracy

Keithley is entering the ac-instrumentation field with five products: two LCZ meters and three multifunction synthesizers. These products simplify the process of testing your circuit or device by automating setup procedures and measurement parameters. The prices for these instruments are as little as one-third the prices of comparable instruments sold by other manufacturers.

The Model 3321 and 3322 LCZ meters are 4½-digit, IEEE-compatible units that offer 0.1% accuracy for inductance, capacitance, and impedance measurements. Dissipation and quality measurements display with 0.0001 resolution; phase resolution is 0.01°. You can select ac test voltages of 1V or 50 mV. To operate either meter, just connect the device you're testing and take a reading—both units automatically identify the type of circuit and display all applicable outputs. Both meters also come with an internal 2V bias source, but you can supply an alternate external bias source as large as 35V.

The \$3490 Model 3321 has 150-msec and 480-msec trigger-reading rates and offers test frequencies of 120 Hz, 1 kHz, 10 kHz, and 100 kHz. The Model 3322 costs \$3990, has eleven test frequencies, and adds a 64-msec trigger-reading rate. The 3320 can also read percent deviation from a preset value and identify what kind of device it's testing.

The three multifunction synthesizers use Direct Digital Synthesis (DDS) to ensure phase-

continuous waveforms. Using DDS allows the units to change frequencies without taking several cycles to stabilize. The units are accurate to 5 ppm and have five built-in waveforms, trigger/burst/gate functions, and on/off oscillation control.

The \$3590 Model 3930A offers 11-digit output resolution, a range of 0 Hz to 1.2 MHz with 0.1-mHz resolution, and a 30V p-p output voltage. The \$5390 Model 3930 has 12-digit output resolution, a range of 0 Hz to 20 MHz, a 20V p-p output, and two built-in synthesizers that can act as a 2-phase oscillator or a harmonic generator. Both models have a built-in IEEE-488 interface and sweep capability over the entire range. The 3930 also has burst capability over its range. If your application doesn't require such accuracy, the \$1695 Model 3910 is accurate to 30 ppm over a range of 0 Hz to 1 MHz.—**J D Mosley**

*Keithley Instruments Inc, 28775 Aurora Rd, Cleveland, OH 44139. Phone (216) 248-0400. FAX (216) 248-6168.*

Circle No. 730

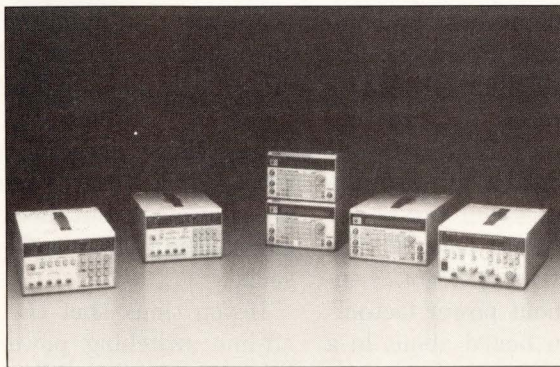

*Offering improved price/performance ratios, Keithley enters the ac instrumentation market with two LCZ meters priced less than \$4000 and three multifunction synthesizers priced less than \$5400.*

## Looking into a multichip module? Read between the lines and you'll get it.

Small wonder! Multichip modules deliver faster, denser, more reliable performance.

Smaller vias, .005 dia., with .003 trace and space widths and buried resistors add up to increased densities.

Faster processing lowers cost by 5 to 10 times over polymer multichip modules.

Each tape layer saves processing steps and cuts leadtimes.

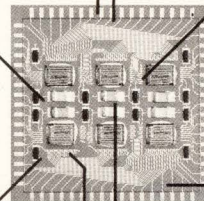

Vias are laser-drilled to control size reduction, increase density and improve reliability.

Lamination assures coverage control, improves trace resistance and reduces crosstalk.

Improved physical and electrical properties provide a dielectric constant approaching a K of 4.

Pacific Hybrid is ready now to put multichip modules to work for you fast. Just call!

10575 SW Cascade Blvd. Portland, OR 97223  
(503) 684-5657 FAX (503) 620-8051

**1-800-622-5574**

 **PACIFIC HYBRID**  
MICROELECTRONICS

**We do small miracles.™**

Copyright © 1991 Pacific Hybrid Microelectronics

CIRCLE NO. 26



# Power-factor-corrected switching power supplies

**Goaded by the IEC and encouraged by IC vendors, firms that make switching power supplies are starting to correct a long-standing problem: their products' propensity to draw nonsinusoidal line currents.**

Dan Strassberg, Associate Editor

**Y**ou designed your system conservatively. You know that the power supplies can handle their loads. When you figured out what the worst-case ac line current would be, you took the supplies' maximum dc output power, divided it by the supplies' efficiency, and then divided the result by the lowest line voltage at which you said the equipment would operate. But when the supplies are heavily loaded, every now and then the circuit breaker inexplicably trips. You tell yourself that the problem must be transient surges—that you just need a clean ac line or a circuit breaker that has a higher rating or a less aggressive current-vs-time trip characteristic.

If the preceding scenario sounds a bit too familiar, you should start to wonder about the power factor of the incoming ac. "Power factor?" you ask, somewhat incredulously. "But *electronics* engineers don't need to worry about power factor!" Power factor is something you heard about in a course on electrical machinery—one of those courses your adviser made you take because the

EE faculty thought all EEs ought to know something about machines. Neither you nor any of your friends could see the relationship between electrical machinery and the kind of work you wanted to do after graduation, so none of you paid much attention.

You remember, though: Power,  $P = EI \cdot \cos\theta$ . E and I are the rms values of sinusoidal voltage and current waveforms;  $\theta$  is the phase angle between them. Power factor,  $PF = \cos\theta$ . And then there was that dumb mnemonic they taught you about Eli the ice man. E (voltage) leads I (current) in an inductive circuit—one where inductance, L, predominates; I leads E in a circuit where capacitance, C, predominates. The preceding applies only when the voltage and current are sinusoidal. But, heck, back in that machinery course, the voltage and current were always sinusoidal.

If you think that the current drawn by most off-line switching power supplies is sinusoidal, think again. An off-line supply is one that first creates a high dc voltage by directly rectifying



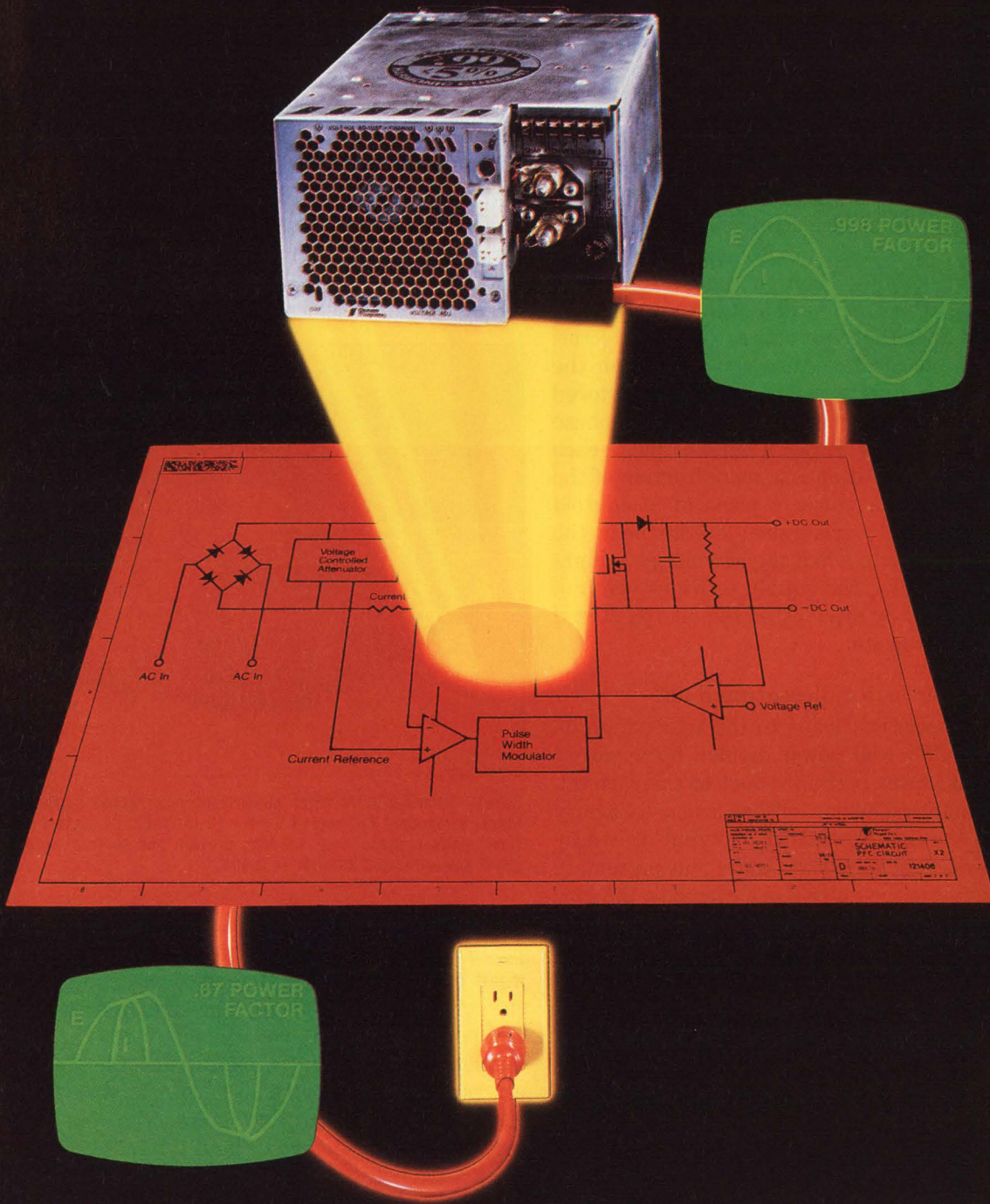

By using power-factor correction, a switching power supply can transform a harmonic-laden current into a safely consumable sinusoidal current. (Photo courtesy Pioneer Magnetics)



## If you think that the current drawn by most off-line switching power supplies is sinusoidal, think again.

and filtering the incoming ac, without first passing the ac through a transformer. The high dc voltage is converted to high-frequency ac, transformed (usually to a lower voltage), rectified, and filtered. In the initial stage of directly rectifying and filtering the ac line, most off-line switchers use capacitor-input filters.

"So," you say, "it's the capacitor-input filter that makes the power supply's input current lead the line voltage." Hardly—the combination of the supply's rectifiers and input filter capacitor acts as a peak detector; current flows to charge the capacitor only when the instantaneous ac voltage exceeds the voltage stored on the capacitor. In other words, in a single-phase system an off-line supply draws a current pulse each half cycle. The pulse duration is a small fraction of the half-cycle duration. The pulse, a piece of a sinusoid whose shape is called a haversine, occurs near the midpoint of the half cycle when the ac voltage is highest. Between the peaks, the supply provides continuous power to the load by drawing on the energy stored in the input filter capacitor.

### Will the real power factor please stand up?

The previous discussion leads to the real definition of power factor:  $PF = \text{real power} / \text{apparent power}$ . Apparent power is the product of the rms values of the line voltage (the line voltage is usually nearly sinusoidal) and the line current (the current drawn by most off-line switching supplies is quite nonsinusoidal). In such a supply you actually don't calculate the rms input current by dividing the supply's output power by its efficiency and dividing the quotient by the rms input voltage. The result of such a calculation would significantly understate the rms input current.

If you think about the problem in the frequency domain, you will remember that you can consider any periodic waveform to consist of a summation of sinusoids. If you integrate the product,

$$E_1 \cdot \sin(\omega t) \cdot I_n \sin(n\omega t + \Theta),$$

where  $n$  is the harmonic number, over one cycle of the fundamental, only when  $n=1$  is the result not zero. ( $E_1$  is the amplitude of the fundamental-frequency component of the line voltage.  $I_n$  is the amplitude of the  $n$ th harmonic component of the current.) Because the line voltage is essentially sinusoidal, but the current

is nonsinusoidal, only the current's fundamental-frequency component will affect the power. However, the harmonics present in the current waveform can have a profound effect on the rms value of the current.

The reason that the harmonics affect the rms current is that  $I_{\text{rms}}$  is the average over the waveform period of the integral of the square of the current. Every harmonic term is multiplied by itself. The integral of a sinusoid squared over one or more periods is always greater than zero. Therefore, although the harmonics in the nonsinusoidal current waveform contribute nothing to the power consumed by the supply, they can make the supply's rms input current considerably greater than the rms value of the fundamental-frequency component.



Several manufacturers offer power-factor-corrected supplies in the industry-standard fan-cooled 5 × 8 × 11-in. package. Jeta Power Systems' units produce 1 or 1.2 kW, provide one to four outputs, and boast power factors as high as 0.998.

The real power delivered to the supply is the output power divided by the efficiency. To obtain the rms input current, you must do one of two things: measure the current with a wideband ac ammeter or divide the real power by the line voltage and divide the resulting quotient by the power factor. Because the power factor can never be greater than 1, the supply's rms input current will almost always exceed the real power divided by the rms line voltage. A typical off-line switching supply will have a power factor of approximately 0.7, so the line current will be about 40% greater than you would calculate if you ignored power factor.

Supplies that have extra long "holdup" time—the time that they will continue to supply power to a load after the incoming ac power fails—can have even lower power factors. Off-line switchers with full-load power factors as low as 0.6 are common. At any given value



of load, a switching supply will exhibit the lowest power factor when its input line voltage is highest.

The harmonics' effect in inflating the rms current can cause other mischief besides the nuisance of tripping circuit breakers mentioned earlier. Suppose your system uses 900W of dc power and that you intend it to operate from an ordinary 120V, 15A branch circuit. According to Underwriters' Laboratories (UL), equipment connected to a "15A" circuit should draw no more than 12A for sustained periods. If your power supply is 75% efficient, its input power will be 1200W. If you specify your system to operate normally when the line voltage drops to 100V, it will draw a maximum current of 12A—provided the power factor is 1.

If the power factor is 0.7, the current will exceed 17A rms. That value is not merely greater than the derated value of 12A that is considered safe on a sustained basis in "15A" circuits; it is greater than the circuit's 15A rating. If a system with a supply having a 0.7 power factor and 75% efficiency is to operate for long periods with a line voltage of 100V on a (nominally) 120V, 15A branch circuit in the US, it must consume no more than 630W of dc power.

Three-phase, 4-wire "wye-connected" power systems can have an even more insidious problem. In such systems, loads are connected from each phase to neutral. If the load currents are sinusoidal, equal, and in phase with the phase voltages, the current in the neutral wire will be zero. But if the loads consist of switching power supplies that draw nonsinusoidal currents, even if the fundamental-frequency components are equal and are in phase with the phase voltages, the harmonic currents that flow in the neutral wire are unlikely to cancel.

In fact they can add in such a way that the rms value of the neutral current exceeds the current in any phase. It is customary for the neutral wire to be of the same gauge (diameter) as the phase wires. For a 3-phase system's neutral wire, choosing a wire gauge that equals the gauge of the phase wires is thought to be a conservative practice. After all, under ideal conditions, the neutral wire carries no current. But because of harmonics, the neutral wire can, in some cases, carry a current larger than the currents in the phase wires, and so should be of a larger gauge.

The situation described in the previous paragraph reveals the possibility that circuit breakers could fail to protect a building's wiring. For safety reasons, circuit breakers do not interrupt the neutral leg of 3-phase power systems. If the neutral conductor carries an rms current that is, say, 25% higher than the current in any phase conductor, there is a possibility of excessive temperature rise in the neutral conductor and,

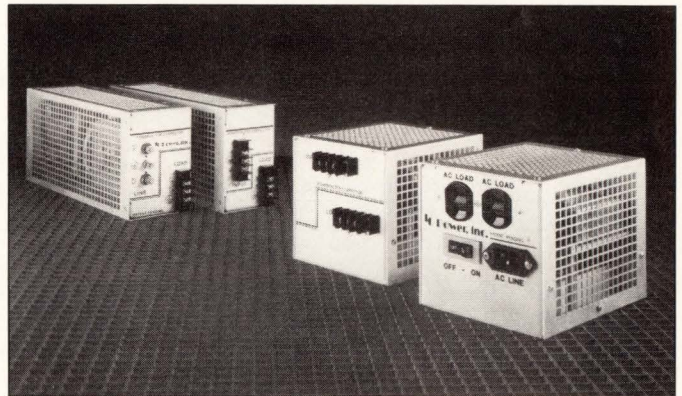

If you don't want to switch to a new power-supply model or a new vendor, you may be able to add a PFC module between the ac line and your existing supply. These ac-in/ac-out units from HC Power offer power factors of 0.98 with 98% efficiency. Power ratings range from 500 to 4000W.

over time, damage to the wiring insulation. (Remember, the temperature rise is proportional to the square of the current.) In existing buildings, changing the wiring to correct this potential problem is an expensive proposition. Eliminating the source of the problem—the harmonic currents—is a better solution.

### IEC 555-2, a power-factor standard

The preceding discussion demonstrates that the growing use of switching power supplies in electronic equipment is making power factor increasingly important. The problem is becoming so significant that the International Electrotechnical Commission (IEC) has drafted a standard for power-factor correction (PFC). The standard, IEC 555-2, applies to equipment that operates from 220V (nominal) ac lines. Unless there is an unforeseen delay, beginning in 1992, equipment covered by the standard and sold in Europe will have to comply. More about IEC 555-2 later.

Ever since the invention of the off-line switching power supply, a technique has existed for increasing the supplies' power factor considerably beyond 0.7. That technique, which really predates the invention of the off-line switcher, is the use of LC (inductive-capacitive) input filters. The problem with LC input filters is that they use inductors (chokes) that are large, heavy, and somewhat expensive. Hence, using inductors in an off-line switcher's input filter network does away with at least part of the advantage of switching technology over linear power-supply technology. Even so, because of the technique's inherent simplicity and reliability, several manufacturers continue to introduce new supplies that use LC filters for power-factor correction.

Filter inductors that operate at line frequency (or



**Table 1—Representative power-factor-corrected switching power supplies<sup>1</sup>**

Vendor	Product	When introduced	US price <sup>2</sup>	Added cost for PFC <sup>3</sup>	Maximum output power	Has own fan(s)?	Dimensions (inches)	Number of outputs	Input voltage and frequency
Abbot	AW and AM	11/90	\$900 (1)	20%	75W	No	2x2x0.85	Multiple	103.5 to 126.5
Astec	JF201	1990	\$991 (1)	NA <sup>5</sup>	2 kW	Yes	5x8x10	1	180 to 264V 1 or 3 phase
Computer Products	Special	1986	Varies <sup>6</sup>	\$100 (OEM qty)	1500W	Varies <sup>6</sup>	Varies <sup>6</sup>	Varies <sup>6</sup>	90 to 130V 180 to 260V 47 to 63 Hz
Deltron	FM Series	Q2 '91	\$705 to \$827 1 kW (OEM qty) 2 kW \$1131 to \$1358	\$325 1 kW \$410 2 kW	1 kW 2 kW	Option (1 kW) Yes (2 kW)	1 kW: 12x6.5x2.5 2 kW: 5x12x6.5	1 kW: 1 to 7 2 kW: 1 to 8	1 kW: 90 to 264V 2 kW: 180 to 264V Both: 47 to 63 Hz
HC Power	Power-miser	1988	\$300 Stand-alone PFC	Not applicable	250W to 4 kW	3 kW and 4 kW only	5x3.5x11.25 to 1 kW	1: ac to ac to dc supply	90 to 132 V or 180 to 246V
	HC1010	4/91	\$1450 (1)	\$300	1 kW	Yes	5x8x11.25	1 to 4	90 to 264V 47 to 63 Hz
	HC1501	4/91	\$1500	\$300	1.5 kW	Yes	5x8x11.25	1	90 to 264V 47 to 63 Hz
Jeta	N100x	3/90	Under \$900 (OEM qty)	Under \$100	1 kW	Yes	5x8x11	As many as 4	90 to 264V
	N120x	3/90	Under \$1000 (OEM qty)	NS	1.2 kW	Yes	5x8x11	As many as 4	90 to 264V
Kepeco	Ray Series	11/90	\$2395	NA <sup>5</sup>	3 kW	Yes (3)	4.3x13.4x12.7	1	170 to 264V 3 phase
Lambda	SMS-1500 SMM-1500	8/89	SMM: \$1479 to \$1698 (100)	NA <sup>5</sup>	1.5 kW	Yes	5x8x11	SMS: 1 SMM: 1 to 5	176 to 264V 48 to 65 Hz
LH	PSMA line	1989	750W: \$1055 (1) 2 kW: from \$1700 (1)	\$350 to \$400	0.75, 1, 1.25, 1.5, 2 kW	Yes	5x8 Depth 10 to 14 <sup>8</sup>	1 to 4	85 to 264V
NCR Power	680W 4 output	Q2 '91	\$500	10%	680W	No. You provide 100 cfm	11.25x15.35x3.82	4	180 to 257 V 49 to 60.6 Hz
Pioneer Magnetics	PM3187A	11/90	\$1485 (1)	\$250	1344W	Yes	5x8x12.25	2 to 5	96 to 264V 47 to 63 Hz
Power One	SPF4 Series	12/90	1250W: \$1403 (1), \$1091 (OEM qty)	\$260 (1) \$204 (OEM qty)	1.35 kW (120V) 1.5 kW (240V)	Yes	5x11 Width: 3 to 8 <sup>9</sup>	1 to 12	85 to 264V 47 to 63 Hz
Puls	PS 1000	1989	Under \$3000 (OEM qty)	NA <sup>5</sup>	4 kW	Yes	16.8x16.9x6.9	4	230V 1 phase 115V 3 phase 230V 3 phase
Sorensen	DCS Series	Q3 '91	\$3500 (1)	NA <sup>5</sup>	3 kW	Yes	3.5x19x18	1 variable	190 to 253V 47 to 63 Hz
Todd Products	Max-1000 line	4/91	\$1150 (1), \$800 (OEM qty)	\$80 to \$100 1 kW (OEM qty)	1 kW	Option <sup>10</sup>	8x12x3.4 with fan	4	90 to 264V 47 to 63 Hz
Transistor Devices	MPS Series	12/90	\$1096 to \$1750 (100)	NA <sup>5</sup>	1 kW/module; 3 kW/5.25 in.	Yes	Modules: 5.22x5.3x18.1	1 to 5	88 to 264V 47 to 63 Hz
	BCE Series	1984	\$4000 (100)	NA <sup>5</sup>	3450W	Yes	6.75x8.25x15.88	1	103 to 264V 47 to 63 Hz 1 phase
Unipower	F Series	4/90	\$808 (1 output) \$920 (multiple output) (100)	\$158	1.5 kW	Yes	4x5x12	1 to 7	90 to 132 V 180 to 264V autoranging 47 to 63 Hz

Notes: NS=Not specified.

<sup>1</sup>Power-factor correction is sometimes abbreviated as PFC.

<sup>2</sup>The figure in parentheses indicates the approximate quantity at which the price applies. "OEM qty" refers to large quantities that, for competitive reasons, the vendor does not wish to describe completely. Prices shown include the added cost for PFC.

<sup>3</sup>At quantity indicated in the Price column (compared with vendor's closest equivalent supply without PFC).

<sup>4</sup>At full load and maximum line voltage.

<sup>5</sup>PFC not available as an add-on option.



## PFC switching power supplies

Minimum <sup>4</sup>		Comments
Efficiency (%)	Power factor	
65%	0.9	MIL spec; 47 to 440 Hz.
80% typ	0.95 3 phase	
70%	Not specified	Auto switching between input-voltage ranges.
70 to 80% Depends on output voltage	0.99	5W/in. <sup>3</sup> ; modular construction allows quick delivery of custom units.
98%	0.98 (50% load)	Stands between ac line and supply that lacks PFC.
70%	0.99	Can directly replace supplies lacking PFC.
70%	0.99	
70%	0.998	Supplies 1 kW while drawing 12A at 115V.
70%	0.998	Meets IEC 555-2.
80% typ	0.92 typ	Meets FCC class A EMI requirements. <sup>7</sup>
80%	0.95	Meets VDE 0871 level B.
72 to 73%	0.99	
65%	0.99 (low line)	All outputs battery-backed by external 48V battery.
70%	0.99	Meets IEC 555-2 and VDE 0871 level A.
77% typ	0.95	Meets UL1950(D3); meets VDE 0871 level A at 230V.
90%	0.7 0.9 0.9	Meets VDE 0871 level B; for mobile use in high RF environment.
85%	0.99	Output ranges: 0 to 8V to 0 to 600V.
75%	0.99	Takes less than half 5x8x11 unit's volume.
72% (5V) 80% (higher voltage)	0.95	Modular system for 19-in.-rack mounting; "hot" switching with isolation diodes.
83 to 87%	0.95	Options include battery charger and military components.
70 to 80% (Depends on outputs)	0.98	Designed to meet IEC 555-2; meets UL1950, CSA22.2 number 220, TUV/IEC 950 and VDE0806.

<sup>4</sup>PFC is offered in custom products. Price depends on requirements.

<sup>7</sup>EMI stands for electromagnetic interference.

<sup>8</sup>Depth depends on power and number of outputs.

<sup>9</sup>Width depends on power and number of outputs.

<sup>10</sup>Unit without fan needs user-supplied air. Size: 8x10.5x3.38 in.

twice line frequency, as does an inductor that follows a full-wave rectifier in a single-phase system) must often be larger than transformers that handle the same amount of power at the same frequency. Although the inductors usually have only one winding, whereas transformers, except for autotransformers, have two or more, the inductor windings must carry dc, which tends to saturate the inductor cores. To prevent saturation, the cores often include air gaps. Even though air gaps help to stabilize a choke's inductance, they lower its inductance and frequently necessitate the use of larger cores.

Correcting an off-line switching supply's power factor by using inductors in its input filter is called passive power-factor correction. Power-factor-correction (PFC) schemes that use active circuits can overcome many of the drawbacks of passive PFC. Within the last two years or so, semiconductor vendors have introduced ICs that make possible power factors very close to 1 (Table 1). Although PFC circuits based on special-purpose ICs are more complex than those based on passive approaches, they require the addition of fewer components than were used by earlier discrete active PFC circuits.

Moreover, some active PFC techniques improve more than just power factor. For example, some PFC circuits furnish a supply with an input voltage that, regardless of the line voltage, always corresponds to the high end of the supply's input range. As a result, the supply's holdup time—its ability to "ride through" brown outs or short-duration outages—increases. The energy stored in a capacitor (in this case, the input filter) is proportional to the square of the voltage across the capacitor, so a 30% increase in voltage yields a nearly 70% increase in holdup time. Such an increase is quite significant. Because PFC circuits can attenuate input-voltage fluctuations, incorporating PFC can improve a supply's line regulation. But as should already be clear, including PFC does raise a supply's cost.

### Active correction uses preregulator

The basic technique used by most active PFC schemes is to precede the supply with a high-frequency switching preregulator that, over the course of an ac-line cycle, draws current from the line approximately in inverse proportion to the instantaneous line voltage. If the preregulator operates at 100 kHz, it completes 833 switching cycles in 1/2 cycle of a 60-Hz line.

Near the line-voltage zero crossing, the preregulator draws line current most of the time. As the instantaneous voltage increases, the percentage of time that the preregulator draws current decreases. The result is a



## PFC switching power supplies

**You don't calculate the rms input current by dividing the supply's output power by its efficiency and dividing the quotient by the rms input voltage.**

current waveform that, when filtered, nearly mimics the line-voltage waveshape. If the current and voltage waveforms are exactly alike and coincide in phase, the power factor will equal 1. In practice, vendors readily achieve power factors of 0.95. Some companies claim that their supplies exhibit power factors greater than 0.99.

Power-factor-correcting switching preregulators use inductors to store energy. But like the magnetic components in switching power supplies themselves, these inductors operate at high frequencies. Therefore, they can be smaller, lighter, and less expensive than magnetic components that operate at line frequencies. Furthermore, a preregulator can act as an ac-to-dc converter, subsuming the functions of a conventional rectifier and filter and furnishing the high-voltage dc that switching supplies use internally. Combining the PFC and ac-to-dc-conversion functions in a single circuit eliminates some redundancy and thereby reduces the incremental cost of power-factor correction.

Adding the PFC function usually exacts a small penalty in a supply's efficiency. Where a vendor furnishes both power-factor-corrected and uncorrected versions of a supply, it might specify typical efficiencies of, say, 70% for the PFC version and 72% for the uncorrected version. Such a decrease in efficiency is equivalent to a 7% increase in the supply's internal power dissipation and temperature rise. That increase, however, has a minimal effect on the line current the supply draws, especially when you compare the size of the increase to the large decrease brought about by PFC.

"But," you say, "I don't design equipment that draws kilowatts, and I certainly don't design equipment that uses 3-phase power. So I don't have to concern myself with power-factor correction." You may be surprised to discover that PFC is likely to affect you anyhow. If you design equipment that operates from 220V ac lines and will be sold in Europe beginning in 1992, it will probably have to conform to IEC 555-2. IEC 555-2 imposes limits on line-current waveshapes and harmonic content that will require many products that use off-line switching power supplies to incorporate PFC. As for your product not using 3-phase power, remember that in most factory and office buildings the single-phase ac lines are derived from 3-phase service.

"OK," you concede, "but what of it? I can just go to my power-supply vendor and get him to substitute a PFC supply for one that lacks the feature." In many cases, you may indeed be able to do just that. But, at present, the number of situations where that approach won't work probably exceeds the number where it will. In some cases, you will be able to obtain an accessory PFC module that you can place between the incoming ac line and your existing power supply or supplies. You may even be able to selectively install the PFC module—for example, only on units going to Europe. Nevertheless, blindly applying PFC, even on a fraction of the units you produce, can unnecessarily increase the cost of your product. You'd be better off understanding when you really need PFC and designing it in intelligently.

IEC 555-2 defines four classes of equipment, A through D. Electronic equipment falls into classes A and D. Class A equipment requires 3-phase ac service. The majority of electronic products use single-phase power and hence fall in class D. Class D distinguishes between equipment that consumes less than 300W of ac power and equipment that uses 300W or more. In the less than 300W category, permissible harmonic currents are proportional to the equipment's power level. And at more than 300W, the limits become absolute; they permit the equipment to draw a number of amperes that depends on the harmonic number but is independent of the power consumed. By writing the specification in this manner, the IEC essentially forced higher power-factor requirements on equipment that uses higher levels of power.

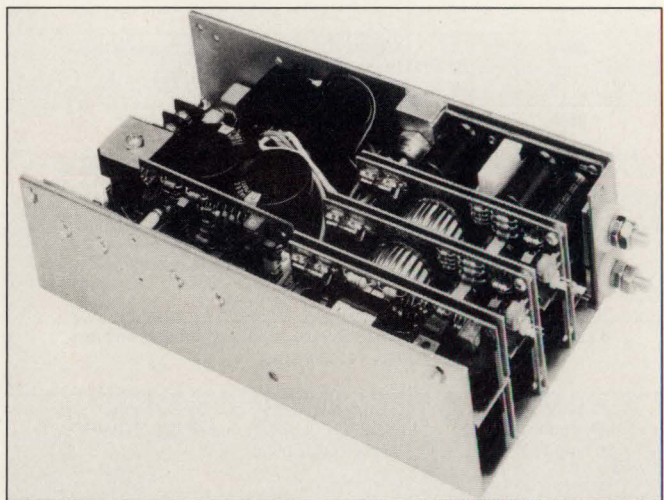

**Specifying a PFC supply doesn't mean you necessarily have to choose a look-alike product. Deltron's Moduflex series uses modular construction to accomplish twin objectives: The power density is very high—as high as 5W/in.<sup>3</sup>—and the firm quotes rapid delivery on custom multiple-output units.**



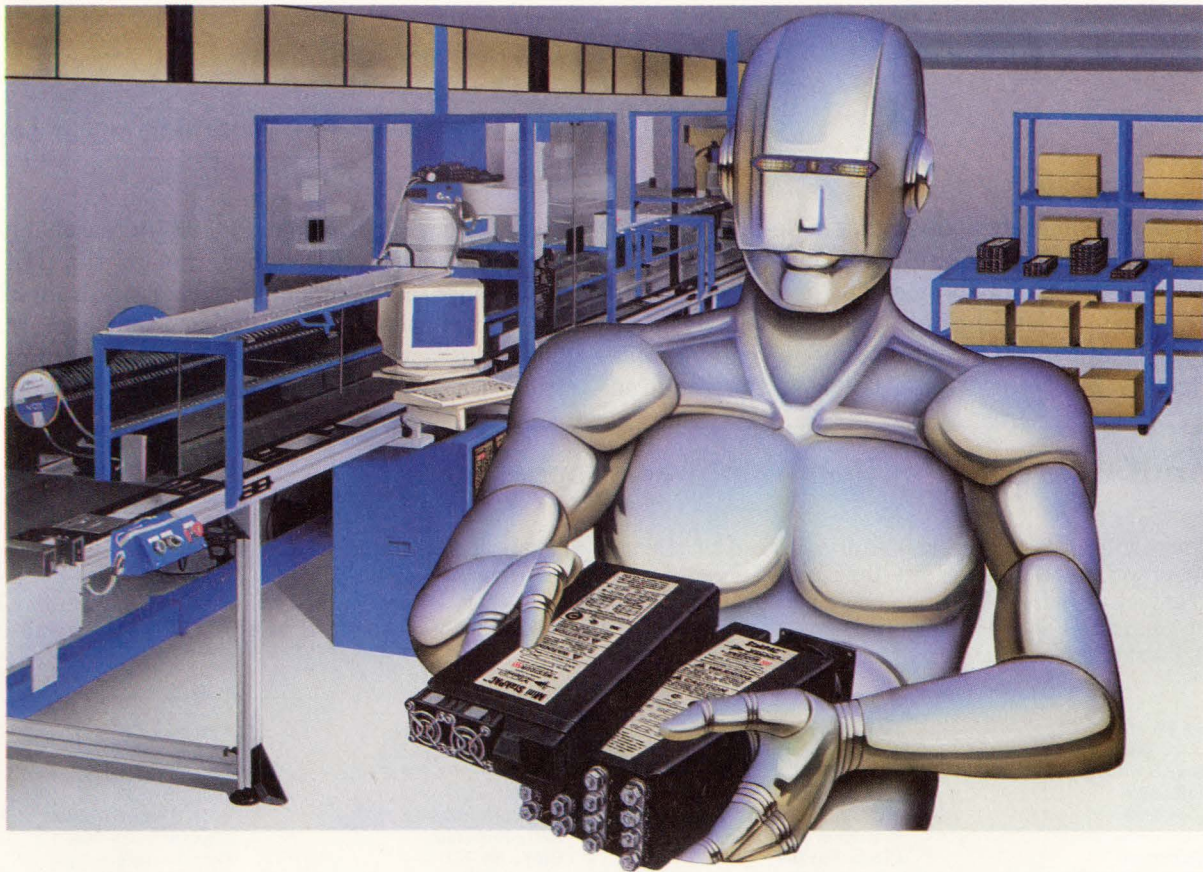

# ROBOPOWER

STAKPAC™		MINI STAKPAC™
1200 Watts	<b>Power</b>	600 Watts
110/220 VAC	<b>Input</b>	110/220 VAC
Up to 8	<b>Outputs</b>	Up to 5
3.2"x5.5"x11.5	<b>Dimensions</b>	1.9"x5.5"x12"
Fan-Cooled	<b>Cooling</b>	Twin Fans

Each StakPAC output is factory configured utilizing Vicor's robotically manufactured power converters...VI-200 series modules. Consider the advantages of a StakPAC customized for your system needs with automatized power modules: **USER DEFINABLE OUTPUTS**—The use of proven standard catalog modules offers the features of a custom without the associated risk or investment.

**STANDARD MODELS**—Many preconfigured standards available.

**QUICK DELIVERY**—Typical delivery 1 week or less for custom or standard evaluation units.

**COMPACTNESS**—Low profile packages provide up to 6 watts/cubic inch, twice the industry norm.

**UL, CSA, TUV SAFETY AGENCY APPROVAL**—All StakPAC configurations are approved, standard or custom.

**EMI**—FCC/VDE Level A, conducted.

StakPACs are designed and built by Westcor Corporation, Los Gatos, CA, a Vicor subsidiary. StakPACs are sold world-wide through Vicor Corporation, Andover, MA.

## STAKPAC STANDARDS 1200 WATT MODELS

Model	Output Voltage (VDC) and Maximum Current (amperes) per Channel				
	#1	#2	#3	#4	#5
<b>Single Output</b>					
SP1-1801	2 @ 240	Total output power may not exceed 1200* watts for any model, single or multiple output. Lower power StakPAC models and many other configurations are available. *Standard models supply 1100 watts; high-powered version 1200 watts. Please contact the factory.			
SP1-1802	5 @ 240				
SP1-1603	12 @ 100				
SP1-1604	15 @ 80				
SP1-1605	24 @ 50				
SP1-1606	28 @ 42				
SP1-1607	48 @ 25				
<b>Dual Output</b>					
SP2-1801	2 @ 120	5 @ 120			
SP2-1802	5 @ 120	5 @ 120			
SP2-1803	5 @ 120	12 @ 66			
SP2-1804	12 @ 66	12 @ 66			
SP2-1805	15 @ 53	15 @ 53			
<b>Triple Output</b>					
SP3-1801	5 @ 180	12 @ 16	12 @ 16		
SP3-1802	5 @ 150	12 @ 33	12 @ 16		
SP3-1803	5 @ 180	15 @ 13	15 @ 13		
SP3-1804	5 @ 150	15 @ 26	15 @ 13		
<b>Quad Output</b>					
SP4-1801	5 @ 150	12 @ 16	12 @ 16	5 @ 30	
SP4-1802	5 @ 150	15 @ 13	15 @ 13	5 @ 30	
SP4-1803	5 @ 150	12 @ 16	12 @ 16	24 @ 8	
SP4-1804	5 @ 150	15 @ 13	15 @ 13	24 @ 8	
<b>Five Output</b>					
SP5-1801	5 @ 120	12 @ 16	12 @ 16	5 @ 30	24 @ 8
SP5-1802	5 @ 120	15 @ 13	15 @ 13	5 @ 30	24 @ 8
<b>Seven Output</b>					
SP7-1801	5 @ 60	12 @ 16	12 @ 16	24 @ 8	24 @ 8
	#6	#7			
	5.2 @ 28	2 @ 30			

## MINI STAKPAC STANDARDS 600 WATT MODELS

Model	Output Voltage (VDC) and Maximum Current (amperes) per Channel				
	#1	#2	#3	#4	#5
<b>Single Output</b>					
ST1-1401	2 @ 120	Total output power may not exceed 600 watts for any model, single or multiple output. Lower power Mini StakPAC models and many other configurations are available. Please contact the factory.			
ST1-1402	5 @ 120				
ST1-1301	12 @ 50				
ST1-1302	15 @ 40				
ST1-1303	24 @ 25				
ST1-1304	28 @ 21				
ST1-1305	48 @ 13				
<b>Dual Output</b>					
ST2-1401	2 @ 60	5 @ 60			
ST2-1402	5 @ 60	5 @ 60			
ST2-1403	5 @ 60	12 @ 33			
ST2-1404	12 @ 33	12 @ 33			
ST2-1405	15 @ 26	15 @ 26			
<b>Triple Output</b>					
ST3-1401	5 @ 60	12 @ 16	12 @ 16		
ST3-1402	5 @ 60	15 @ 13	15 @ 13		
ST3-1501	5 @ 90	12 @ 8	12 @ 8		
<b>Quad Output</b>					
ST4-1401	5 @ 30	12 @ 16	12 @ 16	5 @ 30	
ST4-1402	5 @ 30	15 @ 13	15 @ 13	5 @ 30	
ST4-1403	5 @ 30	12 @ 16	12 @ 16	24 @ 8	
ST4-1501	5 @ 30	15 @ 13	15 @ 13	24 @ 8	
ST4-1502	5 @ 60	12 @ 16	12 @ 8	5 @ 15	
ST4-1503	5 @ 60	15 @ 13	15 @ 7	5 @ 15	
ST4-1504	5 @ 60	12 @ 16	12 @ 8	24 @ 4	
ST4-1505	5 @ 60	15 @ 13	15 @ 7	24 @ 4	
<b>Five Output</b>					
ST5-1501	5 @ 30	12 @ 16	12 @ 16	5 @ 15	24 @ 4
ST5-1502	5 @ 30	15 @ 13	15 @ 13	5 @ 15	24 @ 4

For ordering information call Vicor Express at 1-800-735-6200 or (508) 470-2900 at ext. 265.

For technical information contact Westcor at (408) 395-7050 or FAX (408) 395-1518 or call Vicor.



VICOR CORPORATION

Common Stock Traded on NASDAQ under "VICR"

### WESTCOR CORPORATION

485-100 Alberto Way  
Los Gatos, CA 95032

### VICOR CORPORATION

23 Frontage Road  
Andover, MA 01810



Below approximately 350 watts, single-phase equipment will not usually require power-factor correction, provided the power supply does not exhibit especially high efficiency or long holdup time. At slightly more than 1 kW, passive PFC will probably no longer enable a product to meet the spec. At 2 kW, the required

power factor is approximately 0.98—a reasonably stringent requirement. Remember, though, that IEC 555-2 applies only to equipment that operates from 220V. If you apply its limits to equipment that operates from 120V, the power-factor requirements become more stringent. There is no indication, however, that the

### Manufacturers of switching power supplies with PFC

For more information on power-factor-corrected switching power supplies such as those described in this article, circle the appropriate numbers on the Information Retrieval Service card or use EDN's Express Request service. When you contact any of the following manufacturers directly, please let them know you read about their products in EDN. Some companies have provided the name of a person to contact should you need more information than you find in their literature.

**Abbott Electronics**  
2727 La Cienega Blvd  
Los Angeles, CA 90034  
(213) 202-8820  
(213) 936-8185  
FAX (213) 939-1995  
Hamid Emami  
FAX (213) 836-1027  
Circle No. 650

**Astec America**  
401 Jones Rd  
Oceanside, CA 92054  
(619) 757-1880  
FAX (619) 439-4243  
Ron Sutton  
(619) 439-4337  
Circle No. 651

**Cherokee International**  
2841 Dow Ave  
Tustin, CA 92680  
(714) 544-6665  
FAX (714) 838-4742  
Circle No. 652

**Computer Products/  
Power Conversion**  
3797 Spinnaker Ct  
Fremont, CA 94538  
(415) 657-6700  
FAX (415) 683-6400  
Forrest Sass  
Circle No. 653

**Deltron Inc**  
Wissahickon Ave  
North Wales, PA 19454  
(800) 523-2332  
in PA, (215) 699-9261  
FAX (215) 699-2310  
Jack Phillips  
Circle No. 654

**HC Power Inc**  
17032 Armstrong Ave  
Irvine, CA 92714  
(714) 261-2200  
FAX (714) 261-6584  
Jack Graham  
Circle No. 655

**Jeta Power Systems Inc**  
2675 Junipero  
Signal Hill, CA 90806  
(213) 427-0095  
FAX (213) 426-2417  
H R Modi or Ed Feher  
Circle No. 656

**Kepeco Inc**  
131-38 Sanford Ave  
Flushing, NY 11352  
(718) 461-7000  
FAX (718) 767-1102  
Circle No. 657

**Lambda Electronics**  
515 Broad Hollow Rd  
Melville, NY 11747  
(800) 526-2324  
in NY, (516) 694-4200  
FAX (516) 293-0519  
Ron Koslow  
Circle No. 658

**LH Research**  
14402 Franklin Ave  
Tustin, CA 92680  
(714) 730-0162  
FAX (714) 669-2562  
Steven D Johnson  
Circle No. 659

**Magnetek Defense Systems Inc**  
901 E Ball Rd  
Anaheim, CA 92085  
(714) 956-9200  
FAX (714) 956-5397  
Sandra L Schaffer  
Circle No. 670

**Modular Devices Inc**  
4115 Spence St  
Torrance, CA 90503  
(213) 542-8561  
FAX (213) 371-6331  
Circle No. 671

**NCR Power Systems**  
584 S Lake Emma Rd  
Lake Mary, FL 32746  
(407) 333-9250  
FAX (407) 333-8312  
Zelda Kuszmaul  
Circle No. 672

**Pioneer Magnetics**  
1745 Berkeley St  
Santa Monica, CA 90404  
(800) 233-1745  
in CA, (800) 848-1745  
(213) 870-9505  
FAX (213) 453-3929  
Arnold Hagiwara  
Circle No. 673

**Power One**  
751 Daily Dr  
Camarillo, CA 93010  
(805) 484-2806  
FAX (805) 388-0476  
Pauline Cadena  
(805) 987-8741  
Circle No. 674

**Puls Elektronische  
Stromversorgungen GmbH**  
Arabellastr 17  
D-8000 Munchen 81, Germany  
(89) 9278-0  
FAX (89) 9278-299  
W D Roth (89) 9278-234  
Circle No. 675

**Qualidyne Systems Inc**  
3055 Del Sol Blvd  
San Diego, CA 92154  
(619) 575-1100  
FAX (619) 429-1011  
Circle No. 676

#### VOTE . . .

Please also use the Information Retrieval Service card to rate this article (circle one)

High Interest 494 Medium Interest 495 Low Interest 496

**Sorensen Co**  
5555 N Elston Ave  
Chicago, IL 60630  
(800) 525-2024  
in IL, (312) 775-0843  
FAX (312) 775-7432  
Gary Braaten, ext 346  
Circle No. 677

**Todd Products**  
50 Emjay Blvd  
Brentwood, NY 11717  
(516) 231-3366  
FAX (516) 231-3473  
Frank Sposato  
Circle No. 678

**Transistor Devices**  
274 Salem St  
Randolph, NJ 07849  
(201) 361-6622  
FAX (201) 361-7665  
Don Fedderly  
Circle No. 679

**Unipower Corp**  
2981 Gateway Dr  
Pompano Beach, FL 33069  
(305) 974-2442  
FAX (305) 971-1837  
Warren Peters  
Circle No. 680



# Sprague®

LOW  
ESR & MORE.



8008P89(399)

## Sprague solid tantalums meet many SMPS needs.

Sprague Type 550D Solid-Electrolyte Tantalex® Capacitors, designed for use in power supply filters at frequencies to 100 kHz, feature extremely low ESR and high ripple current capability. Maximum ESR for a 300  $\mu\text{F}$ , 6 VDC unit is only 0.045 $\Omega$  at 100 kHz. Additional ad-

vantages include small size, long life, exceptional capacitance stability and hermetic seal to withstand severe environments. Capacitance values: 5.6 to 330  $\mu\text{F}$ . Voltage ratings: 50 to 6 WVDC. Write for Engineering Bulletin 3548 to Technical Literature Service,

Sprague Electric Company, 41 Hampden Road, P.O. Box 9102, Mansfield, MA 02048-9102.





## PFC switching power supplies

**Some PFC circuits furnish a supply with an input voltage that, regardless of the line voltage, always corresponds to the high end of the supply's input range.**

IEC intends these limits to apply to 120V equipment. **Table 2** shows the IEC 555-2 Class D current limits as a function of harmonic number.

Given the information in the paragraph above, it is not surprising that most of the power supplies listed in **Table 1** are units that produce 500W or more. Note that the power figures given in **Table 1** are supply output powers; to obtain the input power (**Table 2** refers to input power), divide the output power by the efficiency. Remember, too, that if you draw less than a supply's full-rated power, its efficiency will be less than the value shown in **Table 1**. With no load, all supplies have zero efficiency!

Yet another fact to bear in mind is that, without PFC, as a supply's load decreases, so does its power factor. (Long holdup times indicate low power factors; lightly loaded supplies can have very long holdup times. Suppose you choose a supply that, at full load, requires PFC to meet IEC 555-2, but you never operate the supply at more than 50% of full load—a conservative practice that can greatly increase the supply's reliability. From this discussion, you can probably conclude that the supply should still incorporate PFC.

### Universal operation can be a PFC bonus

Many of the listed supplies have so-called universal input ranges. That is, you can vary the input voltage from, say, 90 to 264V without resetting any switches or changing any jumpers. Moreover, the supply vendors often indicate that you can protect the supply over this entire range with a fuse or circuit breaker of a single rating. In some cases, this universal operation is a direct consequence of PFC. As noted earlier, the preregulators in some PFC supplies produce a constant, high-output voltage over a wide input-voltage range.

For products that you will ship to customers in Europe and Asia as well as in North America, such universal operation can greatly simplify configuration, testing, and packaging. Frequently, if your product uses a universal-input supply, the only item you need change as a function of its destination is the power cord. Rather than including a cord appropriate to a specific location, some equipment vendors actually package sets of cords with their products. Other firms

**Table 2—IEC 555-2 Class D harmonic-current limits**

Harmonic order (n)	Equipment that draws less than 300W of ac power Relative limits (mA/W)	Equipment that draws 300W or more of ac power Absolute limits (A)
<b>Odd harmonics</b>		
1 <sup>1</sup>	4.55	Power/Voltage
3	3.6	1.08
5	2.0	0.60
7	1.5	0.45
9	1.0	0.30
11 through 39	0.6* (11/n)	0.18* (11/n)
<b>Even harmonics</b>		
2	1.0	0.3
4	0.5	0.15

**Note:** <sup>1</sup>IEC 555-2 does not specify the limits on the fundamental-frequency component of current. The values shown were obtained by dividing the applicable power by the nominal line voltage specified (220V). The equipment would draw a current of this magnitude if the phase angle between the line voltage and the fundamental component were zero.

have their foreign distributors provide suitable cords when they install the equipment.

Power-factor correction is not for every product. Although most ac-powered products would actually benefit from using PFC supplies, the incremental cost of PFC will prevent the technique from being adopted universally. Nevertheless, under the impetus of IEC 555-2, and with the encouragement of the IC vendors whose chips are simplifying the job of incorporating PFC in power supplies, its use will spread. As PFC's use spreads, its cost will come down. As its cost comes down, its use will spread further. There can be little doubt that PFC is a technique whose importance is destined to grow in the years ahead. **EDN**

### Acknowledgment

*In addition to the power-supply manufacturers, several firms provided assistance in preparing this article: Venture Development Corp, a market-research organization in Natick, MA; and the following manufacturers of PFC ICs: Ixys Corp, San Jose, CA; Micro Linear, San Jose, CA; and Unintegrated Circuits Corp, Merrimack, NH.*

Article Interest Quotient (Circle One)  
High 494 Medium 495 Low 496



**Actual size**

**Actual output**

20 WATTS

**Now AC to DC**

**Actually meets**

MIL-STD-2000  
MIL-STD-810C  
MIL-S-901C  
MIL-STD-461C  
MIL-STD-704D  
NAVMAT GUIDELINES

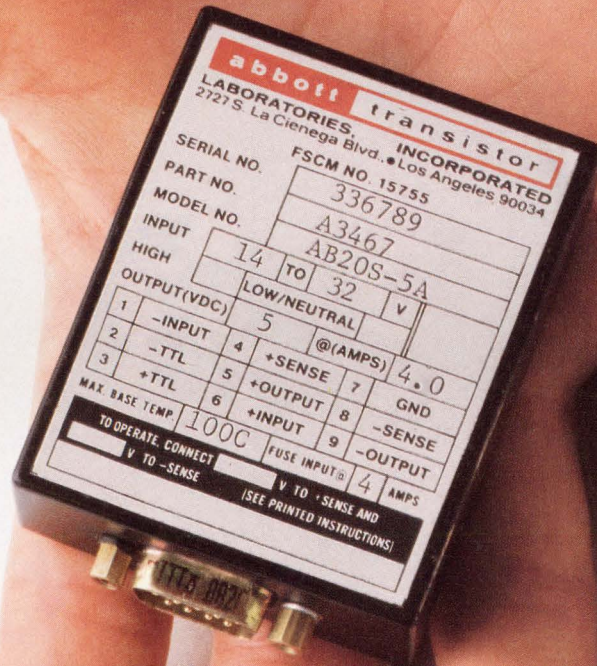

**Mil/Pac™ high-density military power supplies.**

Now you can order Abbott's full mil-qualified compact power supplies in both DC and AC input models.

Mil/Pacs come in 20W, 35W and 50W configurations, with single (5, 12, 15, 24, or 28V) or dual ( $\pm 12V$ ;  $\pm 15V$ ) outputs.

DC-to-DC models accept input from 14V to 32V. AC-to-DC models accept 103.4 to 126.5V rms, 47-440 Hz single phase.

All Mil/Pacs operate at temperature extremes from

-55°C to +100°C. All are designed with a field-proven topology that has been verified by rigorous environmental stress screening.

Mil/Pacs are available with or without MIL-STD-2000. Either way, the specs are worth reading. Just write us at 2727 South La Cienega Bl., Los Angeles, CA 90034. Or call (213) 936-8185.

**abbott**

**WHEN RELIABILITY IS IMPERATIVE.™**



IN THE ERA OF MegaChip™ TECHNOLOGIES

# Sometimes you need easy

“Sorry, guys.  
There’s been a last-minute  
change in the spec.”





# ASIC. TI FPGAs.

These are the gate arrays you design at your desk. And redesign until they're exactly right. Then it's on to silicon — fast. Our free interactive diskette will show you just how easy *easy* can be.

Even when you hit last-minute changes, have a sudden inspiration or are simply intent on getting the job done, field programmable gate arrays (FPGAs) from Texas Instruments can speed your design from start to finish.

Our FPGAs are channeled devices, which gives them their true gate array characteristics. They combine the time-to-market advantages of programmable logic devices (PLDs) with the densities of gate arrays. You have a choice of 1,200 or 2,000 equivalent gate complexities, with 4K and 8K densities coming. And military versions are available too.

Throughout the design cycle, you are in complete control, minimizing risk and avoiding nonrecurring engineering costs.

## Accelerated development

Our advanced development environment, the TI Action Logic™ System (TI-ALS), lets you design and redesign at your desk. You use TI-ALS to validate, automatically place and route, analyze, program, test and debug — all *within hours*.

You can always see what's going on within your design. Only the unique antifuse architecture allows 100% observability of internal nodes. And you can achieve gate utilizations of up to 90%.

TI-ALS operates on '386 personal computers or popular workstations

running familiar CAE tools. You can program in minutes using our Activator™ hardware.

## Unmatched service and support

From hands-on workshops at our Regional Technology Centers to a global network of sales offices and distributors, only TI can meet your FPGA needs across the country and around the world.

What's more, you can pick up the phone and talk with our FPGA applications specialists during regular working hours (CST). Just dial our FPGA Help Line — 1-214-997-5492.

To see how easy *easy* can be, call 1-800-336-5236, ext. 3712, for our free interactive diskette

It will show you why our FPGAs are easy-ASIC and will introduce you to system design advantages that you can achieve quickly and efficiently.

The diskette runs on any MS-DOS® PC with an EGA or VGA

graphics card, and we'll include the diskette with our FPGA DataFile. Just call the number above or complete the return card.



™ MegaChip is a trademark of Texas Instruments Incorporated.  
Action Logic and Activator are trademarks of Actel Corporation.  
® MS-DOS is a registered trademark of Microsoft Corporation.  
© 1991 TI 08-1041

  
**TEXAS  
INSTRUMENTS**



# Our 10-bit multi-step conversion technique gets you from A to D in 1/64 of a flash.

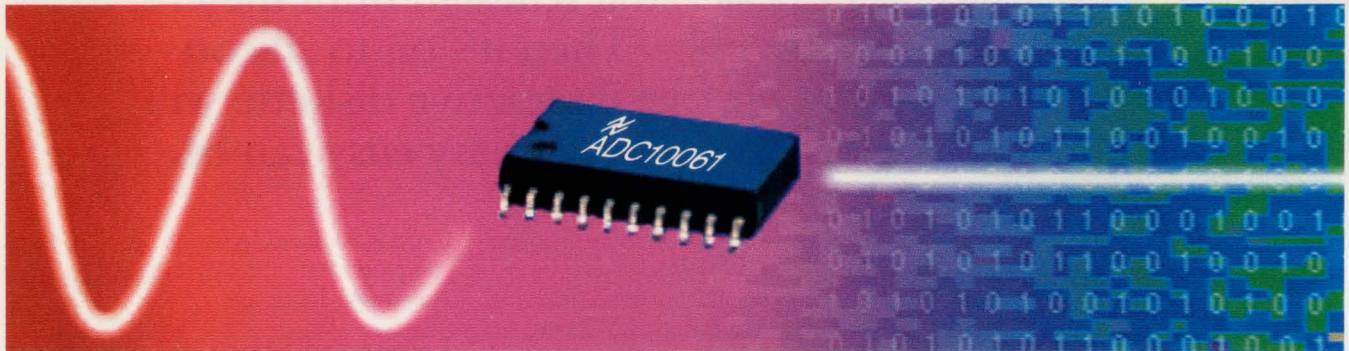

Designing ADCs with a powerful architecture and unsurpassed functionality.

Using a patented multi-step conversion technique, our 10- and 8-bit analog-to-digital converters (ADCs) now require just 1/64 as many comparators as full-flash converters.

This powerful architecture not only shrinks the number of comparators, but also reduces the power consumption and die size. So now you get low-power CMOS devices—available in military (883/SMD) and industrial temperature ranges—that are ideal for high-speed data acquisition, disk drives, and instrumentation.

What's more, our multi-step ADCs offer unsurpassed functionality.

Like on-chip multiplexer (including 2/4 and 8 channel) and sample-and-hold. Which means a big savings in board space and testing, and improved system reliability.

## Optimizing speed and power with 10-bit ADCs.

Drawing a mere 235mW of power (1/2 that of half-flash devices), our ADC10061/2/4 still display a conversion time of 900ns. That's 1Ms/s, which is guaranteed over temperature.

They also guarantee zero and full-scale errors, with *no* missing codes, at  $\pm 1$  LSB. Plus, the ADC10061 is a pin-for-pin upgrade to our ADC1061. With twice the speed. And since their input range

spans from 0 to 5V with single 5V operation, there's no need for a negative power supply.

## Pushing the envelope on high-performance 8-bit ADCs.

Offering the same 5V system compatibility as our 10-bit ADCs, our new

8-bit families, the ADC08061/2/4/8 and the ADC08161/4/8, boast conversion times of 500ns and consume only 100mW of power. With a total error budget of  $\pm 1/2$  LSB.

In fact, the ADC08061 is pin-compatible with the industry-standard ADC0820. Of course, none of this would be possible if it wasn't for our ongoing commitment to high-performance mixed analog + digital technology.

## Making the conversion to multi-step ADCs.

For samples, call or write us today. And discover why other conversion techniques could be just a flash in the pan.

1-800-NAT-SEMI, Ext. 121  
National Semiconductor Corp.  
P.O. Box 7643  
Mt. Prospect, IL 60056-7643

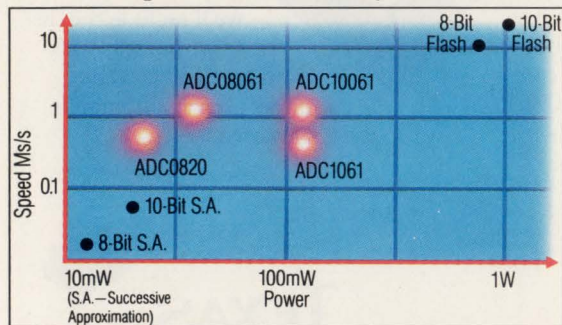

A quick flash on multi-step performance.





# Electro/ International

No matter what your interests are, Electro/International will provide you with the latest information on new products, technologies, and professional career issues.

John Gallant, Associate Editor

**T**his year it's New York City's turn. The Electro/International show, which alternates between Boston and New York City on successive years, will take place at the Jacob K Javits Convention Center from April 16 through the 18. This year, the East Coast's largest electronic trade show will feature more than 450 companies exhibiting their electronic products. Electro/International will also offer 43 technical sessions and 11 short courses devoted to keeping the engineer and manager abreast of the current trends in electronic design and manufacturing.

The ceremonies begin at 8:30 am on Tuesday, April 16, when Congressman Don Ritter (R-PA) will deliver the keynote address on "Meeting the Challenges of the 21st Century." The Congressman will discuss how government and industry strategies, along with intense international competition, have made many electronic business sectors unprofitable for American companies. He will also discuss how high-resolution imaging systems in general, and HDTV (high-definition television) in particular, can reverse this trend and revive US consumer electronics. All Electro/International registrants may attend the address at no extra charge.

In keeping with the theme of the keynote address, a number of the sessions deal with the issue of competition in today's tightening global economy (see **table**). Professionals from different parts of the world describe global marketing and communications techniques in

Session 5. Session 10 discusses strategies for competing in worldwide markets, especially in Japan, the Pacific Rim, and western Europe. Session 15 gives an overview of the quality-control procedures used in the world today—essential knowledge for selling products across international boundaries. Session 20 deals with global opportunities and how education must be improved here and abroad.

The changing economic structure and the present downturn in job opportunities are topics discussed in Session 43. While companies downsize their technical and engineering staffs, many individuals are becoming certified-professional engineers. If you're considering a career change to consulting, sit in on Session 29, which weighs some of the pros and cons of this career move.

Gladly, not all of the Electro/International sessions focus on the current economic conditions. There will be plenty of old-fashioned technical discussion on emerging technologies as well. Tutorial 3 reviews the





**Table 1—Electro/International sessions, tutorials, and short courses**

<b>Tuesday April 16, 1991</b>	<b>Medical electronics</b>	<b>Communications</b>	<b>IC technology</b>	<b>IC technology</b>	<b>Global electronics business colloquium</b>	<b>Short courses</b>
10:00 am to 12:00 noon	<b>Tutorial 1</b> Medical electronics	<b>Tutorial 2</b> Lightwave technology: fundamentals and fiber in the loop	<b>Tutorial 3</b> Solid-state image sensors	<b>Session 4</b> Memory and I/O solutions for today's microcontrollers	<b>Session 5</b> International public relations, marketing, and sales promotion for the electronics industry	8:30 am to 11:30 am <b>(1A)</b> Advanced design techniques for surface-mount technology—Part I
12:30 pm to 2:30 pm	<b>Session 6</b> Medical electronics	<b>Session 7</b> Lightwave technology	<b>Session 8</b> Integrated micro-engineered sensors and actuators	<b>Session 9</b> New innovative specialty memory architectures speed up systems and simplify their design	<b>Session 10</b> The global marketing imperative	1:30 pm to 4:30 pm <b>(1B)</b> CAD/CAM tooling/manufacturing for surface-mount technology—Part II
3:00 pm to 5:00 pm	<b>Session 11</b> Health effects of low-frequency electromagnetic fields	<b>Session 12</b> Photonic switching	<b>Session 13</b> Programmable logic—the software side	<b>Session 14</b> Evolving solid-state memory technology and device architectures promote new cost-effective memory system designs	<b>Session 15</b> Quality-profiting in the global marketing	8:30 am to 4:30 pm <b>(1C)</b> Surface-mount technology—Parts I and II
						8:30 am to 5:00 pm <b>(2)</b> Grounding and shielding of electronic systems
<b>Wednesday April 17, 1991</b>	<b>Manufacturing and test</b>	<b>Communications</b>	<b>Computers, digital systems, and software</b>	<b>Career</b>	<b>Global electronics business colloquium</b>	<b>Short courses</b>
9:30 am to 11:30 am	<b>Session 16</b> Advances in electronic packaging	<b>Session 17</b> New technologies for microwave systems	<b>Session 18</b> Cache memories for today's systems	<b>Session 19</b> Diversity in the workplace: the emerging majorities	<b>Session 20</b> Global opportunities	8:30 am to 12:30 pm <b>(3A)</b> The 8086 family of microprocessors: software, hardware, and system applications—Part I
12:30 pm to 2:30 pm	<b>Session 21</b> Applications of statistics to manufacturing and design	<b>Session 22</b> Commercial applications for microwave technology	<b>Session 23</b> New architectures in high-density/high-performance programmable logic devices	<b>Session 24</b> Continuing education: a lifetime professional commitment	<b>Session 25</b> Canceled	1:30 pm to 5:30 pm <b>(3B)</b> 16/32 bit microprocessors: 68000/68010/68020 software, hardware, and design applications—Part II
3:00 pm to 5:00 pm	<b>Session 26</b> A case study of computer-integrated manufacturing	<b>Tutorial 27</b> Direct digital synthesis	<b>Tutorial 28</b> Object-oriented databases: a new enabling technology for electronic design applications	<b>Session 29</b> Consulting as a career path for engineers		8:30 am to 5:30 pm <b>(3C)</b> 16/32 bit microprocessors—Parts I and II
						8:30 am to 12:30 pm <b>(4)</b> Talking tech: tips for technical talks
<b>Thursday April 18, 1991</b>	<b>Manufacturing and test</b>	<b>Communications</b>	<b>Computers, digital systems, and software</b>	<b>Career</b>	<b>General</b>	<b>Short courses</b>
9:30 am to 11:30 am	<b>Session 30</b> Commercial and industrial ATE	<b>Session 31</b> Premises distribution systems	<b>Session 32</b> Neural networks	<b>Session 33</b> Employing professionals with disabilities: an untapped resource	<b>Session 34</b> Public safety communications and transportation	8:30 am to 12:30 pm <b>(5A)</b> Intelligent pattern recognition and applications—Part I
12:30 pm to 2:30 pm	<b>Session 35</b> New testing protocols for SMT-IEEE boundary scan	<b>General</b> <b>Session 36</b> Superconductor applications	<b>Session 37</b> Artificial neural networks	<b>Tutorial 38</b> Giving us the tools: a packaged training program on employing individuals with disabilities	<b>Session 39</b> Status of magnetically levitated high-speed transportation in the US today	1:30 pm to 5:30 pm <b>(5B)</b> Pattern recognition and image processing—Part II
3:00 pm to 5:00 pm	<b>Session 40</b> Techniques for automatic testing	<b>Session 41</b> OEM sensor technologies for the 90s	<b>General</b> <b>Session 42</b> Photovoltaic solar cells and systems	<b>Session 43</b> Career problems and opportunities	<b>Session 44</b> Speech synthesizers and speech-recognition technology: clinical and commercial applications	8:30 am to 5:30 pm <b>(5C)</b> Image recognition—Parts I and II
						12:30 pm to 5:00 pm Supplier quality and electronic data interchange



basic concepts and discusses progress in the field of visible and infrared image sensors with an emphasis on VLSI sensors for HDTV. Session 7 presents four papers on new application areas for lightwave technology. High-speed cache design and a look at tomorrow's cache systems are the subjects of Session 18. Session 27 is a tutorial on direct digital synthesizers. You'll learn how to expand synthesizers' bandwidths, and suppress spurious signals.

Sessions 32 and 37 will present papers on neural networks—a topic that always stirs up interest. Session 32 will look into the effectiveness of neural-network models for speech recognition, image processing, and fuzzy logic. The papers presented in Session 37 emphasize why artificial neural networks are among the top three research activities at the Defense Advanced Research Projects Agency (DARPA). Session 44 looks at how speech synthesizers are overcoming the inability of the blind to read text and numbers on a computer screen. The session will review commercially available devices and computer methods for synthesizing understandable speech.

In addition to the professional sessions, Electro/International offers 11 short courses, on the Tuesday and Wednesday show days, covering a variety of top-

ics. A schedule and a brief course outline for the short courses offered appears in the **table** on the right side. The courses are not covered by the registration fee, however. Tuitions range from \$200 to \$355.

In addition, there will be a 2-part purchasing conference at the Javits Convention Center on Wednesday, April 17, from 12:30 pm to 5:00 pm. In part 1, a distinguished group of panelists will discuss how purchasers can establish a partnership with suppliers to obtain consistent quality. Part 2 will focus on the savings Electronic Data Interchange means to purchasing. There is a \$20 registration fee for the conference.

Don't forget to explore the exhibitor's booths on the convention's main floor. The exhibition floor opens at 10:00 am all three days and closes at 6:00 pm on Tuesday, 7:00 pm on Wednesday, and 4:00 pm on Thursday. Whatever your interests, there are plenty of booths to attract your attention. Moreover, there's lots to see and do in New York, and the attractions continue into the late evening hours. As the Broadway tune goes, "New York, New York, it's a hell of a town." **EDN**

Article Interest Quotient (Circle One)  
High 497 Medium 498 Low 499

## Finding your way to the show

The Jacob Javits Convention Center is located on 11th Ave between W 34th St and W 39th St—on the west side. It is easily accessible, and both public transportation and a free Electro shuttle bus have stops at the center. The 42nd St crosstown bus (M42) and the 34th St crosstown bus (M34) both serve the Javits Center. These buses run east to west and stop on every block to connect with most north to south bus routes by a free transfer. Fare is \$1.15 in coins or tokens. Buses serving the center have Javits Center signs.

The closest subway line to the Javits Center is the 8th Ave IND line (A, E, C, and K trains) at either the 34th St or 42nd St exits. Other convenient subway lines on 34th and 42nd St are 7th Ave IRT (Nos. 1, 2, and 3); Flushing Line IRT (No. 7); 6th

Ave IND (B, D, F, and JFK Express); Broadway BMT (N, Q, R); and the Grand Central to Times Square Shuttle (S). Fare is \$1.15, and connections to public buses can be made at street level.

If you're trying to get to Electro/International by car, forget it. There is no parking available at the Jacob Javits Center. However, if there are no scheduled baseball games, Electro/International attendees can park and ride from either Yankee Stadium or Shea Stadium. Both parks are adjacent to New York's subway system. You can also park at the Meadowlands Sports Complex No. 13 parking lot. An express bus, No. 322, runs between the parking lot and the downtown Port Authority Bus Terminal. Parking is \$2.75, and the trip takes approximately 15 minutes. Round-trip fare is \$5.50.

If you're flying into Kennedy or LaGuardia airports, you'll save yourself some cash if you use the Carey bus service to get downtown. The buses run every 30 minutes between 7:15 am and 11:00 pm and connect you with either the downtown Hilton, Marriott Marquis, or the Sheraton City Squire hotels. The service also stops at the downtown Port Authority Bus Terminal, which is on 42nd St between 8th and 9th Ave. The fare is \$7.50 from LaGuardia to the bus terminal and \$9.50 from Kennedy to the bus terminal. You can catch a crosstown bus from the bus terminal to the Javits Center or your hotel. The Port Authority Trans-Hudson Corp furnishes an alternative way to get to NYC from New Jersey and the Newark Airport. Call (201) 963-2558 for transportation information.



# OUR FEET MATCH YOUR PADS

If you're looking for a chip carrier socket with a small footprint, you can stop looking! Samtec sockets can be surface mounted on the same PCB pads that are used to mount PLCC's. Precision stampings, high temperature plastics, and unique contact and body designs now allow you to take full advantage of the small size of Plastic Leaded Chip Carriers.

Samtec sockets are available with 28, 32, 44, 52, 68 and 84 leads.

Call your Samtec distributor or

**1-800-SAMTEC-9**

Until 7pm EST

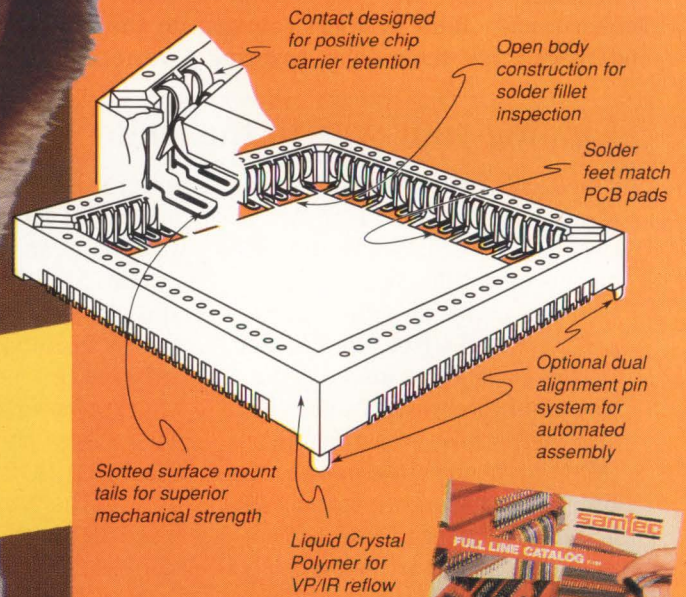

Just released! Samtec's new full line catalog F-191. Get yours today.

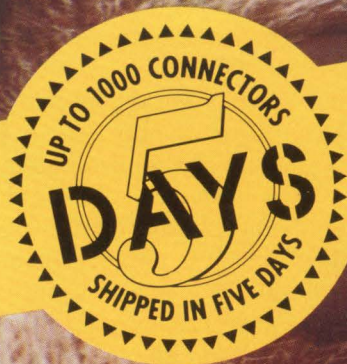

**samtec**

**IS SUDDEN SERVICE**

New Albany, Indiana USA • Sacramento, California USA • Cumbernauld, Scotland UK • Singapore  
SAMTEC, INC. • P.O. Box 1147 • New Albany, IN 47151-1147 USA • Phone 812-944-6733 • Fax 812-948-5047 • TWX 810-540-4095 • Telex 333-918



# Electro/International Products

## Laser-Printer Cleaning Paper

The #8022 cleaning papers for your laser printer keep your output crisp. This cleaning paper removes paper dust, dirt, and toner deposits from inaccessible parts of the machine. You can use a sheet each time you change the toner cartridge or after printing numerous copies. To use the cleaning paper, you first set the printer into its manual or bypass mode. Then you insert the paper into the manual or bypass feed. Next you send a blank document to the printer to print a blank white page. You repeat the procedure four to five times and then discard the paper. A free sample of the paper is available on request. Bag of 50 sheets, \$25; case of 12 bags, \$300.

**ACL Inc, 1960 E Devon Ave, Elk Grove Village, IL 60007. Phone (800) 782-8420; in IL, (708) 981-9212. FAX (708) 981-9278. TLX 4330251. Booth No. 2551.**

Circle No. 351

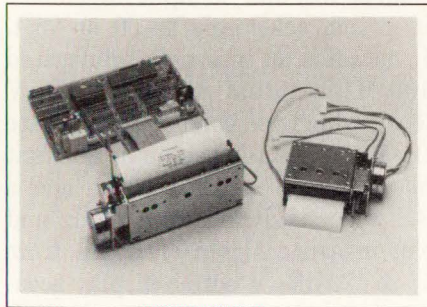

## Thermal Printers

The PL2040 and PL4080 are thermal printers and controllers for the OEM designs. The PL2040 has a print width of 20 or 40 columns and accepts a paper width of 60 mm. The PL4080 has a print width of 40 or 80 columns and accepts a paper width of 114 mm. Both units print at a 152-dpi resolution and have horizontal and vertical dot pitches of 0.007 in. The minimum character size is 6×9 dots, which is expandable 15×. In addition, the printers can print 12 lines/sec, and

they have bar-code-printing software built in. The printers also have bit-image and dot plot modes. PL2040, \$301; PL4080, \$328 (100).

**Telpar Inc, Box 796, Addison, TX 75001. Phone (214) 233-6631. FAX (214) 233-8947. TLX 732561. Booth No. 2226. Circle No. 352**

## Reset-Delay Relay

The C Series is a family of reset-delay relays. The units consist of spst or spdt switches that delay for a fixed or adjustable time before being energized or de-energized after you activate the trigger terminal. You can use the units on a pc board or panel mount to prevent circuit operation for a set period of time. The units consist of solid-state circuitry that drives a relay. Standard units have five male terminals spaced at intervals of 0.11 in. You can also opt for terminals spaced at 0.25-in. intervals or screw terminals. The relays come with preset tie delays of 0.10 to 600 sec. You can also purchase units with screw-driver-adjustable potentiometers that set the time delays between 4 and 165 sec, 150 and 300 sec, or 300 and 600 sec. Contacts have 0.5A ratings at 115V ac. You can specify the input voltage from 5 to 140V ac or 6 to 30V dc. \$22.50.

**Amperite Co Inc, 600 Palisade Ave, Union City, NJ 07087. Phone (800) 752-2329; in NJ, (201) 864-9503. FAX (201) 864-3955. Booth No. 2452. Circle No. 353**

## Vacuum-Fluorescent Display

The model 3601-30-040 vacuum-fluorescent display shows two lines of 11.3-mm-high characters. Each line can have 20 characters; each character comprises a 5×7 dot matrix. The module measures 10.8×2.75×1.3 in. It communicates with a host via an RS-232C or an RS-422 port at 1200 or 9600 baud. All characters and control codes are in 7-bit

ASCII format. The module comes with a standard ASCII 96-character set and alternate General European, Scandinavian, German, and scientific characters. The characters are flicker free, and you can filter them to achieve a variety of colors. The unit can detect errors in transmission, and a test mode displays all characters. \$228 (100).

**Industrial Electronic Engineers Inc, 7740 Lemona Ave, Van Nuys, CA 91409. Phone (818) 787-0311. FAX (818) 902-3723. TLX 4720556. Booth Nos. 2621, 2623.**

Circle No. 354

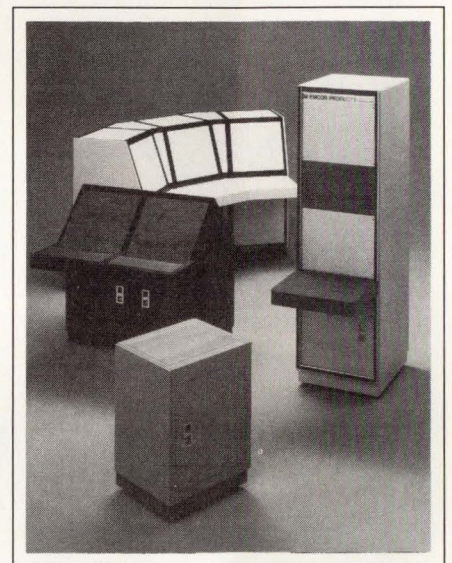

## Modular Enclosures

The ESQ family of modular enclosures comes in 19- and 24-in. panel widths and vertical, desk- and counter-height, slope-front, low-silhouette, wedge-unit, turret, or writing-top frames. The enclosures are fabricated from cold-rolled steel, and electronically controlled resistance welders ensure uniform welds. Their construction employs speed nuts and hardened Phillips-head sheet-metal screws for fastening panels. The enclosures come in 16 standard colors, and the company can match your paint chip or any Federal-Standard-595 color using a color-matching computer system. The enclosures have a static



# Electro/International Products

load capacity estimated at 800 lbs of equipment evenly distributed in the frame. Desk-top units without accessories, \$252 to \$520.

**Emcor Products, 1600 4th Ave NW, Rochester, MN 55901. Phone (507) 289-3371. FAX (507) 287-3405. Booth Nos. 2321, 2323.**

Circle No. 355

## Sealed Lead-Acid Battery

The Model PS-12120 is a rechargeable, sealed, lead-acid 12V battery. The 5.95 x 3.86 x 3.70-in. unit delivers 12.0 Ahrs at a 20-hour rate. This capacity results in an energy density of 1.69 Whrs/in. The maintenance-free battery weighs 8.8 lbs and can deliver as much as 120A

of discharge current. You can use the battery in any position, and it has a life expectancy of more than 5 years or 200 to 500 recharges (depending on the average depth of the discharge). The battery operates at temperatures from -20 to +50°C; withstands a vibration of 2000 cycles/minute, having a 0.10-in. excursion for 2 hours; and has a 3-month shelf life with 91% of nominal capacity at 20°C. \$33.80 (500).

**Power-Sonic, Box 5242, Redwood City, CA 94063. Phone (415) 364-5001. FAX (415) 366-3662. TLX 348400. Booth No. 2733.**

Circle No. 356

## 8051 & 68HC11

**PC-Based In-Circuit Emulators**

**Nohau Covers All Your Development Needs for the 8051 and 68HC11 Families!**

### Free Demo

You can start your debugging with this **FREE** demo simulator. You can load up to 512 bytes of code, assembler, C, or PL/M and do full debugging/simulation in assembly and source level. A great way to get started for **FREE**. Fantastic for schools! Just call and we'll send it!

### Full Simulator

The full-blown simulator is an extension of the DEMO. You can load up to 64K of code and use 64K of XDATA space. You can program an "external environment" to interact with your code to simulate your target system. The emulator is the hardware extension of the simulator!

### In-Circuit Emulation

The 24MHz real-time emulator has been the industry standard for years. With its complex breakpoint logic and advanced trace, nobody can beat it for performance. Plug-in or RS-232 configuration. All 8051 derivatives are supported!

**NOHAU**  
CORPORATION

51 E. Campbell Avenue, Campbell, CA 95008  
(408) 866-1820 • FAX (408) 378-7869

Help File Disp/Alter

FF	P3	FF
FF	IP	00
FF	IE	00

CODE WINDOW, MODULE:

```

;64 void moving_demo() {
0042 E4 CLR A
0043 F5 19 MOV .n,A
;69 for( p1 = arrayX, c = sizeof( array
0045 75 1A 02 MOV .p1,#02
0048 75 1B 00 MOV 1B,#00
004B 75 1C 00 MOV 1C,#00
004E 75 1B 3F MOV .c,#3F
0051 E5 10 MOV A,.c
0053 FF MOV R7,A
0054 14 DEC A
    
```

DATA

0020:	25	A3	C4	56	400
0024:	28	92	A7	7F	400
0028:	E2	A4	50	93	400

\* go  
GO IFROM address  
Begins real

**Identical User Interface for All Three Products — You Can't Go Wrong!**

## Portable Spectrum Analyzer

The model PL 5610 portable spectrum analyzer has a 1-GHz frequency range. It operates from multiple ac line voltages, an external 12 to 15V dc supply, or its internal 12V dc rechargeable battery. The battery operates for approximately 1 hour after being recharged for 2 hours. The analyzer weighs less than 20 lbs, and its input impedance is switch selectable to 50 or 75Ω. It contains an internally generated 100-MHz signal at an 80-dBμV level, which you can use to calibrate the instrument in the field. The unit has a 70-dB dynamic range and a 3-dB IF bandwidth of 10 kHz and can measure signals ranging from 15 to 123 dBμV with a display accuracy of ±2 dB. It uses a 3½-digit LCD display to indicate the center frequency with an accuracy of ±3 MHz. \$2995.

**B&K Precision, Maxtec International Corp, 6470 W Cortland St, Chicago, IL 60635. Phone (312) 889-1448. FAX (312) 794-9740. TLX 210017. Booth Nos. 2033, 2035.**

Circle No. 357

## 6½-Digit Digital Voltmeter

The Model 182 6½-digit digital voltmeter offers a 1-nV sensitivity. The instrument has a special low-tem-

Australia (02) 654 1873, Austria (0222) 38 76 38, Benelux +31 1858-16133, Canada (514) 689-5889, Denmark (42) 65 81 11, Finland 90-452 1255, France (01)-69 41 28 01, Great Britain 0962-73 31 40, Hungary 01-137 2182, Israel (03) 48 48 32, Italy (01) 771 00 10, Korea (02) 784 784 1, New Zealand (09) 392-464, Portugal (01) 81 50 454, Sweden, Norway (040) 92 24 25, Singapore (065) 284-6077, Spain (93) 217 2340, Switzerland (01) 740 41 05, Taiwan (02) 7640215, Thailand (02) 281-9596, West Germany 08131-25083, Yugoslavia 061-57 19 49.

CIRCLE NO. 27



# OrCAD presents Release IV

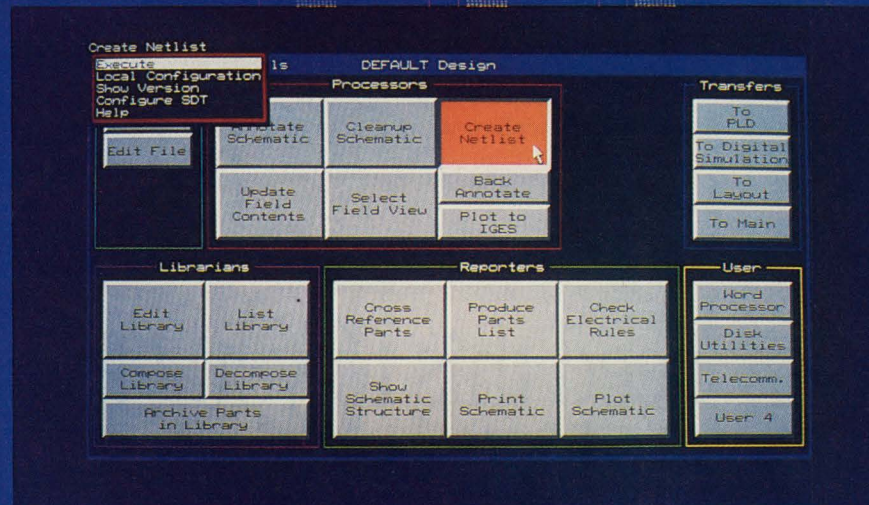
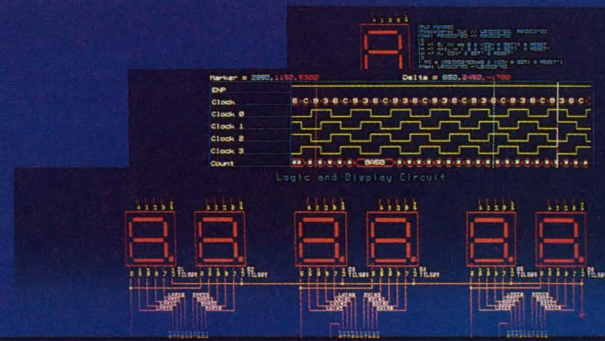

## The limits are gone

OrCAD has introduced the greatest product upgrade in its history. Memory limits, design restrictions, even boundaries between products are all disappearing.

For years, OrCAD's competitors have been playing a game of catch-up. With the introduction of Release IV, the race is over. No one will match our price/performance ratio on these features:

- Schematic Parts Library has been increased to over 20,000 unique library parts
- Digital Simulation process has been speeded up by an order of magnitude
- Printed Circuit Board Layout package offers autoplacement and autorouting at no extra charge
- Expanded memory capabilities

### Best of all, OrCAD introduces ESP

ESP is a graphical environment designed specifically for the electronic designer. Software tools appropriate for different stages in the design process are now linked together to form a seamless flow of information. This easy-to-use framework relieves the designer of time consuming tasks and the inconvenience of moving from one tool set to another. You can now spend more time productively designing.

### For more information . . .

You need to know more about Release IV and all of the benefits OrCAD has to offer. Call the telephone number below and we'll send you a free demonstration disk.

**OrCAD** 

More designs from more designers

**For more information, call (503) 690-9881**

or write to OrCAD Sales Department, 3175 N.W. Alcock Drive, Hillsboro, Oregon, 97124



# Electro/International Products

perature input connector and cable that reduces noise for low-voltage measurements. The model maintains an input noise level of 15 nV p-p. In addition, the instrument has an input impedance greater than 10 G $\Omega$  on all voltage ranges. It has a FET input design that provides 160 dB of common-mode rejection when

making differential measurements using both the positive and negative inputs. The unit has analog and digital filters that operate on the data in the unit's buffer memory. The filters reduce noise when transferring data to a host computer via its IEEE-488 bus. The model can also achieve more than 50 readings/

sec. You can program the voltmeter via the IEEE-488 bus, and an autoranging function automatically switches between 5 voltage ranges—3 mV, 30 mV, 300 mV, 3V, and 30V. \$3695. Delivery is four weeks ARO.

**Keithley Instruments Inc, 28775 Aurora Rd, Cleveland, OH 44139. Phone (800) 552-1115; in OH, (216) 248-0400. FAX (216) 248-6168. Booth No. 2040. Circle No. 358**

U S E R R A T E D  E X C E L L E N C E

## Feed this to your PC and it'll think it's an HP BASIC workstation.



Finally, there's a way for serious technical computer users to get the power and features of HP BASIC on a PC. The answer is HTBasic, a real engineering BASIC that turns your PC into an HP 9000 series 200/300 BASIC workstation—at a fraction of the cost.

Like HP's Rocky Mountain BASIC, HTBasic from TransEra is a state-of-the-art BASIC that gives you all the capabilities you need for complex engineering applications. Plus, you get important advanced features you won't find with any other PC BASIC. Like the complete set of HP graphic commands. Integrated HPIB (GPIB) syntax for intelligent instrument control. The advanced I/O Path system. And built-in matrix math. In fact, all the optional HP binaries are built in. There's nothing else to load. You even get the full screen program editing and debugging environment.

Discover the new solution for cost-effective technical workstations. HTBasic from TransEra.

**HTBasic**  
High Tech Basic

HP, HP BASIC and HPIB are registered trademarks of Hewlett-Packard.

**DISCOVER  
HTBASIC  
FOR  
YOURSELF**

Call today at  
**(801) 224-6550**  
or FAX us at  
**(801) 224-0355**

**TransEra** 3707 North Canyon Road, Provo, Utah 84604 • TEL: 801-224-6550 • FAX: 801-224-0355

**CIRCLE NO. 28**

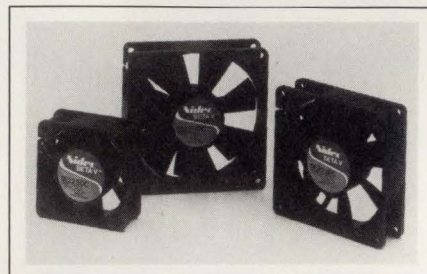

### Cooling Fans

Beta V brushless-dc cooling fans are available in three sizes: 60 x 25 mm; 80 x 25 mm; and 92 x 25 mm. The fans employ aerodynamic impeller blades and a fan housing that produces efficient air flow at low speeds. An energy-absorbing thermoplastic housing reduces structure noise. These units are at least 3 to 5 dB quieter than their predecessors. An optional built-in or remote thermal sensor monitors the air stream or component temperature and regulates the fan speed. Depending on fan size, \$7.30 to \$7.55 (1000).

**Nidec Corp, 318 Industrial Ln, Torrington, CT 06790. Phone (203) 482-4422, ext 400. FAX (203) 489-7201. Booth Nos. 2315, 2317.**

**Circle No. 359**

### SMT Chip Inductors

The GLD series of shielded SMT chip inductors feature a low dc resistance. Sizes range from 3.2 x 2.5 x 2.2 mm to 0.126 x 0.098 x 0.087 mm. The inductors also have a ferrite filler in their encapsulation to reduce magnetic coupling. They operate from -20 to +85°C and





POWER SUPPLIES

# 1 $\phi$ & 3 $\phi$ REGULATED AC/DC POWER SUPPLIES 15 W to 2 kW

## High Frequency — High Current Switchers

MK & MKA Series

- 750 W to 2 kW
- 40 Models From 2 VDC @ 150 A to 48 VDC @ 40 A
- $\text{UL}$  Recognized & CSA Certified
- N+1 Redundancy of Parallelable Outputs
- 5 Year Warranty

## Linears — Enclosed & Open Frame

- Single, Dual & Triple Outputs
- 5 Year Warranty
- 405 Models From 2 VDC to 500 VDC
- $\text{UL}$  Recognized & CSA Certified
- Remote Programming Capability
- Rack Mounting Hardware Options

## Ferro Resonant to 650 W

- 36 Standard Models From 8.5 VDC to 125 VDC
- Customs to 2 kW & 400 VDC
- 4 Package Sizes
- Rack Mounting Hardware Options

## Lab Supplies to 850 W

- SVC Series CV/CC
- 12 Models From 0-20 VDC to 0-125 VDC

- Rack Mounting
- 5 Year Warranty
- Regulation — Line & Load  $\pm 0.01\%$
- Metered V & A



For information on NJE Power Supplies  
or a copy of the latest NJE full line catalog,  
call **TOLL FREE 1-800-631-4298** or write:

**ELECTRONIC MEASUREMENTS INC.**

405 Essex Road, Neptune, NJ 07753  
(In NJ, HI, AL and Canada, call 908-922-9300)

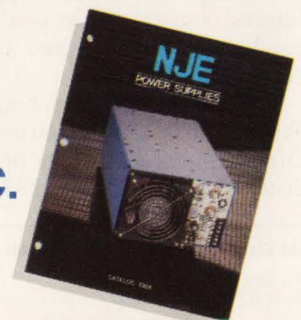



# 3M Reveals New Long Term EMI/RFI Shielding Tape

Tin-alloy coating on both sides of copper foil offers superior solderability, environmental stability.

AUSTIN, Tex. — This new UL Recognized Scotch™ Foil Shielding Tape 1183 employs a tin-alloy coating on smooth copper foil to produce a durable and effective electromagnetic shield.

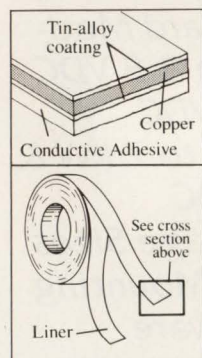

The tin-alloy coating is on both sides of the copper for thorough protection.

The unique electrically-conductive adhesive enables 1183 tape to make electrical connections across seams and between mating sections, of electronic enclosures ranging from small equipment housings to large shielded rooms. The tape can also shield the energy radiating from seams between the sectors of dish antennas.

The special tin-alloy coating on both sides of the foil provides two significant benefits.

1. Thorough environmental stability and corrosion resistance.
2. Exceptional solderability for applications such as sealing the seams when the tape is used as a shield around cable connectors.

3M 1183 Tape also serves as a corrosion resistant contact surface for conductive gasketing, beryllium copper "spring fingers" or other resilient conducting media used around doors and openings of electronic cabinetry.

For more information about all 3M Foil Tapes, contact a 3M Electrical Specialties Division representative or authorized distributor or call 1-800-233-3636.

3M Electrical Specialties Division  
PO Box 2963  
Austin, TX 78769-2963



CIRCLE NO. 25

## Electro/International Products

achieve over 90% coverage using either wave-flow or infrared and vapor-phase-reflow soldering. The series comprises 25 models covering an inductance range from 10.0 to 330.0  $\mu$ H. The units come in either carrier or reel packaging. \$0.41 (1000).

**Sprague-Goodman Electronics Inc., 134 Fulton Ave, Garden City Park, NY 11040. Phone (516) 746-1385. FAX (516) 746-1396. TLX 144533. Booth No. 2056.**

Circle No. 360

### High-Speed Connector Family

Micro-Strip high-speed interconnected connectors maintain a 50- $\Omega$  transmission line impedance within a  $\pm 10\%$  tolerance. They have contacts on 0.05  $\times$  0.10-in. centerline spacing and a design that can fit 40 signal lines and their associated ground lines into a linear inch. The receptacle contacts present a flat metal surface that faces the ground plane. An interconnected unit limits crosstalk to less than 4% when signals have rise times of 1 nsec. Board-to-board connectors are available as right-angle and vertical stacking units. Vertical stacking units are available in 0.43- or 0.738-in. stack heights. Cable-to-board connectors are compatible with transmission-line cables that feature precision-controlled mass-soldering terminations. The connector costs \$0.15 per mated pair for stacking configurations and approximately \$0.21 for right-angle board configurations (OEM qty).

**AMP Inc, Box 3608, Harrisburg, PA 17105. Phone (800) 522-6752. Booth No. 2322. Circle No. 361**

### Digital Oscilloscope

The 9414 digital oscilloscope captures and analyzes signals having frequencies as high as 150 MHz. Each of the scope's four channels employs a flash A/D converter that can digitize transient events as fast

as 100M samples/sec and periodic signals as fast as 4G samples/sec. A  $\pm 0.002\%$  timebase simultaneously drives each A/D converter to ensure timing accuracy for measurements between channels. In addition, the scope contains 10k bytes of memory/channel, letting you analyze waveforms by expanding them to 200 times. An optional card reader allows you to store waveforms and setups on 128k- or 256k-byte memory cards. The scope also lets you automatically measure rise time, fall time, RMS voltage, and other signal characteristics using the IEEE-181 pulse-measurement standard. \$12,990. Delivery is six weeks ARO.

**LeCroy Corp, 700 Chestnut Ridge Rd, Chestnut Ridge, NY 10977. Phone (914) 425-2000. FAX (914) 425-8967. TWX 710-577-2832. Booth Nos. 1934, 1936.**

Circle No. 362



### LAN Tester

The Cable Scanner tool for testing LANs operates on Ethernet, Arcnet, StarLAN, Token-Ring, and Twisted-Pair networks. The tool lets you determine if cabling is the cause of a malfunction. If the problem is cabling, the tester helps you pinpoint the location of a fault or break. The tester also provides cable resistance measurements, noise-level measurements, and audible continuity checks. You can attach a line printer to the unit to record activity. After the scanner helps



# Triple Port DRAMs

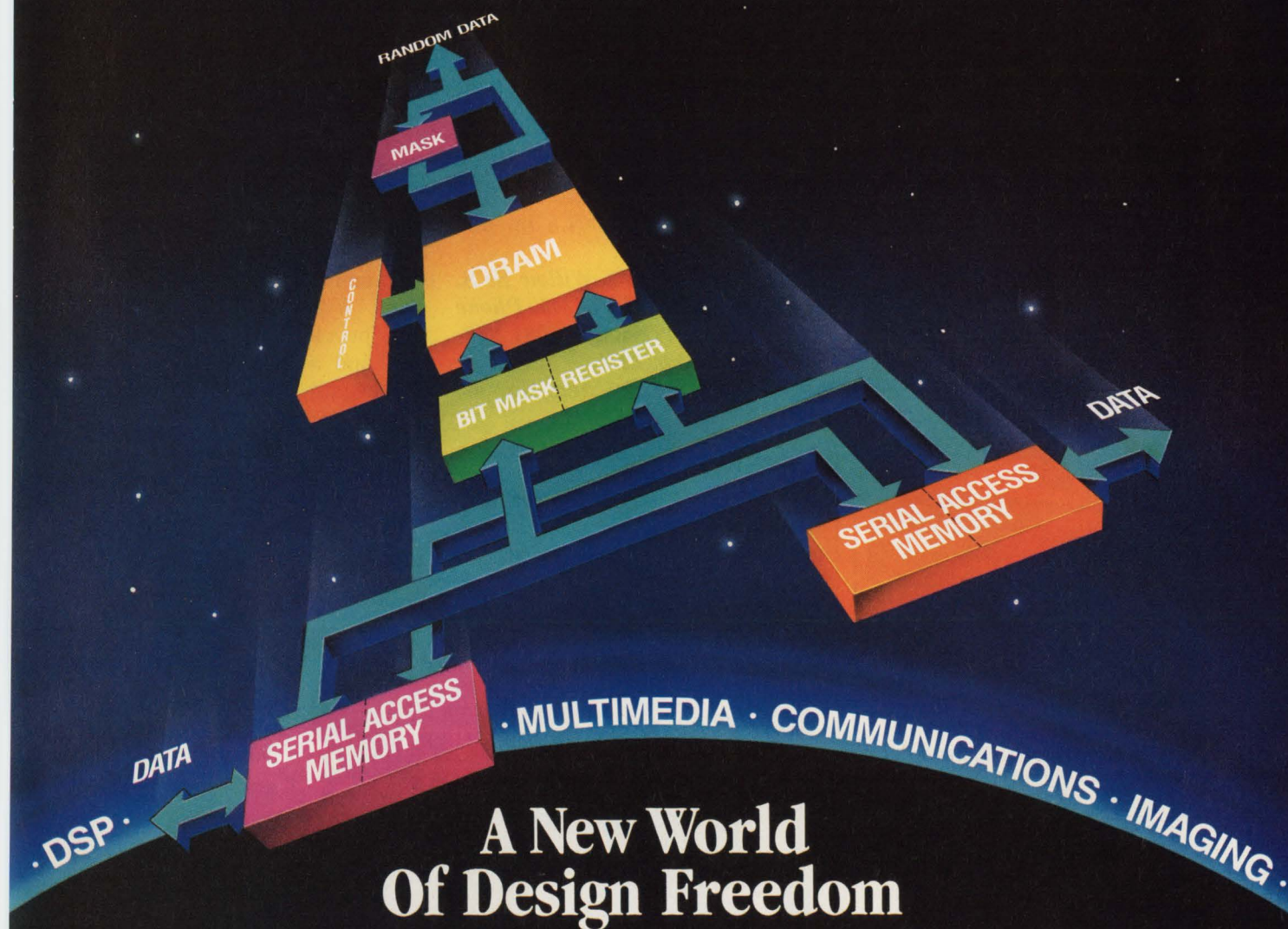

## A New World Of Design Freedom

Experience a new world of design freedom with Micron's 1 Meg Triple Port DRAM — the first DRAM designed to dramatically speed up and simplify your data manipulation. With three ports rapidly accessing a common memory array, you won't be tied down with data bottlenecks.

Our Triple Port DRAM provides three independent, asynchronous and bi-directional ports. Data may be read from and written to memory through both of the fully-static Serial Access Memory ports while normal functions of the DRAM port are also performed. Plus, multiple data input or output operations can occur at the same time — resulting in faster data transfer and more design freedom.

The Triple Port DRAM also features a Bit Mask Register for built-in masking, including windowing, and Split Read or Write Transfers that make transfer timing much easier.

So, whether you're designing multimedia workstations,

super computer networks, satellite communication links or full-motion video frame buffers, you will be worlds ahead in speed and simplicity.

Enjoy your design freedom and stay on the leading edge by calling Micron at 208-368-3900.

Micron. Working to improve your memory.

Part #	Organization	Speed	Package	Availability**
MT43C4257	256K x 4 DRAM	80,100,120	40-Pin SOJ	Samp: Now Prod: Mar 91
	512 x 4 SAMs	25,30,35		
MT43C4258*	256K x 4 DRAM	80,100,120	40-Pin SOJ	Samp: Now Prod: Mar 91
	512 x 4 SAMs	25,30,35		
MT43C8128	128K x 8 DRAM	80,100,120	52-Pin PLCC	Samp: Now Prod: 2Q91
	256 x 8 SAMs	25,30,35		
MT43C8129*	128K x 8 DRAM	80,100,120	52-Pin PLCC	Samp: Now Prod: 2Q91
	256 x 8 SAMs	25,30,35		

\*Provides SAM stop address input \*\*Call for military availability

**MICRON**  
TECHNOLOGY, INC.

2805 E. Columbia Rd., Boise, ID 83706 (208) 368-3900

CIRCLE NO. 162

©Micron Technology, Inc. 1991



# PICO transformers & inductors

**PLUG-IN  
SURFACE MOUNT  
AXIAL LEADS  
TOROIDAL  
INSULATED LEADS**

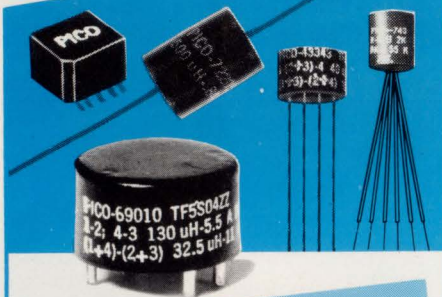

## TRANSFORMERS

QPL standards available  
MIL-T-27/103-1 thru 16, MIL-T-27/172-1 thru 50,  
MIL-T-27/357-1 thru 114, MIL-T-27/358-1 thru 123,  
MIL-T-27/359-1 thru 147

- Audio Transformers ranging in size from 1/4" x 1/4" to 3/4" x 1 1/2". 20 Hz to 250 KHz. Up to 3 watts.
- Pulse Transformers .05μSEC to 100μSEC miniaturized construction.
- Ultra-miniature DC-DC Converter Transformers. 40 watts.
- Miniaturized Switchmode Inverter Transformers. 60 watts.
- 400 Hz Power Transformers. Primary voltages of 115V or 26V. Plug-in construction. Ultra-miniature
- Microphone/Transducer Audio Input.
- MIL-STD-1553 Interface Multiplex Data BUS Pulse Transformers.

## POWER INDUCTORS

QPL standards available MIL-T-27/356-1 thru 63

Inductance values to 20mH with DC currents to 23 amps

## COMMON MODE INDUCTORS

## HIGH "Q" INDUCTORS

See EEM  
or send direct for  
FREE PICO Catalog

# PICO Electronics, Inc.

453 N. MacQuesten Pkwy. Mt. Vernon, N.Y. 10552

Call Toll Free **800-431-1064**

IN NEW YORK CALL **914-699-5514**

FAX **914-699-5565**

CIRCLE NO. 30

# Electro/International Products

you locate the faulty cable or connection, a tracer lets you know the cable's exact location in the ceiling or wall. The tracer locates the fault by detecting a signal injected into the cable by the main unit. The unit comes with adapters for Ethernet, Arcnet, and Twisted-Pair networks; a printer cable; IBM PC-compatible software on floppy disk; and six AA NiCd batteries. The unit measures 1 x 4 x 7.5 in. and weighs 2 lbs. \$1495.

Contact East, 335 Willow St S, North Andover, MA 01845. Phone (508) 682-9844. FAX (508) 688-7829. Booth No. 2221.

Circle No. 363

## 68332 Emulator

The HMI-200 emulator for Motorola's 68332 μP provides real-time emulation; four complex break and trigger points; and two 4k x 104-bit

trace buffers, which include 16 external trace bits and 32 bits of time-tag data. It has a standard 256k bytes of memory and an option for 1, 2, or 4M bytes. The emulator comes with a window-driven high-level-language debugger called Sourcegate. The debugger supports C, Pascal, PL/M, and Ada compilers. Sourcegate displays source code only, assembly code only, or source and assembly code. You can display windows to monitor specified memory locations and variables. A performance analysis option provides real-time software test and analysis. Emulator and Sourcegate, \$16,000; performance analysis option, \$2500.

Huntsville Microsystems Inc, 3322 S Memorial Pkwy, Huntsville, AL 35801. Phone (205) 881-6005. FAX (205) 882-6701. TWX 510-600-8258. Booth No. 2755.

Circle No. 364

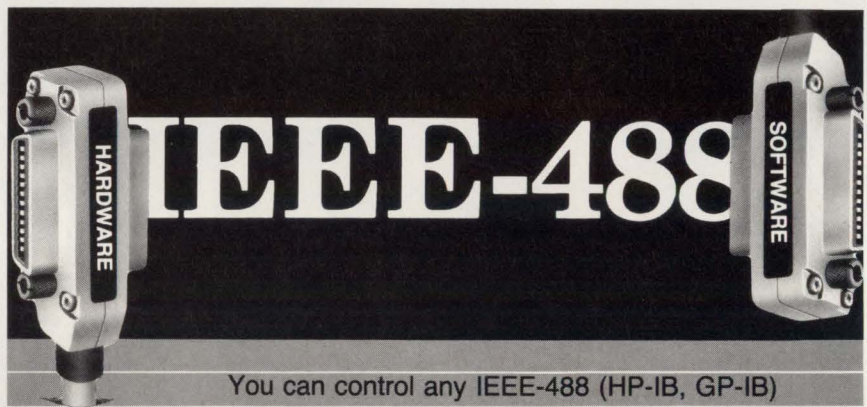

You can control any IEEE-488 (HP-IB, GP-IB) device with our cards, cables and software for the PC/AT/386, EISA, Micro Channel and Macintosh II. You get fast hardware and software support for all the popular languages, plus a software library of time saving utilities. Instrument control has never been easier.

**FREE**  
Informative Catalog 800-234-4232  
Applications help (617) 273-1818

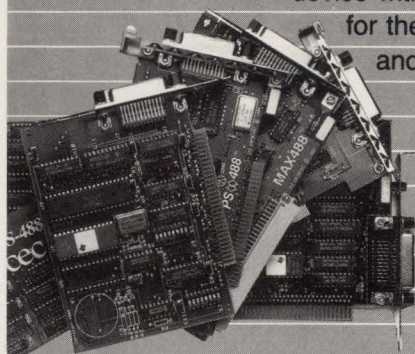

Capital Equipment Corp.  
Burlington, MA. 01803

Micro Channel is a trademark of IBM

CIRCLE NO. 31



# THE SERIES 6600/6700 THERMOSTATS

Now you can ensure the highest level of thermal protection for your P.C. board without compromising its design. Specify an Airpax Series 6600 or 6700 miniature bimetallic snap-action thermostat.

The 6600 provides precise sensing of ambient temperatures in applications where the control of high temperatures is crucial. The 6700 gives you accurate thermal surface sensing when mounted on heat sinks in applications such as

## Small things come in good packages.

The 6700 conforms to Y220/T0220 international product package standards, so you can automatically insert and solder the thermostats onto your board with high-speed automated equipment. The nickel-plated copper mounting bracket assures accurate thermal conductivity for heat-sink applications.

## Excellent repeatability from 40°C to 110°C.

Series 6600/6700 thermostats provide fast, positive response with 1-amp switching capability at 48 Vdc over their operating range of 40°C to 110°C (104°F to 230°F) for a minimum of 30,000 operations. The operating temperature is pre-set at the factory. Both the 6600 and 6700 meet UL and CSA standards.

# Never Has So Little Done So Much For Thermal Protection.

power supplies. Both the 6600 and 6700 are ideal for today's crowded P.C. boards, where reliable thermal protection is essential. And space is at a premium.

## So much to do, so little space.

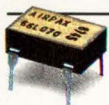

The 6600 occupies less than .84 sq. cm. of precious board space, yet provides complete, self-contained thermal protection. The STD 8-pin dual in-line package is shipped ready for use in auto-insertion assembly equipment.



The 6600 is VDE approved; the 6700 is VDE pending.

## A little information goes a long way.

To find out more about Airpax Series 6600/6700 thermostats, call or write us today. You'll see how so little can do so much to increase your P.C. board's reliability.

Airpax, Husky Park,  
Frederick, MD 21701.  
(301) 663-5141.

FAX (301) 698-0624.

A North American Philips Company.

**AIRPAX**<sup>®</sup>  
FREDERICK DIVISION

CIRCLE NO. 141



**Power  
tool**





# Power tools

## KEPCO TEST/BENCHTOP POWER SUPPLIES

The correct tool makes any job easier. Kepco's Power Supplies for workbench, for burn-in, and float-charging batteries are just some of the tools at your disposal.

For your workbench choose a multi-out array that you configure for the application by plugging-in modules with adjustable outputs. You can combine one, two or three modules in convenient bench-top housings or put six of them together in a rack. Other experimentalist power includes a nice selection of 100W single output instruments (MSK), a triple output logic-analog model (MPS), and burn-in/float chargers (TBC) that range from 300 to 3000 Watts in all the popular voltages.

Custom power assemblies allow you to create your own toolkit with just the selection of voltage and power to fit your need.

Other power tools from Kepco include: ac power to 18KVA, precision programmable dc for test applications, high voltage models and four-quadrant bipolar power. For these, and our broad selection of switching power models, including d-c to d-c converters, please ask for one of the three catalogs illustrated below.

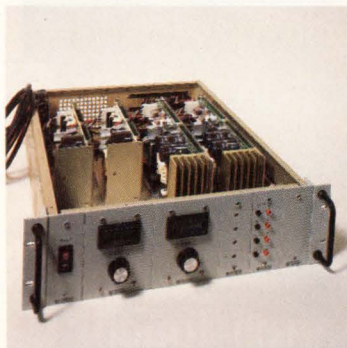
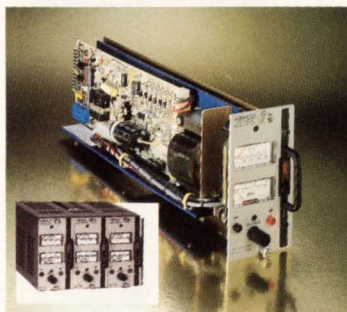

### Plug-in power

- 20 Watt modules, either voltage stabilizers (series PCX-MAT) or current stabilizers (series CC).
- Sized to plug-in six abreast in a 19" rack or in bench-top housings for 1, 2 or 3 units.
- Mix or match.
- Select from six voltage ranges up to 100V.

**Kepco Group PCX-MAT and CC Power Supplies**

### 100 Watts of precision benchtop power.

- LCD meters to set the level accurately, a preview feature to check your setting before applying power to your load.
- Linear design for low-noise high stability.
- Ten-turn controls for good resolution.
- Five models offer outputs up to 125 Volts.

**Kepco Group MSK Power Supplies**

### A triple output design for maximum convenience.

- 0-6V at 5A for logic and a tracked  $\pm$  0-20V, 1A for analog.
- Each output current limited, the 0-6V output has an overvoltage protector.

**Kepco Group MPS Power Supply**

### Battery/float-chargers.

- For telecommunications: maintain 12V, 24V and 48V batteries, built-in equalize timer.
- For burn-in: power up to 3000 Watts, current limited, over-voltage protected. Two output settings, remotely selectable for margining.

**Kepco Group TBC Float Chargers/Power Supplies**

### Kepco Custom System Power Assemblies

We will stuff a 19" rack (5 1/4 or 7") full of switchers to your requirement. With modules from 3 Watts to 3000 Watts, in a wide selection of voltage ranges, we can accommodate most needs.

- LCD output meters.
- Test points.
- Pilots, trimmers, circuit breakers. Convenient 1/8 rack panel format allows multiple control and monitoring.

**Kepco Power Assemblies.**

SEE OUR PAGES IN VOLUME D

**eem**<sup>90</sup><sub>91</sub>



Call/fax/write to Dept. LXT-12 for any of our three catalogs.

**Kepco, Inc.**, 131-38 Sanford Avenue, Flushing, NY 11352 USA (718) 461-7000 • FAX (718) 767-1102 • Easylink (TWX): 710-582-2631

**KEPCO EUROPE, LTD.**, London, England: Salamander Quay West, Park Lane, Harefield, Middlesex UB9 6NZ •

Tel: +44 895 825046 • Fax: +44 895 825045 **UNITED KINGDOM:** PPM Instr. Ltd. • Tel: (0483) 301333 • Fax: (0483) 300862

**GERMANY:** Compumess Elektronik GMBH • Tel: (089) 32 00 95 56 • Fax: (089) 32 00 95 25 **FRANCE:** M.B. Electronique •

Tel: (1) 39 56 81 31 • Fax: (1) 39 56 53 44 **ITALY:** Sistel, S.p.A. • Tel: (02) 618 1893 • Fax: (02) 618 2440



**KEPCO**  
THE POWER SUPPLIER™

CIRCLE NO. 135



# "WE'VE HAD GREAT SUCCESS WITH CARROLL TOUCH. WHY CHANGE IF IT'S WORKING?"

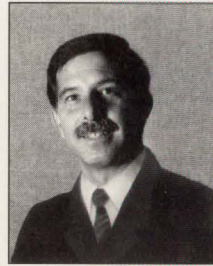
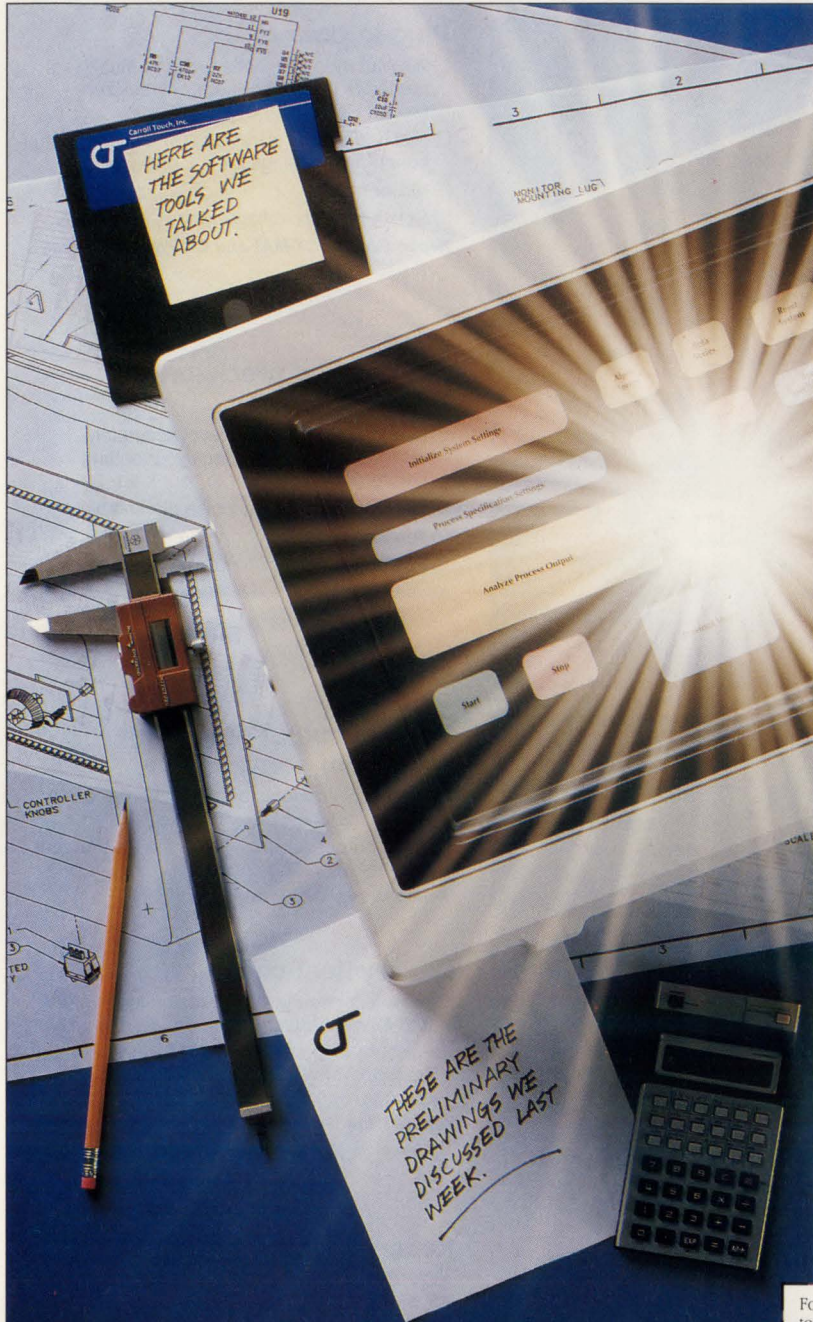

**John Santacroce**  
Mechanical Engineering  
& Project Manager  
Hewlett-Packard Company

"As a diverse international corporation, Hewlett-Packard manufactures everything from computers, measurement and computation equipment, medical equipment, analytical equipment and more. We're known for our high level of test and measurement systems capabilities.

"We recently developed a touch-based automotive test system for a customer and there was no debate over using Carroll Touch in designing this. Our past experience with them has been very successful.

"From my point of view, Carroll Touch has provided good, reliable touch frame assemblies. They also bring a high level of engineering expertise to our team, especially in the materials selection area.

## "Carroll Touch people really approach our projects as a team project."

"Working with Carroll Touch people is great because everybody is part of the team – which helps us create a very successful product. Their willingness to go that extra step makes our job much easier.

"In developing a recent functional spec for a touch frame, Carroll Touch engineers worked closely with us in making sure that the assemblies would survive electrostatic discharge.

"We held design reviews of the various approaches and all of our recommendations were considered very sincerely by Carroll Touch. Comments were intelligently relayed back to us and everything we asked for was delivered in the specified time."

For more information on how Carroll Touch can help you create success with your touch technology applications, call 512/244-3500, or simply mail your business card with this coupon to Carroll Touch, P.O. Box 1309, Round Rock, Texas 78680.

Name \_\_\_\_\_ Title \_\_\_\_\_

Company Name \_\_\_\_\_

Address \_\_\_\_\_

City \_\_\_\_\_ State \_\_\_\_\_ Zip \_\_\_\_\_

**Carroll Touch**  
The Next Level of Contact

**Carroll Touch**  
The Next Level of Contact  
EDN041191

© 1990 Carroll Touch



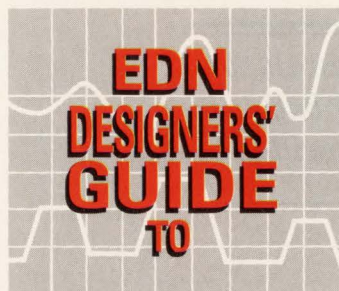

servo simulation  
using PSpice  
part 2

# Servo analysis gets a boost from parametric models

---

*Part 2 of this 2-part series describes how to use the basic mechanical models presented in part 1 to create more complex mechanical subsystems, such as rotational loads, gear trains, and dc motors. Combining these models with standard electrical circuit models allows you to analyze the dc, ac, and transient response of an entire servo-control system.*

---

Dr Vincent G Bello, *Norden Systems*

Modeling and then interconnecting important subsystems simplifies the analysis of complex electromechanical servo systems. With a library of mechanical and electrical subcircuits at your disposal, you can easily simulate a servo system comprising any number of nested subcircuits. You can simulate each block or subcircuit by itself and compare the model's accuracy to measurements or data-sheet specifications. For designers of electromechanical

systems, mechanical models are an important part of that library. The following sections present PSpice models for main mechanical subsystems such as rotational loads, gear trains, and dc motors.

The first of these subcircuit models is a rotational load (**Fig 1**). This model includes elements for moment of inertia, viscous damping, coulomb friction, shaft stiffness, and mass unbalance. A constant torque approximates the mass unbalance, which is a valid approximation if the shaft-angle variations are small. **Listing 1** gives the code for the subcircuit named ROTLD. The equivalent circuit and code follow directly from the analogous circuits for simple mechanical elements developed in part 1.

The first line of **Listing 1** assigns negligible default values to the parameters the **listing** defines as J, B, KS, BKS, FC, and MU. The program uses these defaults if the main circuit's sub circuit call statement doesn't assign alternate values. The external nodes are node 1—the shaft speed in rad/sec relative to space—and node 2—the platform

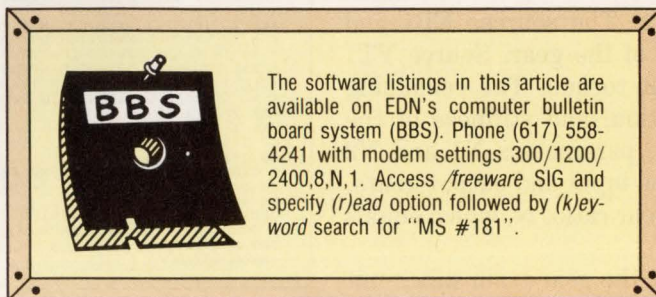



*In some gear trains, backlash is an important parameter. If the amount of backlash is too large, the servo system can oscillate.*

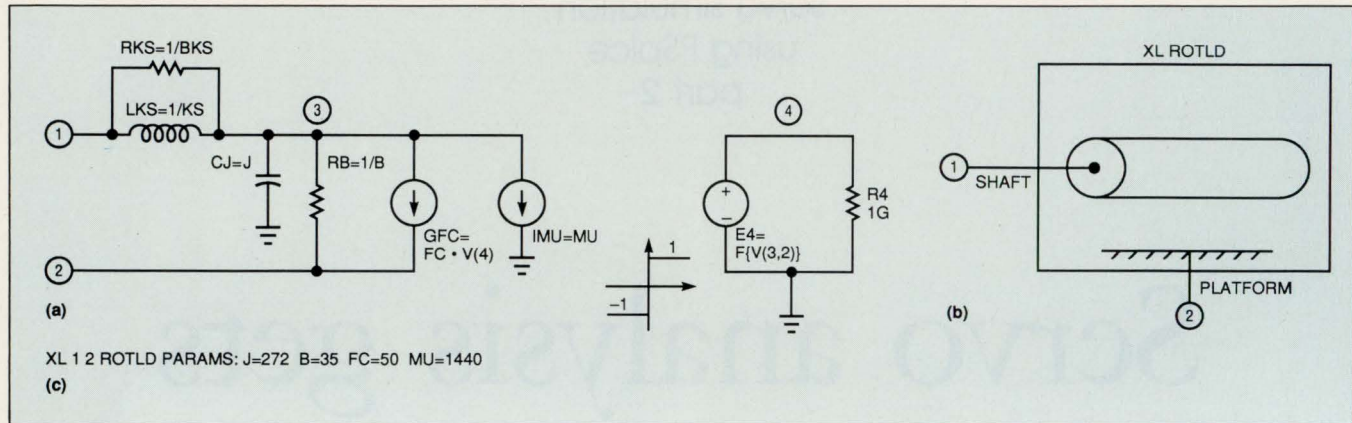

**Fig 1**—This equivalent circuit for a rotational load (a) includes elements that simulate moment of inertia, viscous damping, coulomb friction, stiffness, and mass unbalance, whose values you define in the subcircuit call statement (c). The subcircuit block has two external connections, as b shows.

speed in rad/sec relative to space. Note that the torque delivered to the shaft will not equal the torque returned to the platform because the returns from the moment of inertia and mass unbalance connect directly to space or ground. The platform connection allows an independent platform velocity input. You might need to use such an input in the case of an airborne application in which the airframe can undergo rapid velocity changes.

This rotational-load model contains coulomb friction, so be sure to set this parameter to zero for ac small-signal analysis, or bias the solution away from the transition regions. Part 1 discussed the potential problems that can occur at these regions.

### Gear train meets its electrical match

The gear train is another mechanical subsystem and is analogous to an electrical transformer (Ref 1). The output torque or current is equal to the input torque times the gear ratio. The output shaft velocity or voltage is equal to the input shaft velocity divided by the gear ratio. For an ideal gear train or transformer, the output power equals the input power. Fig 2's equivalent circuit of a gear train includes input and output inertia, friction, and stiffness. The sources EB1 and GT2 model the ideal portion of the gear. Source VT1 is used to measure the input torque. The remaining elements model inertia, friction, and stiffness of the input and output gears. The parameters N1 and N2 are the number of teeth on the input and output gears, respectively, and define the gear ratio, N, which equals  $N2/N1$ .

Listing 2 gives the code for the gear-train subcircuit

named GEAR. The comments at the beginning of the code define the parameters. The external nodes 1 to 4 define the connection of the gear train to the system. There are two independent platform connections, nodes 2 and 4, allowing for movement between an input platform and an output platform. Generally, you would tie these together to a single platform.

The gear-train model is linear except for the two coulomb-friction parameters, F1 and F2. For ac small-signal analysis, set  $F1 = F2 = 0$  (the default values), or bias the solution away from the transition region.

The previous gear-train model ignores backlash. However, in some gear trains, backlash is an important parameter. If the amount of backlash is too large, the servo system can oscillate (Ref 2). Backlash occurs when the input and output gears do not mesh, which stops the transmission of power.

### Listing 1—Pspice code for simple rotational load

```
.SUBCKT ROTLD 1 2 PARAMS:J=1P B=1N KS=1G BKS=1N FC=0 MU=0
* ROTATIONAL LOAD MODEL INCLUDING INERTIA, VISCOUS FRICTION,
* SHAFT SPRING CONSTANT, COULOMB FRICTION, AND MASS UNBALANCE
* NODE 1 IS SHAFT SPEED IN RAD/SEC RELATIVE TO SPACE
* NODE 2 IS PLATFORM SPEED IN RAD/SEC RELATIVE TO SPACE
* NODE 0 IS SPACE REFERENCE
* CURRENT INTO NODE 1 IS TORQUE DELIVERED IN OZ-IN
* UNITS : OZ,IN,RAD/SEC
* J IS INERTIA OF LOAD IN OZ-IN-SEC/RAD/SEC
* B IS VISCOUS FRICTION OF LOAD IN OZ-IN/RAD/SEC
* KS IS SHAFT SPRING CONSTANT IN OZ-IN/RAD
* BKS IS SHAFT SPRING DAMPING IN OZ-IN/RAD/SEC
* FC IS COULOMB FRICTION IN OZ-IN
* MU IS MASS UNBALANCE IN OZ-IN
LKS 1 3 (1/KS)
RKS 1 3 (1/BKS)
CJ 3 0 (J)
RB 3 2 (1/B)
* CIRCUIT TO MODEL COULOMB FRICTION
E4 4 0 TABLE {V(3,2)} = (-.1M,-1) (.1M,1)
R4 4 0 1G
GFC 3 2 VALUE = {FC*V(4)}
* CONSTANT MASS UNBALANCE
IMU 3 0 (MU)
.ENDS ROTLD
```



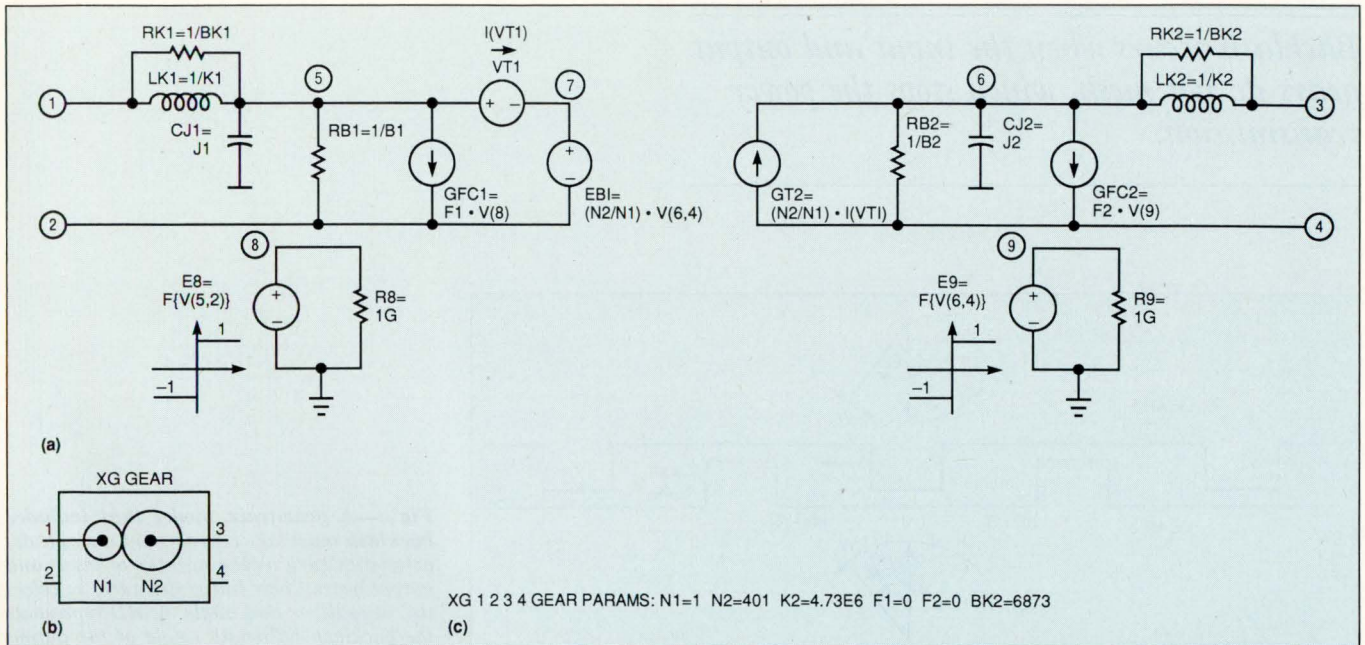

Fig 2—The sources  $EB1$  and  $GT2$  of this gear train's equivalent circuit (a) simulate ideal characteristics. Other elements model inertia, friction, and stiffness of the input and output gears. The subcircuit symbol (b) displays the four external connections. The parameters  $N1$  and  $N2$  in the corresponding call statement (c) define the gear ratio.

To derive the equations for backlash, first define the following variables for Fig 3:

- $\omega_1$  = input-gear speed in rad/sec
- $\theta_1$  = input-gear angle in radians
- $N_1$  = number of input-gear teeth
- $R_1$  = input-gear radius
- $v_1$  = input-gear linear velocity
- $x_1$  = input-gear linear distance
- $\omega_2$  = output-gear speed in rad/sec
- $\theta_2$  = output-gear angle in radians
- $N_2$  = number of output-gear teeth
- $R_2$  = output-gear radius
- $v_2$  = output-gear linear velocity
- $x_2$  = output-gear linear distance
- $N$  = the gear ratio,  $N_2/N_1$
- $HD$  = backlash halfwidth angle at output gear in radians.

When the two gears are in contact, the tangential velocities,  $v_1$  and  $v_2$ , are equal. Thus,

$$\omega_1 R_1 = \omega_2 R_2.$$

Because  $R_2 = NR_1$ , it follows that

$$\omega_1 = N\omega_2.$$

In order for the two gears to contact, the linear distance traveled by the first gear relative to the second gear starting from the center position must be

$$x_1 - x_2 = HD \cdot R_2.$$

Dividing this entire equation by  $R_1$ , substituting  $NR_1$

### Listing 2—PSpice code for gear train

```
.SUBCKT GEAR 1 2 3 4 PARAMS: N1=1 J1=1P B1=1P F1=0 K1=1G BK1=1N
+
N2=1 J2=1P B2=1P F2=0 K2=1G BK2=1N
* NODE 1 IS INPUT SHAFT SPEED IN RAD/SEC RELATIVE TO SPACE
* NODE 2 IS INPUT PLATFORM SHAFT SPEED IN RAD/SEC RELATIVE TO SPACE
* NODE 3 IS OUTPUT SHAFT SPEED IN RAD/SEC RELATIVE TO SPACE
* NODE 4 IS OUTPUT PLATFORM SHAFT SPEED IN RAD/SEC RELATIVE TO SPACE
* NODE 0 IS SPACE REFERENCE
* CURRENT INTO NODE 1 IS TORQUE DELIVERED IN OZ-IN
* CURRENT OUT OF NODE 3 IS TORQUE DELIVERED IN OZ-IN
* UNITS: OZ, IN, RAD/SEC
* N1 IS NUMBER OF TEETH ON INPUT GEAR
* J1 IS INPUT GEAR INERTIA IN OZ-IN-SEC/RAD/SEC
* B1 IS INPUT GEAR VISCOUS FRICTION IN OZ-IN/RAD/SEC
* F1 IS INPUT GEAR COULOMB FRICTION IN OZ-IN
* K1 IS INPUT GEAR SHAFT SPRING CONSTANT IN OZ-IN/RAD
* BK1 IS INPUT GEAR SHAFT DAMPING IN OZ-IN/RAD/SEC
* N2 IS NUMBER OF TEETH ON OUTPUT GEAR
* J2 IS OUTPUT GEAR INERTIA IN OZ-IN-SEC/RAD/SEC
* B2 IS OUTPUT GEAR VISCOUS FRICTION IN OZ-IN/RAD/SEC
* F2 IS OUTPUT GEAR COULOMB FRICTION IN OZ-IN
* K2 IS OUTPUT GEAR SHAFT SPRING CONSTANT IN OZ-IN/RAD
* BK2 IS OUTPUT GEAR SHAFT DAMPING IN OZ-IN/RAD/SEC
LK1 1 5 (1/K1)
RK1 1 5 (1/BK1)
CJ1 5 0 (J1)
RB1 5 2 (1/B1)
E8 8 0 TABLE (V(5,2)) = (-.1M,-1) (.1M,1)
R8 8 0 1G
GFC1 5 2 VALUE = (F1*V(8))
VT1 5 7
EB1 7 2 VALUE = ((N2/N1)*V(6,4))
GT2 4 6 VALUE = ((N2/N1)*I(VT1))
CJ2 6 0 (J2)
RB2 6 4 (1/B2)
E9 9 0 TABLE (V(6,4)) = (-.1M,-1) (.1M,1)
R9 9 0 1G
GFC2 6 4 VALUE = (F2*V(9))
LK2 6 3 (1/K2)
RK2 6 3 (1/BK2)
.ENDS GEAR
```

for  $R_2$ , and using small-angle approximations yields the following condition for gear contact in the positive direction:

$$\theta_1 - N\theta_2 = N \cdot HD. \quad (1)$$

If contact is to occur in the positive direction,  $v_1$  must be greater than  $v_2$  prior to contact. If, after contact occurs,  $v_1$  falls below  $v_2$ , the gears will separate until contact is made in the negative direction when the following condition exists:

$$\theta_1 - N\theta_2 = -N \cdot HD. \quad (2)$$

This equation is the condition for gear contact in the



*Backlash occurs when the input and output gears do not mesh, which stops the power transmission.*

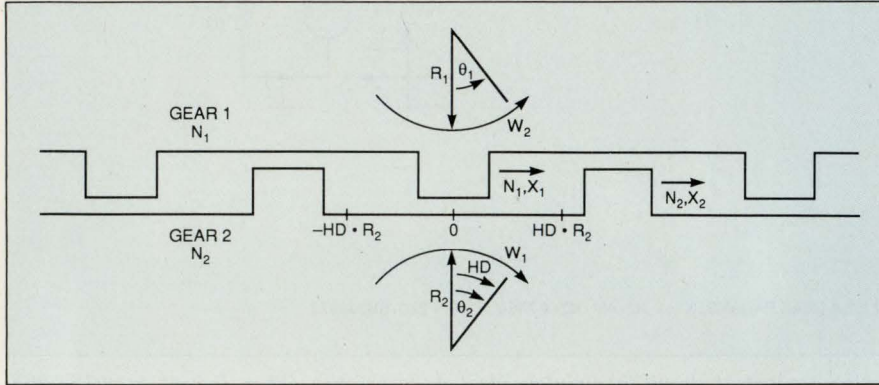

**Fig 3—A gear-train model that includes backlash must take into account many characteristics such as the number of input and output gears; their linear distance,  $x$ ; velocity,  $v$ ; radii,  $r$ ; and angle,  $\theta$ .  $HD$  represents the backlash halfwidth angle at the output gear.**

negative direction. If contact is to occur in the negative direction,  $v_1$  must be less than  $v_2$  just before contact.

By dividing the differential linear velocity  $\Delta v$ , which equals  $v_1 - v_2$ , by the radius  $R_1$ , you can derive the differential angular velocity at the input gear as follows:

$$\Delta\omega_{IN} = \omega_1 - N\omega_2.$$

The differential angle at the input gear is

$$\Delta\theta_{IN} = \theta_1 - N\theta_2 = \int \Delta\omega_{IN} dt.$$

The differential angle at the output gear is

$$\Delta\theta_{OUT} = \Delta\theta_{IN}/N.$$

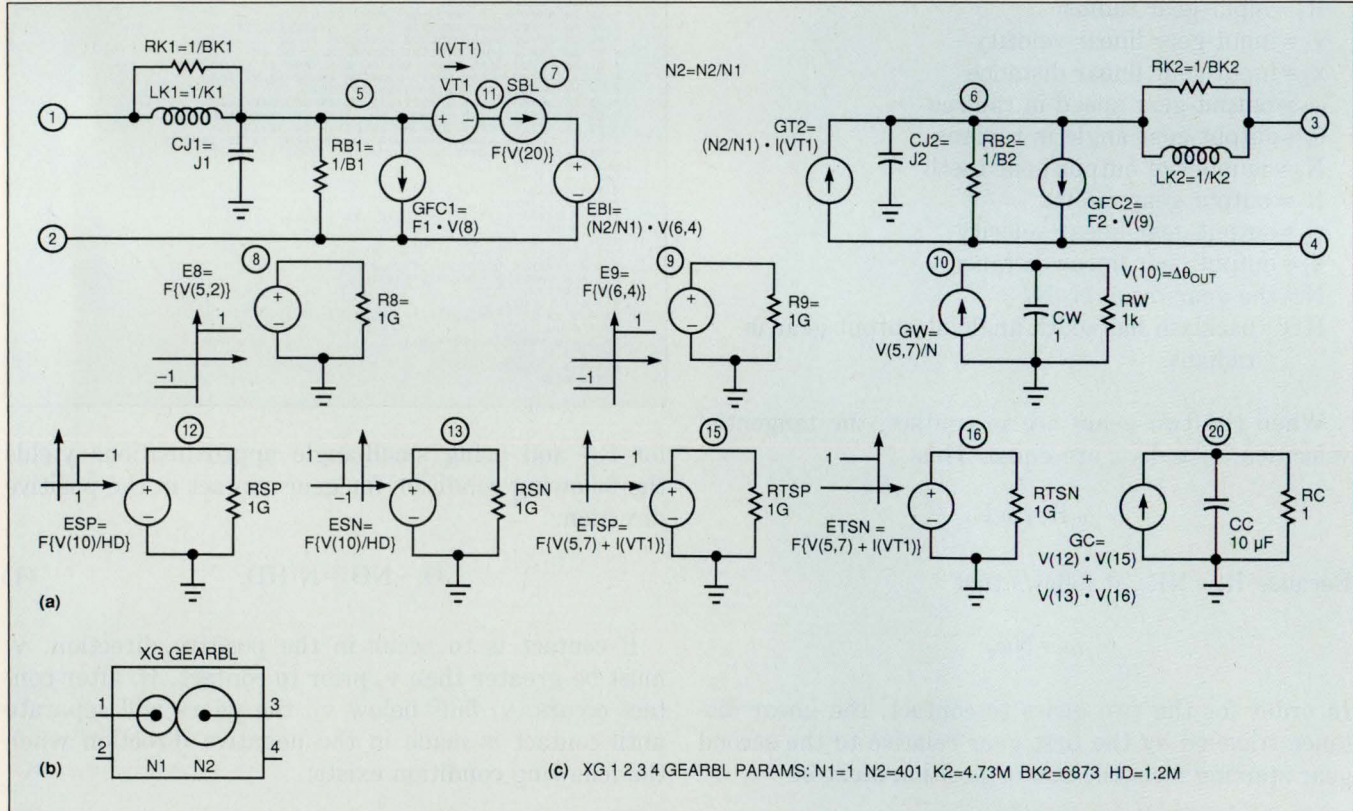

**Fig 4—The equivalent circuit for a gear train with backlash (a) includes a controlled source,  $SBL$ , which acts as a switch.  $SBL$  is an open circuit when the gears are in backlash and a short when the gears mesh. The subcircuit symbol (b) is identical to the gear train without backlash; the call statement in c defines backlash parameters such as  $HD$ .**



From Eqs 1 and 2, the gears mesh when either

$$\Delta\theta_{OUT} \geq HD \text{ and } \Delta\omega_{IN} > 0, \quad (3)$$

or

$$\Delta\theta_{OUT} \leq -HD \text{ and } \Delta\omega_{IN} < 0. \quad (4)$$

Alternately, the gears are in the backlash region when the absolute value of  $\Delta\theta_{OUT}$  is less than HD; that is, when the relative angle of the gears is less than the backlash halfwidth angle.

### Backlash circuit uses a switch

Fig 4 shows the equivalent circuit for a gear train with backlash. The main difference between Fig 4 and Fig 2 is Fig 4's controlled source, SBL, which acts as a switch. In the backlash region, SBL is an open circuit, disconnecting the input gear from the output gear. When the gears mesh, SBL acts as a short, connecting the input and output gears. Controlled current source GW and capacitor CW together determine  $\Delta\theta_{OUT}$  at node 10, because the voltage drop from node 5 to 7— $V(5,7)$  in Spice nomenclature—is

$$V(5,7) = \omega_1 - N\omega_2 = \Delta\omega_{IN},$$

and the voltage at node 10— $V(10)$  in Spice nomenclature—equals

$$V(10) = \int (V(5,7)/N) dt = \Delta\theta_{OUT}.$$

Listing 3 is the code for the gear train with backlash subcircuit (GEARBL). The source ESP uses the table function to set  $V(12)$  equal to 1 when  $V(10) > HD$  and to set  $V(12) = 0$  when  $V(10) < HD$ . Similarly, the source ETSP uses the table function to set  $V(15) = 1$  when  $V(5,7) > 0$  or  $I(VT1) > 0$  and to set  $V(15) = 0$  when  $V(5,7) < 0$  or  $I(VT1) < 0$ . When both  $V(12)$  and  $V(15)$  are high, the condition in either Eq 3 or 4 is satisfied, and the resistance of voltage-controlled resistor SBL is set low, connecting nodes 11 and 7 through a low resistance. The control voltage,  $V(20)$ , and the following parameters determine the resistance of source SBL:  $RON = 1M$ ,  $ROFF = 1MEG$ ,  $VON = 1$ ,  $VOFF = 0$ .

The control voltage  $V(20)$  is equal to the quantity  $(V(12) \times V(15)) + (V(13) \times V(16))$ . If both  $V(12)$  and  $V(15)$  are high or  $V(13)$  and  $V(16)$  are high, then the switch resistance is low and nodes 11 and 7 are connected. If any of the nodes 12, 13, 15, or 16 equal 0,

### Listing 3—PSpice code for gear train with backlash

```
.SUBCKT GEARBL 1 2 3 4 PARAMS: N1=1 J1=1P B1=1P F1=0 K1=1G BK1=1N
+
+ N2=1 J2=1P B2=1P F2=0 K2=1G BK2=1N
+
+ HD=1U
* NODE 1 IS INPUT SHAFT SPEED IN RAD/SEC RELATIVE TO SPACE
* NODE 2 IS INPUT PLATFORM SHAFT SPEED IN RAD/SEC RELATIVE TO SPACE
* NODE 3 IS OUTPUT SHAFT SPEED IN RAD/SEC RELATIVE TO SPACE
* NODE 4 IS OUTPUT PLATFORM SHAFT SPEED IN RAD/SEC RELATIVE TO SPACE
* NODE 0 IS SPACE REFERENCE
* CURRENT INTO NODE 1 IS TORQUE DELIVERED IN OZ-IN
* CURRENT OUT OF NODE 3 IS TORQUE DELIVERED IN OZ-IN
* UNITS: OZ, IN, RAD/SEC
* N1 IS NUMBER OF TEETH ON INPUT GEAR
* J1 IS INPUT GEAR INERTIA IN OZ-IN-SEC/RAD/SEC
* B1 IS INPUT GEAR VISCOUS FRICTION IN OZ-IN/RAD/SEC
* F1 IS INPUT GEAR COULOMB FRICTION IN OZ-IN
* K1 IS INPUT GEAR SHAFT SPRING CONSTANT IN OZ-IN/RAD
* BK1 IS INPUT GEAR SHAFT DAMPING IN OZ-IN/RAD/SEC
* N2 IS NUMBER OF TEETH ON OUTPUT GEAR
* J2 IS OUTPUT GEAR INERTIA
* B2 IS OUTPUT GEAR VISCOUS FRICTION
* F2 IS OUTPUT GEAR COULOMB FRICTION
* K2 IS OUTPUT GEAR SHAFT SPRING CONSTANT
* BK2 IS OUTPUT GEAR SHAFT DAMPING IN OZ-IN/RAD/SEC
* HD IS BACKLASH HALF WIDTH IN RAD REFERRED TO OUTPUT GEAR
LK1 1 5 (1/K1)
RK1 1 5 (1/BK1)
CJ1 5 0 (J1)
RB1 5 2 (1/B1)
EB 8 0 TABLE (V(5,2)) = (-.1M,-1) (.1M,1)
RB 8 0 1G
GFC1 5 2 VALUE = (F1*V(8))
VT1 5 11
EB1 7 2 VALUE = ((N2/N1)*V(6,4))
GT2 4 6 VALUE = ((N2/N1)*I(VT1))
CJ2 6 0 (J2)
RB2 6 4 (1/B2)
E9 9 0 TABLE (V(6,4)) = (-.1M,-1) (.1M,1)
R9 9 0 1G
GFC2 6 4 VALUE = (F2*V(9))
LK2 6 3 (1/K2)
RK2 6 3 (1/BK2)
*
* CIRCUIT TO CALCULATE BACKLASH HALF WIDTH
*
* V(10) = GEAR OFFSET ANGLE IN RADS REFERRED TO OUTPUT GEAR
* V(10) = INTEGRAL[(W1-N*W2)/N] = (THETA1-N*THETA2)/N = THETA1/N - THETA2/N
GW 0 10 VALUE = (V(5,7)/(N2/N1))
CW 10 0
RW 10 0 1K
* CALCULATE POSITIVE BACKLASH SWITCH CLOSURE = V(12)
* V(12) = 0 WHEN V(10) < HD
* V(12) = 1 WHEN V(10) > 1.01*HD
ESP 12 0 TABLE (V(10)/HD) = (.99,0) (1,0) (1.01,1) (1.02,1)
RSP 12 0 1G
* CALCULATE NEGATIVE BACKLASH SWITCH CLOSURE = V(13)
* V(13) = 0 WHEN V(10) > -HD
* V(13) = 1 WHEN V(10) < -1.01*HD
ESN 13 0 TABLE (V(10)/HD) = (-1.02,1) (-1.01,1) (-1,0) (-.99,0)
RSN 13 0 1G
* INPUT TORQUE DIRECTION SENSORS
* IF TORQUE < 0 OR V(5,7) < 0 THEN SET V(15)=0
* OPEN POSITIVE BACKLASH SWITCH FOR NEGATIVE TORQUE OR ROTATION
ETSP 15 0 TABLE (V(5,7)+I(VT1)) = (-10M,0) (0,0) (10M,1) (20M,1)
RTSP 15 0 1G
* IF TORQUE > 0 OR V(5,7) > 0 THEN SET V(16)=0
* OPEN NEGATIVE BACKLASH SWITCH FOR POSITIVE TORQUE OR ROTATION
ETSN 16 0 TABLE (V(5,7)+I(VT1)) = (-20M,1) (-10M,1) (0,0) (10M,0)
RTSN 16 0 1G
* BACKLASH SWITCH TO DISCONNECT INPUT GEAR FROM OUTPUT GEAR
GC 0 20 VALUE = (V(12)*V(15)+V(13)*V(16))
RC 20 0 1
CC 20 0 10UF
SBL 11 7 20 0 RBL
.MODEL RBL VSWITCH (RON=1M ROFF=1MEG VON=1 VOFF=0)
.ENDS GEARBL
```

then the switch resistance is high, nodes 11 and 7 are disconnected, and the gear train is in the backlash region. Sources ESN and ETSN determine the backlash region for negative offset angles. Elements CC and RC slow the switch transition times, which helps improve transient convergence.

Although the equivalent circuit for the gear train with backlash is fairly complex, using the circuit isn't. You simply define the input and output node connections and give the relevant parameter values, as Fig 4 shows. In the main-system description, one line describes each subcircuit. As in all simulations, the models should be only as complex as required. If backlash is negligible, use Fig 2's model for a gear train, which



The gear-train-with-backlash model includes a controlled source that operates as a switch.

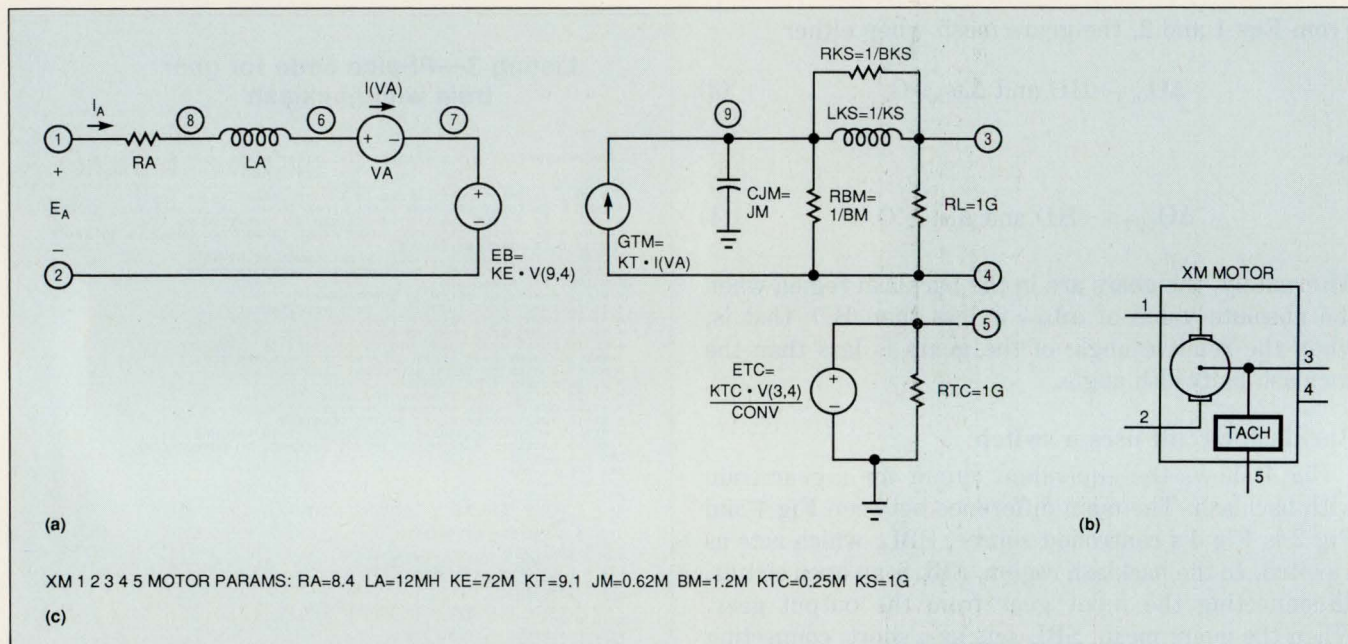

Fig 5—RA and LA model the armature resistance and inductance, respectively, of this dc motor equivalent circuit (a). The subcircuit has five external connections, as b shows, two inputs, two outputs, and one tachometer output. Again, the call statement (c) requires you to define a number of parameters.

is much simpler. The backlash model can greatly lengthen the simulation time because fast transients occur whenever the gear hits the backlash region, an event that can occur many times during a simulation. Backlash also causes a problem for ac small-signal analysis because the backlash condition prevents signals from transmitting through the gear train. For ac analysis, either bias the gear out of the backlash region or use the Fig 2 gear model, which has no backlash.

The servo motor connects the electrical and mechanical parts of a servo system. The motor's input is electrical, and its output is mechanical. The dc motor with armature control and the permanent-magnet motor are analogous to an electrical transformer. The input's electrical power is equal to the output's mechanical power. The torque is proportional to the armature current,  $I_A$ , and equals

$$T = K_T I_A$$

where  $K_T$  is the motor's torque constant. The back EMF,  $E_B$ , produced in the armature circuit is proportional to the motor speed,  $\omega_M$ , as follows:

$$E_B = K_E \omega_M.$$

$K_E$  is the back EMF constant. For an ideal dc motor,

$$I_A E_B = T \omega_M \text{ (watts).}$$

Fig 5 shows the analogous equivalent circuit for the dc motor (Refs 1, 2, and 3). Listing 4 presents the

#### Listing 4—P Spice code for dc motor with armature control

```
.SUBCKT MOTOR 1 2 3 4 5 PARAMS:RA=1M LA=1NH KE=7.06M KT=1 JM=1P
+ BM=1N KTC=1M KS=1G BKS=1N
+ CONV=-.10472
* DC MOTOR WITH ARMATURE CONTROL
* NODE 1 IS POSITIVE MOTOR ARMATURE VOLTAGE
* NODE 2 IS NEGATIVE MOTOR ARMATURE VOLTAGE
* NODE 3 IS MOTOR SHAFT SPEED IN RAD/SEC RELATIVE TO SPACE
* NODE 4 IS MOTOR PLATFORM SPEED IN RAD/SEC RELATIVE TO SPACE
* NODE 0 IS SPACE REFERENCE
* NODE 5 IS TACH OUTPUT IN VOLTS OF MOTOR SPEED RELATIVE TO PLATFORM
* CURRENT OUT OF NODE 3 IS TORQUE DELIVERED IN OZ-IN
UNITS : OZ,IN,RAD/SEC
* RA IS ARMATURE RESISTANCE IN OHMS
* LA IS ARMATURE INDUCTANCE IN HENRIES
* KE IS MOTOR BACK EMF CONSTANT IN VOLTS/RAD/SEC
* KT IS MOTOR TORQUE CONSTANT IN OZ-IN/AMP
* JM IS MOTOR INERTIA IN OZ-IN-SEC/RAD/SEC
* BM IS MOTOR VISCOUS FRICTION IN OZ-IN/RAD/SEC
* KS IS MOTOR SPRING CONSTANT IN OZ-IN/RAD
* BKS IS SHAFT SPRING DAMPING IN OZ-IN/RAD/SEC
* KTC IS TACHOMETER GAIN CONSTANT IN VOLTS/RPM
* CONV IS RPM TO RAD/SEC CONVERSION CONSTANT = 2PI/60
RA 1 8 (RA)
LA 8 6 (LA)
VA 6 7
EB 7 2 VALUE = (KE*V(9,4))
GTM 4 9 VALUE = (KT*I(VA))
CJM 9 0 (JM)
RBM 9 4 (1/BM)
LKS 9 3 (1/KS)
RKS 9 3 (1/BKS)
ETC 5 0 VALUE = (KTC*V(3,4)/CONV)
RTC 5 0 1G
RL 3 4 1G
.ENDS MOTOR
```



# Introducing the only linears approved to meet IEC 950 and Level B EMI.

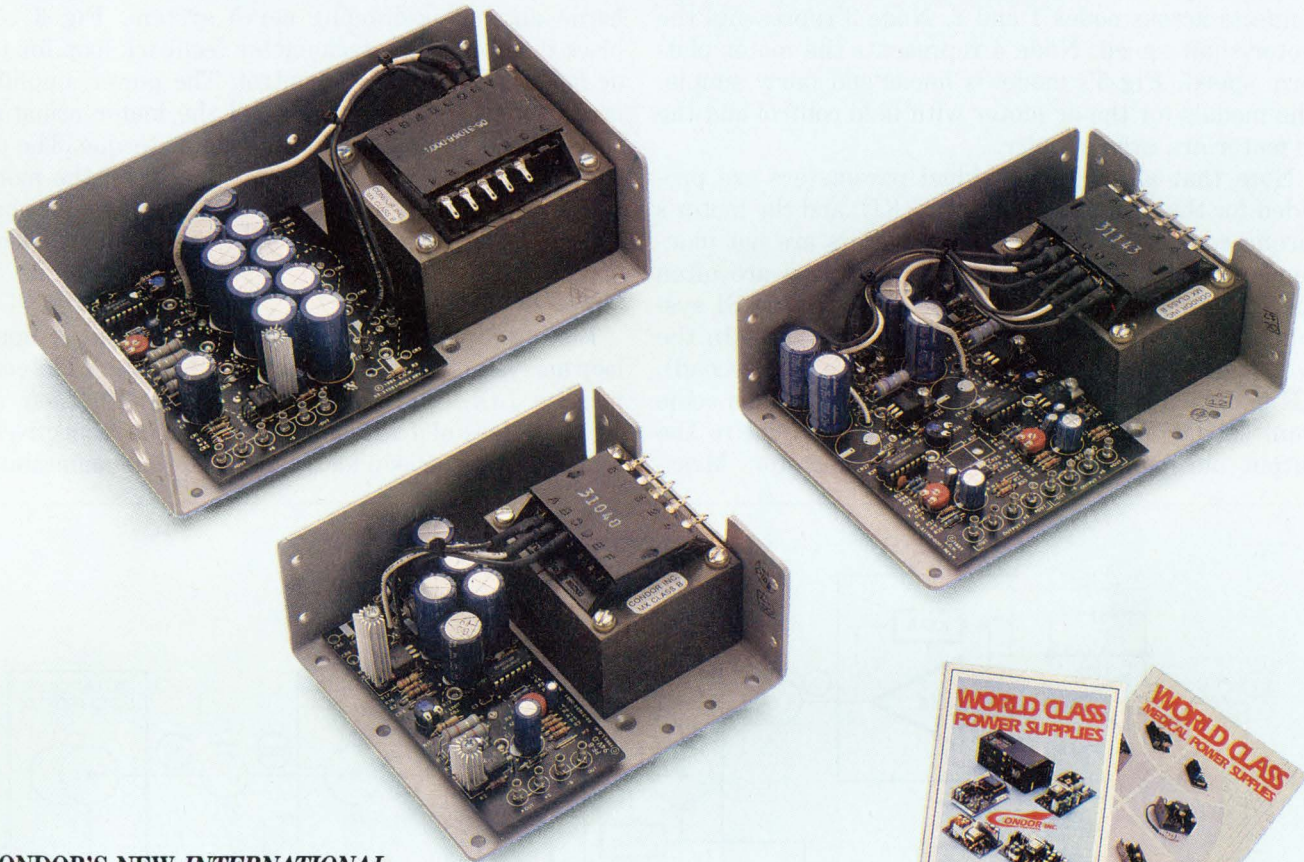

## CONDOR'S NEW *INTERNATIONAL PLUS* LINEAR D.C. POWER SUPPLIES MEET TOMORROW'S TOUGH STANDARDS TODAY!

Our International Plus linears offer you performance, price and one more important feature: the agency approvals you need for the 90's, including IEC 950 and VDE 0871 level B EMI. And Condor has more approved linears in stock than anyone in the industry (including more than 30 models in IEC 601 medical versions).

International Plus linears have what you're looking for:

- 115 models (single and multi-output)
- 7 power levels — 3 to 288W
- Worldwide AC input ranges
- OVP on all 5V outputs

- Hermetically sealed power transistors
- MTBF 200,000+ hours per Mil Hndbk 217E
- 2-hour burn-in with cycling (8 hours on medicals)
- Computerized testing (data sheets furnished)
- 3-year warranty — longest in the industry
- 30-day FREE evaluation (call us for samples)

If you need world class performance, quick turnaround, competitive pricing *and* full agency approvals, call Condor — the leader in linear D.C. power supplies.

Call for our  
FREE catalogs!

- 300+ power supplies
- Standard and medical
- Switchers and linears
- Open frame and enclosed
- Custom capability

**CONDOR**

Condor Inc. D.C. Power Supplies  
2311 Statham Parkway  
Oxnard, CA 93033 • (805) 486-4565  
CALL TOLL-FREE:  
1-800-235-5929 (outside CA)  
FAX: (805) 487-8911



*Simulation models should be only as complex as necessary. If certain conditions, such as gear-train backlash, are negligible, use the simplest model.*

code for the subcircuit named MOTOR. RA is the armature resistance, and LA is the armature inductance. Additional parameters define the motor inertia, viscous friction, and shaft stiffness. In addition, a tachometer output is provided at node 5. The armature voltage connects across nodes 1 and 2. Node 3 represents the motor shaft speed. Node 4 represents the motor platform speed. Fig 5's model is linear and fairly simple. The models for the dc motor with field control and the ac motor are even simpler.

Note that although individual parameters are provided for the back EMF constant (KE) and the motor's torque constant (KT), these parameters are not independent (Refs 2 and 3), even though they are often specified independently. KE equals KT in the SI system of units (Newton, meter, radian, second). In the system of units used here (ounce, inch, radian, second), KE equals  $7.06 \times 10^{-3} \times KT$ . These relationships come from setting the input electrical power equal to the output mechanical power for an ideal motor. Measurements of KE and KT may differ due to parasitic losses, which are not accounted for.

The following example combines these mechanical models with standard electrical components to simulate the inner-most loop of the roll axis of a complex airborne antenna-positioning servo system. Fig 6 is a block diagram of the tachometer feedback loop for the dc motor with armature control. The power amplifier uses current feedback to control the motor armature current, thereby controlling the motor torque. The demodulator provides a feedback signal from the motor tachometer output, allowing control of the motor shaft speed. The op amp acts as a summer, closing the loop.

**Open the loop**

Listing 5 presents the PSpice code for an ac open-loop analysis of the tachometer feedback loop. The components LOL, COL, and VOL, along with their assigned values of 1 kHz, 1 kF, and 1V ac, respectively, serve to open the loop for ac analysis while maintaining

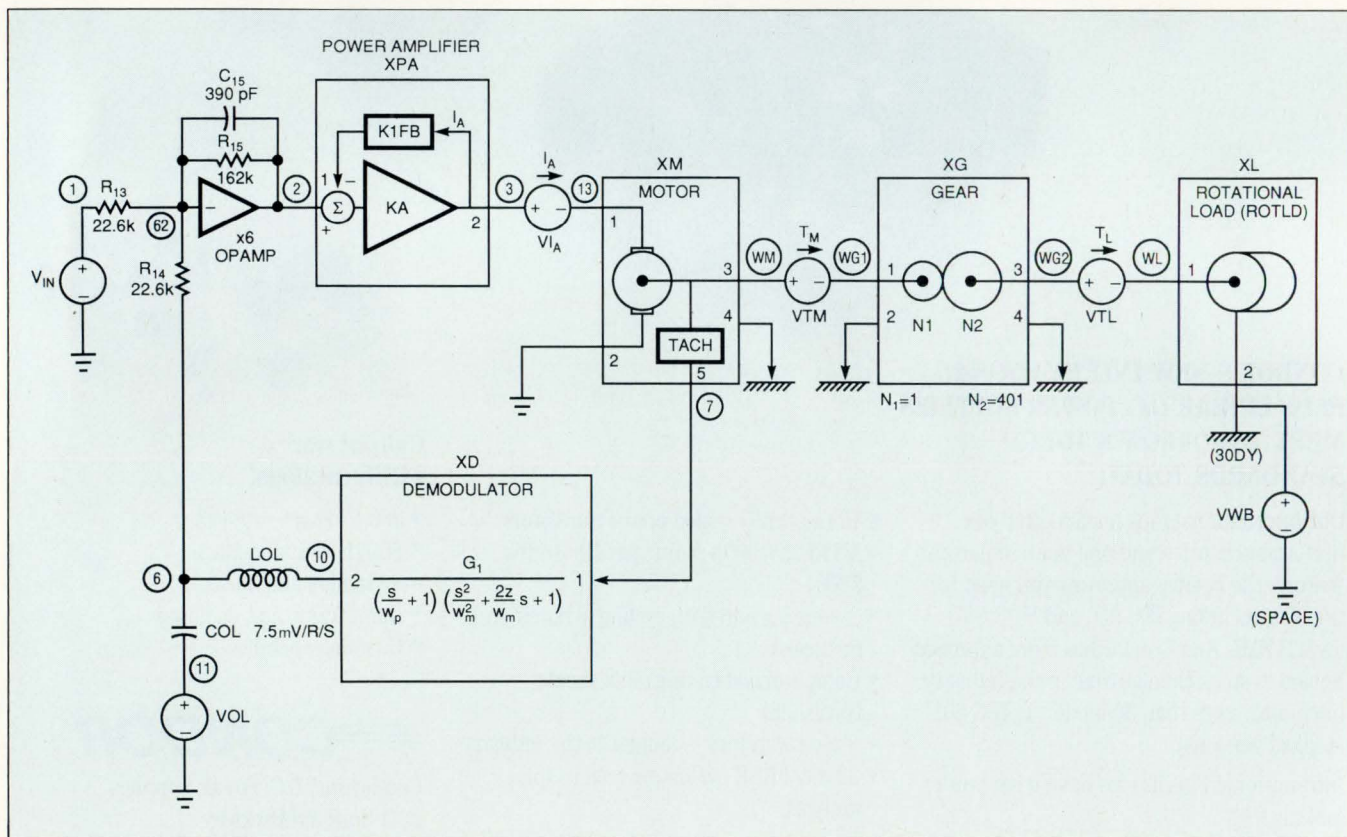

**Fig 6—This servo loop models a dc motor with tachometer-feedback control. The power amplifier uses current feedback to control the motor armature current thereby controlling the motor torque. The demodulator provides feedback from the motor, allowing the loop to control the motor shaft speed.**





68332  
Available  
Mar. 1990



HP emulator  
available  
Dec. 1989  
*(Got a little ahead  
of ourselves.)*



68331  
Available  
Sept. 1990



HP emulator  
available  
Nov. 1990



68302  
Available  
Oct. 1989



HP emulator  
available  
Aug. 1990  
*(We didn't start until  
Feb. 1990, but we finished  
it in 6 months.)*



68040  
Available  
Q4 1990



HP emulator  
available  
Q1 1991

## Coincidence? We don't think so.

Nobody supports the Motorola line of microprocessors better than the Hewlett-Packard 64700 Series of emulators.

You see, HP has agreements with key chip manufacturers. Like Motorola. So while they're working on the next hottest chip design, we're simultaneously developing an emulator.

Our relationship with Motorola has allowed us to provide emulators this quickly for the new 68302, 68331 and 68332 processors.

As well as for the upcoming 68040. And, of course, we've always had broad support for the 68000, 68010, 68020 and 68030.

HP emulators also provide a complete solution. Logic and performance analysis tools and code coverage are all in the same box. They come with C cross compilers, simulators/debuggers and branch validators.

Even better, HP emulators work in real time without halting your target system. Which means you'll ensure a thorough analysis

of your design by executing it at full speed. Not by second-guessing.

All of this is accompanied by HP's renowned service and support. So call **1-800-752-0900, Ext. 1904** for a free demo disk or videotape. They'll demonstrate all the benefits of using an HP emulator. And by the way, if we answer your call quickly, it's no coincidence.





*Don't be surprised if certain parameters, especially nonlinear ones such as backlash, greatly increase the simulation time.*

the correct dc operating point. VOL injects a 1V ac signal at node 6, COL is a short at ac, and LOL is an open at ac. Under these conditions, and with VIN equal to zero, the voltage at node 10 equals the loop gain.

To perform meaningful ac analysis, the models must not include step-type nonlinearities or you must bias the circuit outside the nonlinear regions. Thus, use a power-amplifier model without deadzone, the gear model without backlash, and a simple rotational load model. Fig 7a shows the ac open-loop gain and phase

of the tachometer feedback loop. The open-loop cross-over frequency is 9.5 Hz, and the phase margin is 90°. The notch at 21 Hz and peak at 40 Hz are due to the gear-stiffness parameter K2 resonating with the load inertia and motor inertia. The gear-shaft damping parameter BK2 determines the Q of this resonance. The values for K2 and BK2 match the measured data. The gain margin for the tachometer loop is 12 dB at 190 Hz.

You can obtain the ac closed-loop response by setting LOL=1 nH, COL=1 pF, VOL=0V ac, and VIN to 1V ac. WM, the motor-shaft-speed node, now repre-

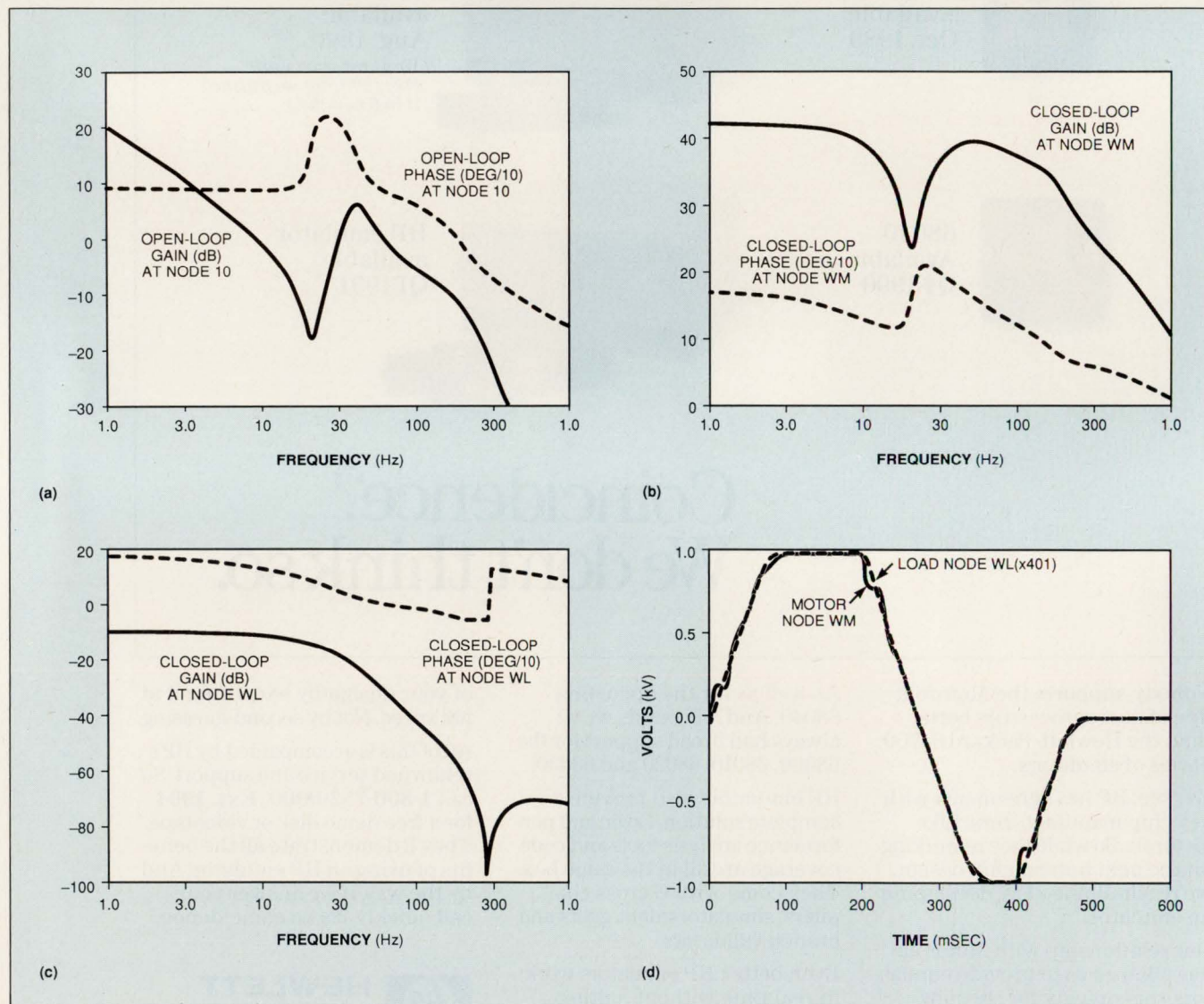

**Fig 7**—Using a combination of electrical and mechanical models, you can simulate Fig 6's tachometer loop and investigate the open-loop gain and phase (a), the closed-loop gain and phase at both the motor (b) and the load (c), and the transient response of the motor and load (d) to a square-wave input.



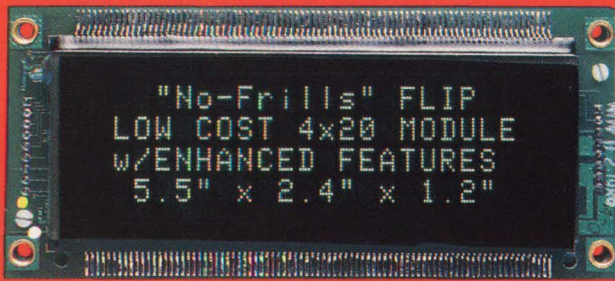

-90



-91A

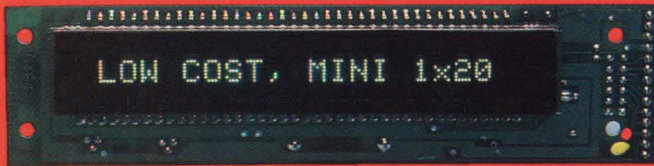

-92

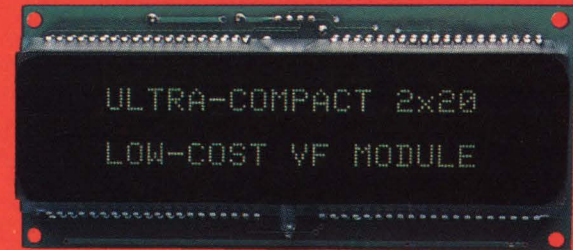

-95A

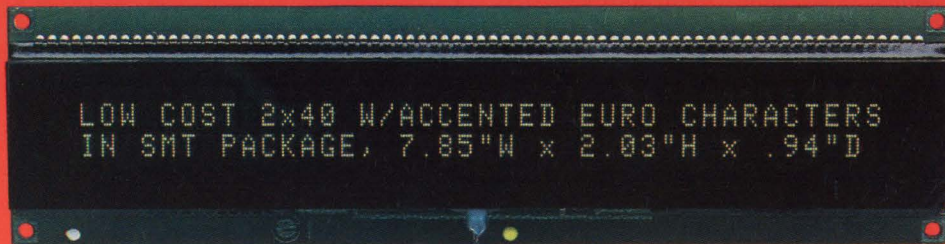

-96

## The Answers for the '90s

You know that a front-panel display is the first thing your customers will notice about your product. You need something to set your product apart from the competition, but you've got tight budget and packaging constraints. Now, IEE has a **new** family of **brilliant answers!**

You can have the **outstanding appearance** of a vacuum fluorescent display at an **affordable** price, with IEE's latest generation of enhanced "Ninety Series NO-FRILLS" FLIP™ VFD modules.

Price isn't the only thing that's unusually trim. Surface mount technology makes these modules exceptionally **compact**. Other features include:

- **Bright, easy to read** 5x7 dot matrix characters
- Software-controlled dimming
- Extended/Euro character set
- User-defined characters
- Only a single +5 VDC supply required
- On-board microprocessor accepts parallel ASCII data
- RS-232 and 20mA loop serial data cards available

Call or write today and tell us your problems. We offer a wide variety of display technologies; what you see here are just a few of the answers we can give you.

Industrial Electronic Engineers, Inc.  
Industrial Products Division  
7740 Lemona Avenue  
Van Nuys, CA 91405  
(818) 787-0311, ext. 418



Circle 10 for Immediate

Circle 11 for Reference



sents the closed-loop gain. Note that nodes with units of rad/sec have names starting with the letter "W" in Fig 6, which helps identify the mechanical speed nodes. Fig 7b shows the ac closed-loop gain and phase of the tachometer loop at the motor-shaft-speed node, WM. The -3-dB bandwidth of the tachometer loop at node WM is 10 Hz. The notch resulting from the gear-shaft stiffness is clearly seen at 21 Hz.

Fig 7c shows the ac closed-loop gain and phase of the tachometer loop at the load-shaft-speed node, WL. The response at the load is down 3 dB at a crossover frequency of 30 Hz where the phase shift is -120°. Note that this response is a 2-pole rolloff and that Fig 7b's notch at 21 Hz is no longer present. The notch at 300 Hz is caused by the high parasitic stiffness—KS=1G—included in the rotational load model and is of no consequence at such a high frequency.

To test Fig 6's transient response, the input voltage VIN steps from 0 to -7.5V for 0.2 sec, and then steps up to 7.5V for 0.2 sec before returning to zero (Listing 5). This input corresponds to commanding the motor speed to go to 1000 rad/sec for 0.2 sec then to -1000 rad/sec for 0.2 sec before returning to zero. Fig 7d shows the motor-speed response and the load-speed response. There is significant slewing because of the power amplifier's 3.5A current limit. The load torque showed some ringing because of the gear-shaft stiffness, but the load-speed response was smooth. These responses were obtained with no dead zone and no backlash.

The PSpice program is particularly efficient for ac analysis. Frequency sweeps with 150 data points typically took 20 seconds to run on a Compaq 386/33 with a 80387/33 coprocessor. Transient runs took several minutes to run. Including gear backlash in the model greatly increases the transient runtime, depending on how many times the simulation traverses the backlash region. In this example, adding backlash to the tachometer loop circuit caused very little difference in the output. However, the simulation crossed the backlash region three times, causing the CPU time to triple. When running worst-case analysis, remember that the runtime is proportional to the number of cases.

As enhanced versions of Spice continue to improve, they will become even more useful for the simulation of servo systems. Areas of possible improvement include the ability to assign mechanical unit labels, the ability to directly assign tolerances to subcircuit parameters, and faster execution of behavioral models during transient analysis.

EDN

## Listing 5—PSpice code for tachometer loop simulation

```

ANTENNA SERVO - TACH LOOP SIMULATION
* TACHLOOP.CIR
* NODE NAMES STARTING WITH W ARE SPEED IN RAD/SEC
* CURRENT AT SPEED NODES IS TORQUE IN OZ-IN
*
* PARAMETERS
.PARAM PI2=6.2831853
*
* INPUT TACH VELOCITY COMMAND IN VOLTS : 7.5V=1000R/S AT MOTOR
VIN 1 0 AC 0 PWL(0S 0V 1MS -7.5V .2S -7.5V .201S 7.5V .4S 7.5V .401S 0)
*
* BODY TO SPACE SPEED INPUT IN RAD/SEC
VWB WB 0 AC 0 PWL(0 0 1MS 0)
*
* TACHOMETER LOOP FEEDBACK AMPLIFIER
R13 1 62 22.6K
R14 6 62 22.6K
R15 62 2 162K
C15 62 2 390PF
XG 0 62 2 OPAMP PARAMS: G1=200K WP=(5HZ*PI2) VLIM=13.5V
*
* MOTOR POWER AMPLIFIER
* FOR AC DO NOT USE DEADZONE
* XPA 2 3 POWAMPDZ PARAMS: KA=120 K1FB=3 ILIM=3.5A VLIM=130V DZ=.2V
* +
* + RO=1 WP=(100KHZ*PI2)
XPA 2 3 POWAMP PARAMS: KA=120 K1FB=3 ILIM=3.5A VLIM=130V RO=1
* +
* + WP=(100KHZ*PI2)
*
* MOTOR MODEL
VIA 3 13
XM 13 0 WM WB 7 MOTOR PARAMS: RA=8.4 LA=12MH KE=72M KT=9.1 JM=.62M
* +
* + BM=1.2M KTC=.25M
VTM WM WGI
*
* GEAR MODEL
* FOR AC SET F1=F2=0
XG WGI WB WGI WB GEAR PARAMS: N1=1 N2=401 K2=4.73MEG BK2=6873
* +
* + XG WGI WB WGI WB GEARBL PARAMS: N1=1 N2=401 K2=4.73MEG BK2=6873
* +
* + HD=1.2M
*
* ROTATIONAL LOAD MODEL
VTL WGI WL
* FOR AC SET FC=0
XL WL WB ROTLD PARAMS: J=272 B=35
*
* TACHOMETER DEMODULATOR MODEL
XD 7 10 DEMOD PARAMS: G1=3.14 WP=(19.5KHZ*PI2) Z=.47 WN=(202HZ*PI2)
*
* SET LOL=1KH , COL=1KF , VOL=1VAC FOR AC OPEN LOOP
* LOOP GAIN = VDB(10) VP(10)
LOL 10 6 1KH
COL 6 11 1KF
VOL 11 0 AC 1
*
* ANALYSIS COMMANDS
*
* .AC DEC 50 1HZ 100HZ
.AC DEC 50 1HZ 1KHZ
.PRINT AC VDB(10) VP(10) VDB(2) VDB(3) VDB(7) VDB([WM]) VDB([WL])
* +
* + VP([WL])
* .TRAN SMS 600MS 0MS SMS
.PRINT TRAN V(1) V(6) V(2) V(3) V([WM]) V([WL]) V(7)
.PRINT TRAN I(VIA) I(VTM) I(VTL)
.OP
.PROBE
.OPTIONS ACCT LIST NODE
.OPTIONS RELTOL=1M ABSTOL=1U VNTOL=1U
.OPTIONS ITL1=100 ITL2=20 ITL5=10000 CHGTOL=1C
*
.LIB SERVO.LIB
.END

```

## References

1. D'Azzo, J and C Houpis, *Linear Control System Analysis and Design*, McGraw-Hill, New York, 1981.
2. Kuo, B, *Automatic Control Systems*, Prentice Hall, NJ, 1987.
3. de Sa e Silva, C, "Motor Modeling Simplifies Design of Control Systems," *EDN*, pg 169, March 31, 1988.

## Author's biography

Dr Vincent G Bello is a senior member of the technical staff at the Norden Systems (Norwalk, CT) division of United Technologies and has been with the company for 21 years. He specializes in the analysis and design of analog circuits and has used Spice extensively. He developed widely used Spice models for switching regulators. Dr Bello has written one book, fourteen papers, and holds four patents. He has a bachelor's degree from Manhattan College and a masters and PhD from New York University.



Article Interest Quotient (Circle One)  
High 488 Medium 489 Low 490



# Strength In Numbers

## The power of dual platforms – more than a promise.

The leading electronics design automation solutions are available today on two industry-leading platforms.

Now DAZIX customers will benefit from products that reside on both Sun and Intergraph workstations. Robust solutions for the entire design process. Plus, an open-system framework that integrates Intergraph, DAZIX, and Sun products – as well as other leading EDA tools – in a simultaneous engineering environment.

## Billion-dollar backing.

Intergraph's financial strength gives DAZIX customers an added benefit – confidence. The confidence that comes from a partnership with the only EDA company

that is part of a billion-dollar computer graphics corporation. Ranked No. 3 in worldwide EDA sales. With an installed base of 13,000-plus EDA seats and capabilities developed over more than 22 years of providing integrated graphics solutions around the globe.

DAZIX customers are assured of continued product development and excellent support. Not just today and tomorrow, but into the future.

To learn more about our numbers, call us. In the United States, 800-239-4111. In Europe, 33-1-4537-7100. In the Asia-Pacific area, 852-8661966.

### CURRENTLY SUPPORTED WORKSTATIONS INCLUDE:

SPARCstation 2

SPARCstation IPC

SPARCstation 1+

SPARCstation 1

SPARCsystem 330

SPARCsystem 470

InterPro 2020

InterAct 2020

InterPro 6040

InterAct 6040

InterPro 6240

InterAct 6240



**DAZIX**<sup>®</sup>  
An Intergraph Company



Ask us about our new releases  
with many added features.

## The Complete Electronic Design Solution.

Tango

For complete specs  
and FREE evaluation  
packages, call  
800 433-7801



Tango is the pacesetter in affordable, PC-based electronic design. It offers the quality and performance engineering professionals demand, and the easiest-to-use interface available on any platform, at any price.

**Tango's powerful lineup.** Build your personal CAE/CAD workstation with Tango's start-to-finish design tools. **Tango-Schematic**,™ just \$495, includes over 8,000 SEDCO™ parts, the largest library on the PC. Experience **Tango-PLD**'s powerful top-down approach to logic design for only \$495. Add interactive logic simulation for up to 40,000 gates with **Susie**.™

Starting at just \$595, our popular PCB layout tools have designed *tens of thousands* of boards. There's **Tango-PCB PLUS**,™ for complex designs and **Tango-PCB**,™ a comprehensive, yet economical program for less demanding requirements. Tango designers have three fast and efficient autorouting options: the high-performance **Tango-Route**,™ multi-grid, multi-layer **Tango-Route PLUS**,™ and **Superoute**,™ the industry-leading rip-up and re-try, 100% completion autorouter. Finally, there's the **SMT Plus Library**,™ supplying proven land patterns for sophisticated SMT designs.

### **Tango extras at no extra charge.**

Your investment in Tango software includes clear, concise documentation; responsive technical support, free by phone or fax; first year of updates free, with affordable annual renewals; our 24-hour Tango BBS; directories of service bureaus and design consultants; a quarterly newsletter; and our money-back guarantee. Give us a call to discuss your design requirements. You'll find our customer service is as friendly as our software.

CIRCLE NO. 140

# Tango™

**Helping good ideas become great products.**

ACCEL Technologies, Inc.  
6825 Flanders Drive • San Diego, CA 92121  
619/554-1000 • Fax 619/554-1019

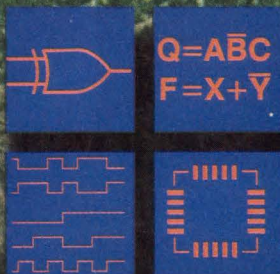

$Q = \bar{A}BC$   
 $F = X + \bar{Y}$

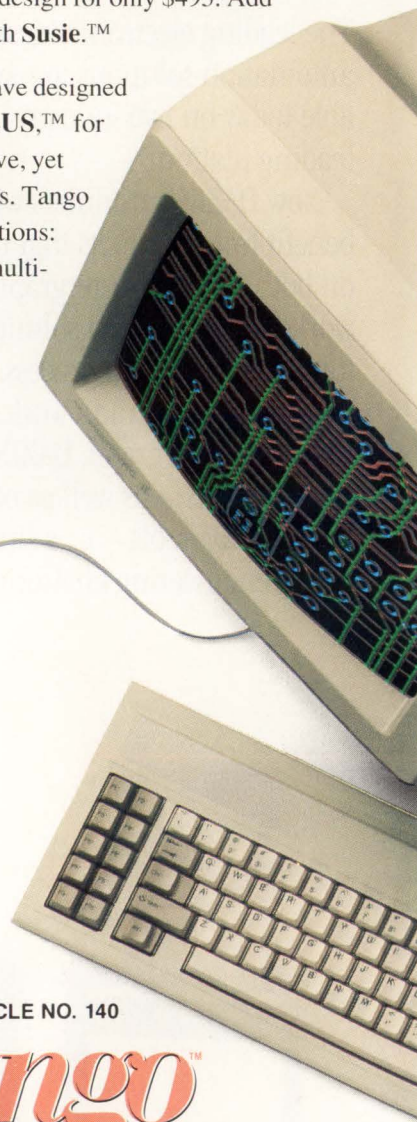



# THE **TODD** R E V O L U T I O N N

TIME.

## TODD's Partner in Power Packaging



Quality and product innovations evolve over time. One product innovation serving as a building block for yet another. One customer need sparking new ideas which transcend old limitations of size and space.

This is TODD's history. A quarter century of revolutionary achievements in advancing the design and development of switching power supplies. Setting standards which become the bench marks for the industry. Delivering quality products on time, every time, just in time.

Quality is customer satisfaction. And TODD customers are the true partners in progress. We listen. We work to under-

stand. We know the pressures of today's shorter design-to-market cycles. We respond to the demands and requirements of our customers for smaller, more powerful, more reliable, cost-effective switching power supplies for computers, telecommunications, medical electronics and industrial products.

The result is an ever-evolving product line incorporating an array of unique features and design alternatives, custom built in concept but available in standard, off-the-shelf quantities, pricing and delivery schedules.

Get all the facts about TODD products and services. And get them fast and complete. Use the fax hotline, 800 number or mail the postage paid reply card.

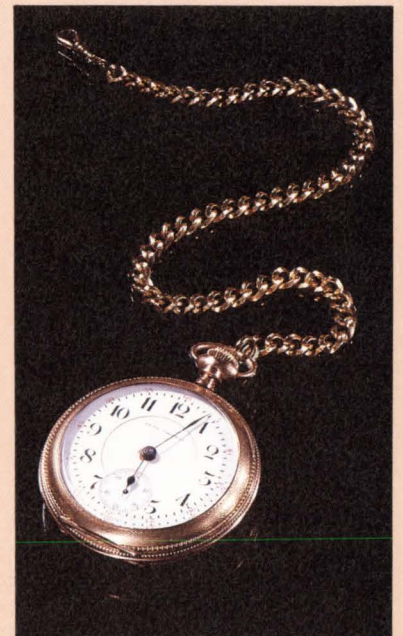
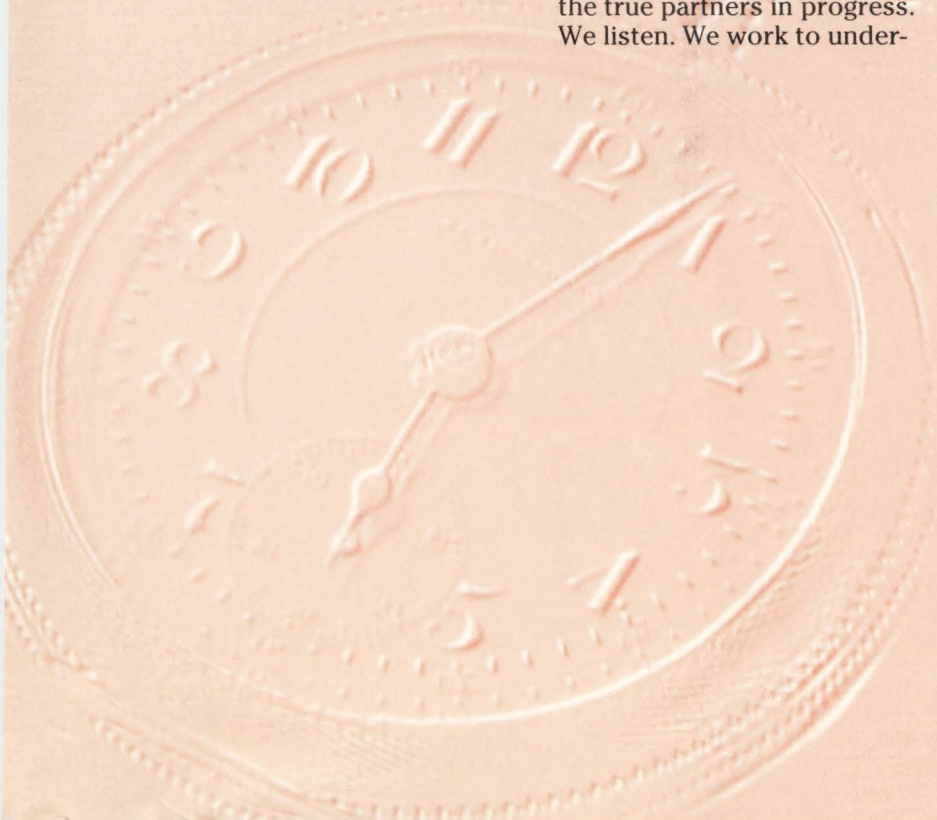



# THE TODD R E V O L U T I O N

**ADVANCED POWER PACKAGES:**

**The MAX Series of switching power supplies—the system designers' choice.**

**FEATURES:**

- 80% overall efficiencies
- Over 100,000 hours MTBF
- Meet International Safety Standards
- High efficiency MAGNA-FLUX ±1% post regulators
- System air or self-cooling
- AC autoline select option
- Power densities up to 4/watts in<sup>3</sup>
- From 30% to 58% smaller
- Cost/watt savings up to 30%

From standard voice and data networks to super micros and workstations, TODD's MAX series of switchers are increasingly become the #1 power choice of OEM system designers. Here's why:

Housed in a compact (2.5"x5"x9") package, the MAX 350's provide the outputs you need for ISDN, LAN and T1 applications – with yields of over three watts/in<sup>3</sup> across four fully regulated outputs. Select a MAX 350 with auxiliary outputs and power common peripherals, ECL systems, RS232 outputs, and communications drivers.

The MAX 500 "bus driver" series pack 500 watts into a 2.5"x5"x11.5" package with power densities of almost 3.5 watts/inch. With VMEbus and Multi-bus II compatibility, up to 16 amps of peak current, and the ability to power up to 80 amps of logic and four hard disk drives, these switchers will meet all your peripheral start up needs.

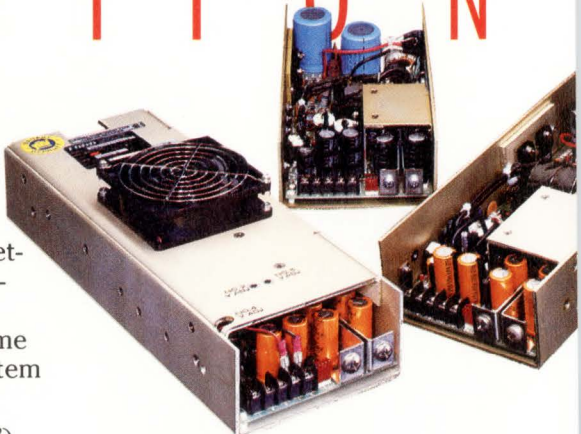

Specify the MAX 700/750 series and you'll get an unprecedented design freedom for your high-end computer products. Replace a 5"x8"x11" shoe box switcher with a 2.5"x5"x13.6" MAX 700 or 750 switcher, and you'll get a space savings of 58%. Or build in redundancy with two MAX 700's in place of one shoe box. And while you'd expect to pay more for this kind of design flexibility, you'll actually realize cost savings of up to 30% per watt.

The MAX series – evolutions in design bringing you revolutionary product enhancements.

## MAX SERIES HIGHLIGHTS

Model	350 WATTS: 2.5"x5"x9"			
	Output #1	Output #2	Output #3	Output #4
MAX-353-0512	+5V @ 50A	+12V @ 8/12Apk	-12V @ 4.0A	—
MAX-354-1205	+5V @ 50A	+12V @ 8/12Apk	-12V @ 4.0A	-5.2 @ 2.0A
MAX-354-1212	+5V @ 50A	+12V @ 8/12Apk	-12V @ 4.0A	12V @ 2.0A
MAX-354-1224	+5V @ 50A	+12V @ 8/12Apk	-12V @ 4.0A	+24V @ 1.5A
Model	400,500 WATTS: 2.5"x5"x11.5"			
MSC-402-0512	+5V @ 20A	+12V @ 25/36Apk	—	—
MAX-503-0512	+5V @ 80A	+12V @ 10/16Apk	-12V @ 10.0A	—
MAX-504-1252	+5V @ 80A	+12V @ 10/16Apk	-5.2V @ 10.0A	12V @ 2.0A
MAX-504-1205	+5V @ 80A	+12V @ 10/16Apk	-12V @ 10.0A	5.2V @ 2.0A
MAX-504-1212	+5V @ 80A	+12V @ 10/16Apk	-12V @ 10.0A	12V @ 2.0A
MAX-504-1224	+5V @ 80A	+12V @ 10/16Apk	-12V @ 10.0A	+24V @ 2.0A
MAX-504-1552	+5V @ 80A	+15V @ 10/16Apk	-5V @ 10.0A	15V @ 2.0A
Model	700,750 WATTS: 2.5"x5"x13.6"			
MAX-704-1205	+5V @ 100A	+12V @ 12/20Apk	-12V @ 10.0A	5.2V @ 2.0A
MAX-704-1212	+5V @ 100A	+12V @ 12/20Apk	-12V @ 10.0A	12V @ 2.0A
MAX-753-0512	+5V @ 120A	+12V @ 12/20Apk	-12V @ 10.0A	—
MSC-753-0512	+5V @ 120A	+12V @ 20/27Apk	-12V @ 6.0A	—
MAX-754-1252	+5V @ 120A	+12V @ 12/20Apk	-5.2V @ 10.0A	12V @ 2.0A
MAX-754-1205	+5V @ 120A	+12V @ 12/20Apk	-12V @ 10.0A	5.2V @ 2.0A
MAX-754-1212	+5V @ 120A	+12V @ 12/20Apk	-12V @ 10.0A	12V @ 2.0A
MAX-754-1224	+5V @ 120A	+12V @ 12/20Apk	-12V @ 10.0A	+24V @ 2.0A

\*Size for system air-cooled versions.

**Call 1-800-223-TODD**  
(516-231-3366 on Long Island)  
for your FREE  
32-page full-color catalog  
of over 100 TODD  
Standard Switching  
Power Supplies.  
Can't wait?  
For instant facts,  
use our FAX HOTLINE:  
**516-231-3473**



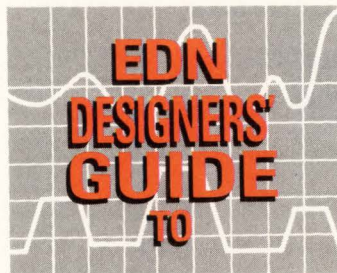

subranging ADCs  
part I

# Subranging ADCs operate at high speed with high resolution

---

*Subranging A/D converters offer performance levels difficult to obtain with successive-approximation or flash converters. They can deliver higher conversion speed and resolution and suit such applications as digital signal processing. Part 1 of this 3-part series explores the architecture and operation of these devices. Part 2 will cover subranging-ADC parameters and specifications. Part 3 will conclude the series with test and measurement principles.*

---

Ray K Ushani, *Datel Inc*

The subranging, or multipass, A/D converter has become increasingly popular in the last few years. A major reason for this popularity is digital signal processing, which demands high conversion speeds and resolution. The traditional successive-approximation converter has reached its speed-resolution limit (about 1  $\mu$ sec for 12 bits) and can't meet the demands of many applications. Although flash converters offer high speeds, a practical limit exists to the resolution they can provide because the number of comparators rises exponentially with the number of bits. A 12-bit flash converter, for example, does not exist.

A flash converter, however, is an essential part of the subranging-ADC architecture. Designers have a wider choice of flash converters than they did a few years ago, and today's devices have significantly better

performance and lower prices (approximately \$10 for an 8-bit flash converter in OEM quantities). Semicustom design has also helped spur subranging-ADC manufacturing because the devices inherently require more components than successive-approximation converters. Integrating the timing and correction logic on a single chip greatly reduces cost, the number of active components, and assembly and reliability problems.

The three types of subranging-ADC architectures are conventional, pipelined, and intermeshed; each type best suits certain applications. All subranging ADCs—whether the device is a hybrid IC or ICs and discrete components on a pc board—contain at least a sample-and-hold (S/H) circuit, a D/A converter, a scaling network, and timing and digital-correction logic.

The conventional subranging architecture (**Fig 1**) is a 2-stage A/D converter. With  $S_1$  closed and  $S_2$  open, the S/H circuit switches to the hold mode. The flash converter then quantizes the input signal,  $V_{IN}$ . After proper scaling, the D/A converter converts the digitized and latched signal back into an equivalent voltage. This voltage is subtracted from the original input signal at the summing junction, yielding the difference between the first conversion and the input signal. The closing of  $S_2$  and the opening of  $S_1$  feeds the difference signal back to the flash converter, which amplifies and digitizes the signal. After latching, the result of this conversion goes through the digital-correction logic to produce the output.



The three different types of subranging-ADC architectures are conventional, pipelined, and intermeshed.

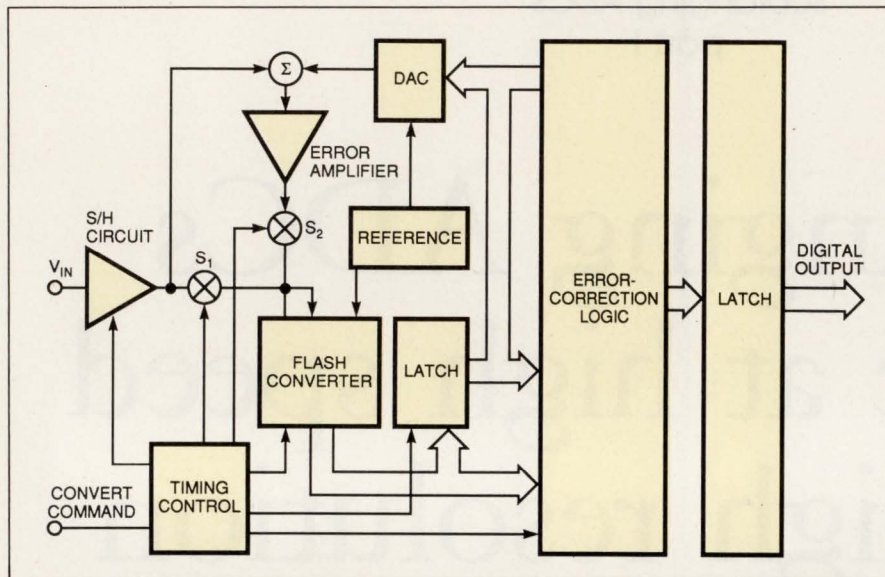

Fig 1—A conventional subranging ADC uses an S/H circuit, a flash converter, and a D/A converter.

Designing and fabricating a good high-resolution flash converter is a major task. Therefore, in monolithic subranging ADCs, using a lower-resolution (3- to 4-bit) flash converter is preferable. Of course, the lower resolution means more passes through the flash converter, making the subranging ADC seem like a successive-approximation converter with a reduced number of trials. This variation of the conventional architecture, which combines flash and successive-approximation features, is the recursive subranging architecture.

The second type of subranging converter has a pipelined architecture. Compared with the other subrang-

ing-ADC types, the pipelined architecture offers a faster throughput rate because the circuit can initiate a new conversion before the previous conversion is finished. However, the conversion time is not significantly improved, and the digital output data corresponding to the present conversion is always delayed by at least one clock.

The 2-stage pipelined converter has an extra S/H circuit and an extra flash converter (Fig 2). In operation, the first S/H circuit switches to the hold mode after acquiring the input signal,  $V_{IN}$ . The first flash converter then quantizes the input signal, while the

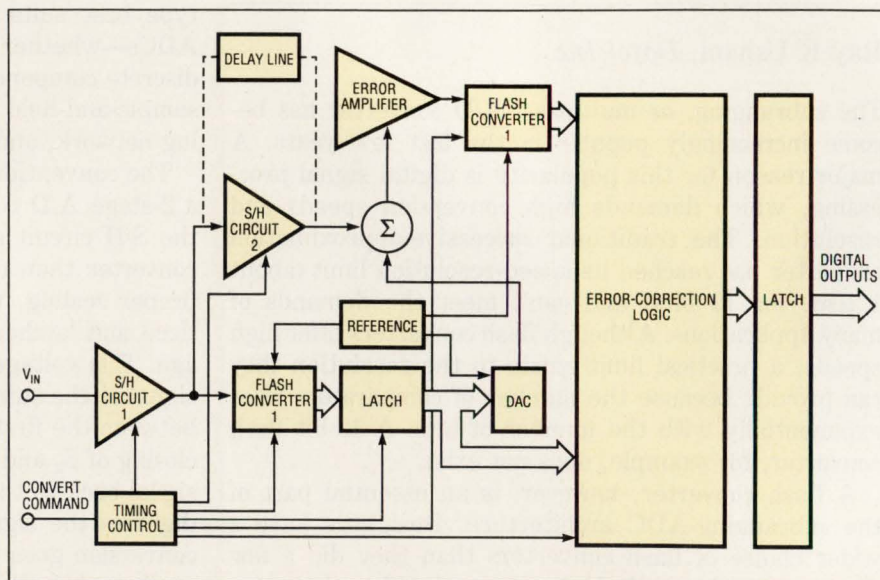

Fig 2—A pipelined subranging ADC uses two S/H circuits, two flash converters, and a D/A converter.



second S/H circuit goes to the hold mode. The D/A converter latches and converts the digitized signal into an equivalent voltage. This voltage is then subtracted from the held output voltage of the second S/H circuit, which represents the input voltage at the time the first flash converter made its conversion. The second flash converter amplifies and digitizes the difference between the first conversion and the input voltage. After latching, the result of this conversion goes through the digital correction logic to produce the output.

Immediately after the second S/H circuit switches to the hold mode, the input S/H circuit can acquire a new signal, effectively increasing the throughput rate (the rate at which the converter can accept new convert commands). Another advantage of pipelining is that you can time the outputs of the S/H circuit and the A/D converter to change simultaneously. Thus, the

outputs don't overdrive the error amplifier, resulting in only a very short transient switching glitch.

In place of the S/H circuit, you could also use a delay line. For the optimum throughput rate, the delay should not exceed the conversion time of the first flash converter plus the settling time of the D/A converter. The delay line itself must be of high fidelity and have a large bandwidth.

The third type of subranging converter uses an intermeshed architecture. **Fig 3** shows a block diagram of this type of converter, which operates as follows: After the S/H circuit acquires the signal, the MSB flash converter decides the range of the input. This input lies between two resistors in the ladder and determines the most significant bits. These two points on the resistor ladder then switch to the reference top and reference bottom of the second flash converter (the higher

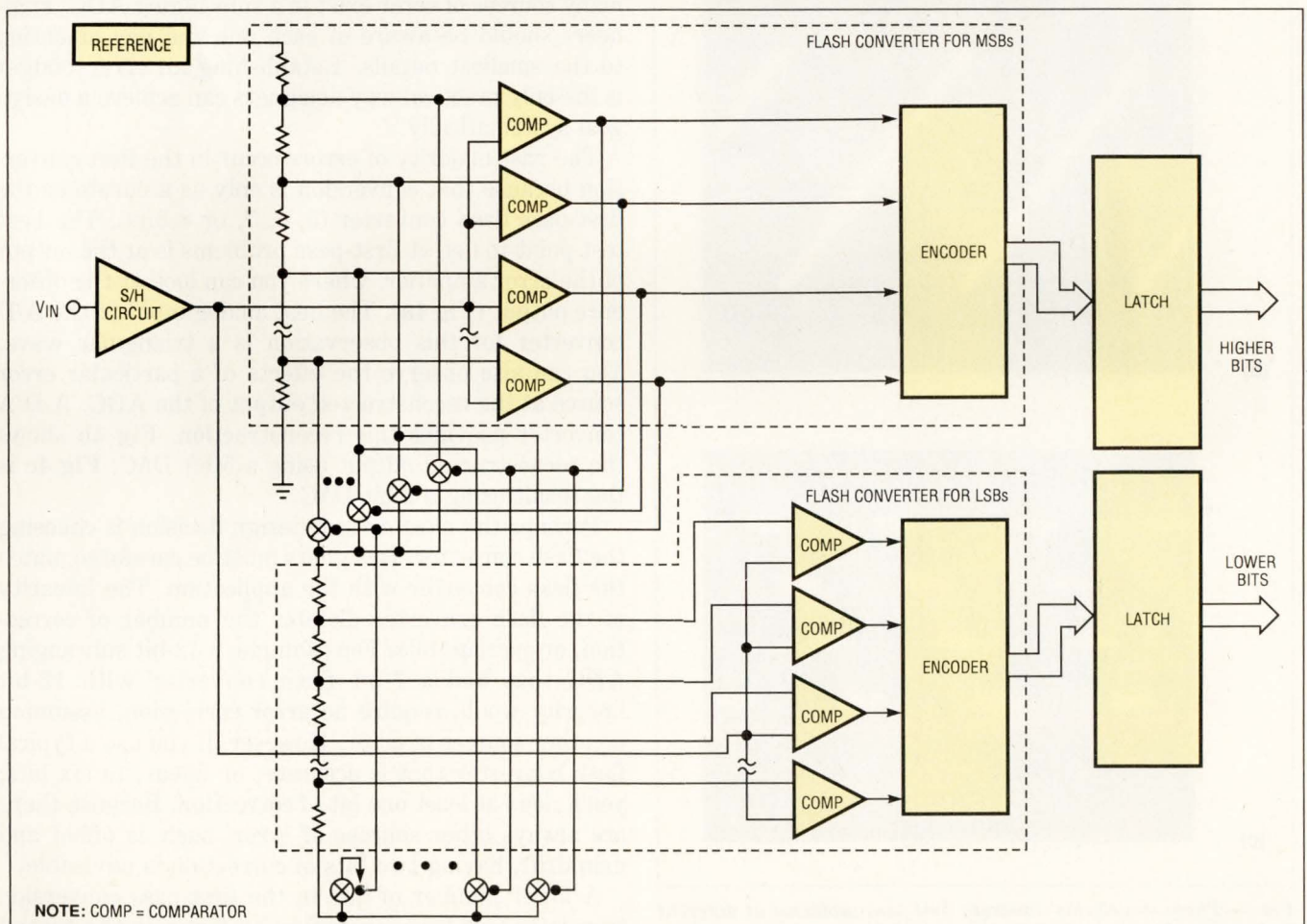

**Fig 3—An intermeshed subranging ADC uses separate flash converters for the MSBs and LSBs. Note the absence of the D/A converter, the error amplifier, and the correction logic.**



Perhaps the most critical design decision is choosing the flash converter.

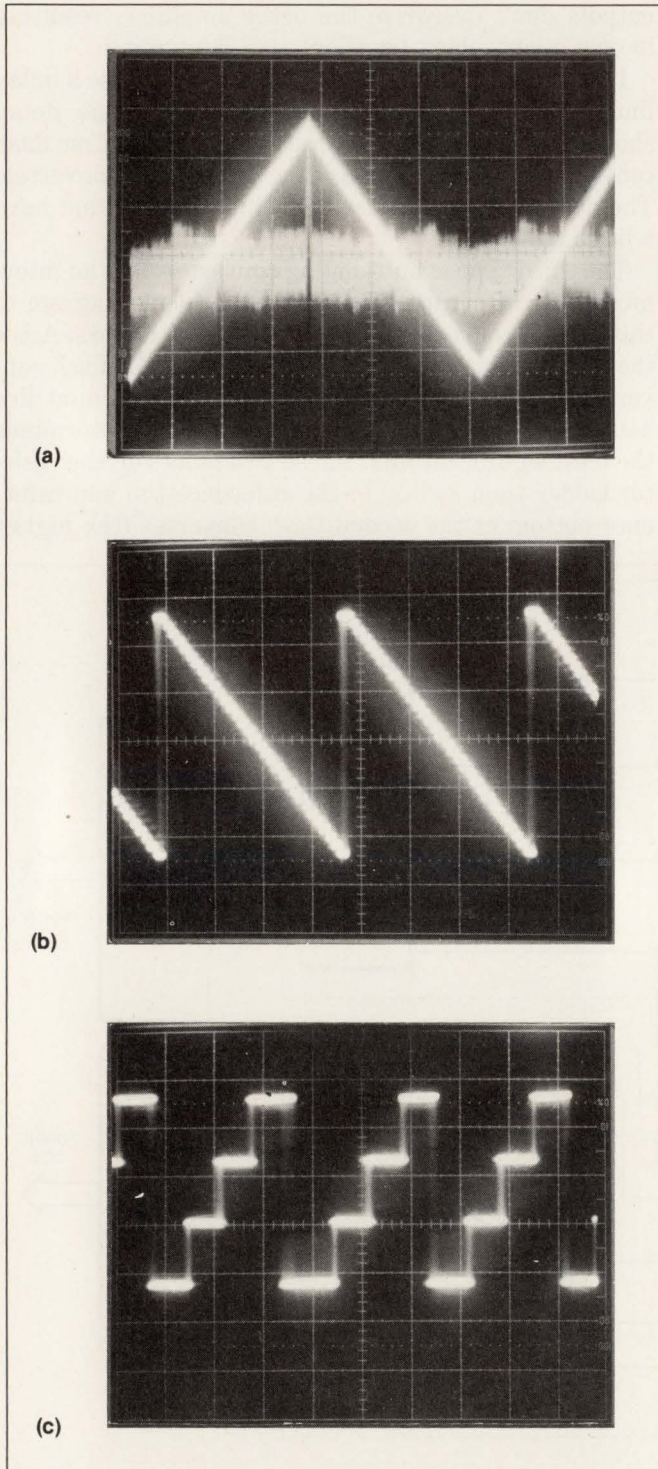

**Fig 4—**These waveforms illustrate first-pass problems at different test points. Photo a shows the output of the error amplifier with a triangle-wave input. Photos b and c show the reconstructed output of the ADC using a 5-bit DAC (b) and a 2-bit DAC (c).

voltage on the ladder will be the reference top and the lower voltage will be the reference bottom). Upon a convert command, the LSB flash converter digitizes the original input to produce the least significant bits.

Because this architecture has no correction logic, the MSB flash converter must be as linear as the intended linearity of the overall A/D converter. Note the absence of the D/A converter, the error amplifier, and the correction logic in the block diagram. This relative simplicity, plus the fact that the circuitry is repetitive, suits the intermeshed architecture for monolithic applications.

To the uninitiated, the block diagram of a subranging A/D converter can appear to be deceptively simple, consisting merely of a few building blocks. On the contrary, subranging A/D converters are the most challenging ADCs to design and manufacture. Because many sources of error exist in a subranging ADC, engineers should be aware of each one and pay attention to the smallest details. Establishing an error budget is the only practical way designers can achieve a design goal systematically.

The vast majority of errors occur in the first conversion because that conversion is only as accurate as the first-pass flash converter (5, 6, 7, or 8 bits). The best test point to detect first-pass problems is at the output of the error amplifier, where you can look at the difference output (Fig 4a). The best analog input to the A/D converter for this observation is a triangular wave. You can also observe the effects of a particular error source at the reconstructed output of the ADC. A D/A converter provides this reconstruction. Fig 4b shows the reconstructed output using a 5-bit DAC; Fig 4c is the result using a 2-bit DAC.

Perhaps the most critical design decision is choosing the flash converter. Designers must be careful to match the flash converter with the application. The linearity of the flash converter dictates the number of correction, or overlap, bits. For example, a 12-bit subranging ADC that had a 7-bit flash converter with 12-bit linearity would require no error correction, assuming no other sources of error. However, if you use a typical flash converter that is accurate, or linear, to six bits, you'll need at least one bit of correction. Because there are always other sources of error, such as offset and gain drift, having two bits of correction is advisable.

A lower number of bits in the first-pass conversion translates to a lower amplification factor in the second pass. As a result, the amplifier settles faster, and you can get by with a lower-resolution D/A converter,



which is easier to design. However, this lower-resolution DAC mandates a higher-resolution flash converter in the second pass, which is more expensive than a lower-resolution converter.

CMOS flash converters are attractive because of their low power consumption. Converters that operate from a single supply have especially low power consumption. However, because most CMOS flash converters use a design scheme in which the comparators switch back and forth between the reference ladder and the input depending on the clock level (Fig 5), large glitches that are synchronized to the convert command appear at the converters' inputs. As a result, CMOS converters distort the input signal, making the devices hard to drive. To overcome this problem, use a high-speed, wide-bandwidth buffer with low output impedance.

CMOS flash converters cause large spikes on the power lines, which not only degrade the performance of the converter, but also create problems for the overall system. Heavily bypassing the reference voltages and power lines right at the flash converter helps lessen, or prevent, spikes. Also, avoid external HCMOS logic when the ADC's sampling rate is greater than 5 MHz. Because of its high-speed switching, HCMOS logic also creates large spikes on the power lines.

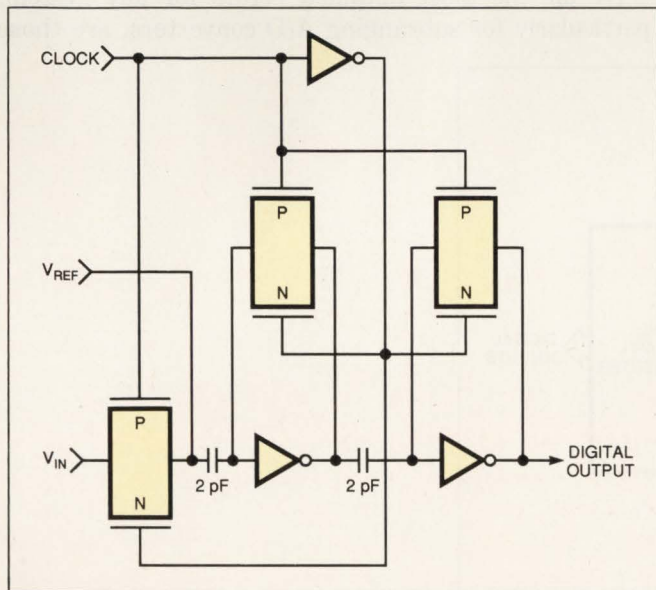

**Fig 5**—Most CMOS flash converters use a design scheme in which the comparators switch back and forth between the reference ladder and the input. This switching can cause undesirable glitches synchronized to the convert command.

Compared with CMOS types, bipolar flash converters, have fewer problems. However, most bipolar flash ADCs require dual supplies (often +5 and -5.2V) and usually consume more power than CMOS converters.

In a subranging A/D converter, the bit resolution of the D/A converter does not need to be more than the resolution of the flash converter used in the first-pass conversion. However, the DAC's differential and integral linearity must be considerably better than the desired differential and integral linearity of the A/D converter. The integral nonlinearity of the DAC not only causes integral nonlinearities but creates non-monotonicity and differential nonlinearities every time the input of the DAC changes. This effect is called overlap; Fig 6 illustrates overlap at the ADC's reconstructed output. The DAC should have an accuracy

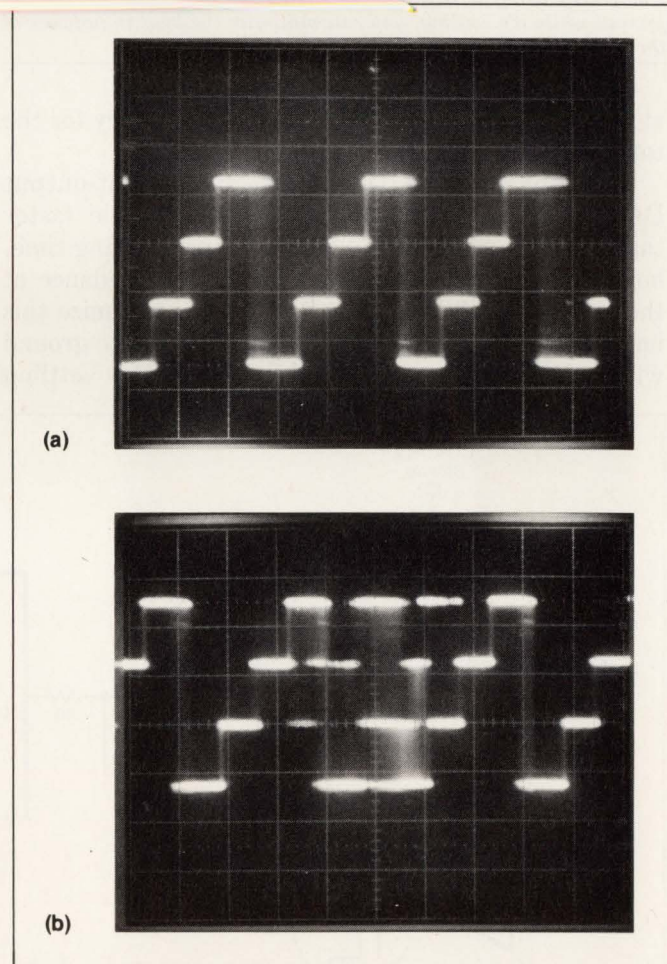

**Fig 6**—These scope photos compare the reconstructed output of the D/A converter in the typical case (a) and when the DAC has integral error (b). This error is called overlap.



*The resolution of the DAC in a subranging A/D converter does not need to be greater than that of the first-pass flash converter.*

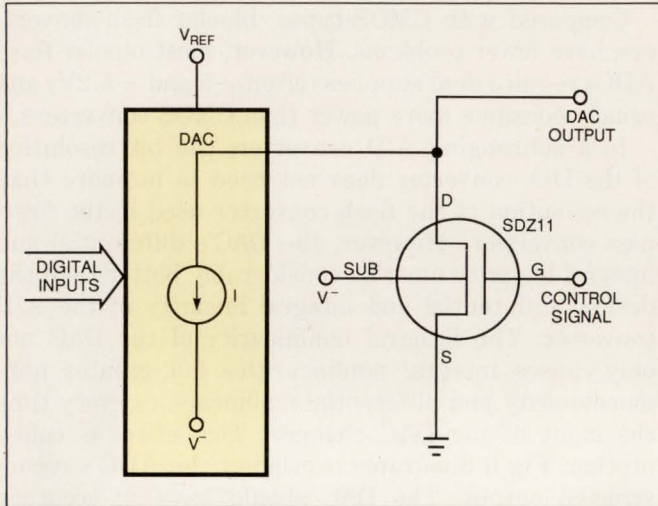

**Fig 7**—By using a MOSFET to switch the output of the DAC to ground while it's settling, you can minimize the load impedance at the output of the DAC and optimize its settling time.

at least 1-bit greater than the desired accuracy for the total converter.

For subranging A/D converters, current-output DACs are a good choice because they settle faster than voltage-output DACs. For optimum settling time, however, you should minimize the load impedance at the output of the DAC. The best way to minimize this impedance is to switch the output of the DAC to ground with a MOSFET transistor while the DAC is settling

(Fig 7). Most current-output DACs have application resistors you can use to set the best gain and gain-drift performance. If the DAC does not have such resistors you must design them into the same resistor network that sets the reference current of the DAC.

### The error amplifier

The error amplifier scales the difference between the first-conversion output and the input signal. The characteristics of the first-pass flash converter determine the gain of this amplifier. This amplifier does not have to settle to better than the accuracy of the second flash converter; therefore, most commercially available monolithic high-speed op amps will do. However, because the amplifier's closed-loop gain requirements are normally high, the device is subject to saturation while the error signal is settling. To eliminate this problem, make sure the error signal settles before it switches to the amplifier, as Fig 8 shows.

Another problem to watch for is overvoltage-recovery time. If the input of the A/D converter exceeds the analog input range even slightly, an undesirable overvoltage recovery time will occur. Usually the input capacitance of the flash converter increases the amplifier's overshoot and, as a result, increases the settling time. In this case, a small-value resistor in series with the output of the amplifier can help.

By far the most untamed errors for any system, particularly for subranging A/D converters, are those

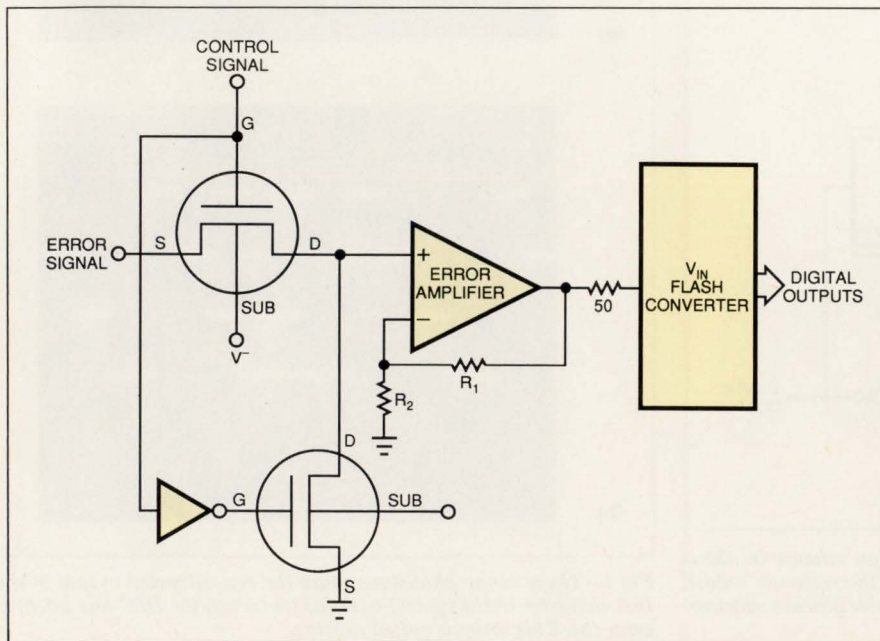

**Fig 8**—Switching the input of the error amplifier to ground while the error is settling can prevent the amplifier from saturating.



# Integrating data modems with Group 3 fax capability takes a world of experience.

The fast-growing worldwide base of 15 million fax machines is an audience you can't ignore. And nearly 75% use Rockwell International modems. So you know who you can count on for true compatibility in a whole family of integrated datafax solutions—at remarkably reasonable prices. Rockwell technology and worldwide support from software vendors make your project easier to design and faster to market.

Rockwell's TrueFAX™ modem family offers a clear migration path for present and future applications. Including the RC224ATF—a low-power, fully integrated single device with Group 3 fax send/receive capabilities based on industry-standard ANSI/EIA-578 Service Class 1 AT commands.

For open-architecture solutions, choose from Rockwell's RC9624DP datapump or RC9624AC integrated device-set families. All support major international protocols for data and send/receive fax. The RC9624AC family also offers a fully featured datafax AT command set, plus V.42/V.42 bis.

Low power consumption, low cost and small size.

They're all yours with the versatile Rockwell family of datafax modems. For details, contact Rockwell Communication Systems at P.O. Box C, M.C. 501-300, Newport Beach, CA 92658-8902; (800) 854-8099; in California: (800) 422-4230; Fax—(714) 833-4078 or (714) 833-4391.

## RC224ATF

- CCITT V.22 bis, V.22, Bell 212A and 103 operating modes
- EIA TR30.2.2/88 AT commands
- Group 3 send and receive fax modes
- ANSI/EIA 578 Service Class 1 fax commands
- Single voltage (+5 volts)
- 2-device version available
- AccelerATor™ Kit

## RC9624DP/RC9623DP

- CCITT V.22 bis, V.22, V.21, V.23, Bell 212A and 103 modes
- V.29, V.27ter, V.21 Channel 2, Group 3 send/receive fax capabilities
- Voice interface
- DTMF generation/detection
- HDLC framing
- Single voltage (+5 volts)



**Rockwell  
International**

...where science gets down to business

CIRCLE NO. 173

**TrueFAX™**



---

*The characteristics of the flash converter determine the gain of the error amplifier. Most monolithic high-speed op amps are suitable.*

---

that improper grounding introduces. Designers often think that their breadboard is functioning properly, but when they change the setup or the timing (repetition rate, duty cycle, or the fall and rise times of the convert command), major errors occur because of ground loops or poor grounding. In some cases, the breadboard stops functioning. Fig 9 shows the transients on the ground of a subranging ADC with poor grounding. You can see the effects of this poor grounding by looking at the error-amplifier output and the ADC's reconstructed output.

Because the number of overlap bits limits the digital correction, poor grounding could cause an error in the first pass that exceeds the digital-correction limit. This first-pass error can cause the remainder to go out of the correction window (Fig 10).

You can solve most grounding problems by separating the analog and digital grounds and connecting them only to heavy ground planes underneath or close to the flash converter. Making ground runs as wide as possible and decoupling the power supplies will also help. Note that CMOS logic and CMOS flash converters tend to magnify any grounding problems because of the large transients they cause whenever they switch. In such cases, you need to take additional care.

A major factor in the proper functioning of a subranging A/D converter is the error-correction logic, which is the Boolean algebra performed on the outputs of the first- and second-pass conversions to produce the ADC's output. This logic corrects for any first-pass

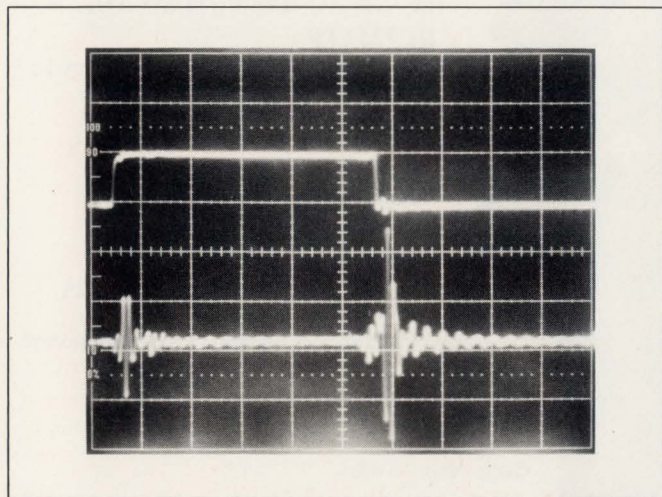

**Fig 9**—This photo shows the transients on the ground of a subranging ADC that has poor grounding. The upper trace shows the signal; the bottom trace shows the analog ground with respect to the same ground at a different physical location.

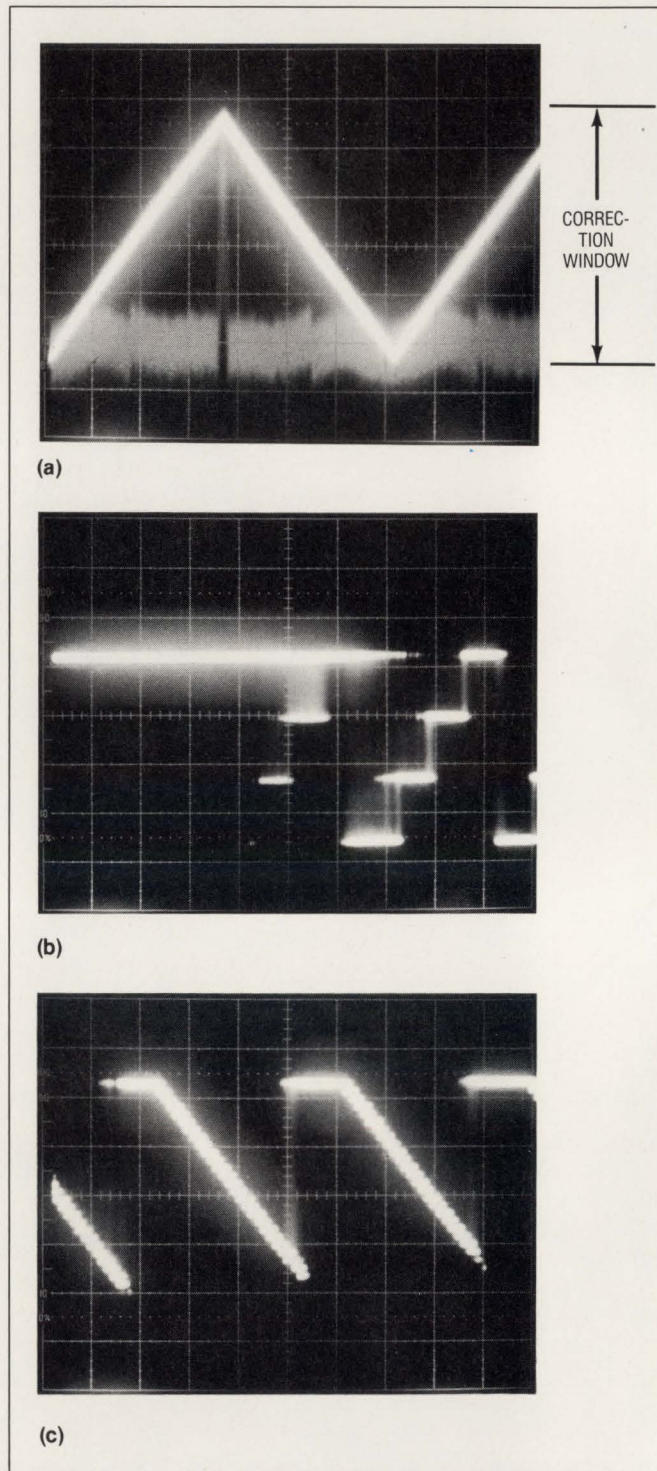

**Fig 10**—In this ADC, a slight change in the start-convert pulse width caused the remainder to go out of the correction window (a). Traces b and c show the resultant missing codes at the reconstructed output for a 2-bit DAC and a 5-bit DAC, respectively.



# Take a look at what the DS345 Synthesized Function Generator offers for only \$1895.

30 MHz direct digitally synthesized source

1  $\mu$ Hz resolution

12 bit, 40 Msample/sec arbitrary waveform generation

Low phase noise and distortion

Fast phase continuous frequency and phase switching

Sine, square, ramp, and triangle waveforms

Frequency, amplitude, and phase modulation

Sweep and burst modes

Available GPIB and RS232 interfaces

## Now take a look at your function generator.



The DS345 from SRS.

At \$1895, it's the only function generator you need.



**STANFORD RESEARCH SYSTEMS**

1290 D Reamwood Avenue, Sunnyvale, CA 94089 TEL (408)744-9040 FAX 4087449049 TLX 706891 SRS UD

EDN April 11, 1991

CIRCLE NO. 177

147



You can solve most grounding problems by separating the analog and digital grounds and connecting them to heavy ground planes underneath or close to the flash converter.

errors that create remainders that stay within the correction window (Fig 11).

Generally, the device's biasing offsets the input negatively in the first-pass conversion to ensure that the error, or remainder, is positive. A positive remainder simplifies the correction logic to an addition, which means the outputs of the first and second conversion are added to get the final output of the ADC. The way these outputs are added depends on the number of correction bits, or overlaps. For example, in the case of a 7-bit flash converter with 1 bit of correction, the ADC's output is

First-pass data: D1 D2 D3 D4 D5 D6 D7 → overlap bit  
 Second-pass data: + D1 D2 D3 D4 D5 D6 D7  
 The ADC output: B1 B2 B3 B4 B5 B6 B7 B8 B9 B10 B11 B12 B13.

D7 in the first pass and D1 in the second pass must have the same weights to be added. If you use a 7-bit flash converter with 2 bits of correction, the ADC's output is

First-pass data: D1 D2 D3 D4 D5 D6 D7 → overlap bits  
 Second-pass data: + D1 D2 D3 D4 D5 D6 D7  
 The ADC output: B1 B2 B3 B4 B5 B6 B7 B8 B9 B10 B11 B12.

In this case, D6 and D7 in the first pass must have the same respective weight as D1 and D2 in the second pass. To make sure the overlap bits have the same weight, the gain of the error amplifier must be  $K = G \times 2^{N-M}$ , where G is the first-pass gain, N is the resolution of the first-pass flash converter, and M is the number of correction bits. In the first example,  $K = G \times 2^{7-1} =$

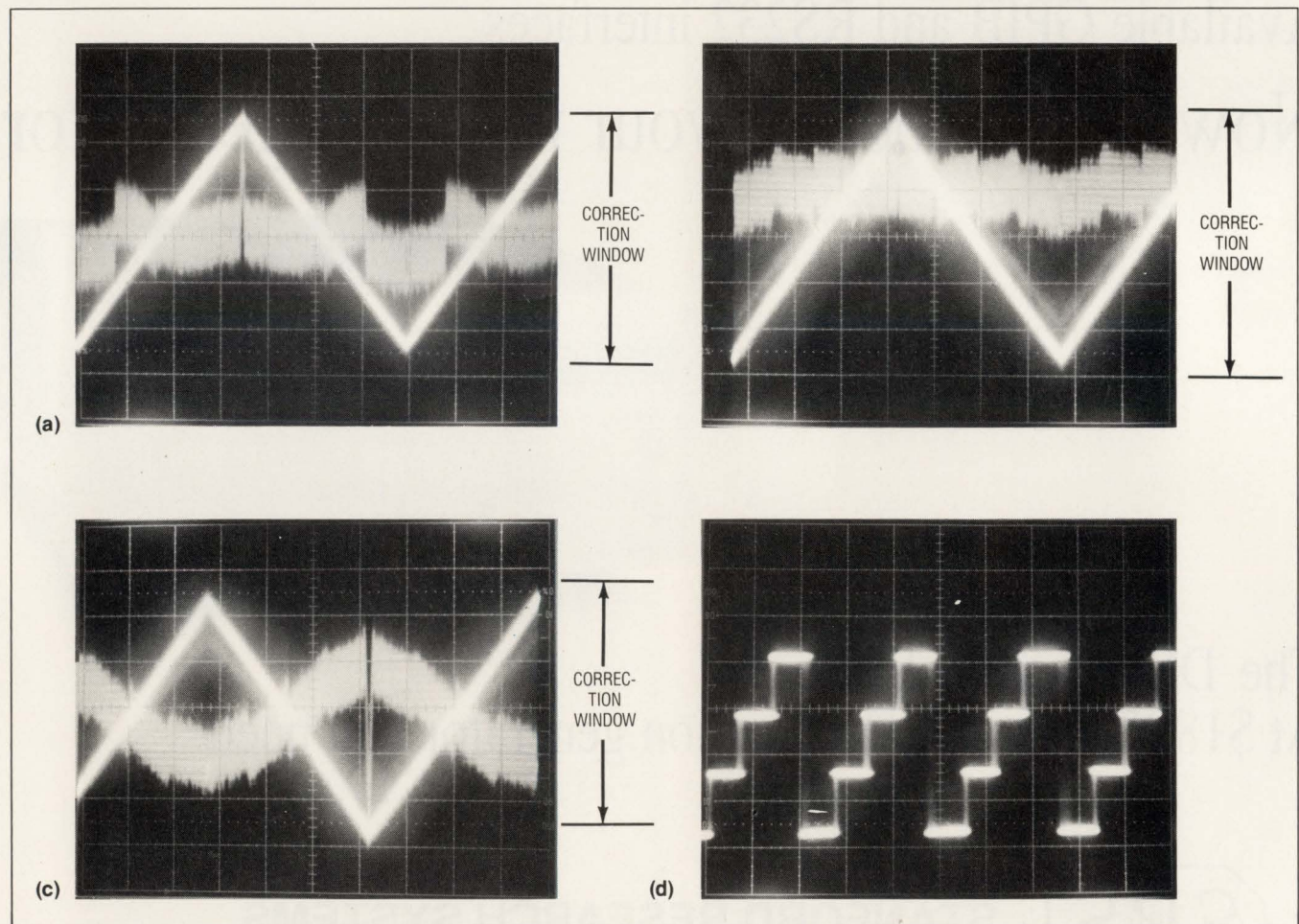

Fig 11—Correction logic in a subranging ADC corrects for first-pass errors that stay within the correction window. Photos a, b, and c show the effects of first-pass nonlinearity, offset, and gain errors, respectively. Photo d shows that these errors have no effect on the reconstructed output.



**NEW  
Release 3.0**



## **MAXI/PC PUTS A FRIENDLY FACE ON PCB CAD**

Unlike some people, you'll be smiling when you see how easy to use new MAXI/PC is. A new, proactive user interface saves you *hundreds* of key-strokes in a typical design because it anticipates your next move and logically defaults to the most likely action. MAXI/PC's OSF/Motif™ style interface has clear, logical menus integrated across all functions. It's easy to learn and much easier and more productive to use than the competition.

### **Nice To Your Budget**

MAXI/PC gives you an incredible amount of design power for the money. Rich with features, it's capable of handling

multi-layer, double-sided, surface mount boards. You get schematic capture, layout, automatic routing, and manufacturing outputs. All backed by a 30 day, no questions, money back guarantee. All for \$995.

Powerful capabilities include:

- 5,000+ part library
- Hierarchical design
- Automatic placement
- Automatic gate and pin swap
- Automatic routing
- Automatic component rename
- Automatic part/component replacement
- Back annotation
- Hotline support

**From A Good Family**  
Racal-Redac is the only EDA vendor to offer a smooth growth path, with data migration from MAXI/PC, to the more powerful PC-based CADSTAR, to high end, workstation-based VISULA EDA. Make yourself smile, get MAXI/PC.

**Call today to order MAXI/PC!**

**1-800-447-7332**

**MAXI/PC**

PCB CAD SOFTWARE

**RACAL-REDAC**

238 Littleton Road, P.O. Box 365  
Westford, MA 01886-9984, USA  
Fax: (508) 692-4725

**RACAL**

OrCad, PADS, and Tango are trademarks of their respective companies.

CIRCLE NO. 171

See us at Electro Booth #2233-2236





*Subranging ADCs use correction logic to guard against first-pass errors.*

$G \times 64$ . In the second example,  $K = G \times 2^{7-2} = G \times 32$ .

Note that the LSBs of the flash converter in the second pass are the LSBs of the output. As a result, the differential nonlinearity of the output is the flash converter's differential nonlinearity. The only time this statement is not true is if you do not adjust  $K$  to the right value. In this case, whenever the LSB of the first pass changes from 1 to 0 or 0 to 1, discontinuities, or noisy codes, will appear in the output of the A/D converter.

One common problem with the addition logic is that when the full-scale output carries, the output of the A/D converter rolls over, thereby generating an erroneous code. For example,

To avoid this problem, use a simple OR gate that

If the first-pass data is	1 1 1 1 1 1 1
and the second-pass data is	0 1 0 0 0 0 0,
then the output will be	0 0 0 0 0 0 0 0 0 0 0 0 with a carry.
The correct output is	1 1 1 1 1 1 1 1 1 1 1 1.

ORs the carry with each output bit. This action forces the output to stay at all 1s for any input exceeding full scale. **Fig 12** shows an error-correcting circuit for a 12-bit, 2-pass converter with two bits of correction.

**The S/H circuit**

Another key element in the performance of any high-speed A/D converter is the S/H circuit. Because of the usually low input impedance in a subranging A/D converter, the designer must pay close attention to designing or selecting the S/H circuit. This essential element consists of an input buffer, a switch, a hold capacitor, and an output buffer that drives the A/D converter. When an S/H circuit is used in front of a subranging ADC, the circuit's dynamic output impedance and aperture uncertainty are of prime importance.

The dynamic output impedance of the S/H circuit, which is a function of the bandwidth of the output buffer, determines how fast the device responds to the

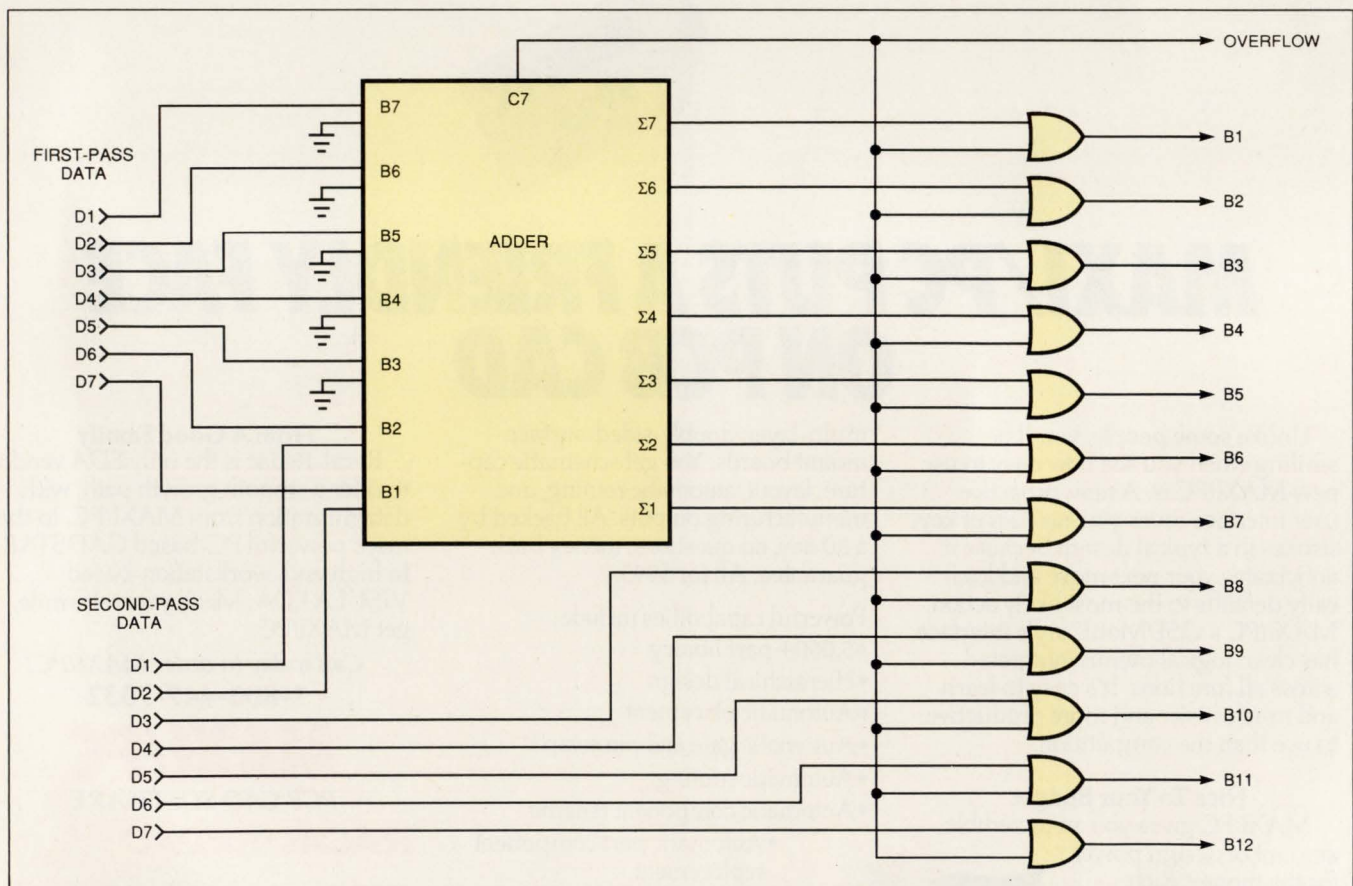

**Fig 12**—This diagram shows the error-correction logic for a 12-bit, 2-pass converter with two bits of correction.



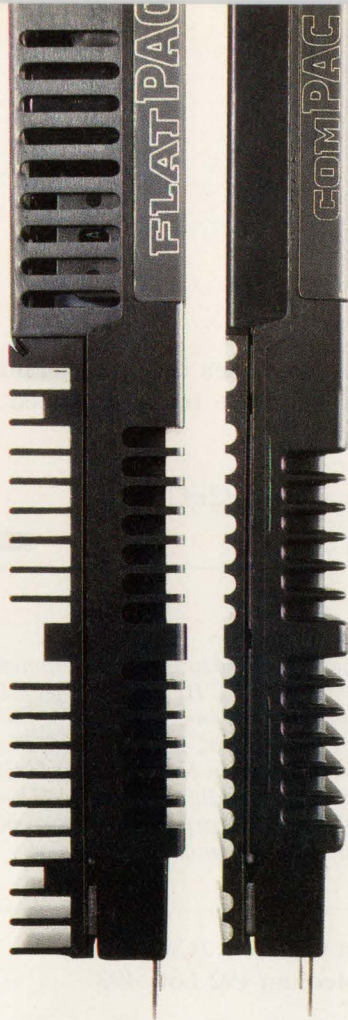

# Up To 600 Watts Per Inch

Our expanding family of compact, configurable, power systems combine the flexibility of a custom supply with the availability of standard catalog products . . . in low profile, compact packages that let you pack the most power into the least amount of space. And they meet the specialized input voltage, noise and transient requirements of major worldwide markets. Think of them as a universal solution for most of your system power requirements . . . AC or DC input . . . in computer, telecom or vehicular applications . . . up to 600 Watts. FlatPAC™ is the industry benchmark for power density in off-line applications. And now, CompPAC™ sets the standard for DC input supplies . . . in a package less than one inch tall! Both offer unprecedented flexibility in configuration along with instant availability . . . in a fraction of the space required by conventional switchers. Just define your requirements . . . we utilize our high frequency, high power-density converters to quickly configure a FlatPAC or CompPAC specific to your needs.

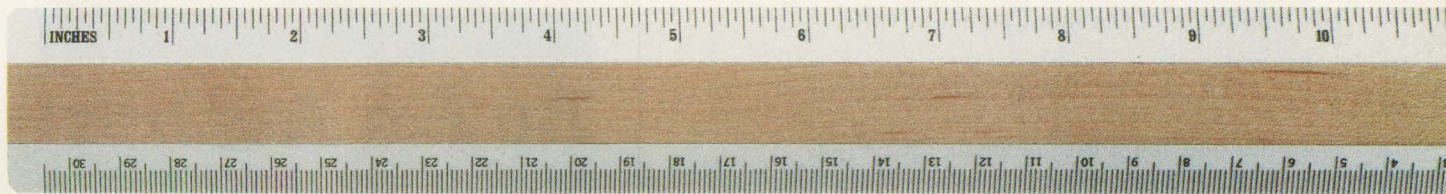

You benefit from the proven field performance, high efficiency and inherently high reliability of our component-level power converters, without sacrificing any of the features you need: off-line inputs for worldwide application; nominal DC inputs from 24 to 300 VDC; surge limiting; safety agency recognition; EMI/RFI to FCC/VDE, British Telecom, Bellcore or MIL-STD-461; totally isolated and trimmable outputs; AC OK and DC OK status signals . . . and more.

You don't have to choose between costly and risky custom development or bulky catalog supplies. Call us to discuss FlatPAC and CompPAC . . . the new standards that make customs obsolete.

Does your power supply measure up?  
Call **VICOR EXPRESS** for a free ruler  
at **1-800-735-6200** or **508-470-2900** at ext. 265

FlatPAC™ AC Input		CompPAC™ DC Input
110/220 VAC	<b>Voltage Inputs</b>	24, 28, 48, 270, 300 VDC
1, 2, or 3	<b>Number of Outputs</b>	1, 2, or 3
2 to 95 VDC	<b>Output Voltages</b>	2 to 95 VDC
Up to 600 Watts	<b>Output Power</b>	Up to 600 Watts
1.37"	<b>Height</b>	1"
FCC Part 15, Class A VDE 0871, Class A IEEE Std 587-1980	<b>Applicable Specifications</b>	Bellcore (24/48 V) British Telecom (24/48 V) FCC/VDE, Class A (300 V) MIL-STD-461 C (28/270 V) MIL-STD-704A



Component Solutions For Your Power System  
23 Frontage Road, Andover, MA 01810

Common Stock Traded on NASDAQ under "VICR"



---

*Subranging ADCs are the most challenging ADCs to design and manufacture.*

---

dynamic load it drives. Because of subranging ADCs' low input impedance and the switching that takes place on the input, the devices require a S/H circuit with a low dynamic output impedance to attain an optimal conversion time.

For precision A/D converters, try to avoid open-loop S/H circuits. The gain of open-loop S/H circuits changes drastically with input frequency and amplitude, and most noticeably with the output load. Any of these factors can cause large static and dynamic errors.

Another error source is the aperture uncertainty, which is the uncertainty period associated with the closing of a switch. Many factors contribute to this error source. The most common are timing jitter caused by random noise, 60-Hz line frequency or other frequencies modulating the power lines, and the uncertainty of the sample command. The ADC's output takes on the spectral characteristics of the error source. The aperture uncertainty also limits the input frequency that the circuit can sample within the specified error budget. The relationship between aperture uncertainty ( $T_A$ ) and the input frequency is as follows, where A is the amplitude of the input signal in volts:

$$\text{If } V_{IN} = A \cdot \sin(\omega t) = A \cdot \sin(2\pi f t),$$

then the maximum rate of change for  $V_{IN}$  is

$$\left. \frac{dV_{IN}}{dt} = \frac{dA \sin(2\pi f t)}{dt} \right|_{t=0} = 2A\pi f \cos(2\pi f t) \Big|_{t=0}$$

$$\left( \frac{dV_{IN}}{dt} \right)_{MAX} = 2A\pi f.$$

Aperture-uncertainty noise generally follows a Gaussian distribution similar to white noise, which means that the rms aperture uncertainty corresponds to the distribution's  $\sigma$  value. The distribution's  $2\sigma$  point thus becomes the proper choice for the maximum value. The maximum aperture uncertainty equals  $2T_A$ . To determine the maximum full-scale sine-wave frequency ( $f_{MAX}$ ) that produces  $1/2$ -LSB error, first calculate the error arising from  $2T_A$ :

$$2T_A \text{ error} = 2(T_A)_{MAX} (dV_{IN}/dt) = 2T_A A 2\pi f_{MAX}.$$

Thus,

$$f_{MAX} = 1/T_A \pi 2^{n+2}.$$

The error resulting from the aperture uncertainty

is primarily random, which makes the noise additive. The general expression for the noise produced by Gaussian time jitter is

$$\text{S/N ratio} = -20 \log(2\pi f T_A).$$

**EDN**

---

### Author's biography

*Ray Ushani is the manager of the Advanced Development Group at Datel Inc (Mansfield, MA). He has been with the company for six years and has been instrumental in the development of several A/D converters, multiplexers, and S/H circuits. Ray has an MSEE from Northeastern University (Boston, MA) and is a PhD candidate at Tufts University (Medford, MA). Not one to stray far from his vocation, Ray's hobbies include RF and microwave design.*

---

Article Interest Quotient (Circle One)  
High 491 Medium 492 Low 493

## Be An Author!

When you write for EDN, you earn professional recognition. And you earn \$75 per published magazine page.

EDN publishes how-to design application information that is read by more than 137,300 electronics engineers and engineering managers worldwide. That's an audience that could belong to you.

If you have an appropriate article idea, send your proposal and outline to: EDN, 275 Washington Street, Newton, MA 02158-1630.

For a FREE EDN Writer's Guide—which includes tips on how to write for EDN and other technical publications—please circle number 800 on the Information Retrieval Service Card.

## EDN

**First in Readership among Design Engineers and Engineering Managers in Electronics.**



# THE LARGEST FAMILY OF 1MEG SRAMS.



## AND MORE ON THE WAY.

Sony's family of 1-Meg SRAMs gets larger and larger all the time.

Our newest additions will include an industrial-grade temperature range, synchronous ASM (Application Specific Memory), and a low, 3-volt power requirement.

We've also adopted all of the industry's most popular package styles, making our family more compatible with all of your PCB designs.

And with the full support of two production facilities — plus another one due soon in San Antonio, TX — we'll be producing more 1-Meg

Sony 1 Megabit SRAM Family Tree

Model	Speed (ns)	Packaging	Data Retention	Current	Special Features	Availability
128Kx8 — CXK581000P	100/120/150	DIP 600mil	L/LL		B/X	Now
— CXK581000M	100/120/150	SOP 525mil	L/LL		B/X	Now
— CXK581000TM	100/120/150	TSOP	L/LL		B/X	Now
— CXK581000YM	100/120/150	TSOP (reverse)	L/LL		B/X	Now
— CXK581001P	70/85	DIP 600mil	L/LL			Now
— CXK581001M	70/85	SOP 525mil	L/LL			Now
— CXK581020SP	35/45/55	SDIP 400mil				Now
— CXK581020J	35/45/55	SOJ 400mil				Now
128Kx9 — CXK77910J	20	SOJ 400mil			Sync ASM	2H '91
256Kx4 — CXK541000J	25/30/35	SOJ 400mil				2H '91

L = Low LL = Low, Low B = 3 Volt X = Extended Temperature

SRAMs than ever.

If you still can't find the right high-density SRAM, we've got your answer — a full team of designers in the USA, armed with 0.8-micron CMOS

technology. And they're ready now to discuss your needs.

So, for the strength and security of the largest 1-Meg SRAM family, look to Sony. You'll find us at Sony Corporation of America, Component Products Company, 10833 Valley View St.,

Cypress, CA 90630. For details, call us at (714) 229-4190, FAX us at (714) 229-4285, or write to us "Attn: Communications."

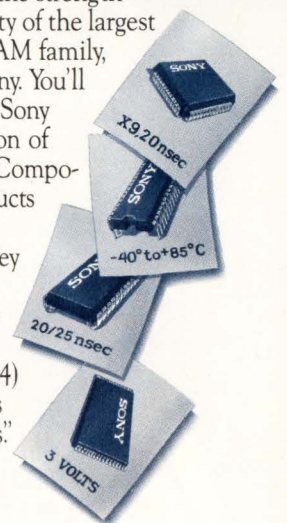

# SONY

Sony is a registered trademark of Sony Corporation.



# Emulation power without compromise



*EZ-Pro™ 1.5 price performance leader for 8-bit in-circuit emulation.*

**Power in selection**—System support for more processors than any other manufacturer in the world. Power in product range to match your needs—from economical basic configurations to fully featured systems.

**Power in performance**—Completely integrated capabilities include options such as versatile trace, performance analysis, EPROM programming, C source level debugging, over 100 personality modules with a common universal platform for different processors, C cross compilers, cross assemblers and more.

**Power without compromise**—All invented here. Supported here. And available to rent or purchase now.



*EZ-Pro 2.1 industry workhorse for 16-bit and 8-bit designs.*

## Free Demo Disk!

See how easily you can use these sophisticated development tools. Our marketing department will ship your demo disk today. Please Call:

# (714) 731-1661

 **american automation**

**Headquarters:** 2651 Dow Avenue, Tustin, California 92680-7207  
Telephone (714) 731-1661. **European Headquarters:** UK Oxford 993 778991. **Distributors:** Australia 3-5601011, Belgium 2-4681400, France 1-69308050, India 418387, Indonesia 22-71880, Italy 2-50722282, Korea 2-7849942, Spain 1-7291155, Switzerland 1-4354111, Taiwan 2-7368150, West Germany 89-6127087.





# DESIGN NOTES

## Current Feedback Amplifier "Do's and Don'ts" - 46

William H. Gross

### Introduction

The introduction of current feedback amplifiers, such as the LT1223, has significantly increased the designer's ability to solve difficult high speed amplifier problems. The current feedback architecture has very high slew rate and the small signal bandwidth is fairly constant for all gains. Current feedback amplifiers are used in broadcast video systems, radar systems, IF and RF stages, RGB distribution systems and many other high speed circuits.

As with any new circuit, there are several new rules that must be kept in mind to prevent problems. Because current feedback amplifiers act very much the same as regular op amps, it is important to note the differences and show how some standard op amp circuits should be implemented.

The most important thing to remember about current feedback amplifiers is that the impedance at the inverting (negative) input sets the bandwidth and therefore the stability of the amplifier. It should be resistive, not capacitive. To slow the amplifier down, increase the resistance driving the inverting input. If the amplifier peaks too much due to capacitive loading, or anything else, increase the value of the feedback resistors.

The best way to demonstrate how to use current feedback amplifiers is to show some example circuits. To make it as painless as possible, I will show the traditional op amp implementation next to the current feedback amplifier version.

### Op Amp Adjustable Gain Amp

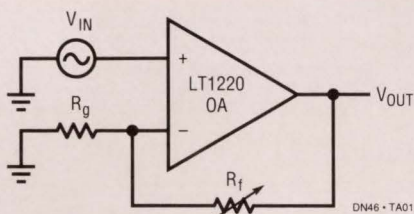

### Current Feedback Amp Adjustable Gain Amp

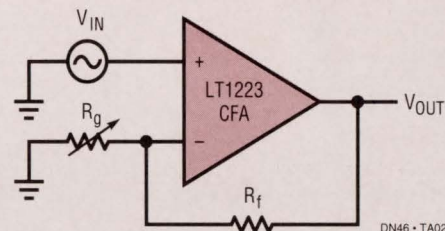

With a standard op amp you can vary the gain of the amplifier with either  $R_f$  or  $R_g$ . The only real restriction on the values is the loading affect the resistors have on the amplifier output. With a current feedback amplifier the value of  $R_f$  should not be varied. If  $R_f$  is a pot, then the bandwidth will be reduced at minimum gain and the circuit will oscillate when  $R_f$  is very small.

### Op Amp Bandwidth Limiting

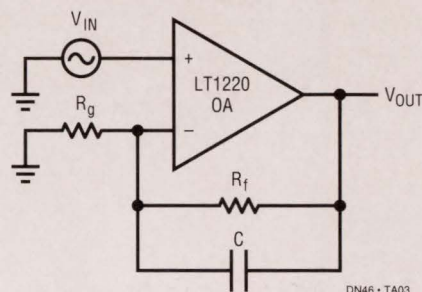

### Current Feedback Amp Bandwidth Limiting

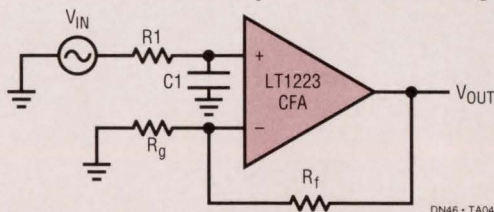

It is very common to limit the bandwidth of an op amp by putting a small capacitor in parallel with  $R_f$ . This works with all unity gain stable op amps; DO NOT PUT A SMALL CAPACITOR FROM THE INVERTING INPUT OF A CURRENT FEEDBACK AMPLIFIER TO ANYWHERE, ESPECIALLY NOT TO THE OUTPUT. The capacitor on



the inverting input will cause peaking or oscillations. If you need to limit the bandwidth of a current feedback amplifier, use a resistor and capacitor at the non-inverting input ( $R_1$  and  $C_1$ ). This technique will also cancel (to a degree) the peaking caused by stray capacitance at the inverting input. Unfortunately, this will not limit the output noise the way it does for the op amp.

### Op Amp Integrator

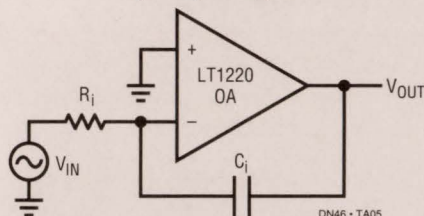

### Current Feedback Amplifier Integrator

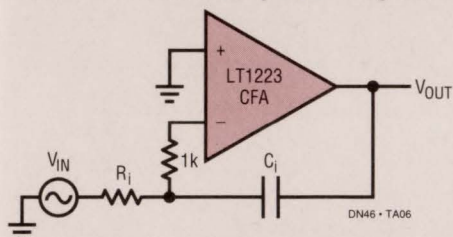

The integrator is one of the easiest circuits to make with an op amp. However, the circuit must be modified before a current feedback amplifier can be used. Since we remember that the inverting input wants to see a resistor, we can add one to the standard circuit. This generates a new summing node where we can apply capacitive feedback. The new current feedback amplifier compatible integrator works just like you would expect; it has excellent large signal capability and accurate phase shift at high frequencies.

### Current Feedback Amplifier Summer (DC Accurate)

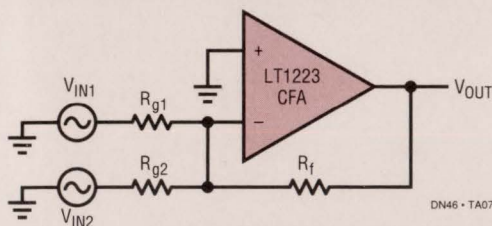

There is no  $I_{OS}$  spec on current feedback amplifiers because there is no correlation between the two input bias currents. Therefore we will not improve the DC accuracy of the inverting amplifier by putting an extra resistor in the non-inverting input. This is also true of input bias current canceled op amps where the  $I_{OS}$  spec is the same as the  $I_B$  spec, such as the LT1220.

### Two Amplifier Instrumentation Amp

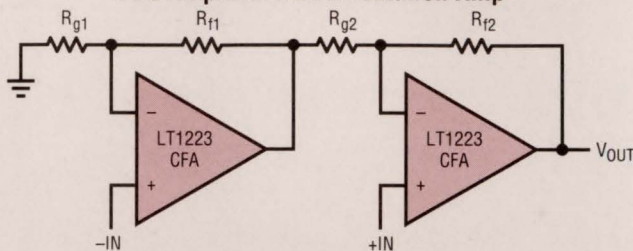

TRIM  $R_{g2}$  FOR GAIN, THEN TRIM  $R_{g1}$  FOR CMRR. VOLTAGE GAIN,  $G$ , IS  $V_{OUT}$  DIVIDED BY DIFFERENCE BETWEEN +IN AND -IN.

OP AMP DESIGN EQUATIONS:

$$R_{f1} = R_{g2}; R_{f2} = (G-1) R_{g2}; R_{g1} = R_{f2}$$

CURRENT FEEDBACK AMP DESIGN EQUATIONS:

$$R_{f1} = R_{f2}; R_{g1} = (G-1) R_{f2}; R_{g2} = \frac{R_{f2}}{G-1}$$

DN46 • TA08

The two amplifier instrumentation amp is easily modified for current feedback amplifiers. The only necessary change is to make the feedback resistor of each amplifier the same and therefore make the gain setting resistors different. This way the bandwidth of both amps is the same and the common mode rejection at high frequencies is better than that of the op amp circuit. In the op amp circuit one amplifier has maximum bandwidth, since it runs at about unity gain, while the other is limited to its gain bandwidth product divided by the gain.

### Cable Driver

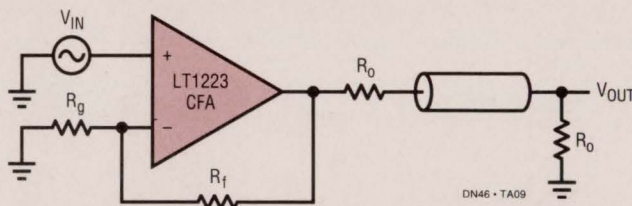

The cable driver circuit is the same for both types of amplifiers. But because most op amps do not have enough output drive current, they are not often used for heavy loads like cables. When driving a cable it is important to properly terminate both ends if even modest high frequency performance is required. The additional advantage of this is that it isolates the capacitive load of the cable from the amplifier so it can operate at maximum bandwidth.

For literature on our Current Feedback Amplifiers, call (800) 637-5545. For applications help, call (408) 432-1900, Ext. 456

Linear Technology Corporation

1630 McCarthy Blvd., Milpitas, CA 95035-7487

(408) 432-1900 • FAX: (408) 434-0507 • TELEX: 499-3977

BA/GP 0491 180K

**LINEAR**  
TECHNOLOGY

© LINEAR TECHNOLOGY CORPORATION 1991



# DESIGN IDEAS

EDITED BY CHARLES H SMALL AND ANNE WATSON SWAGER

## 8051 converts 16-bit integer to BCD

Jeremy Ottenstein  
*Allied Signal Aerospace Corp, Teterboro, NJ*

For an 8051  $\mu$ P, converting a 16-bit binary integer to decimal form is considerably more complicated than converting an 8-bit integer. The most straightforward method uses a 16-bit-divide routine. **Listing 1's** alternative method takes advantage of the 8051's BCD commands. Using the BCD commands results in simple and clean code.

The **listing** is for the Boston Systems Office (Waltham, MA) 8051 macro assembler. Its macro defini-

tions differ somewhat from Intel's. The **listing** uses (r0, r1) and (r2, r3, r4) for the input and output, respectively; but you can use any five 8051 registers or any five internal-direct memory locations. You can obtain the **listing** from the EDN BBS. Phone (617) 558-4241 with modern settings 300/1200/2400, 8, N, 1. From the main menu, enter (sig, <sig>, rk946).  
(EDN BBS /DI\_SIG #946)

**EDN**

To Vote For This Design, Circle No. 746

### Listing 1—8051 Radix-conversion routine

```
title  cnvbcd

; Listing controls
$ nocond
$ genonly

rlc16  macro  %x1, %x2
; Performs a 16-bit rotate left through the Carry flag.
  mov  a, %x2
  rlc  a
  mov  %x2, a
  mov  a, %x1
  rlc  a
  mov  %x1, a
endm

clrbcd macro  %x1, %x2, %x3
; Initializes the packed bcd digits.
  mov  %x3, #0
  mov  %x2, #0
  mov  %x1, #0
endm

incbcd macro  %x1, %x2, %x3
; Increments the packed bcd digits by 1, if the carry is set.
  mov  a, %x3
  addc a, #0
  da   a
  mov  %x3, a

  mov  a, %x2
  addc a, #0
  da   a
  mov  %x2, a

  mov  a, %x1
  addc a, #0
  da   a
  mov  %x1, a
endm

dblbcd macro  %x1, %x2, %x3
; Doubles the packed bcd digits.
  mov  a, %x3
  add  a, %x3
  da   a
  mov  %x3, a

  mov  a, %x2
```

```
  addc a, %x2
  da   a
  mov  %x2, a

  mov  a, %x1
  addc a, %x1
  da   a
  mov  %x1, a
endm

cnvbcd:
; CNVBBCD accepts a 16-bit unsigned binary integer and converts it into
; 5 packed bcd digits.
; The input is passed in (r0,r1).
; The output is returned in (r2,r3,r4).
; Note : The contents of R0 & R1 are destroyed at the end of this routine.
; * The following algorithm is used.
; * See Knuth, "The Art of Computer Programming", Vol 2, 1981
; * Section 4.4, Radix Conversion.
; * y := 0 ;
; * for i := 1 to 15 do
; *   y := y + x[16-i] ;
; *   y := y * 2 ;
; * end do ;
; * y := y + x[0] ;

  mov  r7, #15
  clrbcd r2, r3, r4

1$:  rlc16 r0, r1
     incbcd r2, r3, r4
     dblbcd r2, r3, r4
     djnz r7, 1$

     rlc16 r0, r1
     incbcd r2, r3, r4

  ret

end
```



## Pause detector adapts to signal

Tibor Szep and Andras Pomozi  
 Technical University of Budapest,  
 Budapest, Hungary

You can increase the throughput of a LAN's data transmission if you transmit only during the talk-spurt period. If your detector is sensitive enough, even the pause among the words can be utilized for data transmission. The circuit in Fig 1 distinguishes between the signal and pause states in a speech signal coming from the microphone of a telephone handset. The circuit is adaptive because the threshold level of the comparator depends on the long-time average of the speech signal's power. The detector can also accommodate background noise. Even in cases of massive continuous background noise, the detector can distinguish the signal state from the nonsignal state.

Fig 1 consists of four major parts: a 2-way precision rectifier, an integrator with two time constants, a long-time integrator, and a comparator. The rectifier produces the absolute value of the incoming speech signal.

$R_1$  controls the gain. The rectifier's output drives the integrator. The integrator's rise is determined by  $\tau_1$  which is approximately equal to  $R_2 \times C_1$ .  $\tau_2$  which is approximately equal to  $R_3 \times C_1$  determines the fall time.  $R_5$  and  $R_6$  eliminate the op amp's offset. Two time constants are necessary because the requirements for defining the beginning and the end of a speech period are different. The circuit must be able to detect quickly the beginning of a speech period; determining the end of an active period isn't as critical. Also, making the fall time somewhat longer than necessary avoids biting off the end of a word.

The long-time integrator's time constant ( $\tau_3$ ) equals  $R_4 \times C_2$ . A potentiometer controls the threshold level of the comparator. Speech quality depends on the values of all three time constants. (EDN BBS/DL\_SIG #937)

**EDN**

To Vote For This Design, Circle No. 747

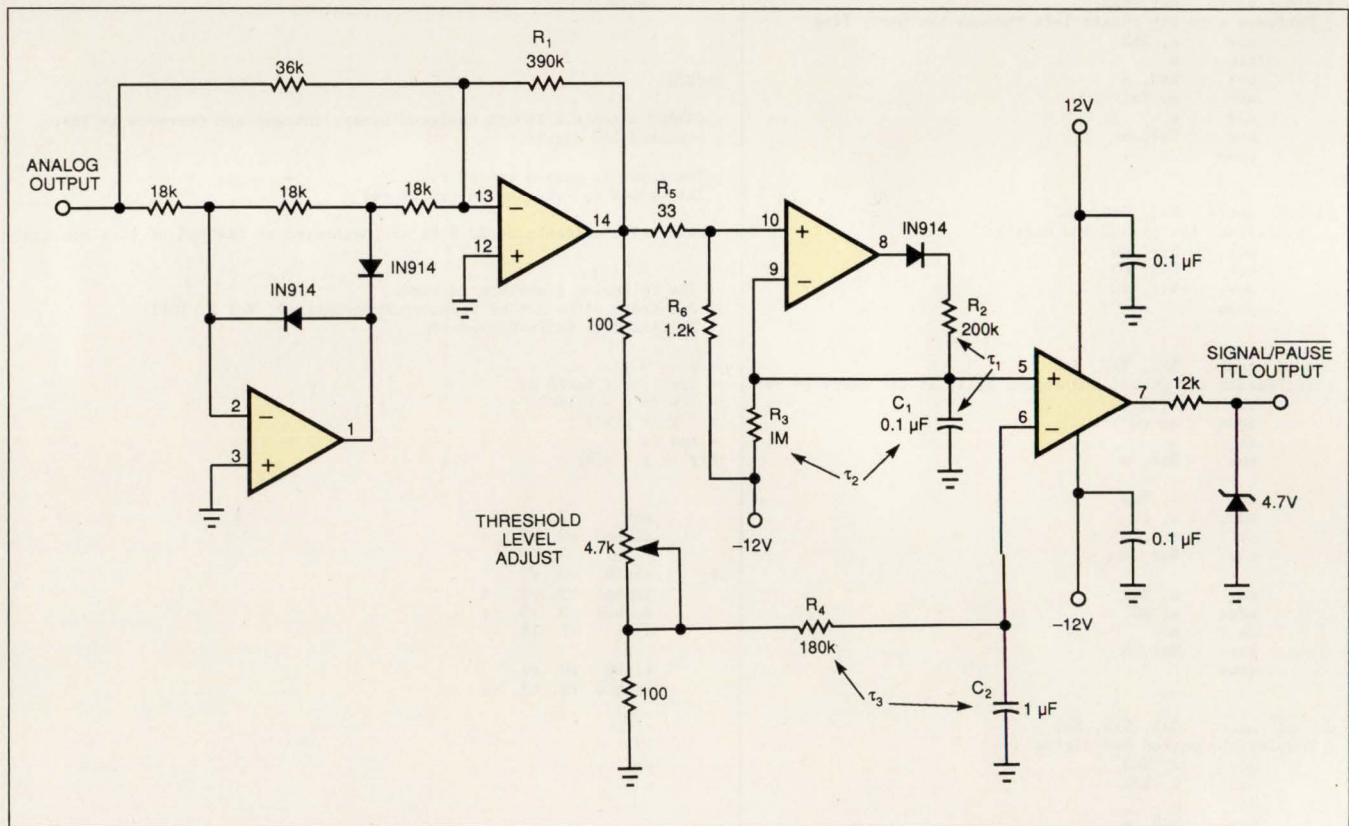
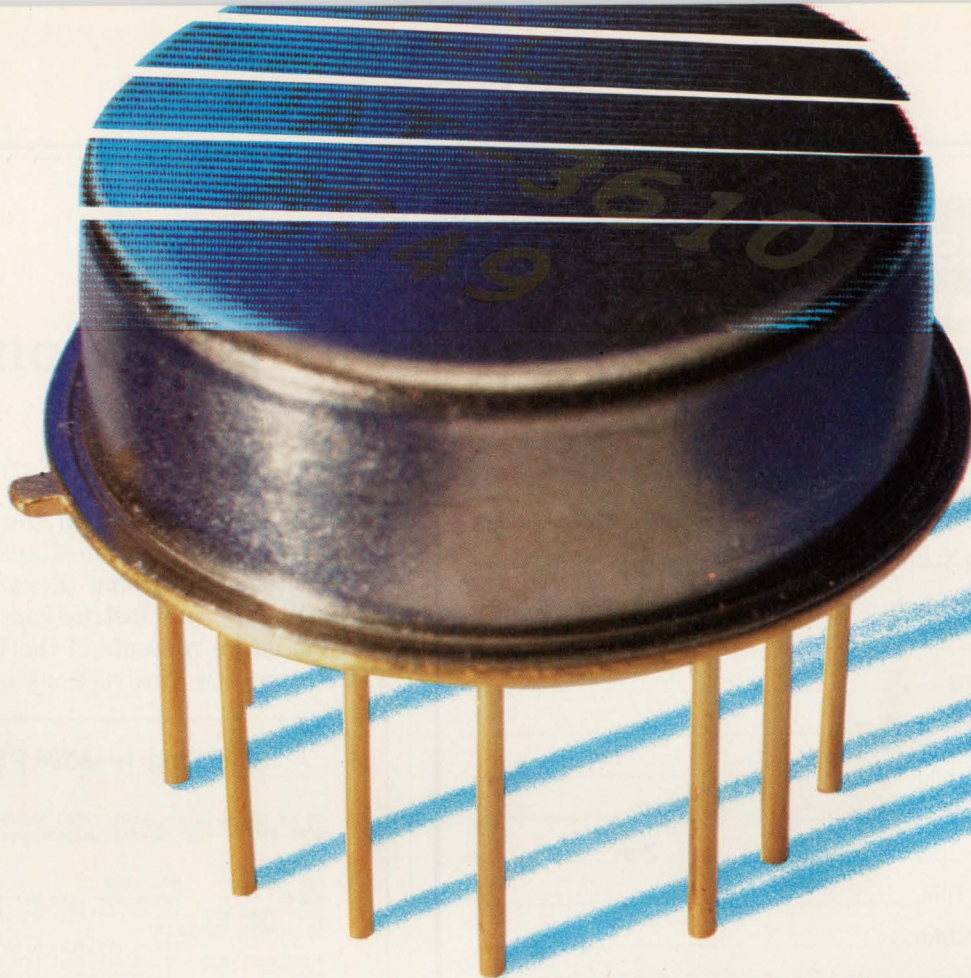

Fig 1—Three independently adjustable time constants,  $\tau_1$ ,  $\tau_2$ , and  $\tau_3$ , allow this pause detector to define the beginning and end of a speech period and allow it to adapt to speech signal levels.





# PRECISION TTL-CONTROLLED ATTENUATORS

up to 35dB  
10 to 1000MHz  
only **\$5995**

TOAT-R512 Accuracy (dB) (+/-dB)		TOAT-124 Accuracy (dB) (+/-dB)		TOAT-3610 Accuracy (dB) (+/-dB)		TOAT-51020 Accuracy (dB) (+/-dB)	
<b>0.5</b>	<b>0.12</b>	<b>1.0</b>	<b>0.2</b>	<b>3.0</b>	<b>0.3</b>	<b>5.0</b>	<b>0.3</b>
<b>1.0</b>	<b>0.2</b>	<b>2.0</b>	<b>0.2</b>	<b>6.0</b>	<b>0.3</b>	<b>10.0</b>	<b>0.3</b>
1.5	0.32	3.0	0.4	9.0	0.6	15.0	0.6
<b>2.0</b>	<b>0.2</b>	<b>4.0</b>	<b>0.3</b>	<b>10.0</b>	<b>0.3</b>	<b>20.0</b>	<b>0.4</b>
2.5	0.32	5.0	0.5	13.0	0.6	25.0	0.7
3.0	0.4	6.0	0.5	16.0	0.6	30.0	0.7
3.5	0.52	7.0	0.7	19.0	0.9	35.0	1.0

bold faced values are individual elements in the units

Now...precision TTL-controlled attenuators accurate over 10 to 1000MHz and -55 to +100°C. Four models are available in the new TOAT-series, each with 3 discrete attenuators switchable to provide 7 discrete and accurate attenuation levels (see chart). Cascade all four models for up to 64.5dB control in 0.5dB steps. Custom values available on request. The 50-ohm TOAT-series performs with 6µsec switching speed and can handle power levels up to 0dBm. Units are housed in a rugged hermetically-sealed TO-8 package to withstand the shock, vibration, and temperature stresses of MIL-STD-883. Connector versions are available. Take advantage of the \$59.95 (1-9 qty) price breakthrough to stimulate new applications as you implement present designs and plan future systems.



finding new ways ...  
setting higher standards

## Mini-Circuits

WE ACCEPT AMERICAN EXPRESS

CIRCLE NO. 164

P.O. Box 350166, Brooklyn, New York 11235-0003 (718) 934-4500 Fax (718) 332-4661 Domestic and International Telexes: 6852844 or 620156

F 140 REV. ORIG.



## Design Entry Blank

**\$100 Cash Award** for all entries selected by editors. An additional **\$100 Cash Award** for the winning design of each issue, determined by vote of readers. Additional **\$1500 Cash Award** for annual Grand Prize Design, selected among biweekly winners by vote of editors.

To: Design Ideas Editor, EDN Magazine  
Cahners Publishing Co  
275 Washington St., Newton, MA 02158

I hereby submit my Design Ideas entry.

Name \_\_\_\_\_

Title \_\_\_\_\_ Phone \_\_\_\_\_

Company \_\_\_\_\_

Division (if any) \_\_\_\_\_

Street \_\_\_\_\_

City \_\_\_\_\_ State \_\_\_\_\_

Country \_\_\_\_\_ Zip \_\_\_\_\_

Design Title \_\_\_\_\_

Home Address \_\_\_\_\_

Social Security Number \_\_\_\_\_  
(Must accompany all Design Ideas submitted by US authors)

**Entry blank must accompany all entries.** Design entered must be submitted exclusively to EDN, must not be patented, and must have no patent pending. Design must be original with author(s), must not have been previously published (limited-distribution house organs excepted), and must have been constructed and tested. Please submit software listings and all other computer-readable documentation on a 5¼-in. IBM PC disk.

Exclusive publishing rights remain with Cahners Publishing Co unless entry is returned to author or editor gives written permission for publication elsewhere.

In submitting my entry, I agree to abide by the rules of the Design Ideas Program.

Signed \_\_\_\_\_

Date \_\_\_\_\_

### ISSUE WINNER

The winning Design Idea for the January 21, 1991 issue is entitled "Digital recorder speeds sampling rate," submitted by Lin Jun of Changchun University of Earth Sciences (Changchun, Jilin, Peoples Republic of China).

**Your vote determines this issue's winner.** All designs published win \$100 cash. All issue winners receive an additional \$100 and become eligible for the annual \$1500 Grand Prize. **Vote now**, by circling the appropriate number on the reader inquiry card.

## Macro fixes 8096 shortcoming

John N Liddy  
*Simplex Time Recorder, Gardner, MA*

An obvious shortcoming of the 8096  $\mu$ P is that you cannot save the program-status word (PSW) on the stack without disturbing the working copy stored in the PSW. The only instructions available that can access the entire contents of the PSW are PUSHF and POPF; these two instructions push and pop the con-

### Listing 1—8096 PSW macro

```

;
; SP is the word register (18H) which contains the stack address
; WORD_REG is any general purpose word register (20H - 0FFH)
;
PUSH PSW MACRO WORD_REG
    PUSHF ;push psw onto stack (clears working psw)
    PUSH WORD_REG ;save contents of word register on stack
    LD WORD_REG,2[SP]
    PUSH WORD_REG ;load register with original PSW contents
    POPF ;push original PSW contents onto stack again
    POPF ;restore original PSW contents
    POP WORD_REG ;restore word register from stack

```

tents of the PSW. However, the PUSHF instruction not only pushes the contents of the PSW onto the stack, it also clears the entire PSW. Clearing the PSW causes several undesirable events, including disabling interrupts and clearing all the flags. This idiosyncrasy can be quite annoying when all you want is to save the contents of the carry flag for future use.

The macro in Listing 1 will save the PSW on the stack without altering the PSW's working value. If you use this macro in a time-critical, interrupt-driven application, be aware that for 93 clock cycles, this macro will disable interrupts. For a 12-MHz clock, interrupts will be off for 7.75  $\mu$ sec. You could lower this interval by not saving the general-purpose-word register, thereby lowering interrupt latency to 5.75  $\mu$ sec. (EDN BBS /DL\_SIG #949) **EDN**

To Vote For This Design, Circle No. 749

### EDN's bulletin board is on line

Call EDN's free bulletin-board system (BBS) at (617) 558-4241 (1200/2400,8,N,1) and select /DL\_SIG to get additional information or to comment on these Design Ideas.



**BOURNS**

# THE PERFECT CHOICE FOR ALL YOUR TRIMMER NEEDS

# TRIMMER NEEDS

## 1/4-Inch Square Sealed Single-Turn

The ideal trimmer for almost any application, the 1/4-inch square Model 3362 features a value-engineered design that's compatible with automatic assembly and adjustment equipment. Its cermet resistance element and multiwire wiper ensure excellent performance with a low 1% CRV. Resistance range is 20 ohms to 2 megohms. Great performance. Low price. Best value.

## 3/8-Inch Square Sealed Single-Turn

The Model 3386 is the industry's most popular single-turn trimmer. Select from 12 different terminal styles in top or side adjust configurations. It's sealed to withstand wave soldering and available in tape-and-reel packaging. Options include a knob for finger adjust and high voltage and opamp offset styles. Resistance range is 10 ohms to 2 megohms, with a 1% CRV.

## 1/4-Inch Square Multiturn

As the industry's smallest multiturn through-hole trimmer, the Model 3266 features a double chevron shaft seal and standoffs that allow PC board washing. Choose from either industrial or military qualified styles. Standard resistance range is 10 ohms to 1 megohm, with a 3% CRV.

## 1/4-Inch Round Sealed Single-Turn

Available as either an industrial or military qualified device, the Model 3329 trimmer uses less space than equivalent square packages. Top or side adjust styles are available in either tape-and-reel or tube packaging. Resistance range is 10 ohms to 1 megohm, with a 1% CRV.

## 3/8-Inch Square Multiturn

With a thin body profile of only 0.190 inch, the Model 3296 trimmer is ideal for a wide range of applications where precise adjustment is important. Available in tape-and-reel packaging, the Model 3296 comes in five pin styles and either top or side adjust styles. Standard resistance range is 10 ohms to 5 megohms, with a 3% CRV.

## 5/16-Inch Round Sealed Four-Turn

The Model 3339 features a unique planetary drive offering the precise wiper setting of a multiturn device in a single-turn package. Choose from top or side adjust styles. Resistance range for this cermet trimmer is 10 ohms to 1 megohm, with a contact resistance variation of 3% and a temperature coefficient of  $\pm 100\text{ppm}/^\circ\text{C}$ .

## 3/4-Inch Rectangular Multiturn

With a low printed circuit board profile of only 1/4-inch high, the Model 3006 is ideal for panel mount applications where board space is a concern. A transparent housing also can be specified for visual setting without hook-up and instrumentation. Resistance range for this cermet trimmer is 10 ohms to 5 megohms, with a 1% contact resistance variation and  $\pm 100\text{ppm}/^\circ\text{C}$  temperature coefficient.



Bourns, Inc., 1200 Columbia Avenue, Riverside, California 92507-2114; (714) 781-5500; European Headquarters: Zugerstrasse 74, 6340 Baar, Switzerland; 042-333333; Benelux: 070-3874400; France: 01-40023604; Germany: 0711-22930; Ireland: 021-357001; United Kingdom: 0278-692392; Asia Pacific Headquarters: 510 Thomson Road, Unit 09-01A SLF Building, Singapore 1130; (65) 353 4118; Hong Kong: (852) 5702171; Korea: (982) 2-558-3619; Japan Headquarters: Nichibei Time 24 Building, 35 Tansu-Cho, Shinjuku-Ku, Tokyo, 162, Japan: (81) 3-260-1411

# FREE SAMPLE OFFER\* CALL BOURNS 714-781-5500

Call Bourns and tell us about your application. Quality for your free sample and data sheet from participating distributors.

ADVACOM  
ALMAC

BELL  
BRILL  
EAC

ELECTRONIC SUPPLY  
ELECTRO SONIC  
GRS ELECTRONICS  
GERBER  
HALL-MARK

HAMILTON/AVNET  
HAMMOND  
HARPER/SID  
HARRISON  
HUGHES PETERS  
ITT MULTICOMPONENTS  
MARSH  
MARSHALL

MAST  
MIDAN  
OHM  
PIONEER STANDARD  
RS ELECTRONICS  
RESCO  
ROME  
SUMMIT  
TTI

\*Limited offer. Restrictions apply.  
COPYRIGHT © 1991, BOURNS, INC. 3/91



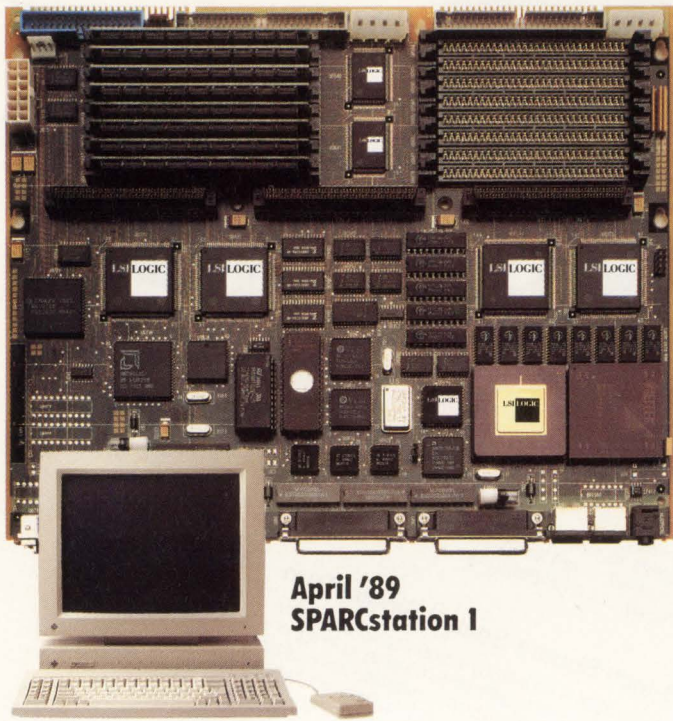

**April '89  
SPARCstation 1**

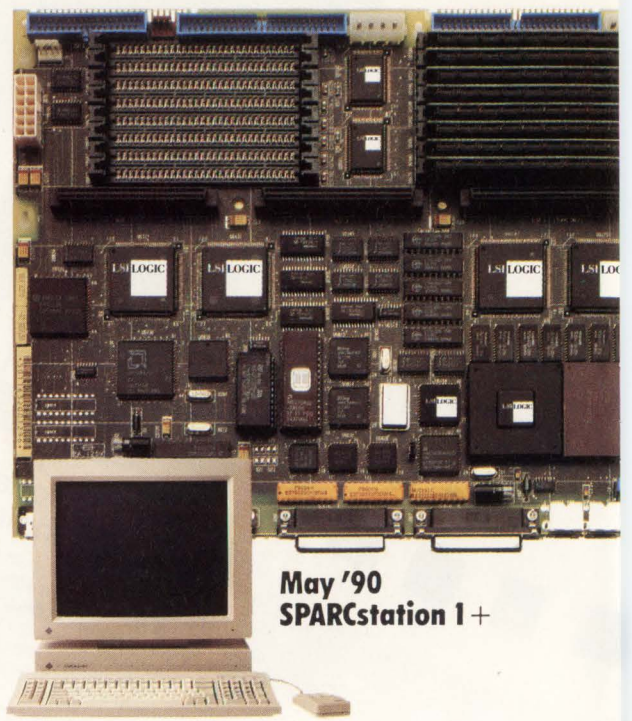

**May '90  
SPARCstation 1+**

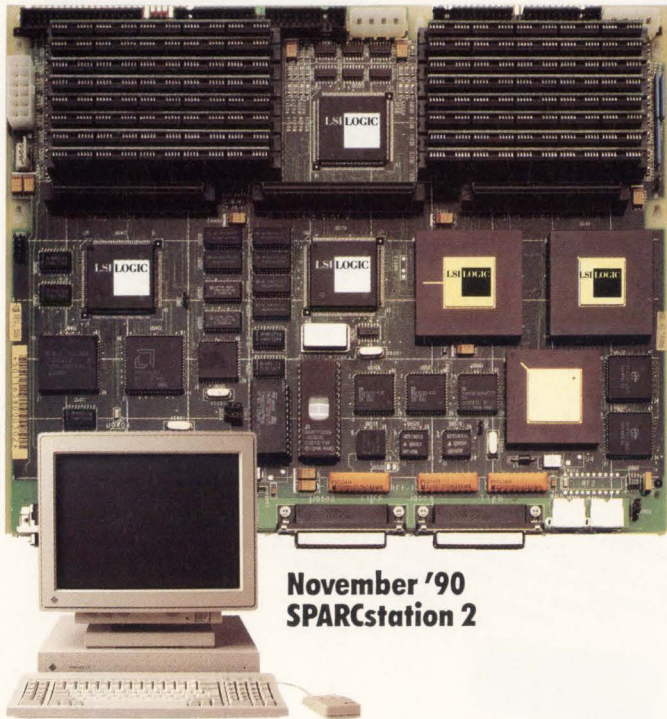

**November '90  
SPARCstation 2**

# LSI HAS ANOTHER



© LSI Logic Corporation 1990. Sun Microsystems is a registered trademark of Sun Microsystems, Inc. SPARC is a registered trademark of SPARC International, Inc., and SPARCstation is used under license therefrom. UNDX is a registered trademark of AT&T Bell Labs.

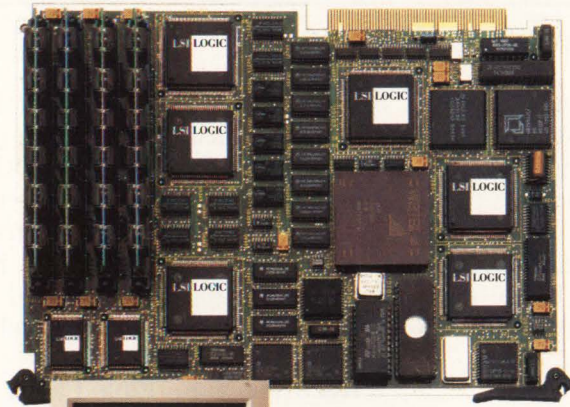

May '90  
SPARCstation SLC

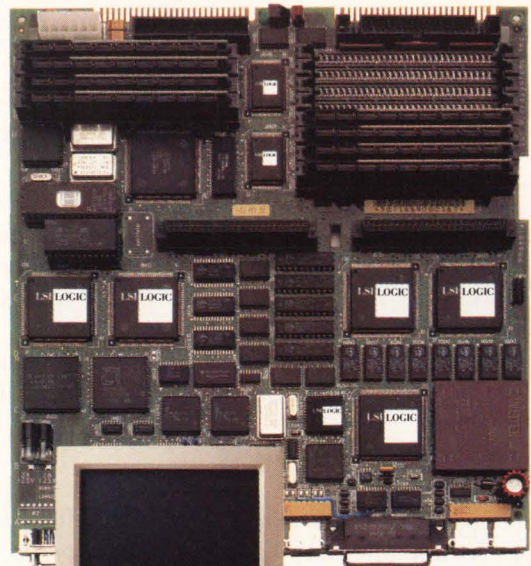

July '90  
SPARCstation IPC



# S JUST MADE ER SUN SHINE.

Since introducing SPARCstation 1 in April '89, Sun has utilized LSI Logic's RISC and ASIC technology and design methodology to pack more processing power into smaller footprints.

This strategic partnership has enabled Sun to compress time to market to an unbelievable four months between new product announcements and has reduced their time to volume. Forever altering the rules on time to market. And capturing the dominant position in the workstation market in the process.

Sun's latest creation, SPARCstation 2, is a shining example. This powerful new workstation was brought to market just four months after the introduction of the

SPARCstation IPC. By leveraging the power of LSI Logic's RISC and ASIC technology, Sun has quickly introduced a whole new level of price/performance in UNIX workstations.

If you have some brilliant new product concepts on your horizon, with windows of opportunity opening as often as every four months, call us at 1-800-451-2742, or write to LSI Logic, 1551 McCarthy Blvd, MS D102, Milpitas, CA 95035.

We'd like to show you how quickly your new product can see the light of day.

LSI LOGIC®

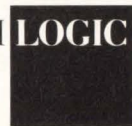

ACROSS THE BOARD



# NEW PRODUCTS

## COMPONENTS & POWER SUPPLIES



### Toggle-Switch Attenuators

- Have a 75Ω impedance
- Lifetime equals 100,000 cycles

The TX Series of 75Ω, toggle-switch attenuators has two versions. The 75TX42 has an attenuation range of 0 to 42 dB in 1-dB steps, and the 75TX82.5 has an attenuation range of 0 to 82.5 dB in 0.5-dB steps. Both types of attenuators incorporate silver-contact switches that are rated for 100,000 cycles of operation. The units operate over a dc to 1-GHz range and are rated for 1W average power and 500W peak power. Measuring 1.062 ×

1.062 × 4.249 in., the units are well suited for panel or in-line applications. Connector options include a choice of BNC, F, N, or TNC. \$215 to \$245.

**Alan Industries Inc**, Box 1203, Columbus, IN 47202. Phone (800) 423-5190. **Circle No. 376**

### Industrial Keyboard

- Splash and dust proof
- Designed for rack mounting

The RMK-103 PC-compatible keyboard is designed for hostile environments. Its slides make it easy to mount in a 19-in. rack. The unit's features include 103 keys with 12 function keys across the top, a numeric keypad, and a separate cursor-control cluster. All keys are environmentally sealed to make them splash and dust proof. An autosense switching feature provides compati-

bility with IBM PC/XTs and PC/ATs; an optional adapter cable provides PS/2 compatibility. Other keyboard features are step-sculptured keytops, frequency programmable autorepeat, and N-key rollover for all keys. The keyboard has a 6-ft shielded cable and a standard DIN connector. \$495.

**Recortec Inc**, 1290 Lawrence Station Rd, Sunnyvale, CA 94089. Phone (800) 729-7654; in CA, (408) 734-3443. **Circle No. 377**

### Optical Encoders

- Operate from 5V dc
  - Develop a quadrature output
- Series D688 units are actually two concentric-shafted optical encoders in one package. They are designed to be panel-mounted in a space that is only 0.5-in. square. The devices operate on an input power of 5V

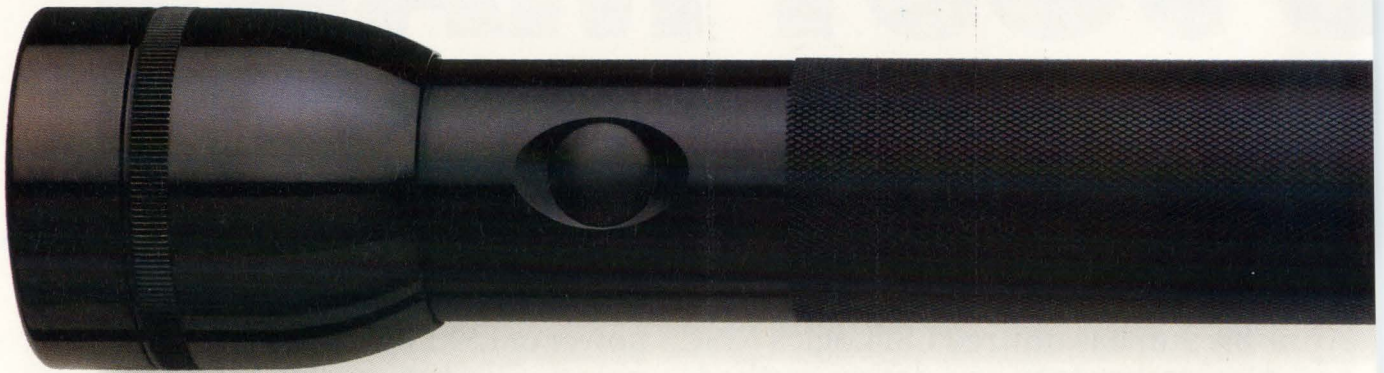

# Make your big ideas smaller, lighter and brighter.

**DURACELL® XL™ DL123A Lithium Batteries give you the power to think small, improve performance and portability.**

Today's emphasis on smaller, lighter, more powerful portable devices requires a bright idea in battery technology. It's here.

Size for size, the DL123A delivers more combined power and energy than other consumer replaceable batteries. In fact, for high current applications, this compact 3-volt lithium battery delivers up to four times more energy than a 1.5-volt AA size battery — even more at low temperatures.



dc at 30 mA. Each section of the unit outputs two square waves in quadrature over a pulse range of 20 to 64 pulses/revolution. Output levels range from 0.4 to 2.4V. Rotational life equals a minimum of  $10^6$  revolutions, and operating range spans  $-20$  to  $+65^\circ\text{C}$ . The units are available with shaft or mounting seals and with cable terminations. \$33.98 (1000).

**Clarostat Mfg Co Inc**, Box 1507, Dover, NH 03820. Phone (603) 742-1120. **Circle No. 378**

### High-Contrast Panel Meter

- Features an LCD readout
- Has 0.1% accuracy

The DPM-54  $3\frac{1}{2}$ -digit panel meter features an LCD readout. Designed for portable equipment applications, the unit has 12.5-mm-high characters, programmable decimal

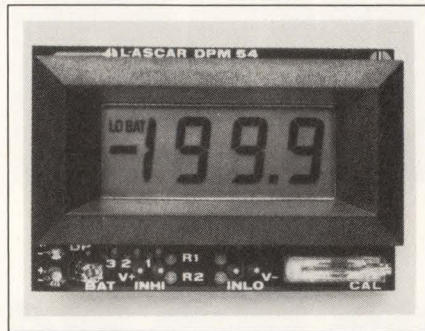

points, and an automatically displayed low-battery warning signal. Autozero, autopolarity, and a bandgap reference are standard. Measurement accuracy equals  $0.1\% \pm 1$  digit. The meter mounts in a panel cutout measuring  $2.68 \times 1.3$  in. and comes with a DIN-compatible bezel and a mounting kit. \$63.70.

**Martel Electronics**, Box 897, Windham, NH 03087. Phone (603) 893-0886. **Circle No. 379**

### Solid-State Relay

- Rated for 25A
- Qualified for MIL-R-28750/10

JPS Series solid-state relays are fully qualified to parts 001 and 002 of MIL-R-28750/10. The relays can handle loads 25 to 220V ac at 25A current levels. Internally, optical coupling techniques provide 1500V rms isolation between the input and output. Zero turn-on switching limits in-rush current, switching transients, and associated EMI. The relay features die-cast aluminum construction, which facilitates heat-sinking and is hermetically sealed to withstand harsh environments. Operating range spans  $-55$  to  $+110^\circ\text{C}$ . \$215 (100). Delivery, 8 to 10 weeks ARO.

**Struthers-Dunn/Hi-G Co Inc**, Lambs Rd, Pitman, NJ 08071. Phone (609) 589-7500. FAX (609) 589-2619. **Circle No. 380**

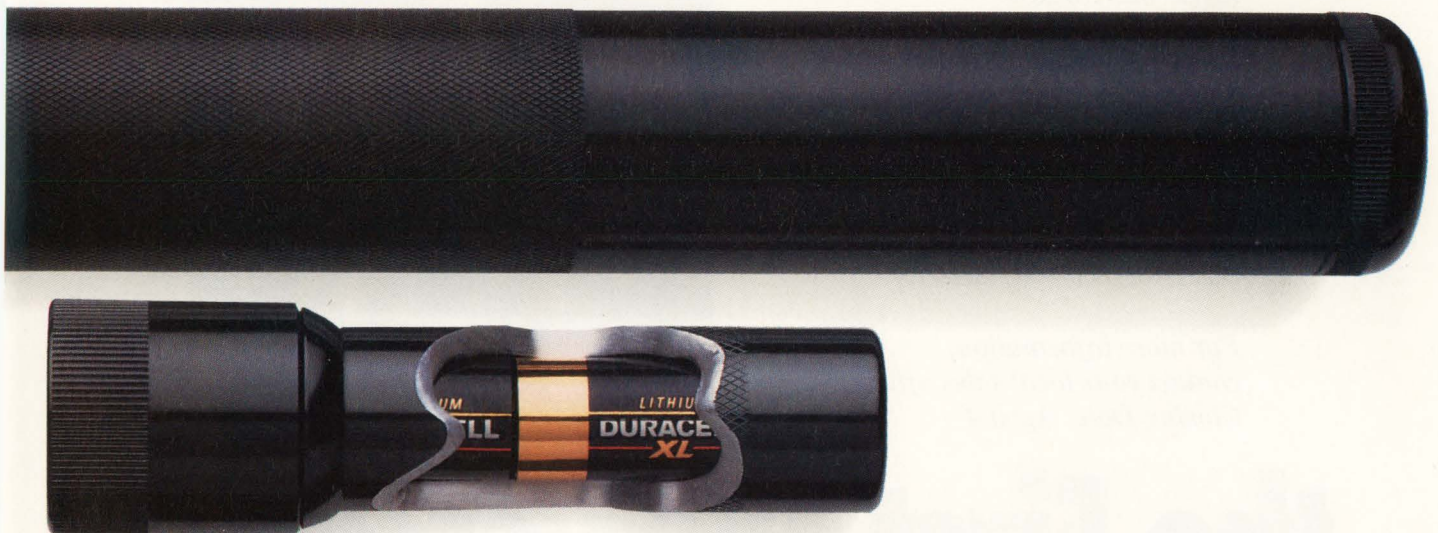

DURACELL XL Lithium Batteries are engineered for single or multicell applications. They're made in the USA and distributed worldwide under the brand name consumers prefer most, DURACELL.

Find out what Duracell's latest high power technology can do for your bright ideas. Write or call for our updated DL123A Performance Portfolio. Or if you have an immediate need, contact our OEM battery engineers today.

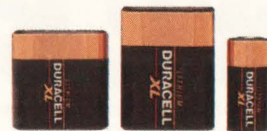

**DURACELL INC.**

### DURACELL INC.

New Products and Technology Division  
OEM Sales and Marketing  
Berkshire Industrial Park  
Bethel, CT 06801  
Toll-free: 1-800-422-9001 ext. 426  
Facsimile: 203-791-3273

©1989, Duracell Inc.



# On May 1<sup>st</sup> Celebrate

***Electronic Business Asia:***  
***The Business Magazine for the***  
***Asian Electronics Industry***

Hong Kong: 852-592-2037

Japan: 813-3366-8301

Taiwan: 866-2711-4833

Korea: 822-776-2096

Singapore: 65-532-4026

Thailand: 662-233-5892

Phillipines: 632-833-7616

India: 911-1543-1249

Australia: 612-283-2788

United States: 617-558-4464

United Kingdom: 4471-628-7030

*For more information,  
contact your local sales office.  
Closing Date: April 4*

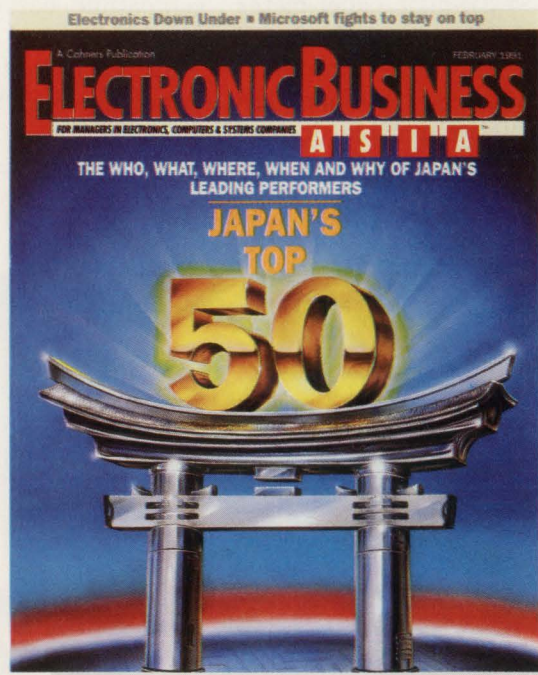

## ...the First Anniversary of Electronic Business Asia.

A Very Special Edition. Including interviews with industry leaders about the future of Asia.

Electronic Business Asia, 22/F Lo Yung Court, 212-220 Lockhart Road, Hong Kong



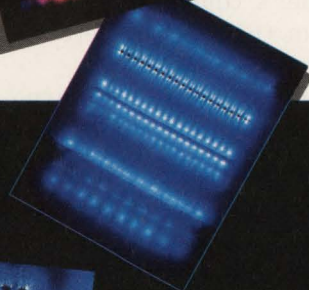

United States Europe Japan Korea Singapore

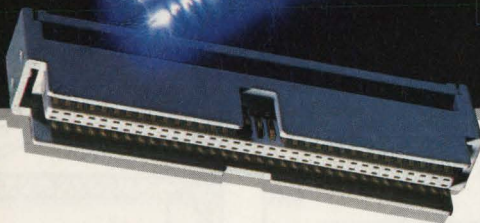
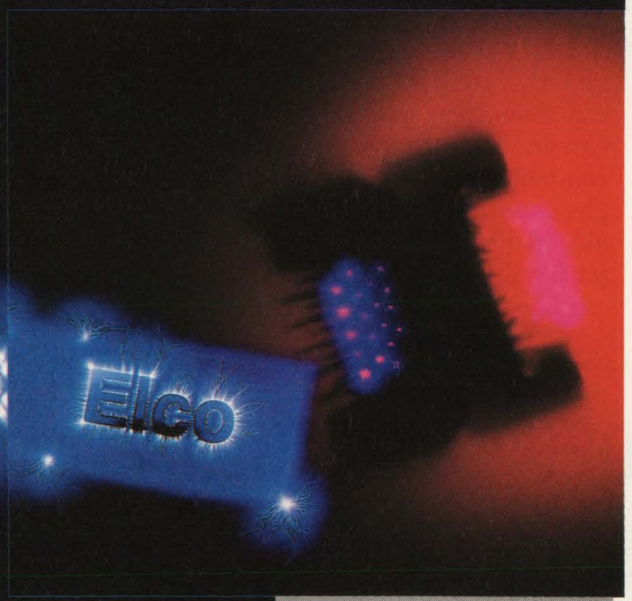
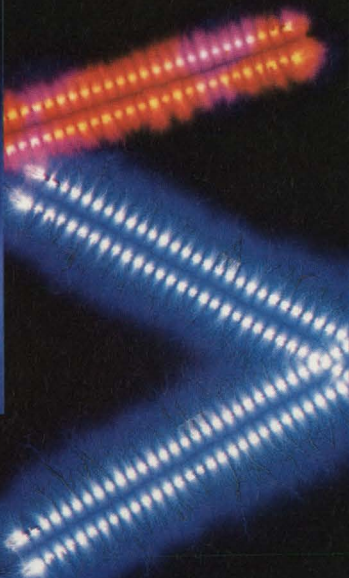

**GREATER  
WORLD CLASS  
POWER FROM  
OUR NEW  
GLOBAL  
CONNECTIONS**

The recent alliance of Elco and AVX with Kyocera forms a solid business relationship that gives us even stronger connections to today's exciting world of technology.

These connections strengthen our own high quality standards and link us to new sources of innovation throughout the world.

Together we combine our talents, energies, and experience to provide you with an ever-expanding line of advanced connector products of unsurpassed value. These new connections also contribute to a fresh spirit of efficient service and delivery and

assure you of timely response to your ever-evolving needs.

From a new source of energy emerges a powerful new Elco.



**World Class Connections**

Copyright 1990, Elco Corporation.  
All rights reserved.



# NEW PRODUCTS

## CAE & SOFTWARE DEVELOPMENT TOOLS

### Gerber File Viewer

- *Previews pc-board artwork*
- *Displays Gerber files on computer screen*

EZ-view, a program for IBM PCs and compatible computers with VGA or EGA displays, puts a Gerber-formatted pc-board artwork file on screen, allowing you to inspect it for accuracy. Viewing the file lets you detect errors before they can result in bad film or bad circuit boards; the viewing area covers as much as 36 in. of the board in both X and Y directions. Using a mouse and the computer keyboard, you can zoom, pan, and snap on a grid cursor. The package displays data containing as many as five decimal places with trailing zeros; it is available alone or as part of the Gerberjet file-printing utility. You can also

download a demo version from the supplier's computer bulletin-board system (BBS). \$99; Gerberjet (including EZ-view), \$199.

**Logical Systems Corp.**, Box 6184, Syracuse, NY 13217. Phone (315) 478-0722. FAX (315) 475-8460. BBS (315) 471-3961 (2400/1200,8,N,1) **Circle No. 381**

### Signal-Processing Software

- *For stand-alone use or integration with other software*
- *For IBM PCs and compatible computers*

PC Data Master 3.0, a signal-processing system for the IBM PC and compatible computers, combines routines for graphics, data sampling, test-data generation, real and

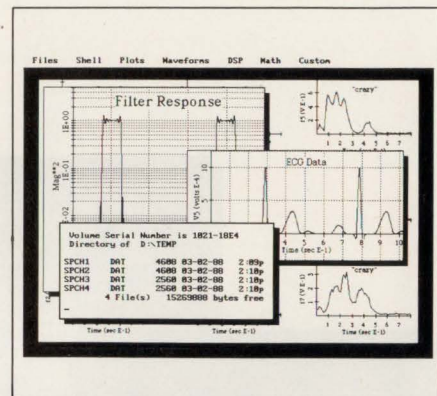

complex math, and digital signal processing. You can integrate your own software with the package using virtually any language compiler or assembler compatible with MS-DOS version 3.0 or higher. The software features both pull-down menus and a traditional DOS command window for user interaction

sponsored by:



## 28th ACM/IEEE

In cooperation with:

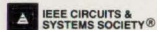

# DESIGN AUTOMATION CONFERENCE & EXHIBITION

• Over 125 exhibitors of CAD hardware and software products.

• Over 60 exhibitor technical presentations Monday, June 17, 1991, many announcing new products.

• *Monday Exhibits Only Passes.* Free invitations available from participating companies.



• DA Professionals world-wide attend DAC to keep current with advancements in Design Automation.

• Seven full day tutorials Friday, June 21, 1991.

• Over 140 papers, tutorials and panel presentations.

**ADVANCE REGISTRATION ENDS MAY 17, 1991.**

For more information contact DAC at: 7490 Clubhouse Rd., Suite 102, Boulder, CO 80301 (303) 530-4333, FAX (303) 530-4334

**MOSCONE CENTER**  
June 17- 21, 1991  
San Francisco, California

**ATTEND THE WORLD'S LARGEST DESIGN AUTOMATION EVENT**

**This year's conference starts Monday, June 17, 1991 !!**



**Our Concept**

# Worldwide Presence



For us a presence all over the world has always been a key objective. After all, our customers are located throughout the entire world. And so are we. With ten European subsidiaries plus two in Asia and another in the U.S.A., an international sales and distribution structure and production facilities in England, France, Germany, Hongkong and Switzerland. So, wherever, our customers are, they can be sure that we keep in close contact with them.

**For connections that work worldwide:**

World headquarters:  
HARTING ELEKTRONIK GmbH  
P.O.Box 1140 · D-4992 Espelkamp · Germany  
Phone (0 57 72) 47-0 · Fax (0 57 72) 47-461  
Telex 9 72 310-11 he d

HARTING Subsidiary Companies:

**Austria/Vienna**  
Tel. 02 22/68 68 18  
**Belgium/Brussels - Zellik**  
Tel. 02-466.01.90  
**France/Paris**  
Tel. (1) 486 323 89  
**Great Britain/Northampton**  
Tel. (06 04) 76 66 86  
**Hongkong**  
Tel. 08 52-422 18 09  
**Italy/Milano - Vimodrone**  
Tel. (2) 27 40 03 00  
**Japan/Yokohama**  
Tel. 045-931.57 15  
**Netherlands/Breda - Etten Leur**  
Tel. 01608-3 54 00  
**Norway/Oslo**  
Tel. 02-6475 90  
**Spain/Barcelona**  
Tel. (3) 323 20 22  
**Sweden/Stockholm - Spånga**  
Tel. (08) 7 61 79 80  
**Switzerland/Zürich - Schwerzenbach**  
Tel. 01-8 25 51 51  
**USA/Chicago - Hoffman Estates**  
Tel. (708) 519-77 00

Agencies:  
Denmark, Finland, South Africa

Representatives:  
PRC/Shanghai, ROC/Taipei,  
ROK/Seoul, Singapore





with either a mouse or the keyboard. You can create multiple graphics windows for data display. Binary data pipes link processing modules implemented as executable (.EXE) files; you can add any number of your own modules, which can be written in any language that supports the standard DOS file system I/O. DSP utility modules included with the software are forward and inverse FFT routines; convolution; correlation; window generation; FIR and IIR filter design and implementation; derivatives and integrals; test-data generation (sinusoidal, rectangular, impulse, triangular, uniform-random, and Gaussian-random data); and real and complex math functions. Multistage transformations such as Cepstrum and Hilbert transforms are available by combining basic operations in data pipes. The software includes data-acquisition routines but does

not allow continuous real-time processing. \$185; demo disk, \$10.

**Durham Technical Images**, Box 72, Durham, NH 03824. Phone (603) 868-5774. **Circle No. 382**

### Image-Processing And Analysis Software

- PC software with functions of dedicated systems
- Runs alone, or with off-the-shelf applications or user-written code

Global Lab Image, a PC-based image-processing and analysis software package for scientific and engineering applications, offers automatic object counting and measurement, frequency analysis, and spectrum editing. According to the supplier, these functions are normally available on dedicated systems that cost more than \$20,000. Other features include morphology, filters, arithmetic and logic operations, his-

tograms, overlays, image acquisition, and display. The software runs with Microsoft Windows 3.0, making all options available simultaneously in multiple open windows. Switching between options is a point-and-click mouse operation. Windows 3.0 also enables other software-application packages to run with the package; with cut-and-paste operations, you can move images and measurements among the different applications. A script option lets you record and replay sequences of commands. You can also edit scripts and write custom code in interpreted C. The software works with the supplier's Quickcapture frame-grabber boards for the IBM PC/AT and the PS/2. Versions for other frame grabbers will be available this spring. \$2495.

**Data Translation**, 100 Locke Dr, Marlboro, MA 01752. Phone (508) 481-3700. **Circle No. 383**

**Non-Contact Current & Voltage Transducers**

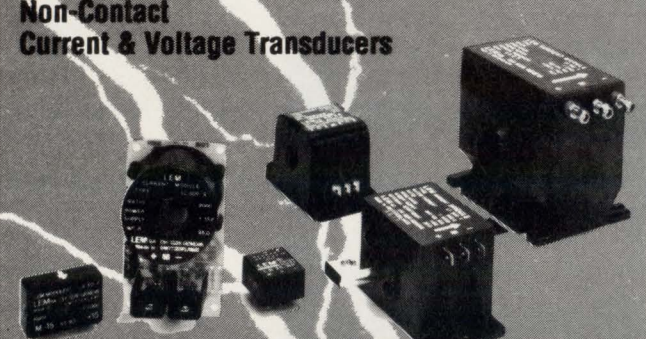

**Measure Electrical Circuits Provide Control Outputs**

Transducers that feed-back Current & Voltage measurements for electronic control

- ✓ Measure DC, AC and pulse currents, bandwidth from DC to 100kHz.
- ✓ High degree of accuracy: 0.2% to 1% typical
- ✓ Currents to 500,000 amperes
- ✓ Voltages to 6,400 volts
- ✓ Instantaneous or True RMS outputs
- ✓ Open and closed loop systems
- ✓ Excellent Linearity: less than 0.1% typical
- ✓ Accuracy, stability and linearity guaranteed for life
- ✓ Reliable in hostile environments
- ✓ Rapid Response time: better than 1msecond
- ✓ Wide range of current measurement and large overload capacity

**LEM USA** Look for us in EEM & Thomas Register  
 6663 W. Mill Rd. • Milwaukee, WI 53218  
 Tel: 414-353-0711 • Fax: 414-353-0733

**Silicon Sensors For OEM Designers.**



**Take advantage of NovaSensor's low-cost, high-reliability silicon technology.**

- Acceleration ranges from  $\pm 2$  G to  $\pm 50$  G
- Widest pressure ranges from 2" H<sub>2</sub>O to 10,000 psi
- Accuracies to  $\pm 0.1\%$  full scale output
- 316 SS diaphragm for harsh media compatibility
- Superior stability and small size

Call or write for product brochure and application assistance.

**NOVA SENSOR** 1055 Mission Ct., Fremont, CA 94539, USA  
 Tel: (415) 490-9100; Fax: (415) 770-0645  
 Telex: 990010



**EXPERIENCE THE FUTURE  
IN CAE/CAD**



# PADS 2000

**2000** PADS is a Personal Computer based Printed Circuit board design system with many advanced features capable of outperforming most Workstation-based CAD systems—at a fraction of the cost.

As the most productive PC based board CAD system available today, PADS-2000 can handle even the most complex designs including: double sided surface mount boards, mixed technology boards, high speed designs and layouts exceeding 2000 IC's.

PADS-2000 design functionality includes:

- Over 11,000 parts/32,000 connections
- 1 micron Resolution
- True T-Routing capability

- Intelligent Copper Pour feature leaving isolated tracks and pads
- 0.1° parts/pads rotation
- Extensive Macro capability
- Digital, Analog and Critical Circuit autorouters

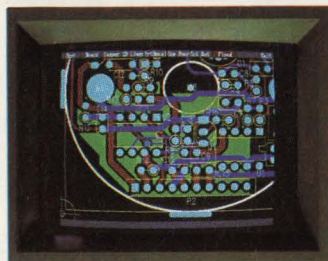

- On-line and Batch Design Rule Checking
- Instant track/segment length measurement
- Complete Forward/Backward ECO capability
- Uses 32 bit/386 native code for increased speed and functionality
- Easy-to-learn and Easy-to-use

Call today for a demonstration at your local authorized CAD Software Dealer.

*Ask about our affordable Leasing Plan.*  
See us at Electro Booth #2144

Call Today  
Inside MA:  
**(508) 486-8929**  
Outside MA:  
**(800) 255-7814**

**CAD**

Software, Inc.

119 Russell Street  
Littleton, MA 01460



# NEW PRODUCTS

## INTEGRATED CIRCUITS

### 12-Bit-Plus-Sign A/D Converter

- *Self calibrating*
- *Has differential inputs*

The TLC1225 self-calibrating A/D converter combines a 12- $\mu$ sec conversion speed with 12-bit integral linearity, 12-bit-plus-sign resolution, and an 85-mW-max power requirement. For applications requiring minimum system noise, the ADC has differential inputs that reduce system error created by common-mode noise. The ADC can also accommodate single-ended inputs. The converter outputs data in a parallel word and interfaces directly to a 16-bit data bus. The output code for bipolar conversion is in 2's complement format; for unipolar conversion, the code is in standard binary format. Maximum offset error

is  $\pm 1\frac{1}{2}$  LSB and unadjusted positive and negative full-scale error is  $\pm 2$  LSB. In a 28-pin DIP, \$16.74 (1000).

**Texas Instruments Inc**, Semiconductor Group (SC-91009), Box 809066, Dallas, TX 75380. Phone, in North America, (800) 336-5236, ext 700; in TX, (214) 995-6611, ext 700. **Circle No. 384**

### Clock Converter

- *Has  $\times 4$  and  $\times 1$  modes*
- *Operates to 1.5 MHz*

The LS7080/LS7081 converts quadrature clocks to up/down clocks (LS7080) or to a clock and an up/down direction control (LS7081). An input pin selects either the  $\times 4$  or  $\times 1$  mode. An on-chip state generator controls the up/down direc-

tion and the output clocks. In the  $\times 4$  mode, output clocks occur on each edge of the input quadrature clocks so that four output clocks occur for each input cycle. In the  $\times 1$  mode, up/down clocks occur on specific input-clock edges so that only one output clock occurs for each input cycle. Internal filtering eliminates clock jitter and ensures a constant output-clock width in the  $\times 4$  mode. An external resistor sets the output-clock width in the  $\times 4$  mode. In the  $\times 1$  mode, the operating frequency, which can be as high as 1.5 MHz, sets the clock width. The LS7080/LS7081 in 8-pin miniature DIPs, \$0.75 (1000).

**LSI Computer Systems**, 1235 Walt Whitman Rd, Melville, NY 11747. Phone (516) 271-0400.

**Circle No. 385**



### SL Waber takes the bite out of electricity

In fact, we've been taming electricity since 1959. SL Waber offers the world's broadest selection of power protection solutions. Our Surge Sentry<sup>®</sup>, Datagard<sup>®</sup> and Power Master<sup>®</sup> surge suppressors are all tested to the stringent UL Standard 1449. Selected models feature a lifetime warranty and our no-nonsense Power Protection Promise that covers all properly connected equipment. We have surge suppressors that offer hard disk, phone line and 20-amp protection. And if you can't find exactly what you need, we can even custom design a product to fit your unique application. Because if you use electricity, you need SL Waber.

**SL WABER, INC.**  
A Subsidiary of SL Industries, Inc.  
(800) 634-1485 • In NJ call (609) 866-8888

CIRCLE NO. 36

## PCB MANUFACTURING DESIGN AND ARTWORK !

ALL YOUR CIRCUIT BOARD NEEDS UNDER ONE ROOF

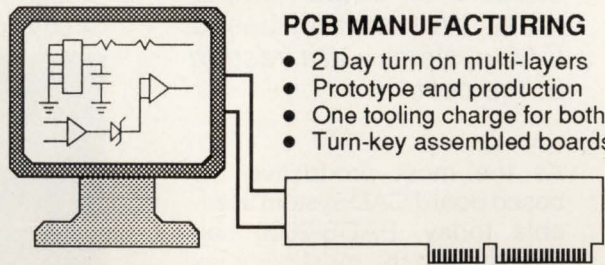

### PCB MANUFACTURING

- 2 Day turn on multi-layers
- Prototype and production
- One tooling charge for both
- Turn-key assembled boards

### PCB DESIGN

- Backplanes
- Impedance control
- Analog and ECL
- Surface mount

### TECHNICAL ASSISTANCE

- PCB design tips
- Mfg cost cutting tips
- Testing guidelines
- We accept gerber data via modem (714) 970-5015

## CALL FOR A QUOTE !

A MANUFACTURING, PCB DESIGN AND SUPPORT CENTER

**ACD** MURRIETTA CIRCUITS  
4761 E. HUNTER AVE. ANAHEIM, CA. 92807  
TEL: (714) 970-2430 FAX: (714) 970-2406

CIRCLE NO. 37



EDN April 11, 1991

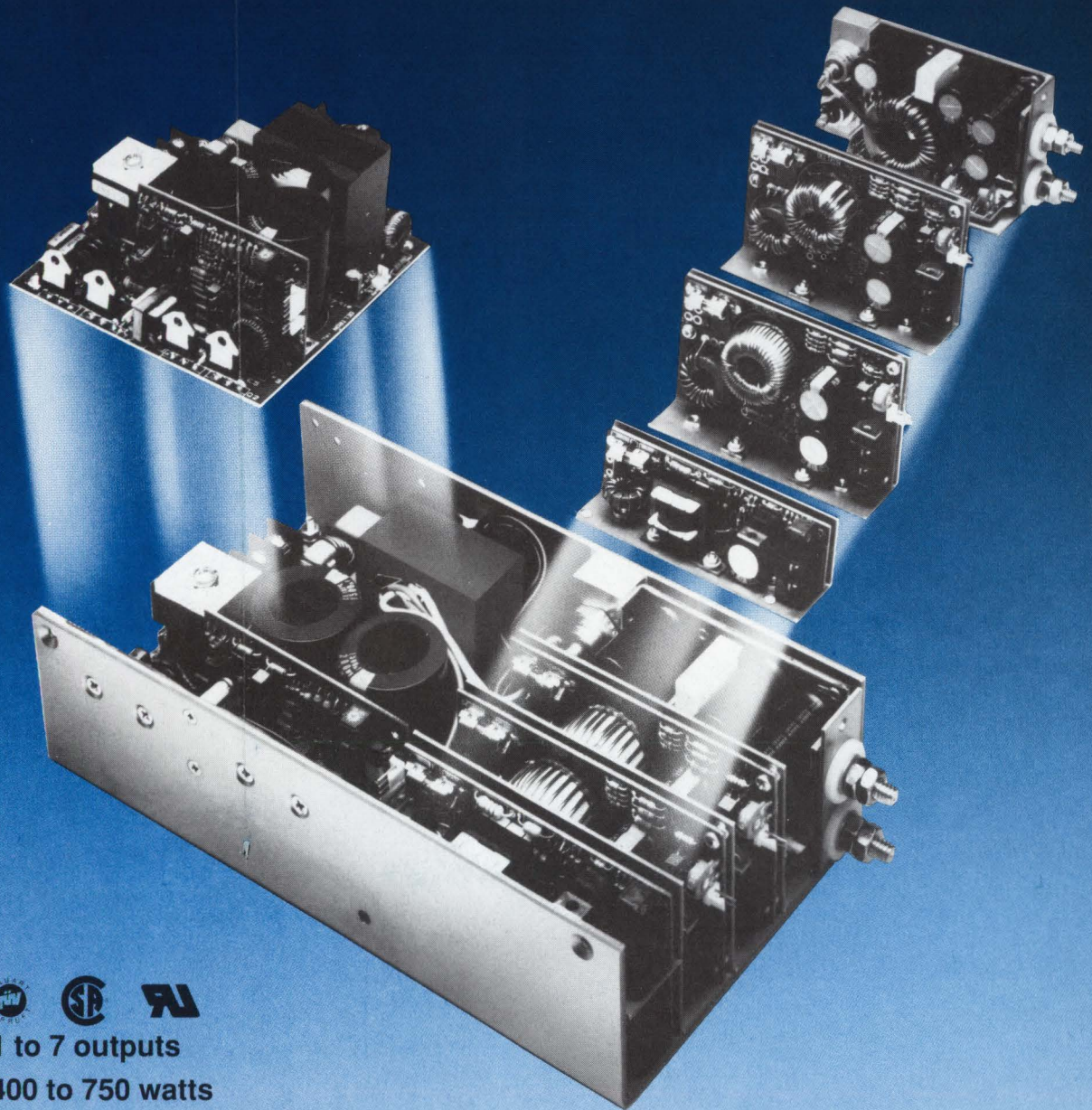

# M and DM SERIES MODUFLEX SWITCHERS

*CUSTOM SWITCHERS FROM STOCK MODULES  
HIGHEST POWER DENSITY...6 WATTS/CU. IN.!*



-   
- 1 to 7 outputs
- 400 to 750 watts
- 2 weeks delivery
- No engineering charge
- AC and DC input units
- Replaces expensive high density systems using potted modules

Call Toll Free 1-800-523-2332  
In PA: 215/699-9261

**Deltron inc.**  
POWER PRODUCTS



# M/DM SERIES SELECTION CHARTS

Input Module Power Codes	
A	400W
B	500W
C	600W
D	750W

Output Module Types	
J	1/2 Height
K	Full Height
L	Double Full
R	Small Main
M	Main
N	Super Main

M Type Main Module Ratings		
Power Rating	Current Multiplier	
	Single	Multiple
400W	0.8	0.6
500W	1.0	0.8
600W	1.2	1.0
750W	N/A	1.2

Options	
Option Code	Function
01	Power Fail Monitor
02	Auto Ranger
04	Pilot Bias
08	Active Surge Limit
16	Redundant
32	Cover
64	Fan Cover

Options 02, 04, 08 mutually exclusive.

Output Modules							
Code	Volts	Type					
		J Amps	K Amps	L Amps	R Amps	M Amps	N Amps
0	2	10	20	30	40	100	150
1	3.3	10	20	30	40	100	150
2	5	10	20	30	40	100	150
3	12	6	12	24	17	42	62
4	15	5	10	20	13	33	50
5	18	4	8	16	11	28	42
6	24	3	6	12	9	21	31
7	28	2.5	5	10	7	18	27
8	36	2	4	8	6	14	21
9	48	1.5	3	6	4	10	16
A	2.2	10	20	30	40	100	150
B	2.4	10	20	30	40	100	150
C	2.7	10	20	30	40	100	150
D	3	10	20	30	40	100	150
E	3.6	10	20	30	40	100	150
F	4	10	20	30	40	100	150
G	4.5	10	20	30	40	100	150
H	5.7	10	20	30	36	90	135
J	6.3	10	20	30	32	80	120
K	7	9	18	30	28	70	105
L	8	8	16	30	25	62	93
M	9	8	15	30	22	56	84
N	10	7	14	30	20	50	75
P	11	7	13	27	18	45	68
Q	13.5	6	11	22	15	37	56
R	17	5	9	18	12	30	45
S	19	4	8	16	11	26	39
T	21	4	7	14	10	24	36
U	23	4	7	13	9	22	33
V	26	3	6	12	8	19	29
W	29	3	5	10	7	17	26
X	32	2	5	9	6	16	24
Y	40	2	4	8	5	13	20
Z	44	2	4	7	5	12	18

For multiple output modules of a given type, voltages are arranged in ascending order by magnitude in the same sense as the output number sequence. Shaded ratings are stock, others available on special order.

## Output Configurations

Output #1 can be Type K, L, R, M. For singles, M or N only.

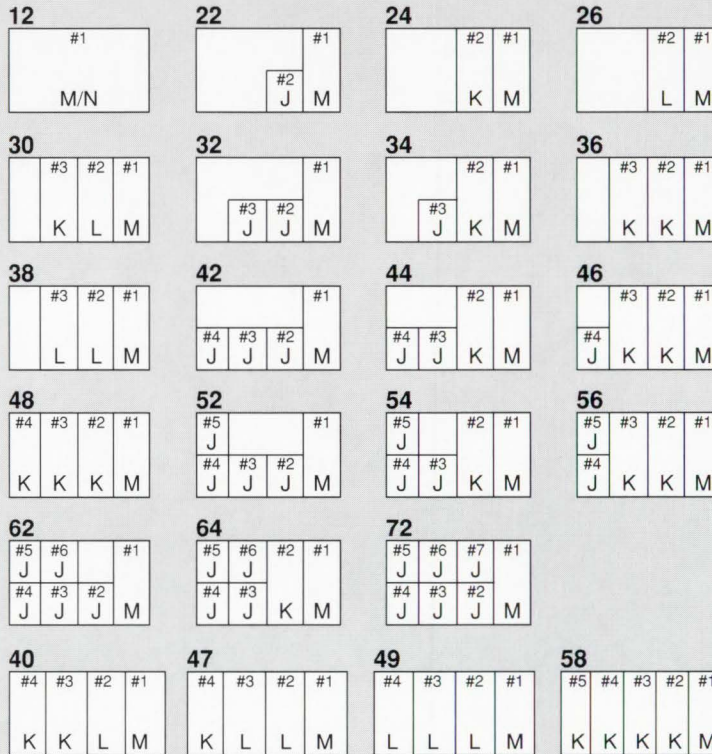

The boxes above are diagrammatic representations of the power supplies as viewed from the output end. The two digit numbers above the boxes are the configuration codes. Configurations 40, 47, 49 and 58 - Power Code D, Case 3. Configurations 26, 30 and 38 - Power Codes C and D, Case 2. Remaining configurations - Power Codes A, B, C and D, Cases 1 and 2.

## M/DM SERIES DIMENSIONS

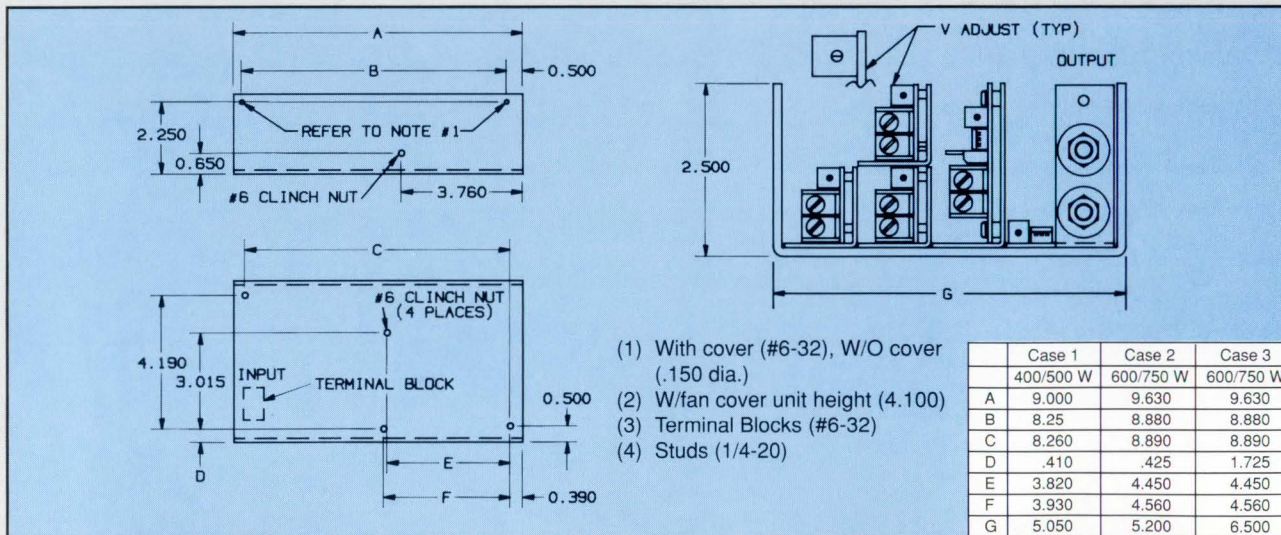



## DESCRIPTION

Moduflex switchers form a comprehensive line of open frame power supplies assembled from standard "off the shelf" modules. These subunits and assembly hardware are pre-approved by safety agencies so that certifications can automatically apply to custom models. Additional advantages include first piece delivery within two weeks and the elimination of engineering costs for qualified "OEM" requirements using stock modules.

The M and DM Series offers the highest power density available in the industry, delivering 6 watts per cubic inch at an ambient temperature of 50°C. The design features "State of the Art" topology, a meticulous thermal structure and the use of high efficiency circuits and components to attain the desired power density.

The modular system concept reduces manufacturing to simple submodules, capable of high volume production with a superior quality level.

M Series are available in power ratings from 400 to 750 watts with only a slight size increase. This power versatility permits system expansion without the need for extra power supply space. DM Series available in power ratings of 400 or 600 watts.

## FEATURES

- TUV, UL, CSA.
- 6 watts per cubic inch.
- 400-750 watts output.
- 120 kilohertz MOSFET design.
- Current mode control.
- All outputs:
  - Adjustable*
  - Fully regulated*
  - Floating*
  - Overload and short circuit proof*
  - Overvoltage protected*
- Standard features include:
  - System inhibit*
  - Load proportional DC fan output*
- Options include:
  - Auto ranger for continuous input operation*
  - Power fail monitor*
  - Independent pilot bias*
  - Cover*
  - Fan cover*
  - Active surge limit*
  - Redundant operation*

## MODEL SELECTION

Input modules are available in ratings of 400, 500, 600, and 750 watts with corresponding code letters A through D. See Power Codes chart opposite.

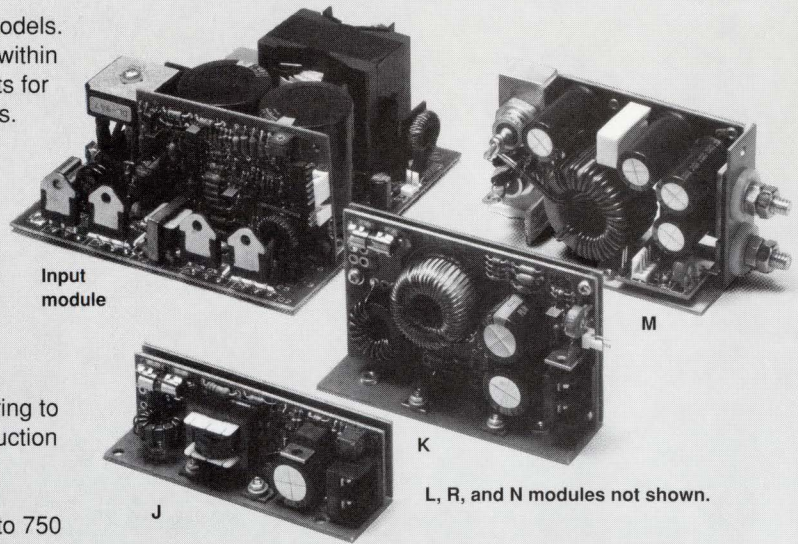

Output modules are available in six types J, K, L, R, M and N in nominal power outputs of 75, 150, 300, 200, 500 and 750 watts respectively. Type M or main output modules are variable power rated depending upon the power level of the input module. This is reflected in the rating table opposite which shows the corresponding multiplier applicable to the output current ratings of the M module as a function of the power rating of the input module. For example, a 750 watt multiple will have its M type module configured to produce 600 watts of output. The ratings of output modules are given in the table of output types. Ratings in shaded areas are stocked for fast delivery.

## HOW TO ORDER

To form the proper model number defining a custom requirement, select the letter M to designate the series, then choose the desired configuration of output modules and list the configuration code. Insert the power code letter for the power level and follow with the output code numbers or letters for each specific output. Enter a dash and from the option table insert the sum of the option codes. Add a suffix letter K, L or R to designate the substitution of one of these module types for the type normally specified for output #1. See example below. For DC input add a prefix D to the model number.

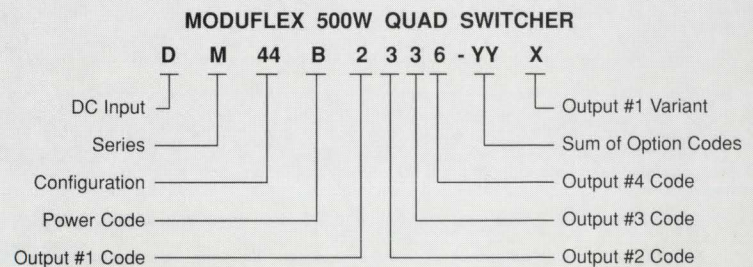



# SPECIFICATIONS

## INPUT

90-132 VAC or 180-264 VAC, 47-440 Hz. Strappable.  
40-60 VDC for DM Series.

## INPUT SURGE

Less than 68 Amps peak from cold start.

## HOLDUP TIME

20 milliseconds from loss of nominal AC power.  
3 milliseconds for DM Series.

## OUTPUTS

See model selection table.

## ADJUSTABILITY

±5% trim adjustment.

## OUTPUT POLARITY

All outputs are floating from chassis and each other and can be referenced to each other or ground as required.

## LINE REGULATION

Less than ±0.1% or ±5mV for input changes from nominal to min. or max. rated values.

## LOAD REGULATION

±0.2% or ±10mV for load changes from 50% to 0% or 100% of max. rated values.

## MINIMUM LOAD

Main output requires a 10% minimum load for full output from auxiliaries.

## REMOTE SENSING

On all outputs except type J modules.

## RIPPLE & NOISE

1% or 100mV pk-pk, 20 MHz bandwidth.

## OPERATING TEMPERATURE

0-70°C. Derate 2.5%/°C above 50°C.

## COOLING

A min. of 10 LFS cooling air directed over the units for full rating. Two test locations on chassis rated for max. temperature of 90°C.

## TEMPERATURE COEFFICIENT

±0.02%/°C.

## EFFICIENCY

80% typical.

## SAFETY

Units meet UL 1950, CSA 22.2 No. 220, CSA bulletin 1402C, IEC 950, VDE 0804, VDE 0806, VDE 0805 (proposed).  
Certifications in process.

## DIELECTRIC WITHSTAND

3750 VRMS input to ground.  
3750 VRMS input to output.  
700 VDC output to ground.

## SPACING

8 mm primary to secondary.  
4 mm to grounded circuits.

## LEAKAGE CURRENT

0.75 mA at 115 VAC 60Hz. input. Not applicable to DM Series.

## EMISSIONS

Units meet FCC 20780 Part 15 Class A and VDE 0871/6.78 Class A for conducted emissions. Compliance with Class B limits by use of additional external filter. DM Series also meet Bellcore TR-TSY-000515.

## DYNAMIC RESPONSE

Peak transient less than ±2% or ±200mV for step load change from 75% to 50% or 100% max. ratings.

## RECOVERY TIME

Recovery within 1%.  
R, M and N modules – 200 microseconds.  
J, K, and L modules – 500 microseconds.

## UNDERVOLTAGE

Protects against damage for undervoltage operation.

## OVERVOLTAGE PROTECTION

Standard on all outputs.

## REVERSE VOLTAGE PROTECTION

All outputs are protected up to load ratings.

## OVERLOAD & SHORT CIRCUIT

Outputs protected by duty cycle current foldback circuit with automatic recovery. Auxiliaries have additional backup fuse protection.

## THERMAL SHUTDOWN

Circuit cuts off supply in case of local over temperature. Units reset automatically when temperature returns to normal.

## SOFT START

Units have soft start feature to protect critical components.

## FAN OUTPUT

Nominal 12 VDC @ 12 watts maximum.

## INHIBIT

TTL compatible system inhibit provided.

## SHOCK

MIL-STD 810-D Method 516.3, Procedure III.

## VIBRATION

MIL-STD 810-D Method 514.3, Category 1, Procedure I.

## MECHANICAL

400 W/500 W – 2.5" H x 5.05" W x 9.00" L. Case 1.  
600 W/750 W – 2.5" H x 5.20" W x 9.63" L. Case 2.  
600 W/750 W – 2.5" H x 6.5" W x 9.63" L. Case 3.

## POWER FAIL MONITOR

Optional circuit provides isolated TTL and VME compatible power fail signal providing 4 milliseconds warning before main output drops by 5% after an input failure.

## AUTO RANGER

Optional circuit provides automatic operation at specified input ranges without strapping. Not applicable to DM Series.

## PILOT BIAS

Optional circuit provides SELV output of 5 volts at 75 milliamps independent of the main power converter. Output isolation compliant to safety specifications referenced above.

## ACTIVE SURGE LIMIT

Limits input surge to less than 18 Amps, and provides rapid reset.

## COVER

Optional flat cover recommended when customer supplied fan cooling is directed through the length of the unit.

## FAN COVER

Optional cover with brushless DC fan which provides the required air flow for full rating of Moduflex power supplies.

## REDUNDANT

This option is specified when two or more like M units are to be used in an N + 1 redundant hookup using external isolating diodes. Cable assemblies are provided that interconnect the remote sensing leads and the single redundant wire which provides current sharing. This option not available for M units containing J modules.

## POWER FACTOR CORRECTION

Refer to Bulletin FM-101 for M Series units with 0.99 power factor and harmonic currents compliant to IEC 555-2.



290 WISSAHICKON AVENUE, P.O. BOX 1369, NORTH WALES, PA 19454  
PHONE: 215/699-9261 • FAX: 215/699-2310

Int'l. Units: Delaire • Sallynoggin Road, Dun Laoghaire, Co. Dublin, Ireland. Tel: (01) 851411 Prefixes – from U.K. – (0001)–Int'l. + 353–(1) Telex: 30442DEL EI  
Delinc • Padre Mier y Dr. Mina, Reynosa, Tamps., Mexico 08866. Tel.: (892) 38723 Prefix – from USA – (01152) FAX (892) 38776

Printed in U.S.A.



# Designing with Motorola's



## Microprocessors?

Then you need HMI's development systems, we support the entire 68000 family. As Motorola enhances and increases integration of its microprocessors, you can count on HMI to be there with

high-quality development products to support your projects. HMI believes in supporting the entire family of products for the Motorola family. Ease of use and familiarity are common in all the emulators.

### Features of HMI's development systems includes:

- Run at real-time with no wait states.
- Window driven source level debugging—SourceGate®
- C, Pascal and ADA compiler source level support for all major compiler companies.
- Real-time hardware performance analyzer.
- Works with IBM PC family and UNIX based machines including Sun and Apollo.
- RS232 Interface up to 115.2K.
- Parallel Interface for high-speed code downloading.
- Complex events and sequences for break and trigger conditions.
- Two independent 4K deep trace buffers.
- 1  $\mu$ sec resolution interval timer.
- 100 nsec resolution Time-stamp in trace buffer.
- Logic state analyzer capabilities built into the emulator.
- 16 External Trace bits.
- Overlay memory up to 4 Mbytes.

If you are looking for one emulator company that provides support for the entire Motorola family, then look to HMI for total support.

### Motorola Devices Supported Include:

68000	68030	68340
68008	6809	68HC001
68010	68302	68HC11 including
68020	68332/331	F1 and D3

IBM is Reg. T.M. International Business Machines, Inc. Unix is Reg. T.M., Bell Laboratories, Inc.



### Huntsville Microsystems, Inc.

3322 South Memorial Parkway  
Huntsville, AL 35801  
Tel.: (205) 881-6005  
FAX: (205) 882-6701



**Frequency Synthesizer**

- Operates to 120 MHz
- Current drain is 3 mA

Designed for use in personal communications applications where low operating power is important, the NJ88C33 frequency-synthesizer chip features a current drain of 3 mA from a 2.5 to 5.5V supply. You

can use the IC as a single-chip 120-MHz device or with an external prescaler for operation to 2 GHz. The IC contains programmable 16-, 12-, and 7-bit counters, which are addressed by an I<sup>2</sup>C bus. The bus operates to 2 MHz and can achieve channel loading in 20 μsec. The synthesizer chip uses current-source



# Multi-Channel Filter for Data Acquisition Systems

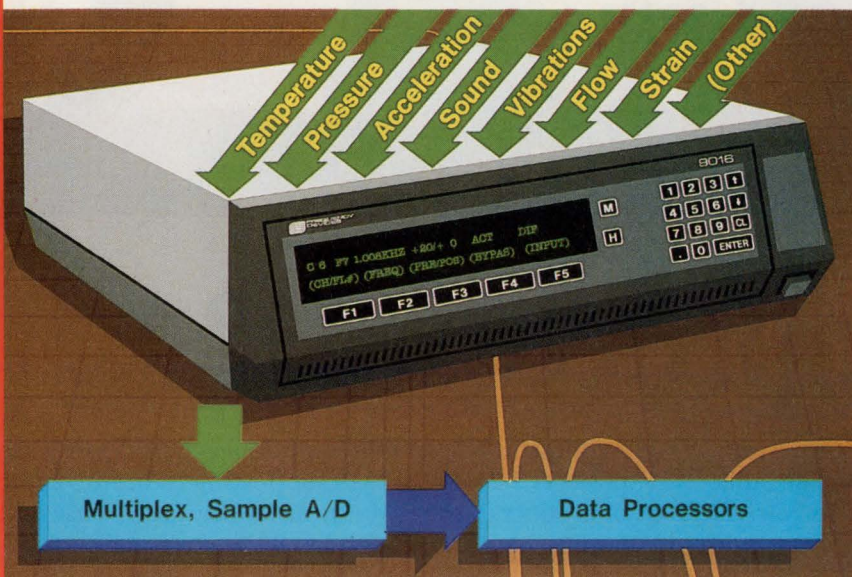

**The Model 9016 makes filtering easy**

- Expandable—Up to 16 channels
- Configurable—Choice of filter transfer functions
  - Butterworth
  - Elliptic
  - Bessell
  - Linear phase
- Simple—Menu driven operation
- Agile—Fine tuning from 0.1 Hz to 102.4 kHz
- Adaptable—Pre- and post gain to 40 dB

- Efficient—Non-volatile memory stores up to 8 set ups per channel
- Conversational—80 character display for front panel operation, and HELP messages
- Programmable—By keypad or bus—standard parallel or IEEE-488

For more information, please call us at **508-374-0761**



**FREQUENCY DEVICES™**

outputs from the phase detector, a feature that allows the implementation of a simple passive loop-filter. The NJ88C33 comes in 14-pin DIPs or SOIC packages. \$7.87 (100).

**Plessey Semiconductors**, 1500 Green Hills Rd, Scotts Valley, CA 95066. Phone (408) 438-2900. FAX (408) 438-5576. TLX 494-0840.

Circle No. 386

**Dual 14-Bit DAC**

- Saves board space
  - Includes a 3V zener reference
- The AD7244 dual 14-bit DAC includes a 3V buried-zener reference, output amplifiers, and high-speed serial interface logic. A pin-compatible 12-bit version, the AD7242, provides an upgrade path for applications that don't currently need 14-bit performance. Housed in a 24-pin DIP or 28-lead SOIC, these dual DACs save cost and board space compared with separate devices. The devices typically consume 130 mW from ±5V supplies. The 14-bit dual DAC settles to ±½ LSB in less than 4 μsec; the 12-bit device settles in 3 μsec. Both devices have a nominal output span of ±3V. The 14-bit AD7244, from \$17.95; 12-bit AD7242, from \$14 (100).

**Analog Devices**, 181 Ballardvale St, Wilmington, MA 01887. Phone (617) 937-1428. **Circle No. 387**



# UXART

## The Wait Is Over.

Now there's a serial I/O chip designed for UNIX.

For years, dumb UARTs have been the standard datacom solution. Now there's something better for today's multi-user, multi-protocol datacom environment. Our single-chip solution gives you multiple channels — each capable of full-duplex operation at 115.2 kbps — and replaces up to 10 chips.

Cirrus Logic introduces the UXART — the first and only UART with specific features to simplify and speed up serial I/O efficiency by a factor of ten or more. So your UNIX® system can support more users, with better response time — and less waiting.

The CL-CD1400 UXART™ gives you 4 fully independent datacom channels, each capable of full-duplex operation at 115.2 kbps. Each channel has two 12 byte FIFOs, one for transmit and one for receive. Separate vectored interrupts allow quick entry to the correct service routine.

A number of features reduce the load on the host system. Automatic expansion of Newline to CRNL, plus other CR and NL options. User-definable flow control characters for automatic flow control.

All five types of UNIX-specified parity and error handling. And more.

For high-line-count, cost-effective applications, there's the CL-CD180. It offers performance gains similar to the CL-CD1400, plus the advantage of 8 channels in a single 84-pin package.

The CL-CD2400 adds synchronous capabilities. It offers 4 independent, multi-protocol channels, plus an on-chip DMA controller for fast, efficient I/O.

For all your multi-protocol, multi-user datacom needs, the Cirrus Logic family of intelligent, high-performance data communications controllers gives you superior throughput in less space — with less waiting.

Don't wait. Call today for *free* product information and benchmark report on the CL-CD1400. **Call 1-800-952-6300. Ask for dept. LD25**

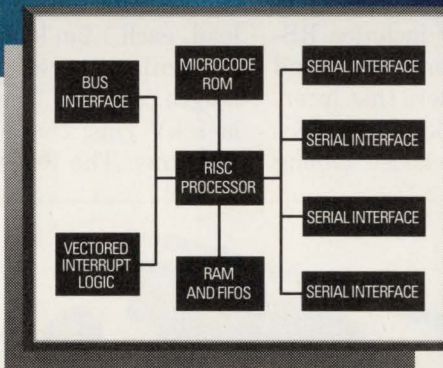

An on-chip 10 MIPS RISC-based processor handles transmit and receive functions, buffer management, flow control, and all special character processing. On-chip FIFOs reduce host interrupts to give you more efficient interrupt handling. The result: faster system throughput, lower host overhead, and less waiting.

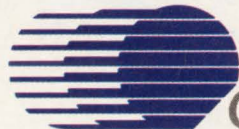

CIRRUS LOGIC

C L O S I N G   T H E   G A P

©1991 Cirrus Logic, Inc., 3100 West Warren Avenue, Fremont, CA 94538 (415) 623-8300; Japan: 462-76-0601; Singapore: 65-3532122; Taiwan: 2-718-4533/4534; Germany: 81-52-2030/6203  
© Cirrus Logic, and the Cirrus Logic logo and UXART are trademarks of Cirrus Logic, Inc. All other trademarks are registered to their respective companies.



# NEW PRODUCTS

## TEST & MEASUREMENT INSTRUMENTS

### 191-MHz FFT Spectrum Analyzer

- Has 90-dB dynamic range
- Includes MS-DOS-compatible 3 1/2-in. floppy-disk drive

The SR760 is an FFT spectrum analyzer that covers frequency spans of 100 kHz to 191 MHz with a dynamic range of 90 dB. Line widths range from 476  $\mu$ Hz to 250 Hz. Real-time bandwidth is 50 kHz. In dual-trace mode, you can view a time record and a spectrum simultaneously. The unit incorporates a 16-bit A/D converter and a 3 1/2-in. floppy-disk drive that stores 720k bytes of data and setups in MS-DOS format. The analyzer includes RS-232C and IEEE-488 interfaces, and it directly drives plotters that interpret the Hewlett-Packard Graphics Language. You can choose among

the following windowing functions: Blackmun-Harris, flat-top, Hanning, and force exponential. \$4350.

**Stanford Research Systems Inc.**,  
1290 D Reamwood Ave, Sunnyvale,  
CA 94089. Phone (408) 744-9040.  
FAX (408) 744-9049. TLX 706891.

Circle No. 388

### Silicone-Rubber Multimeter Lead Set

- Rated for 1 kV and 10A rms
- Accepts push-on probes and accessories

The STLS 2000 lead set for multimeters includes a red and a black lead, each 1.2m long. The TLS 2000 is similar, except that the lead length is 1.5m. The voltage rating is 1 kV rms; the current rating is 10A rms. The leads are supple be-

cause the wire in each lead consists of more than 700 strands; moreover, the insulation is soft silicone rubber. The leads have banana plugs at each end. The plugs, which accept push-on probes and accessories, incorporate spring-loaded, retractable shields. \$19.95.

**Test Probes Inc.**, 9178 Brown Deer Rd, San Diego, CA 92121.  
Phone (800) 368-5719.

Circle No. 389

### RS-232C-Interfaced Device Programmer

- Works with computers of any type
  - For PROMs, EPROMs,  $\mu$ Cs, EEPROMs, PLDs, and EPLDs
- The Allpro-S device programmer works with any computer that

# FACT:

## Parylene Protects Delicate Sensors Best

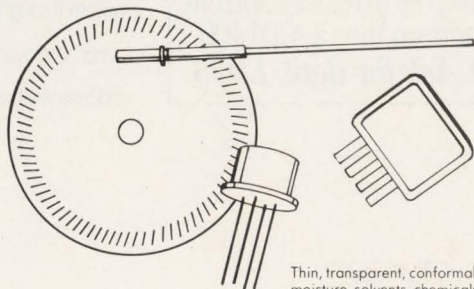

Thin, transparent, conformal, resists moisture, solvents, chemicals, adds minimal mechanical loading.

Vacuum-deposited parylene conformal coating provides a pinhole-free barrier against moisture, chemicals, vapors and other potential threats to sensor performance. This ultra-thin, inert and transparent coating evenly covers flat or irregular surfaces, minute apertures and sharp edges. Its low mass has minimal mechanical effect on delicate sensors.

Parylene has a dielectric strength of 5KV/mil. It is free of VOCs, environmentally safe, and proven in military, medical, automotive, computer and industrial applications. Call for application consultation.

**NOVA TRAN CORPORATION.**

100 DEPOSITION DRIVE  
CLEAR LAKE WI 54005  
715/263-2333/FAX 715/263-3189  
**1-800-554-1697**

UNION CARBIDE Subsidiary of Union Carbide Corporation  
Copyright © 1991 Nova Tran Corporation



# CONSISTENT QUALITY. TECHNICAL EXCELLENCE. AVAILABILITY.

It's all here at C&K. The broadest line of miniature and subminiature electro-mechanical switches in

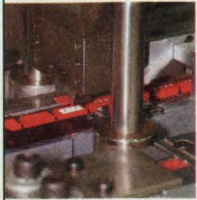

the world. More choices, more options. More attention to your needs. More and better solutions to your switching problems. Two-week delivery on typical models. Literally millions of different switch configurations—surface mount, through-hole and solderable types are available. Plus the ability to design and build the application-specific switch that meets your exact requirements.



Choose from our feature-rich family of process-compatible

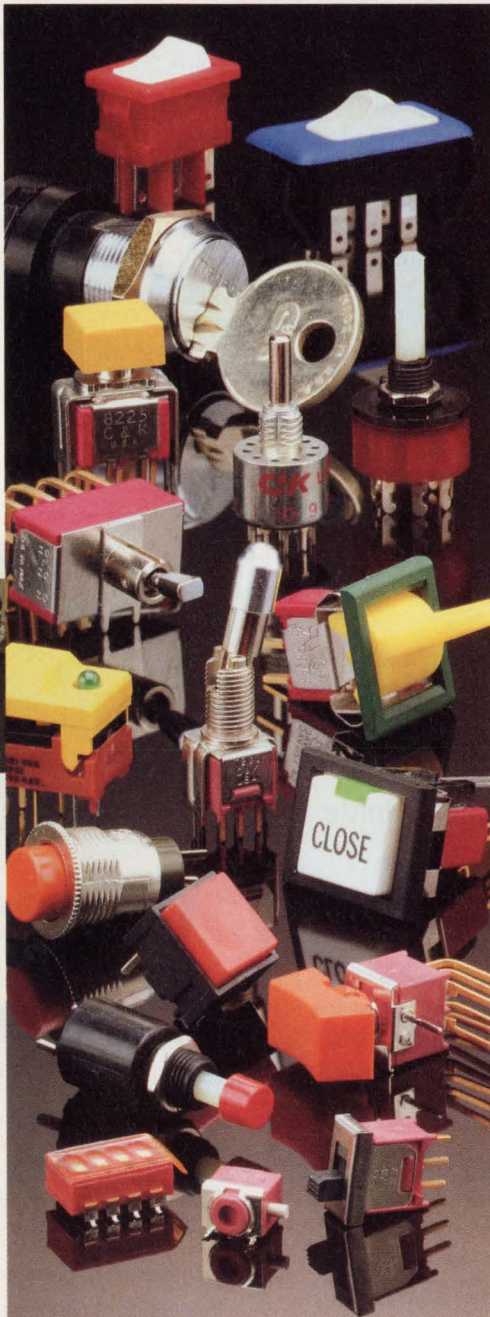

switches sealed to withstand today's high soldering temperatures and pressure wash cleaning methods. Our Six Sigma design capabilities, MRP-2 production techniques, cellular manufacturing and Kanban inventory control methods increase quality, cut costs and get you to market faster with a better product.

It's all here. Free samples and more information than you'll ever use.

At C&K.  
Send for our  
new Catalog.



## C&K<sup>®</sup>

The Primary Source Worldwide<sup>®</sup>

C&K Components, Inc. 15 Riverdale Avenue Newton, MA 02158-1082 Tel: (800) 635-5936 Fax: (617) 527-3062	C&K Components, Inc. 2035 Highway 70 East Clayton, NC 27520-0687 Tel: (800) 334-7729 In NC: (800) 672-8209 Fax: (919) 553-4758
--	---

INTERNATIONAL MFG. FACILITIES:  
USA, Hong Kong, England, Costa Rica  
Representation Worldwide.

See Us at Electro-Booth 2222-2224







has an RS-232C port. The instrument handles PROMs, EPROMs, EEPROMs, PLDs, EPLDs, and single-chip microcomputers. It adapts to all devices via software; there are no plug-in adapters. Users of the vendor's IBM PC-based programmers can turn those units into the equivalent of the new programmer by adding a chassis that includes an RS-232C port, a 3½-in. floppy-disk drive, and a processor based on an 8088  $\mu$ P with 256k

bytes of memory. Upgrades to 640k bytes are possible. \$5995.

**Logical Devices Inc**, 1201 NW 65th Pl, Fort Lauderdale, FL 33309. Phone (800) 331-7766; in FL, (305) 974-0967. FAX (305) 974-8531.

Circle No. 390

### In-Circuit Emulator For MC68EC030

- *Displays coprocessor registers in floating-point format*
- *Can include event-triggering system*

The EL 3200 in-circuit emulation system now supports the MC68EC030  $\mu$ P. Features include support of cache-burst and single-cycle modes; symbolic and source-level debugging; and 33-MHz, zero-wait-state, high-speed overlay memory for normal bus cycles. The trace and event system includes access breakpoints; software and

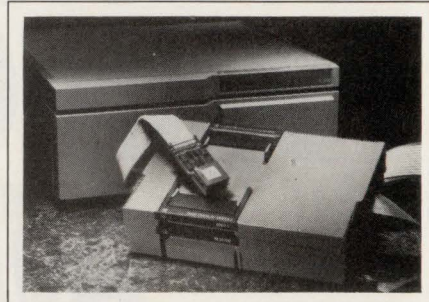

hardware execution breakpoints; complex-event comparators; trigger inputs and outputs; counters; timers; and flags. The emulator communicates with its host via Ethernet using TCP/IP. Hosts are IBM PCs, Sun 3s, SPARCstations, DECstation 3100s, and VAX/VMS systems. From \$30,000; trace and event system from \$10,000. Delivery, eight weeks ARO.

**Applied Microsystems Corp**, Box 97002, Redmond, WA 98073. Phone (800) 426-3925; in WA, (206) 882-2000. Circle No. 391

**It's Here.  
It's Free.**

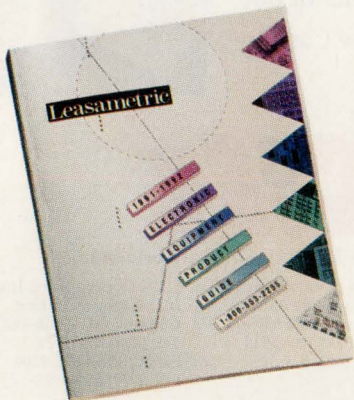

### The 1991/92 Electronic Equipment Product Guide

Choose from over 100 top manufacturers - Hewlett-Packard, Tektronix, Sun Microsystems

- ▶ \$100 Million Inventory
- ▶ Rent, Lease, Buy
- ▶ Overnight Delivery

For a FREE copy of the 1991/92 Electronic Equipment Product Guide, phone toll-free:

**1-800-553-2255**

In Canada call:

**1-800-268-6923**

### Leasametric, Inc.

Electronic Equipment-Renting, Leasing, Sales and Service  
A member of the Marmon Group of companies



## PEARSON

Wide Band, Precision

# Current Monitor

With a Pearson current monitor and an oscilloscope you can make precise amplitude and waveshape measurement of ac and pulse currents from milliamperes to kiloamperes. Currents can be measured in any conductor or beam of charged particles, including those at very high voltage levels.

A typical model gives an amplitude accuracy of +1%, -0%, 20 nanosecond rise time, droop of 0.5% per millisecond, and a 3 db bandwidth of 1 Hz to 35 MHz. Other models feature 2 nanosecond rise time, or a droop as low as 1% per second.

Contact us and we will send you engineering data.

## PEARSON ELECTRONICS, INC.

1860 Embarcadero Road, Palo Alto, Calif. 94303, U.S.A.  
Telephone (415) 494-6444 · Telex 171-412 · FAX (415) 494-6716



# EPSON

THE CRYSTALMASTER™

leads new  
crystal oscillator  
technologies into  
the 90's with...

the most cost effective hi-temp  
SMD crystals and oscillators and  
low cost plastic thru-hole crystal  
oscillators.



## EPSON SURFACE MOUNT CRYSTALS AND OSCILLATORS

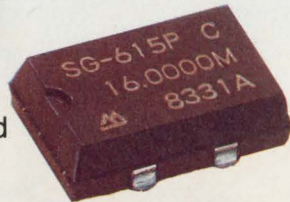
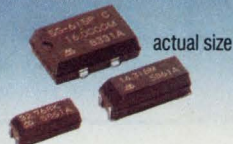

Epson has pioneered the first truly heat resistant crystal for use in its surface mount crystals and crystal oscillators. Capable of withstanding 260°C for 20 seconds... far above the demands of standard IR and vapor phase reflow processing systems... these labor-saving high-temp SMD crystals have become the accepted standard for surface mount crystal and oscillator components.

**MODEL SG-615 OSCILLATOR**  
Frequency: 1.5 to 66.7 MHz  
Symmetry: 45/55 (TYP)  
Rise/Fall Time: 5 nsec (TYP)  
Tristate: Available  
Compatible Technology: CMOS and TTL  
Op. Temp. Range: -40°C to 85°C

**MODEL MA 505/506 CRYSTAL**  
Frequency: 4.00 to 66.7 MHz

**MODEL MC-405 CRYSTAL**  
Frequency: 32.768 KHz

**EPSON®** EPSON AMERICA, INC.  
Component Sales Department Telephone: 213/787-6300

## EPSON THRU-HOLE OSCILLATORS REPLACE METAL CAN OSCILLATORS

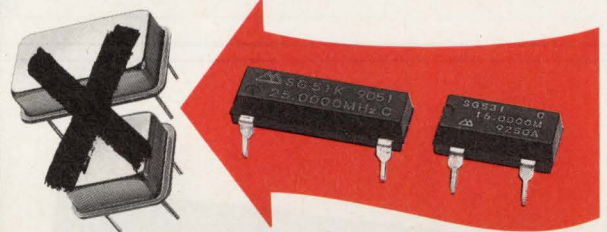

Epson has introduced the first plastic low cost, high performance auto-insertable thru-hole crystal oscillator. Its unique hermetically sealed crystal, embedded in a plastic package, gives the same EMI protection and higher performance than metal can oscillators... at a much lower cost. And, the auto-insertion feature reduces manufacturing costs associated with hand inserting metal cans... into standard full-size or half-size hole patterns.



**MODEL SG-51/SG-531  
OSCILLATOR**

Frequency: 1.5 to 66.7 MHz  
Symmetry: 45/55 (TYP)  
Rise/Fall Time: 5 nsec (TYP)  
Tristate: Available  
Compatible Technology: CMOS and TTL

**EPSON®** EPSON AMERICA, INC.  
Component Sales Department Telephone: 213/787-6300

### CALL YOUR SALES REP TODAY

EPSON Sales Representatives: AL-GA-TN Concord Components 205/772-8883 • AZ-NM Fred Board Assoc. 602/994-9388 • CA-No. Costar 408/446-9339 • CA-So. Bager Electronics 714/957-3367 • CO-UT Wn. Region Mktg. 303/428-8088 • FL Dyne-A-Mark 407/831-2822 • IL-WI LTD Technologies 708/773-2900 • IN-KY C C Electro 317/921-5000 • KS-MO-IA Microtronics 913/262-1444 • MA-NH-CT Rosen Assoc. 617/449-4700 • MD-VA Tech Sales Assoc. 301/461-7802 • MN Electro Mark 612/944-5850 • NC-SC WLA Assoc. 919/231-9939 • NJ JMR Sales 201/525-8000 • NY Elcom Sales 716/385-1400 • Metro, NY Niktronix 516/929-4671 • OH-MI J. D. Babb Assoc. 216/934-4454 • OR-WA Matrex 503/245-8080 • PA Omega Sales 215/244-4000 • TX-OK Component Tech. 214/783-8831 9101



# HIGH FIN DENSITY HEAT SINKS REDUCE SIZE and COST

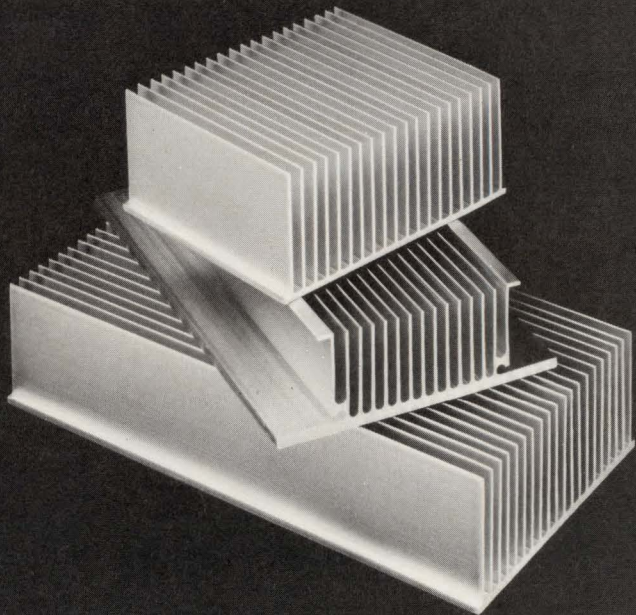

**EG&G WAKEFIELD ENGINEERING**

60 AUDUBON ROAD, WAKEFIELD, MA 01880  
TEL: (617) 245-5900 • FAX: (617) 246-0874

Western U.S. Sales Office • 3777 RUFFIN ROAD, SAN DIEGO, CA 92133  
TEL: (619) 279-2253 • FAX: (619) 576-9286

Achieve maximum heat transfer efficiency with EG&G Wakefield Engineering High Fin Density heat sinks for power-generating components. Our 510, 511, and 512 Series standard heat sinks yield the same thermal performance as other heat sinks needing nearly *twice* as much space.

Designed for cooling isolated power modules, amplifiers, and other power-generating components, these heat sinks are manufactured with a unique process which we developed to maximize the surface area available — to yield 130 sq in. of cooling surface per linear inch of extrusion!

### Available Now

Standard heat sinks in three different profiles and several lengths are available now from stock.

### Lower Cost

Because of the substantial material savings with these unique designs, our High Fin Density heat sinks save on weight and cost per unit volume. The weight savings is approximately 60%!

*Call our Sales Department today for the name of our stocking distributor nearest you, at (617) 245-5900.*

CIRCLE NO. 60

## LET US BE YOUR PACKAGING PARTNER

*Good Service  
is not as  
simple as  
black & white!*

ACT is an **ideal packaging partner** for you, because we are completely committed to increasing your competitive edge by reducing your interconnect costs and improving reliability.

ACT offers:

- early technical assistance
- state of the art interconnects
- quality products delivered on time
- after sales service including order tracking and cost reduction workshops

For additional information, call or write:



**Advanced Circuit  
Technology**

118 Northeastern Blvd. Nashua, NH 03061  
Tel: 603/880-6000 Fax: 603/880-1785

180

CIRCLE NO. 43

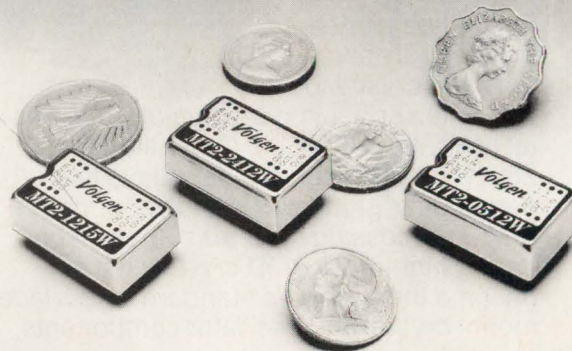

## MT2W SERIES

Miniature DC—DC Converters

Total Output Power: 2 Watts

Input Voltages: 5, 12 & 24 VDC

Output Voltages: Single & Dual  
5, 12 & 15 VDC

Input/Output Isolation to 500VDC

2 year warranty

- Metal Encapsulated
- Miniature DIP Package
- No Heatsinking/derating required.
- Direct PCB Soldering
- Low Output Ripple & Noise

**Volgen**

QUALITY FIRST

- Short-Circuit Protection
- Internal EMI Filter
- High Efficiency
- Competitively Priced

Volgen America Inc. 39650 Liberty Street, #325, Fremont, CA 94538  
(415) 498-5950 • Fax (415) 498-5954

CIRCLE NO. 42



# A

## Advertising Strategy.

### New System HILO 4

Announce new System HILO 4 to design engineers and managers.

Be sure they know...

- ✓ it enhances design productivity through Language Driven Design.
- ✓ its FASTCELL™ ASIC libraries simulate sub-micron technology accurately. And up to eight times faster than traditional gate-level modeling while using less memory.
- ✓ it outperformed golden simulators in accuracy in several benchmarks at ASIC foundries.
- ✓ it's the ideal core simulation toolkit to support a concurrent engineering environment, with simulation for logic verification, worst case timing, fault grading, and non-intrusive ATPG.

And there's much more to tell so readers should contact their local GenRad office for more about System HILO 4.

Call 1-800-4-GENRAD in the U.S., or the GenRad office nearest you in Austria, Canada, England, France, Germany, Italy, Japan, Singapore, Switzerland.

 **GenRad**  
*A New Way of Thinking*



# PCXI INDUSTRIAL COMPUTERS

We offer the advantage of an EISA industrial computer. The power and speed of 32-bit EISA capability: true multi-processing; 33 megabytes/second data transfer for bus masters and DMA; and automatic configuration of system and modules. EISA is ideally suited to support the increased I/O requirements of industrial applications, while maintaining the unique cost-to-performance advantages that industrial PC users have enjoyed. It is fully backward compatible to all XT/AT boards.

## EISA

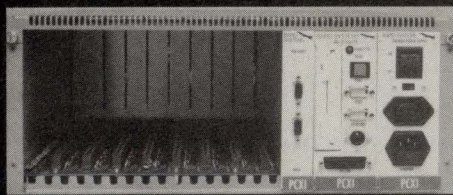

Shown here is a 386/33 EISA industrial computer, with a passive backplane providing six EISA bus master slots, one slot-specific slot and four AT slots.

But PCXI Industrial Computers are also available on the AT bus (ISA). PCXI is a modular, interchangeable, multi-vendor industrial PC. Noise, emissions, power, ground, airflow and cooling are specified and verifiable. All PC functions, from CPU (286/386/486) or power supplies, are enclosed and protected in metal-shielded modules, with front panel connectors.

Plus, PCXI gives you the best advantage of all: low cost.

**RAPID  
SYSTEMS**

433 N. 34th St., Seattle, WA 98103  
(206)547-8311 • FAX: 206-548-0322

## NEW PRODUCTS

### COMPUTERS & PERIPHERALS

#### Process Controller Board

- Displays control parameters on computer screen
- For programs having as many as 96 segments

The SMT-01 single-loop process controller board is a PID (proportional-integral-differential) controller. It plugs into a 16-bit ISA bus expansion slot. The board is programmable for any number of programs having as many as 96 segments each. You can display the process variable vs time along with setpoint, high and low alarms, PID parameters, and autotuning. You can store these parameters in a battery-backed RAM. A ROM-based algorithm provides thermocouple linearization. The controller accepts inputs from a thermocouple, a resistance temperature detector, a 4- to 20-mA source, a pressure transducer, and other specified inputs. Dual 4- to 20-mA control outputs are selectable from the keyboard. The board's two alarm outputs drive solid-state relays. Board, including software on a 5<sup>1</sup>/<sub>4</sub>- or 3<sup>1</sup>/<sub>2</sub>-in. disk, \$395.

**Temp Inc**, Box 929, Fairmont, WV 26554. Phone (304) 366-4088.

Circle No. 392

#### Portable Digitizer

- Features an 18×24-in. tablet
- Components fit inside the surface of the tablet

You can use the XLC/1824 portable digitizing tablet for CAD, drafting, and construction estimating. The 18×24-in. tablet lets you place components inside its surface, making it flat instead of sloped. The digitizer works with Timberline and Promation construction estimating software as well as popular CAD programs. The unit connects to an IBM PC or a compatible computer, and you can transport it from office to office. The vendor offers a choice

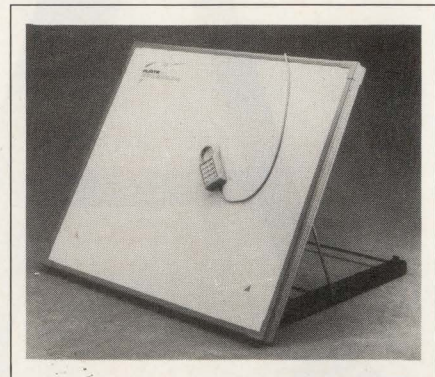

of either a corded 2-switch pen or a corded 16-key cursor with a window cross hair. The digitizer can also emulate GTCO's L Series, Calcomp 9500, Summagraphics Microgrid, and Numonics 2200 digitizing tablets. The software driver supports Microsoft mouse and Windows-compatible programs. Tablet with ±0.01-in. accuracy, \$2195; tablet with ±0.005-in. accuracy, \$3695.

**Kurta Corp**, 3007 E Chambers St, Phoenix, AZ 85040. Phone (602) 276-5533. FAX (602) 276-7823.

Circle No. 393

#### T1 Bridge/Router

- Links remote networks together as fast as 2.048M bps
- Software features IEEE-802.1 spanning-tree protocol

The ACS 4200 T1 bridge/router links remote networks together as fast as 2.048M bps. The unit operates on the company's Series 4000 multiprotocol bridge/routing software. The software routes TCP/IP, DECnet, XNS, and IPX protocols while providing a bridge to all other network protocols. The software also features the IEEE-802.1 spanning-tree protocol, automatic address learning, and dynamic and static routing. Each of the unit's two wide-area-network ports can operate at different speeds and physical connections, such as X.25 networks or T1 leased lines. You can configure the unit from a locally



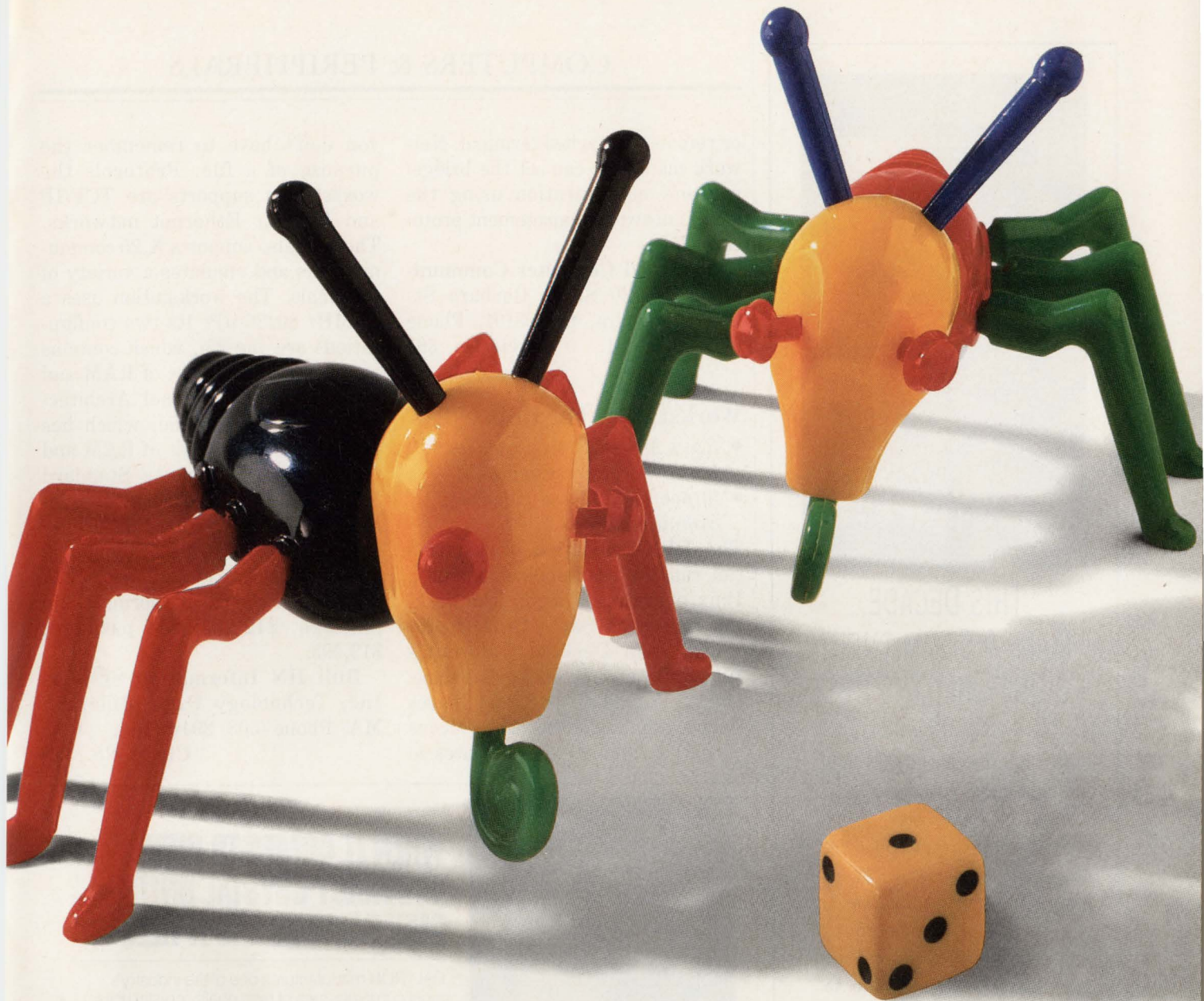

## You Don't Have To Take Chances With Bugs.

**THE LOWEST-COST XDB ROM MONITOR DEBUGGER FOR MOTOROLA 68000, 68020, 68030, 68302, 68332 AND 68340 MICROPROCESSORS.**

Every embedded microprocessor application starts off with a few bugs. But you can eliminate them without missing a beat — or a deadline. Because with InterTools XDB ROM Monitor Debuggers, you start and finish debugging sooner in actual prototype environments. XDB's powerful user-friendly interface and "smart" ROM Monitor make it the most productive debugger available. And, starting at just \$2,495, it's also the lowest priced. Call now for more information, or to order.

With InterTools, you don't have to take chances with bugs. **1-800-356-3594**  
**617-661-0072.**



**Intermetrics**

Microsystems Software, Inc.

**Make Every Bit Count**





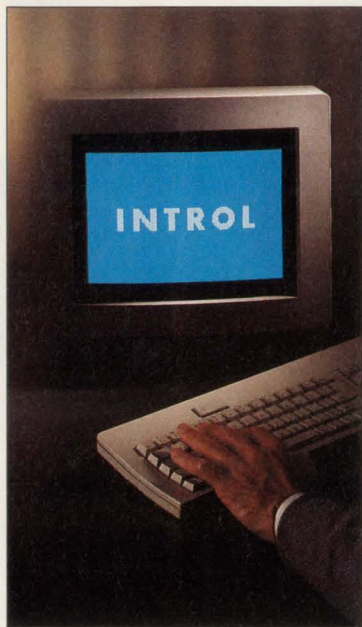

### THIS DECADE, MAKE A COMMITMENT TO USE ONLY THE BEST.

FOR TEN YEARS INTROL HAS BEEN CREATING THE WORLD'S BEST HIGH-POWERED TOOLS FOR EMBEDDED SYSTEMS PROGRAMMERS.

OUR C COMPILERS, MODULA-2 COMPILERS, SOURCE LEVEL DEBUGGERS, AND MACRO ASSEMBLERS ARE IN USE BY MAJOR CORPORATIONS AND SAVVY INDEPENDANT CONSULTANTS FROM SAN FRANCISCO TO SINGAPORE.

ALL OUR PRODUCTS ARE FULLY COVERED BY COURTEOUS AND HIGHLY EFFICIENT TECHNICAL SUPPORT TO ASSIST YOU WITH ANY PROBLEMS YOU MAY ENCOUNTER.

SO, THIS DECADE, MAKE A COMMITMENT - TO INTROL.

6801, 6301, 68HC11, 6809, 68000/  
10, 68020/30/40, 68332, 32000

MSDOS, MAC-MPW, VAX VMS/ULTRIX, DECSTATION, IBM  
RS6000, SUN3, SUN4, APOLLO, 386 UNIX SYSTEM V

INTROL CORPORATION • 9220 WEST HOWARD AVENUE  
MILWAUKEE, WI 53228

TEL 414.327.7171, FAX 414.327.7734



CIRCLE NO. 46

or remotely attached terminal. Network managers can set the bridge/router's configuration using the simple network-management protocol. \$8500.

**Advanced Computer Communications**, 720 Santa Barbara St, Santa Barbara, CA 93101. Phone (805) 963-9431. **Circle No. 394**

### Workstation For Unix

- *Runs MS-DOS programs on Unix operating systems*
- *Supports X.25 and Ethernet communications*

The DPX/Prostation workstation can run MS-DOS applications on a Unix operating system. The desktop unit runs Santa Cruz Operation's Open Desktop, Informix's WingZ, Frame Technology's Framemaker, Alfalfa's Poste, and Ingres Corp's application software. Icons connect to an array of templates so

you don't have to remember the purpose of a file. Protocols the workstation supports are TCP/IP and ISO for Ethernet networks. The unit also supports X.25 communications and emulates a variety of terminals. The workstation uses a 25-MHz 80486  $\mu$ P. Its two configurations are the 25i, which contains as much as 32M bytes of RAM and a single Micro Channel Architecture slot; and the 25e, which has as much as 64M bytes of RAM and two Extended Industry Standard Architecture slots. Each system includes a 213M-byte hard-disk drive and a 144M-byte, 3 $\frac{1}{2}$ -in. floppy-disk drive that can read and write IBM PC/AT and compatible formats. 25i package, \$12,995; 25e package, \$13,495.

**Bull HN Information Systems Inc**, Technology Park, Billerica, MA. Phone (508) 294-6616.

**Circle No. 395**

- *Crystals*
- *Crystal Oscillators*
- *Crystal Filters*
- *Ceramic Resonators*

### WHEN IT COMES TO HIGH ACCURACY CRYSTAL UNITS, ONLY RALTRON HAS IT ALL.

RALTRON manufactures one of the industry's most complete lines of high quality crystal units. Call us for all your crystal needs from micro-processor to AT strip to tuning fork to high accuracy. Or call us for our 28 page catalogue.

#### HIGH ACCURACY CRYSTAL UNITS

- Frequency Range: 1.0 MHz-360 MHz
- Mode of Oscillation: Fundamental to 9th O.T.
- Frequency Tolerance: @ 25°C:  $\pm 2.5$  ppm to  $\pm 100$  ppm
- Frequency Stability:  $\pm 3$  ppm ( $-10^{\circ}\text{C}$  to  $+60^{\circ}\text{C}$ ) to  $\pm 50$  ppm ( $-55^{\circ}\text{C}$  to  $+105^{\circ}\text{C}$ )

#### SURFACE MOUNT CRYSTAL UNITS

##### HC-45/U SMD, TT SMD, HC-49S SMD

- Frequency Range: 3.5 MHz-360 MHz
- Mode of Oscillation: Fundamental to 9th O.T.
- Frequency Tolerance: @ 25°C:  $\pm 2.5$  ppm to  $\pm 100$  ppm
- Frequency Stability:  $\pm 3$  ppm ( $-10^{\circ}\text{C}$  to  $+60^{\circ}\text{C}$ ) to  $\pm 100$  ppm ( $-10^{\circ}\text{C}$  to  $+70^{\circ}\text{C}$ )

*The Products. The Prices. The People. Only RALTRON has it all.*

### RALTRON ELECTRONICS CORP.

2315 NW 107th Avenue, Miami, Florida 33172  
FAX (305) 594-3973 TELEX 441588 RALSENU1  
(305) 593-6033

CIRCLE NO. 47



# Clean sweep to 1 GHz.

100 watts minimum is a lot of low-cost, clean rf power. But that's what our new Model 100W1000M7 delivers for your broadband test needs.

As your hunger for power and bandwidth grows, this year and next, our all-solid-state "W" series of 100-kHz-to-1000-MHz linear amplifiers should become more and more important in your plans. Today you may need only 1 watt (the little portable on the top of the pile), or 5, or 10, or 25, or 50—all with that fantastic bandwidth instantly available without tuning or bandswitching—the kind of bandwidth that lets you sweep clean through with no pausing for adjustment.

#### And next year?

Chances are good that next year you'll be moving up into higher-power work in much the same bandwidth. Then you'll be glad you have 100 watts from 100 to 1000 MHz, using the *only* rf power amplifier in its power-to-bandwidth class. At that point, your smaller "W" series amplifiers can be freed for lower-power work around your lab.

What you can't see in the performance curves shown below is the *unconditional stability* of all AR amplifiers—immunity to even the worst-case load mismatch or shorted or open cable with no fear of damage, foldback, or system shutdown.

The "W" series is part of a complete line of amplifiers offering rf power up to 10,000 watts, in cw and pulse modes, for such diverse applications as RFI susceptibility testing, NMR, plasma/fusion research, and a host of other test situations that demand the very finest in rf power.

Send for our free booklet, "Your guide to broadband power amplifiers."

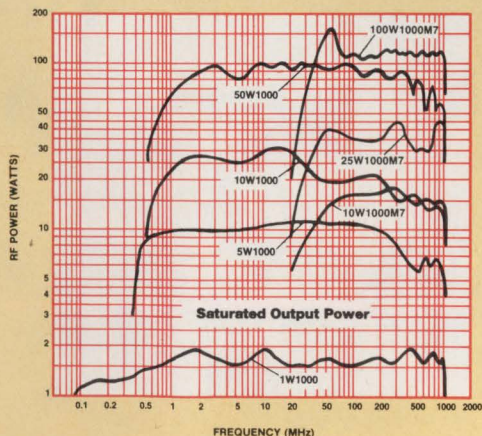

**AMPLIFIER  
RESEARCH**

160 School House Road  
Souderton, PA 18964-9990 USA

For engineering assistance, sales, and service throughout Europe, call

EMV GmbH (Germany)  
89-612-8054

EMV Ltd (United Kingdom)  
908-566556

EMV S.A.R.L. (France)  
1-64-61-63-29

CIRCLE NO. 143

1313



## The New STD Bus...

...Why was it written about more in the last year, than any year since 1980?

...Why is it better than other bus structures for

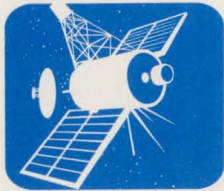

applications  
in  
space,

in the  
ocean  
depths,



and out  
in the  
desert?

The fact is, The STD Bus provides powerful technology in economical, modular, reliable and extremely rugged systems.

That's why it's used in tens of thousands of machines and processes worldwide.

The 100+ manufacturers of STD Bus products provide a full selection of 8, 16 and 32 bit processors on single board computers and in fully packaged systems. The STD Bus is supported by the widest range of industrial I/O of any computer bus.

Find out what the excitement's about. Write  
STD Manufacturer's Group  
1838 Coastland Ave,  
San Jose, CA 95125

...or call the following  
manufacturers directly:

Analog Devices	617-326-6666
Computer Dynamics	803-877-8700
Cubit Division, Proteus Industries	415-962-8237
Matrix Corporation	919-231-8000
Micro-Alde	818-915-5502
Micro/Sys	818-244-4600
Mizar Digital Systems	800-635-0200
Octagon Systems Corp.	303-430-1500
Pro-Log Corporation	800-538-9570
Robotrol Corporation	408-683-2000
Teknor Microsystems	514-437-5682
Versalogic	800-824-3163
WinSystems	817-274-7553
XYZ Electronics	800-852-6822
Zlatech Corporation	805-541-0488

CIRCLE NO. 48

## COMPUTERS & PERIPHERALS

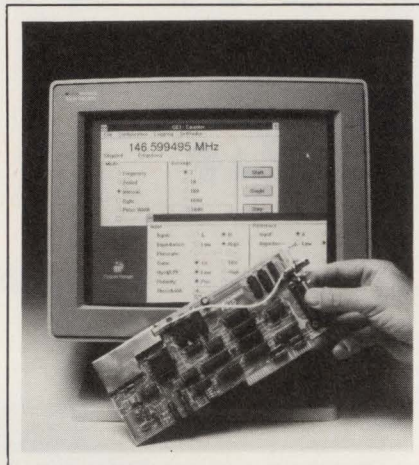

### Universal Counter/Timer Card

- Uses Windows 3.0 as a control panel and display window
  - Operates from 10 Hz to 2.4 GHz
- The Model PC-10 universal frequency counter/timer operates from 10 Hz to 2.4 GHz. The IBM PC-compatible plug-in card uses Windows 3.0 as a control panel and dis-

play window. The unit captures and analyzes discrete and average frequency readings, pulse widths, time intervals, and the ratio between two frequencies. The card's 200-MHz CMOS ASIC and three bipolar monolithic microwave ICs reduce the parts count to 23 ICs. The unit operates as a self-tuning radio, and when the frequency scanning is too slow, it can tune a companion receiver. The card's minimum sensitivity is 10 mV. The unit displays the frequency with 10-digit resolution. The unit's input-gate is continuously variable from 1 msec to 28 sec for optimum balance between time and resolution. The temperature-compensated crystal oscillator has a  $\pm 1$ -ppm resolution. \$335.

**Optoelectronics Inc.**, 5821 NE 14th Ave, Fort Lauderdale, FL 33334. Phone (800) 327-5912; in FL, (305) 771-2050. FAX (305) 771-2052. **Circle No. 396**

## THE PICTURE IS PERFECTLY CLEAR!

### PILLAR/Cycle-Dyne can reduce your CRT production costs.

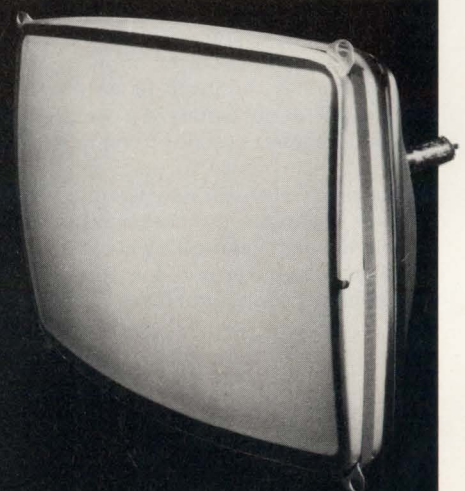

Four Induction Heating processes that can improve productivity and product quality in the manufacturing of

Cathode Ray Tubes:

- Getter Flashing
- Outgassing
- Shrink Band Heating
- Stud Welding

Contact the people  
where American Technology is at its best.

N92 W15800 Megal Drive  
Menomonee Falls, WI 53051  
414-255-6470 FAX: 414-255-0359

 **PILLAR** / Cycle-Dyne

CIRCLE NO. 49





Your business is safe with us.

Through all of its ups and downs.



We'll help you keep your business rolling. With our 4 megabyte diskettes and 3M Magnus™ 1.35 data cartridges you have a whole new generation of data storage media for high capacity systems. So, whatever format or capacity your data is stored in, we're ready when you are.

That's why more business protects important information on 3M brand diskettes and data cartridges than any other brand in the world. Call 1-800-888-1889 ext. 4 to find out more.

Innovation working for you™

Diskettes and data cartridges require compatible drives. ©3M 1991. Magnus is a trademark of 3M.





# If you can see it, we can print it.

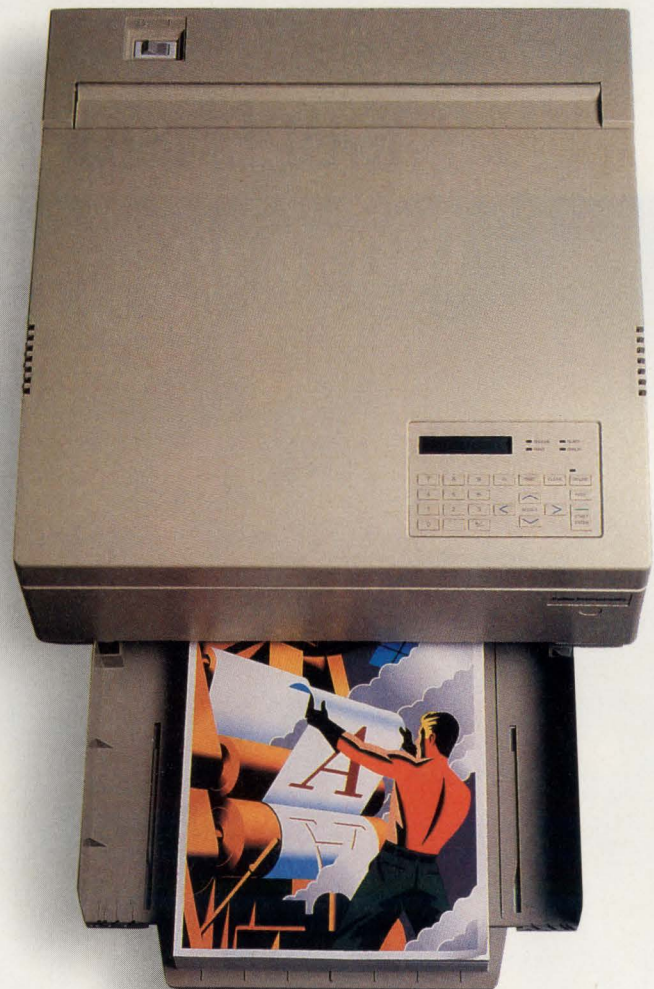

No matter what application you're using, no matter what monitor you're viewing it on, the CH5500 video color printer can produce a hard copy. It supports over 350 video sources—more than any other printer.

Moreover, since the CH5500 doesn't use software, it captures your image fast—so you can get back to work. And it offers outstanding 300 dpi quality in both A and B sizes.

To find out more, give us a call at 1-800-873-4561, Dept. SI-C4.

After all, we pioneered video color printing. And we still do it best. Anybody can see that.

**SII**   
Seiko Instruments



# FREE POWER SUPPLY CATALOG

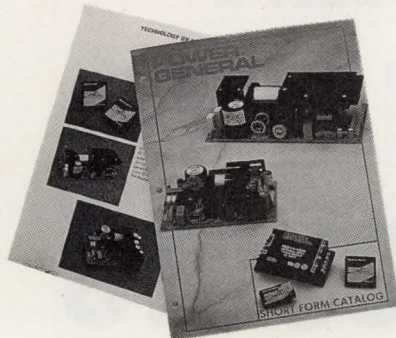

Power General's new 20 page catalog provides electrical and mechanical specifications for a full line of switching power supplies and DC/DC converters. Included are 25 to 150 watt single and multiple output AC/DC switchers; over 200 DC/DC models ranging from 1 to 100; and products approved to UL544. Typical product features include:

#### AC/DC Switchers

- Universal Input Voltage Range
- VDE/FCC Class "B" Input Filters
- UL/CSA/VDE Safety Approvals
- UL 544 Approvals (medical)
- Ultra-High MTBF's

#### DC/DC Converters

- Wide Model Selection
- 1 to 100 Watts
- Industry Standard Pin-Outs
- Ultra-High MTBF's
- 5 Year Warranty

Power General manufactures these products in the USA (Canton, MA). The latest manufacturing technologies are used on our statistical process controlled, JIT production lines to insure repeatable quality and timely delivery.

Put  
**Power General**  
To Work For You!

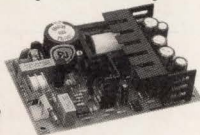

# POWER GENERAL

152 Will Drive, P.O. Box 189, Canton, MA 02021  
(617)828-6216 TWX: 710-348-0200  
FAX: 617-828-3215

CIRCLE NO. 51

EDN April 11, 1991

## LITERATURE

### Listing Of Scientific Software Programs

The 1991 Cosmic Software Catalog provides a comprehensive listing of program abstracts for approximately 1200 scientific programs that are available in the US. It also lists more than 900 programs for limited distribution. Each abstract explains the program's capabilities and presents the programming language, machine requirements, size, and price of the source code and supporting documentation. The printed and microfiche catalogs provide a keyword index, and the disk versions have a search menu. NASA's Technology Utilization Program makes these computer programs available for re-use by domestic industries, governmental agencies, and universities. \$25 to \$60.

Cosmic, University of Georgia,  
382 E Broad St, Athens, GA 30602.

INQUIRE DIRECT

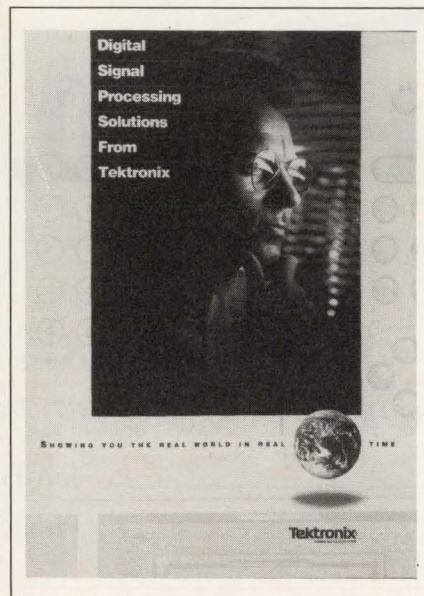

### Brochure About Digital-Signal Processing

This 8-pg pamphlet presents DSP-based solutions for high-end signal-analysis applications in military/signal intelligence, research physics, and satellite communications. It contains application notes and ex-

## Technical calculations made easy!

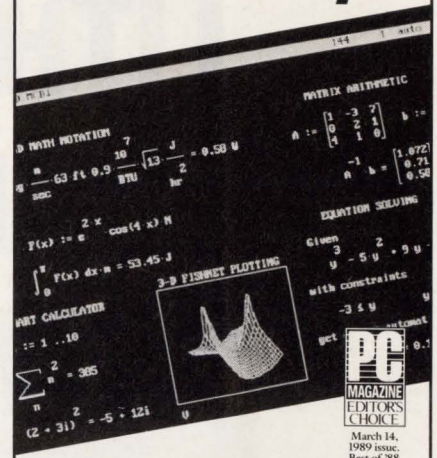

### Perform engineering and scientific calculations faster... and with fewer errors.

- **MathCAD 2.5** does your numerical analyses quickly, easily... and inexpensively! The live document interface™ lets you integrate equations, text, and graphics on your computer screen. You can see what you solve... and update your equations and graphs with a single keystroke.
- **You do the thinking while MathCAD does the work.** MathCAD picks up where calculators and spreadsheets leave off. With over 120 commonly-used functions built-in, MathCAD can handle your formulas, exponentials, differentials, cubic splines, FFTs, and matrices.
- **Applications Packs** customize MathCAD to your work. Seven different packs are available for electrical, mechanical, and chemical engineering and other technical applications.
- **MathCAD works on your PC, Macintosh, or UNIX workstation.** More than 100,000 engineers and scientists are already using MathCAD to turn their computers into powerful workstations that can handle virtually any technical application.

### Call 800-MathCAD, ext. 335 to request a free demo disk!

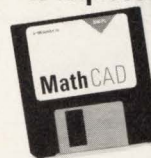

In Massachusetts, call 617-577-1017, ext. 335.

For a free MathCAD Introductory Kit, clip this coupon and mail it back to us. Or circle your reader service card.

Yes! Tell me more about MathCAD!

Name \_\_\_\_\_

Title \_\_\_\_\_

Company \_\_\_\_\_

Address \_\_\_\_\_

City \_\_\_\_\_ State \_\_\_\_\_ Zip \_\_\_\_\_

Phone (\_\_\_\_) \_\_\_\_\_

**MathSoft, Inc.**  
201 Broadway  
Cambridge, MA 02139  
Tech/EDN990 #13 EDN 4/11/91

CIRCLE NO. 52

191





# NO OTHER LITHIUM BATTERY MANUFACTURER POWERS AS MANY DIFFERENT PRODUCTS AS EAGLE-PICHER. PERIOD.



## Get The Fax!

Fill Out This Card And Fax It To (417) 776-2257

EDN 4/11/91

Name \_\_\_\_\_ Job Title \_\_\_\_\_

Company \_\_\_\_\_ Phone \_\_\_\_\_

Address \_\_\_\_\_

Have A Rep Call     Send Me Information     Commercial     Military     Both



## EAGLE PICHER

Electronics Division (Lithium Batteries)

Military: P.O. Box 47 • Joplin, MO 64802 • (417) 623-8000 • Commercial: P.O. Box 130 • Seneca, MO 64865 • (417) 776-2256



## LITERATURE

planations on pulsed radar, frequency-shift keying, and other measurements. The publication describes the VMEbus-based analysis systems that have amplitude-vs-frequency; spectrogram; and phase-and view-limits color displays.

**Tektronix Federal Systems Inc,**  
Box 4495, MS 38-386, Beaverton,  
OR 97076. **Circle No. 397**

### Guide To Components For Signal Processing

The 116-pg 1991 *Short Form Designer's Guide* covers data converters; amplifiers; analog signal-processing devices; transducers; disk-drive components; voltage references; and data-acquisition subsystems. Inside the front cover you'll find instructions on how to use the book, followed by an example of the selection-guide organization. The New Products section contains nu-

# RS-422

- RS-422/485
- Selectable Address/IRQ
- Two/Four Wire Operation
- One/Two/Four Port Versions
- Delivery From Stock

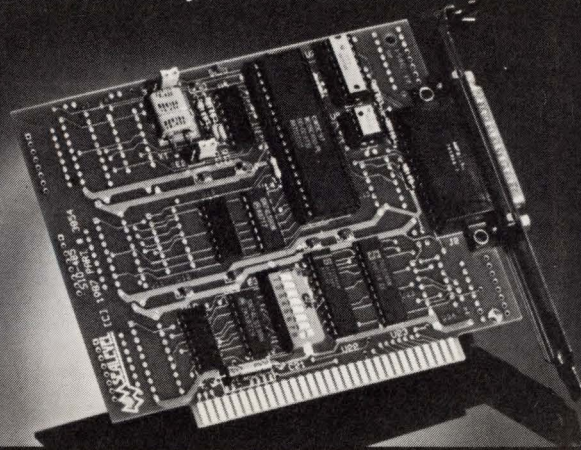

**SEALEVEL**

SEALEVEL SYSTEMS INC.  
PO BOX 1808  
EASLEY, SC 29641  
**(803) 855-1581**

CIRCLE NO. 54

## UNIVERSAL INPUT SWITCHING POWER SUPPLIES

### FEATURING:

- 90-264 VAC (continuous) UNIVERSAL INPUT
- FCC CLASS 'B', VDE 0871 'B' OPTIONAL
- HIGH SURGE CURRENTS ON +12V OUTPUTS
- PRICE, DELIVERY AND QUALITY

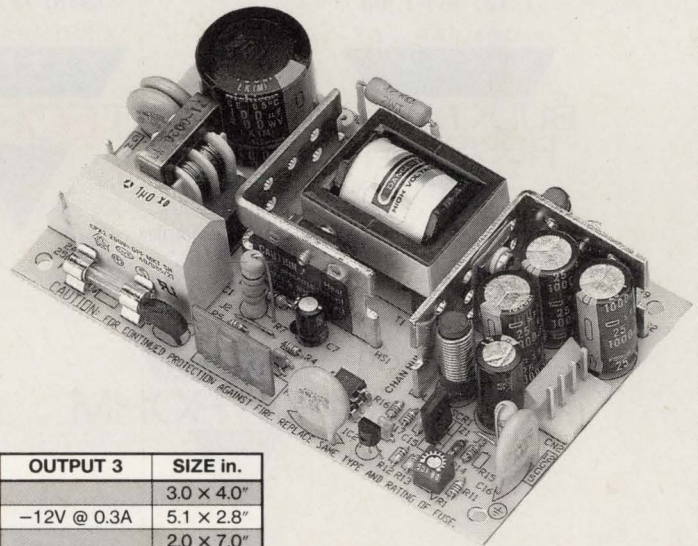

WATTS	MODEL NUMBER	OUTPUT 1	OUTPUT 2 (Peak)	OUTPUT 3	SIZE in.
20	UPS20 - 5002	+5V @ 1.6A	+12V @ 1.0A (2.0)		3.0 x 4.0"
30	UPS30 - 4003	+5V @ 1.5A	+12V @ 1.5A (3.0)	-12V @ 0.3A	5.1 x 2.8"
40	UPS40 - 1002	+5V @ 3.0A	+12V @ 2.0A (4.5)		2.0 x 7.0"
40	UPS40 - 2002	+5V @ 3.0A	+12V @ 2.0A (4.5)		3.0 x 5.0"
40	UPS40 - 2003	+5V @ 3.0A	+12V @ 2.0A (4.0)	-12V @ 0.3A	3.0 x 5.0"
50	UPS50 - 1002	+5V @ 3.0A	+12V @ 3.0A (5.5)		2.0 x 7.0"
50	UPS51 - 2002	+5V @ 4.0A	+12V @ 3.0A (5.5)		3.0 x 5.0"
65	UPS65 - 1002 -X	+5V @ 3.5A	+12V @ 4.0A (7.0)		3.5 x 6.0"
65	UPS65 - 1003	+5V @ 6.0A	+12V @ 2.5A (4.0)	-12V @ 0.5A	3.5 x 6.0"

SINGLE AND QUAD OUTPUT  
MODELS ARE AVAILABLE.

**AR** **AUTEC  
POWER  
SYSTEMS**

CALL NOW...

**818-341-6123**

9301-101 JORDAN AVENUE  
CHATSWORTH, CA 91311  
FAX: 818-341-5726



# READY

## To Help You Grow

We're the Vishay Electronic Components Group (VECG). Six well-known companies now linked with a common purpose: Making you more competitive. One call to the factory or your VECG Representative gives you access to the widest range of passive components available from any single organization.

Commercial to ultra-precise. Standard to special. One call lets you focus on the combined strengths of our multiple technologies and multiple production sources. VECG: Organized to save you time...make planning more precise...development time shorter and delivery more reliable. That's easy to say. Now make us prove it.

V I S H A Y

ELECTRONIC  
COMPONENTS

Precision Bulk Metal Foil:

- Resistors
- Trimmers
- Networks
- Chips
- Surface Mount Components
- Specials

(215) 644-1300

A COMPANY OF  
V I S H A Y

BULK METAL<sup>®</sup>  
RESISTORS

- Military Trimmers
- Custom Networks

(818) 781-1642

A COMPANY OF  
V I S H A Y

TECHNO

- Thin Film Resistors
- Thick Film Chip Resistors
- Surface Mount Components: Thick Film, Thin Film and Foil

(716) 283-4025

A COMPANY OF  
V I S H A Y

OHMTEK

- Metal Film Resistors, Hermetically Sealed
- Power Rheostats

(301) 739-8722

A COMPANY OF  
V I S H A Y

ANGSTROHM

- Wirewound Resistors, Precision and Power
- Foil Resistors
- Shunts
- Surface Mount Components

(303) 242-0810

A COMPANY OF  
V I S H A Y

ULTRONIX

- Wirewound Resistors
- Metal Film Resistors
- Resistor Networks
- Trimmers
- Thermistors
- Inductors
- Transformers
- Oscillators
- Connectors
- Displays
- Surface Mount Components

(402) 563-6417

A COMPANY OF  
V I S H A Y

DALE<sup>®</sup>



# RUGGED PC-BUS SOLUTIONS

## for Rack, Bench, or Embedded Use

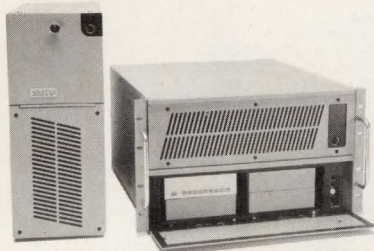

**12 or 20-slot Computers**  
Up to 6 Drives, 375Watts of Power



**All-in-One Systems**  
7-slot VGA with Touchscreen

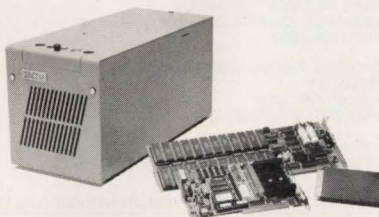

**Compact Computers/Cards**  
Embedded PC/AT Designs, CPUs,  
EPROM and RAM Cards

Over 30 different models to choose from. Custom designs are available.



Systems Manufacturing Technology, Inc.  
1080 Linda Vista Drive  
P.O. Box 1320  
San Marcos, CA 92079  
(619) 744-3590 • FAX: (619) 471-1153  
(800) 648-6262

CIRCLE NO. 55

## LITERATURE

merous additions to the vendor's line of products.

Analog Devices, Box 9106, Norwood, MA 02062. Circle No. 398

### Booklet Highlights VXIbus

This 32-pg brochure, *Feeling Comfortable with VXIbus*, introduces you to VXIbus, its features, and advantages. The publication explains how you can integrate VXIbus products in current test systems, and it discusses the tradeoffs in selecting various VXIbus devices. The publication is an overview of VXIbus technology rather than a manual for a particular VXIbus instrument. For more detailed technical information, the brochure provides a recommended-reading list.

Hewlett-Packard Co, Box 10301, Palo Alto, CA 94303.

Circle No. 399

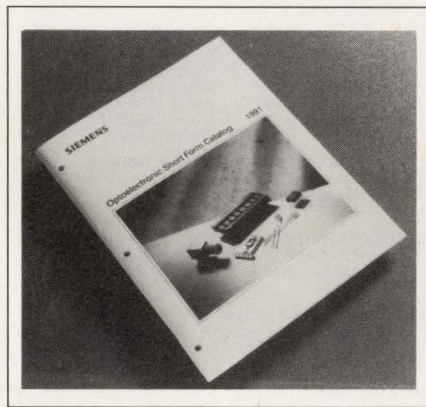

### Publication Catalogs Optoelectronic Products

This 48-pg catalog talks about product-quality programs such as intelligent display devices; numeric displays; and military high-reliability displays. Other devices discussed are optocouplers, LED lamps, IR emitters, photodetectors, and plastic fiber-optic emitter and detector components.

Siemens Components Inc, Optoelectronics Div, 19000 Homestead Rd, Cupertino, CA 95014.

Circle No. 400

**Lowest Profile**  
**0.5" ht.,**  
**up to 55 Watts**



## PICO AC-DC Power Supplies

- Input Voltage 90 to 130 VAC (47/440Hz)
- Single, Dual, Triple Outputs
- 1200V Rms Isolation
- Low Isolation Capacity Available
- Continuous Short Circuit Protection
- High Efficiency
- Fully Regulated Voltage Outputs
- Operating Temperature -25°C. to +70°C. with No Heat Sink or Electrical Derating Required
- Expanded Operating Temperature Available (-55°C. to +85°C. ambient)
- Optional Environmental Screening Available

*PICO manufactures complete lines of Transformers, Inductors, DC-DC Converters and AC-DC Power Supplies*

Delivery—  
stock to  
one week

SEE EEM,  
THOMAS REGISTER  
OR SEND DIRECT FOR  
FREE PICO CATALOG

**PICO  
Electronics, Inc.**

453 N. MacQuisten Pkwy. Mt. Vernon, N.Y. 10552

Call Toll Free **800-431-1064**

IN NEW YORK CALL **914-699-5514**

CIRCLE NO. 56

195



# EDN's CHARTER

**EDN** is written for professionals in the worldwide electronics industry who design, or manage the design of, products ranging from circuits to systems.

**EDN** provides accurate, detailed, and useful information about new technologies, products, design techniques, and careers.

**EDN** covers new and developing technologies to inform its readers of practical design matters that will be of concern to them at once or in the near future.

**EDN** covers new products

- that are immediately or imminently available for purchase
- that have technical data specified in enough detail to permit practical application
- for which accurate price information is available.

**EDN's** Magazine Edition also provides specific "how to" design information that its readers can use immediately. From time to time, EDN's technical editors undertake special "hands on" engineering projects that demonstrate EDN's commitment to readers' needs for useful design information.

**EDN's** News Edition also provides comprehensive analysis and news of technology, products, careers, and distribution.

## EDN

275 Washington St  
Newton, MA 02158  
(617) 964-3030

# BUSINESS/CORPORATE STAFF

**Peter D Coley, VP/Publisher**  
Newton, MA 02158; (617) 558-4673  
Ora Dunbar, Assistant/Sales Coordinator

**Mark J Holdreith, Associate Publisher**  
Newton, MA 02158; (617) 558-4454

**Deborah Virtue, Business Director**  
Newton, MA 02158; (617) 558-4779

**BOSTON**  
Chris Platt, Regional Manager  
Clint Baker, Regional Manager  
199 Wells Ave  
Newton, MA 02159; (617) 964-3730

**STAMFORD 06904**  
George Isbell, Regional Manager  
8 Stamford Forum, Box 10277  
(203) 328-2580

**NEW YORK/NEW JERSEY**  
Daniel J Rowland, Regional Manager  
249 West 17th St; (212) 463-6419

**PHILADELPHIA**  
Steve Farkas, Regional Manager  
487 Devon Park Dr, Suite 206  
Wayne, PA 19087; (215) 293-1212

**CHICAGO**  
Greg Anastos, Regional Manager  
Jack Johnson, Regional Manager  
1350 E Touhy Ave, Box 5080  
Des Plaines, IL 60018; (708) 635-8800

**ARIZONA**  
John Huff, Regional Manager  
44 Cook St, Denver, CO 80206  
(303) 388-4511

**COLORADO**  
Bill Klanke, Regional Manager  
44 Cook St, Denver 80206  
(303) 388-4511

**DALLAS 75251**  
Al Schmidt, Regional Manager  
12201 Merit Dr, Suite 730  
(214) 419-1825

**SAN JOSE 95128**  
Frank Granzeier, Regional Manager  
Bill Klanke, Regional Manager  
Phillip J Branon, Regional Manager  
James W Graham, Regional Manager  
3031 Tisch Way, Suite 100; (408) 243-8838

**LOS ANGELES**  
Charles J Stillman, Jr, Regional Manager  
12233 W Olympic Blvd  
Los Angeles, CA 90064  
(213) 826-5818

Susan Green, Regional Manager  
18818 Teller Ave, Suite 170  
Irvine, CA 92715  
(714) 851-9422

**ORANGE/SAN DIEGO/RIVERSIDE COUNTIES**  
Jim McErlean, Regional Manager  
18818 Teller Ave, Suite 170  
Irvine, CA 92715; (714) 851-9422

**PORTLAND, OREGON 97221**  
Pat Dakin, Regional Manager  
1750 Skyline Blvd, Box 6  
(503) 297-4305

**EUROPEAN OPERATIONS**  
Tully Giacomazzi, Managing Director  
27 Paul St, London EC2A 4JU UK  
Tel: 44-71-628-7030

**UK & BENELUX**  
Colin Smith, Oliver Smith & Partners  
18 Abbeville Mews  
88 Clapham Park Road  
London SW4 7BX

Tracey Lehane, Martin Sutcliffe  
27 Paul St  
London EC2A 4JU UK  
Tel: 44-71-628-7030

**SCANDINAVIA**  
Stuart Smith  
27 Paul St, London EC2A 4JU UK  
Tel: 44-71-628-7030; Fax: 44-71-628-5984

**FRANCE/ITALY**  
Laura Whiteman, G Reina srl  
14 Rue des Parisiens, Via Filippo Carcano, 6  
92600 Asnieres sur Seine, 20149 Milan Italy  
France Tel: 39 2 4819 3542  
Tel: 331-47900507 Fax: 39 2 4981 283  
Fax: 331-47900643

**GERMANY/AUSTRIA/BAVARIA**  
Karin Steinbacher, Wolfgang Richter  
New Media Munchen, Sudring 53  
Ismaninger Str. 108, D-7240 Horb 1 A/N  
8000 Munchen 80, West Germany  
Germany Tel: 49-7451-7828  
Tel: 49-89-98-51-35 Fax: 49-1-451-1794  
Fax: 49-89-981-0117

**GERMANY**  
Helmut Steinkraus, Manfred Horing  
Imedia Medien-Vertretungs, Media Kontakt  
GmbH, Bolkerstrasse 57, Bahnhofstrasse 15  
4000 Dusseldorf 1 Germany, D-6101 Messel  
Germany  
Tel: 49 211 80037  
Fax: 49 211 132410  
Tel and fax: 49 6159 5055

**SWITZERLAND**  
Peter Combag, Roswitha N Kunzle  
Exportwerbung AG  
Kirchgasse 50, 8024 Zurich 1  
Tel: 41 1 261 4690; Fax: 41 1 251 45 42

**ISRAEL**  
Asa Talbar, Talbar Media  
Box 22917  
Tel Aviv 61228, Israel  
Tel: 972-3-223-621; Fax: 972-2-247-403

**HONG KONG**  
Adonis Mak, Cahners Asia Limited  
22nd fl, Lo Yong Court Commercial Bldg  
212-220 Lockhart Road  
Wanchai, Hong Kong  
Tel: 852-572-2037; Fax: 852-838-5912

**JAPAN**  
Kaoru Hara, Dynaco International Inc  
Suite 1003, Sun-Palace Shinjuku  
8-12-1 Nishishinjuku, Shinjuku-ku  
Tokyo 160, Japan  
Tel: 81-3-3366-8301; Fax: 81-3-3366-8302

**KOREA**  
Jeong-guon Seo, DooBee International Inc  
Centre Bldg, 1-11 Jeong-dong  
Choong-ku, Seoul, Korea  
Tel: 82-2-776-2096; Fax: 82-2-755-9860

**SINGAPORE/MALAYSIA**  
Hoo Siew Sai, Ad Media Private Ltd  
95, South Bridge Rd  
#09-13 Pidemco Centre  
Singapore 0105  
Tel: 65-632-4026; Fax: 65-532-4027

**AUSTRALIA**  
Alexandra Harris-Pearson, World Media Network Pty Ltd  
Level 2, 285 Clarence Street  
Sydney, NSW 2000 Australia  
Tel: 61-2-283-2788; Fax: 61-2-283-2035

**TAIWAN**  
Parson Lee, Acteam International Marketing Corp  
Box 82153, Taipei, Taiwan ROC  
Tel: 886-2-7114833; Fax: 886-2-7415110

**PRODUCT MART**  
Joanne Dorian, Manager  
249 West 17th St  
New York, NY 10011  
(212) 463-6415; Fax: (212) 242-6987

**INFO CARDS**  
Heather McElkenney  
Newton, MA 02158; (617) 558-4282

**CAREER OPPORTUNITIES/CAREER NEWS**  
Roberta Renard, National Sales Manager  
Janet O Penn, Eastern Sales Manager  
Diane Philippar, Sales Assistant  
103 Eisenhower Pkwy  
Roseland, NJ 07068  
(201) 228-8602, 228-8610, 228-8608  
Fax: (201) 228-4622

Nancy Olbers, Western Sales Manager  
238 Highland St  
Portsmouth, NH 03801  
(603) 436-7565; Fax: (603) 436-8647

Wendy A Casella, James P Joyce  
Advertising/Contracts Coordinators; (617) 964-3030

**William Platt, Senior Vice President, Reed Publishing USA**

**Cahners Magazine Div**  
Terry McDermott, President, Cahners Publishing Co  
Frank Sibley, Executive Vice President/General Manager,  
Boston Div  
Tom Dellamaria, VP/Production & Manufacturing

**Circulation:** Denver, CO: (303) 388-4511  
Eric Schmierer, Group Manager

Reprints of EDN articles are available on a custom printing basis at reasonable prices in quantities of 500 or more. For an exact quote, contact Andrea Marwitz, Cahners Reprint Service, Cahners Plaza, 1350 E Touhy Ave, Box 5080, Des Plaines, IL 60017. Phone (708) 390-2240.





## For Most People, It Was Just Another Warm September Day.

For design engineers, it was the day mixed analog/digital design came of age.

The event was the mixed-signal design demonstration at the IEEE Bipolar Circuits and Technology Meeting (BCTM). The goal was to give credence to mixed-signal simulation and to benchmark companies in the marketplace. The results were conclusive.

**Viewlogic came up with the right answer first.**

But more to the point, what we did at BCTM in September, we can do for you now. We're the only company with a proven technology and a three year track record of success. The only one that integrates design capture, simulation and analysis.

But that's just the beginning.

**Performance and Flexibility available nowhere else.**

With VIEWsim/SD, you'll get the choices you need. You'll be able to mix behavioral models with gates and SPICE primitives. Choose from leading analog simulators like PSPICE and HSPICE. Include physical hardware models for devices when software models are not available. Use the most popu-

lar platforms from SUN, DEC and IBM. Our white paper "Mixed-Signal Simulation Benchmark Report" proves the point. **Call us at 1-800-422-4660, Ext. 102.** You'll like the climate we're creating for mixed-signal design.

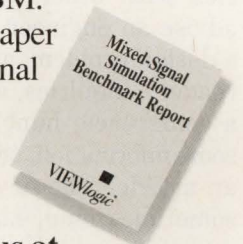

Full Hierarchical Design

Automatic Design Partitioning

Mixed-Signal Simulation With Behavioral, Device, Hardware Models

Integrated Mixed Signal Analysis

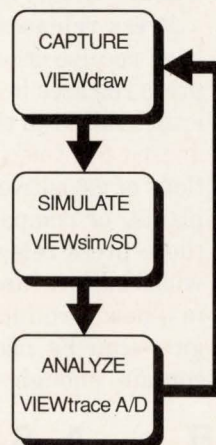

**VIEWlogic<sup>®</sup>**  
The CAE Company

Viewlogic Systems, Inc.  
293 Boston Post Road West  
Marlboro, MA 01752  
508-480-0881  
508-480-0882 FAX

PSPICE and HSPICE are trademarks of their respective companies.



There's a lot more  
to being an  
**EDITOR**  
than editing

**A**n EDN editor is a writer, a talent scout, a tutor, a researcher, a reporter, a critic, a trend spotter, a production coordinator, a consultant, and a troubleshooter. On any given day, he or she may watch a new-product presentation, give some guidance to a free-lance writer, brainstorm ideas for articles with other editors, advise an engineer about a design problem, answer readers' inquiries, attend a conference, hunt down some information, or write an article. The days are sometimes long, but seldom dull.

The raw material EDN editors deal with every day is information—information about companies, information about industry trends, and, most of all, information about new products and designs. All EDN technical editors have engineering degrees and extensive hands-on experience as working engineers. Their knowledge of what engineering in the real world is like guides them as they gather, process, and present the information that goes into the magazine.

The information comes to them

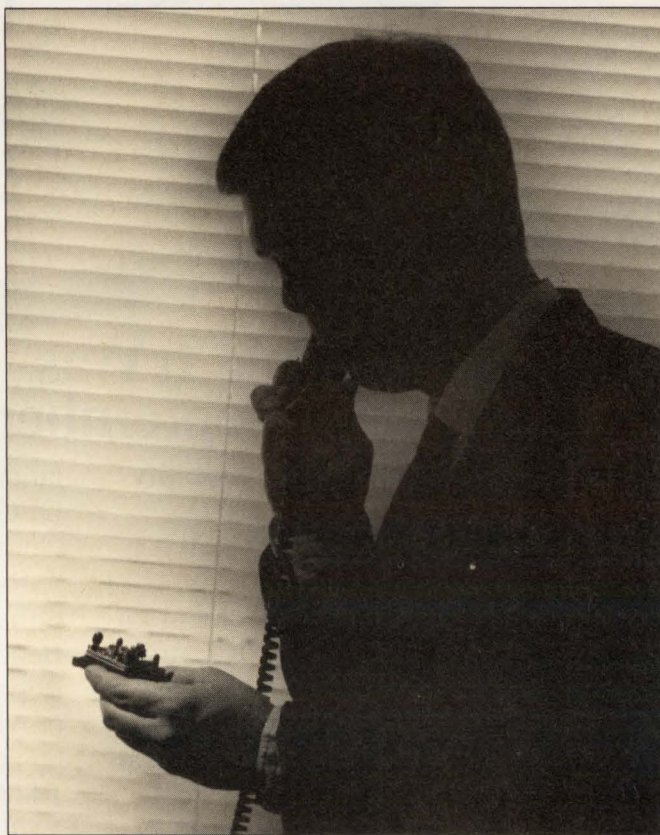

from a variety of sources:

**Press releases**—An EDN editor may receive as many as 25 or 30 press releases in a single day. Some aren't suited to the magazine. EDN doesn't print news about the promotions of executives, openings of new plants, or company mergers. Even those press releases that deal with what editors are most interested in—new products and technologies—can be useless if they don't contain enough hard information,

such as availability dates and prices. Perhaps one-fifth of the press releases that come in have information that will eventually find its way into the pages of the magazine.

**Books, magazines, and newspapers**—EDN editors read widely. They scan everything from prepublication copies of engineering textbooks to the newsletters of local computer societies. Some editors make a point of reading periodicals that deal with technologies outside their areas of expertise to give themselves additional perspective. It isn't just the articles that editors read; advertisements can also contain valuable information.

**Marketing and public relations people**—EDN editors are in constant contact with marketing and PR people. The people who do their jobs best know the magazine and understand what its needs are. They sometimes call an editor to announce a new product if they think he or she might be interested in it. PR people haven't always enjoyed a lofty reputation, but the real professionals can be an invaluable source of information.

**Company visits**—Some compa-

J A Y F R A S E R , A S S O C I A T E E D I T O R



nies send representatives to EDN's offices to announce new products. Sometimes they bring the products with them and demonstrate them. After an editor attends one of these meetings, he or she writes up a report and circulates it to the other editors in the office on E-mail. He or she also sends it to the regional editors on MCI mail.

**Exhibitions and conferences—**Exhibitions and conferences are valuable because they give editors a chance to see a great many new products at one time and provide a snapshot of where an industry is and where it is heading. But exhibitions and conferences are also important because they give editors a chance to meet and talk to people—marketing people, executives, engineers, and EDN readers. There's no substitute for talking with someone face to face.

**Other editors—**EDN editors are constantly passing information among themselves. Editors also confer with each other to determine how to focus an article and how to best present information.

EDN has six regional editors in the USA and one in Europe. Every week they write up reports about the companies they visit, the people they talk to, and the things they see, and send them into the home office. Regional editors are consulted about story ideas just as technical editors are.

Drawing on all these sources of information, every August and February EDN editors make up a list of topics for the articles they

want to write in the coming year. They submit their lists to the editor, who then sits down with two senior editors and works out a detailed schedule. The schedules are only six months long because the high-tech industry changes so rapidly and predicting trends is difficult.

Once a topic is approved and an article scheduled, the first thing an editor usually does is send out edi-

products. The editor also asks for photographs or drawings and the name and phone number of someone he or she can contact for more information.

Then an editor begins to phone his or her industry contacts to find out about the newest products that have been introduced, or are about to be introduced, and the latest technology advances. Contacts aren't necessarily public-relations

people. An editor also talks with engineers, managers, and people who have used a product.

The editor also turns to his or her files and digs out all the press releases, clips from magazines and newspapers, and faxes that might pertain to the article. In addition, the editor checks back issues of EDN to see what has been previously written about the subject.

After the replies to the editorial call letters have come in and the rest of the information has been assembled, the editor begins to write the article.

Writing is part craft and part art. The craft is extracting from the mass of information what is most important, putting it in the proper order, and making sure that it's complete and that all the pieces fit together into a smooth whole. Editors add their insight and analysis to the material, interpret what is going on in the industry, and look

for trends. The art of writing lies in adding that indefinable spark that will bring the entire article to life and catch and hold the reader's attention.

Part of writing an article is also the painstaking compilation of ta-

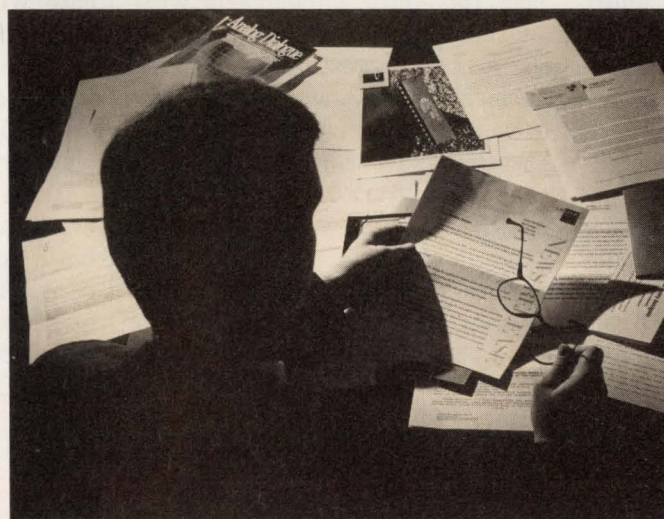
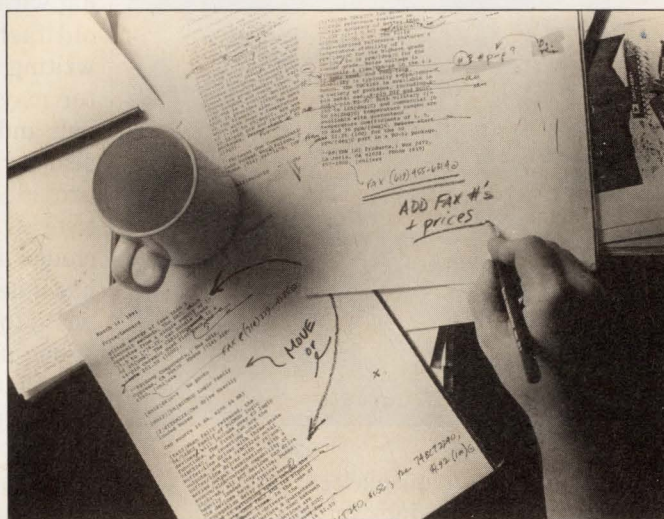

itorial call letters. The letters go to firms that manufacture the products the editor will discuss in the article. The editor asks for detailed information—specs, part numbers, prices, applications, and the advantages and disadvantages of the



bles or graphs and the checking and rechecking of names, addresses, and telephone and fax numbers to make sure they're accurate.

Every EDN technical editor has a varied schedule of writing assignments. He or she is responsible for Special Reports, Technology Updates, Product Updates, Design Features, and News Breaks each

Other people start by sending in complete articles they have slaved over. That's almost always a waste of time and postage. Even if the article happens to be on a subject of interest to EDN's readers, it would almost certainly have to be rewritten to conform to the length, structure, and style EDN requires.

Occasionally an editor will re-

engineering experience helps them make their decisions.

After the information is distilled into a story, it is presented to the readers in the magazine. EDN is published 26 times per year, and each issue is read by approximately 160,000 working engineers. The magazine is the primary way editors have to convey information, but it isn't the only way.

Editors always welcome feedback from readers, and readers have a number of options for communicating with them. Readers can use the old-fashioned method of simply writing a letter to the editor. A letter may end up printed in the Signals and Noise section. Readers can also write comments in the space provided on the Information Retrieval Service cards that are included in every issue. If a reader has a design problem, he or she can write to the Ask EDN department. If the editors can't solve the problem themselves, they'll get in touch with experts who can.

Last October, EDN started a computer bulletin board system that enables readers to communicate with the magazine's editors and with other readers. The bulletin board offers many other services, such as providing free utility, scientific, and engineering shareware programs.

This brief summary doesn't cover every detail of an EDN editor's job, but it does touch on the many facets of it. An EDN editor does much more than simply edit manuscripts. An editor reads, listens, observes, thinks, and then conveys the information he or she has gathered. Most readers never notice the names on the masthead or on bylines, but the work the editors do is important, satisfying, and usually enjoyable. **EDN**

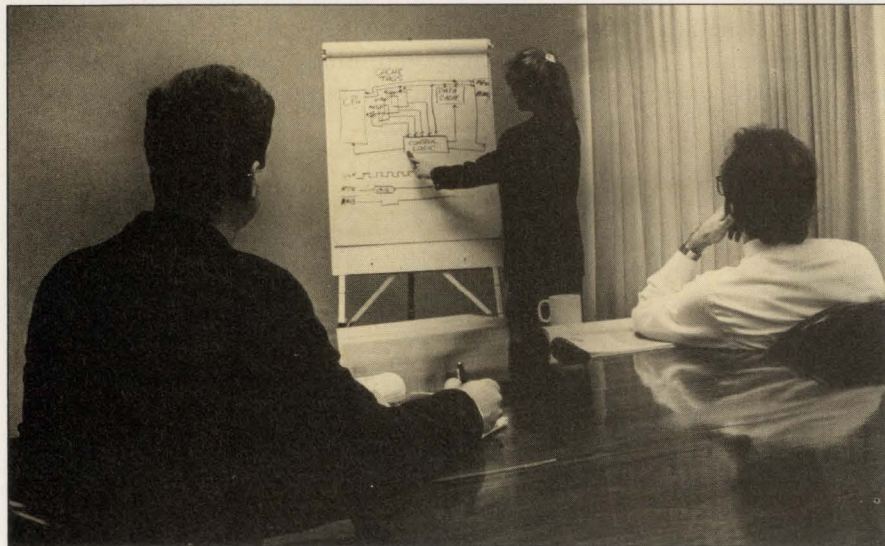

year, as well as a small number of miscellaneous pieces. Each editor also contributes numerous short write-ups to the New Products section. The information for these write-ups comes from press releases, visits by company representatives, and editors' visits to high-tech firms.

Writing articles for the magazine is an editor's primary responsibility, but it's only part of the job. Editors also have to deal with the many proposals and manuscripts that are sent to the magazine. EDN receives hundreds of these each year. Unfortunately, most of them are unusable.

Too many people who want to write for EDN don't read the magazine carefully to understand the kind of articles it does and doesn't print. They send in proposals for articles dealing with a single product, or case histories, or Horatio Alger stories. The editors reject these proposals out of hand.

ceive an unsolicited proposal that he or she finds interesting. In that case, the editor will phone or write a letter to the person who proposed the article suggesting what should be included in it and requesting a detailed outline and a sample lead paragraph. The editor will also send a copy of "Writing for EDN," a booklet that describes what the magazine requires in a contributed article. The editor and the writer may go through a great deal of give and take and more than one rewrite to mold the article into its final form.

Some editors have additional, specialized duties. Two of them handle the Design Ideas section. They choose among the designs sent in by readers and edit the descriptions and schematics. Because they receive many more ideas than the magazine has room to print, the choices they have to make are sometimes difficult. In this situation, too, the editors' real-world

Article Interest Quotient  
(Circle One)

High 518 Medium 519 Low 520



# Power Sandwich.

TDK Components Make Low-Profile Switching Power Supplies.

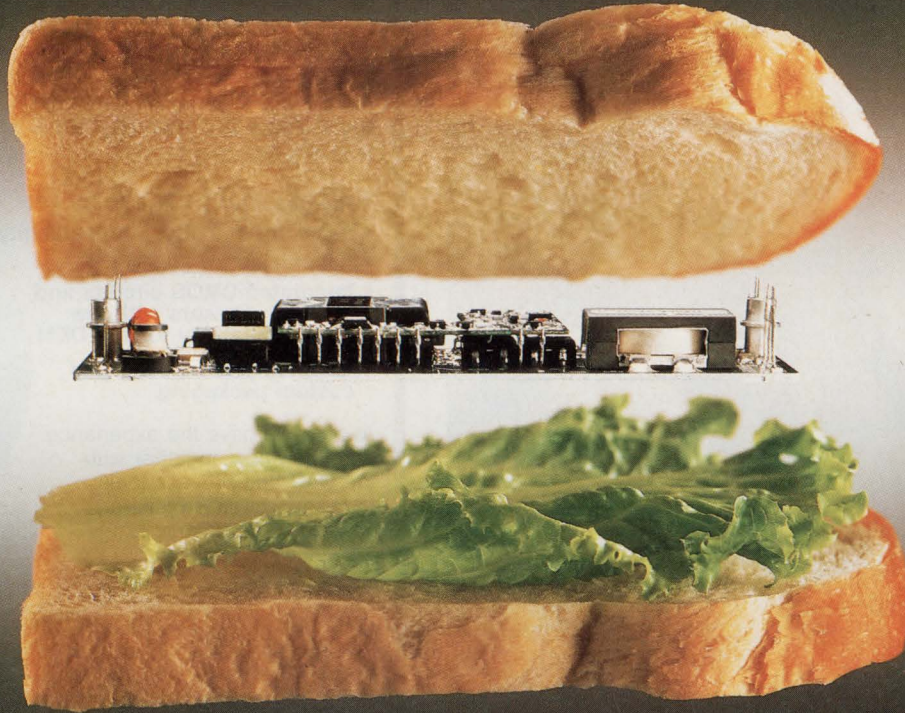

What happens when you "sandwich" low profile components to drastically reduce the space needed for power circuitry?

At TDK it means enhancing mechanical performance, reliability and safety while creating the world's thinnest switching power supply.

Utilizing our original material and design technology, TDK has developed various high performance components for switching power supplies. These include the new PC 50 ferrite with low power loss and high flux density, ultra-thin EPC Cores and Large-Capacitance Multilayer Ceramic Chip Capacitors, HC Series.

Call or write today for more information on TDK Components for Switching Power Supplies.

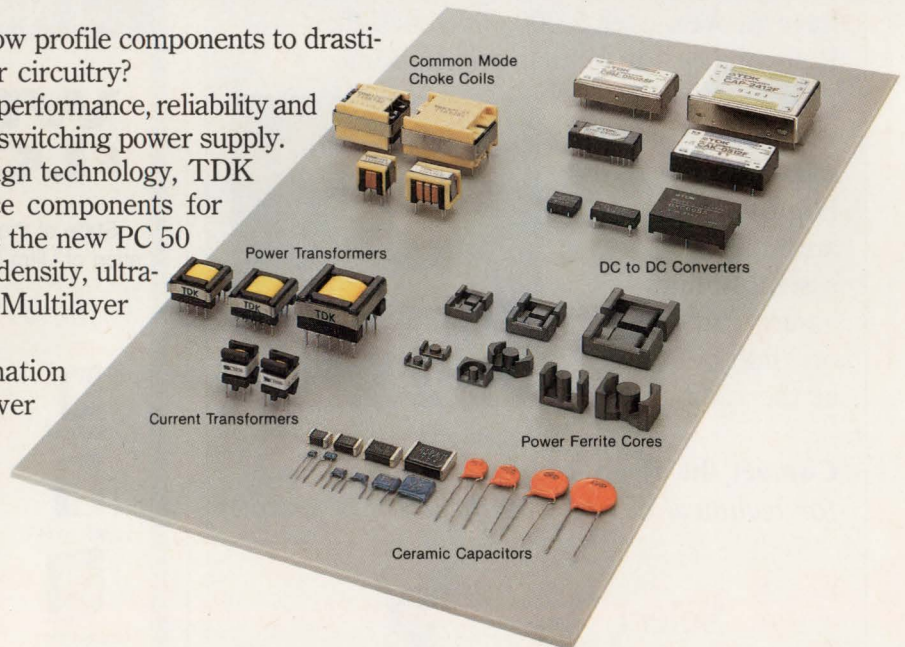

Come See Us at  
Electro '91 Booth #2168

TDK CORPORATION OF AMERICA 1600 Feehanville Drive, Mount Prospect, IL 60056, USA Phone: 708-803-6100 INDIANAPOLIS Phone: 317-872-0370 NEW YORK Phone: 516-625-0151  
LOS ANGELES Phone: 213-539-6631 DETROIT Phone: 313-462-1210 NEW JERSEY Phone: 201-736-0023 BOSTON Phone: 508-624-4262 HUNTSVILLE Phone: 205-464-0222  
GREENSBORO Phone: 919-292-0012 DALLAS Phone: 214-506-9800 SAN FRANCISCO Phone: 408-437-9585  
GERMANY • FRANCE • ITALY • U.K. • KOREA • TAIWAN • HONGKONG • SINGAPORE • THAILAND • P.R. OF CHINA • BRAZIL TDK CORPORATION Tokyo, Japan  
For further information on TDK ferrite products for power supply, please contact **MH&W International Corp.**, Mahwah, NJ Phone: 201-891-8800





THE RIGHT . . .

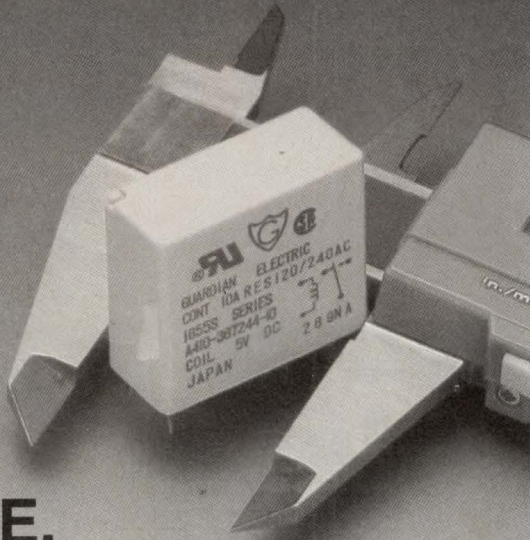

SIZE.

**Tight on board space?**

Only 0.58<sup>2</sup> inches available? Need to isolate and switch 6 AC Amps, and turn on a DC motor?

The 1655S & 1665S Relays from Guardian have proven over 2,000,000 times their Relayability™ in similar applications.

**Budget and delivery schedule tight?**

High volume automated assembly lines, assure consistent on time delivery at the right price.

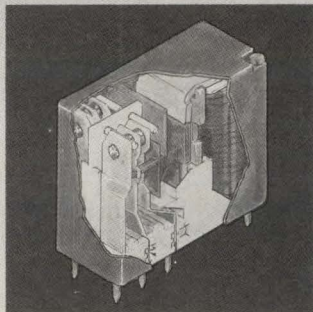

Contact the Relay Network for technical advice, specifications & samples.

Select



**GUARDIAN**

1425 Lake Ave. Woodstock, Illinois 60098  
Phone 815/337-0050  
FAX 815/337-0377

CIRCLE NO. 57

**LOW PRESSURE SILICON CAPACITIVE SENSORS**

M-618



RANGES from 2" H<sub>2</sub>O to 30 PSI

We offer superior silicon capacitive technology for low pressure sensing.

- Ranges from 2" H<sub>2</sub>O to 30 PSI
- Excellent stability & repeatability
- Accuracies to ±0.5% FS
- Integrated CMOS circuits and pressure sensors with low power capability for the OEM
- Versatile plastic, TO-8 and custom packaging

At MSI, we have the experience and know-how, together with the CAD and process tools, to customize state-of-the-art sensors. Give us a call.



SENSING THE FUTURE  
**MSI**

**MONOLITHIC SENSORS, INC.**

2800 W. Golf Road  
Rolling Meadows, IL 60008

Phone: 708/437-8090 • FAX: 708/437-8144

CIRCLE NO. 58





INTRODUCING

**WIDE & LOW**



State of the Art DC/DC Converters offering the combination of Ultra Wide Input Voltage Ranges and Low Profile.

**How They Stack Up:**

	Series	Input Range	Case Height	Power
 2x2x0.38"	LW	9-36 VDC 20-72 VDC	0.38"	15 watts
 2.56x3x0.84"	SIW	9-36 VDC 20-72 VDC	0.84"	30 watts
 3x3x0.375"	CA	9-36 VDC 20-72 VDC	0.375"	40 watts
 2.4x4.6x0.84"	VMC	18-36 VDC 36-72 VDC 85-200 VDC 170-400 VDC	0.84" <small>(No Heat Sink Required)</small>	50 watts

**WALL** INDUSTRIES INC.  
5 WATSON BROOK RD., EXETER, NH 03833  
1-800-321-WALL 603-778-2300 FAX 603-778-9797

**30 Years of Service & Reliability**

CIRCLE NO. 59



from  
*Noritake*

Now you can afford  
VFD quality...VFD visibility



Actual size



*itron* VFD T-Version Module

- Low power
- Long-term reliability
- Easy user interface
- Surface mount technology
- Flexible control data
- Parallel and serial output
- Built-in test function
- ASCII, European, Japanese Katakana characters
- 9 Modules to choose from

Call or write to see our entire line:

*Noritake*

CIRCLE NO. 167

Los Angeles  
23820 Hawthorne Blvd.  
Suite 100  
Torrance, CA 90505  
Tel. 213-373-6704  
Fax 213-772-3918

Chicago  
415 E. Golf Rd.  
Suite 109  
Arlington Heights, IL 60005  
Tel. 708-439-9020  
Fax 708-593-2285

Boston  
263 Winn St.  
Suite 1D  
Burlington, MA 01803  
Tel. 617-270-0360  
Fax 617-273-2892

Dallas  
2454 Trade Mart  
Dallas, TX 75207  
Tel. 214-742-9389  
Fax 214-747-5065

Europe  
Frankfurter Strasse 97-99  
6096 Raunheim  
F.R. Germany  
Tel. 06142-43095/96/97  
Fax 06142-22799



# If you had this...

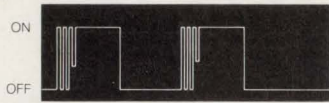

# and we gave you this...

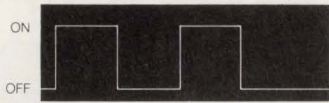

# think what you could do!

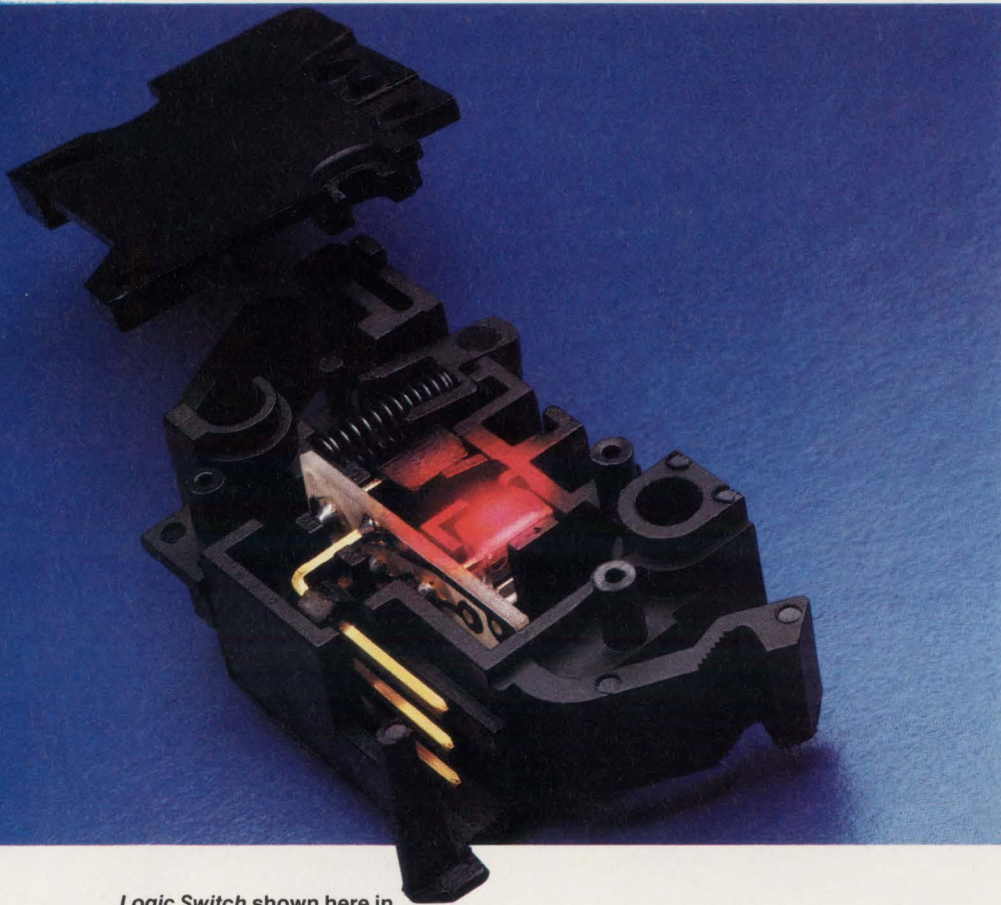

Logic Switch shown here in our Terminator® quick-connect, fast-mount configuration.

**Introducing the Logic Switch™**  
Imagine! Noise-free, logic-level switching from an electromechanical package! We're calling it the *Logic Switch* because this alternative to mechanical contact switches gives you discrete, noise-free signal through optoelectronics. Solid-state and designed for long life and reliability. Think of the possibilities!

#### Here's How It Works.

The *Logic Switch* uses an infrared emitter and phototransistor sensor combination. An internal "flag" interrupts a beam of infrared light from emitter to sensor, thus changing the switch's output when activated.

The infrared light transmission reduces dust problems associated with visible light transmission, and the solid-state life-span is estimated at 50 million cycles.

#### What Can You Do With It?

The *Logic Switch* is so new, we wouldn't presume to guess at all its uses. Instead, we invite you to examine it firsthand and try it out on *your* ideas. Call Cherry at 708-360-3500, and we'll send qualified engineers a free *Logic Switch* and a specifications sheet.

The *Logic Switch* is ideal for any application in which logic-level switching is necessary and traditional snap-action switches are problematic.

But perhaps you have some different ideas.

Why not call us today and put those ideas to the test right in your own laboratory—for FREE. All you've got to lose is signal noise.

**The Logic Switch: an electronic device in an electrical package.**

**CHERRY**   
THE CHERRY CORPORATION

**Cherry Electrical Products**  
3600 Sunset Avenue  
Waukegan, IL 60087  
Phone: 708-360-3500  
Facsimile: 708-360-3566

CIRCLE NO. 146





# EDN PRODUCT MART

This advertising is for new and current products.

Please circle Reader Service number  
for additional information from manufacturers.

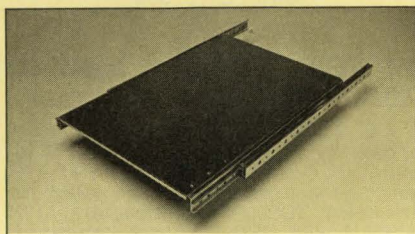

## CC7100 Ball Bearing Sliding Shelf

- Smooth action, ideal for delicate instruments
- Fits standard 19" wide cabinets
- 14 gage CRS with zinc/bright chromate finish
- Different lengths/weight capacities
- Heavy duty construction at competitive price



General Devices Company, Inc., P.O. Box 39100,  
1410 S. Post Rd., Indianapolis, IN 46239-9632  
(317) 897-7009, FAX: 317-898-2917

CIRCLE NO. 325

☆☆☆☆  
"The Best 8051 Emulator"

NEW  
30 MHz  
REAL-TIME

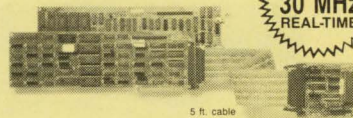

5 ft. cable

## 8051

SEE EEM 90/91  
Pages D 1320-1323

PC based emulators for the 8051 family

8031, 8032, 8051, 8052, 80C150/154/221/451/452/151FA/151GB/151S/173/153/1537/552/562/652/851, 80532, 83C451/552/652/751/752/851, 8344, 87C451/552/751/752, 8751, 8752, DS5000 + CMOS ... more.

- PC plug-in boards or RS-232 box.
- Up to 30 MHz real-time emulation.
- Full Source-level Debugger w/complete C-variable support.
- 48 bit wide, 16K deep trace, with "source line trace."
- "Bond-out" pods for 8051, 83C552, 83C451, 83C652, 83C751, 80C15/80C517, 83C752.

Prices: 32K Emulator 8031 \$1790\* 4K Trace \$1495\*

CALL OR WRITE FOR FREE DEMO DISK!  
Ask about our demo VIDEO

**NOHAU**  
CORPORATION

51 E. Campbell Avenue  
Campbell, CA 95008  
FAX (408) 378-7869

(408) 866-1820

\*US only

CIRCLE NO. 326

## New SMTransformer™ for Telecommunications

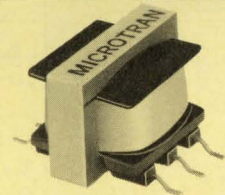

Surface Mount

For interconnect voice / data modem terminals

- Meets FCC Part 68 • Ht. 0.47" • For dry circuits
- Coupling and hybrid • Freq. resp: 300-3500 Hz ± 0.5 dB • -45 to +7 dBm rating • Dist. 0.5% max.
- Return loss 26 dBm • Long. bal. -60 dB • 1500V RMS hipot • Qty. price about \$3.00 • Custom designs available. Box 236, Valley Stream, NY 11582-0236. Tel: 516-561-6050; Fax: 516-561-1117.



**MICROTRAN**  
company, inc.

CIRCLE NO. 327

## DR-11W USERS:

### New Fiber Optic Link

Our new Fiber Optic Link removes the DR-11W's 50 foot cable limit. We use advanced fiber optic technology so you can separate DR11-W compatible devices up to 2 kilometers — with no loss in system throughput. Our Links connect to your existing DR11-W interfaces with standard 40-conductor flat cables. Join the two Link modules with duplex fiber optic cable, and your system is ready without software changes.

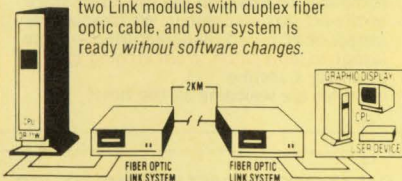

**macrolink inc.**

1500 North Kellogg Drive ■ Anaheim, California 92807  
Phone (714) 777-8800 ■ FAX (714) 777-8807

CIRCLE NO. 328

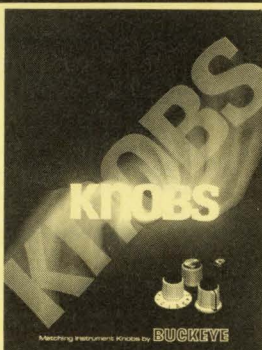

FREE 26 Page CATALOG with all styles and designs of matching instrument knobs illustrated.

Fax us your specs—we will  
Fax you a quote...immediately!

**Buckeye**

555 Marion Road  
Columbus, OH 43207  
Fax: 614/445-8224 Phone: 614/445-8433

CIRCLE NO. 329

## SMD PICO FUSE™ AVAILABLE FROM LITTELFUSE

New PICO SMD™ very fast-acting and Slo-Blo® surface mount fuses are available from Littelfuse, Inc.



The PICO-SMD fuses are available from 1/16 ampere to 5 ampere in the fast-acting type and 3/8 ampere to 5 ampere in the Slo-Blo type. The interrupting rating for the very fast-acting fuse is 50 ampere at 125VAC and 300 ampere at 125VDC, the Slo-Blo fuse is 50 ampere at 125VAC and DC.

Recognized under the components program of Underwriters Laboratories and Certified by CSA, the fuses are supplied on 12mm tape, 500 fuses per reel for use with automatic placement equipment per EIA Standard 481-1.

**Littelfuse Inc.**

Call or write Littelfuse, Inc., 800 E. Northwest Highway, Des Plaines, IL 60018, (708) 824-1188.

CIRCLE NO. 330

To advertise in Product Mart, call Joanne Dorian, 212/463-6415



## HIGH PERFORMANCE SUBMINIATURE COAX CABLE ASSEMBLIES

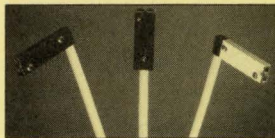

- Impedance controlled to the PC Board
- EMI/RFI Shielded

Meritec's economical Shielded Performance Interconnects (SPI™) are ideal for fast logic, dense package applications which require low noise crosstalk and high impedance control.

For more information,  
call Meritec at (216) 354-3148.



CIRCLE NO. 331

## Imagine if YOUR product could talk!

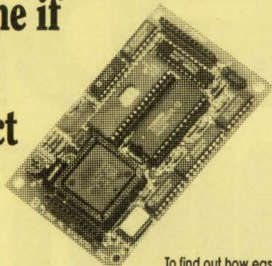

To find out how easy  
it is to add speech output  
to your own products, call for  
your free V8600 data book today!

- Converts plain ASCII text into high quality speech
- Requires only a single 5V supply and speaker
- Use in computers, voice-mail, warning systems, etc.
- Built in  $\mu$ P, serial and printer interfaces
- Less than \$100 in OEM quantities
- Customization services available

### RC SYSTEMS

121 W Winesap Rd. - Bothell, WA 98012

USA/Canada - Phone/Fax: (206) 672-6909

Europe - 081 539 0285 Fax: 081 558 8110

CIRCLE NO. 332

## PCB and SCHEMATIC C.A.D.

### EASY-PC

\$195

Now even faster and with  
Laser Printer Output.

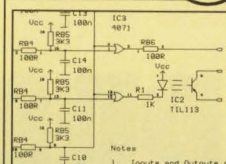

- Runs on PC/XT/AT/286/386 with CGA EGA or VGA.
- Design Single sided, Double sided and Multilayer boards.
- Provides Surface Mount support.
- Standard output includes Dot Matrix / Laser / Inkjet Printer, Pen Plotter, Photo-plotter and N.C. Drill.

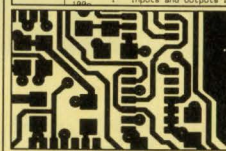

- Award winning EASY-PC is in use in over 7000 installations in 50 countries world-wide.
- SUPERBLY EASY TO LEARN AND USE.
- Not Copy Protected.
- Dealers Wanted.

FAST Professional Quality Output at an Affordable Price

For full info, write, fax, call or use inquiry #

### Number One Systems Ltd. 1

REF: EDN, HARDING WAY, ST. IVES, HUNTINGDON,  
CAMBS, ENGLAND, PE17 4WR.

Telephone:

USA: 011-44-480-61778

Intrnl: +44-480-61778

UK :- 0480 61778

Fax:

USA: 011-44-480-494042

Intrnl: +44-480-494042

UK :- 0480 494042

BRITISH  
DESIGN  
AWARDS  
1982

AMEX,VISA,  
MasterCard  
Welcome

CIRCLE NO. 333

## SPICE SOFTWARE CAE TOOLS FOR THE PC

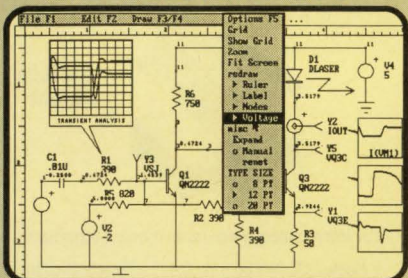

From Schematic Entry, through SPICE Simulation,  
to Graphical Post Processing, only \$790

- ISPACE - Full Featured SPICE Circuit Simulation
- SPICENET - Graphical Schematic Entry for SPICE
- INTUSCOPE - Waveform Display and Plotting
- PRESPACE - Model Libraries, Monte Carlo analysis
- SPICEMOD - SPICE Model generation from data sheets



P.O. Box 710  
San Pedro, CA  
90733-0710

Tele (213) 833-0710

FAX (213) 833-9658

CIRCLE NO. 334

## 200 MHz Logic Analyzer

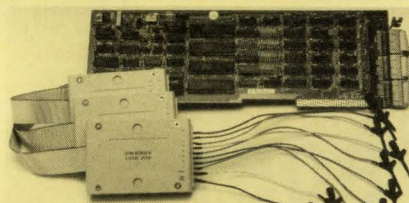

- 24 Channels (up to 50 MHz), Timing and State
- 200/100 MHz Max Sampling Rate (6 channel)
- Timing and State Simultaneous on Same Probe
- 16K Samples/Channel (6 channel mode)
- 16 Levels of Sequential Triggering
- Optional Expansion to 72 Channels
- Variable, TTL, or ECL Logic Threshold Levels
- 3 External Clocks and 11 Quality Lines
- FREE Software Updates on 24 Hour BBS

\$799 - LA12100 (100 MHz)

\$1299 - LA27100 (100 MHz)

\$1899 - LA27200 (200 MHz)

Price includes Card,  
Pods, and Software

## UNIVERSAL PROGRAMMER

PAL  
GAL  
EPROM  
EEPROM  
PROM  
87xxx...  
22V10

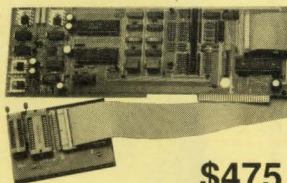

\$475

16Bit EPROMs FLASH EPROMs  
5ns PALs 4 Meg EPROMs  
FREE software updates on BBS

## GANG PROGRAMMER

- 4 32pin Sockets (8 Socket option)
- 2716-27010 EPROMs

\$215

Call - (201) 994-6669  
Link Computer Graphics, Inc.

4 Sparrow Dr., Livingston, NJ 07039 FAX:994-0730

CIRCLE NO. 338

## !!! NEW !! NEW !! NEW !!! 20MHz single-board computer

4" x 3" TDS2020 FORTH controller or data-logger, based on CMOS Hitachi 16-bit H8  $\mu$ P. On-board high-level easy FORTH language and assembler - no need for emulation! TDS9090 compatible, up to 512K NVRAM, 45K PROM. Attach keyboard, lcd, I2C peripherals. Built-in interrupts, multi-tasking, watchdog timer, editor and assembler. 33 I/O lines, two RS-232 ports. 6 - 16 volts 500 $\mu$ A data-logging: 8-channel, 10-bit A/D, 6 ch D/A, date/time clock -- low-power mode lasts one year on 9v battery! Includes lots of ready-made software solutions. Program with PC. Many in use worldwide for machine control, data-logging, inspection, factory automation, robotics, remote monitoring, etc.

Sale-or-return.

\*\*TDS9092 now only \$159

CALL FOR DETAILS!

\$299 (25's)



Saelig Company

European Technology

tel: (716) 425-3753 fax: (716) 425-3835

CIRCLE NO. 336

## DC-DC CONVERTER

- 5W-60W, SINGLE, DUAL, TRIPLE OUTPUT
- Input Range: 9 to 18V, 18 to 36V, 36 to 72V
- Output Range:  $\pm$ 5V,  $\pm$ 12V,  $\pm$ 15V,  $\pm$ 24V
- Input Pi Filter, EMI/RFI Shielding
- Special and Custom Design

## OEM ASSEMBLY SERVICE

Galaxy is your answer. We have over 5 years' experience with Telephone and PBX systems, switching power supplies, and computer boards; and use the latest state-of-the-art SMT equipment. We handle every aspect of PC board manufacturing — from layout to lamination, from etching to assembly & testing. Inquiries are welcome all the time!

## GALAXY MICROCRAFT SYSTEMS CO., LTD.

7FL., NO. 25, LANE 23, RUI-AN ST., TAIPEI,  
TAIWAN, R.O.C. P.O. BOX 24-543 TAIPEI  
TEL: 886-2-7051622 FAX: 886-2-7016600

CIRCLE NO. 339

## PC/AT™ COMPATIBILITY ON MULTIBUS

In 1989 our MAT286™ SBC brought PC-DOS to Multibus I. Since then no competitor has come close in terms of features, price, or technical support. We've added capabilities, such as 8 megabytes of onboard EPROM capacity, MATXSSD Solid-State Disk software, EMS 4.0, and low power CMOS components. Now we are announcing our new MATXSYSIO2 daughter-card with 16-bit VGA and LCD flat-panel interfaces, 1-1 interleave MFM/RLI ST506 hard-disk/floppy disk controller, and a PC/AT Bus short-card adaptor. And, yes, we are working on MAT386, the 386-based Multibus AT that will be compatible with the 286-based standard, MAT286.

Phone (408) 253-0250 for more information.

Single Board Solutions, Inc.

20045 Stevens Creek Blvd., Cupertino, CA 95014  
PC/AT™ IBM

CIRCLE NO. 337

To advertise in Product Mart, call Joanne Dorian, 212/463-6415



**100% PC/AT Compatibility  
Guaranteed**

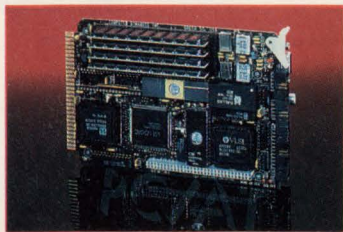

**On ONE Module— the CPU-AT**

- More power than a desktop AT, in less than 10% of the space
- Directly drives flat panel displays and CRTs
- Ideal for embedded control
- 0- 70° C operation, low power requirements
- Supports ROM- or disk-based applications
- Expands with any STD Bus I/O

Call for your FREE CPU-AT brochure and "ROMing" software demo diskette.

**Computer Dynamics Sales**  
107 S. Main Street Greer, SC 29650  
Phone: 803-877-8700 FAX: 803-879-2030

CIRCLE NO. 340

**INDUSTRIAL  
THERMOSTATS**

Snap-action thermostats provide quick make or break of current in

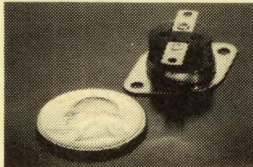

temperature-critical devices. Compact, surface mounted, reliable. Some models open on temperature rise, others close, at fixed set points between 35°F and 500°F. Attractive quantity discounts. Literature, free sample, and quotations. Available from stock.

**Selco Products Co.**

7580 Stage Rd., Buena Park, CA 90621  
213/921-0681, 714/521-8673  
800/229-2332

CIRCLE NO. 341

**THE LOGIC ANALYZER**

MODEL 3625 32CH. 100MHZ  
MODEL 3620 24CH. 100MHZ



FREE DEMO DISK

FORMAT MODE

LIST MODE

- Runs on PC, Drives HGA, CGA, EGA, VGA, and MCGA.
- Up to 32 timing/state data channels, 2045 bits/channel.
- Sample rate up to 100 MHz asynchronous, 25 MHz sync.
- Sample data by rising, falling, both edge of two EXT clocks AND/OR logic combinations.
- Over 4000 multilevel combinational trigger conditions.
- Level/Edge trigger capability.
- Data qualification with 8 channels qualifier.
- Easy-to-use menu-driven system software.
- FORMAT, TIMING, LIST, and DOS display Mode.
- Full color display enhances user interface.
- User-definable color set.
- 8 acquisition templates provide rapid setup and operation.
- 4 user-definable groups those can be displayed in separate BIN, OCT, HEX, ASCII, and DEC radices.
- Save/load acquisition data file and edit testing comment in DOS Mode.
- Hardcopy at any moment, and dump the data of interest in timing diagram or state table.

**OEM AND  
DISTRIBUTOR  
WANTED!**



**ARGOSY TECHNOLOGY CO., LTD.**  
8F, NO. 196, SEC. 2, KEELUNG RD., TAIPEI, TAIWAN, R.O.C.  
TEL: 886-2-7371325 FAX: 886-2-7371342

CIRCLE NO. 342

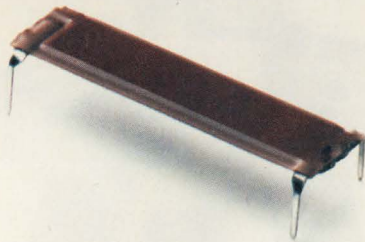

**SIMPLIFY BOARD LAYOUT**

MICRO/Q 1000 ceramic decoupling capacitors share board mounting holes with IC pins to simplify board design. Now add more active devices with increased density in the same space, or design the same package on a smaller board. Rogers Corp. 2400 S. Roosevelt St., Tempe, AZ 85282. 602/967-0624

CIRCLE NO. 343

**#1 LOW COST  
CIRCUIT  
BREAKER**

100% tested and calibrated

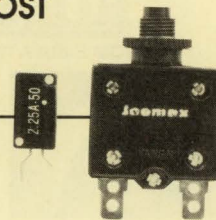

- 76 series: Auto reset, printed circuit board mounted, 0.6A to 5A. Ideal for medical equipment, audio system, and food processor.
- 74 series: Push to reset, panel mounted, 3A to 30A. Ideal for control panel, motor protection, and power supplies. UL/CSA.

**JOEMEX ELECTRICS AMERICA, INC.**  
19 Hammond, Suite 508, Irvine, CA 92718  
Tel: (714) 855-4472 Fax: (714) 855-4574

CIRCLE NO. 344

**Half the time/  
Half the cost**

- Affordable 8, 16 & 32 bit emulators
- Download 250,000 bytes/second
- Built-in performance analysis
- Full speed, zero wait state operation
- C, C++ & PL/M source level support



Z80 8085  
64180/Z180 64180S  
8088/86 80188/186  
V20/30 V40/50  
647180X Z280  
68000 80386

**SOFTAID, Inc.**  
1-800-433-8812  
Columbia, Md.

CIRCLE NO. 345

**\$495**

FOR A PROGRAMMABLE  
DC POWER SUPPLY IS NOW A REALITY!



- GPIB Interface Standard
- Output Voltage/Current Programming & Readback
- Local & Remote GPIB Operations
- Remote Sense Function
- Programmable Overvoltage and Overcurrent Protection
- Software Calibration
- Superior Line/Load Regulation
- Output Enable/Disable
- 3 Year Warranty

FREE Orientation Video available  
For details, call:  
**AMERICAN RELIANCE INC.**  
(800) 654-9838

CIRCLE NO. 346

**TCP/IP**

**NETWORKING PROTOCOLS**

Add them to your System Designs with:

**FUSION Developer's Kit**

- FUSION TCP/IP protocol suite
- Flexible architecture - C source code
- Used in hundreds of process control, embedded systems, and end-user designs
- Full support with consulting and porting services

Call 1-800-541-9508



CIRCLE NO. 347

**Transmission Line Problems?**

Glitchy clocks?  
Overshoot and undershoot?  
Flaky system operation?



**New!** LineSim Pro spots problem signals and helps find solutions before you build boards.

**LineSim Pro** features:

- simulation of 100's of transmission line segments per electrical net
- push-button schematic
- oscilloscope display
- device-model library
- circuit-board-impedance calculators
- extended-memory support
- uses 386/486 protected mode

Or choose **LineSim**, a simplified version (2 lines).

**LineSim Pro: \$995 (U.S.)** Requires 386/486 PC w/EGA/VGA; min. 2 Mb extended memory; mouse.  
**LineSim: \$495 (U.S.)** Requires IBM PC w/EGA; min. 640K memory.

30-day money-back guarantee, w/\$25 restock fee.



Attention: Sales Dept.  
P.O. Box 3578  
Redmond, WA 98073-3578  
Tel. (206)869-2320  
Fax (206)881-1008

CIRCLE NO. 348

To advertise in Product Mart, call Joanne Dorian, 212/463-6415



## HEAT SINK

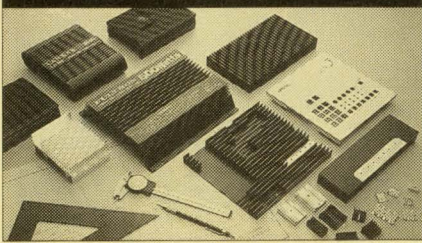

HPIC is a specialist manufacturer of aluminum products since 1972. Our experience and integrated production including extrusion, cutting, punching, drilling, lathing, CNC milling and anodizing etc. guarantee you the best price, quality products and prompt delivery. Many famous makers of household electronic/electric appliances, computers etc. purchase their heat sinks, front panels and metal parts from HPIC. Your inquiry are most welcome.

HWANG PIIN IND. CO., LTD.

NO.254, CHUNG CHENG RD., LOU-JOU HSIANG, TAIPEI HSIEN TAIWAN, R.O.C.  
TEL: (02)2816636~8 Telex: 33485 HPIC Fax: (02)2828180



CIRCLE NO. 349

## ADVANTECH

Industrial & Lab Automation with PCs



### PC-Based Universal Device Programmer

PC-UPROG

\$895

- Programs most PLDs and memories up to 40 pins
- Menu driven device selection by P/N and manufacturer
- Full screen editor for fuse maps and memory buffers
- JEDEC standard vector test functions
- New devices can be easily added by yourself
- Self test and diagnosis for high programming yield
- One year warranty and free device update

408-293-6786

1310 Tully Rd., #115, San Jose, CA 95122 FAX 408-293-4697

CIRCLE NO. 350

## NoiseKen

### IEC Pub. 801-2 HIGH REPRODUCIBLE ESD TESTING.

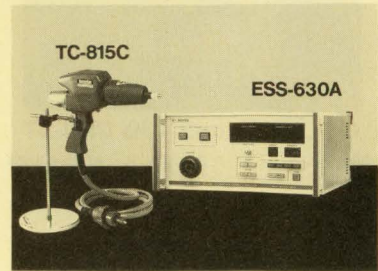

### ELECTROSTATIC DISCHARGE SIMULATOR **ESS-630A**

U.S.A WATAHAN NOHARA INTERNATIONAL, INC.  
TEL (800)366-3515

CIRCLE NO. 751

## WORLD'S SMALLEST SMT QUARTZ CRYSTALS and CLOCK OSCILLATORS

708-806-1485

- 10kHz-32MHz
- ceramic & metal packages
- hermetically-sealed
- hi-temp mounting
- tape & reel
- thru-hole versions
- shock resistant



FREE CATALOG

CIRCLE NO. 752

## ROM-IT

EPROM EMULATION SYSTEM



### NEW 4-MEGABIT VERSION

- Emulates up to 8 4-Megabit EPROMs with one control card.
- Downloads 2-Megabit programs in less than 23 seconds.
- Allows you to examine and modify individual bytes or blocks.
- Accepts Intel Hex, Motorola S-Record and Binary files.
- Software available for IBM PC and compatibles and Macintosh systems.
- Base 27256 EPROM System \$395.00 Other configurations available.

ORDER TODAY--IT'S EASY  
CALL OR FAX FOR MORE INFORMATION



Incredible Technologies, Inc.  
(708) 437-2433  
(708) 437-2473 Fax

VISA now accepted.

CIRCLE NO. 753

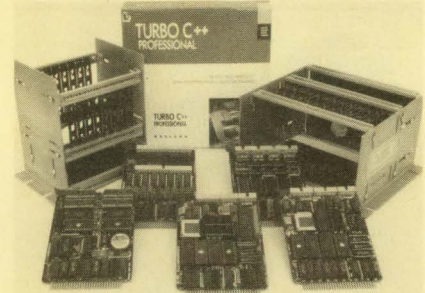

### TURBO-STD-BUS

R.L.C.'s large selection of 8 and 16-Bit STD Bus Single Board Computers offer an Intel 80C186/188 CPU and 80C187/8087 Numeric Co-Processor at true bus speeds up to 16 MHz. On-board functions include MEMORY, SERIAL PORTS, REAL TIME CLOCK, TIMERS, DMA, INTERRUPT CONTROLLER, and BATTERY BACK-UP, WATCH-DOG TIMER and much more. R.L.C. also offers 16-Bit support cards, card cages and complete software support using the award winning TURBO-DEBUGGER. For more information and technical assistance please call Robert Coomer.

R.L.C. Enterprises  
(805) 466-9717

4800 Templeton Road Atascadero, CA 93422

CIRCLE NO. 754

## Create a DISKLESS PC

IT'S EASY...IT'S SIMPLE...  
THERE'S NOTHING TO IT!!

### PROMDISK™ III IBM PC DISK EMULATOR CARD

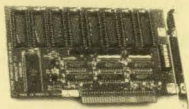

- IBM PC/XT/AT Compatible
- Mix EPROMs, EEROMs, SRAMs
- Emulates up to 1.024Mbyte Drive
- Occupies 32K PC address space
- Supports popular Byte-Wide chips



Phone: (619) 744-8087  
FAX: (619) 744-9256

810-208 Los Vallecitos ~ San Marcos, CA

CIRCLE NO. 755

## A 3"x 5" Single Board Computer with FREE C Source Utilities!

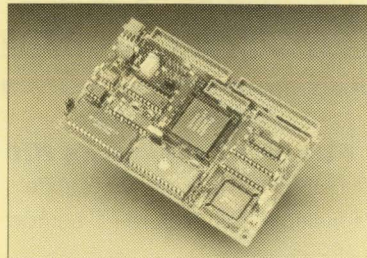

### 30-Day Money-Back Guarantee!

- 8051 type architecture
- Siemens 80C535
- 40 digital I/O lines
- 2 RS232 ports and 1 RS485 port
- 8-Bit A/D converter with 8 multiplexed inputs
- Power supervisory circuits
- 8KB or 32KB RAM / 32KB or 64KB EPROM
- 5x4 keypad encoder
- On board +5V regulation
- Optional real time clock
- Over 40 FREE C source utilities



TRI-L DATA SYSTEMS  
94-871 Farrington Hwy, 2nd Fl.  
Waipahu, HI, USA 96797-3146  
Phone: (808) 671-5133  
FAX: (808) 671-8543  
Toll Free: 1-800-245-8745

CIRCLE NO. 756

## 40-PIN E/EPROM PROGRAMMER Lifetime S/W via BBS

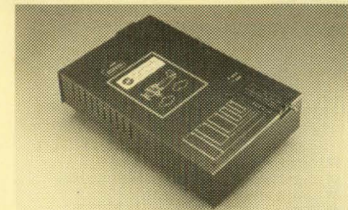

PILOT-144: Powerful PC-driven 40-pin programmer supports E/EPROMs up to 40-pins. Standard parallel port interface means fast thru-put and no need to install high voltage cards inside your PC. Built-in power supply. Upgradable to support 875x and 874x micros. \$795. SATISFACTION GUARANTEED.

408-243-7000, 800-627-2456, Fax 408-736-2503



ADVIN SYSTEMS INC.  
1050-L E. Duane Ave., Sunnyvale, CA 94086

CIRCLE NO. 757

To advertise in Product Mart, call Joanne Dorian, 212/463-6415



## DEVELOPERS' TOOLS

TPT-100 \$145.-  
POCKET IC TESTER

- Tests TTL (74/54), CMOS (40/45) and DRAM
- 9V battery operated
- LCD display
- Search unknown IC

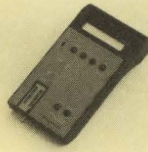

TRE-200 \$295.-  
8/16 BIT  
ROM/RAM EMULATOR  
(PC based)

- 8 or 16 Bit
- ROM: 2764, 128, 256, 512
- RAM: 6264, 62256
- Fast download load
- Screen edit
- Dis-assembler for 8 MPUs

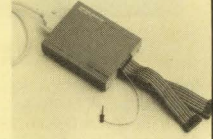

TLK-PLD PLD Learn Kit \$85.- TLK-GAL GAL Learn Kit \$85.-  
TLK-PEEL PEEL Learn Kit \$85.- TLK-8051 8051 Learn Kit \$85.-

- Enable beginners to design their own PLD/PEEL/GAL/MPU within a short period of time.
- Design & Experiments manuals and Experiment PCB Kit

Call us today for complete product line

- 1-year warranty 30 days money back guarantee

**TRIBAL MICROSYSTEMS**

Tel: (415)623-8859 Fax: (415)623-9925  
44388 S. Grimmer Blvd. Fremont CA 94538

CIRCLE NO. 758

## DEVELOPERS' TOOLS

The Total Solution Programmer  
The best-selling Programmer since 1985  
Appreciated by over 50,000 users worldwide

TUP-300  
Universal Programmer  
& Tester (PC based)  
from \$595.-

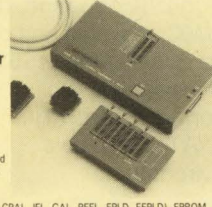

- 40 Pin ZIF socket can be expanded up to 68 Pin for 8 to 68 Pins DIP or PLCC chips.
- Programs 20 to 68 Pin PLD (PAL, CPAL, IFL, GAL, PEEL, EPLD, EEPLD), EPROM (up to 16 Mbit), EEPROM, Serial PROM, Special PROM, Bipolar PROM & MPU (8741/42/48/49, 8051/61FA, FB, PC/521/541/252/751/752/552/451, 8796/97, 68705, 2866/1121, TMS7742, TMS77C82, 8755A, ...)
- Tests TTL (74/54), CMOS (40/45), SRAM, DRAM, SIP DRAM and SIM DRAM.
- Full screen edit, HEX to OBJ, 2-way or 4-way Binary File Splitter and Shuffler, 6 MPU Dis-assemblers.
- 34 various adapters (4 sockets, ROM-RAM, PLCC, ...) from \$95.
- Other high quality programmer cards at low cost available from \$119.-
- UV Eraser (UV-32) for 32 pcs at \$95.

Call us today for complete product line

- 1 year warranty, 30 days money back guarantee
- 1 year free software updates and Customer Support

**Distributors  
Are  
Welcome**

**TRIBAL MICROSYSTEMS**

Tel: (415)623-8859 Fax: (415)623-9925  
44388 S. Grimmer Blvd. Fremont CA 94538

CIRCLE NO. 759

## LEMO'S NEW CIRCULAR CONNECTOR CATALOG

LEMO's new circular connector catalog highlights expanded shell and insert designs. Insert configurations are available in single, multi or mixed designs including signal, coaxial, triaxial, high voltage, fiber optic and fluidic/pneumatic. Shell styles are available in standard chrome plated brass, anodized aluminum or stainless steel.

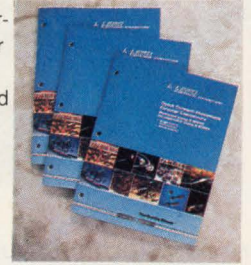

**LEMO USA INC**

P.O. Box 11488, Santa Rosa, CA 95406  
Phone (800) 444-LEMO, Fax 707/578-0869

CIRCLE NO. 760

The PC/XT™ Designed For Embedded Control

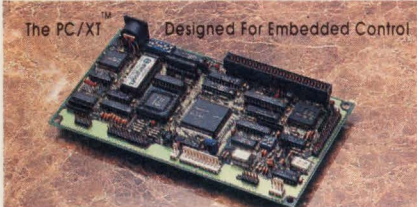

**FEATURES: (T7000/T7100)**

- On Board Rom Dos. (T7100 Only)
- On Board Power
- 80C88 CPU with 4.77MHz/12MHz operation (H/W, S/W, Selectable)
- On Board 640KB DRAM, 100% Compatible with PC XT™
- "Go Anywhere" Size and Low Power
- Board Size is 110mm x 200mm
- Low Power consumption, 300 mA/12MHz operation 220 mA in sleep mode.
- Support CRT or LCD
- Directly drives Mono or Colour CRT, or drives CGA 640 x 200 Single Screen LCD panel with 8 gray levels.
- Built in Multi Functions
- One printer port
- One serial port
- FDC controller (1.2MB/360K, 1.44MB/720K)
- One expansion slot
- Low cost: US\$249/US\$274 (FOB Taiwan)

OEMs Welcome!



**Tidalwave Microtech Inc.**  
3F, NO. 7, LANE 50, SEC. 3 NAN KANG RD.,  
TAIPEI, TAIWAN, R.O.C.  
(Far East ABC Wisdom Industrial Park)  
TEL: 886-2-7861680 / 7859140 / 7859141  
FAX: 886-2-7859142

CIRCLE NO. 761

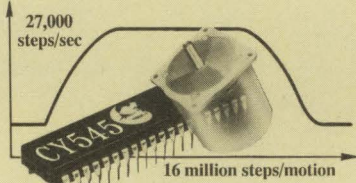

## STEP MOTOR CONTROL

27K steps/sec! 16 Million steps!

New CY545. Rates up to 27K steps/sec, up to 16 million steps per single motion. Separately programmable start rate, accel/decel rate, and max rate. Pulse & direction output. External jog mode and limit switch detection. Serial or parallel interface, LED/LCD & Thumbwheel interface lines, and more. ASCII commands. Supports 64K external memory. CMOS 40-pin DIP. \$75 each (\$25/1000). Credit Cards OK.



**Cybernetic Micro Systems**

Box 3000, San Gregorio CA 94074  
(415)726-3000 Tlx: 910-350-5842

CIRCLE NO. 762

**NEW!** iceMASTER™  
COP8 8051 68HC11



**YOUR WINDOW TO EMULATION PRODUCTIVITY**

- Easy to learn & use
- Windowed interface -- user configurable
- FAST! Download -- < 3 sec. typ. at 115KB
- Source Level debug

- A 4K frame trace buffer with advanced searching capabilities.
- Hyperlinked On-line help guides you through the emulation process.
- iceMASTER connects easily to your PC, requires no disassembly, or expansion slots. Works on any PC (DOS or OS/2), MicroChannel or EISA. Even laptops!
- Supports more than 50 different 8051 family derivatives. M68HC11 support will be available early in 1991.
- Try iceMASTER risk free! Satisfaction Guaranteed or return for a full refund!\*
- RENTALS AVAILABLE! Ideal for consultants and researchers!
- Call today for free demo disk and ask about a free 8051 Macro Assembler! (800) 638-2423

**Metalink Corporation**

Metalink Corporation P.O. Box 1329 Chandler, AZ 85244-1329  
Phone: (602) 926-0797 FAX: (602) 926-1198 TELEK: 4998050MILINK  
\* With 10-day trial period

**FREE ASSEMBLER**

CIRCLE NO. 763

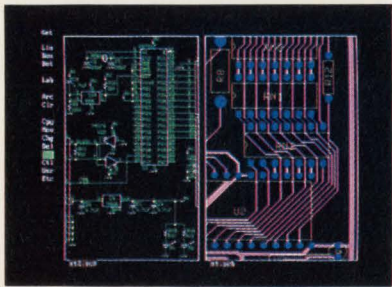

## New Schematic and PCB Software

With support for extended and expanded memory, HiWIRE II can handle your most demanding schematic and PCB designs quickly and easily. The unique HiWIRE editor allows you to display and edit schematics and PCBs simultaneously, using the same commands for each. HiWIRE II is \$995, and is guaranteed.

**Wintek Corporation**

1801 South St., Lafayette, IN 47904  
(800) 742-6809 or (317) 448-1903

CIRCLE NO. 764

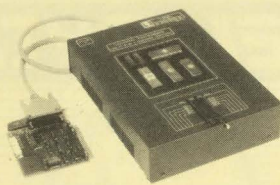

**PC BASED UNIVERSAL DEVICE PROGRAMMER** \$695/895

- Programs EE/PROMS, PALS, GALS, EPLDs, MICROS, BIPOLARS, PEELS.
- Software driven pin drivers. D/A generated programming voltages (8 bit DACs) used to generate voltages from 5-25V with 0.1V resolution for all 40 pins
- Upgradeable for virtually any future programmable devices up to 40 pins.
- Self subsistent operation. No additional modules or plug-in adapters required.
- Includes user friendly MEMORY BUFFER FULL SCREEN EDITOR.
- Commands include: Fill, Move, Insert, Delete, Search, ASCII or HEX entry.
- Friendly Menu-Driven interface. Device selection by P/N and manufacturer.
- Supports 8/16/32 bit data word formats.
- Programming algorithm: Normal, Intelligent I&I, Quick Pulse Programming.
- Verify operation performed at normal & worst case operating voltage.
- Functional test: JEDEC standard functional testing for logic devices.
- TTL Logic functional test for 74xx/54xx series devices.
- File formats accepted: JEDEC (full), JEDEC (kernel), Binary, MOS Technology, Motorola Hex, Intel Hex, Tektronix Hex.
- Customer support via voice line, fax & dedicated BBS. Full 1 year warranty.
- Base price: \$695 includes Interface card, cable, Memory/Micro/Bipolar library and 1 year free updates. \$895 with additional Logic Device Library.
- Library updates can be received via floppy or Customer Support BBS.

MC / VISA / AMEX

Call today for datasheets!



**B&C MICROSYSTEMS INC.**  
750 N. Pastoria Ave., Sunnyvale, CA 94086 USA  
TEL: (408) 730-5511 FAX: (408) 730-5521

CIRCLE NO. 765

## Interactive/Real-Time

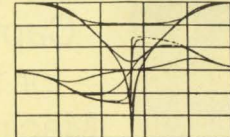

## Analog Circuit Simulation

ECA-2 Electronic Circuit Analysis offers: • AC, DC, Transient, Fourier, and Temperature Analysis with Nominal, MonteCarlo and/or Worst-Case component values • Interactive or batch modes • Full nonlinear simulation • Sine, Pulse, PWL, SFFM, and Exponential generators • IBM PC/Mac • Multiple plots • On-line real time graphics - 2 to 50 times faster than SPICE • Over 500 nodes • Advanced component parameters • Component optimization sweeping • Full editing, built-in or external • New detailed 424 page manual

Call for FREE DEMO!

**Tatum Labs, Inc.**

3917 Research Park Dr. B-1, Ann Arbor, MI 48108  
313-663-8810

CIRCLE NO. 766

To advertise in Product Mart, call Joanne Dorian, 212/463-6415





**'488 CONTROL FOR YOUR MACINTOSH II**

Control any instrument in minutes.  
Supports BASIC, Pascal, C and Hypertalk.  
HyperCard utilities included.  
Software library. Risk free guarantee.

**cec** Capital Equipment Corp.  
Burlington, MA. 01803

Informative catalog 800-234-4232  
Applications help (617) 273-1818

CIRCLE NO. 767

**TOTAL RECALL**

Fairchild's new **MIL-STD-1553 Data Logger/Processor (DL/P)** with our **DBMC** captures and processes unlimited quantities of **1553 bus traffic** with full error and timing information in an IBM PC/AT compatible environment.



**FAIRCHILD**  
DEFENSE

Marketing: (301) 428-6629 • Telefax: (301) 428-6885  
20301 Century Boulevard • Germantown, MD 20874-1182

CIRCLE NO. 768

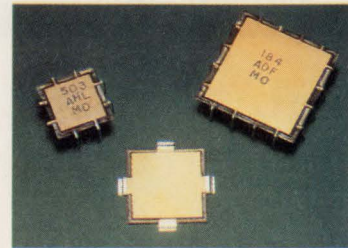

**CUT PGA NOISE**

Micro/Q (R) 3000 capacitors reduce noise associated with PGA and PLCC devices. Designed to be mounted under the device, take no extra board space. Can be used under MPUs, Gate Arrays, and ASICs. Choose from Z5V, X7R, and P3J dielectrics. Available in both thru-hole and surface mount versions. Several sizes available to fit all devices.

**Rogers Corp.**

2400 South Roosevelt St., Tempe, AZ 85282

**(602) 967-0624**

CIRCLE NO. 769

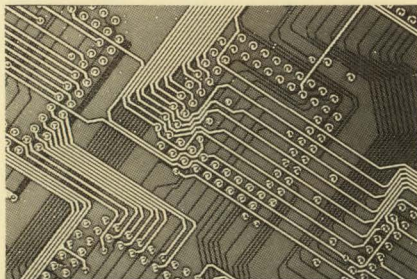

**Your reliable & economic source for printed circuit boards.**

We offer a wide range of double-sided & multilayer PCBs with high reliability fast service, top quality and competitive price. We can help you become more effective & profitable through the next decade. Don't hesitate! Contact us now!

SALES AGENTS WANTED.



**GBC GLOBAL PMX CO., LTD.**  
12TH FL., NO. 689, CHUNG SHAN N. RD.  
SEC. 5, TAIPEI, TAIWAN, R.O.C.  
TEL: 886-2-8356244 FAX: 886-2-8356254

CIRCLE NO. 770

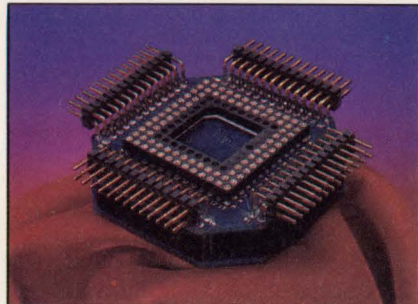

**Full Line of PQFP Adapters**

- At the prototyping stage, use a PQFP Adapt-A-Board™ Extends leads for easy wire wrapping.
- For emulation, use an Adapt-A-Pod™ like the one shown here for an 80386 PQFP package. Just plug and play.
- For production testing, a Bug Katcher™ turns your PQFP into an IC so you can start testing—ASAP.
- We stock all types of PQFP adapters. Quick turnaround on custom orders. Free catalog.

Emulation Technology, Inc.  
2368-B Walsh Ave. Santa Clara, CA 95051  
Phone: 408-982-0660 FAX: 408-982-0664



CIRCLE NO. 771

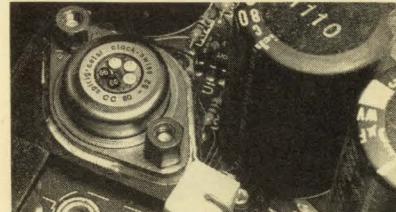

**Put a low cost temperature monitor CelsiClock® on any surface.**

The indicating triangle of the CelsiClock® labels turns permanently black when the surface reaches the specific «switch» temperature level of that triangle. Highly reliable labels are available as single temperature spots or in multiple sequenced temperature increments. Labels are self-adhesive and quickly placed on any dry surface. Temperature ranges from 105° F (40° C) to 550° F (260° C). FREE SAMPLE on all inquiries. **CELSI's, the reliable «Temperature Watchdog» for years.**

**SAT** Solder Absorbing Technology Inc.

144 Oakland Street, Springfield MA 01108  
(413)788-6191/call TOLL FREE (800)628-8862  
Fax (413)788-0490

CIRCLE NO. 772



**Schematic Capture for the Macintosh**

**DESIGNWORKS**

**Schematic features** Menu-driven, mouse-controlled operations • cut/copy/paste between circuits • right-angle rubber-banding. **Digital simulation** 13-state, event-driven simulation • logic analyzer-style timing window • PLD support. **Libraries** Fully-simulated 7400, 4000, 10K series, PLDs, PROMs and RAMs, non-simulated analog and discrete components • User-definable, simulated custom symbols. **Interfaces** Formats for Douglas CAD/CAM, Cadnetix, Calay, Orcad, Tango, Racal Redac, Spice. • user-definable printers, dot-matrix printers, HP, Houston, Roland pen plotters. **Requirements** Macintosh Plus, SE, II, Ix, Ixc, or Icii.

CALL (604) 669-6343 FOR YOUR FREE DEMO DISK TODAY.

CAPILANO COMPUTING SYSTEMS LTD.

CIRCLE NO. 773

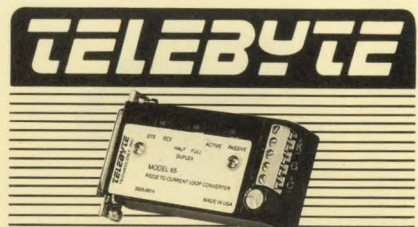

**RS-232 TO CURRENT LOOP CONVERTER**

MODEL 65 - OPTICALLY ISOLATED

CALL 1-800-835-3298

- ACTIVE/PASSIVE LOOPS
- 9.6 KBAUD
- 20/60 MA OPERATION
- HDX/FDX
- DTE/DCE SELECT
- SELF POWERED

**\$109**

**TELEBYTE** TECHNOLOGY, INC.  
270 E. Putnam Rd. Greentown NY 11740 • 516-423-3232/516-385-8080  
1-800-835-3298 • FAX: 516-385-8184

CIRCLE NO. 774



**Design, Program, Test**

**TURPRO-1** Universal Pin Driven I.C. Programmer  
Current and Future Devices Supported

- PALs, GALs, PEELs, PLDs, FPGAs, E/PROMs, PROMs, MPUs, etc.
- 8-40 Pins DIP and 20-188 Pins PLCC Packages.
- PC Remote Control via RS232C or Parallel Port.
- **I.C. MFR. Approved** • Self-Contained Power Supply + 2 CPUs.

=== Only \$1,450 for ===

State-of-the-Art Performance

**SYSTEM GENERAL** Tel. 408-263-6667 Fax: 408-262-9220

CIRCLE NO. 775

To advertise in Product Mart, call Joanne Dorian, 212/463-6415



## \$249. TERMINAL

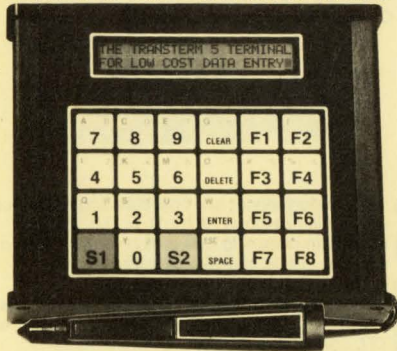

- Featuring
- Standard RS-232 Serial Asynchronous ASCII Communications
  - 48 Character LCD Display (2 Lines of 24 Each)
  - 24 Key Membrane Keyboard with embossed graphics
  - Ten key numeric array plus 8 programmable function keys
  - Optional RS-422 multidrop protocol mode
  - Keyboard selectable SET UP features—baud rates, parity, etc.
  - Size (5.625" W x 6.9" D x 1.75" H), Weight 1.25 lbs.
  - 5 x 7 Dot Matrix font with underline cursor
  - Displays 96 Character ASCII Set (upper and lower case)
  - Optional Bar Code Wand (shown)

COMPUTERWISE, INC.

302 N. Winchester • Olathe, KS 66062 • 800-255-3739 • FAX (913) 829-0810

CIRCLE NO. 776

## DEVICE INTERCONNECT

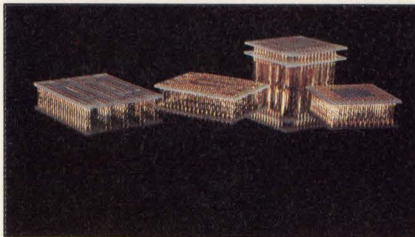

### SOLUTIONS

IRONWOOD Electronics offers a comprehensive line of devices for your interconnect needs. We have hundreds of prototyping adaptors and sockets for PGA, QFP, PLCC, LCC, PGA, ZIP, and many more packages. Our line of clips for probing all different sizes of the different packages also number in the hundreds. We also do custom designs quickly and inexpensively including SMT components and tight spacing and supply the highest quality solutions. Call us for your interconnect needs.

IRONWOOD ELECTRONICS

P.O. BOX 21151, ST. PAUL, MN 55121  
(612) 431-7025; FAX (612) 432-8616



CIRCLE NO. 777

## PLCC LoClip - PLCC Probe

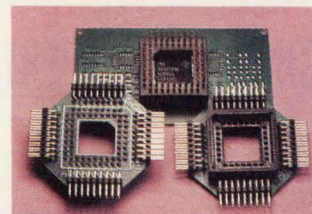

### NEW PRODUCT

The PLCC-LoClipXX line from Ironwood is a new product line allowing probing of surface mount PLCC's at a fraction of size of other clips. The U and L ver. have right angle leads (cable connect or probing). Device heights of 0.75", 0.57", and 0.45" for S, U, and L boards respectively enable probing of boards in backpanels. Interdevice spacing of 0.10" allowed. PLCC's from 24 to 84 pins supported. Kits of 10 with different sizes/carrying case available at substantial discount.

IRONWOOD ELECTRONICS

P.O. BOX 21151, ST. PAUL, MN 55121  
(612) 431-7025

CIRCLE NO. 778

## Protel Autotrax™

Best PCB design solution for mixed Digital, Analog, and SMT boards

Our NEW and POWERFUL Protel Autotrax™ is a fully integrated PCB layout system with automatic component placement and autorouting in a single working environment. Its latest features will definitely push the price/performance of mixed technology PCB designs to the highest level, boost your design productivity, and deliver your products to the marketplace faster than your competitors.

- Integrated automatic component placement and autorouting
  - On-the-fly library components creation
    - 45°, 90° and curve tracks routing
    - Powerful user-definable Macros
    - Auto-panning
    - PostScript™ printing
    - Switchable Metric/Imperial grid
    - Intelligent Pad to Pad autorouting
    - Automatic power/ground relief for SMD pads
- Automatic Copper Pour leaves clearance for tracks & pads
- From schematic design, manual and automatic PCB design, Rip-up and Retry autorouting, to Gerber viewing and editing, we offer free tech and EMS support, 24-hour BBS and 50-day money back guarantee and our prices start at \$395.

### Free Evaluation Package

Toll Free: 800-544-4186

Protel Technology, Inc.  
50 Airport Parkway, San Jose, CA 95110  
Tel: 408-437-7771 Fax: 408-437-4913



CIRCLE NO. 779

## LOW COST Data Acquisition Cards for PC/XT/AT

### 12 Bit A/D & D/A [PCL711S] \$295

- A/D converter: 8 single-ended channels; Uses AD574 device; Conversion time is less than 25µsec; Input range: ±5V; Software Trigger Mode only.
- D/A converter: 1 channel; 12 bit resolution; 0 to +5.10V Output Range.
- Digital I/O: 16 In/Out (TTL compatible); External Wiring Terminal Board incl.
- Utility Routines and Demo/Sample Programs for BASIC and Quick-BASIC.

### 12 Bit A/D & D/A [PCL812] \$395

- A/D converter: 16 single ended inputs; Uses AD574; Conversion time less than 25µsec; Built-in programmable pacer; Input Ranges: ±10V, ±5V, ±1V.
- D/A converter: 2 channels; 12 bit resolution; Output Range 0-5V.
- Digital I/O: 16 In/Out (TTL compatible); Programmable Counter/Timer (8254).
- DMA and interrupt capability. Utility software and sample program in BASIC.

### Fast 12 Bit A/D/A [PCL718] \$795

- A/D converter: 16 single ended or 8 differential channels; 12 bits resolution; Programmable scan rate; Built-in Interrupt and DMA control circuitry. Conversion speed 60,000 samples/sec (standard), 100,000 samples/sec (optional).
- Input Ranges: Bipolar: ±10V, ±5V, ±2.5V, ±1V, ±0.5V; Unipolar: 0-5.2, 1V.
- D/A converter: 2 channels; Resolution: 12 bits; Settling time: 5µsec; ±5V.
- Digital I/O: 16 In/Out (TTL compatible); Programmable Counter/Timer (8254).
- Software: Utility software for BASIC & QuickBASIC included. Sample prgm. Supported by Lab/DAS, ASSYST, LABTECH, LinkScope.

### 6 Channel 12 bit D/A [PCL726] \$495

- Output Ranges: 0 to +5V, 0 to +10V, ±5V, ±10V, or sink 4-20mA.
- Settling time: 70µs. Linearity: ±1/2bit; Voltage output drive capacity: ±5mA.
- Digital I/O: 16 digital input and 16 digital outputs (TTL compatible).



B&C MICROSYSTEMS INC.  
750 N. Pastoría Ave. Sunnyvale, CA 94086 USA  
TEL: (408)730-5511 FAX: (408)730-5521

CIRCLE NO. 780



## AS 168 Energy Limiting Circuit Breaker

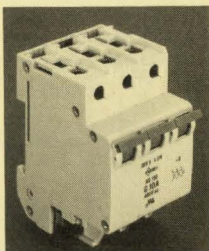

- Superior Short Circuit Protection
- Selective Disconnection - No nuisance shutdown
- Easy Installation with Quick Connect Terminals, screw terminals, or DIN Rail Mounting
- Worldwide Approvals, VDE, UL, & CSA
- Single, Double, Triple, and four pole versions
- Current Ratings - 0.5 to 50 Amp
- AC rating to 480 and DC rating 120 Volts per pole
- Available with Switched Neutral, Auxiliary and Signal contacts
- Stock available in Connecticut

Contact: Inmark Corporation, 4 Byington Place  
Norwalk, CT 06850 Telephone: 203-866-8474  
Fax: 203-866-0918

CIRCLE NO. 782

## Instant Microcontroller



### Instant C Programming

Don't use a microprocessor, use a SmartBlock™ microcontroller module to build your custom controller. Our low cost Dynamic C™ makes programming a snap. 3.5 x 2.5 inch module includes microprocessor, memory, time/date clock, eeprom, watchdog, serial ports and more. As low as \$59 in quantity. The efficiency of a custom design without the headaches.

### Z-World Engineering

1340 Covell Blvd., Davis, CA 95616 USA

Tel: (916) 753-3722

Regular Fax: (916) 753-5141

Automatic Fax: (916)-753-0618

(Call from your fax, hear computer voice, use touchtone dial to request desired data sheets.)

CIRCLE NO. 783

## Telecom Solutions from Teltone

### Call Progress Tone Detectors

Tone detector ICs for all telecom products. 5-volt, 3.58 MHz time base, tri-statable outputs.

- M-980 band pass detector from 340 Hz to 620 Hz. Ideal for detecting non-precise call progress tones.
- M-981 provides precise detection of 350, 400, 440, and 480 Hz. 22-pin.
- M-982 provides precise detection of 350, 440, 480, and 620 Hz. 22-pin.

1-800-426-3926

Or: 206-487-1515 Fax: 206-487-2288

TELSTONE®

INNOVATING SOLUTIONS

In Telecom Interface Components

Teltone Corporation, 22121-20th Avenue SE, Bothell, WA 98021

CIRCLE NO. 784

To advertise in Product Mart, call Joanne Dorian, 212/463-6415



## DC/CAD

CAD Showdown Results!

# HIGH DENSITY EXPERTS!

### Schematic Capture + PCB Layout + Autorouting

Top-rated DC/CAD out-routed the competition in the 1990 CAD Showdown. Routing the challenging benchmark on a double-sided board while competing routers used four to six layers, DC/CAD displayed the power and flexibility needed in a top-notch design package to tackle high density board jobs. This non-copy protected package with surface mount support includes:

- High capacity schematic capture
- Multi-strategy 1-mil parts autoplacer
- 1-mil autorouting w/ripup & retry
- Thorough annotating design rule checker
- Full 2-way GERBER and DXF support
- Optional autoground plane support with cross-hatching
- Optional protected-mode version for 386 Users and much more!

CALL TODAY. Priced at \$495.

Call today  
for DC/CAD  
Priced at \$495



DESIGN  
COMPUTATION

Rt. 33, Sherman Square Farmingdale, NJ 07727  
(201) 938-6661 • (201) 938-6662 (FAX)

Smart Software for Tough Board Design.

CIRCLE NO. 785

## SUPER UNIVERSAL PROGRAMMER



NEW!

SUPERPRO  
\$795

### FREE MULTIMETER SPECIAL

- programs • PAL, EPLD, GAL, PEEL, FPL (up to 68 pin PLCC)
- E(E) PROM, Flash EPROM up to 4 Mbits (40 pins)
- Microcontroller, Bipolar PROM.
- Tests TTL/CMOS Logic, D/S Memory Device.
- High speed parallel interface card to PC/XT/AT/386
- Pull-down Menu driven, Library Operating software.
- Fast Device update on user's request
- 40-pin Gold ZIF Socket
- Lifetime Free Updates (BBS)
- User Device Library Generator (optional)

Call 1-800-541-1975

764 San Aleso Ave.  
Sunnyvale, CA 94086  
TEL(408)745-7974  
FAX(408)745-1401

**XELTEK**

CIRCLE NO. 786

## MCP-550 Complete Data Acquisition Card

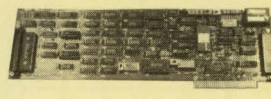

- High performance, low cost data acquisition card with multi-functions: A/D, D/A, D/I, D/O
- Maximum sampling rate of 100K samples/sec (option) or 60K samples/sec (standard)
- Industry standard 12-bit resolution
- 16 single ended or 8 differential A/D channels
- Two 12-bit monolithic multiplying D/A channels
- TTL compatible 24 D/I & D/O channels
- Switch selectable analog input range: 0-10V or +10V
- With MCE-730: a versatile 16 channel analog input multiplexing and signal conditioning card
- Complete support of vendor application S/Ws such as Labtech Notebook, ASYST...

**XELTEK**

764 San Aleso Ave.  
Sunnyvale, CA 94086  
TEL(408)745-7974  
FAX(408)745-1401

CIRCLE NO. 787

## Wave Form 20MHz - 32K \$1290

The WSB-100 Wave Form Synthesizer Board from Quatech has the best set of numbers in the market. With speed to 20MHz and a 32K memory at \$1290, it's making waves in more ways than one. The WSB-100 is also a star performer as a digital pulse/word generator with the optional digital module.

Call for our free  
PC Interface Handbook  
**1-800-553-1170**

**QUATECH**

662 Wolf Ledges Parkway  
Akron, OH 44311

CIRCLE NO. 788

## RS-422/RS-485 Boards for AT, Micro Channel

RS-422/RS-485 asynchronous serial communication boards from Quatech available in 1 to 4 ports for PC-AT and compatibles and 1 to 4 ports for PS/2 Micro Channel.

Call for our free  
PC Interface Handbook:  
**1-800-553-1170**

**QUATECH**

662 Wolf Ledges Parkway  
Akron, OH 44311

PC-AT, Micro Channel, and PS/2 are trademarks or registered trademarks of IBM Corp.

CIRCLE NO. 789

## RELIABILITY PREDICTION SOFTWARE

### ARE YOUR PRODUCTS RELIABLE?

The RelCalc 2 Software Package predicts the reliability of your system using the part stress procedure of MIL-HDBK-217E, and runs on the IBM PC and full compatibles. Say goodbye to tedious, time consuming, and error prone manual methods! RelCalc 2 is very easy to use, and features menu windows, library functions, global editing for what-if? trials, and clear report formats. Try our Demo Package for \$25.

**T-CUBED SYSTEMS**, 31220 La Baya Drive #110, Westlake Village, CA 91362. (818) 991-0057 • FAX: (818) 991-1281

CIRCLE NO. 790

## X.25 SDLC QLLC HDLC ADCCP PAD

- C source code
- ROM-able
- Full porting provided
- No OS required

**GCOM**

GCOM, Inc.  
1776 E. Washington  
Urbana, IL 61801  
(217) 337-4471

Specialists in Computer Communications  
FAX 217-337-4470

CIRCLE NO. 791

## There is a Difference. Lifetime Free Updates

EP-1140  
\$895



A programmer is not just another programmer. That is why BP Microsystems is committed to bringing our customers the highest quality programmers at an affordable price. This commitment is evident in our EP-1140 E/EPROM programmer supporting thousands of 24-, 28-, 32- and 40 pin devices. A 32-pin model, EP-1132, is available also for \$895. And, all of our programmers include future chip support at no charge and an unconditional money back guarantee.

**BP MICROSYSTEMS**  
**1-800-225-2102**  
(713) 461-9430

CIRCLE NO. 792

## 48 Channel 50MHz Logic Analyzer

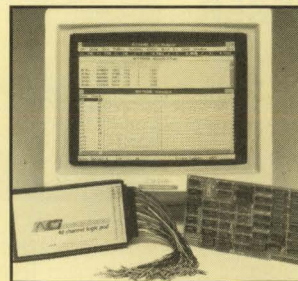

**Complete System \$1895.00**  
New Windows 3.0 Compatible Software

- 48 Chnls @ 50 MHz x 4K words deep
- 16 Trigger Words/16Level Trigger Sequence
- Storage and recall of traces/setups to disk
- Disassemblers available for: 68000, 8088, 8086, 6801, 6811, Z80, 8085, 6502, 6809, 6303, 8031

**NCI** 6438 UNIVERSITY DRIVE,  
HUNTSVILLE, AL 35806  
(205) 837-6667 FAX (205) 837-5221

CIRCLE NO. 793

To advertise in Product Mart, call Joanne Dorian, 212/463-6415



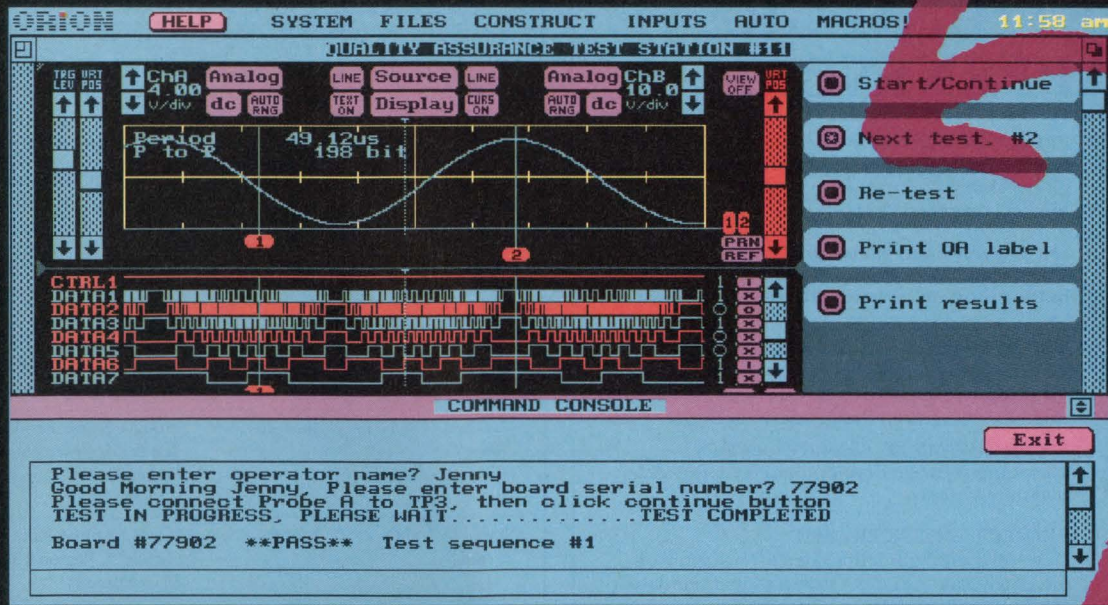

# If you want to slash test set-up and debug time, click here.

## OMNILAB™ INTEGRATES SIX INSTRUMENTS INTO A POWERFUL TEST PROGRAMMING ENVIRONMENT.

Develop complete functional test set-ups in 1/10th the time with OmniLab — the PC-based Programmable Test Station that integrates six test instruments into one fast and easy programming environment. Quickly develop automated test set-ups for pilot production runs or manufacturing tests.

OmniLab invokes the power of hundreds of



OmniLab's shown: self-contained portable with built-in 386SX computer and rack/stack model that connects to any IBM PC/AT, 386, or PS/2.

lines of test program code with a few mouse clicks. Interactive software eliminates the editing, compiling, linking and most debugging tasks. OmniMacros™ speed the entire process by recording test set-ups on-the-fly.

Save time troubleshooting hard-to-find faults, too. Mixed A/D Triggering™ and time correlated 100 MHz analog and digital displays easily capture elusive bugs and mixed mode problems that stump other instruments

What's more, OmniLab pleases both design and manufacturing managers. It's a snap to reconfigure. Designers can zip through their R&D test chores and manufacturing won't tie up expensive ATE equipment for prototype production runs.

Thanks to convenient pull-down menus and an intuitive graphical user interface, training is fast and easy.

If you're like most test engineers, up to 75% of your set-up time is spent developing programs. OmniLab cuts that job down to size.

**FREE KIT—FREE VIDEO**  
**Before you start another test set-up, call for your FREE Test Express Kit and video tutorial. See how easy it is to let OmniLab slash set-up and debug time.**

**Call: 800/729-7700**

Or, fax your request to 415/327-9881

**ORION**  
 INSTRUMENTS

Orion Instruments, Inc.  
 180 Independence Drive  
 Menlo Park, CA 94025  
 415/327-8800

©1990 ORION Instruments, Inc. OmniLab, OmniMacros, and Mixed A/D Triggering are trademarks of Orion Instruments, Inc.



# SOMETHING GREAT IS HAPPENING...

## We Are

*At GE Medical Systems there is a unique spirit.* It is the feeling that comes when you are a true global leader and innovator in state-of-the-art medical diagnostic systems.

*Our people are part of that spirit.* Smart. Proud. Thinkers and Doers working with an elite group in the evolution of diagnostic imaging systems.

## We Need

### SOFTWARE ENGINEERING MANAGER

Lead the development of real-time software for diagnostic imaging systems, using computer aided tools and structured design methodology.

**Requires:** BS/MS EE, CE and experience managing software development for large-scale real-time systems.

### PROJECT ENGINEER - EMI

Develop design guidelines/tests for diagnostic imaging systems to meet international regulatory requirements for EMI/EMC; define project tasks and schedules; track progress.

**Requires:** BS/MS EE, ME and EMI, electronic packaging/power grounding/cabling design experience, domestic/international regulatory requirements knowledge.

### PERFORMANCE FEEDBACK

#### PROJECT LEADER

Design and implement product performance feedback process, including a cause and effect failure analysis mechanism and associated tools.

**Requires:** BS/MS EE, CS, ME, project leadership background, and quality data analysis, program planning and design or manufacturing experience.

### SOFTWARE SYSTEMS ENGINEER

Specify and develop software for applications/data acquisition/display or diagnostics.

**Requires:** BS/MS EE, CS and real-time/scientific software design experience, including 'C' and Unix.

### SOFTWARE DEVELOPMENT ENGINEER

Develop X-Ray product applications/diagnostics/calibration software and participate in cross-functional designs/reviews.

**Requires:** BS/MS EE, CS and structured software development, PL/M86 and INTEL microprocessor experience, digital hardware knowledge.

### ELECTRICAL DEVELOPMENT ENGINEER

Design complex circuit boards encompassing low signal analog control, position and velocity feedback servos and phase lock loop circuitry.

**Requires:** BS/MS EE and experience in analog control systems design and development.

## How To Reply

GE's highly competitive salary and benefits benefit an industry leader. Please send resume in strict confidence to: JMB, GE Medical Systems, P.O. Box 414, W-407, Milwaukee, WI 53201. *Replies will be made, within 20 days, to candidates of interest.*



**GE Medical Systems**

An Equal Opportunity Employer

# CAREER OPPORTUNITIES

## 1991 Recruitment Editorial Calendar

Issue	Issue Date	Ad Deadline	Editorial Emphasis
Magazine Edition	June 20	May 30	Software, ICs & Semiconductors, High Speed Memory Technology • Computer Bus Boards
News Edition	June 27	June 7	ICs & Semiconductors, RISC**, Regional Profile: So. California**
Magazine Edition	July 4	June 13	Product Showcase—Volume I • Interconnects, ICs & Semiconductors • Neural Networks • Power Sources, Software
Magazine Edition	July 18	June 26	Product Showcase—Volume II • Test & Measurement, Computer Peripherals • Components, CAE/ASICs •
News Edition	July 25	July 5	ICs & Semiconductors, Peripherals**, Regional Profile: Massachusetts**
Magazine Edition	Aug. 5	July 11	CAE • ASICs, Test & Measurement • Computers & Peripherals • Technical Article Database
News Edition	Aug. 8	July 19	CAE, Datacom**
Magazine Edition	Aug. 19	July 25	Military Electronics Special Issue, Image Processing • Ultra High Speed ICs/ASICs • Computer Peripherals, Software •
News Edition	Aug. 22	Aug. 2	Peripherals/Components, Test & Measurement**, Regional Profile: Idaho, Colorado, Utah**
Magazine Edition	Sept. 2	Aug. 8	ASICs Special Issue, Semicustom ICs • CAE, Packaging • ICs & Semiconductors Data Converters
News Edition	Sept. 5	Aug. 16	Military Electronics Special Issue, Computer Architectures, Defense Electronics**
Magazine Edition	Sept. 16	Aug. 21	DSP/Microprocessors, ICs & Semiconductors, CAE/ASICs, Environmental Engineering • Software
News Edition	Sept. 19	Aug. 29	RISC/ICs, Computers**, Regional Profile: Florida**
Magazine Edition	Oct. 1	Sept. 5	Computers & Peripherals/Networks, DSP Chip Directory • ICs & Semiconductors/Memory Technology, Instrumentation
News Edition	Oct. 3	Sept. 13	ICs & Semiconductors, Multimedia**
Magazine Edition	Oct. 10	Sept. 19	Test & Measurement Special Issue, Oscilloscopes, VXI Board Directory • CAE/ASICs, Sensors & Transducers •
News Edition	Oct. 17	Sept. 27	ATE/Board & IC Testing, Artificial Intelligence**, Regional Profile: New Mexico & Arizona**
Magazine Edition	Oct. 24	Oct. 3	Telecommunications ICs, Graphics & Video Circuits, Computers & Peripherals, Software, Wescon Preview Issue

Call today for information on Recruitment Advertising:

East Coast: Janet O. Penn (201) 228-8610

West Coast: Nancy Olbers (603) 436-7565

National: Roberta Renard (201) 228-8602



# ADVANCED MICRO DEVICES IS COMIN' THROUGH IN TEXAS!

AMD is a billion dollar high technology company with a solid business plan in place to take us through the '90s and beyond. EPROMs, microprocessors and PLDs will provide the volume. And we're focused on the leading edge technologies driving the fourth wave of computing—networked computers.

## Manager Quality Assurance

Requires 5+ years' related experience in semiconductor fabrication and test. Will manage QA organization which includes incoming materials, quality audit, supplier relationships and enhancement of quality system. Management experience, data analysis and interpretation skill, as well as effective problem solving skills are a must.

## Process Engineers

BS or MS in Electrical Engineering with 2-3 years' experience in photolithography with ASM steppers is desired. Extensive background in positive resist/coat and development using SQC is a plus.

## Sr. Mask Designers

Your background must include CMOS IC layout experience with a heavy emphasis/exposure to CAD tools. Must have hands on experience with place & route tools, LVS, chip planning, die size estimating and other advanced layout functions. Project leadership experience as well as UNIX, "C" and Mentor experience are preferred.

## Mgr., Quality and Reliability Engineering

Requires 5+ years' experience in managing quality and reliability in IC wafer fabs and product development departments. Will design new systems, recommend equipment purchases and develop/implement plans to address areas for improvement. BS/MS degree required.

## Sr. Quality and Reliability Engineers

Requires 3+ years' experience in statistical design of experiments and data analysis. Will determine and implement new ways in which process and product reliability can be evaluated. Will cover all aspects of manufacturing from incoming material to customer returns. BS degree minimum.

## Device Analysis Engineer

Requires experience in failure analysis, circuit analysis, process technology, testing, microprobing and device processing. Must understand circuit schematics, test dialogs and circuit layouts. Technical bachelors degree minimum.

We are an equal opportunity employer.  
Trademarks are registered to their respective companies.

## Microprocessor Design/Development Engineer

Requires systems/logic VLSI design experience of 32-bit microprocessors. Will design from product definition through production transfer. Product definition and design methodology experience a plus. BS/MS degree required.

## Senior Process Technicians

An Associates degree with a minimum of 2 years' experience in sustaining a photolithography line is required. Applicants must demonstrate a working knowledge of steppers, positive resist coat development tracks. In addition, experience in the following areas is also desired: ASM Steppers, Perkin-Elmer Aligners, SVG & SSI Coat and Develop Tracks, SPC/SQC—on all of above data collection using computer statistical software.

## Equipment Maintenance Technicians

Requires an Associates degree with 2+ years' experience working in a wafer fab environment. Familiarity with diffusion, thin film, plasma etch and/or photolithography equipment essential.

## Sr. Operations Analyst

Requirements include extensive experience with IBM 3090 Series mainframe computer running the MVS Operating System. Must have expertise with JCL, JES2, Tape Management Subsystems, DASD Management, Batch Processing and Network Management. Will be responsible for monitoring and insuring continuous operation of our IBM/MVS Computer Environment and contribute to various operational projects. BS degree minimum.

Qualified applicants should send a resume to: **Advanced Micro Devices, MS-556, 5204 E. Ben White Blvd., Austin, Texas 78741.** For process & equipment engineering positions, forward resume to Ed Moore; and for all other openings, forward resume to Paul Maack. You may also call 1-(800) 531-5202 or FAX your resume to (512) 462-5108.





# EDN Databank

## Professional Profile

### Announcing a new placement service for professional engineers!

To help you advance your career, Placement Services, Ltd. has formed the EDN Databank. What is the Databank? It is a computerized system of matching qualified candidates with positions that meet the applicant's professional needs and desires. What are the advantages of this new service?

- It's absolutely free. There are no fees or charges.

- The computer never forgets. When your type of job comes up, it remembers you're qualified.
- Service is nationwide. You'll be considered for openings across the U.S. by PSL and its affiliated offices.
- Your identity is protected. Your resume is carefully screened to be sure it will not be sent to your company or parent organization.

- Your background and career objectives will periodically be reviewed with you by a PSL professional placement person.

We hope you're happy in your current position. At the same time, chances are there is an ideal job you'd prefer if you knew about it.

That's why it makes sense for you to register with the EDN Databank. To do so, just mail the completed form below, along with a copy of your resume, to: Placement Services, Ltd., Inc.

#### IDENTITY

#### PRESENT OR MOST RECENT EMPLOYER

Name \_\_\_\_\_ Parent Company \_\_\_\_\_  
Home Address: \_\_\_\_\_ Your division or subsidiary: \_\_\_\_\_  
City \_\_\_\_\_ State: \_\_\_\_\_ Zip: \_\_\_\_\_ Location (City, State) \_\_\_\_\_  
Home Phone (include area code): \_\_\_\_\_ Business Phone if O.K. to use: \_\_\_\_\_

#### EDUCATION

Degrees (List)

Major Field	GPA	Year Degree Earned	College or University

#### POSITION DESIRED

#### EXPERIENCE

Present or Most Recent Position \_\_\_\_\_ From: \_\_\_\_\_ To: \_\_\_\_\_ Title: \_\_\_\_\_

Duties and Accomplishments: \_\_\_\_\_ Industry of Current Employer: \_\_\_\_\_

Reason for Change: \_\_\_\_\_

#### PREVIOUS POSITION:

Job Title: \_\_\_\_\_

Employer: \_\_\_\_\_ From: \_\_\_\_\_ To: \_\_\_\_\_ City: \_\_\_\_\_ State: \_\_\_\_\_

Division: \_\_\_\_\_ Type of Industry: \_\_\_\_\_ Salary: \_\_\_\_\_

Duties and Accomplishments: \_\_\_\_\_

#### COMPENSATION/PERSONAL INFORMATION

Years Experience	Base Salary	Commission	Bonus	Total Compensation	Asking Compensation	Min. Compensation
Date Available _____	I Will Travel <input type="checkbox"/> Light <input type="checkbox"/> Moderate <input type="checkbox"/> Heavy			I own my home. How long? _____ I rent my home/apt. <input type="checkbox"/>		
<input type="checkbox"/> Employed <input type="checkbox"/> Self-Employed <input type="checkbox"/> Unemployed		<input type="checkbox"/> Married <input type="checkbox"/> Single		Height _____ Weight _____		
Level of Security Clearance _____		<input type="checkbox"/> U.S. Citizen <input type="checkbox"/> Non-U.S. Citizen		My identity may be released to: <input type="checkbox"/> Any employer <input type="checkbox"/> All but present employer		
<input type="checkbox"/> WILL RELOCATE		<input type="checkbox"/> WILL NOT RELOCATE		<input type="checkbox"/> OTHER _____		

# EDN Databank

A DIVISION OF PLACEMENT SERVICES LTD., INC.

265 S. Main Street, Akron, OH 44308 216/762-0279



# Free P-CAD PCB Design demo disk.

If  
somebody's  
ripped off  
your free disk,  
send us this  
coupon today.

P-CAD delivers the power, flexibility and speed you need to get your next product to market faster. Because P-CAD gives you the advanced technology, sophisticated tools, and robust functionality needed to quickly complete and verify your PCB designs. Over 18,000 users worldwide design their future products today with P-CAD. To see P-CAD on your own PC or UNIX®-based technical workstation, call toll-free today or complete and mail the coupon. We'll send you the disk, absolutely free!



**Please send me my free demo disk. I want to see the power of P-CAD.**

- Send me the IBM® RISC System/6000™ P-CAD Demo.
- Send me the Sun® SPARCstation™ P-CAD Demo.
- Send me the P-CAD 386®/486® PC-DOS Demo.

Name \_\_\_\_\_

Title \_\_\_\_\_

Company \_\_\_\_\_

Telephone \_\_\_\_\_

Address \_\_\_\_\_

City \_\_\_\_\_

State \_\_\_\_\_

Zip \_\_\_\_\_

Please allow 3 weeks for delivery. Disk format:  5 1/4"  3 1/2"

MAIL TO: P-CAD/CADAM, 1935 N. Buena Vista Street, Burbank, CA 91504



**1-800-255-5710**

*World Class PCB CAD Productivity*

**p-cad**®

PRODUCTS FROM CADAM, AN IBM COMPANY

CADAM and P-CAD are registered trademarks of CADAM INC. IBM is a registered trademark and RISC System/6000 is a trademark of International Business Machines Corp. Sun is a registered trademark and SPARCstation is a trademark of Sun Microsystems, Inc. 386 and 486 are registered trademarks of Intel Corp. UNIX is a registered trademark of AT&T. ©1991 CADAM INC.



# Analog Devices can meet your needs, no matter what your

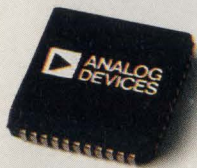
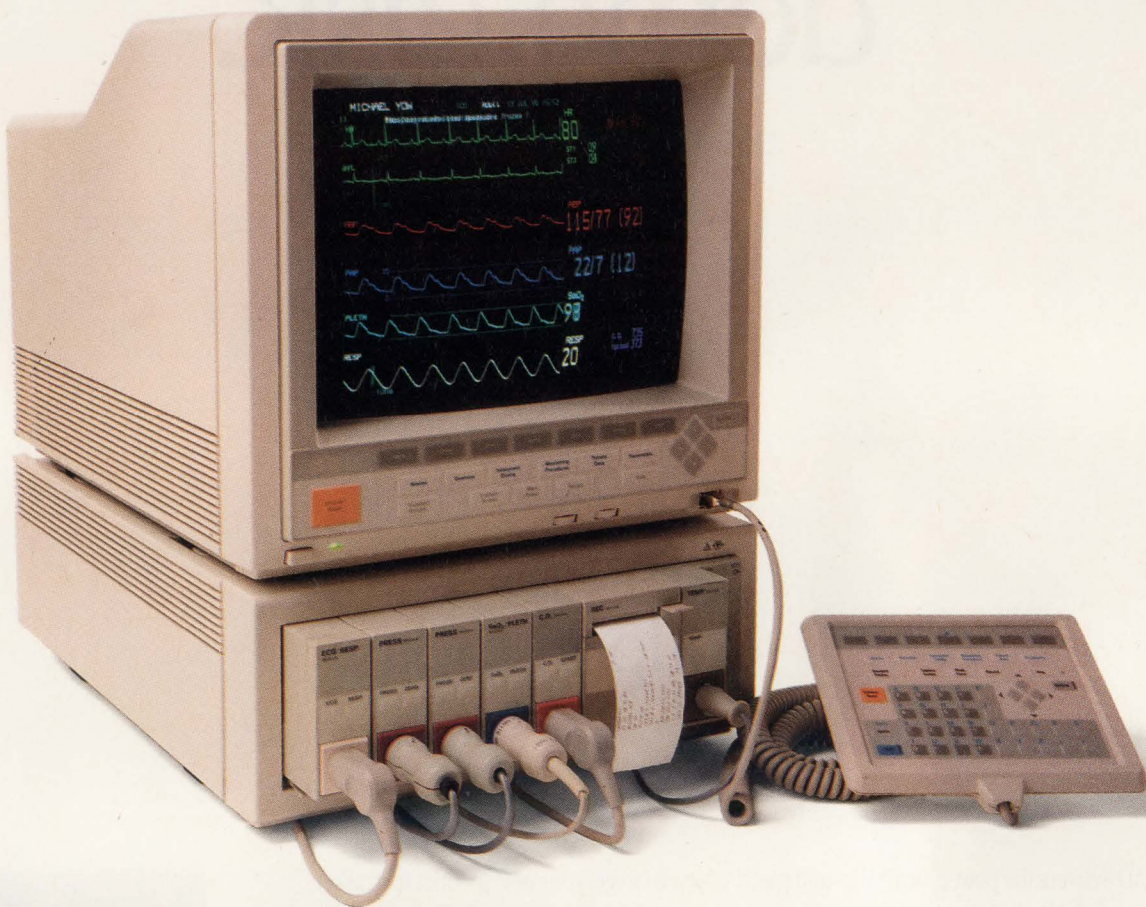

**Custom Medical Instrumentation ASIC –**  
Provides complete data acquisition on a chip. Replacing 30 separate ICs, it integrates a low-noise instrumentation amp with gains of 15 to 2,000, a 50/60 Hz switched-capacitor notch filter, 11-bit a/d converter, 7-bit d/a converter, and a serial UART communications interface.

Whether your market is a few thousand or a few million, there's one customer demand for your product that'll always remain high – the demand for high performance.

The best way to meet this demand is to follow what

the leaders in the medical, military and instrumentation markets have been doing for 25 years, and what the leaders in consumer electronics have been doing for several years now. Call Analog Devices.

These companies call us because we offer a complete line of high-performance linear, digital signal processing and mixed-signal components. ICs that allow them to achieve higher levels of system integration, greater reliability, and



# Meet your mixed-signal volume you're dealing in.

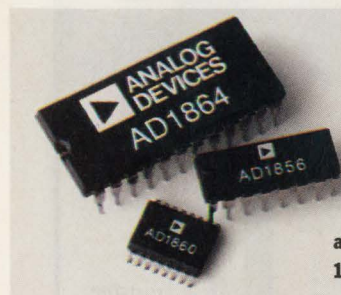

**Digital Audio Converters – The SOUNDPORT™ family of data converters comes complete with output amplifier, reference and digital logic interface. These mixed-signal ICs for high fidelity digital audio and multimedia applications achieve SNRs as high as 108 dB and THDs as low as 0.0025%.**

better performance in their products.

And as a global operation, we're able to respond to calls from any corner of the earth. In fact, international sales account for half of our \$450 million in revenues. And

three of the top five Japanese electronics companies rely on us for their mixed-signal needs.

So call 1-800-262-5643 and request a free copy of our recent white paper on Mixed-Signal Technology.

You'll see that no matter how big or small your mixed-signal needs are, we're in the best position to help.



Analog Devices, Inc., One Technology Way, P.O. Box 9106, Norwood, MA 02062-9106. Headquarters: (617) 329-4700. Offices and applications support available worldwide.



ATTENTION!

PADS

**p-cad**  
PERSONAL CAD SYSTEMS INC.

CADSTAR

**AUTOCAD**

THE  
CAD  
T.E.A.M.

NORTH AMERICA'S #1  
"SUPERVAR"

The CAD T.E.A.M. is a three-phase company:

- DESIGN SERVICE BUREAU
- CAD SOFTWARE/HARDWARE DISTRIBUTION
- CAD TRAINING CENTRE

We offer both the services/software and training you require to get the job done! Fast!

WE USE WHAT WE SELL,  
AND WE SELL WHAT WE USE.

FREE DEMO DISKS

VIEWPOINT Project Management

CAE

CAD

CAM

Schematic  
PCAD  
PADS-PCB  
RACAL-REDAC

Simulation  
P-SPICE  
SUSIE  
AUTOCAE

Thermal  
Analysis  
BETASOFT  
PACIFIC  
NUMERIX

Service  
Bureau  
PCB LAYOUT  
PHOTO PLOTTING  
BOARD MFG.

Board Layout  
PCAD  
PADS-PCB  
RACAL-REDAC  
AUTOPCB

Autorouting  
MAXROUTE  
SUPERROUTE  
RIP N ROUTE

AutoCAD  
AUTOPCB  
AUTOHYBRID

Photoplotter  
LAVENIR 1620  
PHOTOCAM  
VIEW+

Manufacturing  
FABMASTER  
FROM  
ACADEMI

CIRCLE No. 270

CIRCLE No. 271

CIRCLE No. 272

CIRCLE No. 273

CIRCLE No. 274

CIRCLE No. 275

CIRCLE No. 276

CIRCLE No. 277

CIRCLE No. 278

**PROJECT  
MANAGEMENT**

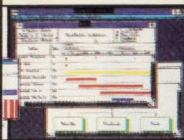

**ViewPoint**

- CAD systems for management
- Mouse operated
- Windows 3.0 based
- Unlimited limits
- Top down structured planning
- Network versions
- #1 project management system in the world

Free Demo Disks  
READER SERVICE NUMBER 279

**CIRCUIT  
SIMULATION**

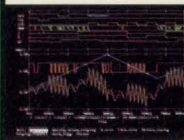

**PSpice**

Analog and Mix  
Mode Simulator  
from \$995.00

- Breadboard on screen
- Save months in design
- Reduce number of revs
- Save money
- Greater product reliability

Free Demo Disks  
READER SERVICE NUMBER 281

**DESIGN  
SERVICES**



**Special**

99¢ A PIN/\$13 A FILM

- Project management
- Concept engineering
- Schematic capture
- Simulation • PCB layout
- Autorouting
- Photoplotting/MIVA25
- PCB manufacture
- Scanning service

**Mentor  
Graphics**

READER SERVICE NUMBER 283

**PCB  
LAYOUT**

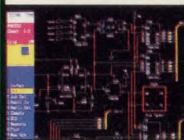

**Pads-Logic**

- 3rd generation schematic
- Multisheet database
- Interfaces to all CAD systems
- \$450

**Pads-PCB**

- World's most popular low cost ECAD system
- Completely upgradable to 2000 from \$995

Free Demo Disks  
READER SERVICE NUMBER 285

**MAXROUTER  
AUTOROUTE**

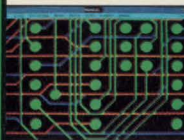

**If you're using..**

CADSTAR, PCAD,  
PADS, TANGO,  
ORCAD

**FREE BENCHMARKS**

- UNIX and DOS
- Push/shove/rip up
- Use in conjunction with your present CAD
- Largest installed base in the world

Free Demo Disks  
READER SERVICE NUMBER 287

**AUTOCAD**

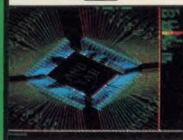

**AutoCAE**

- Schematic capture
- Analog/Digital simulation

**AutoPCB**

- PCB design
- SMT support
- Push & shove routing

**AutoHybrid**

- Hybrid circuit design
- World's only PC solution
- Component synthesis

Free Demo Disks  
READER SERVICE NUMBER 289

**Computers**

- Sun
- AST
- Compaq
- Hewlett Packard
- NEC
- WORMs
- Rewritablees
- CD-ROM
- Optical drives
- Novell
- Artist/Elsa graphics cards
- Plotters/printers
- Security software

READER SERVICE NUMBER 280

**Susie**

The industry  
standard digital  
simulator

- From \$995
- Support for all PC CAE vendors schematic capture
- New Susie 6.0
- Pop-up windows
- Software acceleration

Free Demo Disks  
READER SERVICE NUMBER 282

**TEAM Training**

- The CAD Club
- All software
- CAD translations
- SMT and analog specialists
- AutoCAD drafting service

We can design  
your board and  
return it in any CAD  
system format

Free Demo Disks  
READER SERVICE NUMBER 284

**Pads-2000**

- 3rd generation PCB layout
- All software
- Full 32 bit system
- Virtual memory
- No limits
- On the fly design
- T-Routing
- Over 2000 IC capability
- Push n' shove
- \$6,995

Free Demo Disks  
READER SERVICE NUMBER 286

**PCGERBER**

If you work with Gerber  
data, you need:

- PCGERBER-View and edit your Gerber files before you photoplot...\$995
- GPLOT-PenPlot & print Gerber files....\$595

ECAM-Provides PCB  
CAM features found in  
products retailing between  
\$7K and \$30K....\$2995

Free Demo Disks  
READER SERVICE NUMBER 288

**Fabmaster**

Putting CAD data on the  
factory floor

- Input any CAD data
- Output any manufacturing data
- Board tester
- Auto insertion
- Drilling profile

**ARTmaster**  
HPGL Editor \$995

Free Demo Disks  
READER SERVICE NUMBER 290

THE CAD T.E.A.M.

BOSTON • NEW YORK • TORONTO • ORLANDO • VANCOUVER • SAN FRANCISCO • L.A.

1-800-668-0726

US HEAD OFFICE: 620 - 19th Street, Niagara Falls, New York 14301  
Telephone: 416-842-1303, Fax: 416-842-9195



# EDN's INTERNATIONAL ADVERTISERS INDEX

Abbott Transistor Laboratories . . . . .	101	Huntsville Microsystems Inc . . . . .	173	Racal-Redac . . . . .	149
ACCEL Technologies Inc . . . . .	136	Hwang Piin . . . . .	208	Raltron . . . . .	184
Advanced Circuit Technology . . . . .	180	HyperLynx . . . . .	207	Rapid Systems . . . . .	182
Advanced Micro Devices . . . . .	8-9	IC Sensors . . . . .	63	Rayovac . . . . .	27
Advin Systems . . . . .	208	IEE . . . . .	133	RC Systems . . . . .	206
Airpax Corp . . . . .	119	Incredible Tech . . . . .	208	RLC Enterprises . . . . .	208
American Advantech . . . . .	208	Inmark . . . . .	211	Rockwell . . . . .	145
American Automation . . . . .	154	Integrated Device Technology Inc . . . . .	74	Rogers Corp . . . . .	207, 210
American Reliance . . . . .	207	Intergraph . . . . .	166	Saelig Co . . . . .	206
AMP . . . . .	54-55	Intermetrics Inc . . . . .	183	Samsung Semiconductor . . . . .	56-57
Amplifier Research . . . . .	185	International Rectifier . . . . .	C3	Samtec Inc . . . . .	110
Ampro Computers Inc . . . . .	38-39	Introl Corp . . . . .	184	SAT Solder Absorbing Tech . . . . .	210
Analog Devices Inc . . . . .	218-219	Intusoft . . . . .	206	SBE . . . . .	58
Analogic Corp . . . . .	135	Ironwood . . . . .	211	SeaLevel Systems . . . . .	193
Argosy Technology Co Ltd . . . . .	207	ISdata . . . . .	66	Seiko Instruments . . . . .	188-190
Autec Power Systems . . . . .	193	ITT Pomona Electronics** . . . . .	40	Selco Products Inc . . . . .	207
B&C Microsystems . . . . .	209, 211	Jomex . . . . .	207	Siliconix Inc . . . . .	10-11
Bopla Enclosures . . . . .	46	Kepco Inc . . . . .	120-121	Single Board Solutions . . . . .	206
Bourns . . . . .	161	KMS Advanced Products . . . . .	53	SL Waber . . . . .	172
BP Microsystems . . . . .	212	Knuerr AG . . . . .	87	Softaid Inc . . . . .	207
Bruel & Kjaer Instruments** . . . . .	172E	Kokusai Electric . . . . .	84	Sony . . . . .	153
Buckeye Stamping Co . . . . .	205	Leasametric Inc . . . . .	178	Spectrum Software . . . . .	32
CAD Software Inc . . . . .	171	Lemo USA Inc . . . . .	170, 209	Sprague Electric Co . . . . .	99
Cad TEAM . . . . .	220	Linear Technology Corp . . . . .	155-156	Sprague Goodman . . . . .	26
Cadre Technologies . . . . .	60	Link Computer Graphics Inc . . . . .	206	Stanford Research Systems Inc . . . . .	147
Capilano Computer Systems Inc . . . . .	210	Littelfuse . . . . .	205	System General . . . . .	210
Capital Equipment Corp . . . . .	118, 210	Logic Devices . . . . .	72	Systems Manufacturing Tech . . . . .	195
Carroll Touch Inc . . . . .	122	LSI Logic Corp . . . . .	162-163	Tatum Labs . . . . .	209
Cherry Electrical Products Inc . . . . .	204	3M Co . . . . .	116, 187	T-Cubed Systems Inc . . . . .	212
Cirris Logic . . . . .	175	Macrolink Inc . . . . .	205	TDK Corp of America . . . . .	201
C & K Components Inc . . . . .	166	MathSoft Inc . . . . .	191	Tek . . . . .	34-37, 68-71
Computer Dynamics . . . . .	186, 207	MCSI . . . . .	208	Telebyte Technology Inc . . . . .	210
Computerwise Inc . . . . .	211	Meritec . . . . .	206	Telecom Analysis Systems . . . . .	86
Condor . . . . .	129	MetaLink Corp . . . . .	209	Teltone Corp . . . . .	211
Connor Peripherals . . . . .	14-15	Micro Crystal . . . . .	208	Tempil Div . . . . .	211
Cybernetic Micro Systems Inc . . . . .	209	Micron Technology . . . . .	117	Teradyne Inc . . . . .	24-25
Cypress Semiconductor . . . . .	6	MicroSim Corp . . . . .	19	Texas Instruments Inc . . . . .	102-105
Dale Electronics Inc . . . . .	24, 191	MicroStar Labs . . . . .	49	Tidalwave Microtech . . . . .	209
Data I/O Corp . . . . .	52A-P, C4	Microtran Co Inc . . . . .	205	Todd Products Corp . . . . .	137-138
Datel . . . . .	67	Mini-Circuits Laboratories . . . . .	22-23, 30-31, 159, 222	Transera . . . . .	114
Delker . . . . .	86	Monolithic Sensors . . . . .	202	Tribal Microsystems . . . . .	209
Deltron Inc . . . . .	172A-D	Murrietta Circuits . . . . .	172	Tri-L Data Systems Inc . . . . .	208
Design Automation Conference . . . . .	168	National Instruments . . . . .	2	Valid Logic Systems Inc . . . . .	79
Design Computation Inc . . . . .	212	National Semiconductor Corp . . . . .	12-13, 40, 106	Versatec . . . . .	51
Dexter Magnetics . . . . .	52	NCI . . . . .	212	Vicor . . . . .	151
Duracell . . . . .	164-165	NEC Electronics . . . . .	C2	Viewlogic Systems Inc . . . . .	197
Eagle Picher . . . . .	192	Network Research . . . . .	207	Volgen America . . . . .	180
Echelon . . . . .	82-83	Nichicon Corp . . . . .	64-65	Wall Industries* . . . . .	202
EG&G Wakefield Engineering Inc . . . . .	180	Nohau Corp . . . . .	112, 205	Wavetek . . . . .	3
Elco Corp . . . . .	167	Noise Laboratory Co . . . . .	208	Westcor . . . . .	97
Electronic Measurements Inc . . . . .	115	Noritake Electronics Inc . . . . .	203	WH Brady . . . . .	80
Emulation Technology Inc . . . . .	210	Nova Sensor . . . . .	170	Wintek Corp . . . . .	209
Epson America Inc . . . . .	179	Nova Tran Corp . . . . .	176	Xeltek . . . . .	212
Ericsson Components . . . . .	44	Number One Systems Ltd . . . . .	206	Xerox Engineering Systems/Versatec Products . . . . .	51
Fairchild Defense . . . . .	210	OrCAD Systems Corp . . . . .	113	Ziatech Corp . . . . .	1
Fenner Industrial . . . . .	66	Orion Instruments . . . . .	213	Zilog Inc . . . . .	88
Force Computers Inc . . . . .	28-29	Oyster Terminals . . . . .	172F	Z-World . . . . .	211
Frequency Devices . . . . .	174	Pacific Hybrid Microelectronics . . . . .	89		
Galaxy Microcraft . . . . .	206	P-Cad . . . . .	217		
GCOM . . . . .	212	Pearson . . . . .	178		
General Devices . . . . .	205	Pentica Systems . . . . .	81		
Genrad . . . . .	181	Pico . . . . .	118, 195		
Global PMX Co Ltd . . . . .	210	Pillar Industries . . . . .	182		
Grayhill Inc . . . . .	52	Pioneer . . . . .	77		
Guradian Electric . . . . .	202	Power General . . . . .	191		
Harting Electronics . . . . .	169	Protel Tech . . . . .	211		
Hewlett-Packard Co . . . . .	4, 16, 131	Qua Tech Inc . . . . .	212		
Hughes Aircraft Co/Industrial Products . . . . .	42-43				

## Recruitment Advertising 214-216

\*Advertiser in US edition

\*\*Advertiser in International edition

This index is provided as an additional service. The publisher does not assume any liability for errors or omissions.



# incredible!

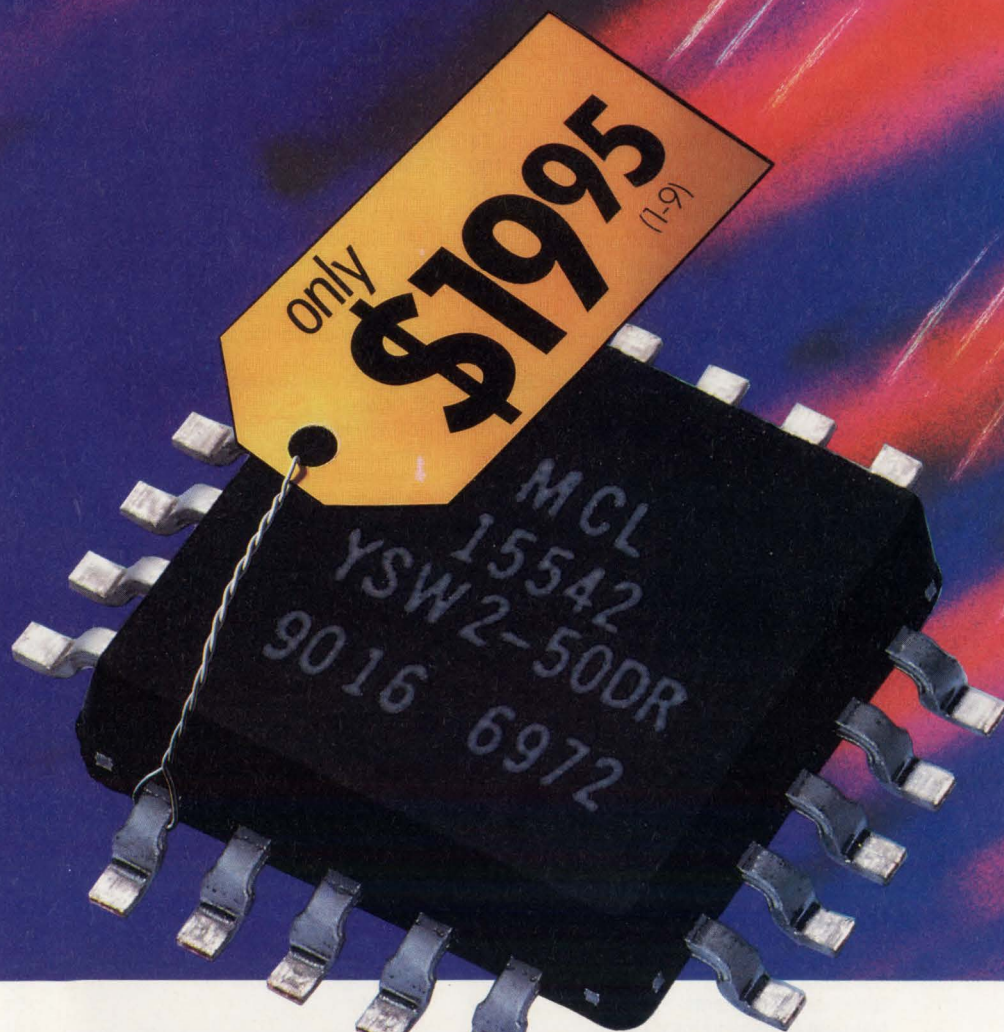

## SPDT switch dc to 5GHz with built-in driver

Truly incredible... a superfast 3nsec GaAs SPDT reflective switch with a built-in driver for only \$19.95. So why bother designing and building a driver interface to further complicate your subsystem and take added space when you can specify Mini-Circuits' YSW-2-50DR?

Check the outstanding performance specs of the rugged device, housed in a tiny plastic case, over a  $-55^{\circ}$  to  $+85^{\circ}$  C span. Unit-to-unit repeatability for insertion loss is 3-sigma guaranteed, which means less than 15 of a 10,000-unit production run will come close to the spec limit. Available for immediate delivery in tape-and-reel format for automatic placement equipment.

### SPECIFICATIONS YSW-2-50DR

	dc- 500MHz	500- 2000MHz	2000- 5000MHz
Insertion loss, typ (dB)	0.9	1.3	1.4
Isolation, typ (dB)*	50	40	28
1dB compression, typ (dBm @ in port)	20	20	24
RF input, max dBm (no damage)	22	22	26
VSWR (on), typ	_____	1.4	_____
Video breakthrough to RF, typ (mV p-p)	_____	30	_____
Rise/Fall time, typ (nsec)	_____	3.0	_____

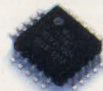

\*typ isolation at 5MHz is 80dB and decreases 5dB/octave from 5-1000 MHz

finding new ways ...  
setting higher standards

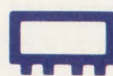

## Mini-Circuits

WE ACCEPT AMERICAN EXPRESS

P.O. Box 350166, Brooklyn, New York 11235-0003 (718) 934-4500 Fax (718) 332-4661 Telexes: 6852844 or 620156



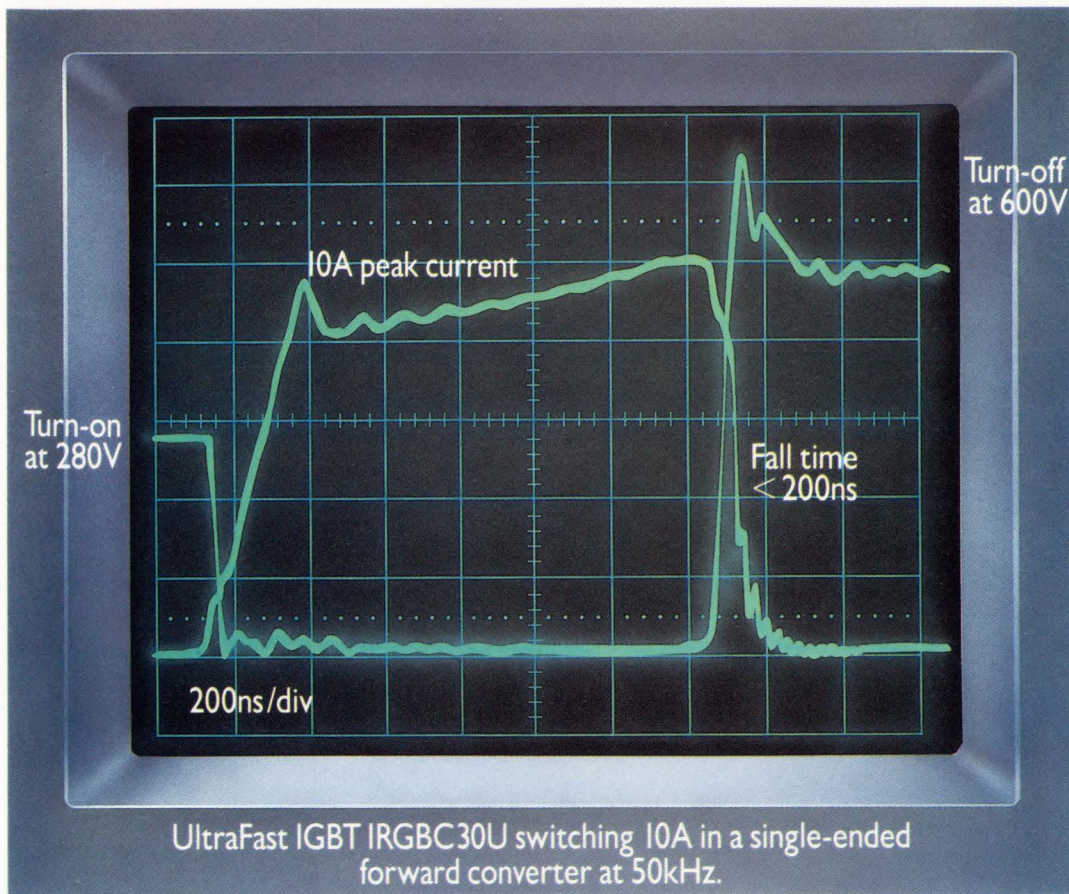

# IGBTs Without A Trace of Competition.

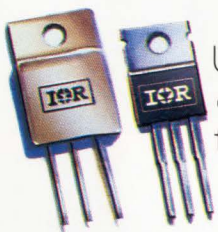

IR announces Ultra Fast IGBTs: our 600V power transistors that switch faster and run cooler than any you've ever used. Forget about bipolar. Put these

breakthrough devices in your high-voltage, high-current, medium-frequency applications and get performance unparalleled for the price.

Which should come as no surprise. IR IGBTs build on the same proprietary technology that made IR's HEXFETs® world leaders.

Call 1 (213) 640-6534 and ask about Standard, Fast or Ultra-Fast IGBTs, optimized for your operating frequency. And available from 10A to 70A, in commercial or hi-rel packages.

We'll be happy to arrange a screening.

**IR International Rectifier**

WORLD HEADQUARTERS: 233 KANSAS ST., EL SEGUNDO, CA 90245, U.S.A. (213) 772-2000. TWX 910 348-6291. TELEX 472-0403. EUROPEAN HEADQUARTERS: HURST GREEN, OXTED, SURREY RH8 9BB, ENGLAND TELEPHONE (0883) 713215, TELEX 95219

CIRCLE NO. 4



Recommended  
Advanced Micro Device  
for MACH™ parts.



# Program your hot new parts here.

And Now. Just one thing stands between you and your "hot" new design: a device programmer that can handle it. That's why the UniSite™ Universal Programmer is the designer's first choice.

UniSite is always first to support the latest devices like the Altera Max, AMD MACH,™ and the newest FPGAs. It also supports more



packages—including PLCCs and LCCs up to 84 pins, pin grid arrays, and SOICs. UniSite is designed for the future. Data I/O's universal pin-driver technology eliminates pinout adapters, for single-site programming of each device type. And its new PinSite™ programming module uses Data I/O's new Universal Package System,™ to support all surface-mount packages from one site.

Adding device support is easy too, with UniSite's update diskettes. They're released quarterly, so you'll always have support for the latest devices—first.

**FREE Programming Tutorial.** For a FREE copy of our programming technology tutorial and more information about UniSite, call now.

**1-800-247-5700**

The Personal Silicon Experts

**DATA I/O**  
Corporation

Data I/O Corporation 10525 Willows Road N.E., P.O. Box 97046, Redmond, WA 98073-9746, U.S.A. (206) 881-6444/1-800-247-5700  
Data I/O Canada 6725 Airport Road, Suite 302, Mississauga, Ontario L4V 1V2 (416) 678-0781  
Data I/O Europe World Trade Center, Strawinskylaan 633, 1077 XX Amsterdam, The Netherlands +31 (0)20-6622866  
Data I/O Instrument Electronic Systems Vertriebs GmbH Lochhamer Schlag 5A, 8032 Gräfelfing, W. Germany, +49 (0)89-858580  
Data I/O Japan Sumitomoseimei Higashishinbashi Bldg., 8F, 2-1-7, Higashi-Shinbashi, Minato-Ku, Tokyo 105, Japan  
011-81-3-3432-6991/Telex 2522685 DATAIO J

©1991 Data I/O Corporation

CIRCLE NO. 5